



# V60

**TWIN ENGINE**

OWNER'S MANUAL



# VÄLKOMMEN!

We hope you will enjoy many years of driving pleasure in your Volvo. The car has been designed for the safety and comfort of you and your passengers. Volvo strives to build one of the safest cars in the world. Your Volvo is also designed to meet applicable safety and environmental requirements.

To increase your enjoyment of your Volvo, we recommend that you read the instructions and maintenance information in this owner's manual.

The owner's manual is also available as a mobile app (Volvo Manual) and on the Volvo Cars support site ([support.volvocars.com](https://support.volvocars.com)).

We encourage everyone to always wear their seatbelt in this and other cars. Please do not drive if you are under the influence of alcohol or medication – or have an impaired ability to drive in some other way.

# TABLE OF CONTENTS

## OWNER'S INFORMATION

Owner information	16
Owner's manual in centre display	17
Navigate in the owner's manual in the centre display	18
Owner's Manual in mobile devices	20
Volvo Cars support site	21
Reading the owner's manual	21
The owner's manual and the environment	23

## YOUR VOLVO

Volvo ID	26
Creating and registering a Volvo ID	26
Drive-E - cleaner driving pleasure	28
IntelliSafe – driver support and safety	31
Sensus - online connectivity and entertainment	32
Software updates	35
Recording data	35
Terms & Conditions for Services	36
Customer Privacy Policy	36
Important information on accessories and auxiliary equipment	37
Installation of accessories	37
Connection of equipment to the car's diagnostic socket	38
Showing the car's identification number	39
Driver distraction	39

## SAFETY

Safety	42
Safety during pregnancy	42
Whiplash Protection System	43
Pedestrian Protection System	44
Seatbelts	45
Putting on and taking off seatbelts	46
Seatbelt tensioner	47
Resetting the electric seatbelt tensioner*	48
Door and seatbelt reminder	49
Airbags	50
Driver airbags	51
Passenger airbag	52
Activating and deactivating passenger airbag*	53
Side airbags	55
Inflatable curtains	56
Safety mode	57
Starting and moving the car after safety mode	57
Child safety	58
Child seats	59
Upper mounting points for child seats	60
Lower mounting points for child seats	60
i-Size/ISOFIX mounting points for child seats	61

Child seat positioning	62
Child seat mounting	63
Overview table for location of child seats	65
Table for location of child seats using the car's seatbelts	66
Table for location of i-Size child seats	68
Table for location of ISOFIX child seats	69

## DISPLAYS AND VOICE CONTROL

Instruments and controls in left-hand drive car	74	Overview of centre display	102
Instruments and controls in right-hand drive car	75	Managing the centre display	105
Driver display	77	Activating and deactivating centre display	108
Driver display settings	79	Navigating in the centre display's views	108
Fuel gauge	80	Managing subviews in centre display	112
Hybrid gauge	80	Function view in centre display	115
Hybrid battery gauge	81	Moving apps and buttons in centre display	117
Trip computer	82	Symbols in the centre display's status bar	117
Show trip data in the driver display	84	Keyboard in centre display	119
Resetting the trip meter	85	Changing keyboard language in centre display	122
Show trip statistics in the centre display	85	Enter the characters, letters and words manually in the centre display	122
Settings for trip statistics	86	Changing the appearance in the centre display	124
Date and time	86	Switching off and changing the volume of the system sound in the centre display	124
Outside temperature gauge	87	Changing system units	125
Indicator symbols in the driver display	87	Changing system language	125
Warning symbols in the driver display	89	Other settings in the centre display's top view	125
License agreement for the driver display	90	Open contextual setup in the centre display	126
Application menu in driver display	96	Resetting user data for change of ownership	127
Handling the application menu in the driver display	97	Resetting settings in the centre display	127
Messages in the driver display	98		
Managing messages in the driver display	99		
Handling a message saved from the driver display	100		

Table showing centre display settings	128
Driver profiles	129
Selecting driver profile	130
Renaming a driver profile	130
Protect driver profile	131
Linking remote control key to driver profile	131
Resetting settings in the driver profiles	133
Message in centre display	133
Managing messages in the centre display	134
Handling a message saved from the centre display	134
Head-up display*	135
Activating and deactivating the head-up display*	137
Settings for head-up display*	137
Voice recognition	138
Using voice recognition	139
Controlling a telephone with voice recognition	140
Voice control of radio and media	141
Settings for voice recognition	142

## LIGHTING

Lighting control	144
Adjusting light functions via the centre display	145
Adapting the headlamp pattern from the headlamps	145
Position lamps	146
Daytime running lights	146
Dipped beam	147
Using main beam	148
Active main beam	148
Using direction indicators	150
Active bending lights*	151
Front fog lamps/cornering lights*	151
Rear fog lamp	152
Brake lights	153
Emergency brake lights	153
Hazard warning flashers	153
Using home safe lighting	154
Approach light duration	154
Interior lighting	155
Adjusting interior lighting	157

## WINDOWS, GLASS AND MIRRORS

Windows, glass and mirrors	160
Pinch protection for windows and sun blinds	160
Reset sequence for pinch protection	161
Power windows	161
Operating power windows	162
Rearview and door mirrors	163
Adjusting rearview mirror dimming	164
Angling the door mirrors	165
Panorama roof*	166
Operating the panorama roof*	167
Automatic closing of the panoramic roof's* sun blind	169
Wiper blades and washer fluid	170
Using windscreen wipers	170
Using the rain sensor	171
Using the rain sensor's memory function	172
Using windscreen and headlamp washers	173
Using the rear window wiper and washer	174
Using automatic rear windscreen wiping when reversing	175

## SEATS AND STEERING WHEEL

Manual front seat	178
Power* front seat	179
Adjusting the power* front seat	179
Storing position for seat, door mirrors and head-up display*	180
Using a stored position for seat, door mirrors and head-up display*	181
Massage settings* in the front seat	182
Adjusting massage settings* in the front seat	183
Adjusting* the length of the seat cushion in the front seat	184
Adjusting the side support* in the front seat	185
Adjusting the lumbar support* in the front seat	185
Adjusting the passenger seat from the driver's seat*	187
Lowering the backrests in the rear seat	188
Adjusting the head restraints in the rear seat	190
Steering wheel controls and horn	192
Steering lock	192
Adjusting the steering wheel	193

## CLIMATE

Climate	196	Activating and deactivating the heated steering wheel*	211
Climate zones	196	Activating and deactivating automatic start of heated steering wheel*	211
Climate control - sensors	196	Activating auto climate control	211
Perceived temperature	197	Activating and deactivating air recirculation	212
Controlling climate control with voice recognition	197	Activating and deactivating time setting for air recirculation	213
Air quality	198	Activating and deactivating max defroster	213
Clean Zone*	199	Activating and deactivating the heated windscreen*	214
Clean Zone Interior Package*	200	Activating and deactivating automatic start of heated windscreen*	215
Interior Air Quality System*	200	Activating and deactivating the heated rear window and door mirrors	215
Activating and deactivating the air quality sensor*	201	Activating and deactivating automatic starting of the heated rear window and door mirrors	216
Passenger compartment filter	201	Regulating fan level for front seat	216
Air distribution	201	Regulating temperature for front seat	217
Changing air distribution	202	Synchronising temperature	218
Opening, closing and aiming the air vents	203	Activating and deactivating air conditioning	218
Table of air distribution options	204	Parking climate	219
Climate controls	207	Preconditioning	219
Activating and deactivating heated front seat*	208	Start and switch off preconditioning	220
Activating and deactivating automatic start of heated front seat*	209	Preconditioning time setting	221
Activating and deactivating heated rear seat*	209		
Activating and deactivating ventilated front seat*	210		

Adding and editing time setting for preconditioning	222
Activating and deactivating time setting for preconditioning	223
Removing time setting for preconditioning	224
Climate comfort when parking	225
Starting and switching off climate comfort when parking	225
Symbols and messages for parking climate control	226
Heater	228
Parking heater	229
Additional heater	230
Activating and deactivating automatic start of auxiliary heater	231

## KEY, LOCKS AND ALARM

Lock confirmation	234	Locking and unlocking from inside the car	262
Lock indication setting	235	Unlocking the tailgate from the inside of the car	263
Remote control key	235	Activating and deactivating child safety locks	264
Locking and unlocking with the remote control key	237	Automatic locking when driving	265
Settings for remotely controlled and inside unlocking	238	Opening and closing the power*-operated tailgate	266
Unlocking the tailgate with the remote control key	239	Programming maximum opening for power operated tailgate*	269
Remote control key range	239	Opening and closing the tailgate with foot movement*	269
Replacing the battery in the remote control key	240	Private locking	271
Ordering more remote control keys	243	Activating and deactivating private locking	271
Red Key - restricted remote control key*	244	Alarm*	272
Settings for Red Key*	244	Activating and deactivating alarms*	274
Detachable key blade	245	Reduced alarm level*	275
Locking and unlocking with the detachable key blade	247	Double lock*	275
Immobiliser	248	Temporarily* deactivating double locks	276
Type approval for the remote control key system	249		
Keyless and touch-sensitive surfaces*	258		
Keyless locking and unlocking*	259		
Settings for Keyless entry*	260		
Keyless unlocking of the tailgate*	261		
Antenna locations for the start and lock systems	261		



## DRIVER SUPPORT

Driving support systems	278	Reactivating cruise control from standby mode	294	Set time interval for driver support	318
Speed-dependent steering force	278	Deactivating cruise control	295	Drive mode for driver support	319
Electronic stability control	279	Distance Warning*	296	Set the stored speed for driver support	319
Electronic Stability Control in sport mode	280	Activating/deactivating Distance warning	297	Automatic braking with driver support	320
Activating/deactivating sport mode for Electronic Stability Control	281	Limitations of Distance Warning	297	Overtaking Assistance	321
Symbols and messages for electronic stability control	282	Adaptive cruise control*	298	Use Overtaking Assistance	322
Speed limiter	284	Controls and display view for adaptive cruise control*	300	Radar unit	323
Activating and starting the Speed Limiter	285	Activating and starting adaptive cruise control*	300	Type approval for radar device	324
Deactivate the speed limiter and set it in standby mode	285	Deactivating/reactivating adaptive cruise control*	301	Camera unit	329
Reactivating the speed limiter from standby mode	286	Limitations for adaptive cruise control*	303	Limitations for camera and radar unit	330
Deactivating the speed limiter	287	Change between cruise control and adaptive cruise control*	303	Recommended maintenance for camera and radar unit	334
Limitations for speed limiter	287	Symbols and messages for adaptive cruise control*	305	City Safety™	335
Automatic speed limiter	288	Pilot Assist	307	Parameters and subfunctions for City Safety	336
Activate/deactivate Automatic Speed Limiter	289	Controls and display view for Pilot Assist	309	Setting the warning distance for City Safety	338
Changing the tolerance for the automatic speed limiter	290	Activating and starting Pilot Assist	310	Detection of obstacles with City Safety	339
Limitations for automatic speed limiter	291	Deactivating/activating Pilot Assist	311	City Safety in cross traffic	341
Cruise control	291	Limitations of Pilot Assist	313	Limitations for City Safety in cross traffic	342
Activating and starting Cruise Control	293	Symbols and messages for Pilot Assist*	314	City Safety steering assistance for evasive manoeuvre	343
Deactivate cruise control and set it in standby mode	293	Warning from driver support in the event of a collision risk	316	Limitations of City Safety steering assistance when taking evasive action	344
		Change of target with driver support	317	City Safety when evasive manoeuvres are prevented	344

City Safety brakes for oncoming vehicles	345	Driver Alert Control	366	Park Assist*	381
Limitations of City Safety	346	Activate/deactivate Driver Alert Control	367	Park Assist Pilot front, rear and along the sides*	382
Messages for City Safety	349	Select rest stop guidance in the event of a warning from Driver Alert Control	368	Activating/deactivating Park Assist Pilot*	383
Rear Collision Warning	350	Limitations of Driver Alert Control	368	Limitations of Parking assistance	384
Limitations of Rear Collision Warning	350	Lane assistance	368	Symbols and messages for Park Assist Pilot	385
BLIS*	351	Steering assistance with lane assistance	370	Park assist camera*	386
Activating or deactivating BLIS	352	Activate/deactivate Lane Keeping Aid	370	Parking camera views*	387
Limitations of BLIS	353	Select assistance option for lane assistance	370	Park assist lines for parking camera*	389
Messages for BLIS	354	Limitations of Lane assistance	371	Sensor fields from Park Assist Pilot for parking camera	391
Cross Traffic Alert*	355	Symbols and messages for lane assistance	372	Starting the park assist camera	392
Activate/deactivate Cross Traffic Alert	356	Lane assistance symbols in the driver display	374	Symbols and messages for Park assist camera	393
Limitations of Cross Traffic Alert	356	Steering assistance at risk of collision	375	Park Assist Pilot*	394
Messages for Cross Traffic Alert	358	Activating/deactivating Steering assistance in the event of a collision risk	376	Parking variants with Park Assist Pilot*	395
Road Sign Information*	359	Steering assistance level in the event of a run-off risk	376	Parking with Park Assist Pilot*	396
Activating/deactivating Road Sign Information*	360	Steering assistance upon risk of run-off	377	Leaving parallel parking with Park Assist Pilot*	398
Road Sign Information and sign display*	361	Steering assistance upon risk of head-on collision	378	Limitations of Park Assist Pilot*	399
Road Sign Information and Sensus Navigation*	363	Limitations for steering assistance at risk of collision	379	Messages for Park Assist Pilot*	402
Road Sign Information with speed warning and settings*	363	Symbols and messages for steering assistance upon risk of collision	380		
Activating/deactivating Speed warning in Road Sign Information	364				
Road Sign Information with Speed Camera Information*	365				
Limitations of Road Sign Information*	365				

## HYBRID INFORMATION

General information about Twin Engine	404
Charging the hybrid battery	405
Charging current	406
Charging cable	407
Ground fault breaker in the charging cable	408
Temperature monitoring of the charging cable	409
Opening and closing the hatch for the charging input socket	410
Start charging the hybrid battery	410
Charging status in the car's charging input socket	413
Charging status in the charging cable's control unit	414
Charging status in the car's driver display	417
Stop charging of hybrid battery	419
Symbols and messages relating to Twin Engine in the driver display	421
Long-term storage of vehicles with hybrid batteries	423

## STARTING AND DRIVING

Starting the car	426	Auto braking after a collision	439
Switching off the car	428	Gearbox	440
Ignition positions	428	Gear positions for automatic gearbox	441
Selecting ignition mode	429	Changing gear with steering wheel paddles*	443
Alcohol lock*	430	Gear selector inhibitor	444
Bypass of the alcohol lock*	430	Kick-down function	444
Before starting the engine with the alcohol lock	431	Gear shift indicator	444
Brake functions	431	All-wheel drive	445
Foot brake	432	Drive systems	445
Brake assistance	433	Starting and stopping the combustion engine in Twin Engine	446
Braking on wet roads	433	Drive modes	447
Braking on gritted roads	434	Changing drive mode	451
Brake system maintenance	434	Energy distribution in hybrid drive using map data*	451
Parking brake	434	Level control* and shock absorption	453
Activating and deactivating the parking brake	435	Settings for level control*	455
Automatic parking brake activation setting	436	Economical driving	455
Parking on a hill	437	Factors that affect range when running on electricity	456
In the event of a fault in the parking brake	437	Hold and Charge function	458
Automatic braking when stationary	438	Preparations for a long trip	459
Activating and deactivating the automatic brake at a standstill	438	Winter driving	459
Help when starting on a hill	439	Driving in water	460
		Opening and closing the fuel filler flap	461

Filling fuel	462
Handling of fuel	463
Petrol	464
Petrol particle filter	465
Overheating in the engine and drive system	466
Overloading the starter battery	467
Using jump starting with another battery	467
Towbar*	469
Specifications for towbar*	470
Extendable and retractable towbar*	470
Driving with a trailer	472
Trailer stability assist*	474
Checking trailer lamps	475
Towbar-mounted bicycle rack*	476
Towing	477
Fitting and removing the towing eye	478
Recovery	479
HomeLink®*	479
Programming HomeLink®*	480
Using HomeLink®*	482
Type approval for HomeLink®*	482
Compass*	483
Activating and deactivating the compass*	483

Calibrating the compass*	483
--------------------------	-----

## **SOUND, MEDIA AND INTERNET**

Sound, media and Internet	486
Audio settings	486
Sound experience*	487
Apps	488
Downloading apps	489
Updating apps	490
Deleting apps	490
Radio	491
Start radio	491
Changing radio band and radio station	492
Searching for radio stations	493
Setting radio favourites	493
Settings for radio	494
RDS radio	495
Digital radio*	496
Link between FM and digital radio*	497
Media player	497
Media playback	498
Controlling and changing media	499
Searching media	500
Gracenote®	501
CD player*	501
Video	502
Playing a video	502

Playing back DivX®	502	Switch between Bluetooth-connected phones	516	License agreement for audio and media	529
Settings for video	503	Removing devices connected to Bluetooth	517		
Media via Bluetooth®	503	Managing phone calls	517		
Connecting a device via Bluetooth®	503	Managing text messages	518		
Media via USB port	504	Settings for text messages	519		
Connecting a device via USB port	504	Managing the phone book	519		
Technical specifications for USB devices	505	Settings for phone	520		
Compatible media formats	505	Settings for Bluetooth devices	521		
Apple® CarPlay®*	506	Internet-connected car*	521		
Using Apple® CarPlay®*	507	Connect the car to the Internet via a Bluetooth-enabled phone	522		
Settings for Apple® CarPlay®*	508	Connect the car to the Internet via a phone (Wi-Fi)	523		
Tips for using Apple® CarPlay®*	509	Connect the car to the Internet via car modem (SIM card)	523		
Android Auto*	510	Settings for car modem*	524		
Using Android Auto*	510	Sharing Internet access from the car via a Wi-Fi hotspot	525		
Settings for Android Auto*	511	No or poor Internet connection	526		
Tips for using Android Auto*	512	Remove Wi-Fi network	526		
Phone	512	Wi-Fi technologies and security	527		
Connecting a phone to the car via Bluetooth for the first time	513	User terms and conditions and data sharing	527		
Connecting a phone to the car via Bluetooth automatically	515	Activating and deactivating data sharing	527		
Connecting a phone to the car via Bluetooth manually	516	Storage space on hard disk	528		
Disconnecting a Bluetooth-connected phone	516				

## **ECALL**

eCall	540
Automatic collision alarm with eCall	540
Emergency assistance with eCall	540
Roadside Assistance	541

## **WHEELS AND TYRES**

Tyres	544
Dimension designation for tyre	545
Dimension designation for wheel rim	546
Tyres' rotation direction	547
Tread wear indicators on the tyres	547
Checking tyre pressure	548
Adjusting tyre pressure	548
Recommended tyre pressure	549
Tyre pressure monitoring system*	550
Saving a new tyre pressure in the monitoring system*	551
See tyre pressure status in the centre display*	553
Action in the event of warning for low tyre pressure	554
When changing wheels	555
Tool kit	555
Jack*	555
Wheel bolts	556
Removing a wheel	557
Fitting the wheels	559
Spare wheel*	560
Handling the spare wheel	561
Winter tyres	561
Snow chains	562

Emergency puncture repair kit	563
Using a puncture repair kit	564
Inflating tyres with the compressor from the puncture repair kit	567

## LOADING, STORAGE AND PASSENGER COMPARTMENT

Passenger compartment interior	570
Tunnel console	571
Using the cigarette lighter*	571
Electrical sockets	573
Using electrical sockets	575
Using the glovebox	576
Sun visors	578
Cargo area	578
Recommendations for loading	578
Roof load and loading on load carriers	579
Bag hooks	580
Load retaining eyelets	581
Through-load hatch in the rear seat	581
Fitting and removing cargo cover*	582
Operating cargo cover*	582
Fitting and removing safety grilles*	584
Fitting and removing the safety net*	585
First aid kit*	587
Warning triangle	587

## MAINTENANCE AND SERVICE

Volvo service programme	590	Fuses in engine compartment	614
Data transfer between car and workshop via Wi-Fi	590	Fuses under glovebox	618
Download Center	591	Fuses in cargo area	621
Managing system updates via the Download Centre	591	Cleaning the interior	625
Car status	592	Cleaning the centre display	625
Book service and repair	593	Cleaning the head up display*	626
Sending car information to a workshop	594	Cleaning fabric upholstery and headlining	627
Raise the car	596	Cleaning the seatbelts	627
Servicing the climate control system	598	Cleaning floor mats and inlay mats	627
Head up display when replacing the windscreen*	598	Cleaning leather upholstery	628
Opening and closing the bonnet	599	Cleaning the leather steering wheel	629
Engine compartment overview	600	Cleaning interior plastic, metal and wood parts	629
Engine oil	601	Cleaning the exterior	630
Checking and filling with engine oil	602	Polishing and waxing	630
Topping up coolant	603	Handwashing	631
Bulb replacement	605	Automatic car wash	632
Starter battery	606	High-pressure washing	633
Hybrid battery	610	Cleaning the wiper blades	633
Symbols on the batteries	611	Cleaning exterior plastic, rubber and trim components	634
Battery recycle	611	Cleaning wheel rims	635
Fuses and central electrical units	612	Rustproofing	635
Replacing a fuse	612	Car paintwork	636
		Touching up minor paintwork damage	636

Colour codes	637
Replacing the wiper blade, rear window	638
Replacing windscreen wiper blades	639
Wiper blades in service position	640
Filling washer fluid	641

## SPECIFICATIONS

Type designations	644
Dimensions	647
Weights	649
Towing capacity and towball load	650
Engine specifications	652
Engine oil — specifications	653
Adverse driving conditions for engine oil	654
Coolant — specifications	655
Transmission fluid — specifications	655
Brake fluid — specifications	655
Fuel tank - volume	656
Air conditioning — specifications	656
Fuel consumption and CO <sub>2</sub> emissions	658
Approved wheel and tyre sizes	661
Minimum permitted tyre load index and speed rating for tyres	662
Approved tyre pressures	663

## ALPHABETICAL INDEX

Alphabetical Index	665
--------------------	-----



OWNER'S INFORMATION

## Owner information

Owner's information is available in several different product formats, both digital and printed. The owner's manual is available in the car's centre display, as a mobile app and on the Volvo Cars support site. There is a Quick Guide and a supplement to the owner's manual available in the glovebox, with specifications and fuse information, amongst other things. A printed owner's manual can be ordered.

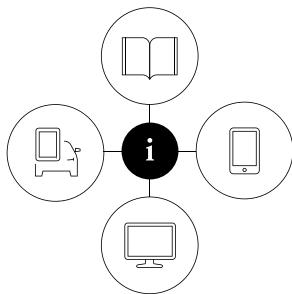

0900003

### The car's centre display<sup>1</sup>



In the centre display, drag down the top view and tap on **Owner's manual**. Available here are options for visual navigation with exterior and interior images of the car. The information is searchable and is also

divided into categories.

### Mobile app

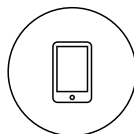

In App Store or Google Play, search for "Volvo Manual", download the app to your smartphone or tablet and select the car. Available in the app are video tutorials and options for visual navigation with exterior

and interior images of the car. It is easy to navigate between the different sections in the owner's manual and the content is searchable.

### Volvo Cars support site



Go to [support.volvocars.com](http://support.volvocars.com) and select your country. Here you can find owner's manuals, both online and in PDF format. On the Volvo Cars support site there are also video tutorials and further information and

help regarding your Volvo and your car ownership. The page is available for most markets.

### Printed information

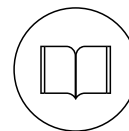

There is a supplement to the owner's manual<sup>1</sup> in the glovebox that contains information on fuses and specifications, as well as a summary of important and practical information.

There is also a Quick Guide available in printed format that helps you to get started with the most commonly used functions in the car.

Depending on equipment level selected, market, etc. additional owner's information may also be available in printed format in the car.

A printed owner's manual and associated supplement can be ordered. Contact a Volvo dealer to order.

### **!** IMPORTANT

The driver is always responsible that the vehicle is driven safely in traffic and that applicable laws and regulations are followed. It is also important that the car is maintained and handled in accordance with Volvo's recommendations in the owner's information.

If there should be a difference between the information in the centre display and the printed information then it is always the printed information that applies.

<sup>1</sup> A complete printed manual is included with the car for markets without owner's manual in the centre display.

**i NOTE**

Changing the language in the centre display may mean that some owner's information is not compliant with national or local laws and regulations. Do not switch to a language that is difficult to understand as this may make it difficult to find your way back through the screen structure.

**Related information**

- Owner's manual in centre display (p. 17)
- Owner's Manual in mobile devices (p. 20)
- Volvo Cars support site (p. 21)
- Reading the owner's manual (p. 21)

**Owner's manual in centre display**

A digital<sup>2</sup> version of the owner's manual is available in the car's centre display.

The digital owner's manual can be accessed from the top view, and in some cases the contextual owner's manual can also be accessed from the top view.

**i NOTE**

The digital owner's manual is not available while driving.

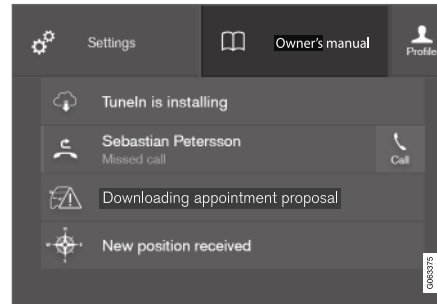
**Owner's manual**

Top view with button for owner's manual.

To open the owner's manual - drag down the top view in the centre display and tap on **Owner's manual**.

The information in the owner's manual can be accessed directly via the owner's manual homepage or its top menu.

<sup>2</sup> Applies for most markets.

### ◀◀ Contextual owner's manual

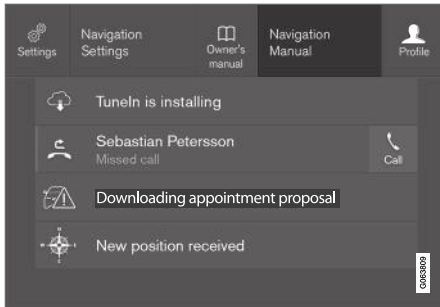

Top view with button for contextual owner's manual.

The contextual owner's manual is a shortcut to an article in the owner's manual that describes the active function shown on the screen. When the contextual owner's manual is available, it is shown to the right of **Owner's manual** in the top view.

Tapping on the contextual owner's manual therefore opens an article in the owner's manual that is related to the content that is shown on the screen. E.g. tap on **Navigation Manual** – an article that is related to navigation opens.

This only applies to some of the apps in the car. For downloaded third party apps, for example, it is not possible to access app-specific articles.

### Related information

- Navigate in the owner's manual in the centre display (p. 18)
- Navigating in the centre display's views (p. 108)
- Downloading apps (p. 489)

### Navigate in the owner's manual in the centre display

The digital owner's manual can be accessed from the centre display top view in the car. The content is searchable and it is easy to navigate between different sections.

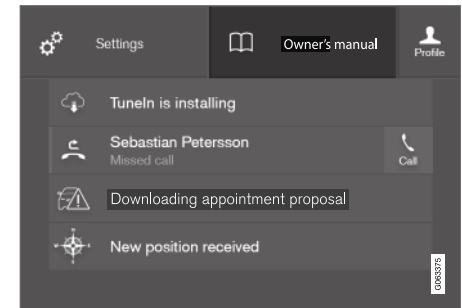

The owner's manual is accessed from the top view.

- To open the owner's manual - drag down the top view in the centre display and tap on **Owner's manual**.

There is a range of different options for finding information in the owner's manual. The options can be accessed from the owner's manual homepage and from the top menu.

## Opening the menu in the top menu

- Press  in the upper list in the owner's manual.
  - > A menu with different options for finding information is opened:

### Homepage



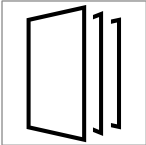

Tap on the symbol to go back to the start page in the owner's manual.

### Categories



The articles in the owner's manual are structured into main categories and subcategories. The same article can be found in several appropriate categories so that it can be found more easily.

1. Press **Categories**.
    - > The main categories are shown in a list.
  2. Tap on a main category ().
    - > A list of subcategories () and articles () is shown.
  3. Tap on an article to open it.
- To go back, press the back arrow.

## Quick Guide

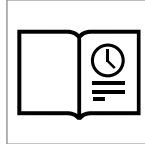

Press the symbol to access a page with links to a selection of articles that can be particularly useful to read in order to get to know the most common functions of the car. The articles can also be accessed via categories, but are collected here for quick access. Tap on an article in order to read it in its entirety.

### Hotspots for exterior and interior

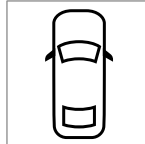

Exterior and interior overview images of the car. Different parts are designated with hotspots that lead to articles about those parts of the car.

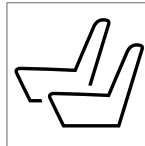

1. Press **Exterior or Interior**.
  - > Exterior or interior images are shown with so-called hotspots in place. The hotspot leads to articles about the corresponding part of the car. Swipe horizontally over the screen to browse among the images.

2. Tap on a hotspot.
    - > The title of the article about the area is shown.
  3. Tap on the title to open the article.
- To go back, press the back arrow.

### Favourites

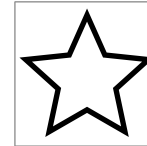

Press the symbol to access the articles saved as favourites. Tap on an article in order to read it in its entirety.

### Saving or deleting articles as favourites

Save an article as favourite by pressing  at the top right when an article is open. When an article has been saved as a favourite the star is filled in:



To remove an article as a favourite, press the star again in the current article.

### Video

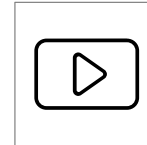

Press the symbol to view brief instruction videos for various functions in the car.

◀ Information



Tap on the symbol to obtain information about which version of the owner's manual is available in the car as well as other useful information.

**Using the search function in the top menu**

1. Tap on **Q** in the top menu of the owner's manual. A keyboard appears in the lower part of the screen.
2. Type in a keyword, such as "seatbelt".
  - > Suggestions for articles and categories are shown while letters are being entered.
3. Tap on the article or category to access it.

**Related information**

- Owner's manual in centre display (p. 17)
- Keyboard in centre display (p. 119)
- Reading the owner's manual (p. 21)

**Owner's Manual in mobile devices**

The owner's manual is available as a mobile app<sup>3</sup> from both the App Store and Google Play. The app is adapted for smartphones and tablets.



The owner's manual can be downloaded as a mobile app from the App Store or Google Play. The QR code provided here takes you directly to the app. Alternatively, you can search for "Volvo manual" in

the App Store or Google Play.

The app contains a video along with exterior and interior images where different parts of the car are highlighted with so-called hotspots, which lead to articles about the area in question. It is easy to navigate between the different sections

in the owner's manual and the content is searchable.

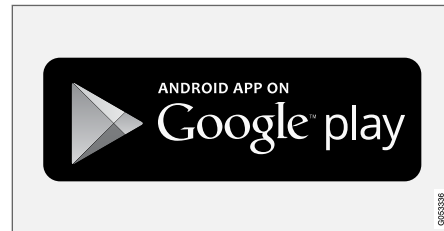
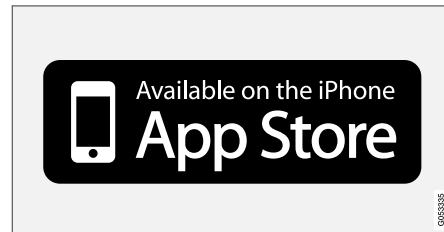

The mobile app is available from both the App Store and Google Play.

**Related information**

- Reading the owner's manual (p. 21)

<sup>3</sup> For certain mobile devices.

## Volvo Cars support site

More information on your car is available on the Volvo Cars website and support site.

### Support on the Internet

Go to support.volvocars.com to visit the site. The support site is available for most markets.

It contains support for functions such as web-based services and functions, Volvo On Call\*, the navigation system\* and apps. Videos and step-by-step instructions explain different procedures, e.g. how to connect the car to the Internet via a mobile phone.

### Downloadable information

#### Maps

For cars equipped with Sensus Navigation there is the facility to download maps from the support page.

#### Owner's manuals as PDF

Owner's manuals are available for download in PDF format. Select car model and model year to download the manual as required.

#### Contact

The support site contains contact details to customer support and your nearest Volvo retailer.

### Log in to Volvo Cars website

Create a personal Volvo ID and log in to www.volvocars.com. When you have logged in it is possible to get an overview of service, agree-

ments and warranties, amongst other things. Here there is also information about accessories and software adapted for your car model.

### Related information

- Volvo ID (p. 26)

## Reading the owner's manual

A good way of getting to know your new car is to read the owner's manual, ideally before your first journey.

Reading the owner's manual is a good way to become familiar with new functions, get advice on how best to handle the car in different situations and learn how to make the best use of all the car's features. Please pay attention to the safety instructions contained in the owner's manual.

The intention of this owner's information is to explain all possible functions, options and accessories included in a Volvo vehicle. It is not intended as an indication or guarantee that all of these features, functions and options are included in every vehicle. Some terminology used may not exactly match terminology used in sales, marketing and advertising materials.

Development work is constantly underway in order to improve our product. Modifications may mean that information, descriptions and illustrations in the owner's manual differ from the equipment in the car. We reserve the right to make modifications without prior notice.

Do not remove this manual from the car - if problems should arise then the necessary information about where and how to seek professional help will be missing.

© Volvo Car Corporation



## Options/accessories

In addition to standard equipment, the owner's manual also describes options (factory fitted equipment) and certain accessories (retrofitted extra equipment).

All, at the time of publication known, options and accessories are marked with an asterisk: \*.

The equipment described in the owner's manual is not available in all cars - they have different equipment depending on adaptations for the needs of different markets and national or local laws and regulations.

In the event of uncertainty over what is standard or an option/accessory, contact a Volvo dealer.

## Special texts

### **WARNING**

Warning texts appear if there is a risk of injury.

### **IMPORTANT**

"Important" texts appear if there is a risk of damage.

### **NOTE**

NOTE texts give advice or tips that facilitate the use of e.g. features and functions.

## Decals

The car contains different types of decal which are designed to convey important information in a simple and clear manner. The decals in the car have the following descending degree of importance for the warning/information.

### Warning of personal injury



Black ISO symbols on yellow warning field, white text/image on black message field. Used to indicate the presence of danger which, if the warning is ignored, may result in serious personal injury or fatality.

## Risk of property damage



White ISO symbols and white text/image on black or blue warning field and message field. Used to indicate the presence of danger which, if the warning is ignored, may result in damage to property.



## Information



White ISO symbols and white text/image on black message field.

### **i** NOTE

It is not intended that the decals illustrated in the owner's manual should be exact replicas of those in the car. They are included to show their approximate appearance and location in the car. The information that applies to your particular car is available on the respective decals for your car.

## Illustrations and video clips

Illustrations and video clips used in the owner's manual are sometimes schematic and are intended to provide an overall picture or example of a certain function. They may deviate from the

car's appearance depending on equipment level and market.

### Related information

- Owner's manual in centre display (p. 17)
- Owner's Manual in mobile devices (p. 20)
- Volvo Cars support site (p. 21)

## The owner's manual and the environment

The Owner's Manual is printed on paper originating from controlled forests.

The Forest Stewardship Council (FSC)<sup>®</sup> symbol shows that the paper pulp in a printed owner's manual comes from FSC<sup>®</sup>-certified forests or other controlled sources.

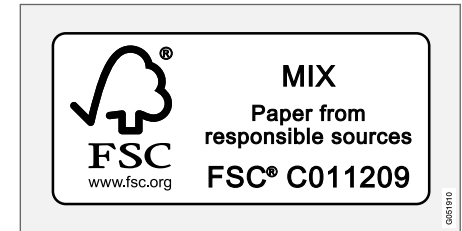

### Related information

- Drive-E - cleaner driving pleasure (p. 28)



YOUR VOLVO

## Volvo ID

Volvo ID is a personal ID that gives access to a wide range of services via a single username and password.

### **i** NOTE

The services available may vary over time and depend on equipment level and market.

Examples of services:

- Volvo On Call app\* – check the car with your phone. For example, you can check fuel level, show the nearest petrol station and lock the car remotely.
- Send to Car – send addresses from map services on the Web, directly to the car.
- Book service and repair – register your preferred workshop/dealer on volvocars.com and book service directly from the car.

### **i** NOTE

If the username/password for a service (e.g. Volvo On Call) is changed, then it is also changed automatically for other services.

Volvo ID is created from the car, volvocars.com or the Volvo On Call app<sup>1</sup>.

<sup>1</sup> If you have Volvo On Call\*.

<sup>2</sup> Only applies to certain markets.

When a Volvo ID is registered in the car, several services will be made available. Several Volvo IDs can be used for the same car and several cars can even be connected to the same Volvo ID.

### Related information

- Creating and registering a Volvo ID (p. 26)
- Book service and repair (p. 593)

## Creating and registering a Volvo ID

It is possible to create a Volvo ID in different ways. If the Volvo ID is created at volvocars.com or with Volvo On Call app<sup>2</sup>, the Volvo ID must also be registered to the car to enable use of the various Volvo ID services.

### Create a Volvo ID with the Volvo ID app

1. Download the Volvo ID app from **Download Centre** in the centre display's app view.
2. Start the app and register a personal email address.
3. Follow the instructions that are automatically sent to the specified email address.
  - > A Volvo ID has now been created and automatically registered to the car. Volvo ID services can now be used.

### Create a Volvo ID on the Volvo Cars website

1. Go into [www.volvocars.com](http://www.volvocars.com) and log in<sup>3</sup> using the icon at the top right. Select Create Volvo ID.
2. Enter a personal email address.
3. Follow the instructions that are automatically sent to the specified email address.
  - > A Volvo ID has now been created. Read below to learn how to register the ID to the car.

### Create a Volvo ID with the Volvo On Call app<sup>4</sup>

1. Download the latest version of the Volvo On Call app from a smartphone, via e.g. App Store, Windows Phone or Google Play.
2. Choose to create a Volvo ID from the app's start page and enter a personal email address.
3. Follow the instructions that are automatically sent to the specified email address.
  - > A Volvo ID has now been created. Read below to learn how to register the ID to the car.

### Registering your Volvo ID to the car

If you created your Volvo ID via the web or the Volvo On Call app, register it to your car as follows:

1. If not done already, download the Volvo ID app from **Download Centre** in the centre display's app view.

#### NOTE

To download apps, the car must be connected to the Internet.

2. Start the app and enter your Volvo ID/your email address.
3. Follow the instructions that are automatically sent to the email address linked to your Volvo ID.
  - > Your Volvo ID is now registered to the car. Volvo ID services can now be used.

### Related information

- Volvo ID (p. 26)
- Downloading apps (p. 489)
- Managing system updates via the Download Centre (p. 591)
- Internet-connected car\* (p. 521)

<sup>3</sup> Available on certain markets.

<sup>4</sup> Cars with Volvo On Call\*.

## **Drive-E - cleaner driving pleasure**

Volvo Car Corporation is constantly working on the development of safer and more efficient

products and solutions in order to reduce the negative impact on the environment.



Environmental care is one of Volvo Cars' core values and influences all operations. The environmental work is based on the whole life cycle of the car and takes into account the environmental impact it has, from design to scrapping and recycling. Volvo Cars' basic principle is that every new product developed must have less impact on the environment than the product it replaces.

Volvo's environmental management work has resulted in the development of more effective and less polluting drivelines Drive-E. Personal environment is also important to Volvo - the air

inside a Volvo is, for example, cleaner than the air outside thanks to the climate control system.

Your Volvo complies with stringent international environmental standards. All Volvo's manufacturing units must be ISO 14001 certified, and this supports a systematic approach to the operation's environmental issues, which leads to continuous improvement with reduced environmental impact. Holding the ISO certificate also means that environmental laws and regulations in force are complied with. Volvo also requires that its partners must also meet these requirements.

## **Fuel consumption**

Since a large part of a car's total environmental impact stems from its use, the emphasis of Volvo Cars' environmental work is on reducing fuel consumption, carbon dioxide emissions and other air pollutants. Volvo cars have competitive fuel consumption in each of their respective classes. Lower fuel consumption generally results in lower emission of the greenhouse gas, carbon dioxide.

### Contributing to a better environment

An energy-efficient and fuel-efficient car not only contributes to a reduced impact on the environment, but also means reduced costs for the owner of the car. As the driver, it is easy to reduce fuel consumption and thereby save money and contribute to a better environment - here is some advice:

- Plan for an effective average speed. Speeds above approx. 80 km/h (approx. 50 mph) and below 50 km/h (approx. 30 mph) lead to increased energy consumption.
- Follow the Service and Warranty Booklet's recommended intervals for service and maintenance of the car.
- Avoid letting the engine idle - switch off the engine when stationary for longer periods. Pay attention to local regulations.
- Plan the journey - a lot of unnecessary stops and uneven speed contribute to increased fuel consumption.
- Use preconditioning - it improves the range of the hybrid battery and reduces the energy requirement while driving.

Also remember to always dispose of environmentally hazardous waste, such as batteries and oil, in an environmentally safe manner. Consult a workshop in the event of uncertainty about how this type of waste should be discarded - an authorised Volvo workshop is recommended.

### Efficient emission control

Your Volvo is manufactured following the concept "Clean inside and out" - a concept that encompasses a clean interior environment as well as highly efficient emission control. In many cases the exhaust emissions are well below the applicable standards.

### Clean air in the passenger compartment

An air filter helps prevent dust and pollen entering the passenger compartment via the air intake.

The Interior Air Quality System (IAQS)\* ensures that the incoming air is cleaner than the air in the traffic outside.

The system cleans the air in the passenger compartment from contaminants such as particles, hydrocarbons, nitrous oxides and ground-level ozone. If the outside air is contaminated then the air intake is closed and the air is recirculated. Such a situation may arise in heavy traffic, queues and tunnels for example.

IAQS is a part of the Clean Zone Interior Package (CZIP)\*, which also includes a function that allows the fan to start when the car is unlocked with the remote control key.

### Interior

The material used in the interior of a Volvo is carefully selected and has been tested in order to be pleasant and comfortable. Some of the details are hand-made, such as the seams of the steer-

ing wheel that are sewn by hand. The interior is monitored in order not to emit strong odours or substances that cause discomfort in the event of e.g. high heat and bright light.

### Volvo workshops and the environment

Regular maintenance creates the conditions for a long service life and low fuel consumption for your car. In this way you also contribute to a cleaner environment. When Volvo's workshops are entrusted with the service and maintenance of your car it becomes part of Volvo's system. Volvo makes clear demands regarding the way in which workshop premises shall be designed in order to prevent spills and discharges into the environment. The workshop staff have the knowledge and the tools required to guarantee good environmental care.

### Recycling

Since Volvo works from a life cycle perspective, it is also important that the car is recycled in an environmentally sound manner. Almost all of the car can be recycled. The last owner of the car is therefore requested to contact a retailer for referral to a certified/approved recycling facility.

### Related information

- Fuel consumption and CO<sub>2</sub> emissions (p. 658)
- Economical driving (p. 455)
- Start and switch off preconditioning (p. 220)



## YOUR VOLVO

- ◀◀ • The owner's manual and the environment (p. 23)
- Air quality (p. 198)



## IntelliSafe – driver support and safety

IntelliSafe is the Volvo Cars concept for car safety. IntelliSafe comprises a number of systems<sup>5</sup>, whose purpose is to make a car journey safer, to prevent injuries and to protect passengers and other road users.

### WARNING

The functions are supplementary aids - they cannot handle all situations in all conditions.

The driver always bears responsibility that the vehicle is driven safely and that applicable road traffic rules and regulations are followed.

### Support

With the aim of assisting the driver to drive the car in a safer way, IntelliSafe has the following functions.

- Active main beam
- Tunnel detection
- Pilot Assist
- Cross Traffic Alert
- Blind Spot Information
- Park Assist\*
- Park Assist Pilot\*
- Park assist camera\*

- Road Sign Information\*
- Electronic stability control
- Roll Stability Control
- Speed limiter\*
- Cruise control
- Adaptive cruise control\*
- Rear Collision Warning
- Driver Alert Control
- All-wheel drive<sup>6</sup>

### Prevention

With the aim of assisting the driver to avoid an accident, IntelliSafe has the following functions.

- City Safety
- Distance Warning\*
- Lane assistance
- **Collision Avoid. Assistance**

### Protection

With the aim of protecting the driver and passengers in certain situations in the event of an accident, IntelliSafe has the following collaborative functions.

- Whiplash Protection System
- Pedestrian Protection System
- Seatbelts with seatbelt tensioners

- Airbags

### NOTE

Read the individual sections on each system in order to fully understand the functions and learn about important warnings.

### Related information

- Active main beam (p. 148)
- Safety (p. 42)
- Driving support systems (p. 278)

<sup>5</sup> Some of the systems are fitted as standard, while others are options. This may vary depending on market, model year and car model.

<sup>6</sup> All Wheel Drive

## **Sensus - online connectivity and entertainment**

Sensus makes it possible to use different types of apps and turn the car into a Wi-Fi hotspot.

### **This is Sensus**

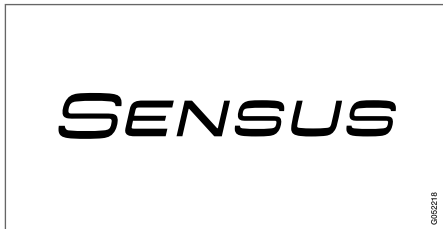

Sensus offers an intelligent interface and online connectivity with the digital world. An intuitive navigation structure makes it possible to receive relevant support, information and entertainment when it is necessary, without distracting the driver.

Sensus covers all solutions in the car that are connected with entertainment, online connectivity, navigation\* and the user interface between driver and car. It is Sensus that makes communication possible between you, the car and the outside world.

## **Information when it is needed, where it is needed**

The different displays in the car provide information at the right time. The information is shown in different locations based on how it should be prioritised by the driver.



Different types of information are shown in different displays depending on how the information should be prioritised.

### Head-up display\*

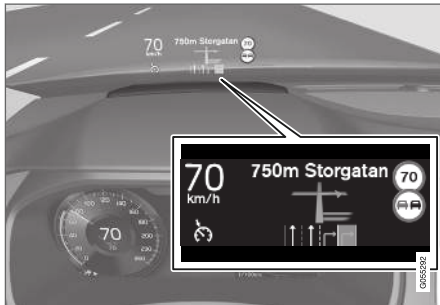

The head-up display shows selected information that the driver should deal with as soon as possible. Such information may, for example, include

traffic warnings, speed information and navigation\* information. Road Sign Information and incoming phone calls are also shown in the head-up display. The display is operated via the right-hand steering wheel keypad and via the centre display.

### Driver display



The driver display shows information on speed and e.g. incoming calls or song tracks being



- ◀ played. The display is operated via the two steering wheel keypads.

### Centre display



Many of the main functions of the car are controlled from the centre display, a touch screen which reacts to touch. The number of physical buttons and controls in the car is therefore minimal. The screen can even be operated while wearing gloves.

From here, for example, you can control the climate control system, the entertainment system and seat position\*. The information that is shown in the centre display can be acted on by the driver or someone else in the car when the opportunity arises.

### Voice recognition system



The voice recognition system can be used without the driver needing to take his/her hands off the steering wheel. The system can understand natural speech. Use voice recognition to, for example, play back a

song, call someone, increase the temperature or read out a text message.

### Related information

- Head-up display\* (p. 135)
- Driver display (p. 77)
- Overview of centre display (p. 102)
- Voice recognition (p. 138)
- Internet-connected car\* (p. 521)
- Sharing Internet access from the car via a Wi-Fi hotspot (p. 525)

## Software updates

So that you as a Volvo customer get the best experience of your car, Volvo continuously develops the systems in the cars and the services that you are offered.

You can update the software in your Volvo to the latest version when your car is serviced at an authorised Volvo dealer. The latest software update allows you to benefit from available improvements, including improvements from earlier software updates.

For more information about released updates and answers to frequently asked questions, please go to [support.volvocars.com](http://support.volvocars.com).

### **i** NOTE

Functionality after updating may vary depending on market, model, model year and options.

## Related information

- Sensus - online connectivity and entertainment (p. 32)
- Managing system updates via the Download Centre (p. 591)

## Recording data

As part of Volvo's safety and quality assurance, certain information about the vehicle's operation, functionality and incidents are recorded in the car.

This vehicle is equipped with an "Event Data Recorder" (EDR). Its primary purpose is to register and record data related to traffic accidents or collision-like situations, such as times when the airbag deploys or the vehicle strikes an obstacle in the road. The data is recorded in order to increase understanding of how vehicle systems work in these types of situations. The EDR is designed to record data related to vehicle dynamics and safety systems for a short time, usually 30 seconds or less.

The EDR in this vehicle is designed to record data related to the following in the event of traffic accidents or collision-like situations:

- How the various systems in the car worked
- Whether the driver and passenger seatbelts were fastened/tensioned
- The driver's use of the accelerator or brake pedal
- The travel speed of the vehicle

This information can help us better understand the circumstances in which traffic accidents, injuries and damage occur. The EDR only records data when a non-trivial collision situation occurs. The EDR does not record any data during normal

driving conditions. Similarly, the system never registers who is driving the vehicle or the geographic location of the accident or near-miss situation. However, other parties, such as the police, could use the recorded data in combination with the type of personally identifiable information routinely collected after a traffic accident. Special equipment and access to either the vehicle or the EDR is required to be able to interpret the registered data.

In addition to the EDR, the car is equipped with a number of computers designed to continually check and monitor the function of the car. They can record data during normal driving conditions, but in particular register faults affecting the vehicle's operation and functionality, or upon activation of the vehicle's driver support function (e.g. City Safety and the auto brake function).

Some of the recorded data is required to enable service and maintenance technicians to diagnose and remedy any faults that occurred in the vehicle. The registered information is also needed to enable Volvo to satisfy legal requirements laid out in laws and by government authorities. Information registered in the vehicle is stored in its computer until the vehicle is serviced or repaired.

In addition to the above, the registered information can be used in aggregate form for research and product development with the aim of continuously improving the safety and quality of Volvo cars.



Volvo will not contribute to the above-described information being disclosed to third parties without the vehicle owner's consent. To comply with national legislation and regulations, Volvo may be forced to disclose information of this nature to the police or other authorities who may assert a legal right to access such. Special technical equipment which Volvo and workshops that have entered into agreements with Volvo have access to is required to be able to read and interpret the recorded data. Volvo is responsible that the information, which is transferred to Volvo during servicing and maintenance, is securely stored and managed and that its management complies with relevant legal requirements. For further information - contact a Volvo retailer.

### **Terms & Conditions for Services**

Volvo offers services so that you can drive your Volvo as safely and as comfortably as possible.

These services include everything from assistance in emergencies to navigation and various maintenance services.

Before using the services, it is important for you to read the Terms & Conditions for Services at [support.volvocars.com](http://support.volvocars.com).

### **Related information**

- Customer Privacy Policy (p. 36)

### **Customer Privacy Policy**

Volvo respects and safeguards the personal integrity of everyone visiting our website.

This policy regards to the handling of customer data and personal information. The purpose is to give current, past and potential customers a general understanding of:

- The circumstances in which we gather and process your personal data.
- The types of personal data we gather.
- The reason we gather your personal data.
- How we handle your personal data.

This policy can be read in its entirety at [support.volvocars.com](http://support.volvocars.com).

### **Related information**

- User terms and conditions and data sharing (p. 527)
- Terms & Conditions for Services (p. 36)
- Recording data (p. 35)

## Important information on accessories and auxiliary equipment

The incorrect connection and installation of accessories and extra equipment can negatively affect the car's electronic system.

We strongly recommend that Volvo owners only install Volvo approved original accessories, and that installation of accessories is only carried out by trained and qualified Volvo service technicians. Certain accessories only function when associated software is installed in the car's computer system.

The equipment described in the owner's manual is not available in all cars - they have different equipment depending on adaptations for the needs of different markets and national or local laws and regulations.

Options or accessories described in this manual are marked with an asterisk. In the event of uncertainty over what is standard or an option/ accessory, contact a Volvo retailer.

### WARNING

The driver always bears the ultimate responsibility that the car is used safely and that laws and regulations in force are followed.

It is also important that the car has maintenance and service according to Volvo's recommendations, the owner's information and the service and warranty booklet.

If the on-board information differs from the printed owner's manual then the printed information always has precedence.

### Related information

- Installation of accessories (p. 37)
- Connection of equipment to the car's diagnostic socket (p. 38)
- Reading the owner's manual (p. 21)

## Installation of accessories

We strongly recommend that Volvo owners only install Volvo approved original accessories, and that installation of accessories is only carried out by trained and qualified Volvo service technicians. Certain accessories only function when associated software is installed in the car's computer system.

- Volvo original accessories are tested to ensure that they function with the car systems for performance, safety and emissions control. In addition, a trained and qualified Volvo service technician knows where accessories may or may not be safely installed in your Volvo. Always seek the advice of a trained and qualified Volvo service technician before installing any accessories in or on your car.
- Accessories that are not approved by Volvo may not have been specifically tested for use with your car.
- Some of the car's performance or safety systems can be negatively affected if you install accessories that have not been tested by Volvo, or if you permit someone without experience of the car to install accessories.
- Damage that is caused by accessories installed in a non-approved or incorrect way is not covered by any new car warranty. More warranty information can be found in the service and warranty booklet. Volvo does not accept



- ◀◀ any liability for deaths, personal injury or costs arising as a result of the installation of non-original accessories.

### Related information

- Important information on accessories and auxiliary equipment (p. 37)

### Connection of equipment to the car's diagnostic socket

Incorrect connection and installation of software or diagnostic tools may have a negative effect on the car's electronic system.

We strongly recommend that Volvo owners only install Volvo approved original accessories, and that installation of accessories is only carried out by trained and qualified Volvo service technicians. Certain accessories only function when associated software is installed in the car's computer system.



Data link connector (On-board Diagnostic, OBDII) is under the instrument panel on the driver's side.

<b>i NOTE</b>
Volvo Cars accepts no liability for the consequences if unauthorised equipment is connected to the On-board Diagnostic socket (OBDII). This socket should only be used by trained and qualified Volvo service technicians.

### Related information

- Important information on accessories and auxiliary equipment (p. 37)



## Showing the car's identification number

When contacting a Volvo dealer concerning your Volvo On Call subscription, for example, you will need the car's identification number (VIN<sup>7</sup>).

1. Press **Settings** in the top view in the centre display.
2. Continue to **System** → **System Information** → **Vehicle Identification Number**.  
 > The car's identification number is shown.

Another way of finding the VIN is to look on the dashboard through the car's windscreen, on the first page of the service and warranty booklet or in the car's registration certificate.



VIN is positioned in a similar place on all models.

<sup>7</sup> Vehicle Identification Number

## Driver distraction

The driver is responsible for doing everything possible to ensure the safety of themselves, their passengers and other road users. Part of this responsibility is avoiding distractions such as carrying out an activity that is not related to operating the car in a driving environment.

Your new Volvo is, or can be, equipped with content-rich entertainment and communications systems. This could be mobile phones with hands-free, navigation systems and audio systems with lots of functions. You may also have other portable electronic devices for your own convenience. Used correctly, in a safe way they can enrich the driving experience. If they are used in the wrong way they could distract you.

We wish to give the following warnings regarding such systems, to indicate Volvo's concern for your safety. Never use a device or function in the car in such a way that it will distract you from the task of driving safely. Distractions can lead to serious accidents. Apart from these general warnings, we offer the following advice regarding the new functions that may be in the car:

### **WARNING**

- Never use a hand-held mobile phone while driving. In some areas it is forbidden for the driver to use a mobile phone while the car is moving.
- If the car is equipped with a navigation system you must only set and change the itinerary when the car is parked.
- Never program the audio system while the car is moving. Program the radio's presets when the car is parked and then use the programmed presets for faster and simpler use of the radio.
- Never use laptops or hand-held computers while the car is moving.

### Related information

- Sound, media and Internet (p. 486)



SAFETY

## Safety

The vehicle is equipped with several safety systems that work together to protect the vehicle's driver and passengers in the event of an accident.

The car is equipped with a number of sensors that react in the event of an accident and activate different safety systems, such as different types of airbags and seatbelt tensioners. Depending on the specific accident situation, such as collisions at different angles, roll-over or driving off the road, the systems react in different ways to provide the best protection.

There are also mechanical safety systems such as Whiplash Protection System. The car is also constructed so that a large part of the force of a collision is distributed to beams, pillars, floor, roof and other parts of the body.

The car's safety mode may be activated after a collision if an important function in the car has been damaged.

### Warning symbol in driver display



The warning symbol is illuminated in the driver display when the car's electrical system is set in ignition position II. The symbol is extinguished after

approx. 6 seconds if the car's safety system is fault-free.

### WARNING

If the warning symbol remains illuminated or is switched on during driving and the message **SRS airbag Service urgent Drive to workshop** is shown in the driver display, it means that part of one of the safety systems does not have full functionality. Volvo recommends that an authorised Volvo workshop should be contacted as soon as possible.

### WARNING

Never modify or repair the car's various safety systems yourself. Defective work in one of the systems can cause malfunction and result in serious personal injury. Volvo recommends that an authorised Volvo workshop should be contacted.



If the specific warning symbol is broken then the general warning symbol is illuminated instead and the driver display shows the same message.

### Related information

- Safety during pregnancy (p. 42)
- Seatbelts (p. 45)
- Airbags (p. 50)
- Whiplash Protection System (p. 43)
- Pedestrian Protection System (p. 44)
- Safety mode (p. 57)
- Child safety (p. 58)

## Safety during pregnancy

It is important that the seatbelt is used correctly during pregnancy, and that pregnant drivers adjust their seating position.

### Seatbelt

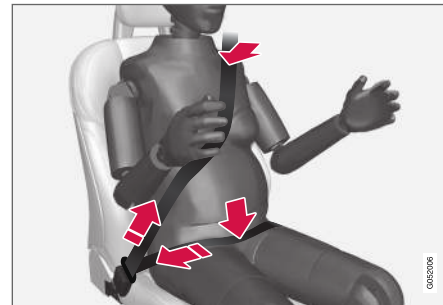

The diagonal section should wrap over the shoulder then be routed between the breasts and to the side of the abdomen.

The lap section should lay flat over the thighs and as low as possible under the abdomen. – It must never be allowed to ride upward. Remove the slack from the seatbelt and ensure that it fits as close to the body as possible. In addition, check that there are no twists in the seatbelt.

### Seating position

As the pregnancy progresses, pregnant drivers must adjust the seat and steering wheel such that they can easily maintain control of the vehi-

cle as they drive (which means that they must be able to easily operate the foot pedals and steering wheel). The aim should be to position the seat with as large a distance as possible between abdomen and steering wheel.

### Related information

- Safety (p. 42)
- Seatbelts (p. 45)
- Manual front seat (p. 178)
- Power\* front seat (p. 179)

## Whiplash Protection System

Whiplash Protection System (WHIPS) reduces the risk of whiplash injuries. The system consists of energy absorbing backrests and seat cushion, as well as a specially designed head restraint in the front seats.

WHIPS is deployed in the event of a rear-end collision, where the angle and speed of the collision and the nature of the colliding vehicle all have an influence.

When WHIPS is deployed, the front seat backrests are lowered backward and the seat cushions move downward to change the seating position of the driver and front seat passenger. Its movement helps to absorb some of the forces that can arise and cause whiplash.

### WARNING

WHIPS is a supplement to the seatbelts. Always use a seatbelt.

### WARNING

Never modify or repair the seat or WHIPS yourself. Volvo recommends that an authorised Volvo workshop should be contacted.

If the front seats have been subjected to a major load, such as in conjunction with a collision, the seats must be replaced. Some of the seats' protective properties may have been lost even if they do not appear damaged.

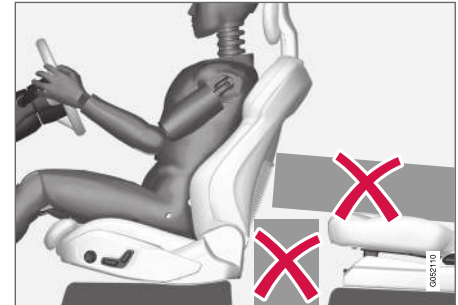

Do not leave any objects on the floor behind or under the front seats or in the rear seat that may prevent WHIPS from functioning.



### **WARNING**

Do not squeeze rigid objects between the rear seat cushion and the front seat's backrest.

If a backrest in the rear seat is lowered then any load must be secured to prevent it from sliding up to the front seat backrest in the event of a collision.

### **WARNING**

If a backrest in the rear seat is lowered or a rear-facing child seat is used in the rear seat, the corresponding front seat must be moved forward so that it does not make contact with the lowered backrest or child seat.

## Seating position

For optimum protection from WHIPS the driver and passenger must have the correct seating position and make sure that the system's function is not obstructed.

Set the correct seating position in the front seat before driving starts.

Driver and front seat passenger should sit in the centre of the seat with as little space as possible between the head and the head restraint.

## WHIPS and child seats

The protection provided by the car to children seated in a child seat or on a booster cushion is not diminished by WHIPS.

## Related information

- Safety (p. 42)
- Manual front seat (p. 178)
- Power\* front seat (p. 179)
- Rear Collision Warning (p. 350)

## Pedestrian Protection System

The Pedestrian Protection System (PPS) is a system which, in certain frontal collisions, contributes to mitigating a pedestrian's impact with the car.

In certain frontal collisions with a pedestrian, the sensors in the front of the car react and the system is activated.

When PPS is activated, the following occur:

- The rear section of the bonnet is raised.
- An automatic alarm is sent via Volvo On Call\*.

The sensors are active at a speed of approx. 25-50 km/h (15-30 mph).

The sensors are designed to detect a collision with an object that has similar properties to those of the human leg.

### **NOTE**

There may be objects in the traffic environment that prompt a signal to the sensors that is similar to a collision with a pedestrian. It is possible that the system will be activated in the event of a collision with such an object.

**⚠ WARNING**

Do not fit any accessories or change anything in the front. Incorrect intervention at the front may cause incorrect function in the system and lead to serious injury and damage to the car.

Volvo recommends that genuine wiper arms are used and that only genuine parts are used for them.

**⚠ WARNING**

Never modify or repair the system yourself. Volvo recommends that an authorised Volvo workshop should be contacted. Defective work in the system could cause malfunction and result in serious personal injury.

**⚠ WARNING**

Volvo recommends contacting an authorised Volvo workshop in the event of any damage to the front of the car in order to ensure that the system is intact.

**Related information**

- Safety (p. 42)

**Seatbelts**

Heavy braking can have serious consequences if the seatbelts are not used.

It is important that the seatbelt lies against the body so it can provide maximum protection. Do not lean the backrest too far back. The seatbelt is designed to protect in a normal seating position.

**⚠ WARNING**

Remember not to clip or hook the seatbelt to hooks or other interior fittings, as this prevents the belt from tightening properly.

**⚠ WARNING**

The seatbelts and airbags interact. If a seatbelt is not used or is used incorrectly, this may diminish the protection provided by the airbag in the event of a collision.

**Symbols in the driver display**

Symbol	Specification
	PPS has been activated, or a fault has occurred in the system. Follow the recommendation given.



### **⚠ WARNING**

Never modify or repair the seatbelts yourself. Volvo recommends that an authorised Volvo workshop should be contacted.

If the seatbelt has been subjected to a major load, such as in conjunction with a collision, the entire seatbelt must be replaced. Some of the seatbelt's protective properties may have been lost even if the seatbelt does not appear damaged. The seatbelt must also be replaced if it shows signs of wear or damage. The new seatbelt must be type-approved and designed for installation at the same location as the replaced seatbelt.

#### **Related information**

- Safety (p. 42)
- Seatbelt tensioner (p. 47)
- Putting on and taking off seatbelts (p. 46)
- Door and seatbelt reminder (p. 49)

### **Putting on and taking off seatbelts**

Make sure that all passengers have fastened their seatbelts before starting to drive.

#### **Putting on seatbelts**

1. Pull out the seatbelt slowly and make sure it is not twisted or damaged.

#### **i NOTE**

The seatbelt is equipped with an inertia reel that is locked in the following situations:

- if the belt is extended too quickly.
- during braking and acceleration.
- if the car leans heavily.
- when driving in bends.

2. Lock the belt by inserting the locking tab in the intended buckle.
  - > A loud "click" indicates that the belt has locked.

### **⚠ WARNING**

Always insert the tongue of the seatbelt into the buckle on the correct side. The seatbelts and buckles would otherwise possibly not function as intended in the event of a collision. There is a risk of serious injury.

3. In the front seats the seatbelt can be adjusted for height.



Press together the seat mounting and move the seatbelt up or down.

Position the belt as high as possible without it chafing against your throat.



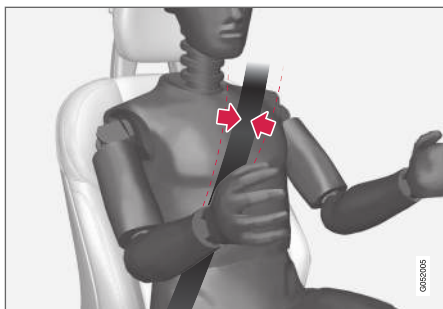

The seatbelt must pass over the shoulder (not down over the arm).

4. Tension the hip strap over the lap by pulling the diagonal shoulder belt up towards the shoulder.

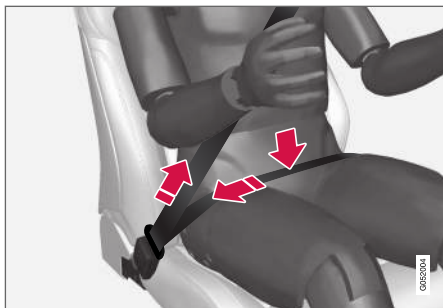

The hip strap must be positioned low down (not over the abdomen).

### **⚠ WARNING**

Each seatbelt is designed for only one person.

### **⚠ WARNING**

Remember not to clip or hook the seatbelt to hooks or other interior fittings, as this prevents the belt from tightening properly.

### **⚠ WARNING**

Do not make any damages on seatbelts nor insert any foreign objects into a buckle. The seatbelts and buckles would then possibly not function as intended in the event of a collision. There is a risk of serious injury.

### **Taking off seatbelts**

1. Press the red button on the seatbelt buckle and then let the belt retract.
2. If the seatbelt does not retract fully, feed it in by hand so that it does not hang loose.

### **Related information**

- Seatbelts (p. 45)
- Seatbelt tensioner (p. 47)
- Door and seatbelt reminder (p. 49)

## **Seatbelt tensioner**

The car is fitted with standard seatbelt tensioners and electric\* seatbelt tensioners that can tension the seatbelts in critical situations and collisions.

### **Standard seatbelt tensioner**

All the seatbelts are equipped with a standard seatbelt tensioner.

The seatbelt tensioner tensions the seatbelt in the event of a collision with sufficient force in order to more effectively restrain the occupant.

### **Electric seatbelt tensioner\***

The driver and front passenger seatbelts are equipped with an electric seatbelt tensioner.

The seatbelt tensioners work together and can be activated together with the driver support systems City Safety and Rear Collision Warning. In critical situations, such as panic braking, driving off the road (e.g. the car rolls into a ditch, lifts off the ground or hits something in the terrain), skidding, or risk of collision, the seatbelt can be tensioned by the seatbelt tensioner's electric motor.

The electric seatbelt tensioner helps to adjust the occupant to a better position, reducing the risk of striking the car's interior and improving the effect of safety systems, such as the car's airbags.

When the critical situation has come to an end, the seatbelt and the electric seatbelt preten-



## SAFETY

- ◀◀ sioner are restored automatically, but they can also be restored manually.

### **IMPORTANT**

If the passenger airbag is deactivated, the electric seatbelt tensioner on the passenger side will also be deactivated.

### **WARNING**

Never modify or repair the seatbelts yourself. Volvo recommends that an authorised Volvo workshop should be contacted.

If the seatbelt has been subjected to a major load, such as in conjunction with a collision, the entire seatbelt must be replaced. Some of the seatbelt's protective properties may have been lost even if the seatbelt does not appear damaged. The seatbelt must also be replaced if it shows signs of wear or damage. The new seatbelt must be type-approved and designed for installation at the same location as the replaced seatbelt.

### **Related information**

- Seatbelts (p. 45)
- Putting on and taking off seatbelts (p. 46)
- Resetting the electric seatbelt tensioner\* (p. 48)
- Activating and deactivating passenger airbag\* (p. 53)

- City Safety™ (p. 335)
- Rear Collision Warning (p. 350)

## **Resetting the electric seatbelt tensioner\***

The electric seatbelt tensioner is designed to be reset automatically, but the seatbelt tensioner can be reset manually if the belt remains extended.

1. Stop the car at a safe place.
2. Unfasten the seatbelt and then refasten it.
  - > The seatbelt and electric seatbelt tensioner are reset.

### **WARNING**

Never modify or repair the seatbelts yourself. Volvo recommends that an authorised Volvo workshop should be contacted.

If the seatbelt has been subjected to a major load, such as in conjunction with a collision, the entire seatbelt must be replaced. Some of the seatbelt's protective properties may have been lost even if the seatbelt does not appear damaged. The seatbelt must also be replaced if it shows signs of wear or damage. The new seatbelt must be type-approved and designed for installation at the same location as the replaced seatbelt.

### **Related information**

- Seatbelt tensioner (p. 47)
- Seatbelts (p. 45)

## Door and seatbelt reminder

The system reminds unbelted occupants to wear a seatbelt, and also warns about an open door, bonnet or lid.

### Driver display graphics

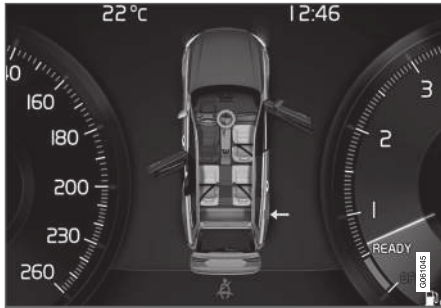

Graphics in the driver display with different types of warnings. The warning colour on the door and tailgate is dependent on the vehicle's speed.

The driver display's graphics show which seats in the car are occupied by belted and unbelted passengers.

The same graphic also shows if the bonnet, tailgate, fuel filler flap or any door is open.

The graphic can be acknowledged by pressing the **O** button on the right-hand steering wheel keypad.

## Seatbelt reminder



Visual reminder in the roof console.

A visual reminder is given in the roof console and by means of the warning symbol in the driver display.

The acoustic reminder is dependent on speed, driving time and distance.

The belt status of the driver and passengers is shown in the driver display graphics when a belt is buckled or unbuckled.

Child seats are not covered by the seatbelt reminder system.

### Front seat

A visual and acoustic reminder remind the driver and front seat passenger to use a seatbelt if either of them is not wearing one.

## Rear seat

The seatbelt reminder in the rear seat has two subfunctions:

- Provides information on which seatbelts are being used in the rear seat. The driver display's graphics are shown when the seatbelts are in use.
- Reminding that a seatbelt in the rear seat is unfastened during a journey by means of a visual and acoustic reminder. The reminder will cease once the seatbelt has been put on again.

## Reminder for doors, bonnet, tailgate and fuel filler flap

If the bonnet, tailgate, fuel filler flap or a door is not closed properly, the driver display's graphics show what is open. Stop the car in a safe place as soon as possible and close the source of the warning.



If the car is driven at a speed lower than approx. 10 km/h (6 mph) then the driver display's information symbol illuminates.



If the car is driven at a speed higher than approx. 10 km/h (6 mph) then the driver display's warning symbol illuminates.

## ◀ Related information

- Seatbelts (p. 45)
- Putting on and taking off seatbelts (p. 46)

## Airbags

The car is equipped with airbags and inflatable curtains for driver and passengers.

### NOTE

The detectors react differently depending on the nature of the collision and whether or not the seatbelts are fastened. Applies to all belt positions.

It is therefore possible that only one (or none) of the airbags may inflate in a collision. The detectors sense the force of the collision on the vehicle and the action is adapted accordingly so that none, one or more airbags are deployed.

### WARNING

The airbag system's control module is located in the centre console. If the centre console is drenched with water or other liquid, disconnect the cables to the starter battery. Do not attempt to start the car since the airbags may deploy. Recovering the car. Volvo recommends that it is transported to an authorised Volvo workshop.

## Deployed airbags

If any of the airbags have deployed, the following is recommended:

- Recovering the car. Volvo recommends that it is transported to an authorised Volvo workshop. Do not drive with deployed airbags.
- Volvo recommends engaging an authorised Volvo workshop to handle the replacement of components in the car's safety systems.
- Always contact a doctor.

### WARNING

Never drive with deployed airbags. They can make steering difficult. Other safety systems may also be damaged. The smoke and dust created when the airbags are deployed can cause skin and eye irritation/injury after intensive exposure. In case of irritation, wash with cold water. The rapid deployment sequence and airbag fabric may cause friction and skin burns.

## Related information

- Safety (p. 42)
- Driver airbags (p. 51)
- Passenger airbag (p. 52)
- Side airbags (p. 55)
- Inflatable curtains (p. 56)

## Driver airbags

As a supplement to the seatbelts, the car is equipped with steering wheel airbag and knee airbag<sup>1</sup> on the driver's side.

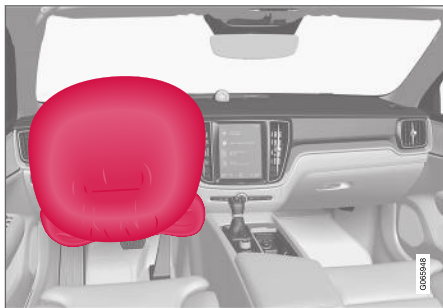

Steering wheel airbag and knee airbag<sup>1</sup> on the driver's side in the front seat.

In the event of a frontal collision, the airbags help to protect the head, neck, face and chest of the driver as well as the knees and legs.

A sufficiently violent collision trips the sensors and the airbag/airbags is inflated. The airbag cushions the initial collision impact for the occupant. The airbag deflates when compressed by the collision. When this occurs, smoke escapes into the car. This is completely normal. The entire process, including inflation and deflation of the airbag, occurs within tenths of a second.

<sup>1</sup> The car is only equipped with knee airbag in certain markets.

### WARNING

The seatbelts and airbags interact. If the belt is not used or is used incorrectly, this may diminish the protection provided by the airbag in the event of a collision.

To minimise the risk of injury if the airbag deploys, passengers must sit as upright as possible with their feet on the floor and backs against the backrest.

### WARNING

Volvo recommends that an authorised Volvo workshop should be contacted for repair. Defective work in the airbag system could cause malfunction and result in serious personal injury.

## Steering wheel airbag location

This airbag is fitted into the centre of the steering wheel. The steering wheel is marked **AIRBAG**.

## Knee airbag<sup>1</sup> location

The airbag is folded up in the lower part of the instrument panel on the driver's side. Its cover panel is marked **AIRBAG**.

### WARNING

Do not place or attach any object on the top or front of the panel where the knee airbag is stowed.

## Related information

- Airbags (p. 50)
- Passenger airbag (p. 52)

## Passenger airbag

As a supplement to the seatbelts, the vehicle is equipped with an airbag on the passenger side in the front seat.



Front passenger airbag in front seat.

In the event of a frontal collision, the airbag helps to protect the head, neck, face and chest of the passenger as well as the knees and legs.

A sufficiently violent collision trips the sensors and the airbag is inflated. The airbag cushions the initial collision impact for the occupant. The airbag deflates when compressed by the collision. When this occurs, smoke escapes into the car. This is completely normal. The entire process, including inflation and deflation of the airbag, occurs within tenths of a second.

### WARNING

The seatbelts and airbags interact. If the belt is not used or is used incorrectly, this may diminish the protection provided by the airbag in the event of a collision.

To minimise the risk of injury if the airbag deploys, passengers must sit as upright as possible with their feet on the floor and backs against the backrest.

### WARNING

Volvo recommends that an authorised Volvo workshop should be contacted for repair. Defective work in the airbag system could cause malfunction and result in serious personal injury.

## Passenger airbag location

The airbag is folded up into a compartment above the glovebox. Its cover panel is marked **AIRBAG**.

### WARNING

Do not put objects in front of or above the dashboard where the passenger airbag is located.

## Label for passenger airbag



Label on the passenger side's sun visor.

The warning label for the passenger airbag is positioned as shown above.

### WARNING

If the car is not equipped with a switch to activate/deactivate the passenger airbag, the airbag will always be activated.

**⚠ WARNING**

Never allow anybody to stand or sit in front of the front passenger seat.

Never use a rear-facing child seat on the front passenger seat if the airbag is activated.

Front-facing passengers (children and adults) must never sit on the front passenger seat if the passenger airbag is deactivated.

Failure to follow the advice given above can endanger life or lead to serious personal injury.

**Related information**

- Airbags (p. 50)
- Driver airbags (p. 51)
- Activating and deactivating passenger airbag\* (p. 53)

**Activating and deactivating passenger airbag\***

The passenger airbag can be deactivated if the car is equipped with a switch, Passenger Airbag Cut Off Switch (PACOS).

The switch for the passenger airbag is located on the passenger end of the instrument panel and is accessible when the passenger door is open.

Check that the switch is in the required position.

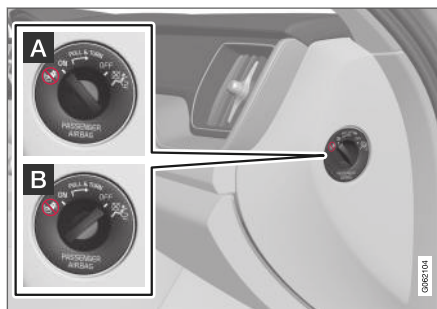

**A ON** - the airbag is activated and all front-facing passengers (children and adults) can sit safely on the passenger seat.

**B OFF** - The airbag is deactivated and children in rear-facing child seats can sit safely on the passenger seat.

**⚠ WARNING**

If the car is not equipped with a switch to activate/deactivate the passenger airbag, the airbag will always be activated.

## ◀ Activating passenger airbag



- 1 Pull the switch outward and turn from **OFF** to **ON**.

> The driver display shows the message **Passenger airbag on Please acknowledge**.

### **i** NOTE

If the passenger airbag has been activated/deactivated with the car in ignition position **I** or lower, a message is shown in the driver display and the following indicator in the roof console approx. 6 seconds after the car's electrical system has been set in ignition position **II**.

2. Confirm the message by pressing the right-hand steering wheel keypad's **O** button.

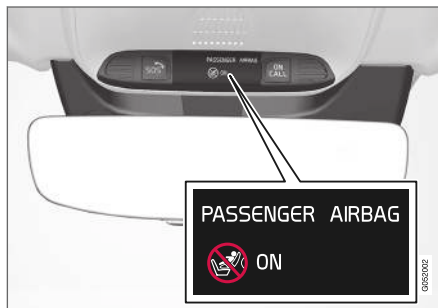

> A text message and a warning symbol in the roof console indicate that the airbag for the front passenger seat is activated.

### **⚠** WARNING

Never use a rear-facing child seat on the front passenger seat when the airbag is activated.

The passenger airbag must always be activated when front-facing passengers (children and adults) are sitting in the front passenger seat.

Failure to follow the advice given above can endanger life or lead to serious personal injury.

## Deactivating passenger airbag



- 1 Pull the switch outward and turn from **ON** to **OFF**.

> The driver display shows the message **Passenger airbag off Please acknowledge**.

### **i** NOTE

If the passenger airbag has been activated/deactivated with the car in ignition position **I** or lower, a message is shown in the driver display and the following indicator in the roof console approx. 6 seconds after the car's electrical system has been set in ignition position **II**.



- Confirm the message by pressing the right-hand steering wheel keypad's **O** button.

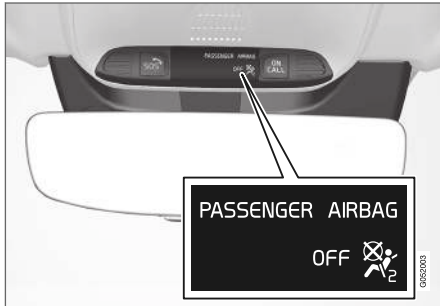

- > A text message and a symbol in the roof console indicate that the airbag for the front passenger seat is deactivated.

### **⚠ WARNING**

Front-facing passengers (children and adults) must never sit on the passenger seat when the airbag is deactivated.

Failure to follow the advice given above can endanger life or lead to serious personal injury.

### **! IMPORTANT**

If the passenger airbag is deactivated, the electric seatbelt tensioner on the passenger side will also be deactivated.

### **Related information**

- Seatbelt tensioner (p. 47)
- Child seats (p. 59)

### **Side airbags**

The side airbags on the driver's and passenger seats act to protect the chest and hips in the event of a collision.



The side airbags are fitted in the outer backrest frames of the front seats and help to protect the driver and passengers in the front seat.

A sufficiently violent collision trips the sensors and the side airbags are inflated. The airbag inflates between the occupant and the door panel and thereby cushions the initial impact. The airbag deflates when compressed by the collision. The side airbag is normally only deployed on the side of the collision.



### **⚠ WARNING**

Volvo recommends that an authorised Volvo workshop should be contacted for repair. Defective work in the side airbag system could cause malfunction and result in serious personal injury.

### **⚠ WARNING**

Do not put objects in the area between the outside of the seat and the door panel, since this area is required by the side airbag.

Volvo recommends the use only of car seat covers approved by Volvo. Other seat covers may impede the operation of the side airbags.

### **⚠ WARNING**

Side airbags are a supplement the seatbelts. Always use a seatbelt.

### **Side airbags and child seats**

The protection provided by the car to children seated in a child seat or on a booster cushion is not diminished by the side airbag.

### **Related information**

- Airbags (p. 50)

### **Inflatable curtains**

The Inflatable Curtain (IC), helps to prevent the driver and passengers from striking their heads on the inside of the car during a collision.

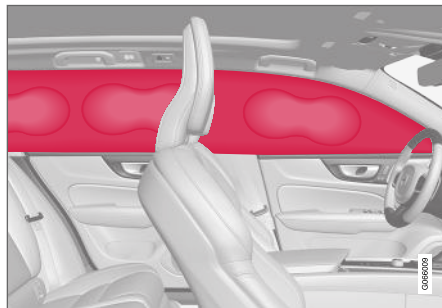

The inflatable curtain is mounted along both sides of the headlining and helps protect the driver and outer seat passengers of the car. The panels are labelled with **IC AIRBAG**.

A sufficiently violent collision trips the sensors and the inflatable curtain is inflated.

### **⚠ WARNING**

Volvo recommends that an authorised Volvo workshop should be contacted for repair. Defective work in the inflatable curtain system can cause malfunction and result in serious personal injury.

### **⚠ WARNING**

Never hang or attach heavy items onto the handles in the roof. The hooks are only designed for light coats and jackets (not for solid objects such as umbrellas).

Do not screw or install anything onto the car's headlining, door pillars or side panels. This could compromise the intended protection. Volvo recommends only using Volvo genuine parts that are approved for fitting within these areas.

### **⚠ WARNING**

Leave 10 cm (4 inches) space between the load and the side windows if the car is loaded to above the top edge of the door windows. Otherwise, the intended protection of the inflatable curtain, which is concealed in the headlining, may be compromised.

### **⚠ WARNING**

The inflatable curtain is a supplement to the seatbelts. Always use a seatbelt.

### **Related information**

- Airbags (p. 50)

## Safety mode

Safety mode is a protective state that is triggered when a collision may have damaged any of the car's vital functions, such as the fuel lines, sensors for any of the safety systems, or the brake system.

If the car has been in a collision, the message **Safety mode See Owner's manual** may be shown on the driver display with a warning symbol as long as the display is not damaged and the car's electrical system is still in working order. This message means that the car has reduced functionality.

### WARNING

Never, under any circumstances, attempt to restart the car if it smells of fuel when the **Safety mode See Owner's manual** message is shown in the driver display. Leave the car at once.

If the car is in safety mode, it is possible to attempt to reset the system in order to start and move the car for a short distance, if in a dangerous traffic situation for example.

### WARNING

Never attempt to repair your car or reset the electronics yourself if the car has been in safety mode. This could result in personal injury or the car not functioning as normal. Volvo recommends that engaging an authorised Volvo workshop to check and restore the car to normal status after **Safety mode See Owner's manual** has been shown.

### WARNING

If the car is in safety mode it must not be towed. It must be transported from its location. Volvo recommends that it is transported to an authorised Volvo workshop.

## Related information

- Safety (p. 42)
- Starting and moving the car after safety mode (p. 57)
- Recovery (p. 479)

## Starting and moving the car after safety mode

If the car is in safety mode, it is possible to attempt to reset the system in order to start and move the car for a short distance, if in a dangerous traffic situation for example.

## Starting the car after safety mode

1. Check the general damage situation of the car and whether any fuel has been leaking. There must be no smell of fuel either.

If there is only minor damage and a check has revealed no fuel leaks, starting can be attempted.

### WARNING

Never, under any circumstances, attempt to restart the car if it smells of fuel when the **Safety mode See Owner's manual** message is shown in the driver display. Leave the car at once.

2. Switch off the car.
3. Then try to start the car.
  - > The car's electronics carry out a systems check and then try to resume normal status. The driver display shows the message **Car start System check, wait** during this time. This can take up to one minute.

- ◀ 4. Then try to start the car again when the message **Car start System check, wait** is no longer shown in the driver's display.

### **IMPORTANT**

If the message **Safety mode See Owner's manual** is still shown on the display the car must not be driven or towed but a vehicle recovery service must then be used instead. Even if the car appears to be driveable, hidden damage may make the car impossible to control once moving.

### **Moving the car after safety mode**

1. If the driver display shows the message **Normal mode The car is now in normal mode** after a start attempt, the car can be carefully moved if standing in a dangerous position.
2. Do not move the car further than necessary.

### **WARNING**

If the car is in safety mode it must not be towed. It must be transported from its location. Volvo recommends that it is transported to an authorised Volvo workshop.

### **Related information**

- Safety mode (p. 57)
- Starting the car (p. 426)
- Recovery (p. 479)

### **Child safety**

Children must always sit secure while travelling in the car.

Volvo has child safety equipment (child seats and attachment devices) which is designed for fitting in this particular car. Using Volvo's child safety equipment, you obtain the optimum conditions for a child to travel safely in the car. In addition, the child safety equipment fits in well and is simple to use.

The equipment that should be used is selected taking account of the weight and size of the child.

Volvo recommends that children travel in a rear-facing child seat until as late an age as possible, at least until 3-4 years of age, and then in a front-facing child seat until the child is 140 cm (4 feet 7 inches) tall.

### **NOTE**

Legal provisions about the type of child seat that must be used for children of different ages and heights vary from country to country. Check what does apply.

**i NOTE**

When using child safety equipment, it is important to read the installation instructions included.

In the event of questions when fitting child safety equipment, contact the manufacturer for clearer instructions.

Children of all ages and sizes must always sit correctly secured in the car. Never allow a child to sit on the knee of a passenger.

**Related information**

- Safety (p. 42)
- Child seats (p. 59)
- Activating and deactivating child safety locks (p. 264)

**Child seats**

**Suitable child seats should always be used when children are travelling in the car.**

Children should sit comfortably and safely. Make sure that the child seat is positioned, mounted and used correctly.

Look in the installation instructions for the child seat for the correct fitting.

**i NOTE**

When using child safety equipment, it is important to read the installation instructions included.

In the event of questions when fitting child safety equipment, contact the manufacturer for clearer instructions.

**i NOTE**

Never leave a child seat loose in the car. Always secure it according to the instructions for the child seat, even when it is not in use.

**Related information**

- Child safety (p. 58)
- Upper mounting points for child seats (p. 60)
- Lower mounting points for child seats (p. 60)

- i-Size/ISOFIX mounting points for child seats (p. 61)
- Child seat positioning (p. 62)
- Activating and deactivating passenger air-bag\* (p. 53)

## Upper mounting points for child seats

The car is equipped with upper mounting points for child seats on the rear seat's outer seats.

The upper mounting points are primarily intended for use with front-facing child seats.

Always follow the manufacturer's installation instructions when connecting a child seat to the upper mounting points.

### The location of the mounting points

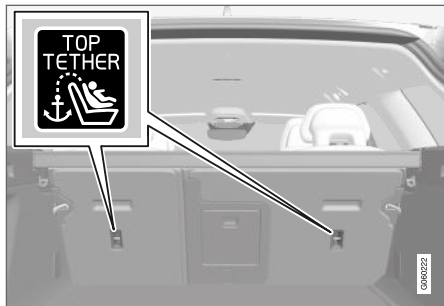

Mounting point locations are indicated by symbols on the rear of the backrest.

The mounting points are located on the rear of the rear seat's outer seats.

## **⚠** WARNING

The child seat's upper straps must be routed through the hole in the head restraint leg before they are tensioned at the mounting point. If this is not possible, follow the recommendations from the child seat manufacturer.

### **i** NOTE

Fold the head restraints in order to facilitate fitting this type of child seat in cars with folding head restraints on the outer seats.

### **i** NOTE

In cars with a cargo cover over the luggage compartment, this must be removed before child seats can be attached to the securing points.

### Related information

- Child seats (p. 59)
- Lower mounting points for child seats (p. 60)
- i-Size/ISOFIX mounting points for child seats (p. 61)
- Overview table for location of child seats (p. 65)
- Table for location of child seats using the car's seatbelts (p. 66)

## Lower mounting points for child seats

The car is equipped with lower mounting points for child seats in the front seat\* and the rear seat.

The lower mounting points are designed to be used in conjunction with certain rear-facing child seats.

Always follow the manufacturer's installation instructions when connecting a child seat to the lower mounting points.

### The location of the mounting points



Mounting point locations in the front seat.

The mounting points in the front seat are located on the sides of the passenger seat's legroom.

The mounting points in the front seat are only mounted if the vehicle is equipped with a switch to activate/deactivate the passenger airbag\*.

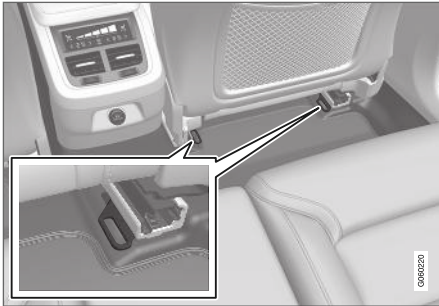

Mounting point locations in the rear seat.

The mounting points in the rear seat are located on the rear section of the front seat's floor rails.

### Related information

- Child seats (p. 59)
- Upper mounting points for child seats (p. 60)
- i-Size/ISOFIX mounting points for child seats (p. 61)
- Overview table for location of child seats (p. 65)
- Table for location of child seats using the car's seatbelts (p. 66)

## i-Size/ISOFIX mounting points for child seats

The car is equipped with i-Size/ISOFIX mounting points for child seats in the rear seat.

i-Size/ISOFIX<sup>2</sup> is a fixture system for car child seats that is based on an international standard.

Always follow the manufacturer's installation instructions when connecting a child seat to the i-Size/ISOFIX mounting points.

### The location of the mounting points



Mounting point locations are indicated by symbols<sup>2</sup> on the upholstery of the backrest.

The mounting points for i-Size/ISOFIX are located behind covers in the lower section of the rear seat's backrest, in the outer seats.

Lift the covers in order to access the mounting points.

### Related information

- Child seats (p. 59)
- Upper mounting points for child seats (p. 60)
- Lower mounting points for child seats (p. 60)
- Overview table for location of child seats (p. 65)
- Table for location of i-Size child seats (p. 68)
- Table for location of ISOFIX child seats (p. 69)

<sup>2</sup> Names and symbols change depending on market.

## Child seat positioning

It is important to position the child seat in the right place in the car. The choice of location depends, amongst other things, on the type of child seat and whether the passenger airbag is activated.



Rear-facing child seat and airbag are not compatible.

Always fit rear-facing child seats in the rear seat if the passenger airbag is activated. If a child is sitting on the front passenger seat then he/she could suffer serious injury if the airbag deploys.

If the passenger airbag is deactivated then rear-facing child seats can be fitted on the front passenger seat.

### NOTE

Regulations regarding the placement of children in cars vary from country to country. Check what does apply.

### WARNING

Never allow anybody to stand or sit in front of the front passenger seat.

Never use a rear-facing child seat on the front passenger seat if the airbag is activated.

Front-facing passengers (children and adults) must never sit on the front passenger seat if the passenger airbag is deactivated.

Failure to follow the advice given above can endanger life or lead to serious personal injury.

## Label for passenger airbag



Label on the passenger side's sun visor.

The warning label for the passenger airbag is positioned as shown above.

## Related information

- Child seats (p. 59)
- Child seat mounting (p. 63)
- Overview table for location of child seats (p. 65)
- Table for location of child seats using the car's seatbelts (p. 66)
- Table for location of i-Size child seats (p. 68)
- Table for location of ISOFIX child seats (p. 69)



## Child seat mounting

It is important to remember a number of things when a child seat is mounted and used, which depend on where the child seat is positioned.

### WARNING

Booster cushions/child seats with steel braces or some other design that could rest on the seatbelt buckle's opening button must not be used, as they could cause the seatbelt buckle to open accidentally.

Do not secure the straps for the child seat into the seat's horizontal adjustment bar or in springs, rails or beams under the seat. Sharp edges may damage the straps.

Do not allow the upper section of the child seat to rest against the windscreen.

### NOTE

When using child safety equipment, it is important to read the installation instructions included.

In the event of questions when fitting child safety equipment, contact the manufacturer for clearer instructions.

### NOTE

Never leave a child seat loose in the car. Always secure it according to the instructions for the child seat, even when it is not in use.

## Installation in the front seat

- When fitting rear-facing child seats, check that the passenger airbag is deactivated.
- When fitting front-facing child seats, check that the passenger airbag is activated.
- Only use child seats that are recommended by Volvo, are universally approved or are semi-universal, and where the car is included on the manufacturer's vehicle list.
- ISOFIX child seats can only be fitted when the car is equipped with the ISOFIX console<sup>3</sup> accessory.
- If the child seat is equipped with lower straps, Volvo recommends that the lower mounting points are used with these<sup>3</sup>.
- If the child seat is equipped with support legs, always fit the support leg/support legs directly to the floor. Never fit a support leg to a footrest or other object.

## Installation in the rear seat

- Only use child seats that are recommended by Volvo, are universally approved<sup>4</sup> or are semi-universal, and where the car is included on the manufacturer's vehicle list.
- A child seat with support legs must not be fitted in the centre seat.
- The outer seats are equipped with the ISOFIX fixture system and are approved for i-Size<sup>5</sup>.
- The outer seats are equipped with upper mounting points. Volvo recommends that child seat's upper straps should be pulled through the hole in the head restraint before being tensioned at the mounting point. If this is not possible, follow the recommendations from the child seat manufacturer.
- If the child seat is equipped with lower straps, never adjust the position of the seat in front after the straps have been fitted in the lower mounting points. Always remember to remove the lower straps when the child seat is not installed.
- If the child seat is equipped with support legs, always fit the support leg/support legs directly to the floor. Never fit a support leg to a footrest or other object.

<sup>3</sup> The accessory range varies depending on market.

<sup>4</sup> Does not apply to the centre seat.

<sup>5</sup> Varies depending on market.

◀◀ **Related information**

- Child seat positioning (p. 62)
- Overview table for location of child seats (p. 65)
- Table for location of child seats using the car's seatbelts (p. 66)
- Table for location of i-Size child seats (p. 68)
- Table for location of ISOFIX child seats (p. 69)

## Overview table for location of child seats

The table gives an overview of the types of child seats suitable for the car's seats.

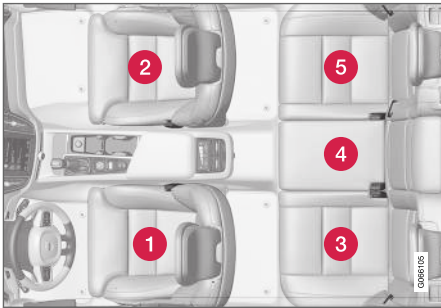

Seat positions in left-hand drive cars.

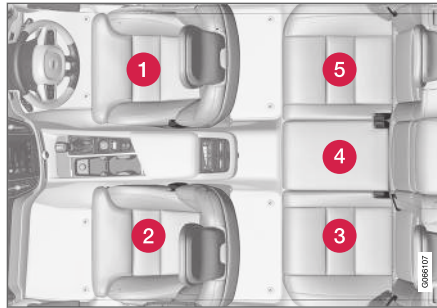

Seat positions in right-hand drive cars.

	i-Size child seats	Universally approved child seats secured using the car's seatbelt	Other child seat categories <sup>A</sup>
Seat position <sup>B</sup>	3, 5	2 <sup>C</sup> , 3, 5	2 <sup>C</sup> , 3, 4, 5

<sup>A</sup> For more information, contact the child seat manufacturer.

<sup>B</sup> According to the numbering above.

<sup>C</sup> Activated airbag for front-facing child seats. Deactivated airbag for rear-facing child seats.

### Related information

- Child seat positioning (p. 62)
- Child seat mounting (p. 63)
- Table for location of child seats using the car's seatbelts (p. 66)
- Table for location of i-Size child seats (p. 68)
- Table for location of ISOFIX child seats (p. 69)

### Table for location of child seats using the car's seatbelts

The table gives a recommendation for which child seats suit which locations, and for what size of child.

 NOTE
Always read the owner's manual section on installing a child seat before installing one in the car.

Weight	Front seat (with deactivated airbag, only rear-facing child seats) <sup>A</sup>	Front seat (with activated airbag, only front-facing child seats) <sup>A</sup>	Outer rear seat	Centre rear seat
Group 0 max 10 kg	U <sup>B, C</sup>	X	U <sup>C</sup>	L <sup>C</sup>
Group 0+ max 13 kg	U <sup>B, C</sup>	X	U <sup>C</sup>	L <sup>C</sup>
Group 1 9-18 kg	L <sup>D</sup>	U <sup>F, B, E</sup>	U <sup>E, L<sup>D</sup></sup>	L <sup>E</sup>
Group 2 15-25 kg	L <sup>D</sup>	U <sup>F, B, F</sup>	U <sup>F, L<sup>D</sup></sup>	L <sup>F</sup>

Weight	Front seat (with deactivated airbag, only rear-facing child seats) <sup>A</sup>	Front seat (with activated airbag, only front-facing child seats) <sup>A</sup>	Outer rear seat	Centre rear seat
Group 3 22-36 kg	X	UF <sup>B,F</sup>	U <sup>F</sup>	L <sup>F</sup>

U: Suitable for universal category restraints approved for use in this mass group.

UF: Suitable for front-facing universally approved child seats.

L: Suitable for particular child restraints. These restraints may be of the specific vehicle, restricted or semi-universal categories.

X: The seat is not suitable for children in this mass group.

<sup>A</sup> The seat cushion extension must always be retracted for the installation of child seats.

<sup>B</sup> Adjust the backrest to a more upright position.

<sup>C</sup> Volvo recommends: Volvo infant seat (type approval E1 04301146).

<sup>D</sup> Volvo recommends: Volvo rear-facing seat (type approval E5 04212).

<sup>E</sup> Volvo recommends rear-facing child seat for children in this mass group.

<sup>F</sup> Volvo recommends: Booster cushion with and without back (type approval E5 04216); Volvo booster seat (type approval E1 04301312).

### WARNING

Never use a rear-facing child seat on the front passenger seat if the passenger airbag is activated.

- Table for location of ISOFIX child seats (p. 69)
- Seatbelts (p. 45)

### Related information

- Child seat positioning (p. 62)
- Child seat mounting (p. 63)
- Overview table for location of child seats (p. 65)
- Table for location of i-Size child seats (p. 68)

## Table for location of i-Size child seats

The table gives a recommendation for which i-Size child seats suit which locations, and for what size of child.

The child seat must be approved in accordance with UN Reg R129.

<b>i NOTE</b>
Always read the owner's manual section on installing a child seat before installing one in the car.

Type of child seat	Front seat (with deactivated airbag, only rear-facing child seats)	Front seat (with activated airbag, only front-facing child seats)	Outer rear seat	Centre rear seat
i-Size child seats	X	X	i-U <sup>A, B</sup>	X

i-U: Suitable for i-Size "universal" child seat, front-facing and rear-facing.

X: Not suitable for universally approved child seats.

A Volvo recommends rear-facing child seats for this group.

B Volvo recommends: BeSafe iZi Kid X2 i-Size (type approval E4-129R-000002).

### Related information

- Child seat positioning (p. 62)
- Child seat mounting (p. 63)
- Overview table for location of child seats (p. 65)
- Table for location of child seats using the car's seatbelts (p. 66)
- Table for location of ISOFIX child seats (p. 69)
- i-Size/ISOFIX mounting points for child seats (p. 61)

## Table for location of ISOFIX child seats

The table gives a recommendation for which ISOFIX child seats suit which locations, and for what size of child.

The child seat must be approved in accordance with UN Reg R44 and the car model must be included in the manufacturer's vehicle list.

<b>i</b> <b>NOTE</b>
Always read the owner's manual section on installing a child seat before installing one in the car.

Weight	Size class <sup>A</sup>	Type of child seat	Front seat (with deactivated air-bag, only rear-facing child seats) <sup>B, C</sup>	Front seat (with activated air-bag, only front-facing child seats) <sup>B, C</sup>	Outer rear seat	Centre rear seat
Group 0 max 10 kg	E	Rear-facing infant seat	IL <sup>B, D</sup> , X <sup>E</sup>	X	IL <sup>D</sup>	X
Group 0+ max 13 kg	E	Rear-facing infant seat	IL <sup>B, D, F</sup> , X <sup>E</sup>	X	IL <sup>D</sup>	X
	C	Rear-facing child seat				
	D	Rear-facing child seat				



Weight	Size class <sup>A</sup>	Type of child seat	Front seat (with deactivated air-bag, only rear-facing child seats) <sup>B, C</sup>	Front seat (with activated air-bag, only front-facing child seats) <sup>B, C</sup>	Outer rear seat	Centre rear seat
Group 1 9-18 kg	A	Front-facing child seat	X	IL <sup>B, F, G</sup> , X <sup>E</sup>	IL <sup>G</sup> , IU <sup>F, G</sup>	X
	B	Front-facing child seat				
	B1	Front-facing child seat				
	C	Rear-facing child seat	IL <sup>B, F</sup> , X <sup>E</sup>	X	IL	X
	D	Rear-facing child seat				

IL: Suitable for particular ISOFIX child restraint systems. These child restraint systems are those of the specific vehicle, restricted or semi-universal categories.

IUF: Suitable for ISOFIX forward child restraint systems of universal category approved for use in the mass group.

X: Not suitable for ISOFIX child restraint systems.

<sup>A</sup> For child seats with the ISOFIX fixture system there is a size classification to help users choose the right type of child seat. The size class can be read on the child seat's label.

<sup>B</sup> Works for the installation of ISOFIX child seats that are semi-universally approved (IL) if the car is equipped with the ISOFIX console accessory (the accessory range varies depending on market). There are no upper mounting points for child seats here.

<sup>C</sup> The seat cushion extension must always be retracted for the installation of child seats.

<sup>D</sup> Volvo recommends: Volvo infant seat secured using the ISOFIX fixture system (type approval E1 04301146).

<sup>E</sup> Applicable if the car is not fitted with an ISOFIX bracket.

<sup>F</sup> Adjust the backrest so that the head restraint does not interfere with the child seat.

<sup>G</sup> Volvo recommends rear-facing child seat for children in this mass group.

### WARNING

Never use a rear-facing child seat on the front passenger seat if the passenger airbag is activated.

### NOTE

If an i-Size/ISOFIX child seat has no size classification, the car model must be included on the vehicle list for the child seat.

### NOTE

Volvo recommends contacting an authorised Volvo dealer for information about which i-Size/ISOFIX child seats Volvo recommends.



**Related information**

- Child seat positioning (p. 62)
- Child seat mounting (p. 63)
- Overview table for location of child seats (p. 65)
- Table for location of child seats using the car's seatbelts (p. 66)
- Table for location of i-Size child seats (p. 68)
- i-Size/ISOFIX mounting points for child seats (p. 61)



DISPLAYS AND VOICE CONTROL

## Instruments and controls in left-hand drive car

The overviews show where the displays and controls near the driver are located.

### Steering wheel and instrument panel

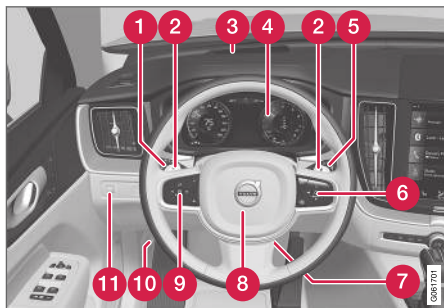

- 1 Position lamps, daytime running lights, dipped beam, main beam, direction indicators, rear fog lamp, resetting the trip meter
- 2 Steering wheel paddles for manual gear changing in an automatic gearbox\*
- 3 Head-up display\*
- 4 Driver display
- 5 Wipers and washing, rain sensor\*
- 6 Right-hand steering wheel keypad

- 7 Steering wheel adjustment
- 8 Horn
- 9 Left-hand steering wheel keypad
- 10 Bonnet opening
- 11 Display lighting, tailgate unlocking/opening\*/closing\*, halogen headlamp levelling

### Roof console



- 1 Front reading lamps and interior lighting
- 2 Panorama roof\*
- 3 Display in roof console, **ON CALL** button\*
- 4 Manual dimming of interior rearview mirror

### Centre and tunnel console

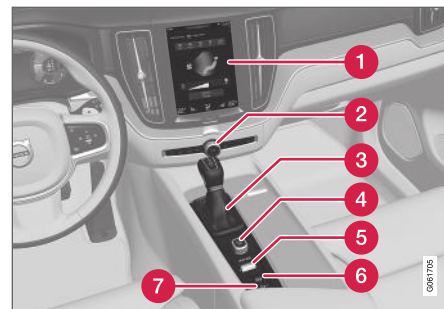

- 1 Centre display
- 2 Hazard warning flashers, defrosting, media
- 3 Gear selector
- 4 Start knob
- 5 Drive mode control
- 6 Parking brake
- 7 Automatic braking when stationary

### Driver's door

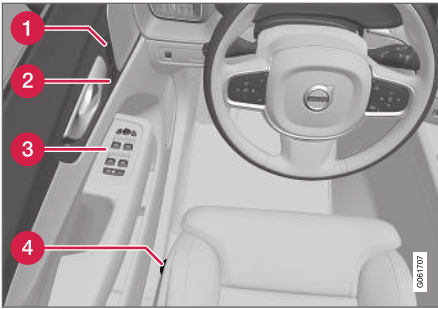

- 1 Memories for power front seat\*, door mirror and head-up display\* settings
- 2 Central locking
- 3 Power windows, door mirrors, electric child safety lock\*
- 4 Adjusting front seat

**Related information**

- Manual front seat (p. 178)
- Adjusting the power\* front seat (p. 179)
- Adjusting the steering wheel (p. 193)
- Lighting control (p. 144)
- Starting the car (p. 426)
- Driver display (p. 77)
- Overview of centre display (p. 102)
- Gearbox (p. 440)

**Instruments and controls in right-hand drive car**

The overviews show where the displays and controls near the driver are located.

**Steering wheel and instrument panel**

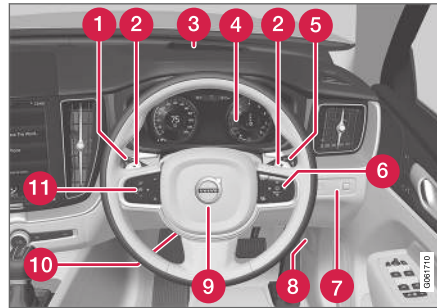

- 1 Position lamps, daytime running lights, dipped beam, main beam, direction indicators, rear fog lamp, resetting the trip meter
- 2 Steering wheel paddles for manual gear changing in an automatic gearbox\*
- 3 Head-up display\*
- 4 Driver display
- 5 Wipers and washing, rain sensor\*
- 6 Right-hand steering wheel keypad
- 7 Display lighting, tailgate unlocking/opening\*/closing\*, halogen headlamp levelling
- 8 Bonnet opening
- 9 Horn
- 10 Steering wheel adjustment
- 11 Left-hand steering wheel keypad

**Roof console**



- 1 Front reading lamps and interior lighting
- 2 Panorama roof\*
- 3 Display in roof console, **ON CALL** button\*
- 4 Manual dimming of interior rearview mirror

**Centre and tunnel console**



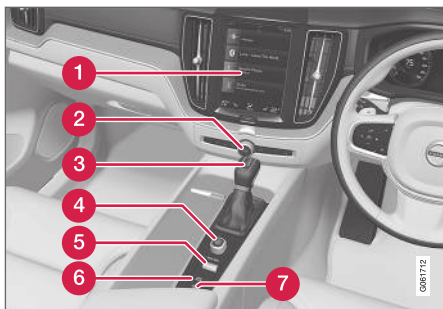

- 1 Centre display
- 2 Hazard warning flashers, defrosting, media
- 3 Gear selector
- 4 Start knob
- 5 Drive mode control
- 6 Parking brake
- 7 Automatic braking when stationary

### Driver's door

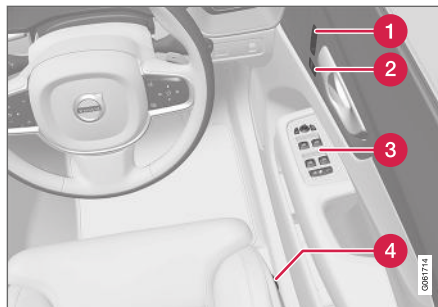

- 1 Memories for power front seat\*, door mirror and head-up display\* settings
- 2 Central locking
- 3 Power windows, door mirrors, electric child safety lock\*
- 4 Adjusting front seat

### Related information

- Manual front seat (p. 178)
- Adjusting the power\* front seat (p. 179)
- Adjusting the steering wheel (p. 193)
- Lighting control (p. 144)
- Starting the car (p. 426)
- Driver display (p. 77)
- Overview of centre display (p. 102)
- Gearbox (p. 440)

## Driver display

The driver display shows information about the car and driving.

The driver display contains gauges, indicators and indicator and warning symbols. The content of the driver display depends on the car's equipment, settings and which functions are active at that time.

The driver display is activated as soon as a door is opened, i.e. in ignition position **0**. The driver display extinguishes after a while if it is not used. To reactivate it, proceed with one of the following:

- Depress the brake pedal.
- Activate ignition position **I**.

- Open one of the doors.

### WARNING

If the driver display should extinguish, not illuminate on activation/start or be fully or partially illegible, the car must not be used. You should visit a workshop immediately. Volvo recommends an authorised Volvo workshop.

### WARNING

In the event of a fault in the driver display the information on e.g. brakes, airbags or other safety systems may not be shown. In which case, the driver cannot check the status of the car's systems or receive current warnings and information.



The figure is schematic - parts may vary depending on car model.

Location in the driver display:

On the left	In the middle	On the right
Speedometer	Indicator and warning symbols	Tachometer/Hybrid gauge <sup>A</sup>
Trip meter	Outside temperature gauge	Gear shift indicator
Odometer <sup>B</sup>	Clock	Drive mode
Cruise control and speed limiter information	Messages, in some cases with graphics	Fuel gauge
Road Sign Information*	Door and seatbelt information	Hybrid battery gauge
–	Charging status	Distance to empty tank
–	Media player	Distance to empty battery





On the left	In the middle	On the right
–	Navigation map*	Instantaneous fuel consumption
–	Phone	App menu (activated via steering wheel keypad)
–	Voice recognition	–

A Depends on drive mode selected.

B Accumulated mileage.

### Dynamic symbol



The dynamic symbol in its basic form.

The centre of the driver display contains a dynamic symbol that changes appearance for different types of message. An amber or red marker around the symbol indicates the degree of severity of a control or warning message.



Examples of indicator symbol.

With an animation, the basic shape can be turned into a graphic showing where a problem is situated, or in order to clarify information.

### Related information

- Driver display settings (p. 79)
- Warning symbols in the driver display (p. 89)

- Indicator symbols in the driver display (p. 87)
- Trip computer (p. 82)
- Messages in the driver display (p. 98)
- Handling the application menu in the driver display (p. 97)



## Driver display settings

Settings for the driver display's display options can be made via the driver display's application menu and via the centre display's settings menu.

### Settings via the driver display's app menu



The figure is schematic - parts may vary depending on car model.

The app menu is opened and controlled using the right-hand keypad on the steering wheel.

In the app menu, you can choose which information is shown on the driver display from

- Trip computer
- media player
- phone
- navigation system\*.

## Settings via the centre display

### Selecting information type

1. Tap on **Settings** in the centre display's top view.
2. Press **My Car → Displays → Driver Display Information**.
3. Select what should be shown in the background:
  - **Show no information in background**
  - **Show information for current playing media**
  - **Show navigation even if no route is set**

### Selecting theme

1. Tap on **Settings** in the centre display's top view.
2. Tap on **My Car → Displays → Display Themes**.
3. Select a theme (appearance) for the driver display:
  - **Glass**
  - **Minimalistic**
  - **Performance**
  - **Chrome Rings**

### Selecting language

1. Tap on **Settings** in the centre display's top view.

2. Tap on **System → System Languages and Units → System Language** to select language.

> A change will affect the language in all displays.

These settings are personal and are saved automatically to the active driver profile.

### Related information

- Driver display (p. 77)
- Handling the application menu in the driver display (p. 97)
- Other settings in the centre display's top view (p. 125)

## Fuel gauge

The fuel gauge in the driver display shows the fuel level in the tank.

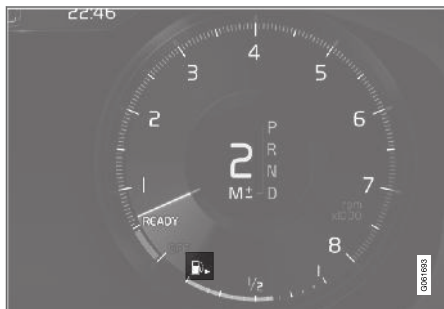

The beige zone in the fuel gauge indicates the quantity of fuel in the tank.

When the fuel level is low and it is soon time to refuel, the fuel pump symbol illuminates and changes to amber. The trip computer also indicates the distance to empty tank.

### Related information

- Driver display (p. 77)
- Hybrid battery gauge (p. 81)
- Filling fuel (p. 462)
- Fuel tank - volume (p. 656)

## Hybrid gauge

In drive modes Hybrid and Pure, the driver display shows a hybrid gauge that can help the driver to drive the car in a more energy-efficient way.



The hybrid gauge shows in different ways the relationship between how much power is being taken from the electric motor and how much power is available.

### Symbols in the hybrid gauge



Indicates current level for available electric motor power. If the symbol is filled in, it means that the electric motor is in use.



If the symbol is not filled in, it means that the electric motor is not in use.



Indicates the power level when the combustion engine starts. If the symbol is filled in, it means that the combustion engine is in use.



Indicates the power level when the internal combustion engine is due to start. If the symbol is not filled in, it means that the combustion engine is not in use.



Indicator that shows that the hybrid battery is being charged, e.g. if the brake pedal is gently depressed.

### Driver-requested power

The pointer in the hybrid gauge indicates the amount of engine power requested by the driver by regulating the accelerator pedal. The higher the reading on the scale, the more power is requested by the driver in the current gear. The marker between the lightning flash and the drop shows the point at which the internal combustion engine starts.

**Example:**

The car is started but stationary, no power is requested.



The electric motor cannot supply the amount of engine power requested and the internal combustion engine starts.



The car generates current to the battery, the battery is charged, e.g. when the brake pedal is pressed lightly or during engine braking down a hill.

**Related information**

- Drive modes (p. 447)
- Driver display (p. 77)
- Foot brake (p. 432)
- Starting and stopping the combustion engine in Twin Engine (p. 446)

**Hybrid battery gauge**



The hybrid battery gauge shows how much energy there is in the hybrid battery.



The energy in the hybrid battery is used for the electric motor, but also to cool or heat the car. The trip computer calculates an approximate distance for the energy left in the hybrid battery.

## ◀ Symbols in the hybrid battery gauge



The  symbol in the hybrid battery gauge indicates that the **Hold** function is activated, and the  symbol indicates that the **Charge** function is activated.

### Related information

- Driver display (p. 77)
- Charging the hybrid battery (p. 405)
- Hold and Charge function (p. 458)

## Trip computer

The car's trip computer records values such as e.g. distance, fuel consumption and average speed whilst driving.

In order to facilitate fuel-efficient driving, information is recorded about both instantaneous and average fuel consumption. The information from the trip computer can be shown in the driver display.



Examples of trip computer information in the driver display.<sup>1</sup>

The following meters are included in the trip computer:

- Trip meter
- Odometer
- Instantaneous fuel consumption

- Distance to empty tank
- Distance to empty battery
- Tourist - alternative speedometer

Units for distance, speed, etc. can be changed via system settings in the centre display.

### Trip meter

There are two trip meters, TM and TA.

TM can be reset manually and TA is reset automatically if the car is not used for at least four hours.

The following information is registered while driving:

- Mileage
- Driving time
- Average speed
- Average fuel consumption

The values apply from the trip meter's latest reset.

### Odometer

The odometer records the car's total mileage. This value cannot be reset to zero.

### Instantaneous fuel consumption

This gauge shows the fuel consumption that the car has at the moment. The value is updated approximately every second.

<sup>1</sup> The figure is schematic - parts may vary depending on car model.

### Distance to empty tank



The trip computer calculates the remaining mileage with the fuel available in the tank.

The calculation is based on the average fuel consumption over the last 30 km (20 miles) and the remaining drivable fuel quantity.

When the gauge shows "----", there is not enough fuel left to be able to calculate the remaining mileage. Refuel as soon as possible.

#### **i** NOTE

There may be a slight deviation if the driving style has been changed.

An economic driving style generally results in a longer driving distance.

### Distance to empty battery



The approximate distance that can be driven with the remaining amount of energy in the hybrid battery is indicated adjacent to this symbol.

The calculation is based on the average consumption of normally loaded vehicle, during normal driving and taking into account whether the air conditioning (AC) is switched on or off. When changing between the **Hybrid** and **Pure** drive modes, the calculated distance increases since

the **Pure** mode has reduced climate settings (ECO climate).

No guaranteed range on electric power remains when the gauge shows "----".

#### **i** NOTE

There may be a slight deviation if the driving style has been changed.

An economic driving style generally results in a longer driving distance.

### Start value for fully charged hybrid battery

Since it is difficult to anticipate driving style and other factors that affect the range for electric operation, Volvo has decided to use a start value when the car is fully charged. The start value indicates an up-to figure instead of a forecast for the range for electric operation. The difference in start value between **Hybrid** and **Pure** is due to the car being allowed to use more energy from the hybrid battery in **Pure** mode, as well as that the car changes over to ECO climate.

### Mileage for electric operation

In order to achieve the longest possible mileage for electric operation, the driver of an electrically powered car also has to think about energy conservation. The more consumers there are (stereo, electric heating in windows/mirrors/seats, very cold air from the climate control system, etc.) that are active - the shorter the potential mileage.

#### **i** NOTE

In addition to high current take-off in the passenger compartment, sudden acceleration and braking, high speed, heavy loads, low outside temperature and uphill gradients also reduce the possible driving distance.

### Tourist - alternative speedometer

The alternative digital speedometer makes it easier to drive in countries where speed limit signs are in a different unit than that shown in the car's instruments.

The digital speed is then shown in the opposite unit to that shown in the analogue speedometer. If the analogue speedometer is graduated in **mph**, the digital speedometer shows the corresponding speed in **km/h** and vice versa.

### Related information

- Show trip data in the driver display (p. 84)
- Resetting the trip meter (p. 85)
- Show trip statistics in the centre display (p. 85)
- Driver display (p. 77)
- Changing system units (p. 125)

## Show trip data in the driver display

The trip computer's recorded and calculated values can be shown in the driver display.

The values are saved in a trip computer app. Via the app menu, you can choose which information is shown on the driver display.

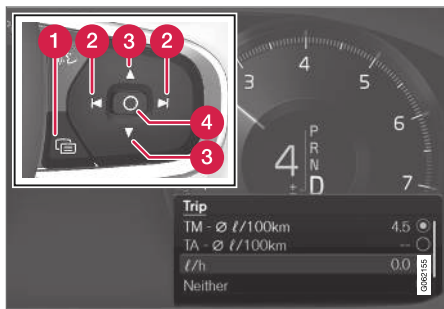

Open and navigate in the app menu<sup>2</sup> using the right-hand steering wheel keypad.

- 1 App menu
- 2 Left/right
- 3 Up/down
- 4 Confirm

1. Open the app menu in the driver display by pressing (1).  
(It is not possible to open the app menu while there is an unacknowledged message in the driver display. The message first has to be confirmed by pressing the **O** button (4) before the app menu can be opened.)
  2. Navigate to the trip computer app to left or right with (2).  
> The top four menu rows show measured values for trip meter TM. The next four menu rows show measured values for trip meter TA. Scroll up or down in the list with (3).
  3. Scroll down to the option buttons to select which information to show in the driver display:
    - Odometer
    - Distance to empty tank
    - Distance to empty battery
    - Tourist (alternative speedometer)
    - Mileage for trip meter TM, TA, or no display of mileage
    - Instantaneous fuel consumption, average consumption for TM or TA, alternatively, no display of fuel consumption
- Select or deselect an option with the **O** button (4). The change is made immediately.

## Related information

- Trip computer (p. 82)
- Resetting the trip meter (p. 85)

<sup>2</sup> The figure is schematic - parts may vary depending on car model.

## Resetting the trip meter

Reset the trip meter using the left-hand stalk switch.



- Reset all information in trip meter TM (i.e. mileage, average consumption, average speed and driving time) with a long press on the **RESET** button on the left-hand stalk switch.

A short press on the **RESET** button resets only the mileage.

The trip meter TA can only be reset automatically when the car has not been used for four or more hours.

### Related information

- Trip computer (p. 82)

<sup>3</sup> The figure is schematic - parts may vary depending on car model.

<sup>4</sup> Applicable to fuel-driven auxiliary heater.

## Show trip statistics in the centre display

Trip statistics from the trip computer are displayed graphically in the centre display and provide an overview that facilitates more fuel-efficient driving.

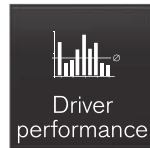

Open the **Driver performance** app in app view in order to show the trip statistics.

Each bar in the diagram symbolises a distance of 1, 10 or 100 km, alternatively miles. The

bars are filled in from the right as driving progresses. The bar on the far right shows the value for the current distance.

The average fuel consumption and total driving time are calculated since the last time the trip statistics were reset.

Fuel and electricity consumption are shown in separate graphs. Electricity consumption is "net" consumption, i.e. energy consumed minus regenerated energy created during braking.

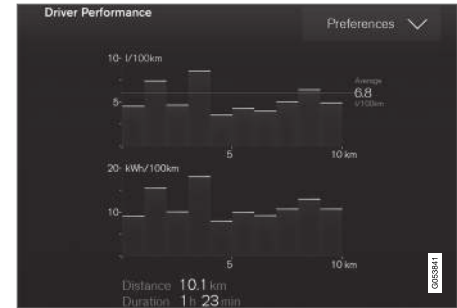

Trip statistics from the trip computer<sup>3</sup>.

### **i** NOTE

When driving with electric operation, fuel consumption can be indicated in the trip statistics if the additional heater<sup>4</sup> is running.

### Related information

- Settings for trip statistics (p. 86)
- Trip computer (p. 82)

## Settings for trip statistics

Reset or adjust settings for trip statistics.

1. Open the **Driver performance** app in app view in order to show the trip statistics.

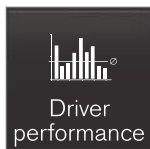

2. Press **Preferences** to

- change graph scale. Select resolution 1, 10 or 100 km/miles for the bar.
- reset data after every trip. Performed when the car has been stationary for more than 4 hours.
- reset data for the current trip.

Trip statistics, calculated average consumption and total driving time are always reset simultaneously.

Units for distance, speed, etc. can be changed via system settings in the centre display.

### Related information

- Show trip statistics in the centre display (p. 85)
- Trip computer (p. 82)
- Resetting the trip meter (p. 85)

## Date and time

The clock is shown in both the driver display and the centre display.

### Clock location



In certain situations, messages and information may cover the clock in the driver display.

In the centre display, the clock is located at the top right of the status bar.

### Date and time settings

- Select **Settings** → **System** → **Date and Time** in the centre display's top view to change settings for time and date format.

Adjust the date and time by pressing the up or down arrow on the touch screen.

### Automatic time for cars with GPS

When the car is equipped with a navigation system, **Auto Time** can be selected. The time zone

is then adjusted automatically based on the location of the car. For certain types of navigation systems, the current location (country) must also be set to obtain the right time zone. If **Auto Time** is not selected, time and data are adjusted with arrow up or arrow down on the touch screen.

### Summer time

In certain countries, it is possible to select the **Auto Daylight Saving Time** setting for automatic setting of summer time. For other countries, the **Daylight Saving Time** setting can be selected manually.

### Related information

- Driver display (p. 77)
- Other settings in the centre display's top view (p. 125)



## Outside temperature gauge

The outside temperature is shown in the driver display.

A sensor detects the temperature outside of the car.

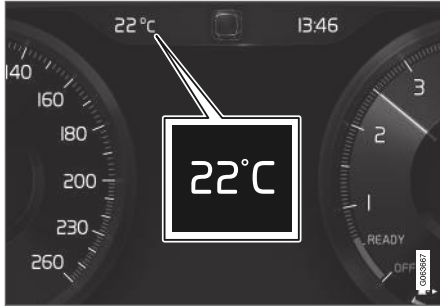

If the car has been stationary, the gauge may display a temperature reading that is too high.



When the outside temperature is in the range  $-5^{\circ}\text{C}$  to  $+2^{\circ}\text{C}$  ( $23^{\circ}\text{F}$  to  $36^{\circ}\text{F}$ ), a snowflake symbol lights up that warns of potentially slippery conditions.

The symbol is also illuminated briefly in the head-up display\*, if the car is equipped with one.



Change the unit for the temperature gauge, etc. via system settings in the centre display's top view.

## Related information

- Driver display (p. 77)
- Changing system units (p. 125)

## Indicator symbols in the driver display

The indicator symbols alert the driver that a function is activated, that a system is operating, or that a fault or abnormal condition has occurred.



Symbol	Specification
	<b>Information, read display text</b> When one of the car's systems does not behave as intended, this information symbol illuminates and a text appears on the driver display. The information symbol can also illuminate in conjunction with other symbols.
	<b>Fault in brake system</b> The symbol lights up when there is a fault in the parking brake.
	<b>ABS fault</b> If this symbol illuminates then the system is not working. The car's regular brake system continues to work, but without the ABS function.





Symbol	Specification
	<p><b>Automatic brake on</b></p> <p>The symbol illuminates when the function is activated and the foot brake or parking brake is acting. The brake holds the car stationary when it has stopped.</p>
	<p><b>Tyre pressure system</b></p> <p>The symbol illuminates when tyre pressure is too low. If there is a fault in the tyre pressure system, the symbol will flash for approx. 1 minute and then illuminate with a constant glow. This may be because the system cannot detect or warn of low tyre pressure as intended.</p>
	<p><b>Emissions system</b></p> <p>If the symbol illuminates after the engine has been started then it may be due to a fault in the car's emissions system. Drive to a workshop for checking. Volvo recommends that an authorised Volvo workshop is contacted.</p>

Symbol	Specification
	<p><b>Left and right-hand direction indicator</b></p> <p>The symbols flash when the direction indicators are used.</p>
	<p><b>Position lamps</b></p> <p>The symbol lights up when the position lamps are switched on.</p>
	<p><b>Fault in the headlamp system</b></p> <p>The symbol illuminates if a fault has occurred in the ABL function (Active Bending Lights) or if another fault has occurred in the headlamp system.</p>
	<p><b>Active main beam on</b></p> <p>The symbol lights up blue when the automatic main beam is on.</p>
	<p><b>Active main beam off</b></p> <p>The symbol lights up white when the automatic main beam is off.</p>

Symbol	Specification
	<p><b>Main beam On</b></p> <p>The symbol illuminates when main beam is on and with main beam flash.</p>
	<p><b>Active main beam on</b></p> <p>The symbol lights up blue when active main beam is on. Position lamps are switched on.</p>
	<p><b>Active main beam off</b></p> <p>The symbol lights up white when active main beam is off. Position lamps are switched on.</p>
	<p><b>Main beam On</b></p> <p>The symbol lights up when main beam and the position lamps are switched on.</p>
	<p><b>Rear fog lamp on</b></p> <p>This symbol illuminates when the rear fog lamp is switched on.</p>
	<p><b>Rain sensor on</b></p> <p>This symbol illuminates when the rain sensor is on.</p>

Symbol	Specification
	<b>Preconditioning on</b> The symbol illuminates when the engine block and passenger compartment heater/air conditioning are preconditioning the car.
	<b>Stability system</b> A flashing symbol indicates that the stability system is operating. If the symbol illuminates with constant glow then there is a fault in the system.
	<b>Stability system, sport mode</b> The symbol illuminates when the sport mode is activated. Sport mode allows for a more active driving experience.



Symbol	Specification
	<b>Lane assistance</b> White symbol: Lane assistance is on and road lines are detected. Grey symbol: Lane assistance is on but road lines are not detected. Amber symbol: Lane assistance warns/intervenes.
	<b>Lane assistance and rain sensor</b> White symbol: Lane assistance is on and road lines are detected. Rain sensor is on. Grey symbol: Lane assistance is on but road lines are not detected. Rain sensor is on.

**Related information**



- Driver display (p. 77)
- Warning symbols in the driver display (p. 89)



**Warning symbols in the driver display**

The warning symbols alert the driver that an important function is activated or that a serious fault or condition exists.

Symbol	Specification
	<b>Warning</b> The red warning symbol illuminates when a fault has been indicated which could affect the safety or drivability of the car. An explanatory text is shown on the driver display at the same time. The warning symbol can also illuminate in conjunction with other symbols.
	<b>Seatbelt reminder</b> This symbol illuminates or flashes if someone in a front seat has not put on their seatbelt or if someone in a rear seat has taken off their seatbelt.



Symbol	Specification
	<p><b>Airbags</b></p> <p>If the symbol remains illuminated or illuminates while driving, a fault has been detected in one of the car's safety systems. Read the message in the driver display. Volvo recommends that an authorised Volvo workshop is contacted.</p>
	<p><b>Fault in brake system</b></p> <p>If this symbol illuminates, the brake fluid level may be too low. Visit the nearest authorised workshop to have the brake fluid level checked and rectified.</p>
	<p><b>Parking brake applied</b></p> <p>This symbol illuminates with a constant glow when the parking brake is applied.</p> <p>A flashing symbol means that a fault has arisen. Read the message in the driver display.</p>

Symbol	Specification
	<p><b>Low oil pressure</b></p> <p>If this symbol illuminates during driving then the engine's oil pressure is too low. Stop the engine immediately and check the engine oil level, top up if necessary. If the symbol illuminates and the oil level is normal, contact a workshop. Volvo recommends that an authorised Volvo workshop is contacted.</p>
	<p><b>Alternator not charging</b></p> <p>This symbol illuminates during driving if a fault has occurred in the electrical system. Visit a workshop. Volvo recommends that an authorised Volvo workshop is contacted.</p>
	<p><b>Collision risk</b></p> <p>City Safety warns of a risk of collision with other vehicles, pedestrians, cyclists or large animals.</p>

**Related information**

- Indicator symbols in the driver display (p. 87)
- Driver display (p. 77)

**License agreement for the driver display**

A license is an agreement for the right to operate a certain activity or the right to use someone else's entitlement according to the terms and conditions in the agreement. The following text is Volvo's agreement with the manufacturer or developer.

**Boost Software License 1.0**

Permission is hereby granted, free of charge, to any person or organization obtaining a copy of the software and accompanying documentation covered by this license (the "Software") to use, reproduce, display, distribute, execute, and transmit the Software, and to prepare derivative works of the Software, and to permit third-parties to whom the Software is furnished to do so, all subject to the following: The copyright notices in the Software and this entire statement, including the above license grant, this restriction and the following disclaimer, must be included in all copies of the Software, in whole or in part, and all derivative works of the Software, unless such copies or derivative works are solely in the form of machine-executable object code generated by a source language processor.

THE SOFTWARE IS PROVIDED "AS IS", WITHOUT WARRANTY OF ANY KIND, EXPRESS OR IMPLIED, INCLUDING BUT NOT LIMITED TO THE WARRANTIES OF MERCHANTABILITY, FITNESS FOR A PARTICULAR PURPOSE, TITLE AND NON-INFRINGEMENT. IN NO EVENT SHALL THE COPYRIGHT HOLDERS OR ANYONE DISTRIBUTING THE SOFTWARE BE LIABLE FOR ANY DAMAGES OR OTHER LIABILITY, WHETHER IN CONTRACT, TORT OR OTHERWISE, ARISING FROM, OUT OF OR IN CONNECTION WITH THE SOFTWARE OR THE USE OR OTHER DEALINGS IN THE SOFTWARE.

**BSD 4-clause "Original" or "Old" License**

Copyright (c) 1982, 1986, 1990, 1991, 1993 The Regents of the University of California. All rights reserved.

Redistribution and use in source and binary forms, with or without modification, are permitted provided that the following conditions are met:

1. Redistributions of source code must retain the above copyright notice, this list of conditions and the following disclaimer.
2. Redistributions in binary form must reproduce the above copyright notice, this list of conditions and the following disclaimer in the documentation and/or other materials provided with the distribution.
3. All advertising materials mentioning features or use of this software must display the following acknowledgement: This product includes software developed by the University of California, Berkeley and its contributors.
4. Neither the name of the University nor the names of its contributors may be used to endorse or promote products derived from this software without specific prior written permission.

THIS SOFTWARE IS PROVIDED BY THE REGENTS AND CONTRIBUTORS "AS IS" AND ANY EXPRESS OR IMPLIED WARRANTIES, INCLUDING, BUT NOT LIMITED TO, THE IMPLIED WARRANTIES OF MERCHANTABILITY

AND FITNESS FOR A PARTICULAR PURPOSE ARE DISCLAIMED. IN NO EVENT SHALL THE REGENTS OR CONTRIBUTORS BE LIABLE FOR ANY DIRECT, INDIRECT, INCIDENTAL, SPECIAL, EXEMPLARY, OR CONSEQUENTIAL DAMAGES (INCLUDING, BUT NOT LIMITED TO, PROCUREMENT OF SUBSTITUTE GOODS OR SERVICES; LOSS OF USE, DATA, OR PROFITS; OR BUSINESS INTERRUPTION) HOWEVER CAUSED AND ON ANY THEORY OF LIABILITY, WHETHER IN CONTRACT, STRICT LIABILITY, OR TORT (INCLUDING NEGLIGENCE OR OTHERWISE) ARISING IN ANY WAY OUT OF THE USE OF THIS SOFTWARE, EVEN IF ADVISED OF THE POSSIBILITY OF SUCH DAMAGE.



◀◀ **BSD 3-clause "New" or "Revised" License**

Copyright (c) 2011-2014, Yann Collet.

Redistribution and use in source and binary forms, with or without modification, are permitted provided that the following conditions are met:

1. Redistributions of source code must retain the above copyright notice, this list of conditions and the following disclaimer.
2. Redistributions in binary form must reproduce the above copyright notice, this list of conditions and the following disclaimer in the documentation and/or other materials provided with the distribution.
3. Neither the name of the organisation nor the names of its contributors may be used to endorse or promote products derive from this software without specific prior written permission.

THIS SOFTWARE IS PROVIDED BY THE COPYRIGHT HOLDERS AND CONTRIBUTORS "AS IS" AND ANY EXPRESS OR IMPLIED WARRANTIES, INCLUDING, BUT NOT LIMITED TO, THE IMPLIED WARRANTIES OF MERCHANTABILITY AND FITNESS FOR A PARTICULAR PURPOSE ARE DISCLAIMED. IN NO EVENT SHALL THE COPYRIGHT HOLDER OR CONTRIBUTORS BE LIABLE FOR ANY DIRECT, INDIRECT, INCIDENTAL, SPECIAL, EXEMPLARY, OR CONSEQUENTIAL DAMAGES (INCLUDING, BUT NOT LIMITED TO, PROCUREMENT OF SUBSTITUTE GOODS OR

SERVICES; LOSS OF USE, DATA, OR PROFITS; OR BUSINESS INTERRUPTION) HOWEVER CAUSED AND ON ANY THEORY OF LIABILITY, WHETHER IN CONTRACT, STRICT LIABILITY, OR TORT (INCLUDING NEGLIGENCE OR OTHERWISE) ARISING IN ANY WAY OUT OF THE USE OF THIS SOFTWARE, EVEN IF ADVISED OF THE POSSIBILITY OF SUCH DAMAGE.

**BSD 2-clause "Simplified" license**

Copyright (c) <YEAR>, <OWNER> All rights reserved.

Redistribution and use in source and binary forms, with or without modification, are permitted provided that the following conditions are met:

1. Redistributions of source code must retain the above copyright notice, this list of conditions and the following disclaimer.
2. Redistributions in binary form must reproduce the above copyright notice, this list of conditions and the following disclaimer in the documentation and/or other materials provided with the distribution.

THIS SOFTWARE IS PROVIDED BY THE COPYRIGHT HOLDERS AND CONTRIBUTORS "AS IS" AND ANY EXPRESS OR IMPLIED WARRANTIES, INCLUDING, BUT NOT LIMITED TO, THE IMPLIED WARRANTIES OF MERCHANTABILITY AND FITNESS FOR A PARTICULAR PURPOSE ARE DISCLAIMED. IN NO EVENT SHALL THE COPYRIGHT OWNER

OR CONTRIBUTORS BE LIABLE FOR ANY DIRECT, INDIRECT, INCIDENTAL, SPECIAL, EXEMPLARY, OR CONSEQUENTIAL DAMAGES (INCLUDING, BUT NOT LIMITED TO, PROCUREMENT OF SUBSTITUTE GOODS OR SERVICES; LOSS OF USE, DATA, OR PROFITS; OR BUSINESS INTERRUPTION) HOWEVER CAUSED AND ON ANY THEORY OF LIABILITY, WHETHER IN CONTRACT, STRICT LIABILITY, OR TORT (INCLUDING NEGLIGENCE OR OTHERWISE) ARISING IN ANY WAY OUT OF THE USE OF THIS SOFTWARE, EVEN IF ADVISED OF THE POSSIBILITY OF SUCH DAMAGE.

The views and conclusions contained in the software and documentation are those of the authors and should not be interpreted as representing official policies, either expressed or implied, of the FreeBSD Project.

## FreeType Project License

1. Copyright 1996-1999 by David Turner, Robert Wilhelm, and Werner Lemberg  
Introduction The FreeType Project is distributed in several archive packages; some of them may contain, in addition to the FreeType font engine, various tools and contributions which rely on, or relate to, the FreeType Project. This license applies to all files found in such packages, and which do not fall under their own explicit license. The license affects thus the FreeType font engine, the test programs, documentation and makefiles, at the very least. This license was inspired by the BSD, Artistic, and IJG (Independent JPEG Group) licenses, which all encourage inclusion and use of free software in commercial and freeware products alike. As a consequence, its main points are that:
  - o We don't promise that this software works. However, we are interested in any kind of bug reports. ('as is' distribution)
  - o You can use this software for whatever you want, in parts or full form, without having to pay us. ('royalty-free' usage)
  - o You may not pretend that you wrote this software. If you use it, or only parts of it, in a program, you must acknowledge somewhere in your documentation that you've used the FreeType code. ('credits')
 We specifically permit and encourage the inclusion of this software, with or without modifications, in commercial products,

provided that all warranty or liability claims are assumed by the product vendor. Legal Terms 0. Definitions Throughout this license, the terms 'package', 'FreeType Project', and 'FreeType archive' refer to the set of files originally distributed by the authors (David Turner, Robert Wilhelm, and Werner Lemberg) as the 'FreeType project', be they named as alpha, beta or final release. 'You' refers to the licensee, or person using the project, where 'using' is a generic term including compiling the project's source code as well as linking it to form a 'program' or 'executable'. This program is referred to as 'a program using the FreeType engine'. This license applies to all files distributed in the original FreeType archive, including all source code, binaries and documentation, unless otherwise stated in the file in its original, unmodified form as distributed in the original archive. If you are unsure whether or not a particular file is covered by this license, you must contact us to verify this. The FreeType project is copyright (C) 1996-1999 by David Turner, Robert Wilhelm, and Werner Lemberg. All rights reserved except as specified below.

1. No Warranty THE FREETYPE ARCHIVE IS PROVIDED 'AS IS' WITHOUT WARRANTY OF ANY KIND, EITHER EXPRESSED OR IMPLIED, INCLUDING, BUT NOT LIMITED TO, WARRANTIES OF MERCHANTABILITY AND FITNESS FOR A PARTICULAR PURPOSE.

IN NO EVENT WILL ANY OF THE AUTHORS OR COPYRIGHT HOLDERS BE LIABLE FOR ANY DAMAGES CAUSED BY THE USE OR THE INABILITY TO USE, OF THE FREETYPE PROJECT. As you have not signed this license, you are not required to accept it. However, as the FreeType project is copyrighted material, only this license, or another one contracted with the authors, grants you the right to use, distribute, and modify it. Therefore, by using, distributing, or modifying the FreeType project, you indicate that you understand and accept all the terms of this license.

2. Redistribution Redistribution and use in source and binary forms, with or without modification, are permitted provided that the following conditions are met:
  - o Redistribution of source code must retain this license file ('licence.txt') unaltered; any additions, deletions or changes to the original files must be clearly indicated in accompanying documentation. The copyright notices of the unaltered, original files must be preserved in all copies of source files.
  - o Redistribution in binary form must provide a disclaimer that states that the software is based in part of the work of the FreeType Team, in the distribution documentation. We also encourage you to put an URL to the FreeType web page in your documentation, though this isn't mandatory. These conditions apply to any software derived from or based



- ◀ on the FreeType code, not just the unmodified files. If you use our work, you must acknowledge us. However, no fee need be paid to us.
3. Advertising The names of FreeType's authors and contributors may not be used to endorse or promote products derived from this software without specific prior written permission. We suggest, but do not require, that you use one or more of the following phrases to refer to this software in your documentation or advertising materials: 'FreeType Project', 'FreeType Engine', 'FreeType library', or 'FreeType Distribution'.
  4. Contacts There are two mailing lists related to FreeType:
    - o [freetype@freetype.org](mailto:freetype@freetype.org) Discusses general use and applications of FreeType, as well as future and wanted additions to the library and distribution. If you are looking for support, start in this list if you haven't found anything to help you in the documentation. o [devel@freetype.org](mailto:devel@freetype.org) Discusses bugs, as well as engine internals, design issues, specific licenses, porting, etc. o <http://www.freetype.org> Holds the current FreeType web page, which will allow you to download our latest development version and read online documentation. You can also contact us individually at: David Turner <[david.turner@freetype.org](mailto:david.turner@freetype.org)> Robert Wilhelm <[robert.wilhelm@freetype.org](mailto:robert.wilhelm@freetype.org)> Werner Lemberg <[werner.lemberg@freetype.org](mailto:werner.lemberg@freetype.org)>

### Libpng License

This copy of the libpng notices is provided for your convenience. In case of any discrepancy between this copy and the notices in the file `png.h` that is included in the libpng distribution, the latter shall prevail.

#### COPYRIGHT NOTICE, DISCLAIMER, and LICENSE:

If you modify libpng you may insert additional notices immediately following this sentence.

libpng versions 1.0.7, July 1, 2000, through 1.0.13, April 15, 2002, are Copyright (c) 2000-2002 Glenn Randers-Pehrson and are distributed according to the same disclaimer and license as libpng-1.0.6 with the following individuals added to the list of Contributing Authors

Simon-Pierre Cadieux

Eric S. Raymond

Gilles Vollant

and with the following additions to the disclaimer:

There is no warranty against interference with your enjoyment of the library or against infringement. There is no warranty that our efforts or the library will fulfill any of your particular purposes or needs. This library is provided with all faults, and the entire risk of satisfactory quality, performance, accuracy, and effort is with the user.

libpng versions 0.97, January 1998, through 1.0.6, March 20, 2000, are Copyright (c) 1998, 1999 Glenn Randers-Pehrson, and are distributed according to the same disclaimer and license as libpng-0.96, with the following individuals added to the list of Contributing Authors:

Tom Lane

Glenn Randers-Pehrson

Willem van Schaik

libpng versions 0.89, June 1996, through 0.96, May 1997, are Copyright (c) 1996, 1997 Andreas Dilger Distributed according to the same disclaimer and license as libpng-0.88, with the following individuals added to the list of Contributing Authors:

John Bowler

Kevin Bracey

Sam Bushell

Magnus Holmgren

Greg Roelofs

Tom Tanner

libpng versions 0.5, May 1995, through 0.88, January 1996, are Copyright (c) 1995, 1996 Guy Eric Schalnat, Group 42, Inc.



For the purposes of this copyright and license, "Contributing Authors" is defined as the following set of individuals:

Andreas Dilger

Dave Martindale

Guy Eric Schalnat

Paul Schmidt

Tim Wegner

The PNG Reference Library is supplied "AS IS". The Contributing Authors and Group 42, Inc. disclaim all warranties, expressed or implied, including, without limitation, the warranties of merchantability and of fitness for any purpose. The Contributing Authors and Group 42, Inc. assume no liability for direct, indirect, incidental, special, exemplary, or consequential damages, which may result from the use of the PNG Reference Library, even if advised of the possibility of such damage.

Permission is hereby granted to use, copy, modify, and distribute this source code, or portions hereof, for any purpose, without fee, subject to the following restrictions:

1. The origin of this source code must not be misrepresented.
2. Altered versions must be plainly marked as such and must not be misrepresented as being the original source.

3. This Copyright notice may not be removed or altered from any source or altered source distribution.

The Contributing Authors and Group 42, Inc. specifically permit, without fee, and encourage the use of this source code as a component to supporting the PNG file format in commercial products. If you use this source code in a product, acknowledgment is not required but would be appreciated.

A "png\_get\_copyright" function is available, for convenient use in "about" boxes and the like:

```
printf("%s",png_get_copyright(NULL));
```

Also, the PNG logo (in PNG format, of course) is supplied in the files "pngbar.png" and "pngbar.jpg (88x31) and "pngnow.png" (98x31).

Libpng is OSI Certified Open Source Software. OSI Certified Open Source is a certification mark of the Open Source Initiative.

Glenn Randers-Pehrson randeg@alum.rpi.edu  
April 15, 2002

### MIT License

Copyright (c) <year> <copyright holders>

Permission is hereby granted, free of charge, to any person obtaining a copy of this software and associated documentation files (the "Software"), to deal in the Software without restriction, including without limitation the rights to use, copy, modify, merge, publish, distribute,

sublicense, and/or sell copies of the Software, and to permit persons to whom the Software is furnished to do so, subject to the following conditions:

The above copyright notice and this permission notice shall be included in all copies or substantial portions of the Software.

THE SOFTWARE IS PROVIDED "AS IS", WITHOUT WARRANTY OF ANY KIND, EXPRESS OR IMPLIED, INCLUDING BUT NOT LIMITED TO THE WARRANTIES OF MERCHANTABILITY, FITNESS FOR A PARTICULAR PURPOSE AND NONINFRINGEMENT. IN NO EVENT SHALL THE AUTHORS OR COPYRIGHT HOLDERS BE LIABLE FOR ANY CLAIM, DAMAGES OR OTHER LIABILITY, WHETHER IN AN ACTION OF CONTRACT, TORT OR OTHERWISE, ARISING FROM, OUT OF OR IN CONNECTION WITH THE SOFTWARE OR THE USE OR OTHER DEALINGS IN THE SOFTWARE.

### « **zlib License**

The zlib/libpng License Copyright (c) <year>  
<copyright holders>

This software is provided 'as-is', without any express or implied warranty. In no event will the authors be held liable for any damages arising from the use of this software.

Permission is granted to anyone to use this software for any purpose, including commercial applications, and to alter it and redistribute it freely, subject to the following restrictions:

1. The origin of this software must not be misrepresented; you must not claim that you wrote the original software. If you use this software in a product, an acknowledgment in the product documentation would be appreciated but is not required.
2. Altered source versions must be plainly marked as such, and must not be misrepresented as being the original software.
3. This notice may not be removed or altered from any source distribution.

### **SGI Free Software B License Version 2.0.**

SGI FREE SOFTWARE LICENSE B (Version 2.0, Sept. 18, 2008)

Copyright (C) [dates of first publication] Silicon Graphics, Inc. All Rights Reserved. Permission is hereby granted, free of charge, to any person obtaining a copy of this software and associated

documentation files (the "Software"), to deal in the Software without restriction, including without limitation the rights to use, copy, modify, merge, publish, distribute, sublicense, and/or sell copies of the Software, and to permit persons to whom the Software is furnished to do so, subject to the following conditions: The above copyright notice including the dates of first publication and either this permission notice or a reference to <http://oss.sgi.com/projects/FreeB/> shall be included in all copies or substantial portions of the Software.

THE SOFTWARE IS PROVIDED "AS IS", WITHOUT WARRANTY OF ANY KIND, EXPRESS OR IMPLIED, INCLUDING BUT NOT LIMITED TO THE WARRANTIES OF MERCHANTABILITY, FITNESS FOR A PARTICULAR PURPOSE AND NONINFRINGEMENT. IN NO EVENT SHALL SILICON GRAPHICS, INC. BE LIABLE FOR ANY CLAIM, DAMAGES OR OTHER LIABILITY, WHETHER IN AN ACTION OF CONTRACT, TORT OR OTHERWISE, ARISING FROM, OUT OF OR IN CONNECTION WITH THE SOFTWARE OR THE USE OR OTHER DEALINGS IN THE SOFTWARE.

Except as contained in this notice, the name of Silicon Graphics, Inc. shall not be used in advertising or otherwise to promote the sale, use or other dealings in this Software without prior written authorization from Silicon Graphics, Inc.

### **Related information**

- Driver display (p. 77)

### **Application menu in driver display**

Application menu (app menu) in the driver display provides quick access to commonly used functions for certain apps.



The figure is schematic.

The app menu in the driver display can be used instead of the centre display and is controlled using the right-hand keypad on the steering wheel. The app menu makes it easier to switch between different apps or functions within the apps without having to let go of the steering wheel.

### **App menu functions**

Different apps give access to different types of functions. The following apps and their associated functions can be controlled from the app menu:

App	Functions
Trip computer	Selection of trip meter, selection of what to show in the driver display, etc.
Media player	Selection of active source for the media player.
Phone	Calling a contact from the call list.
Navigation	Guide to destination, etc.

### Related information

- Driver display (p. 77)
- Overview of centre display (p. 102)
- Handling the application menu in the driver display (p. 97)

## Handling the application menu in the driver display

The application menu (the app menu) in the driver display is operated with the steering wheel's right-hand keypad.

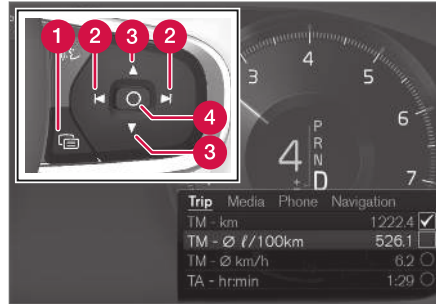

The app menu and the steering wheel's right-hand keypad.

- 1 Open/close
- 2 Left/right
- 3 Up/down
- 4 Confirm

## Opening/closing the app menu

- Press on open/close (1).
  - > The app menu opens/closes.

### NOTE

It is not possible to open the app menu while there is an unacknowledged message in the driver display. The message has to be confirmed first before the app menu can be opened.

The app menu closes automatically after a period of inactivity or after certain options have been selected.

## Navigating and selecting in the app menu

1. Navigate between the apps by pressing on the left or right (2).
  - > Functions for previous/next app are shown in the app menu.
2. Browse through the functions for the selected app by tapping on up or down (3).
3. Confirm or highlight an option for the function by pressing on confirm (4).
  - > The function is activated and for some options the app menu then closes.

If the app menu is opened again, the functions of the most recently selected app are shown first.

◀◀ **Related information**

- Application menu in driver display (p. 96)
- Messages in the driver display (p. 98)

### **Messages in the driver display**

The driver display can show messages to inform or assist the driver in the event of different events.

for acknowledging the message or accepting a request, for example.



Examples of messages in the driver display.

The driver display shows messages that are of high priority for the driver.

Messages can be shown in different parts of the driver display depending on what other information is currently being displayed. After a while, or when the message has been acknowledged/ action taken if required, the message disappears from the driver display. If a message needs to be saved, it is placed in the **Car Status** app, which is opened from the app view in the centre display.

Message composition may vary and they can be shown together with graphics, symbols or buttons

**Service messages**

Shown below is a selection of important service messages and their meanings.

Message	Specification
<b>Stop safely<sup>A</sup></b>	Stop and switch off the engine. Serious risk of damage - consult a workshop <sup>B</sup> .
<b>Turn off engine<sup>A</sup></b>	Stop and switch off the engine. Serious risk of damage - consult a workshop <sup>B</sup> .
<b>Service urgent Drive to workshop<sup>A</sup></b>	Contact a workshop <sup>B</sup> to check the car immediately.
<b>Service required<sup>A</sup></b>	Contact a workshop <sup>B</sup> to check the car as soon as possible.
<b>Regular maintenance Book time for maintenance</b>	Time for regular service - contact a workshop <sup>B</sup> . Shown before the next service date.
<b>Regular maintenance Time for maintenance</b>	Time for regular service - contact a workshop <sup>B</sup> . Shown at the next service date.

Message	Specification
<b>Regular maintenance Maintenance overdue</b>	Time for regular service - contact a workshop <sup>B</sup> . Shown when the service date has passed.
<b>Temporarily off<sup>A</sup></b>	A function has been temporarily switched off and is reset automatically while driving or after starting again.

<sup>A</sup> Part of message, shown together with information on where the problem has arisen.

<sup>B</sup> An authorised Volvo workshop is recommended.

**Related information**

- Managing messages in the driver display (p. 99)
- Handling a message saved from the driver display (p. 100)
- Message in centre display (p. 133)

**Managing messages in the driver display**

Messages in the driver display are handled using the steering wheel's right-hand keypad.



Examples of messages in the driver display and the steering wheel's right-hand keypad.

- ❶ Left/right
- ❷ Confirm

Some messages in the driver display contain one or more buttons for acknowledging the message or accepting a request, for example.

## ◀◀ Managing a new message

For messages with buttons:

1. Navigate between the buttons by pressing on the left or right (1).
2. Confirm the selection by pressing on confirm (2).
  - > The message disappears from the driver display.

For messages without buttons:

- Close the message by pressing on confirm (2), or allow the message to close automatically after a while.
  - > The message disappears from the driver display.

If a message needs to be saved, it is placed in the **Car Status** app, which is opened from the app view in the centre display. The message **Car message stored in Car Status application** is shown in the centre display in conjunction with this.

### Related information

- Messages in the driver display (p. 98)
- Handling a message saved from the driver display (p. 100)
- Message in centre display (p. 133)

## Handling a message saved from the driver display

Whether saved from the driver display or the centre display, messages are managed in the centre display.

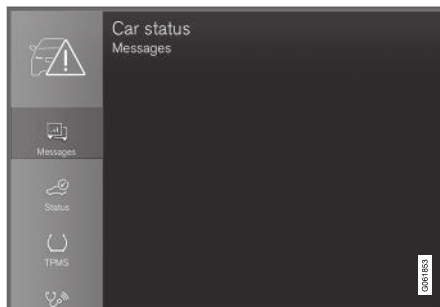

Saved messages can be seen in the **Car Status** app.

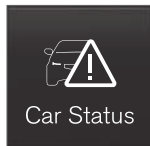

Messages that are shown in the driver display and that need to be saved are added in the **Car Status** app in the centre display. The message **Car message stored in Car Status application** is shown

in the centre display in conjunction with this.

## Reading a saved message

To read a saved message immediately:

- Press the button to the right of the **Car message stored in Car Status application** message in the centre display.
  - > The saved message is shown in the **Car Status** app.

To read a saved message later:

1. Open the **Car Status** app from the app view in the centre display.
  - > The app is opened in the bottom tile of the home view.
2. Select the **Messages** tab in the app.
  - > A list of saved messages is shown.
3. Tap on a message to expand/minimise.
  - > More information on the message is shown in the list and the image to the left in the app shows information about the message graphically.

### Managing a saved message

In maximised mode, some messages have two buttons available to book service or read the owner's manual.

To book service for a saved message:

- In maximised mode for the message, press **Request appoint./Call to make Appointment**<sup>5</sup> for help in booking service.
  - > With **Request appoint.:** The **Appointments** tab opens in the app and creates a request to book service and repair work.
  - With **Call to make Appointment:** The phone app is initiated and calls a service centre to book service and repair work.

To read the owner's manual for a saved message:

- In maximised mode for the message, press **Owner's manual** to read about the message in the owner's manual.
  - > The owner's manual opens in the centre display and shows information linked to the message.

Saved messages in the app are deleted automatically each time the engine is started.

### Related information

- Messages in the driver display (p. 98)
- Managing messages in the driver display (p. 99)
- Message in centre display (p. 133)

---

<sup>5</sup> Market dependent. Volvo ID and selected workshop also need to be registered.

### **Overview of centre display**

Many of the car's functions are controlled from the centre display. Presented here is the centre display and its options.



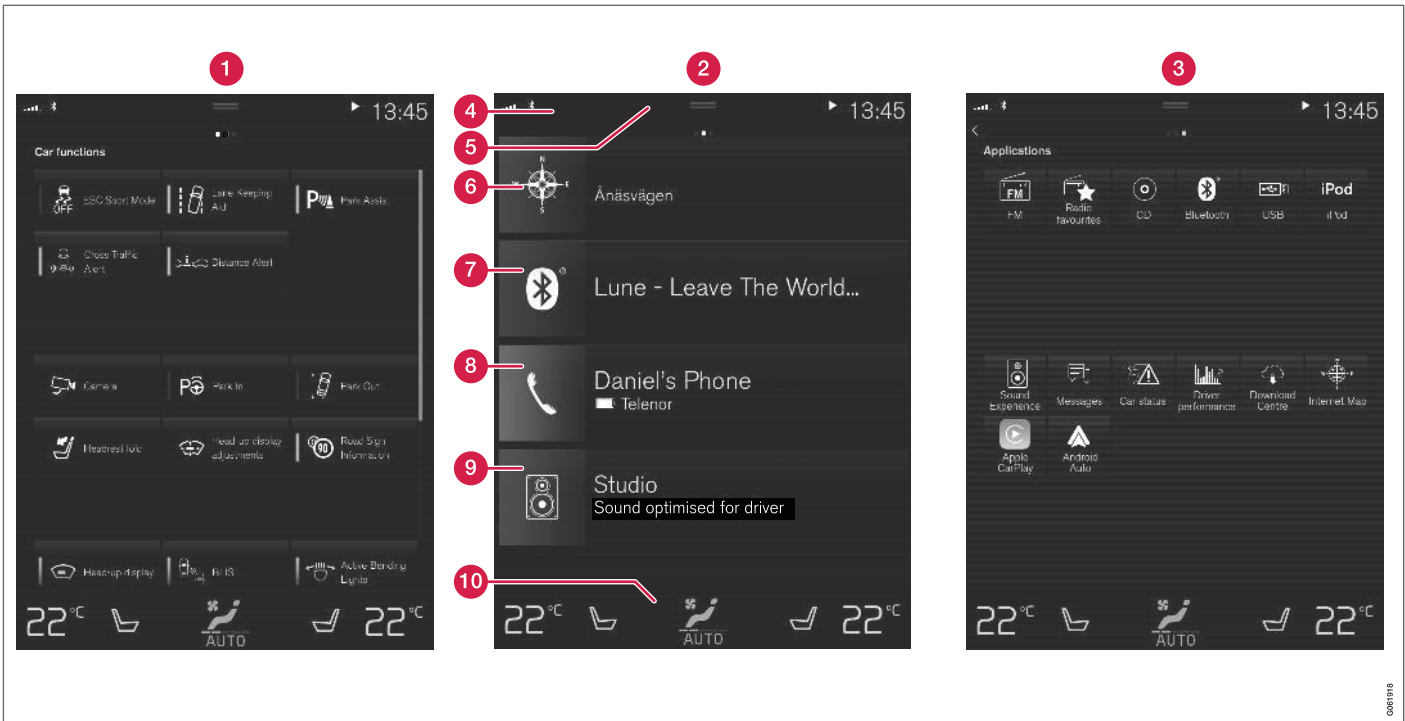

Three of the centre display's basic views. Swipe right or left to access the function or app view respectively<sup>6</sup>.

**1** Function view - car functions that are activated or deactivated with a press. Certain

functions are also so-called trigger functions, which means they open a window with set-

ting options. Examples of these include **Camera**. Settings for the head-up display\*

<sup>6</sup> The views are reversed for right-hand drive cars.





are also made from the function view, but adjustments are made using the steering wheel's right-hand keypad.

- 2 Home view - the first view that is shown when the screen is started.
- 3 Application view (app view) - apps that have been downloaded (third-party apps) and apps for embedded functions, such as **FM radio**. Tap on an app icon to open the app.
- 4 Status bar - the activities in the car are shown right at the top of the screen. Network and connection information is shown on the left-hand side of the status bar, while media-related information, the clock and indication about on-going background activity are shown on the right.
- 5 Top view - drag the tab down in order to access the top view. **Settings**, **Owner's manual**, **Profile** and the car's saved messages are accessed from here. In some cases contextual settings (e.g. **Navigation Settings**) and the contextual owner's manual (e.g. **Navigation Manual**) can also be accessed in the top view.
- 6 Navigation - leads to map navigation, with e.g. Sensus Navigation\*. Tap on the subview to expand it.
- 7 Media - recently used apps associated with media. Tap on the subview to expand it.
- 8 Phone - the phone function can be reached from here. Tap on the subview to expand it.

- 9 Extra subview - recently used apps or car functions that do not belong in any of the other subviews. Tap on the subview to expand it.
- 10 Climate row - information and direct interaction to set temperature and seat heating for example\*. Tap on the symbol in the centre of the climate row in order to open the climate view with more setting options.

### Related information

- Managing the centre display (p. 105)
- Navigating in the centre display's views (p. 108)
- Function view in centre display (p. 115)
- Apps (p. 488)
- Symbols in the centre display's status bar (p. 117)
- Other settings in the centre display's top view (p. 125)
- Open contextual setup in the centre display (p. 126)
- Owner's manual in centre display (p. 17)
- Media player (p. 497)
- Phone (p. 512)
- Climate controls (p. 207)
- Switching off and changing the volume of the system sound in the centre display (p. 124)

- Changing the appearance in the centre display (p. 124)
- Changing system language (p. 125)
- Changing system units (p. 125)
- Cleaning the centre display (p. 625)
- Message in centre display (p. 133)

## Managing the centre display

Many of the car's functions are controlled and regulated from the centre display. The centre display is a touch screen that reacts to touch.

### Using the touch screen functionality in the centre display

The screen reacts differently depending on whether you press, drag or swipe across it. Actions such as browsing between different views, marking objects, scrolling in a list and mov-

ing apps can be performed by touching the screen in different ways.



An infrared light curtain just above the surface of the screen enables the screen to detect a finger that is just in front of the screen. This technology makes it possible to use the screen even with gloves on.

Two people can interact with the screen at the same time, e.g. to adjust the climate for the driver and passenger side respectively.





### IMPORTANT

Do not use sharp objects on the screen as they may scratch it.

The table below presents the different procedures for operating the screen:

Procedure	Execution	Result
	Press once.	Highlights an object, confirms a selection or activates a function.
	Press twice in quick succession.	Zooms in on a digital object, such as the map.
	Press and hold.	Grabs an object. Can be used to move apps or map points on the map. Press and hold your finger against the screen and at the same time drag the object to the desired location.
	Tap once with two fingers.	Zooms out from a digital object, such as the map.



Procedure	Execution	Result
	<p>Drag</p>	<p>Changes between different views, scrolls a list, text or view. Hold depressed and drag in order to move apps or map points on the map. Drag horizontally or vertically across the screen.</p>
	<p>Swipe/drag quickly</p>	<p>Changes between different views, scrolls a list, text or view. Drag horizontally or vertically across the screen. Note that touching the upper section of the screen may cause the top view to open.</p>
	<p>Drag apart</p>	<p>Zooms in.</p>
	<p>Drag together</p>	<p>Zooms out.</p>

### Returning to home view from another view

1. Briefly press the home button below the centre display.
  - > The last position of the home view is shown.
2. Briefly press again.
  - > All subviews of the home view are set to their default mode.

#### **i** NOTE

In home view standard mode - briefly press the home button. An animation that describes access to the different views is shown on the screen.

### Scrolling in a list, article or view

When a scroll indicator is visible in the screen, it is possible to scroll downward or upward in the view. Swipe downwards/upwards anywhere in the view.

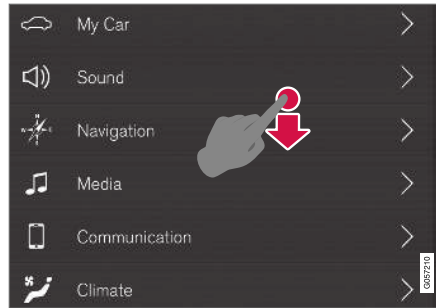

The scroll indicator appears in the centre display when it is possible to scroll in the view.

### Using the controls in the centre display



Temperature control.

The control is used for many of the car's functions. Regulate e.g. temperature by means of one of the following:

- drag the control to the desired temperature,
- tap on + or – in order to raise or lower the temperature gradually, or
- tap on the desired temperature on the control.

### Related information

- Activating and deactivating centre display (p. 108)
- Moving apps and buttons in centre display (p. 117)
- Keyboard in centre display (p. 119)

## Activating and deactivating centre display

The centre display can be dimmed and reactivated using the home button beneath the screen.



Home button for the centre display.

The effect of using the home button that the screen dims and the touchscreen no longer reacts to touch. The climate row will still be shown. All functions connected to the screen are still running, such as climate, audio, guidance\* and apps. When the centre display is dimmed, it is a good opportunity to clean the screen. The dimming function can also be used to fade the screen so that it does not disturb while driving.

1. Give a long press on the physical home button below the screen.
  - > The screen goes dark except for the climate row, which continues to be shown. All functions connected to the screen are still running.
2. Reactivate the screen - briefly tap on the home button.
  - > The view that was displayed before the screen was switched off will be shown again.

### **i** NOTE

The screen cannot be deactivated when a prompt to perform an action is shown on the screen.

### **i** NOTE

The centre display deactivates automatically when the engine is off and the driver's door is opened.

### Related information

- Cleaning the centre display (p. 625)
- Changing the appearance in the centre display (p. 124)
- Overview of centre display (p. 102)

## Navigating in the centre display's views

There are five different basic views in the centre display: home view, top view, climate view, application view (app view) and function view. The screen is started automatically when the driver's door is opened.

### Home view

Home view is the view that is shown when the screen is started. It consists of four subviews: **Navigation**, **Media**, **Phone** and an extra subview.

An app or car function selected from the app or function view starts in the respective subview of the home view. E.g. **FM radio** starts in the **Media** tile.

The extra tile shows the last used app or car function that is not associated with any of the other three areas.

The subviews show brief information about each different app.

### **i** NOTE

When the car is started, the home view's various sub-views show information on the current status of apps.

**i NOTE**

In home view standard mode - briefly press the home button. An animation that describes access to the different views is shown on the screen.

**Status bar**

The activities in the car are shown at the top of the screen. Network and connection information is shown on the left-hand side of the status bar, while media-related information, the clock and indication that background activity is in progress are shown on the right.

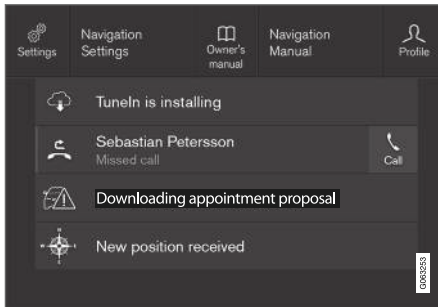
**Top view**

Top view dragged down.

A tab is located in the centre of the status bar at the top of the screen. Open the top view by

pressing on the tab or by dragging/swiping from the top downwards across the screen.

In the top view, access is always available to:

- **Settings**
- **Owner's manual**
- **Profile**
- The car's saved messages.

In the top view, access is given to the following in some cases:

- Contextual setting (e.g. **Navigation Settings**). Change settings directly in the top view when an app (e.g. navigation) is running.
- Contextual Owner's Manual (e.g. **Navigation Manual**). Gain access directly in the top view to articles in the digital owner's manual that are related to the content displayed on screen.

Exit the top view - press outside the top view, on the home button or at the bottom of the top view and drag upward. The underlying view is then visible and available for use again.

**i NOTE**

The top view is not available during starting/shutdown or when a message is shown on the screen. It is also not available when climate view is shown.

**Climate view**

The climate row is always visible at the bottom of the screen. The most common climate settings can be made directly there, such as setting temperature and seat heating\*.



Press the symbol in the centre of the climate row to open the climate view and gain access to more climate settings.



Press the symbol to close the climate view and return to the previous view.

## Application view



Application view with the car's apps.

Swipe from right to left<sup>7</sup> across the screen in order to access the application view (app view) from the home view. Apps that have been downloaded (third-party apps) and apps for embedded functions, such as **FM radio**, are found here. Certain apps show brief information directly in the

app view, such as the number of unread text messages for **Messages**.

Tap on an app to open it. The app then opens in the tile to which it belongs, e.g. **Media**.

You can scroll down in the app view, depending on the number of apps. Do this by swiping/dragging from the bottom and up.

Go back to the home view again by swiping from left to right<sup>7</sup> across the screen, or by pressing the home button.

## Function view

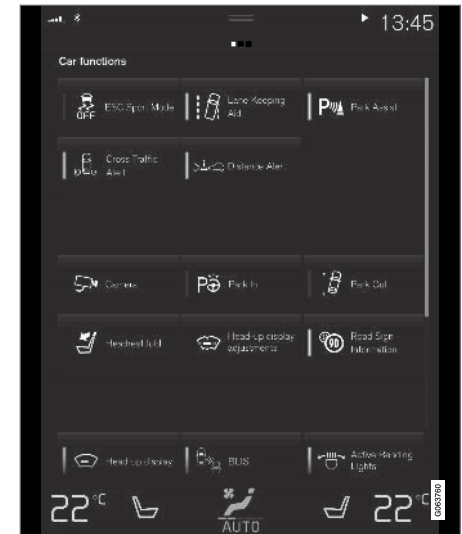

The function view with buttons for different car functions.

Swipe from left to right<sup>7</sup> across the screen in order to access the function view from the home view. From here you can activate or deactivate different car functions, e.g. **BLIS\***, **Lane Keeping Aid\*** and **Park Assist\***.

<sup>7</sup> Applies to left-hand drive cars. For right-hand drive cars - swipe in the opposite direction.



Depending on the amount of functions, it is also possible here to scroll downward in the view. Do this by swiping/dragging from the bottom and up.

Unlike in app view, where an app is opened with a press, a function is activated or deactivated by pressing the relevant function button. Some functions (trigger functions) open in a new window when pressed.

Go back to the home view again by swiping from right to left<sup>7</sup> across the screen, or by pressing the home button.

### Related information

- Managing subviews in centre display (p. 112)
- Symbols in the centre display's status bar (p. 117)
- Other settings in the centre display's top view (p. 125)
- Open contextual setup in the centre display (p. 126)
- Owner's manual in centre display (p. 17)
- Driver profiles (p. 129)
- Climate controls (p. 207)
- Apps (p. 488)
- Function view in centre display (p. 115)
- Overview of centre display (p. 102)

---

<sup>7</sup> Applies to left-hand drive cars. For right-hand drive cars - swipe in the opposite direction.

## **Managing subviews in centre display**

Home view consists of four subviews:

**Navigation, Media, Phone** and an extra subview. These views can be expanded.

## Expanding a subview from default mode



Standard mode and expanded mode of a subview in the centre display.

### ◀ Expanding a subview:

- For tiles **Navigation, Media** and **Phone**: Press anywhere on the subview. When a tile is expanded, the extra tile in the home view is temporarily forced away. The other two tiles are minimised and only certain information is shown. When the extra tile is tapped, the other three tiles are minimised and only certain information is displayed.

The expanded view provides access to the basic functions of the app.

### Closing an expanded subview:

- The subview can be closed in three different ways.
  - Tap on the upper part of the expanded subview.
  - Tap on another tile (this tile will then open in expanded mode instead).
  - Briefly press the physical home button below the centre display.

### Opening or closing a subview in full screen mode

The extra tile<sup>8</sup> and the tile for **Navigation** can be opened out in full screen mode, with even more information and more setting options.

When a new subview is opened in full-screen mode, no information from the other subviews is shown.



In expanded mode, open the app in full screen - press on the symbol.



Press on the symbol to go back to the expanded mode, or press the home button at the bottom of the screen.



Home button for the centre display.

There is always the option to go back to home view by pressing the home button. To go back to the home view's standard view from full screen mode – press twice on the home button.

### Related information

- Managing the centre display (p. 105)
- Activating and deactivating centre display (p. 108)
- Navigating in the centre display's views (p. 108)

<sup>8</sup> Does not apply to all apps or car functions opened via the extra tile.

## Function view in centre display

All the buttons for car functions are located in the function view, one of the centre display's basic views. Navigate to the function view from

home view by swiping from left to right across the screen<sup>9</sup>.

## Different types of buttons

There are three different types of buttons for car functions; see below:

Type of button	Property	Affects car function
Function buttons	<p>Have on/off positions.</p> <p>When a function is running, an LED indicator illuminates to the left of the icon for the button.</p> <p>Press the button to activate/deactivate a function.</p>	<p>Most buttons in function view are function buttons.</p>
Trigger buttons	<p>Do not have on/off positions.</p> <p>When a trigger button is depressed, a window for the function is opened. For example, it may be a window to change seat position.</p>	<ul style="list-style-type: none"> <li>● <b>Camera</b></li> <li>● <b>Headrest Fold</b></li> <li>● <b>Head-up Display Adjustments</b></li> </ul>
Parking buttons	<p>Have on, off and scan modes.</p> <p>Similar to the function buttons but with an extra position for parking scanning.</p>	<ul style="list-style-type: none"> <li>● <b>Park In</b></li> <li>● <b>Park Out</b></li> </ul>

<sup>9</sup> Applies to left-hand drive cars. For right-hand drive cars - swipe in the opposite direction.

## ◀ The buttons' different modes

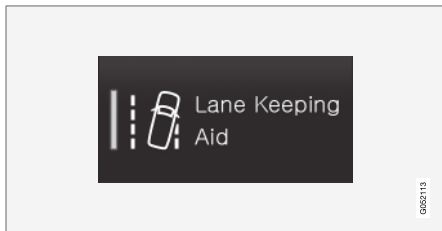

When the LED indicator illuminates in green on a function or parking button, the function is activated. When a function is activated, extra text with an explanation for certain functions is shown. The text is shown for a few seconds and then the button is shown with the LED indicator illuminated.

For **Lane Keeping Aid**, the text **Works only at certain speeds** is shown, for example, when the button is depressed.

Press the button once briefly to activate or deactivate the function.

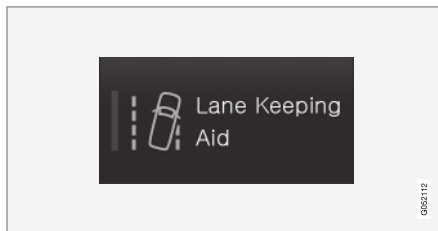

The function is deactivated when the LED indicator is extinguished.

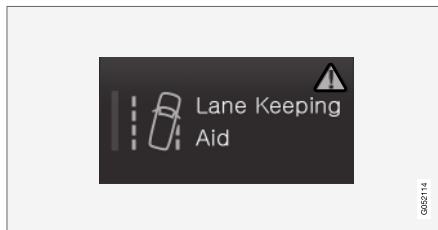

When a warning triangle is shown in the right-hand section of the button there is something not working as intended.

### Related information

- Managing the centre display (p. 105)
- Navigating in the centre display's views (p. 108)

## Moving apps and buttons in centre display

The apps and buttons for car functions in the app view and function view respectively can be moved and organised as desired.

1. Swipe from right to left<sup>10</sup> to access the app view, or swipe from left to right<sup>10</sup> to access the function view.
2. Tap on an app or button and hold it down.
  - > The app or button changes size and becomes slightly transparent. It is then possible to move it.
3. Drag the app or button to a vacant space in the view.

The maximum number of rows available for use in order to position apps or buttons is 48. To move an app or button outside the visible view, drag it to the bottom of the view. New rows are then added, where the app or button can be located.

An app or button can thus be located further down and is then not visible in the normal mode for the view.

Swipe across the screen to scroll up or down in the view.

### NOTE

Hide the apps that you rarely or never use by moving them to the bottom, off the visible screen. This way it will be easier to find the apps you use more often.

### NOTE

Apps and car function buttons cannot be added to locations that are already occupied.









### Related information

- Function view in centre display (p. 115)
- Apps (p. 488)
- Managing the centre display (p. 105)

## Symbols in the centre display's status bar







Overview of the symbols that can be shown in the centre display's status bar.

The status bar shows activities in progress and, in some cases, their status. Not all symbols are shown all the time due to the limited space in the status bar.

Symbol	Specification
	Connected to the Internet.
	Roaming activated.
	Signal strength in mobile phone network.
	Bluetooth device connected.
	Bluetooth activated but no device connected.
	Information sent to and from GPS.
	Connected to Wi-Fi network.
	Tethering activated (Wi-Fi hotspot). The car then shares the available connection.

<sup>10</sup> Applies to left-hand drive cars. For right-hand drive cars - swipe in the opposite direction.



Symbol	Specification
	Car modem activated.
	USB sharing active.
	Process in progress.
	Timer for preconditioning active.
	Audio source being played back.
	Audio source stopped.
	Phone call in progress.
	Audio source muted.
	News is received from the radio channel.
	Traffic information is received.
	Clock.

- Connecting a device via USB port (p. 504)
- Phone (p. 512)
- Date and time (p. 86)

**Related information**

- Navigating in the centre display's views (p. 108)
- Message in centre display (p. 133)
- Internet-connected car\* (p. 521)



## **Keyboard in centre display**

The centre display keyboard makes it possible to make entries using keys. It is also possible to "draw in" letters and characters on the screen by hand.

The keyboard can be used to enter characters, letters and numbers, e.g. to write text messages from the car, enter passwords or search for articles in the digital owner's manual.

The keyboard is only shown when entries can be made on the screen.

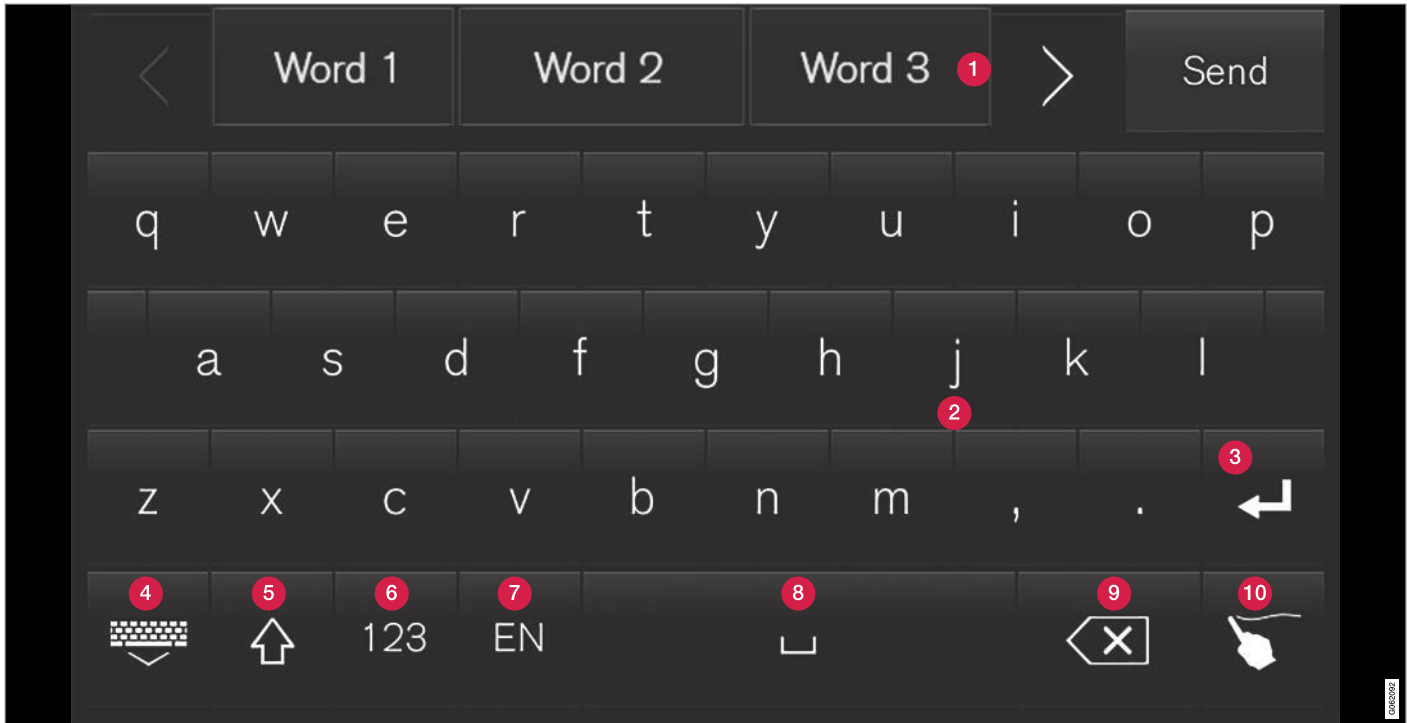

The image shows an overview of some of the buttons which may be shown in the keyboard. The appearance varies depending on language settings and the context in which the keyboard is being used.

- 1 Row of suggested words or characters<sup>11</sup>. The suggested words are adjusted as new letters are being entered. Browse among the suggestions by pressing on the right and left arrows. Tap on a suggestion to select it. Note that this function is not supported by all language selections. If not available, the row will not be shown on the keyboard.
- 2 The characters available on the keyboard depend on which language was selected (see point 7). Tap on a character to enter it.
- 3 The button works in different ways, depending on the context in which the keyboard is used - either to enter @ (when an email address is entered) or to **create a new row** (for normal text input).
- 4 Hides the keyboard. If this is not possible, the button is not shown.
- 5 Used to enter capital letters. Press again to enter one capital letter and then continue with lower-case letters. Another press makes all letters capital letters. The next press restores the keyboard to lower-case letters. In this mode, the first letter after a full stop, exclamation mark or question mark is a capital letter. The first letter in the text field is also a capital letter. In text fields intended for names or addresses, each word automatically starts with a capital letter. In text fields for password, web address or email address

entry, all letters are automatically lower case unless otherwise set with the button.

- 6 Number entry. The keyboard (2) is then shown with numbers. Press ABC, which in number mode is shown instead of 123, to return to the letter keyboard, or #\~ to open the keyboard with special characters.
- 7 Changes text input language, e.g. EN. The available characters and word suggestions (1) vary depending on the selected language. To make it possible to change languages for the keyboard, the languages must first be added under Settings.
- 8 Space.
- 9 Undoes entered text. Pressing briefly deletes one character at a time. Hold the button depressed to delete characters more quickly.
- 10 Changes keyboard mode to write letters and characters by hand instead.

Pressing the confirmation button above the keypad (not visible in the illustration) confirms the entered text. The appearance of the button differs depending on context.

## Variants of a letter or character



Variants of a letter or character, e.g. **é** or **è**, can be entered by holding down the letter or character. A box is displayed showing possible variants of letters or characters. Press the required variant. If no variant is selected, the original letter/character is entered.

## Related information

- Changing keyboard language in centre display (p. 122)
- Enter the characters, letters and words manually in the centre display (p. 122)
- Managing the centre display (p. 105)
- Managing text messages (p. 518)

<sup>11</sup> Applies to Asiatic languages.

## Changing keyboard language in centre display

To make it possible to switch between different languages for the keyboard, the languages must first be added under **Settings**.

### Adding or deleting languages in settings

The keyboard is automatically set to the same languages as the system language. The keyboard language can be manually adapted without affecting the system language.

1. Press **Settings** in the top view.
2. Press **System** → **System Languages and Units** → **Keyboard Layouts**.
3. Select one or more languages from the list.
  - > It is now possible to switch between the selected languages directly from the keyboard for text input.

If no languages have been actively selected under **Settings**, the keyboard retains the same language as the car's system language.

## Switching between different languages in the keyboard



When a number of languages have been selected in **Settings**, the button in the keyboard is used to switch between the different languages.

To change keyboard language with list:

1. Give a long press on the button.
  - > A list opens.
2. Select the required language. If more than four languages have been selected under **Settings**, it is possible to scroll in the list from the keyboard.
  - > The keyboard is adapted to the selected language and other word suggestions are given.

To change the keyboard language without displaying the list:

- One short press of the button.
  - > The keyboard is adapted to the next language in the list without displaying the list.

### Related information

- Changing system language (p. 125)
- Keyboard in centre display (p. 119)

## Enter the characters, letters and words manually in the centre display

The centre display keyboard allows you to enter characters, letters and words on the screen by "drawing" by hand.



Press the button on the keyboard to change from typing with the keys to entering letters and characters by hand.

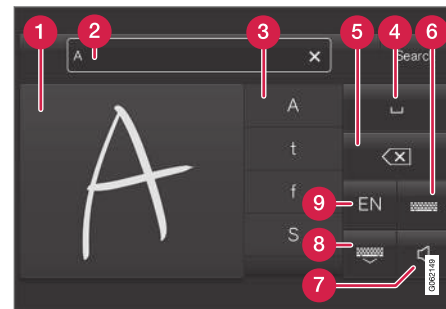

- 1 Area for writing characters/letters/words/ parts of word.
- 2 The text field where the characters or word suggestions<sup>12</sup> appear as they are written on screen (1).

<sup>12</sup> Applies to certain system languages.

- 3 Suggestions for characters/letters/word/ part of word. It is possible to scroll through the list.
- 4 Space. A space can also be created by entering a dash (-) in the area for hand-written letters (1). See the heading "Entering a space in the free text field with handwriting recognition" below.
- 5 Undo entered text. Press briefly to delete one character/one letter at a time. Wait a moment before pressing again to delete the next character/letter, etc.
- 6 Return to the keyboard with regular character input.
- 7 Switch off/on sound when entering.
- 8 Hide the keyboard. If this is not possible, the button is not shown.
- 9 Change text input language.

### Writing characters/letters/words by hand

1. Write a character, a letter, a word or parts of a word in the area for hand-written letters (1). Write a word or parts of a word above each other or on a line.
  - > A number of suggested characters, letters or words is shown (3). The most likely choice is found at the top of the list.

#### **!** IMPORTANT

Do not use sharp objects on the screen as they may scratch it.

2. Enter the character/letters/word by waiting a moment.
  - > The character/letter/word at the top of the list is entered. It is also possible to select a different character by pressing the required character, letter or word in the list.

### Deleting/changing characters/letters written by hand

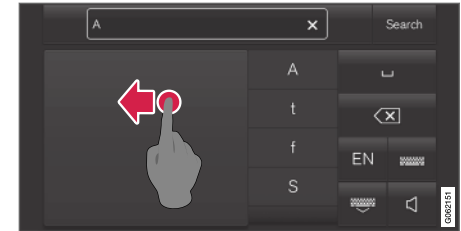

Delete all characters in the text field (2) by swiping across the handwriting field (1).

- There are several options for deleting/ changing characters/letters:
  - Press the intended letter or word in the list (3).
  - Press the text undo button (5) to delete the letter and begin again.
  - Swipe horizontally from right to left<sup>13</sup> over the area for handwritten letters (1). Delete multiple letters by swiping over the area several times.
  - Pressing the X in the text field (2) deletes all of the entered text.

<sup>13</sup> For Arabic keyboard - swipe in the opposite direction. Swiping from right to left creates a space.

#### ◀ Changing row in the free text field with handwriting

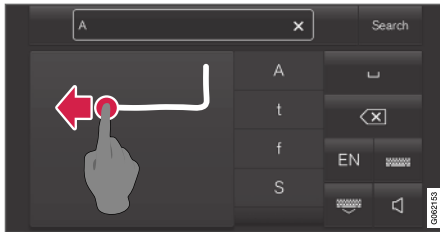

Change row by hand by drawing the above character in the handwriting field<sup>14</sup>.

#### Entering a space in the free text field with handwriting recognition

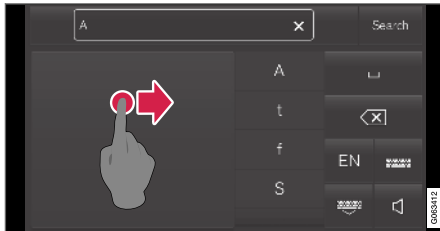

Enter a space by drawing a dash from left to right<sup>15</sup>.

#### Related information

- Keyboard in centre display (p. 119)

#### Changing the appearance in the centre display

The appearance of the screen in the centre display can be changed by selecting a theme.

1. Press **Settings** in the top view.
2. Press **My Car** → **Displays** → **Display Themes**.
3. Then select a theme, e.g. **Minimalistic** or **Chrome Rings**.

As a supplement to these appearances, it is possible to choose between **Normal** and **Bright**. With **Normal**, the screen background is dark and the text is light. This alternative is the default for all themes. A light variant can also be selected, in which the background is light and the text is dark. This alternative can be useful in e.g. strong daylight.

This alternative is always available for the user and is not affected by the surrounding lighting.

#### Related information

- Other settings in the centre display's top view (p. 125)
- Activating and deactivating centre display (p. 108)
- Cleaning the centre display (p. 625)

#### Switching off and changing the volume of the system sound in the centre display

The centre display can be used to change the volume of the system sound or switch off the system sound altogether.

1. Press **Settings** in the top view in the centre display.
2. Press **Sound** → **System Volumes**.
3. Under **Touch Sounds**, drag the control to change the volume/switch off screen touch sounds. Drag the control to the desired volume.

#### Related information

- Overview of centre display (p. 102)
- Other settings in the centre display's top view (p. 125)
- Audio settings (p. 486)

<sup>14</sup> For Arabic keyboards - draw the same character, but reversed.

<sup>15</sup> For Arabic keyboard - draw the dash from right to left.

## Changing system units

Units settings are defined in the centre display's **Settings** menu.

1. Press **Settings** in the top view in the centre display.
2. Continue to **System** → **System Languages and Units** → **Units of Measurement**.
3. Select a unit standard:
  - **Metric** - kilometres, litres and degrees Celsius.
  - **Imperial** - miles, gallons and degrees Celsius.
  - **US** - miles, gallons and degrees Fahrenheit.

> The units in the driver display, centre display and head-up display are changed.

### Related information

- Overview of centre display (p. 102)
- Other settings in the centre display's top view (p. 125)
- Changing system language (p. 125)

## Changing system language

Language settings are defined in the centre display menu **Settings**.

### NOTE

Changing the language in the centre display may mean that some owner's information is not compliant with national or local laws and regulations. Do not switch to a language that is difficult to understand as this may make it difficult to find your way back through the screen structure.

1. Press **Settings** in the top view in the centre display.
2. Continue to **System** → **System Languages and Units**.
3. Select **System Language**. Languages that support voice recognition have a voice recognition symbol.
  - > The language in the driver display, centre display and head-up display is changed.

### Related information

- Overview of centre display (p. 102)
- Other settings in the centre display's top view (p. 125)
- Changing system units (p. 125)

## Other settings in the centre display's top view

You can change settings and information for many of the car's functions via the centre display.

1. Open the top view by pressing on the tab at the top or by dragging/swiping from the top downwards across the screen.
2. Press **Settings** to open the settings menu.

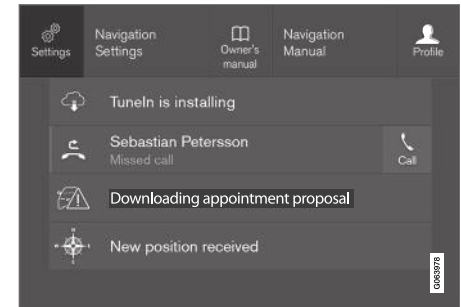

Top view with button for **Settings**.

3. Press on one of the categories and the sub-categories to navigate to the required setting.
4. Change one or more settings. Different types of setting are changed in different ways.
  - > The changes are saved immediately.

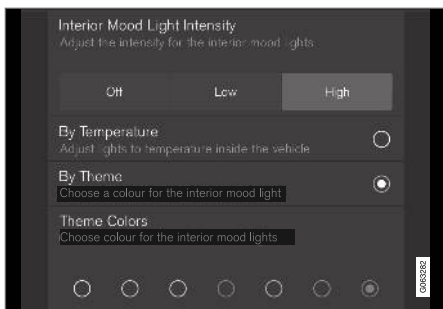

A subcategory in the settings menu with different types of settings (here, a multi-selector button and radio buttons).

### Related information

- Overview of centre display (p. 102)
- Resetting settings in the centre display (p. 127)
- Table showing centre display settings (p. 128)

## Open contextual setup in the centre display

It is possible to use contextual setup for most of the car's basic apps so that you can change settings directly in the top view in the centre display.

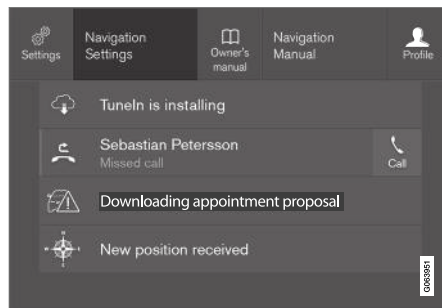

Top view with button for contextual setting.

Contextual setting is a shortcut for accessing a specific setting relating to the active function shown on screen. The apps installed in the car from the beginning, e.g. **FM radio** and **USB**, are a part of Sensus and are part of the car's embedded functions. The settings for these apps can be changed directly via contextual setting in the top view.

When contextual setup is available:

1. Drag down top view when an app is in expanded mode, e.g. **Navigation**.

2. Press **Navigation Settings**.
  - > A navigation settings page opens.
3. Change settings as desired and confirm the selections.

Press **Close** or the physical home button beneath the centre display to close setup view.

Most of the car's basic apps have this contextual setting option, but not all.

### Third party apps

Third party apps are not included in the car's system from the beginning, but are the type that can be downloaded e.g. **Volvo ID**. Here the settings are always made inside the app and not from the top view.

### Related information

- Other settings in the centre display's top view (p. 125)
- Overview of centre display (p. 102)
- Resetting settings in the centre display (p. 127)
- Downloading apps (p. 489)



## Resetting user data for change of ownership

In the event of a change of ownership, user data and system settings should be restored to factory settings.

The settings in the car can be reset at different levels. Restore all user data and system settings to the original factory settings in the event of a change of ownership. In the event of a change of ownership it is also important to change the owner of the Volvo On Call\* service.

### Related information

- Resetting settings in the centre display (p. 127)
- Resetting settings in the driver profiles (p. 133)

## Resetting settings in the centre display

It is possible to reset the defaults for all settings defined in the centre display settings menu.

### Two types of reset

There are two different types of resets for settings in the settings menu:

- **Factory reset** - clears all data and files and resets all settings to their default values.
- **Reset Personal Settings** - clears personal data and resets personal settings to their default values.

### Resetting settings

Follow these instructions to reset your settings.

#### NOTE

**Factory reset** is only possible when the car is stationary.

1. Press **Settings** in the top view in the centre display.
2. Continue to **System** → **Factory reset**.
3. Select the required reset type.
  - > A pop-up window is shown.

4. Press **OK** to confirm the reset.

For **Reset Personal Settings**, the reset must be confirmed by pressing **Reset for the active profile** or **Reset for all profiles**.

> Selected settings are reset.

### Related information

- Overview of centre display (p. 102)
- Other settings in the centre display's top view (p. 125)
- Table showing centre display settings (p. 128)

## Table showing centre display settings

The settings menu in the centre display has a number of main categories and subcategories where settings and information for many of the car's functions are collected.

There are seven main categories: **My Car**, **Sound**, **Navigation**, **Media**, **Communication**, **Climate** and **System**.

In turn, each category contains a number of subcategories and setting options. The tables below show the first level of subcategories. The setting options for a function or area are described in more detail in the corresponding section of the owner's manual.

Some settings are personal, which means that they can be saved to **Driver Profiles**. Other settings are global, which means they are not linked to a driver profile.

### My Car

Subcategories
Displays
IntelliSafe
Drive Preferences/Individual Drive Mode*
Lights and Lighting
Mirrors and Convenience

Subcategories
Locking
Parking Brake and Suspension
Wipers

### Sound

Subcategories
Tone
Balance
System Volumes

### Navigation

Subcategories
Map
Route and Guidance
Traffic

### Media

Subcategories
AM/FM radio
DAB*
Gracenote®

Subcategories
TV*
Video

### Communication

Subcategories
Phone
Text Messages
Android Auto*
Apple CarPlay*
Bluetooth Devices
Wi-Fi
Car Wi-Fi Hotspot
Car Modem Internet*
Volvo On Call*
Volvo Service Networks

### Climate

The main category **Climate** has no subcategories.

## System

<b>Subcategories</b>
Driver Profile
Date and Time
System Languages and Units
Privacy and Data
Keyboard Layouts
Voice Control*
Factory reset
System Information

### Related information

- Overview of centre display (p. 102)
- Other settings in the centre display's top view (p. 125)
- Resetting settings in the centre display (p. 127)

## Driver profiles

Many of the settings made in the car can be adapted according to the driver's personal preferences and can be saved in one or more driver profiles.

The personal settings are automatically saved in the active driver profile. Each key can be linked to a driver profile. When the linked key is used, the car is adapted to the settings of that specific driver profile.

### What settings are saved in the driver profiles?

Many of the settings defined in the car will be saved automatically in the active driver profile unless the profile is protected. In the car, the settings defined are either personal or global. Only personal settings are saved in driver profiles.

Settings that can be saved in a driver profile include, amongst other things, screens, mirrors, front seats, navigation\*, audio and media system, language and voice control.

Some settings, referred to as global settings, can be changed but are not saved to a specific driver profile. Changes to global settings affect all profiles.

### Global settings

The global settings and parameters are not changed when changing between driver profiles.

They remain the same regardless of which driver profile is active.

Keyboard layout settings are an example of global settings. If driver profile X is used to add additional languages to the keyboard, these remain available for use even if driver profile Y is used. The keyboard layout settings are not saved to a specific driver profile - the settings are global.

### Personal preferences

If driver profile X was used to e.g. set centre display brightness, driver profile Y is not affected by this setting. It has been saved to driver profile X - the brightness setting is a personal setting.

### Related information

- Selecting driver profile (p. 130)
- Renaming a driver profile (p. 130)
- Linking remote control key to driver profile (p. 131)
- Protect driver profile (p. 131)
- Resetting settings in the driver profiles (p. 133)
- Table showing centre display settings (p. 128)

## Selecting driver profile

When the centre display has been started, the selected driver profile is shown at the top of the screen. The driver profile last used is the one that will be active next time the car is unlocked. It is possible to change to another driver profile after the car has been unlocked. However, if the remote control key has been linked to a driver profile then this is what is selected when the car is started.

There are two options for changing to another driver profile.

Option 1:

1. Tap on the name of the driver profile shown in the top of the centre display when the display has been started.
  - > A list of selectable driver profiles is shown.
2. Select the driver profile required.
3. Press **Confirm**.
  - > The driver profile is selected and the system loads the settings for the new driver profile.

Option 2:

1. Drag down the top view in the centre display.
2. Press **Profile**.
  - > The same list as for Option 1 is shown.
3. Select the driver profile required.

4. Press **Confirm**.
  - > The driver profile is selected and the system loads the settings for the new driver profile.

Option 3:

1. Drag down the top view in the centre display.
2. Press **Settings** in the top view in the centre display.
3. Press **System → Driver Profiles**.
  - > A list of selectable driver profiles is shown.
4. Select the driver profile required.
5. Press **Confirm**.
  - > The driver profile is selected and the system loads the settings for the new driver profile.

### Related information

- Driver profiles (p. 129)
- Navigating in the centre display's views (p. 108)
- Renaming a driver profile (p. 130)
- Linking remote control key to driver profile (p. 131)

## Renaming a driver profile

It is possible to change the name of the different driver profiles used in the car.

1. Press **Settings** in the top view in the centre display.
2. Press **System → Driver Profiles**.
3. Select **Edit Profile**.
  - > A menu opens, where the profile can be edited.
4. Tap in the box **Profile Name**.
  - > A keyboard appears, and it is possible to change the name. Tap on  to close the keyboard.
5. Save the name change by pressing **Back** or **Close**.
  - > The name has now been changed.

### NOTE

A profile name cannot start with a space, as the profile name will not then be saved.

### Related information

- Selecting driver profile (p. 130)
- Keyboard in centre display (p. 119)

## Protect driver profile

In some cases it is preferable not to save various settings defined in the car to the active driver profile. In this case, it is possible to protect the driver profile.

### NOTE

Protecting a driver profile is only possible when the car is stationary.

To protect a driver profile:

1. Press **Settings** in the top view in the centre display.
2. Press **System → Driver Profiles**.
3. Select **Edit Profile**.
  - > A menu opens, where the profile can be edited.
4. Select **Protect Profile** to protect the profile.

5. Save your profile protection option by pressing **Back/Close**.
  - > When the profile is protected, settings defined in the car will not be saved automatically to the profile. Instead, your changes must be saved manually under **Settings → System → Driver Profiles → Edit Profile** by pressing **Save current settings to the profile**. When the profile is unprotected, on the other hand, your settings will be saved automatically to the profile.

### Related information

- Driver profiles (p. 129)

## Linking remote control key to driver profile

It is possible to link your key to a driver profile. The driver profile along with all of its settings will then be automatically selected every time the car is used with that specific remote control key.

The first time the remote control key is used, it is not linked to any specific driver profile. When the car is started, the **Guest** profile will automatically be activated.

A driver profile can be selected manually without linking it to the key. When the car is unlocked, the last active driver profile is activated. Once the key has been linked to a driver profile, a driver profile does not need to be selected when that specific key is used.

## Linking a remote control key to a driver profile

### NOTE

Connecting a remote control key to a driver profile is only possible when the car is stationary.

First select the profile to be linked to the key, if the profile to be linked is not already active. The active profile can then be linked to the key.

1. Press **Settings** in the top view in the centre display.



2. Press **System** → **Driver Profiles**.
3. Select the desired profile. The display returns to the home view. The **Guest** profile cannot be linked to a key.
4. Drag down the top view again and tap on **Settings** → **System** → **Driver Profiles** → **Edit Profile**.

5. Select **Connect key** to link the profile with the key. It is not possible to link a driver profile to a different key than the one currently being used in the car. If there are multiple keys in the car, the message **More than one key is found, put the key you want to connect on backup reader** will be displayed.

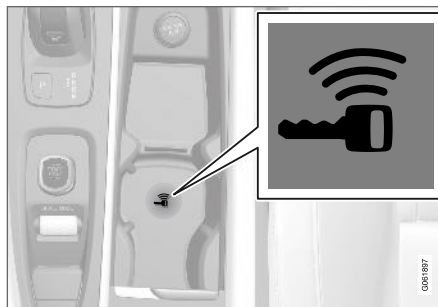

Backup reader's location in the tunnel console.

- > When the message **Profile connected to key** is shown, the key and the driver profile are linked.
6. Press **OK**.
    - > This key is now linked to the driver profile and will remain linked as long as the **Connect key** box is not unticked.

### Related information

- Driver profiles (p. 129)
- Renaming a driver profile (p. 130)
- Remote control key (p. 235)

## Resetting settings in the driver profiles

Settings that have been saved to one or more driver profiles can be reset if the car is stationary.

### **i** NOTE

**Factory reset** is only possible when the car is stationary.

1. Press **Settings** in the top view.
2. Press **System** → **Factory reset** → **Reset Personal Settings**.
3. Select one of the options **Reset for the active profile**, **Reset for all profiles** or **Cancel**.

### Related information

- Driver profiles (p. 129)
- Resetting settings in the centre display (p. 127)

## Message in centre display

The centre display can show messages to inform or assist the driver in the event of different events.

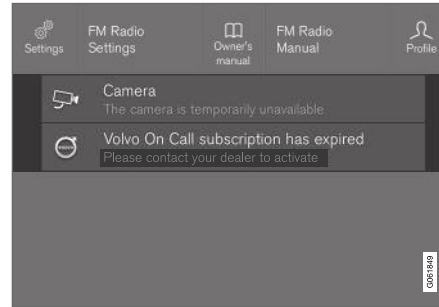

Example of a message in the centre display's top view.

The centre display shows messages that are of lower priority for the driver.

Most messages are shown above the centre display's status bar. After a while, or when any required action related to the message has been taken, the message disappears from the status bar. If a message needs to be saved, it is positioned in the top view in the centre display.

Message composition may vary and they can be shown together with graphics, symbols or a button for activating/deactivating a function linked to the message.

### Pop-up messages

In some cases, a message is shown in the form of a pop-up window. Pop-up messages have higher priority than messages shown in the status bar and require acknowledgement/action before they disappear.

### Related information

- Managing messages in the centre display (p. 134)
- Handling a message saved from the centre display (p. 134)
- Messages in the driver display (p. 98)

## Managing messages in the centre display

Messages in the centre display are handled in centre display views.

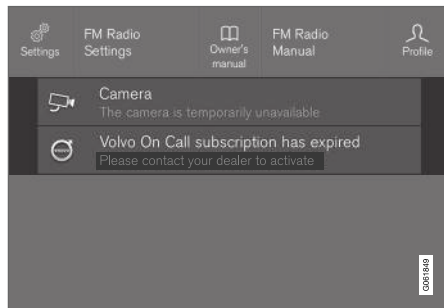

Example of a message in the centre display's top view.

Some messages in the centre display have a button (or several buttons in pop-up messages) for e.g. activating/deactivating a function linked to the message.

### Managing a new message

For messages with buttons:

- Press the button to perform the action or allow the message to close automatically after a while.
  - > The message disappears from the status bar.

For messages without buttons:

- Close the message by tapping on it, or allow the message to close automatically after a while.
  - > The message disappears from the status bar.

If a message needs to be saved, it is positioned in the top view in the centre display.

### Related information

- Message in centre display (p. 133)
- Handling a message saved from the centre display (p. 134)
- Messages in the driver display (p. 98)

## Handling a message saved from the centre display

Whether saved from the driver display or the centre display, messages are managed in the centre display.

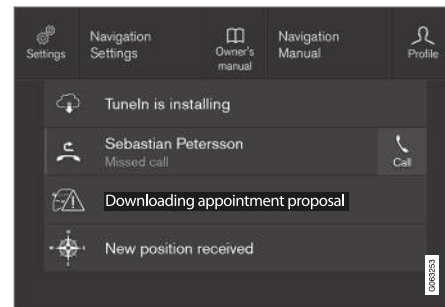

Examples of saved messages and possible options in the top view.

Messages that are shown in the centre display that need to be saved are added in the top view of the centre display.



### Reading a saved message

1. Open the top view in the centre display.
  - > A list of saved messages is shown. Messages with an arrow to the right can be maximised.
2. Tap on a message to expand/minimise.
  - > More information on the message is shown in the list and the image to the left in the app shows information about the message graphically.

### Managing a saved message

Some messages have a button for e.g. activating/deactivating a function linked to the message.

- Press the button to perform the action.

Saved messages in the top view are deleted automatically when the car is switched off.

### Related information

- Message in centre display (p. 133)
- Managing messages in the centre display (p. 134)
- Messages in the driver display (p. 98)

### Head-up display\*

The head-up display supplements the car's driver display and projects information from the driver display onto the windscreen. The projected image can only be seen from the driver position.



The head-up display shows warnings and information relating to speed, cruise control functions, navigation, etc. in the driver's field of vision. Road Sign Information and incoming phone calls can also be shown in the head up display.

### **i** NOTE

The driver's ability to see the information in the head-up display is impaired by the following

- use of polarising sunglasses
- a driving position which means that the driver is not sitting centred in the seat
- objects on the display unit's cover glass
- unfavourable light conditions.

### **i** IMPORTANT

The display unit from which the information is projected is located in the instrument panel. To avoid damage to the display unit's cover glass - do not store any objects on the cover glass and make sure that no objects fall down onto it.

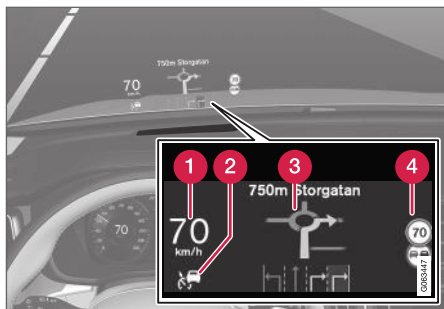

Examples of what can be shown in the display.

- 1 Speed
- 2 Cruise control
- 3 Navigation
- 4 Road signs

A number of symbols can be shown temporarily in the head-up display, e.g.:



If the warning symbol illuminates - read the warning message in the driver display.



If the information symbol illuminates - read the message in the driver display.



The snowflake symbol illuminates in the event of a risk of icy conditions.

**NOTE**

Certain visual defects may cause headaches and a feeling of stress during the use of the head-up display.

**City Safety in the head-up display**

In the event of a collision warning, the information in the head-up display is replaced by the warning symbol for City Safety. This graphic is illuminated even if the head-up display is switched off.

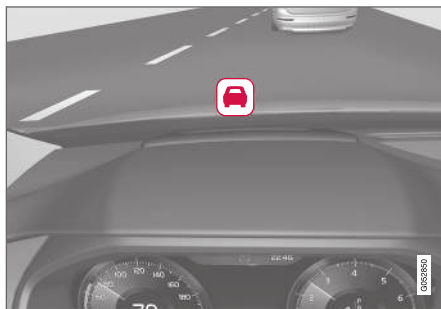

The warning symbol for City Safety flashes in order to attract the driver's attention if there is a risk of collision.

**Related information**

- Activating and deactivating the head-up display\* (p. 137)
- Cleaning the head up display\* (p. 626)
- Head up display when replacing the wind-screen\* (p. 598)

## Activating and deactivating the head-up display\*

The head-up display can be activated and deactivated when the car has been started.



Press the **Head-up Display** button in the centre display function view. An indicator in the button illuminates when the function is activated.

### Related information

- Settings for head-up display\* (p. 137)
- Head-up display\* (p. 135)

## Settings for head-up display\*

Adjust the settings for the head-up display's projection onto the windscreen.

Settings can be defined when the car has been started and a projected image is shown on the windscreen.

### Selecting display options

Select which functions are to be shown in the head-up display.

1. Tap on **Settings** in the centre display's top view.
2. Press **My Car** → **Displays** → **Head-Up Display Options**.
3. Select one or more functions:
  - **Show Navigation**
  - **Show Road Sign Information**
  - **Show Driver Support**
  - **Show Phone**

The setting is saved as a personal setting in the driver profile.

## Adjusting brightness and vertical position



1. Press the **Head-up Display Adjustments** button in the centre display function view.
2. Adjust the brightness and vertical position of the projected image in the driver's field of vision using the steering wheel's right-hand keypad.

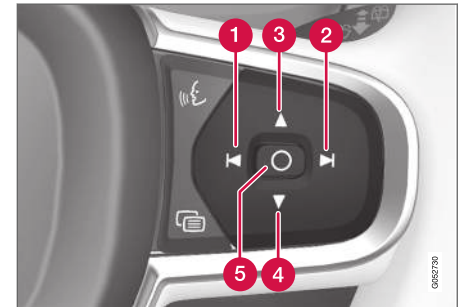

- 1 Reducing the brightness
- 2 Increasing the brightness
- 3 Raising the position



◀◀ **4** Lowering the position

**5** Confirm

The brightness of the graphics is automatically adapted to their background light conditions. The brightness is also affected by the adjustment of the brightness in the car's other displays.

The height position can be stored in the memory function for the power\* front seat using the keypad in the driver's door.

### Calibrate the horizontal position

The head-up display's horizontal position may need to be calibrated if the windscreen or display unit is replaced. Calibration means that the projected image is rotated clockwise or anticlockwise.

1. Tap on **Settings** in the centre display's top view.
2. Select **My Car → Displays → Head-Up Display Options → Head-Up Display Calibration**.
3. Calibrate the image's horizontal position with the steering wheel's right keypad.

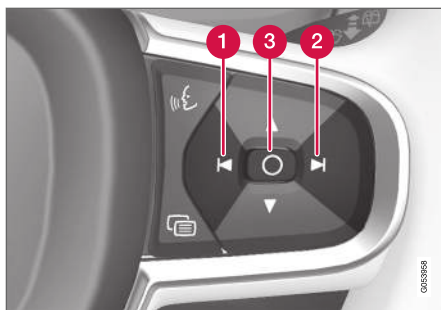

**1** Rotate anticlockwise

**2** Rotate clockwise

**3** Confirm

### Related information

- Head-up display\* (p. 135)
- Activating and deactivating the head-up display\* (p. 137)
- Driver profiles (p. 129)
- Storing position for seat, door mirrors and head-up display\* (p. 180)

### Voice recognition<sup>16</sup>

The driver can use voice recognition to control certain functions in the media player, Bluetooth-connected phone, climate system and Volvo's navigation system\*.

Voice commands offer additional convenience and assist the driver to not be distracted so that he or she can concentrate on driving, the road and the traffic situation.

**⚠ WARNING**

The driver always holds overall responsibility for driving the vehicle in a safe manner and complying with all applicable rules of the road.

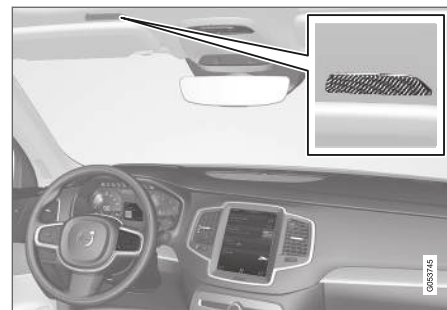

Voice control system microphone

<sup>16</sup> Applies to certain markets.

Voice control is done in dialogue form with the user saying commands and receiving verbal responses from the system. The voice recognition system uses the same microphone as Bluetooth-connected devices, and the voice recognition system's responses are given via the car's speakers. In some cases, a text message is also shown in the driver display. Functions are controlled from the right-hand steering wheel keypad. Settings are made via the centre display.

### System updating

The voice recognition system is continuously improved. Download updates for optimal performance from support.volvocars.com.

### Related information

- Using voice recognition (p. 139)
- Controlling a telephone with voice recognition (p. 140)
- Voice control of radio and media (p. 141)
- Controlling climate control with voice recognition (p. 197)
- Settings for voice recognition (p. 142)

## Using voice recognition<sup>17</sup>





Depress the steering wheel button for voice recognition  to activate the system and initiate a dialogue using voice commands.

Remember the following:

- Speak after the tone with a normal voice at a normal tempo.
- Do not speak while the system is replying (the system cannot understand commands during this time).
- Avoid background noise in the passenger compartment by having the doors, windows and panoramic roof\* closed.

Voice recognition can be deactivated as follows:

- briefly press  and say "**Cancel**".
- a long press on the steering wheel button for voice control  until you hear two beeps.

To speed up communication and skip the prompts from the system, press the steering wheel button for voice recognition  when the system voice is speaking and say the next command.

To change the system audio volume, turn the rotary volume knob when the voice speaks. It is possible to use other buttons during voice control. However, other sounds will be silenced during dialogue with the system, which means that it is not possible to execute any functions linked with audio using the buttons.

### Example of voice recognition control

Press , say "Call [Forename] [Surname] [number category]" - dials the selected contact from the phone book. If the contact has several phone numbers (e.g. home, mobile, work), the right category must be referred to.

So press  and say "Call Robin Smith Mobile".

### Commands/phrases

The following commands can generally be used, regardless of the situation:

- "**Repeat**" - repeats the last voice instruction in the ongoing dialogue.
- "**Cancel**" - discontinue the dialogue.
- "**Help**" - starts a help dialogue. The system replies with the commands available in the current situation, a prompt or an example.

Commands for specific functions such as phone and radio are described in specific sections.

<sup>17</sup> Applies to certain markets.

### ◀ Digits

The number commands are stated differently depending on the function to be controlled:

- **Phone numbers and postcodes** must be spoken individually, number by number, e.g. zero three one two two four four three (03122443).
- **House numbers** can be spoken individually or in groups, e.g. two two or twenty-two (22). For English and Dutch, several groups can be said in sequence, e.g. twenty-two twenty-two (22 22). For English, double or triple can be used, e.g. double zero (00). Numbers can be given within the range 0-2300.
- **Frequencies** can be spoken as ninety eight point eight (98.8), a hundred and four point two or hundred four point two (104.2).

### Speed and repetition mode

It is possible to adjust the speed if the voice is speaking too quickly.

Repetition mode can be enabled so that the system repeats what you have said.

To change the speed or activate/deactivate repetition mode:

1. Press **Settings** in the top view.
2. Press **System** → **Voice Control** and select settings.
  - **Repeat Voice Command**
  - **Speech Rate**

### Related information

- Voice recognition (p. 138)
- Controlling a telephone with voice recognition (p. 140)
- Voice control of radio and media (p. 141)
- Controlling climate control with voice recognition (p. 197)
- Settings for voice recognition (p. 142)

### Controlling a telephone with voice recognition<sup>18</sup>

Call a contact, have messages read aloud or dictate brief messages with voice control commands to a Bluetooth connected telephone.

To specify a contact in the phone book, the voice recognition command must include contact information that is entered in the phone book. If a contact, e.g. **Robyn Smith**, has several phone numbers then the number category can also be stated, e.g. **Home** or **Mobile**: "**Call Robyn Smith Mobile**".

Press  and say one of the following commands:

- "**Call [contact]**" - dials the selected contact from the phone book.
- "**Call [phone number]**" - dials the phone number.
- "**Recent calls**" - displays the call list.
- "**Read message**" - message is read out. If there are several messages - select which message should be read out.
- "**Message to [contact]**" - users are requested to say a brief message. The message is then repeated aloud and the user can choose to send<sup>19</sup> or revise the message. For this function to work, the car must be connected to the Internet.

## Related information

- Voice recognition (p. 138)
- Using voice recognition (p. 139)
- Voice control of radio and media (p. 141)
- Controlling climate control with voice recognition (p. 197)
- Settings for voice recognition (p. 142)
- Internet-connected car\* (p. 521)

## Voice control of radio and media<sup>20</sup>

Commands for radio and media player device control are shown below.

Tap on  and say one of the following commands:

- **"Media"** - starts a dialogue for media and radio and shows examples of commands.
- **"Play [artist]"** - plays back music by the selected artist.
- **"Play [song title]"** - plays back the selected song.
- **"Play [song title] from [album]"** - plays back the selected song from the selected album.
- **"Play [TV channel name]"** - starts the selected TV channel\*<sup>21</sup>.
- **"Play [radio station]"** - starts playing back the selected radio channel.
- **"Tune to [frequency]"** - starts the selected radio frequency in the current frequency band. If no radio source is active, the FM band is started by default.
- **"Tune to [frequency] [wavelength]"** - starts the selected radio frequency in the selected frequency band.

- **"Radio"** - starts FM radio.
- **"Radio FM"** - starts FM radio.
- **"DAB"** - starts DAB radio\*.
- **"TV"** - starts playback from TV\*<sup>21</sup>.
- **"CD"** - starts playback from CD\*.
- **"USB"** - starts playback from USB.
- **"iPod"** - starts playback from iPod.
- **"Bluetooth"** - starts playback from a Bluetooth-connected media source.
- **"Similar music"** — plays back music similar to the music currently playing back from USB devices.

## Related information

- Voice recognition (p. 138)
- Using voice recognition (p. 139)
- Controlling a telephone with voice recognition (p. 140)
- Controlling climate control with voice recognition (p. 197)
- Settings for voice recognition (p. 142)

<sup>18</sup> Applies to certain markets.

<sup>19</sup> Only certain phones can broadcast messages from the car. For compatibility, see support.volvocars.com.

<sup>20</sup> Applies to certain markets.

<sup>21</sup> Applies to certain markets.

## Settings for voice recognition<sup>22</sup>

Settings for the voice control system are selected here.

Settings → System → Voice Control

Settings can be made within the following areas:

- Repeat Voice Command
- Gender
- Speech Rate

### Audio settings

Select audio settings under:

Settings → Sound → System Volumes → Voice Control

### Language settings

Voice recognition is not possible for all languages. Languages available for voice recognition are marked with an icon in the language list -

🇪🇺.

Changing the language also affects menu, message and help texts.

Settings → System → System Languages and Units → System Language

### Related information

- Voice recognition (p. 138)
- Using voice recognition (p. 139)
- Controlling a telephone with voice recognition (p. 140)
- Controlling climate control with voice recognition (p. 197)
- Voice control of radio and media (p. 141)
- Audio settings (p. 486)
- Changing system language (p. 125)

<sup>22</sup> Applies to certain markets.



LIGHTING

## Lighting control



The different lighting controls are used to control both exterior and interior lighting. The left-hand stalk switch activates and adjusts the exterior lighting. The interior brightness is adjusted using a thumbwheel on the instrument panel.

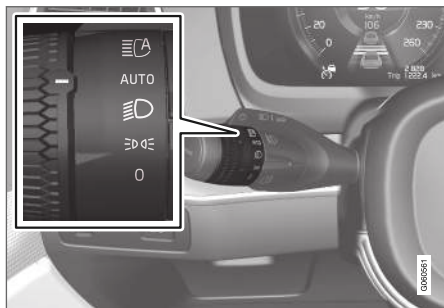

### Exterior lighting



Rotating ring in the left-hand stalk switch.

When the car's electrical system is in ignition position **II**, the following functions are available for the rotating ring's different positions:

Position	Specification
	Daytime running lights. Main beam flash can be used.
	Daytime running lights and position lamps. Position lamps when the car is parked. <sup>A</sup> Main beam flash can be used.
	Dipped beam and position lamps. Main beam can be activated. Main beam flash can be used.

Position	Specification
	Daytime running lights and position lamps in daylight. Dipped beam and position lamps in weak daylight or darkness, or when the front fog lamp* and/or rear fog lamp are activated. The Active main beam function can be activated. Main beam can be activated when dipped beam is switched on. Main beam flash can be used.
	Active main beam on/off.

<sup>A</sup> If the car is stationary but running, the rotating ring can be moved to  position from another position to switch on only the position lamps instead of other lighting.

Volvo recommends that **AUTO** mode is used when the vehicle is driven.

### WARNING

The car's lighting system is not able to determine when daylight is too weak or sufficiently strong, e.g. in fog and rain, in all situations.

The driver is always responsible for ensuring that the car is driven with a beam pattern suitable for the traffic situation and in accordance with applicable traffic regulations.

### Thumbwheel in instrument panel



Thumbwheel (to left) for adjusting interior brightness.

### Related information

- Adjusting light functions via the centre display (p. 145)
- Interior lighting (p. 155)
- Position lamps (p. 146)
- Using direction indicators (p. 150)
- Using main beam (p. 148)
- Dipped beam (p. 147)
- Front fog lamps/cornering lights\* (p. 151)
- Rear fog lamp (p. 152)
- Active bending lights\* (p. 151)
- Brake lights (p. 153)
- Emergency brake lights (p. 153)
- Hazard warning flashers (p. 153)

### Adjusting light functions via the centre display

Several light functions can be adjusted and activated via the centre display. This applies to active main beam, home safe lighting and approach light, for example.

1. Tap on **Settings** in the centre display's top view.
2. Press **My Car** → **Lights and Lighting**.
3. Select **Exterior Lights** or **Interior Lighting** and then select the function that needs to be adjusted.

### Related information

- Lighting control (p. 144)
- Active main beam (p. 148)
- Using home safe lighting (p. 154)
- Approach light duration (p. 154)
- Using direction indicators (p. 150)
- Other settings in the centre display's top view (p. 125)
- Function view in centre display (p. 115)

### Adapting the headlamp pattern from the headlamps

The headlamp pattern can be reset when changing from right to left-hand traffic, and vice versa. The function adapts the beam from the headlamps so that it does not dazzle oncoming traffic.

1. Tap on **Settings** in the centre display's top view.
2. Press **My Car** → **Lights and Lighting** → **Exterior Lights**.
3. Select **Temporary Right Hand Traffic/ Temporary Left Hand Traffic**.

### **i** NOTE

Active bending lights are not available when the headlamp pattern is temporarily adapted from left to right-hand traffic, or vice-versa.

### Related information

- Other settings in the centre display's top view (p. 125)
- Function view in centre display (p. 115)
- Active bending lights\* (p. 151)

## Position lamps

Position lamps can be used so that other road users can see the car if it stops or is parked. The position lamp is switched on with the rotating ring on the stalk switch.

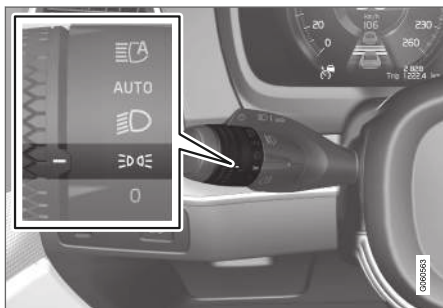

Stalk switch rotating ring in position lamps position.

Turn the rotating ring to the **P** position - the position lamps are switched on (number plate lighting is switched on at the same time).

If the car's electrical system is in ignition position **II** then the daytime running lights are switched on instead of the front position lamps. When the rotating ring is in this position, the position lamps are switched on regardless of the ignition position of the car's electrical system.

If the car is stationary but running, the rotating ring can be moved to the position lamp **P**.

position from another position to switch on only the position lamps instead of other lighting.

When driving for more than 30 seconds at max. 10 km/h (approx. 6 mph), or if the speed exceeds 10 km/h (approx. 6 mph), the daytime running lights are switched on. The driver should turn to a position other than **P**.

If the tailgate is opened when it is dark outside, the rear position lamps come on (if not already switched on) to warn road users approaching from behind. This takes place irrespective of the position of the rotating ring or the ignition position of the car's electrical system.

### Related information

- Lighting control (p. 144)
- Ignition positions (p. 428)

## Daytime running lights

The car has sensors that detect the light conditions in the surroundings. The daytime running lights are switched on when the rotating ring on the stalk switch is in position **0**, **P** or **AUTO** as well as when the car's electrical system is in ignition position **II**. In position **AUTO**, the headlamps change automatically to dipped beam in weak daylight or darkness.

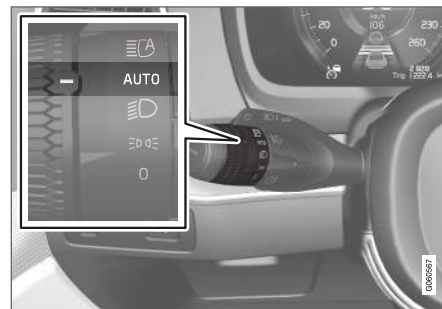

Stalk switch rotating ring in **AUTO** position.

If the stalk switch rotating ring is in the **AUTO** position, the daytime running lights (DRL<sup>1</sup>) are switched on when the car is driven in daylight. The car automatically changes lighting from daytime running light to dipped beam in weak daylight or darkness. Changing to dipped beam also takes place if the front fog lamp\* and/or rear fog lamp are activated.

### **⚠ WARNING**

This system help to save energy - it cannot determine in all situations when daylight is too weak or sufficiently strong, e.g. in mist and rain.

The driver is always responsible for ensuring that the car is driven with the correct beam pattern for the traffic situation and in accordance with applicable traffic regulations.

### **Related information**

- Lighting control (p. 144)
- Ignition positions (p. 428)
- Dipped beam (p. 147)

### **Dipped beam**

When driving with the stalk switch's rotating ring in the **AUTO** position, dipped beam is activated automatically in weak daylight or darkness or when the car's electrical system is in ignition position **II**.

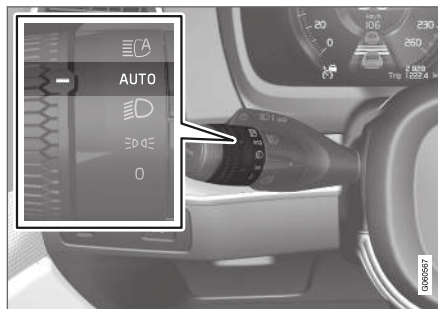

Stalk switch rotating ring in **AUTO** position.

With the stalk switch's rotating ring in **AUTO** position, dipped beam is also activated automatically if the rear fog lamp is activated.

With the stalk switch's rotating ring in the **⚡** position, dipped beam is always activated when the car's electrical system is in ignition position **II**.

### **Tunnel detection**

The car detects when it is driven into a tunnel and switches from daytime running lights to dipped beam.

Note that the rotating ring in the left-hand stalk switch must be in **AUTO** mode for tunnel detection to work.

### **Related information**

- Lighting control (p. 144)
- Ignition positions (p. 428)
- Daytime running lights (p. 146)

<sup>1</sup> Daytime Running Lights

## Using main beam

Main beam is operated with the left-hand stalk switch. Main beam is the car's strongest lighting and should be used when driving in the dark for better visibility, as long as it does not dazzle other road users.

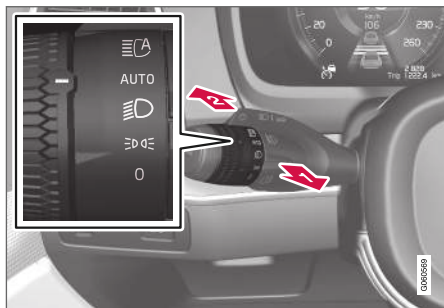

Steering wheel stalk switch with rotating ring.

### Main beam flash

1 Move the stalk switch backwards slightly to main beam flash position. Main beam comes on until the stalk switch is released.

### Main beam

2 Main beam can be activated when the steering wheel stalk switch's rotating ring is in position **AUTO**<sup>2</sup> or . Activate main beam by moving the stalk switch forwards.

Deactivate by moving the stalk switch backwards.

When main beam has been activated the  symbol illuminates in the driver display.

### Related information

- Lighting control (p. 144)
- Active main beam (p. 148)

## Active main beam

Active main beam is a function which uses a camera sensor at the top edge of the windscreen to detect the headlamp beams from oncoming traffic or the rear lights of vehicles in front, and then switches from main beam to dipped beam.

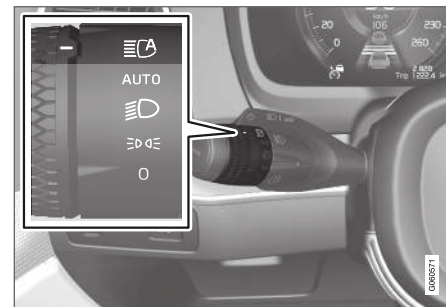



The symbol  represents active main beam.

The function can start while driving in the dark when the car's speed is approx. 20 km/h (approx. 12 mph) or higher. The function can also take streetlights into account. When the camera sensor no longer detects any oncoming car or car in front, main beam is switched on again after about a second.

<sup>2</sup> When dipped beam is activated.

### Activate active main beam

Active main beam is activated and deactivated by turning the rotating ring on the right-hand stalk switch to position . The rotating ring then returns to position **AUTO**. When active main beam is activated, the symbol  illuminates with a white glow in the driver display. When main beam is activated, the symbol shines blue.

If active main beam is deactivated while main beam is on, the lighting is immediately reset to dipped beam.

### Adaptive functionality

For cars with LED<sup>3</sup> headlamps\*, active main beam has adaptive functionality<sup>4</sup>. In this case, unlike what happens during conventional dimming, the light beam continues to illuminate with main beam on both sides of oncoming traffic or vehicles ahead – only the part of the light beam that points directly to the vehicle is dimmed.

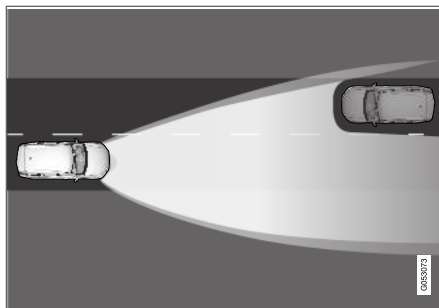

Adaptive functionality: Dipped beam directly towards oncoming vehicle, but continued main beam on both sides of the vehicle.

The main beam is partly dimmed, i.e. if the light beam shines with slightly more than dipped beam, the symbol  in the driver display shines blue.

### Limitations for active main beam

The camera sensor on which the function is based has limitations.



If this symbol is shown in the driver display, together with the message **Active High Beam Temporarily unavailable**, then switching between main and dipped beam must be performed manually. The  symbol extinguishes when these message are shown.



The same applies if this symbol is shown together with the message **Windscreen sensor blocked, see Owner's manual**.

Active main beam may be temporarily unavailable e.g. in situations with dense fog or heavy rain. When active main beam becomes available again, or the windscreen sensors are no longer blocked, the message goes out and the  symbol illuminates.

### WARNING

Active main beam is an aid for using the optimum beam pattern when conditions are favourable.

The driver always bears responsibility for manually switching between main and dipped beam when traffic situations or weather conditions so require.

<sup>3</sup> LED (Light Emitting Diode)

<sup>4</sup> Depending on the car's equipment level.

◀◀ **Related information**

- Lighting control (p. 144)
- Using main beam (p. 148)
- Limitations for camera and radar unit (p. 330)

**Using direction indicators**

The car's direction indicators are operated with the left-hand stalk switch. The direction indicator lamps flash three times or continuously, depending on how far up or down the stalk switch is moved.

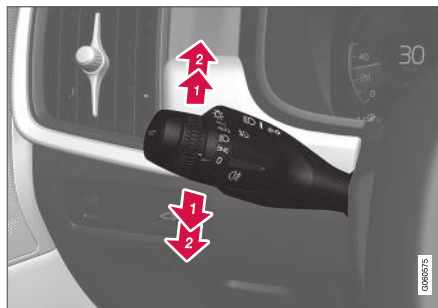

Direction indicators.

**Short flash sequence**

- ➡ Move the stalk switch up or down to the first position and release. The direction indicator lamps flash three times. If the function is deactivated via the centre display, the lamps will flash once.

<b>i</b>	<b>NOTE</b>
<ul style="list-style-type: none"> <li>• This automatic flashing sequence can be stopped by moving the stalk switch immediately in the opposite direction.</li> <li>• If the symbol for direction indicators in the driver display flashes more quickly than normal - see the message in the driver display.</li> </ul>	

**Continuous flash sequence**

- ➡ Move the stalk switch up or down to its end position.

The stalk switch remains in its position and is moved back manually, or automatically by the steering wheel movement.

**Related information**

- Hazard warning flashers (p. 153)
- Adjusting light functions via the centre display (p. 145)



## Active bending lights\*

Active bending lights are designed to provide maximum illumination in bends and junctions. Cars with LED<sup>5</sup> headlamps\* can have active bending lights, depending on the car's equipment level.

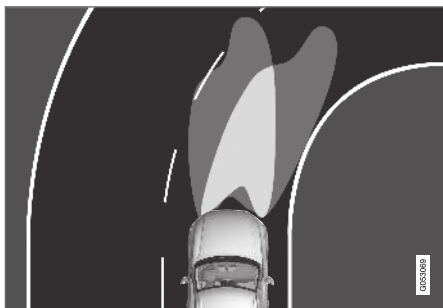

Headlamp pattern with function deactivated (left) and activated (right) respectively.

Active bending lights follow steering wheel movements to provide maximum illumination in bends and junctions and can thereby provide the driver with improved visibility.

The function is activated automatically when the car is started. In the event of a fault in the function, the  symbol illuminates in the driver display at the same time as the driver display shows an explanatory text.

The function is only active in weak daylight or darkness and only when the car is moving and dipped beam is switched on.

## Deactivating/activating the function

The function is activated when the car is supplied from the factory and can be deactivated/activated via the centre display's function view.



Press the **Active Bending Lights** button.

## Related information



- Adjusting light functions via the centre display (p. 145)
- Front fog lamps/cornering lights\* (p. 151)

## Front fog lamps/cornering lights\*

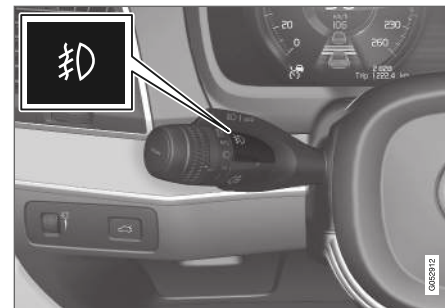
The front fog lamps emit a stronger beam than dipped beam and are therefore additionally effective in fog.



Button for front fog lamps.

The rear fog lamps can only be switched on when the car's electrical system is in ignition position **II** and the rotating ring on the stalk switch is in position **AUTO**,  or .

Press the button to activate and deactivate. The  symbol illuminates in the driver display when the front fog lamps are switched on.

The front fog lamps switch off automatically when the car is switched off or when the rotating ring on the stalk switch is set to the **0** position.

<sup>5</sup> LED (Light Emitting Diode)

**NOTE**

Regulations on the use of fog lamps vary from country to country.

**Cornering lights\***

The front fog lamps can include the cornering lights function, which temporarily illuminates the area diagonally in front of the car in the direction the steering wheel is turned on a sharp bend, or in the direction shown by the direction indicators.

The function is activated in weak daylight or darkness when the stalk switch's rotating ring is in the **AUTO** or  position and the speed of the car is lower than approx. 30 km/h (approx. 20 mph).

In addition, both cornering lights are switched on as a supplement to the reversing lamp during reversing.

The function is activated when the car is supplied from the factory and can be activated and deactivated via the centre display.

**Related information**

- Lighting control (p. 144)
- Ignition positions (p. 428)
- Rear fog lamp (p. 152)
- Active bending lights\* (p. 151)
- Adjusting light functions via the centre display (p. 145)

**Rear fog lamp**

The rear fog lamp is considerably stronger than the normal rear lights and should only be used in reduced visibility due to fog, snow, smoke or dust so that other road users have an early warning of a vehicle ahead.



Button for rear fog lamp.

The rear fog lamp is a lamp at the rear of the car, on the driver's side.

The rear fog lamp can only be switched on when ignition position **II** is active and the rotating ring on the stalk switch is in position **AUTO** or  .

Press the button to switch the lights on/off. The

 symbol in the driver display illuminates when the rear fog lamp is switched on.

The rear fog lamp switches off automatically when the car is switched off or when the rotating

ring on the stalk switch is set to the **0** or  position.

**NOTE**

Regulations on the use of rear fog lamps vary from country to country.

**Related information**

- Lighting control (p. 144)
- Front fog lamps/cornering lights\* (p. 151)
- Ignition positions (p. 428)

## Brake lights

The brake light automatically comes on during braking.

The brake light is illuminated when the brake pedal is depressed and when the car is braked automatically by one of the driver support systems.

### Related information

- Emergency brake lights (p. 153)
- Brake functions (p. 431)
- Driving support systems (p. 278)

## Emergency brake lights

Emergency brake lights are activated to alert vehicles behind about heavy braking.

The function means that the brake light flashes instead of - as in normal braking - shining with a constant glow.

The emergency brake lights are activated during heavy braking or if the ABS system is activated at high speeds.

After the driver brakes to a low speed and then releases the brake, the brake light returns to normal glow.

The car's hazard warning flashers are activated at the same time. These flash until the driver accelerates the car to a higher speed again or switches off the car's hazard warning flashers.

### Related information

- Brake lights (p. 153)
- Foot brake (p. 432)
- Hazard warning flashers (p. 153)

## Hazard warning flashers

Hazard warning flashers warn other road users by means of all of the car's direction indicators being activated simultaneously. The function can be used to give a warning in the event of traffic hazards.

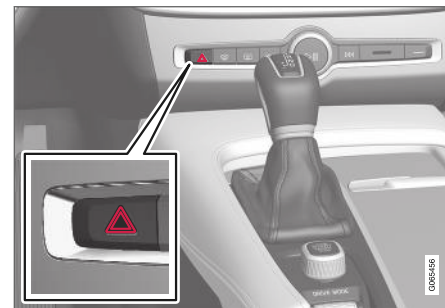

Button for hazard warning flashers.

Press the button to activate the hazard warning flashers.

The hazard warning flashers are automatically activated when the car brakes so powerfully that the emergency brake lights are activated and the speed is low. The hazard warning flashers start to flash after the emergency brake lights have stopped flashing and are then deactivated automatically when the car drives away again or are deactivated if the button is depressed.

**i NOTE**

Regulations for the use of hazard warning flashers may vary between countries.

**Related information**

- Emergency brake lights (p. 153)
- Using direction indicators (p. 150)

**Using home safe lighting**

Some of the exterior lighting can be kept switched on to work as home safe lighting after the car has been locked.

To activate the function:

1. Switch off the car.
2. Move the left-hand stalk switch forward toward the instrument panel and release.
3. Get out of the car and lock the door.

When the function is activated, a symbol illuminates in the driver display and position lamps, exterior handle lighting\* and number plate lighting are switched on.

The length of time that home safe lighting remains on can be set via the centre display.

**Related information**

- Adjusting light functions via the centre display (p. 145)
- Approach light duration (p. 154)

**Approach light duration**

Approach lighting is switched on when the car is unlocked and is used to switch on the car's lighting at a distance.

The function is activated when the remote control key is used for unlocking. At which point, position lamps, exterior handle lighting\*, number plate lighting, interior roof lamps, floor lamps and cargo area lighting are switched on. If a door is opened within the activation time, the time for the lighting in the outside handles\* and the interior lighting will be extended.

The function can be activated and deactivated via the centre display.

**Related information**

- Adjusting light functions via the centre display (p. 145)
- Using home safe lighting (p. 154)
- Remote control key (p. 235)

## Interior lighting

The interior is equipped with several different types of lighting to improve the experience. This includes, reading lamps, glovebox lighting and ground lighting.

All lighting in the passenger compartment can be switched on and off manually at least 5 minutes from when:

- the car has been switched off and its electrical system is in ignition position **0**
- the car has been unlocked but it has not been started.

## Front roof lighting



Controls in roof console for the front reading lamps and passenger compartment lighting.

- 1 Reading lamp, left-hand side
- 2 Passenger compartment lighting

- 3 Auto function for passenger compartment lighting
- 4 Reading lamp, right-hand side

## Reading lighting

The reading lamps on the right and left-hand sides can be turned on and off by briefly pressing the buttons in the roof console. Brightness is adjusted by holding the button pressed in.

## Passenger compartment lighting

The floor lighting and interior roof lighting are switched on or off with a short press on the button in the roof console.

## Auto function for passenger compartment lighting

The automatic function is activated by a short press on the **AUTO** button in the roof console. With the automatic system activated, the light indicator in the button illuminates and the passenger compartment lighting is switched on and off according to the following.

The passenger compartment lighting comes on when:

- the car is unlocked
- the car is switched off
- a side door is opened
- remains on for 2 minutes if one of the side doors is open.

The passenger compartment lighting goes off when:

- the car is locked
- the car is started
- a side door is closed.

## Rear roof lighting

The rear area of the car has reading lighting, which is also used as passenger compartment lighting.



Reading lamps above the rear seat.



In cars with panorama roof\* there are two lamp units, one on each side of the roof.

The reading lamps are switched on or off by briefly pressing the button on the lamp. Brightness is adjusted by holding the button pressed in.

### Glovebox lighting

Glovebox lighting is switched on and off respectively when the lid is opened or closed.

### Sun visor mirror lighting\*

The lighting for the mirror in the sun visor is switched on and off respectively when the cover is opened or closed.

### Ground lighting\*

The ground lighting is switched on or off when the corresponding door is opened or closed.

### Door sill lighting

The door sill lighting is switched on or off when a door is opened or closed.

### Lighting in the cargo area

The lighting in the cargo area is switched on or off when the tailgate is opened or closed.

### Decor lighting

The ambient light is switched on when you open the doors and is switched off when the car is locked. The intensity of the decor lighting can be adapted in the centre display and also precisely adjusted using the thumbwheel in the instrument panel.

### Ambience lights\*

The car is equipped with LEDs that make it possible to change the colour of the light. These lights are switched on when the car is running. The ambience light can be adapted in the centre display and also precisely adjusted using the thumbwheel in the instrument panel.

### Lighting in storage compartments in doors

The lighting in the storage compartments in the doors is switched on when you open the doors and is switched off when the car is locked. The brightness can be precisely adjusted using the thumbwheel in the instrument panel.

### Lighting in the tunnel console's front cup holder

The lighting in the front cup holders is switched on when the car is unlocked and is switched off when the car is locked. The brightness can be

precisely adjusted using the thumbwheel in the instrument panel.

### Related information

- Adjusting interior lighting (p. 157)
- Lighting control (p. 144)
- Ignition positions (p. 428)
- Passenger compartment interior (p. 570)

## Adjusting interior lighting

The lamps inside the car come on differently depending on the ignition position used. The interior lighting can be adjusted with a thumbwheel in the instrument panel, and certain light functions can also be adjusted via the centre display.



The thumbwheel on the instrument panel, to the left of the steering wheel, is used to adjust the brightness of the display light, control light, ambient light and ambience light\*

### Adjusting ambient decor illumination

1. Press **Settings** in the top view in the centre display.
2. Press **My Car → Lights and Lighting → Interior Lighting**.
3. Choose between the following settings:
  - Under **Ambient Light Intensity**, select from **Off**, **Low** and **High**.
  - Under **Ambient Light Level**, select from **Reduced** and **Full**.

### Adjusting ambience light\*

The car is equipped with a number of LEDs that make it possible to change the colour of the light. These lights are switched on when the car is running.

### Changing the brightness of the lights

1. Press **Settings** in the top view in the centre display.
2. Press **My Car → Lights and Lighting → Interior Lighting → Interior Mood Lighting**.
3. Under **Interior Mood Light Intensity**, select from **Off**, **Low** and **High**.

### Changing the colour of the light

1. Press **Settings** in the top view in the centre display.
2. Press **My Car → Lights and Lighting → Interior Lighting → Interior Mood Lighting**.
3. Choose between **By Temperature** and **By Colour** in order to change the colour of the light.

With the **By Temperature** option, the light changes according to the set passenger compartment temperature.

With the **By Colour** option, the **Theme Colours** subcategory can be used to adjust further.

### Related information

- Interior lighting (p. 155)
- Adjusting light functions via the centre display (p. 145)
- Ignition positions (p. 428)





WINDOWS, GLASS AND MIRRORS

## Windows, glass and mirrors

The car contains controls for windows, glass and mirrors. Some of the windows in the car are laminated.

### Laminated glass

The windscreen has laminated glass, and laminated glass is available as an option for certain other glass areas. Laminated glass is reinforced, which provides better protection against break-ins and improved sound insulation in the passenger compartment.

The panoramic roof\* also has laminated glass.



The symbol is shown on the windows where the glass is laminated<sup>1</sup>

### Related information

- Pinch protection for windows and sun blinds (p. 160)
- Panorama roof\* (p. 166)
- Power windows (p. 161)
- Rearview and door mirrors (p. 163)
- Head-up display\* (p. 135)
- Using windscreen wipers (p. 170)

- Using windscreen and headlamp washers (p. 173)
- Activating and deactivating the heated windscreen\* (p. 214)
- Activating and deactivating the heated rear window and door mirrors (p. 215)

## Pinch protection for windows and sun blinds

All power windows and sun blinds\* have pinch protection which is deployed if they are blocked by any object while opening or closing.

In the event of blocking, the movement stops and then reverses automatically to approx. 50 mm (approx. 2 inches) from the blocked position (or to full ventilation position).

It is possible to force pinch protection when closing has been cancelled, e.g. when ice is formed, by continuing to press the control in one and the same direction.

If any fault arises with the pinch protection, a reset sequence can be tested.

### WARNING

If the starter battery is disconnected, the automatic opening and closing function must be reset to work properly. A reset must take place for pinch protection to work.

### Related information

- Reset sequence for pinch protection (p. 161)
- Operating power windows (p. 162)
- Panorama roof\* (p. 166)

<sup>1</sup> Does not apply to the windscreen or panorama roof\* which are always laminated and thus do not have this symbol.

## Reset sequence for pinch protection

If a problem occurs with the electrical functions for the electric windows, a reset sequence can be tested.

### WARNING

If the starter battery is disconnected, the automatic opening and closing function must be reset to work properly. A reset must take place for pinch protection to work.

If a problem persists, or if it concerns the panoramic roof or sunroof, contact a workshop<sup>2</sup>.

### Reset the power window

1. Start with the window in closed position.
2. Then operate the controls in the manual position 3 times upwards to closed position.
  - > The system is initialised automatically.

### Related information

- Pinch protection for windows and sun blinds (p. 160)
- Operating power windows (p. 162)

## Power windows

The power windows are operated using the control panels in each respective door. The driver's door has controls for operating all windows and also to activate the child safety locks.

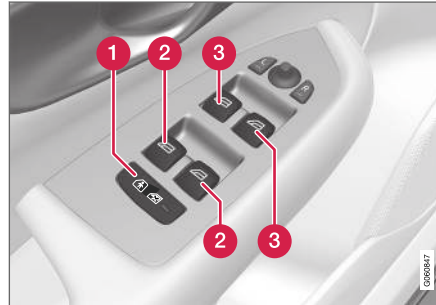

Driver's door control panel.

- 1 Electric child safety locks\* that deactivate the controls in the rear doors to prevent doors or windows from being opened from the inside.
- 2 Controls for rear windows.
- 3 Controls for front windows.

The power windows are equipped with pinch protection. If any fault arises with the pinch protection, a reset sequence can be tested.

### WARNING

Children, other passengers or objects may be trapped by the moving parts.

- Always operate the windows with caution.
- Do not allow children to play with the controls.
- Never leave children alone in the car.
- Remember to always switch off the power supply to the power windows by setting the car's electrical system in ignition position **0**, and then take the remote control key with you when leaving the car.
- Never put an object or part of the body through the windows, even if the car's electrical system is fully disconnected.

### Related information

- Operating power windows (p. 162)
- Pinch protection for windows and sun blinds (p. 160)
- Reset sequence for pinch protection (p. 161)

<sup>2</sup> An authorised Volvo workshop is recommended.

## Operating power windows

Using the driver's door control panel, all power windows can be operated - using the control panels in the other doors operates the power window in the individual door.

The power windows are equipped with pinch protection. If any fault arises with the pinch protection, a reset sequence can be tested.

### **WARNING**

Children, other passengers or objects may be trapped by the moving parts.

- Always operate the windows with caution.
- Do not allow children to play with the controls.
- Never leave children alone in the car.
- Remember to always switch off the power supply to the power windows by setting the car's electrical system in ignition position **0**, and then take the remote control key with you when leaving the car.
- Never put an object or part of the body through the windows, even if the car's electrical system is fully disconnected.



Operating the power windows.

- 1** Operating without auto. Move one of the controls gently up or down. The power windows move up or down as long as the control is held in position.
- 2** Operating with auto. Move one of the controls up or down to the end position and release it. The window runs automatically to its end position.

In order for the power windows to be used, the ignition position must be **I** or **II**. The power windows can be operated for a few minutes after the car has been switched off and after the ignition has been switched off - although not after a door has been opened. It is only possible to operate one control at a time.

It can also be operated using a remote control key or keyless opening\* with the door handle.

### **WARNING**

Check that children or other passengers are not at risk of crushing when all the windows are closed with a remote control key or keyless opening\* with a door handle.

### **NOTE**

One way to reduce the pulsating wind noise when the rear windows are open is to also open the front windows slightly.

### **NOTE**

The windows cannot be opened at speeds above approx. 180 km/h (approx. 112 mph), but they can be closed.

The driver always bears responsibility for following traffic regulations in force.

### **NOTE**

It may not be possible to operate windows at low temperatures.

### Related information

- Power windows (p. 161)
- Pinch protection for windows and sun blinds (p. 160)
- Reset sequence for pinch protection (p. 161)

- Keyless locking and unlocking\* (p. 259)
- Locking and unlocking with the remote control key (p. 237)

## Rearview and door mirrors

The rearview mirrors and door mirrors are used to give the driver better visibility to the rear.

### Interior rearview mirror

The interior rearview mirror is adjusted by angling it manually. The interior rearview mirror can be fitted with HomeLink\*, automatic dimming\* and compass\*.

### Door mirrors

#### WARNING

Both mirrors are bent to provide optimal vision. Objects may appear to be further away than they actually are.

The door mirror positions are adjusted with the joystick in the driver's door control panel. There are also a number of automatic settings that can be linked to the memory function buttons for the power seat\*.

### Related information

- HomeLink®\* (p. 479)
- Compass\* (p. 483)
- Adjusting rearview mirror dimming (p. 164)
- Angling the door mirrors (p. 165)
- Storing position for seat, door mirrors and head-up display\* (p. 180)

- Activating and deactivating the heated rear window and door mirrors (p. 215)

## Adjusting rearview mirror dimming

Bright light from behind could be reflected in the rearview mirrors and dazzle the driver. Use dimming when disturbed by light from behind.

### Manual dimming

The interior rearview mirror can be dimmed with a control in the mirror's lower edge.



#### 1 Control for manual dimming.

1. Use dimming by moving the control in towards the passenger compartment.
2. Return to normal mode by moving the control towards the windscreen.

The control for manual dimming is not available on mirrors with automatic dimming.

### Automatic dimming\*

Bright light from behind is automatically dimmed by the interior rearview and door mirrors. Automatic dimming is always active while driving, apart from when gearbox reverse position is selected.

#### **i** NOTE

When sensitivity is changed there is no immediately noticeable change in dimming, but the change takes place gradually.

Dimming sensitivity will affect both the interior rearview mirror and the door mirrors.

To change dimming sensitivity:

1. Press **Settings** in the top view in the centre display.
2. Press **My Car** → **Mirrors and Convenience**.
3. Under **Rearview Mirror Auto Dimming**, select **Normal**, **Dark** or **Light**.

The interior rearview mirror contains two sensors - one forward facing and one rearward facing - that work together to identify and eliminate dazzling light. The forward facing sensor detects ambient light, while the rearward facing sensor detects the light from vehicle headlights behind.

For the door mirrors to be equipped with automatic dimming, the interior rearview mirror must also be equipped with automatic dimming.

#### **i** NOTE

If the sensors are obscured by e.g. parking permits, transponders, sun visors or objects in the seats or in the cargo area in such a way that light is prevented from reaching the sensors, then the dimming function of the interior rearview and door mirrors is reduced.

### Related information

- Rearview and door mirrors (p. 163)
- Angling the door mirrors (p. 165)

## Angling the door mirrors

To ensure better visibility to the rear, the door mirrors need to be set to the preferences of the driver. There are a number of automatic settings that can also be linked to the memory function buttons for the power seat\*.

### Using controls for door mirrors

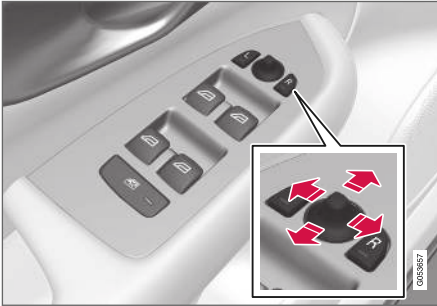

Controls for door mirrors.

The door mirror positions are adjusted with the joystick in the driver's door control panel. Ignition position must be at least I.

1. Press the **L** button for the left-hand door mirror or the **R** button for the right-hand door mirror. The light in the button illuminates.
2. Adjust the position with the joystick in the centre.

3. Press the **L** or **R** button again. The light should no longer be illuminated.

### Folding in rearview mirrors electrically\*

The mirrors can be retracted for parking/driving in narrow spaces.

1. Depress the **L** and **R** buttons simultaneously.
2. Release them after approximately 1 second. The mirrors automatically stop in the fully retracted position.

Fold out the mirrors by pressing down the **L** and **R** buttons simultaneously. The mirrors automatically stop in the fully extended position.

### Resetting to neutral

Mirrors that have been moved out of position by an external force must be reset electrically to the neutral position for electric retracting/extending\* to work correctly.

1. Fold in the door mirrors by pressing down the **L** and **R** buttons simultaneously.
2. Fold them out again by pressing the **L** and **R** buttons simultaneously.
3. Repeat the above procedure as necessary.

The mirrors are now reset in neutral position.

### Angling during parking<sup>3</sup>

A door mirror can be angled down for the driver to view the side of the road when parking, for example.

- Engage reverse gear and press the **L** or **R** button.

Note that the button may need to be pressed twice, depending on whether it was already pre-selected. The button flashes when the door mirror is angled down. When reverse gear is disengaged, the door mirror automatically starts to return after approx. 3 seconds and then reaches its original position after approx. 8 seconds.

### Automatic angling during parking<sup>3</sup>

With this setting, the door mirror is automatically angled down when reverse gear is selected. The folded position is preset and cannot be adjusted. You can make the door mirror return to its original position by pressing the **L** or **R** button twice.

1. Tap on **Settings** in the centre display's top view.
2. Press **My Car** → **Mirrors and Convenience**.
3. Under **Exterior Mirror Tilt at Reverse**, select **Off**, **Driver**, **Passenger** or **Both** to activate/deactivate and to select which review mirror should be angled.

<sup>3</sup> Only in combination with power seat with memory buttons\*.

#### ◀◀ **Automatic retraction when locking\***

When the car is locked/unlocked with the remote control key, the door mirrors can be automatically retracted/extended.

1. Tap on **Settings** in the centre display's top view.
2. Press **My Car → Mirrors and Convenience**.
3. Select **Fold Mirror When Locked** to activate/deactivate.

#### **Related information**

- Rearview and door mirrors (p. 163)
- Adjusting rearview mirror dimming (p. 164)
- Storing position for seat, door mirrors and head-up display\* (p. 180)
- Activating and deactivating the heated rear window and door mirrors (p. 215)

#### **Panorama roof\***

The panorama roof is divided into two glass sections. The front section can be opened vertically at the rear edge (ventilation position) or horizontally (open position). The rear section is fixed roof glass.

The panoramic roof has a wind deflector and a sun blind made of perforated fabric and located under the glass roof to provide extra protection from factors such as strong sunlight.



The panoramic roof and sun blind are operated with a control located in the roof.

In order that the panoramic roof and the sun blind can be operated, the car's electrical system must be in ignition position **I** or **II**.

#### **⚠ WARNING**

Children, other passengers or objects may be trapped by the moving parts.

- Always operate the windows with caution.
- Do not allow children to play with the controls.
- Never leave children alone in the car.
- Remember to always switch off the power supply to the power windows by setting the car's electrical system in ignition position **0**, and then take the remote control key with you when leaving the car.
- Never put an object or part of the body through the windows, even if the car's electrical system is fully disconnected.

#### **⚠ IMPORTANT**

- Do not open the panoramic roof when load carriers are fitted.
- Do not place any heavy objects on the panoramic roof.

#### **⚠ IMPORTANT**

- Remove ice and snow before opening the panoramic roof. Take care not to scratch surfaces or damage strips.
- Do not operate the panoramic roof if it has frozen closed.



## Wind deflector

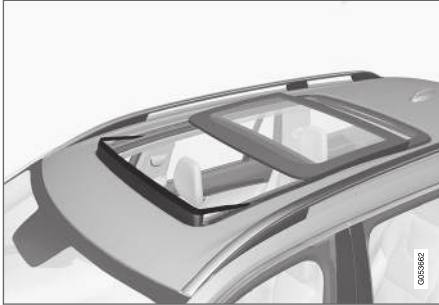

The panorama roof has a wind deflector that is raised when the panorama roof is in the open position.

## Related information

- Operating the panorama roof\* (p. 167)
- Automatic closing of the panoramic roof's\* sun blind (p. 169)
- Pinch protection for windows and sun blinds (p. 160)
- Keyless locking and unlocking\* (p. 259)
- Locking and unlocking with the remote control key (p. 237)

## Operating the panorama roof\*

The panoramic roof and sun blind are operated with a control in the roof panel and both are equipped with pinch protection.

### **⚠ WARNING**

Children, other passengers or objects may be trapped by the moving parts.

- Always operate the windows with caution.
- Do not allow children to play with the controls.
- Never leave children alone in the car.
- Remember to always switch off the power supply to the power windows by setting the car's electrical system in ignition position **0**, and then take the remote control key with you when leaving the car.
- Never put an object or part of the body through the windows, even if the car's electrical system is fully disconnected.

### **⚠ IMPORTANT**

- Do not open the panoramic roof when load carriers are fitted.
- Do not place any heavy objects on the panoramic roof.

### **⚠ IMPORTANT**

- Remove ice and snow before opening the panoramic roof. Take care not to scratch surfaces or damage strips.
- Do not operate the panoramic roof if it has frozen closed.

In order that the panoramic roof and the sun blind can be operated, the car's electrical system must be in ignition position **I** or **II**.

It can also be operated using a remote control key or keyless opening\* with the door handle.

### **⚠ WARNING**

Check that children or other passengers are not at risk of crushing when all the windows are closed with a remote control key or keyless opening\* with a door handle.

### **⚠ IMPORTANT**

Check that the panoramic roof is properly closed when closing.

The movement of the roof is stopped if the control is released during manual operation, or when the glass reaches the comfort position<sup>4</sup> or the maximum opening or closing position. The move-

<sup>4</sup> Comfort position is a position where wind noise and resonance noise are at a comfortably low level while driving.

- ◀◀ ment of both panoramic roof and sun blind are also stopped if the roof control is operated again in the opposite direction to the current direction of movement.

The panoramic roof and the sun blind are also equipped with pinch protection. If any fault arises with the pinch protection, a reset sequence can be tested.

**i NOTE**

For manual opening, the sun blind must be fully open before the panoramic roof can be opened. When the procedure is reversed, the panoramic roof must be fully closed before the sun blind can be fully closed.

**i NOTE**

It may not be possible to operate windows at low temperatures.

**Open and close ventilation position**

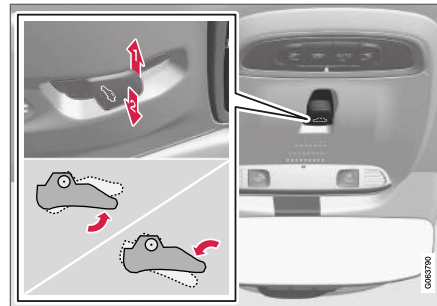

Ventilation position, vertically at the rear edge.

- 1** → Open by pressing the control upward once.
- 2** → Close by pressing the control downward once.

When the ventilation position is selected the front glass cover is raised at its rear edge. If the sun blind is fully closed when ventilation position is selected, then it opens automatically approx. 50 mm (approx. 2 inches).

The sun blind follows automatically if the panoramic roof is closed from ventilation position.

**Fully open and close the panoramic roof using the roof control**

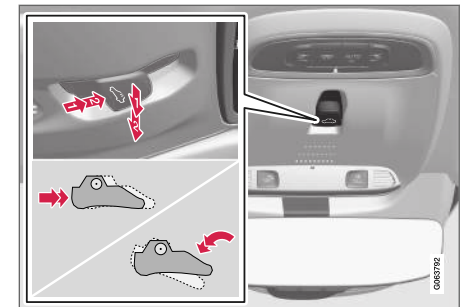

- 1** → Operation, manual mode
- 2** → Operation, automatic mode

**Manual operation**

1. To open the sun blind - press the control backwards to the position for manual opening.
2. Open the panoramic roof to comfort position - press the control backwards a second time to the position for manual opening.
3. Open the panoramic roof to maximum position - press the control backwards a third time to the position for manual opening.

Close by repeating the preceding procedure in reverse order - press the control forward/downward to the manual closing position instead.

**Automatic operation**

1. Open the sun blind to maximum position - press the control backward to the position for automatic opening and release.
2. Open the panoramic roof to comfort position - press the control backwards a second time to the position for automatic opening and release.
3. Open the panoramic roof to maximum position - press the control backwards a third time to the position for automatic opening and release.

Close by repeating the preceding procedure in reverse order - press the control forward/downward to the automatic closing position instead.

**Automatic operation - rapid opening or closing**

The panoramic roof and sun blind can be opened or closed simultaneously:

- To open - press the control rearward to the automatic operation position twice and release.
- To close - press the control forward/downward to the automatic operation position twice and release.

**Related information**

- Panorama roof\* (p. 166)
- Automatic closing of the panoramic roof's\* sun blind (p. 169)

- Pinch protection for windows and sun blinds (p. 160)
- Keyless locking and unlocking\* (p. 259)
- Locking and unlocking with the remote control key (p. 237)

**Automatic closing of the panoramic roof's\* sun blind**

With this function, the sun blind is closed automatically 15 minutes after the car has been locked if it is parked in hot weather. This is in order to lower the passenger compartment temperature and protect the car's upholstery from sun-fading.

The function is deactivated when the car is supplied from the factory and can be activated or deactivated in the centre display.

1. Press **Settings** in the top view in the centre display.
2. Press **My Car** → **Locking**.

Select **Auto Close Sunroof Curtain** to activate/deactivate.

***i* NOTE**

The sun blind is also closed when all windows are closed using the remote control key or keyless opening\* with a door handle.

**Related information**

- Panorama roof\* (p. 166)
- Operating the panorama roof\* (p. 167)
- Pinch protection for windows and sun blinds (p. 160)



- Keyless locking and unlocking\* (p. 259)
- Locking and unlocking with the remote control key (p. 237)

### Wiper blades and washer fluid

Together with the washer fluid, the wipers are used to improve visibility as well as headlamp pattern.

Washer fluid direct from the wiper blades and heating\* of the wiper blades gives improved vision.

Information indicating that the washer fluid needs topping up appears in the driver display when there is approx. 1 litre (1 qt) of washer fluid remaining.

### Related information

- Using the rain sensor (p. 171)
- Using windscreen and headlamp washers (p. 173)
- Using automatic rear windscreen wiping when reversing (p. 175)
- Using the rain sensor's memory function (p. 172)
- Using the rear window wiper and washer (p. 174)
- Filling washer fluid (p. 641)
- Wiper blades in service position (p. 640)
- Replacing windscreen wiper blades (p. 639)
- Replacing the wiper blade, rear window (p. 638)
- Using windscreen wipers (p. 170)

### Using windscreen wipers

The windscreen wipers clean the windscreen. Different settings for the windscreen wipers are set using the right-hand stalk switch.

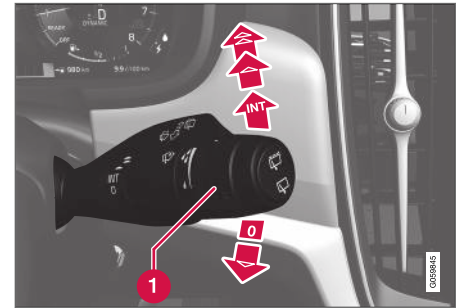

Right-hand stalk switch.

- 1 The thumbwheel is used to set rain sensor sensitivity and wiper swipe frequency.

### Single sweep

 Lower the stalk switch and release to make one sweep.

### Windscreen wipers off

 Move the stalk switch to position 0 to switch off the windscreen wipers.

### Intermittent wiping

 Set the number of sweeps per time unit with the thumbwheel when intermittent wiping is selected.

### Continuous wiping



Raise the stalk switch for the wipers to sweep at normal speed.



Raise the stalk switch further for the wipers to sweep at high speed.

### ! IMPORTANT

Before activating the wipers - ensure that the wiper blades are not frozen in, and that any snow or ice on the windscreen and rear window is scraped away.

### ! IMPORTANT

Use plenty of washer fluid when the wipers are cleaning the windscreen. The windscreen must be wet when the windscreen wipers are operating.

### Related information

- Using the rain sensor (p. 171)
- Using windscreen and headlamp washers (p. 173)
- Using automatic rear windscreen wiping when reversing (p. 175)
- Wiper blades and washer fluid (p. 170)
- Using the rain sensor's memory function (p. 172)
- Using the rear window wiper and washer (p. 174)

- Filling washer fluid (p. 641)
- Wiper blades in service position (p. 640)
- Replacing windscreen wiper blades (p. 639)
- Replacing the wiper blade, rear window (p. 638)

### Using the rain sensor

The rain sensor automatically starts the windscreen wipers based on how much water it detects on the windscreen. Rain sensor sensitivity can be adjusted with the thumbwheel on the right-hand stalk switch.

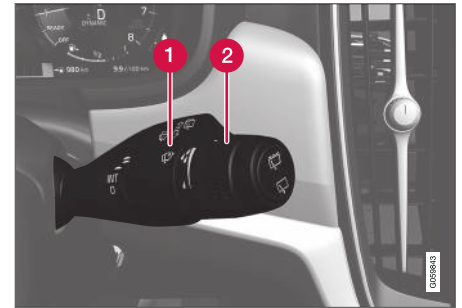

Right-hand stalk switch.

- 1 Rain sensor button
- 2 Thumbwheel sensitivity/frequency

When the rain sensor is activated, the rain sensor symbol  is shown in the driver display.

### Activating the rain sensor

When activating the rain sensor, the car must be running or in ignition position **I** or **II** while the windscreen wiper stalk switch is in position **0** or in the position for a single sweep.



- ◀◀ Activate the rain sensor by pressing the rain sensor button .

Move the lever down to make the wipers move.

Turn the thumbwheel upward for higher sensitivity and downward for lower sensitivity. An extra sweep is made when the thumbwheel is turned upward.

### Deactivating the rain sensor

Deactivate the rain sensor by pressing the rain sensor button  or moving the stalk switch up to another wiper program.

The rain sensor is deactivated automatically in ignition position **0** or when the engine is switched off.

The rain sensor is deactivated automatically when wiper blades are set in service position. The rain sensor is reactivated when service mode has been deactivated.

### IMPORTANT

The windscreen wipers could start and be damaged in an automatic car wash. Deactivate the rain sensor while the car is running or when the car's electrical system is in ignition position **I** or **II**. The symbol in the driver display extinguishes.

### Related information

- Using windscreen and headlamp washers (p. 173)
- Using automatic rear windscreen wiping when reversing (p. 175)
- Wiper blades and washer fluid (p. 170)
- Using the rain sensor's memory function (p. 172)
- Using the rear window wiper and washer (p. 174)
- Filling washer fluid (p. 641)
- Wiper blades in service position (p. 640)
- Replacing windscreen wiper blades (p. 639)
- Replacing the wiper blade, rear window (p. 638)
- Using windscreen wipers (p. 170)

### Using the rain sensor's memory function

The rain sensor automatically starts the windscreen wipers based on how much water it detects on the windscreen.

### Activating/deactivating the memory function

The memory function for the rain sensor can be activated in such a way that the rain sensor button does not need to be depressed each time the car is started:

1. Press **Settings** in the top view in the centre display.
2. Press **My Car** → **Wipers**.
3. Select **Rain Sensor Memory** to activate/deactivate the memory function.

### Related information

- Using the rain sensor (p. 171)
- Using windscreen and headlamp washers (p. 173)
- Using automatic rear windscreen wiping when reversing (p. 175)
- Wiper blades and washer fluid (p. 170)
- Using the rear window wiper and washer (p. 174)
- Filling washer fluid (p. 641)
- Wiper blades in service position (p. 640)

- Replacing windscreen wiper blades (p. 639)
- Replacing the wiper blade, rear window (p. 638)
- Using windscreen wipers (p. 170)

## Using windscreen and headlamp washers

Windscreen and headlamp washers clean the windscreen and headlamps. Windscreen and headlamp washers are started using the right-hand stalk switch.

### Starting windscreen and headlamp washers



Washing function, right-hand stalk switch.

- Move the right-hand stalk switch toward the steering wheel to start the windscreen and headlamp washers.
  - > The windscreen wipers will make several more sweeps once the stalk switch has been released.

### **!** IMPORTANT

Avoid activating the washer system when it is frozen or the washer reservoir is empty, otherwise there is a risk of damaging the pump.

### Headlamp washing\*

To save fluid, the headlamps are washed automatically at a defined interval when the headlamps are switched on.

### Reduced washing

If only approx. 1 litre (1 qt) of washer fluid remains in the reservoir and the message **Washer fluid Level low, refill**, together with the

 symbol, is shown in the driver display, then the supply of washer fluid to the headlamps is switched off. This is to prioritise cleaning the windscreen and the visibility through it. The headlamps are only washed if main or dipped beam is switched on.

### Related information

- Using the rain sensor (p. 171)
- Using automatic rear windscreen wiping when reversing (p. 175)
- Wiper blades and washer fluid (p. 170)
- Using the rain sensor's memory function (p. 172)
- Using the rear window wiper and washer (p. 174)



- Filling washer fluid (p. 641)
- Wiper blades in service position (p. 640)
- Replacing windscreen wiper blades (p. 639)
- Replacing the wiper blade, rear window (p. 638)
- Using windscreen wipers (p. 170)

### Using the rear window wiper and washer



Rear window wiper and washer clean the rear window. Washing/wiping is started and settings are changed by means of the right-hand steering wheel stalk switch.

### Activating the rear window wiper and washer

#### NOTE

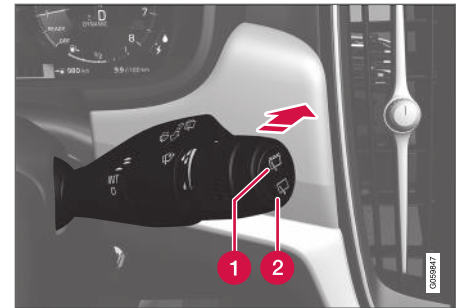
The rear window wiper motor is equipped with overheating protection which means that it is switched off if it overheats. The rear window wiper works again after a cooling-down period.



- 1 Select  for intermittent wiping with the rear window wiper.
  - 2 Select  for continuous speed with the rear window wiper.
- Move the right-hand steering wheel stalk switch forward to start rear window washing and wiping.

### Related information

- Using the rain sensor (p. 171)
- Using windscreen and headlamp washers (p. 173)
- Using automatic rear windscreen wiping when reversing (p. 175)
- Using the rain sensor's memory function (p. 172)
- Wiper blades and washer fluid (p. 170)
- Filling washer fluid (p. 641)



- Wiper blades in service position (p. 640)
- Replacing windscreen wiper blades (p. 639)
- Replacing the wiper blade, rear window (p. 638)
- Using windscreen wipers (p. 170)

### Using automatic rear windscreen wiping when reversing

Engaging reverse gear while the windscreen wipers are on initiates rear window wiping. The function stops when reverse gear is disengaged.

1. Press **Settings** in the top view in the centre display.
2. Press **My Car** → **Wipers**.
3. Select **Auto Rear Wiper** to activate/deactivate wiping when reversing.

If the rear windscreen wiper is already operating at a constant speed, no change takes place when reverse gear is selected.

### Related information

- Using the rain sensor (p. 171)
- Using windscreen and headlamp washers (p. 173)
- Wiper blades and washer fluid (p. 170)
- Using the rain sensor's memory function (p. 172)
- Using the rear window wiper and washer (p. 174)
- Filling washer fluid (p. 641)
- Wiper blades in service position (p. 640)
- Replacing windscreen wiper blades (p. 639)
- Replacing the wiper blade, rear window (p. 638)

- Using windscreen wipers (p. 170)



SEATS AND STEERING WHEEL

## Manual front seat

The car's front seats have different setting options for optimum seating comfort.



- 1 Raise/lower the front edge of the seat cushion\* by pumping up/down.<sup>1</sup>
- 2 Change the length\* of the seat cushion by pulling the lever up and moving the seat cushion forward/backward by hand.
- 3 Adjust the seat forward/backward by lifting the handle and adjusting the distance to the steering wheel and pedals. Check that the seat is locked after the position has been adjusted.
- 4 Change the lumbar support\* by pressing the button upward/downward/forward/back<sup>2</sup>.

- 5 Raise/lower the seat by means of adjusting the control up/down.
- 6 Change the backrest inclination by turning the control knob.

### **⚠ WARNING**

Adjust the position of the driver's seat before setting off, never while driving. Make sure that the seat is in locked position in order to avoid personal injury in the event of heavy braking or an accident.

### Related information

- Power\* front seat (p. 179)
- Adjusting the power\* front seat (p. 179)
- Storing position for seat, door mirrors and head-up display\* (p. 180)
- Using a stored position for seat, door mirrors and head-up display\* (p. 181)
- Adjusting massage settings\* in the front seat (p. 183)
- Adjusting\* the length of the seat cushion in the front seat (p. 184)
- Massage settings\* in the front seat (p. 182)
- Adjusting the side support\* in the front seat (p. 185)

- Adjusting the lumbar support\* in the front seat (p. 185)
- Adjusting the passenger seat from the driver's seat\* (p. 187)

<sup>1</sup> Only applies to the driver's seat.

<sup>2</sup> Applicable to four-way lumbar support\*. Two-way lumbar support\* is adjusted forwards/backwards.

## Power\* front seat

The car's front seats have different setting options for optimum seating comfort. The power seat can be moved forwards/backwards and upwards/downwards. The front edge of the seat cushion can be raised/lowered as well as adjusted in length\* and the backrest inclination can be changed. The lumbar support\* can be adjusted upward/downward/forward/backward.<sup>3</sup>

Seat setup can take place when the engine is running and within a certain time after unlocking the door without the engine running. Adjustment can also be performed within a certain time after the engine has been switched off.

### ! IMPORTANT

The power seats have overload protection that is triggered if any seat is blocked by an object. If this happens, remove the object and then move the seat again.

## Related information

- Manual front seat (p. 178)
- Adjusting the power\* front seat (p. 179)
- Storing position for seat, door mirrors and head-up display\* (p. 180)
- Using a stored position for seat, door mirrors and head-up display\* (p. 181)

- Adjusting massage settings\* in the front seat (p. 183)
- Adjusting\* the length of the seat cushion in the front seat (p. 184)
- Massage settings\* in the front seat (p. 182)
- Adjusting the side support\* in the front seat (p. 185)
- Adjusting the lumbar support\* in the front seat (p. 185)
- Adjusting the passenger seat from the driver's seat\* (p. 187)

## Adjusting the power\* front seat

Set the preferred seat position using the control on the front seat's seating section. To set the various comfort functions, turn the multifunction control<sup>4</sup> up/down.

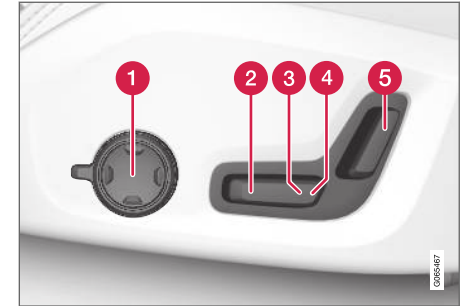

The illustration shows the controls from a car with four-way lumbar support\*. Cars with two-way lumbar support\* do not have the rotatable multifunction control.

- 1 In cars with four-way lumbar support\*, turn the multifunction control<sup>4</sup> up/down to set the different comfort functions. In cars with two-way lumbar support\*, use the round button to adjust the lumbar support forward/backward.
- 2 Raise/lower the seat cushion front edge by adjusting the control up/down.
- 3 Raise/lower the seat by means of adjusting the control up/down.

<sup>3</sup> Applicable to four-way lumbar support\*. Two-way lumbar support\* is adjusted forwards/backwards.

- ◀ 4 Move the seat forward/backward by adjusting the control forward/backward.
- 5 Change the backrest inclination by adjusting the control forward/backward.

Only one movement (forward/back/up/down) can be made at a time.

The backrests of the front seats cannot be lowered fully forward.

### Related information

- Manual front seat (p. 178)
- Power\* front seat (p. 179)
- Storing position for seat, door mirrors and head-up display\* (p. 180)
- Using a stored position for seat, door mirrors and head-up display\* (p. 181)
- Adjusting massage settings\* in the front seat (p. 183)
- Adjusting\* the length of the seat cushion in the front seat (p. 184)
- Massage settings\* in the front seat (p. 182)
- Adjusting the side support\* in the front seat (p. 185)
- Adjusting the lumbar support\* in the front seat (p. 185)
- Adjusting the passenger seat from the driver's seat\* (p. 187)

<sup>4</sup> Not available in cars with two-way lumbar support\*.

## Storing position for seat, door mirrors and head-up display\*

You can store the position for power\* seat, door mirrors and head-up display\* in the memory buttons.

Store two different positions for the power\* seat, the door mirrors and the head-up display\* using the memory buttons. The buttons are located on the inside of one of the front doors or both\*.

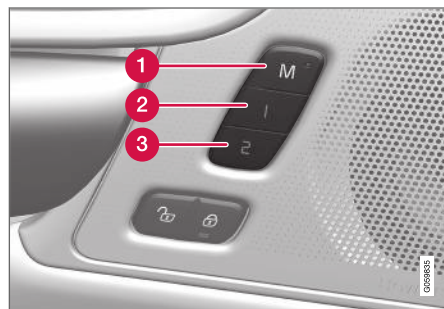

- 1 Button **M** for storing settings.
- 2 Memory button.
- 3 Memory button.

## Storing a position

1. Adjust seat, door mirrors and head-up display to the desired position.
2. Press and hold the **M** button depressed. The light indicator in the button illuminates.
3. Within three seconds, press and hold the **1** or **2** button.
  - > When the position has been stored in the selected memory button, an acoustic signal can be heard and the light indicator in the **M** button extinguishes.

If none of the memory buttons is depressed within three seconds then the **M** button extinguishes and no storing takes place.

The seat, the door mirrors or the head-up-display must be readjusted before a new memory can be set.

## Related information

- Manual front seat (p. 178)
- Power\* front seat (p. 179)
- Adjusting the power\* front seat (p. 179)
- Using a stored position for seat, door mirrors and head-up display\* (p. 181)
- Adjusting massage settings\* in the front seat (p. 183)
- Adjusting\* the length of the seat cushion in the front seat (p. 184)

- Massage settings\* in the front seat (p. 182)
- Adjusting the side support\* in the front seat (p. 185)
- Adjusting the lumbar support\* in the front seat (p. 185)
- Adjusting the passenger seat from the driver's seat\* (p. 187)
- Angling the door mirrors (p. 165)
- Settings for head-up display\* (p. 137)

### Using a stored position for seat, door mirrors and head-up display\*

If the positions for the power\* seat, the door mirrors and the head-up display\* have been stored, they can be activated simply by using the memory buttons.

#### Using a stored setting

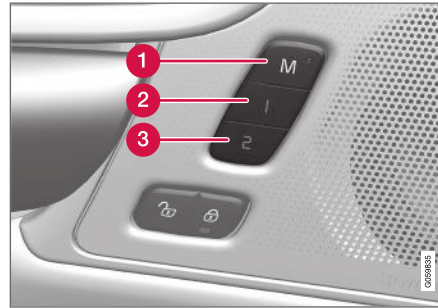

A stored setting can be used with the front door either open or closed:

#### Open front door

- Depress one of the memory buttons **1** (2) or **2** (3) with a short press. Power seat, door mirrors and head-up display move and then stop at the positions stored in the selected memory button.

#### Closed front door

- Hold one of the memory buttons **1** (2) or **2** (3) depressed until seat, door mirrors and head-up display stop in the positions that are stored in the selected memory button.

If the memory button is released, the movement of the seat, door mirrors and head-up display will be stopped.

#### **⚠ WARNING**

- Because the driver's seat can be adjusted with the ignition off, children should never be left unattended in the vehicle.
- Movement of the seat can be STOPPED at any time by pressing any button on the power seat control panel.
- Do not adjust the seat while driving.
- Make sure there is nothing under the seats when they are being adjusted.

#### Related information

- Manual front seat (p. 178)
- Power\* front seat (p. 179)
- Adjusting the power\* front seat (p. 179)
- Storing position for seat, door mirrors and head-up display\* (p. 180)
- Adjusting massage settings\* in the front seat (p. 183)



- Adjusting\* the length of the seat cushion in the front seat (p. 184)
- Massage settings\* in the front seat (p. 182)
- Adjusting the side support\* in the front seat (p. 185)
- Adjusting the lumbar support\* in the front seat (p. 185)
- Adjusting the passenger seat from the driver's seat\* (p. 187)
- Angling the door mirrors (p. 165)
- Settings for head-up display\* (p. 137)

### Massage settings\* in the front seat

Both the multi-function control on the side of the seat and the centre display can be used in order to change the settings. The range of settings is shown in the centre display.



Multi-function control, located on the side of the seat's seating section.

### Settings for massage

The following setting options are available for massage:

- **On/Off:** Select **On/Off** in order to switch on/off the massage function.
- **Programs 1-5:** There are 5 preset massage programs. Select between **Swell**, **Tread**, **Advanced**, **Lumbar** and **Shoulder**.
- **Intensity:** Select between **Low**, **Normal** and **High**.

- **Speed:** Select between **Slow**, **Normal** and **Fast**.

### Restarting massage

The massage function is deactivated automatically after 20 minutes. Reactivation of the function is performed manually.

- Tap on **Restart**, which is shown in the centre display, to restart the selected massage program.
  - > The message program restarts. If no action is taken, the message remains shown in the top view.

### Related information

- Manual front seat (p. 178)
- Power\* front seat (p. 179)
- Adjusting the power\* front seat (p. 179)
- Storing position for seat, door mirrors and head-up display\* (p. 180)
- Using a stored position for seat, door mirrors and head-up display\* (p. 181)
- Adjusting massage settings\* in the front seat (p. 183)
- Adjusting\* the length of the seat cushion in the front seat (p. 184)
- Adjusting the side support\* in the front seat (p. 185)



- Adjusting the lumbar support\* in the front seat (p. 185)
- Adjusting the passenger seat from the driver's seat\* (p. 187)

### Adjusting massage settings\* in the front seat

Both the multi-function control on the seat and the centre display can be used in order to change the settings. The range of settings is shown in the centre display.

### Adjusting massage settings in the front seat

The front seat has massage in the backrest. The massage is performed by air cushions that can massage with different settings.

The massage function can only be activated when the car's engine is running.

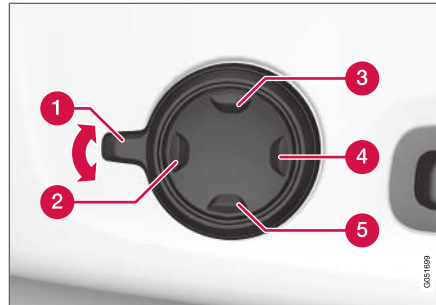

1. Activate the multi-function control by turning the control **1** upwards/downwards. The seat settings view will be shown in the centre display.

2. Select **Massage** in the seat settings view.
3. To choose between the different massage functions, select either directly in the centre display or by moving the cursor up/down using the multi-function control's upper **3** / lower **5** button. Change the setting in the selected function directly in the centre display, by pressing the arrows, or by using the multi-function control's front **2**/rear **4** button.

### Related information

- Manual front seat (p. 178)
- Power\* front seat (p. 179)
- Adjusting the power\* front seat (p. 179)
- Storing position for seat, door mirrors and head-up display\* (p. 180)
- Using a stored position for seat, door mirrors and head-up display\* (p. 181)
- Adjusting\* the length of the seat cushion in the front seat (p. 184)
- Massage settings\* in the front seat (p. 182)
- Adjusting the side support\* in the front seat (p. 185)
- Adjusting the lumbar support\* in the front seat (p. 185)
- Adjusting the passenger seat from the driver's seat\* (p. 187)

## Adjusting\* the length of the seat cushion in the front seat

Depending on equipment level selected, seat cushion length is adjusted either using the multi-function control\* on the side of the seat's seat cushion, or manually using a control on the front of the seat cushion.

### Adjusting the length of the seat cushion using the multifunction control

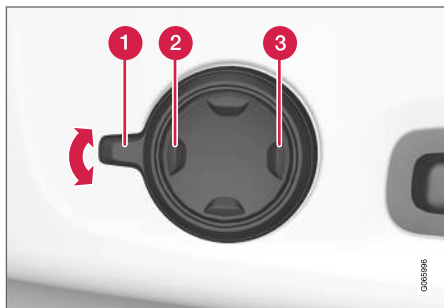

Multifunction control, located on the side of the seat cushion.

1. Activate the multi-function control by turning the control **1** upwards/downwards. The seat settings view will be shown in the centre display.

2. Select **Cushion extension** in the seat settings view.
  - Press the front section of the four-way button **2** to extend the seat cushion.
  - Press the rear section of the four-way button **3** to retract the seat cushion.

### Adjusting the length of the seat cushion manually



Control for seat cushion adjustment.

1. Grip the handle **1** on the front of the seat and pull upwards.
2. Adjust the length of the seat cushion.
3. Release the handle and make sure that the seat cushion has reached the correct position.

### Related information

- Manual front seat (p. 178)
- Power\* front seat (p. 179)
- Adjusting the power\* front seat (p. 179)
- Storing position for seat, door mirrors and head-up display\* (p. 180)
- Using a stored position for seat, door mirrors and head-up display\* (p. 181)
- Adjusting massage settings\* in the front seat (p. 183)
- Massage settings\* in the front seat (p. 182)
- Adjusting the side support\* in the front seat (p. 185)
- Adjusting the lumbar support\* in the front seat (p. 185)
- Adjusting the passenger seat from the driver's seat\* (p. 187)

## Adjusting the side support\* in the front seat

Increase comfort in the front seat by adjusting the sides of the backrest.

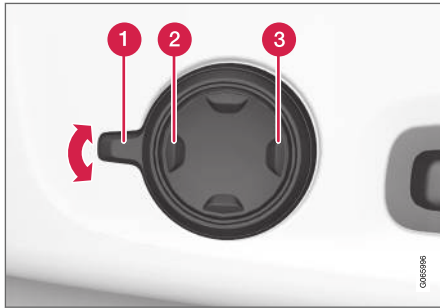

Multi-function control, located on the side of the seat's seating section.

The sides of the backrest can be adjusted to provide side support. Both the multi-function control on the seat and the centre display can be used in order to change the settings. The range of settings is shown in the centre display.

To adjust the side support:

1. Activate the multi-function control by turning the it up/down **1**. The seat settings view will be shown in the centre display.
2. Select **Side bolsters** in the seat settings view.
  - Press the front section of the four-way button to increase side support **2**.
  - Press the rear section of the four-way button to decrease side support **3**.

### Related information

- Manual front seat (p. 178)
- Power\* front seat (p. 179)
- Adjusting the power\* front seat (p. 179)
- Storing position for seat, door mirrors and head-up display\* (p. 180)
- Using a stored position for seat, door mirrors and head-up display\* (p. 181)
- Adjusting massage settings\* in the front seat (p. 183)
- Adjusting\* the length of the seat cushion in the front seat (p. 184)
- Massage settings\* in the front seat (p. 182)
- Adjusting the lumbar support\* in the front seat (p. 185)
- Adjusting the passenger seat from the driver's seat\* (p. 187)

## Adjusting the lumbar support\* in the front seat

The lumbar support is adjusted using a control on the side of the seat cushion.



Multifunction control in cars with four-way lumbar support\*.



Control in cars with two-way lumbar support\*.



- ◀◀ The lumbar support is adjusted using the multi-function control in cars with four-way lumbar support\*, or using the round button in cars with two-way lumbar support\*. The control is located on the side of the seat's seating section. Depending on the equipment level selected, the lumbar support can be adjusted forward/back and up/down (four-way lumbar support) or forward/back (two-way lumbar support).

### Adjust the lumbar support in the car using the four-way lumbar support

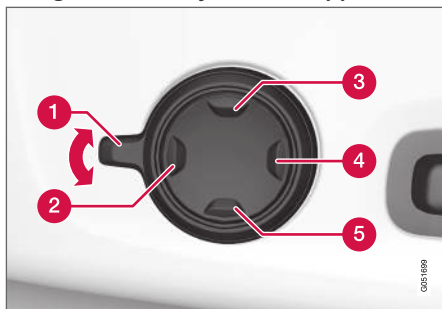

1. Activate the multi-function control by turning the control **1** upwards/downwards. The seat settings view will be shown in the centre display.

2. Select **Lumbar** in the seat settings view.

- Press the round button up **3**/down **5** to move the lumbar support upwards/downwards.
- Press the front section **2** of the button to increase lumbar support.
- Press the rear section **4** of the button to decrease lumbar support.

### Adjust the lumbar support in the car using the two-way lumbar support

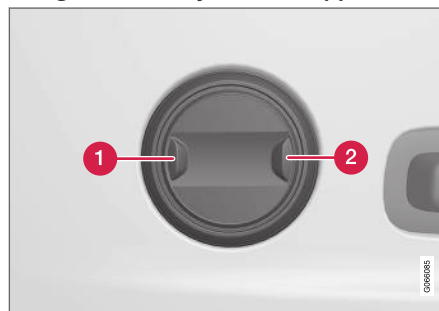

1. Press the front section **1** of the round button to increase lumbar support.
2. Press the rear section **2** of the round button to decrease lumbar support.

### Related information

- Manual front seat (p. 178)
- Power\* front seat (p. 179)
- Adjusting the power\* front seat (p. 179)
- Storing position for seat, door mirrors and head-up display\* (p. 180)
- Using a stored position for seat, door mirrors and head-up display\* (p. 181)
- Adjusting massage settings\* in the front seat (p. 183)
- Adjusting\* the length of the seat cushion in the front seat (p. 184)
- Massage settings\* in the front seat (p. 182)
- Adjusting the side support\* in the front seat (p. 185)
- Adjusting the passenger seat from the driver's seat\* (p. 187)

## Adjusting the passenger seat from the driver's seat\*

The front passenger seat can be adjusted from the driver's seat.

### Activating the function

The function is activated via the function view in the centre display:



Press the **Adjust Passenger Seat** button to activate.

### Adjust passenger seat

From activation of the function, the driver must adjust the passenger seat within 10 seconds. If no adjustment is made within this time the function is deactivated.

The driver adjusts the passenger seat using the controls on the driver's seat:

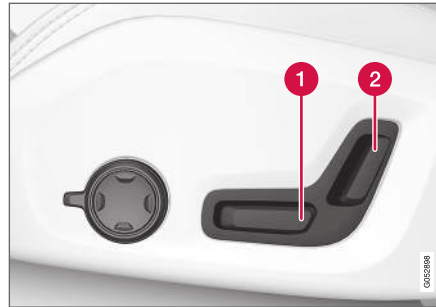

- 1 Move the passenger seat forward/backward by adjusting the control forward/backward.
- 2 Change the passenger seat's backrest inclination by adjusting the control forward/backward.

### Related information

- Manual front seat (p. 178)
- Power\* front seat (p. 179)
- Adjusting the power\* front seat (p. 179)
- Storing position for seat, door mirrors and head-up display\* (p. 180)
- Using a stored position for seat, door mirrors and head-up display\* (p. 181)
- Adjusting massage settings\* in the front seat (p. 183)
- Adjusting\* the length of the seat cushion in the front seat (p. 184)

- Massage settings\* in the front seat (p. 182)
- Adjusting the side support\* in the front seat (p. 185)
- Adjusting the lumbar support\* in the front seat (p. 185)

## Lowering the backrests in the rear seat

The rear seat's backrest is divided into two parts. The two parts can be folded forward individually.

### **⚠ WARNING**

- Adjust the seat and fix it before driving away. Take care when adjusting the seat. Uncontrolled or careless adjustment can lead to trapping injuries.
- When loading long objects, they must always be strapped in securely to avoid injury and damage during sudden braking.
- Always switch off the engine and apply the parking brake when loading and unloading the car.
- For cars with automatic gearbox, set the gear selector in **P** to prevent it from being moved by mistake.

### **⚠ IMPORTANT**

There must be no objects on the rear seat when the backrest is to be folded down. The seat belts must not be connected either. Otherwise there is a risk of damaging the rear seat upholstery.

### **⚠ IMPORTANT**

The armrest\* for the centre seat must be raised before lowering the seat.

The through-load hatch in the rear seat must be closed before lowering.

### **ⓘ NOTE**

The front seats may need to be pushed forwards, and/or the backrests adjusted upwards, in order that the rear backrests can be fully folded forward.

## Lowering the backrest in a car using electronically-controlled lowering\*

If the car is equipped with electronic lowering of the rear seat, you can lower the seat using the buttons located in the cargo area. It is also possible to fold down the rear seat using handles on the top of the seat.

### **⚠ WARNING**

Pay attention that people are not at risk of being trapped during the automatic folding of the rear seat. Since this takes place automatically on the press of a button, no one must be on or too close to the rear seat.

## Lowering the backrest using buttons in the cargo area

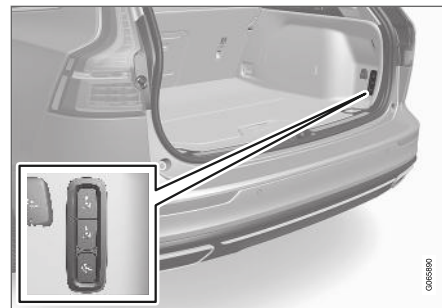

To facilitate folding of the rear seat, the car must be stationary and the tailgate open. Ensure that there are no occupants or objects in the rear seat.

1. Lower the centre seat's head restraint manually.
2. Hold the button for folding depressed. The buttons are marked **L** and **R** for left and right-hand backrest sections respectively.
3. The backrests release from the locks. The head restraints are lowered first, then the backrests are lowered automatically to horizontal position.

### Lowering the backrests using handles in the rear seat

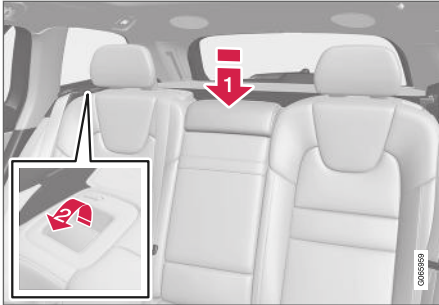

Ensure that there are no occupants or objects in the rear seat.

- 1 Lower the centre seat's head restraint manually.
- 2 Pull the handles located on the car's left and right-hand backrests forwards to fold down the left and right-hand part of the rear seat respectively.
  - > The backrests release from the locks. The head restraints are lowered first, then the backrests are lowered automatically to horizontal position.

### Lowering the backrests manually

If the car only allows the rear seat to be folded down manually, fold down the right and left-hand

sides of the seat with the handles in the rear seat.

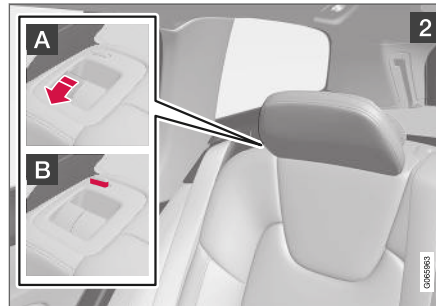
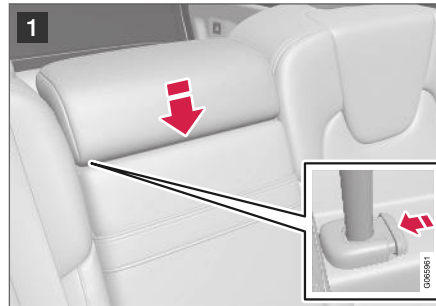

Ensure that there are no occupants or objects in the rear seat.

- 1 Lower the centre seat's head restraint manually.

- 2 Pull up the backrest's locking handle **A** while folding the backrest forward at the same time. The locking handle for the head restraints is pulled up automatically when the backrest is folded. A red indicator on the lock catch **B** shows that the backrest is no longer locked in place.

### **i** NOTE

When the backrests are lowered, the head restraints can accommodate the seat cushion of the seat being lowered. Adjust the head restraints on the seat being lowered to avoid material damage.

3. The backrest disengages from the lock and needs to be lowered manually to the horizontal position.

### Raising the backrest

Raising the backrest to upright position is carried out manually:

1. Move the backrest up/back.
2. Press the backrest until the lock engages.
3. Raise the head restraints manually.

- ◀ 4. If necessary, raise the centre seat's head restraint.

### WARNING

When the backrest has been raised, the red indicator should no longer be showing. If it is still showing then the backrest is not locked in place.

### WARNING

Check that the backrests and head restraints in the rear seat are locked properly after being folded up.

The head restraints of the outer seats must always be raised when there are passengers on any of the rear seats.

### Related information

- Adjusting the head restraints in the rear seat (p. 190)
- Private locking (p. 271)
- Activating and deactivating private locking (p. 271)

### Adjusting the head restraints in the rear seat

Adjust the centre seat head restraint according to the height of the passenger. Fold down the outer seat head restraints\* to improve rearward visibility.

### Adjust the head restraint for the centre seat

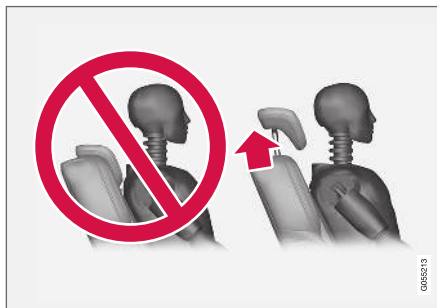

The centre seat's head restraint must be adjusted according to the passenger's height so that, if possible, the whole of the back of the head is covered. Slide it up manually as required.

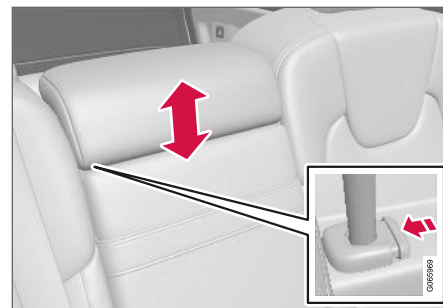

To lower the head restraint, the button (see illustration) must be depressed while the restraint is carefully moved down.

### WARNING

The centre seat head restraint must be in its lowest position when the centre seat is not used. When the centre seat is used, the head restraint must be correctly adjusted to the height of the passenger so that it covers the whole of the back of the head if possible.

### Fold down the rear seat's outer head restraints via the centre display\*

The outer head restraints can be retracted via the centre display's function view. You can lower the head restraints in ignition position **0**.





Press the **Headrest Fold** button to activate/deactivate lowering.

Move the head restraint back manually until a click is heard.

### **WARNING**

Do not lower the outer head restraints if there are passengers in any of the outer rear seats.

### **WARNING**

The head restraint must be in locked position after being folded up.

### Fold down the rear seat's outer head restraints using handles

For cars with electronically controlled rear seat folding\*, the outer head restraints can be folded using handles on the top side of the seat, see figure **1**. For cars without electronic folding, the outer head restraints are folded manually using the inner control on the upper side of the seat; see figure **2**.



### Related information

- Lowering the backrests in the rear seat (p. 188)

## Steering wheel controls and horn

The steering wheel houses the horn and controls for e.g. the driver support systems and voice recognition.

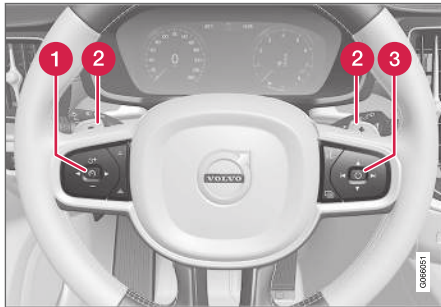

Keypads and paddles\* in the steering wheel.

- 1 Controls for driver support systems<sup>5</sup>
- 2 Paddle shifter\* for manual gear changing in an automatic gearbox.
- 3 Controls for voice recognition and menu, message and phone handling.

## Horn



The horn is located in the centre of the steering wheel.

## Related information

- Steering lock (p. 192)
- Adjusting the steering wheel (p. 193)

## Steering lock

The steering wheel lock makes it difficult to steer the car if it is stolen, for example. A mechanical noise can be perceived when the steering lock is locked or unlocked.

## Activating the steering lock

The steering lock is activated when the car is locked from the outside and the engine is switched off. If the car is left unlocked then the steering lock will be activated automatically after a while.

## Deactivating the steering lock

The steering lock is deactivated when the car is unlocked from outside. If the car is not locked, the steering wheel lock will be deactivated as long as the remote control key is in the passenger compartment and the car is started.

## Related information

- Steering wheel controls and horn (p. 192)
- Adjusting the steering wheel (p. 193)

<sup>5</sup> Speed Limiter, Cruise Control, Adaptive Cruise Control\*, Distance Warning\* and Pilot Assist.

## Adjusting the steering wheel

The steering wheel can be adjusted in different positions.

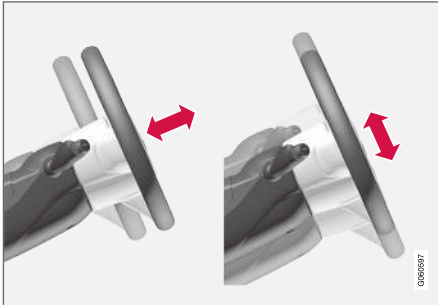

The steering wheel can be adjusted for height and for depth.

The steering wheel is adjusted in different ways depending on whether or not the car is equipped with knee airbag<sup>6</sup>.

### **⚠ WARNING**

Adjust the steering wheel and fix it before driving away. The steering wheel must never be adjusted while driving.

With speed related power steering the level of steering force can be adjusted. Steering force is

regulated according to the car's speed in order to give the driver enhanced road responsiveness.

## Adjusting the steering wheel in a car with a knee airbag

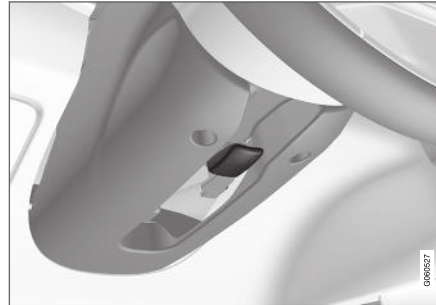

Lever for steering wheel adjustment.

1. Push the lever forwards to release the steering wheel.
2. Adjust the steering wheel to the position that suits you.
3. Pull the lever back to fix the steering wheel in place. If the lever is stiff, press the steering wheel lightly at the same time as you move the lever back.

## Adjusting the steering wheel in a car without a knee airbag



Lever for steering wheel adjustment.

1. Pull the lever backwards to release the steering wheel.
2. Adjust the steering wheel to the position that suits you.
3. Push the lever forwards to secure the steering wheel. If the lever is stiff, press the steering wheel lightly at the same time as you move the lever back.

### Related information

- Steering lock (p. 192)
- Steering wheel controls and horn (p. 192)
- Adjusting the power\* front seat (p. 179)

<sup>6</sup> The car is only equipped with knee airbag in certain markets.



CLIMATE

## Climate

The car is equipped with electronic climate control. The climate control system cools or heats as well as dehumidifies the air in the passenger compartment.

All climate control system functions are controlled from the centre display and physical buttons in the centre console.

Some functions for the rear seat can also be controlled from the climate controls\* at the rear of the tunnel console.

### Related information

- Climate zones (p. 196)
- Climate control - sensors (p. 196)
- Perceived temperature (p. 197)
- Controlling climate control with voice recognition (p. 197)
- Parking climate (p. 219)
- Heater (p. 228)
- Air quality (p. 198)
- Air distribution (p. 201)
- Climate controls (p. 207)

## Climate zones

The number of climate zones that the car is divided into governs the options for setting different temperatures for different parts of the passenger compartment.

### 2-zone climate

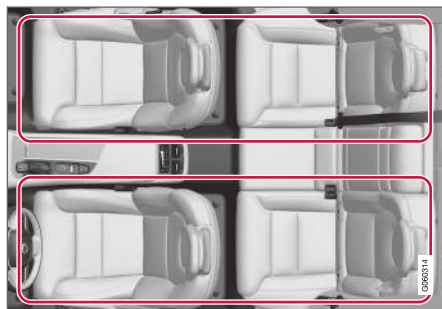

Climate zones with 2-zone climate.

With 2-zone climate, the temperature in the passenger compartment can be set separately for the left and right-hand sides.

### Related information

- Climate (p. 196)

## Climate control - sensors

The climate control system has a number of sensors to help control the climate in the car.

### Sensor location

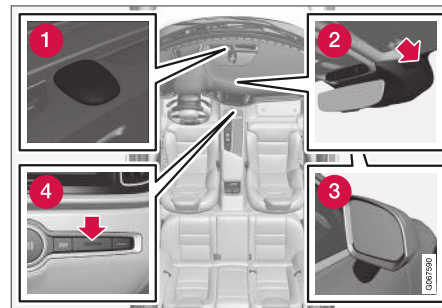

- 1 Sun sensor - on the upper side of the instrument panel.
- 2 Moisture sensor - in the casing by the interior rearview mirror.
- 3 Outside temperature sensor - in the right-hand door mirror.
- 4 Temperature sensor for the passenger compartment - by the physical buttons in the centre console.

### **i** NOTE

Do not cover or block the sensors with clothing or other objects.

With the Interior Air Quality System\* there is also an air quality sensor that is fitted into the climate control system air intake.

### Related information

- Climate (p. 196)
- Interior Air Quality System\* (p. 200)

## Perceived temperature

The climate control system regulates the climate in the passenger compartment based on the perceived temperature, not on actual temperature.

The temperature you select in the passenger compartment corresponds to the physically perceived temperature as affected by factors such as the ambient temperature, air speed, humidity, solar radiation, etc. in and around the car at the time.

The system includes a sun sensor which detects on which side the sun is shining into the passenger compartment. This means that the temperature can differ between the right and left-hand side's air vents despite the controls being set for the same temperature on both sides.

### Related information

- Climate (p. 196)

## Controlling climate control with voice recognition<sup>1</sup>

Voice recognition commands for the climate control system to e.g. change temperature, activate a heated seat\* or change fan level.

Press  and say one of the following commands:

- **"Climate"** - starts a dialogue for climate control and shows examples of commands.
- **"Set temperature to X degrees"** - sets the desired temperature.
- **"Raise temperature"/"Lower temperature"** - raise/lower the temperature setting one step.
- **"Sync temperature"** - synchronises the temperature for all climate zones in the car with the temperature set for the driver's side.
- **"Air on feet"/"Air on body"** - opens the desired air flow.
- **"Air on feet off"/"Air on body off"** - closes the desired air flow.
- **"Set fan to max"/"Turn off fan"** - changes the air flow to **Max/Off**.
- **"Raise fan speed"/"Lower fan speed"** - raises/lowers the fan level one step.
- **"Turn on auto"** - activates automatic regulation of the climate control.

<sup>1</sup> Applies to certain markets.

- ◀◀ ● **"Air condition on"/"Air condition off"** - activates/deactivates the air conditioning.
- **"Recirculation on"/"Recirculation off"** - activates/deactivates the air circulation.
- **"Turn on defroster"/"Turn off defroster"** - activates/deactivates defrosting of windows and door mirrors.
- **"Turn on max defroster"/"Turn max defroster off"** - activates/deactivates the max defroster.
- **"Turn on electric defroster"/"Turn off electric defroster"** - activates/deactivates the heated windscreen\*.
- **"Turn on rear defroster"/"Turn off rear defroster"** - activates/deactivates the heated rear window and door mirrors.
- **"Turn steering wheel heat on"/"Turn steering wheel heat off"** - activates/deactivates the heated steering wheel\*.
- **"Raise steering wheel heat"/"Lower steering wheel heat"** - raises/lowers the setting for the heated steering wheel\* one step.
- **"Turn on seat heat"/"Turn off seat heat"** - activates/deactivates the heated seat\*.
- **"Raise seat heat"/"Lower seat heat"** - raises/lowers the setting for the heated seat\* one step.
- **"Turn on seat ventilation"/"Turn off seat ventilation"** - activates/deactivates the seat ventilation\*.
- **"Raise seat ventilation"/"Lower seat ventilation"** - raises/lowers the setting for the ventilated seat\* one step.

#### Related information

- Climate (p. 196)
- Voice recognition (p. 138)
- Using voice recognition (p. 139)
- Settings for voice recognition (p. 142)

## Air quality

The materials selected for the passenger compartment and the air cleaning system ensure that the air quality in the passenger compartment is high.

### Materials in the passenger compartment

The interior of the passenger compartment is designed to be pleasant and comfortable, even for people with contact allergies and for asthma sufferers.

Tested materials have been developed in order to minimise the quantity of dust in the passenger compartment and to contribute to making the passenger compartment easier to keep clean.

The carpets in both the passenger compartment and the cargo area are removable and easy to remove and clean.

Use cleaning agents and car care products recommended by Volvo to clean the interior.

### Air cleaning system

In addition to the passenger compartment filter, Clean Zone Interior Package\* and the Interior Air Quality System\* also help to maintain high air quality in the passenger compartment.

#### Related information

- Climate (p. 196)
- Clean Zone\* (p. 199)



- Clean Zone Interior Package\* (p. 200)
- Interior Air Quality System\* (p. 200)
- Passenger compartment filter (p. 201)

### Clean Zone\*

The Clean Zone function checks and indicates whether or not all conditions have been met for good air quality in the passenger compartment.

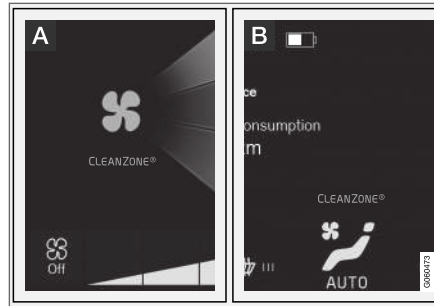

**A** The indicator is visible in the climate view in the centre display.

**B** The indicator is visible in the climate row when the climate view is not open.

If the conditions have not been met then the **Clean Zone** text is white. When all conditions have been met, this is indicated by the text changing colour to blue.

Conditions that need to be met:

- That all doors and the tailgate are closed.
- That all side windows and the panorama roof\* are closed.

- That the air quality system Interior Air Quality System\* is activated.
- That the ventilation fan is activated.
- That the air recirculation is deactivated.

#### **i** NOTE

Clean Zone does not indicate that the air quality is good. It only indicates that the conditions for good air quality have been met.

#### Related information

- Air quality (p. 198)
- Clean Zone Interior Package\* (p. 200)
- Interior Air Quality System\* (p. 200)
- Passenger compartment filter (p. 201)

### Clean Zone Interior Package\*

Clean Zone Interior Package (CZIP) comprises a series of modifications that keep the passenger compartment even clearer from allergy and asthma-inducing substances.

The following is included:

- An enhanced fan function that means that the fan starts when the car is unlocked with the remote control key. The fan fills the passenger compartment with fresh air. The function starts when required and is disengaged automatically after a time or when one of the passenger compartment doors is opened. The amount of time the fan runs is reduced gradually due to reduced need up until the car is 4 years old.
- The fully automatic air quality system Interior Air Quality System (IAQS).

#### Related information

- Air quality (p. 198)
- Clean Zone\* (p. 199)
- Interior Air Quality System\* (p. 200)
- Passenger compartment filter (p. 201)

### Interior Air Quality System\*

Interior Air Quality System (IAQS) is a fully automatic air quality system that separates gases and particles to reduce the levels of odours and contaminants in the passenger compartment.

IAQS is a part of the Clean Zone Interior Package (CZIP) and cleans the air in the passenger compartment from contaminants such as particles, hydrocarbons, nitrous oxides and ground-level ozone.

If the air quality sensor senses that the outside air is contaminated, the air intake is closed and air recirculation is activated.

#### NOTE

The air quality sensor must always be enabled to ensure the best air in the passenger compartment.

In a cold climate recirculation is limited so as to prevent misting.

In the event of misting, the defrost functions for windscreen, side windows and rear window should be used.

#### Related information

- Activating and deactivating the air quality sensor\* (p. 201)
- Air quality (p. 198)
- Clean Zone\* (p. 199)

- Clean Zone Interior Package\* (p. 200)
- Passenger compartment filter (p. 201)

## Activating and deactivating the air quality sensor\*

The air quality sensor is part of the fully automatic air quality system Interior Air Quality System (IAQS).

It is possible to set whether the air quality sensor should be activated/deactivated.

1. Press **Settings** in the top view in the centre display.
2. Press **Climate**.
3. Select **Air Quality Sensor** to activate/deactivate the air quality sensor.

### Related information

- Interior Air Quality System\* (p. 200)

## Passenger compartment filter

All air entering the car's passenger compartment is cleaned with a filter.

### Replacing the passenger compartment filter

To maintain high climate system performance, the filter must be changed at regular intervals. Follow the Volvo Service Programme for the recommended replacement intervals. If the car is used in a severely contaminated environment, it may be necessary to replace the filter more often.

#### **NOTE**

There are different types of passenger compartment filter. Make sure that the correct filter is fitted.

### Related information

- Air quality (p. 198)
- Clean Zone\* (p. 199)
- Clean Zone Interior Package\* (p. 200)
- Interior Air Quality System\* (p. 200)

## Air distribution

The climate control system distributes the incoming air via a number of different vents in the passenger compartment.

### Automatic and manual air distribution

With auto-regulated climate control running the air distribution takes place automatically. If necessary, the air distribution can be controlled manually.

### Adjustable air vents

Some of the air vents in the car are adjustable, which means that you can open/close the vent to aim the air flow.

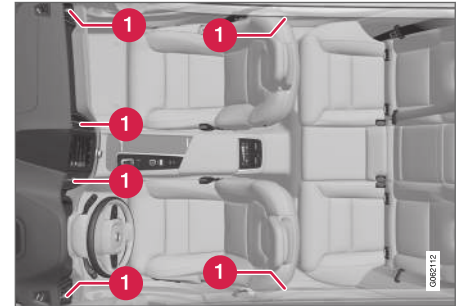

Location of adjustable air vents in the passenger compartment.

- 1 Four on the instrument panel and one on each of the door pillars between the front and rear doors.



#### ◀◀ **Related information**

- Climate (p. 196)
- Changing air distribution (p. 202)
- Opening, closing and aiming the air vents (p. 203)
- Table of air distribution options (p. 204)

### **Changing air distribution**

The air distribution can be changed manually if required.



1. Open climate view in the centre display by pressing the symbol in the middle of the climate row.

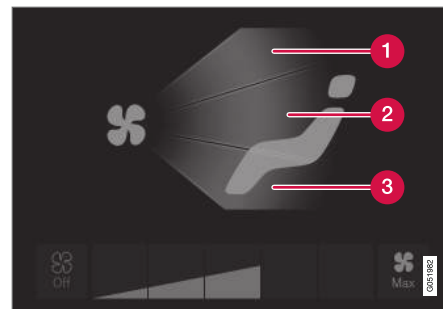

The air distribution buttons in the climate view.

- 1 Air distribution - windscreen defroster vents
  - 2 Air distribution - air vents in instrument panel and centre console
  - 3 Air distribution - air vents in the floor
2. Press one or more of the air distribution buttons in order to open/close the corresponding air flow.
    - > The air distribution is changed and the buttons illuminate/extinguish.

#### **Related information**

- Air distribution (p. 201)
- Opening, closing and aiming the air vents (p. 203)
- Table of air distribution options (p. 204)

## Opening, closing and aiming the air vents

Some air vents in the passenger compartment can be opened, closed and aimed individually.

If the car's outer vents are aimed at the side windows then misting can be eliminated.

If the car's outer vents are aimed inwards then, in a hot climate, a comfortable environment is obtained in the passenger compartment.

## Opening and closing the air vents

Air vents on the instrument panel:

- Turn the rotary knob in the middle of the air vent to open/close the air flow from the vent.  
The air flow is at maximum when the marking on the knob is in vertical position.

Air vents in the door pillars:

- Move the lever in the middle of the air vent up/down to open/close the air flow from the vent.  
The air flow is switched off in the bottom position, while it is constant in other positions.

## Aiming the air vents





- Move the lever in the middle of the air vent horizontally/vertically to direct the air flow from the vent.





## Related information

- Air distribution (p. 201)
- Changing air distribution (p. 202)
- Table of air distribution options (p. 204)

### Table of air distribution options

The air distribution can be changed manually if required. The following options are available for setting.

	Air distribution	Purpose
	<p>If all air distribution buttons are deselected in manual mode, the climate control system returns to automatically regulated climate control.</p>	
	<p>Main air flow from the defroster vents. Some air flows from other air vents.</p>	<p>Counteracts misting and icing in a cold and humid climate (to achieve this, fan level must not be low).</p>
	<p>Main air flow from the air vents in the instrument panel. Some air flows from other air vents.</p>	<p>Provides efficient cooling in a hot climate.</p>
	<p>Main air flow from the air vents at the floor. Some air flows from other air vents.</p>	<p>Provides heat or cooling to the floor.</p>

	<b>Air distribution</b>	<b>Purpose</b>
	Main air from the defroster vents and air vents in the instrument panel. Some air flows from other air vents.	Provides good comfort in hot and dry climates.
	Main air flow from the defroster vents and air vents at the floor. Some air flows from other air vents.	Provides good comfort and good demisting in a cold or humid climate.
	Main air flow from the air vents in the instrument panel and air vents at the floor. Some air flows from other air vents.	Provides good comfort in sunny weather with cool outdoor temperatures.
	Main air flow from the defroster vents, from the air vents in the instrument panel and air vents at the floor.	Gives balanced comfort in the passenger compartment.

◀◀ **Related information**

- Air distribution (p. 201)
- Opening, closing and aiming the air vents (p. 203)
- Changing air distribution (p. 202)



## Climate controls

The climate control system's functions are controlled from physical buttons in the centre console, the centre display and the climate controls at the rear of the tunnel console\*.

### Physical buttons in centre console

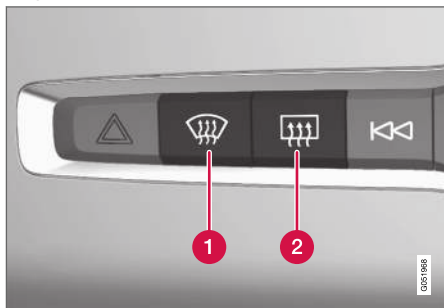

- 1 Button for heated windscreen\* and max defroster.
- 2 Button for heated rear window and door mirrors.

### Climate row in centre display

The most common climate functions can be regulated from the climate row.

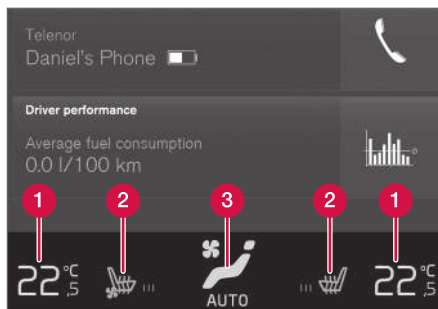

- 1 Temperature controls for driver and passenger side.
- 2 Controls for heated\* and ventilated\* driver and front passenger seat, as well as heated steering wheel\*.
- 3 Button for access to the climate view. The graphic on the button shows activated climate settings.

### Climate view in centre display



Open climate view by pressing the symbol in the middle of the climate row.

Depending on equipment level, the climate view can be divided into several tabs. Change between the tabs by swiping left/right or by pressing the respective heading.

### Main climate

In addition to the climate row's functions, other main climate functions can also be controlled in the **Main climate** tab.

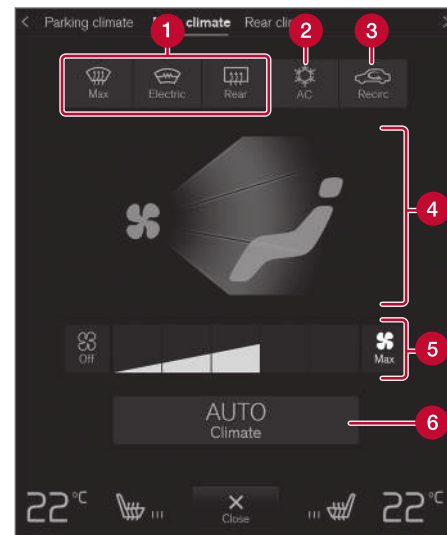

- 1 **Max, Electric, Rear** - Controls for defrosting the windows and door mirrors.
- 2 **AC** - Controls for air conditioning.
- 3 **Recirc** - Controls for air recirculation.
- 4 Controls for air distribution.

◀◀ **5** Fan control.

**6** **AUTO** - Auto regulating the climate.

### **Parking climate**

The car's parking climate control can be regulated in the **Parking climate** tab.

### **Climate controls at rear of tunnel console\***

If the car is equipped with heated rear seats\* there are physical buttons at the rear of the tunnel console for controlling this function.

### **Related information**

- Climate (p. 196)
- Activating and deactivating heated front seat\* (p. 208)
- Activating and deactivating heated rear seat\* (p. 209)
- Activating and deactivating ventilated front seat\* (p. 210)
- Activating and deactivating the heated steering wheel\* (p. 211)
- Activating auto climate control (p. 211)
- Activating and deactivating air recirculation (p. 212)
- Activating and deactivating max defroster (p. 213)
- Activating and deactivating the heated windscreen\* (p. 214)

- Activating and deactivating the heated rear window and door mirrors (p. 215)
- Regulating fan level for front seat (p. 216)
- Synchronising temperature (p. 218)
- Activating and deactivating air conditioning (p. 218)

## **Activating and deactivating heated front seat\***

The seats can be heated in order to increase comfort for driver and passengers when it is cold.



1. Press the left or right-hand side's steering wheel and seat button in the climate row in the centre display in order to open the controls for seat and steering wheel.

If the car is not equipped with ventilated seats or heated steering wheel (for the driver's side), the button for heated seats is immediately available in the climate row.



2. Repeatedly press the button for heated seats in order to change between the four levels: **Off, High, Medium** and **Low**.
  - > The level changes and the button shows the set level.

**⚠ WARNING**

Heated seats must not be used by people who find it difficult to perceive an increase in temperature due to a lack of sensation or who otherwise have problems operating the controls for the heated seats. Otherwise they may suffer burn injuries.

**Related information**

- Climate controls (p. 207)
- Activating and deactivating automatic start of heated front seat\* (p. 209)

**Activating and deactivating automatic start of heated front seat\***

The seats can be heated in order to increase comfort for driver and passengers when it is cold.

It is possible to set whether automatic start of heated seats should be activated/deactivated when the engine is started. With automatic start activated, heating will start in the event of low ambient temperature.

1. Press **Settings** in the top view in the centre display.
2. Press **Climate**.
3. Select **Auto Driver Seat Heating Level** and **Auto Passenger Seat Heating Level** to activate/deactivate automatic start of heated driver's and passenger seat.
  - > An "A" is shown at each button for heated front seats in the climate row when automatic starting has been activated.
4. Select **Low**, **Medium** or **High** to select level after the function has been activated.

**Related information**

- Climate controls (p. 207)
- Activating and deactivating heated front seat\* (p. 208)

**Activating and deactivating heated rear seat\***

The seats can be heated in order to increase comfort for driver and passengers when it is cold.

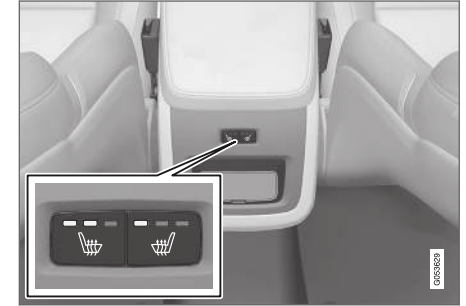
**Activating and deactivating the heated rear seat from the rear seat**

Buttons for heated seats at the rear of the tunnel console.

- Press repeatedly on the left or right-hand side's physical buttons for heated seats at the rear of the tunnel console to switch between the four levels: **Off**, **High**, **Medium** and **Low**.
  - > The level changes and the LEDs in the button show the set level.



### **WARNING**

Heated seats must not be used by people who find it difficult to perceive an increase in temperature due to a lack of sensation or who otherwise have problems operating the controls for the heated seats. Otherwise they may suffer burn injuries.

#### Related information

- Climate controls (p. 207)

### Activating and deactivating ventilated front seat\*

The seats can be ventilated to provide increased comfort in a hot climate, for example.

The ventilation system consists of fans in the seats and backrests that draw air through the seat upholstery. The cooling effect increases the cooler the passenger compartment air becomes. The system can be activated when the engine is running.



1. Press the left or right-hand side's steering wheel and seat button in the climate row in the centre display in order to open the controls for seat and steering wheel.

If the car is not equipped with heated seats or heated steering wheel (for the driver's side), the button for ventilated seats is immediately available in the climate row.



2. Repeatedly press the button for ventilated seats in order to change between the four levels: **Off**, **High**, **Medium** and **Low**.
  - > The level changes and the button shows the set level.

#### Related information

- Climate controls (p. 207)

## Activating and deactivating the heated steering wheel\*

The steering wheel can be heated in order to increase comfort for the driver when it is cold.



1. Press the driver's side steering wheel and seat button in the climate row of the centre display in order to open the controls for seat and steering wheel.

If the car is not equipped with heated seats or ventilated seats, the button for heated steering wheel is immediately available in the climate row.



2. Repeatedly press the button for heated steering wheel in order to change between the four levels: **Off**, **High**, **Medium** and **Low**.
  - > The level changes and the button shows the set level.

### Related information

- Climate controls (p. 207)
- Activating and deactivating automatic start of heated steering wheel\* (p. 211)

## Activating and deactivating automatic start of heated steering wheel\*

The steering wheel can be heated in order to increase comfort for the driver when it is cold.

It is possible to set whether automatic start of heated steering wheel should be activated/deactivated when the engine is started. With automatic start activated, heating will start in the event of low ambient temperature.

1. Press **Settings** in the top view in the centre display.
2. Press **Climate**.
3. Select **Auto Steering Wheel Heating Level** to activate/deactivate automatic start of heated steering wheel.
  - > An "A" is shown at the button for heated steering wheel in the climate row when automatic starting has been activated.
4. Select **Low**, **Medium** or **High** to select level after the function has been activated.

### Related information

- Activating and deactivating the heated steering wheel\* (p. 211)

## Activating auto climate control

With auto climate control activated, multiple climate functions are controlled automatically.



1. Open climate view in the centre display by pressing the symbol in the middle of the climate row.
2. Give a short or long press on **AUTO Climate**.
  - Short press - air recirculation, air conditioning and air distribution are controlled automatically.
  - Long press - air recirculation, air conditioning and air distribution are controlled automatically, temperature and fan speed are changed to standard settings: 22 °C (72 °F) and level **3**.
  - > Auto-regulation of the climate is activated and the button illuminates.



### **i** NOTE

Temperature and fan speed can be changed without deactivating the automatically-regulated climate control system. The automatically-regulated climate control system is deactivated when the air distribution is changed manually or when maximum defroster is activated.

### Related information

- Climate controls (p. 207)

## Activating and deactivating air recirculation

Air recirculation shuts out bad air, exhaust gases, etc. from outside the car by the climate control system reusing the air in the passenger compartment.



1. Open climate view in the centre display by pressing the symbol in the middle of the climate row.



2. Press **Recirc**.
  - > Air recirculation is activated/deactivated and the button illuminates/extinguishes.

### **!** IMPORTANT

If the air in the car is recirculated for too long then there is a risk of misting on the insides of the windows.

### **i** NOTE

It is not possible to activate air recirculation when max defroster is activated.

### Related information

- Climate controls (p. 207)
- Activating and deactivating time setting for air recirculation (p. 213)

## Activating and deactivating time setting for air recirculation

Air recirculation shuts out bad air, exhaust gases, etc. from outside the car by the climate control system reusing the air in the passenger compartment.

It is possible set whether the air recirculation timer should be activated/deactivated. When the timer is activated, air recirculation is automatically switched off after 20 minutes.

1. Press **Settings** in the top view in the centre display.
2. Press **Climate**.
3. Select **Recirculation Timer** to activate/deactivate the air recirculation timer.

### Related information

- Activating and deactivating air recirculation (p. 212)

## Activating and deactivating max defroster

Max defroster is used to quickly remove mist and ice from windows.

Max defroster deactivates auto-regulation of the climate and air recirculation, activates air conditioning and changes the fan level to **5** and the temperature to **HI**.

### NOTE

Changing the fan level to **5** increases the noise level.

When max defroster is deactivated, the climate control system returns to the previous settings.

### Activating and deactivating max defroster from centre console

There is a physical button in the centre console for quick access to max defroster.

With heated windscreen\* the max defroster can only be activated individually from the climate view in the centre display.



Physical button in the centre console.

Cars without heated windscreen:

- Press the button.
  - > Max defroster is activated/deactivated and the button illuminates/extinguishes.

Cars with heated windscreen:

- Press the button repeatedly in order to switch between the three levels:
  - Activated heated windscreen
  - Activated heated windscreen and max defroster
  - Deactivated.
- > Heated windscreen and max defroster are activated/deactivated and the button illuminates/extinguishes.





### **i** NOTE

Max defroster starts with a certain delay in order to avoid a short increase in fan level if the heated windscreen is deactivated by two quick presses of the button.

### Activating and deactivating max defroster from centre display



1. Open climate view in the centre display by pressing the symbol in the middle of the climate row.



2. Press **Max**.
  - > Max defroster is activated/deactivated and the button illuminates/extinguishes.

### Related information

- Climate controls (p. 207)

### Activating and deactivating the heated windscreen\*

A heated windscreen is used to quickly remove mist and ice from the window.

### Activating and deactivating heated windscreen from centre console

In the centre console is a physical button for rapid access to the heated windscreen.



Physical button in the centre console.

- Press the button repeatedly in order to switch between the three levels:
  - Activated heated windscreen
  - Activated heated windscreen and max defroster
  - Deactivated.
- > Heated windscreen and max defroster are activated/deactivated and the button illuminates/extinguishes.

### Activating and deactivating heated windscreen from centre display



1. Open climate view in the centre display by pressing the symbol in the middle of the climate row.



2. Press **Electric**.
  - > Heated windscreen is activated/deactivated and the button illuminates/extinguishes.

### **i** NOTE

A triangular area at the end of each side of the windscreen is not electrically heated, where de-icing may take longer.

### **i** NOTE

The heated windscreen may affect the performance of transponders and other communication equipment.



### Related information

- Climate controls (p. 207)
- Activating and deactivating automatic start of heated windscreen\* (p. 215)

### Activating and deactivating automatic start of heated windscreen\*

A heated windscreen is used to quickly remove mist and ice from the window.

It is possible to set whether automatic start of heated windscreen should be activated/deactivated when the engine is started. With automatic start activated, heating will start when there is a risk of ice or misting on the windscreen/window. The heating switches off automatically when the windscreen/window is sufficiently warm and the ice or misting is gone.

1. Press **Settings** in the top view in the centre display.
2. Press **Climate**.
3. Select **Auto Front Defroster** to activate/deactivate automatic start of heated windscreen.

### Related information

- Activating and deactivating the heated windscreen\* (p. 214)

### Activating and deactivating the heated rear window and door mirrors

The heated rear window and door mirrors are used to quickly remove mist and ice from the windows and mirrors.

### Activating and deactivating heated rear window and door mirrors from centre console

In the centre console is a physical button for rapid access to the heated rear window and door mirrors.



Physical button in the centre console.

- Press the button.
  - > Heated rear window and door mirrors are activated/deactivated and the button illuminates/extinguishes.



## ◀ Activating and deactivating heated rear window and door mirrors from centre display



1. Open climate view in the centre display by pressing the symbol in the middle of the climate row.



2. Press **Rear**.
  - > Heated rear window and door mirrors are activated/deactivated and the button illuminates/extinguishes.

### Related information

- Climate controls (p. 207)
- Activating and deactivating automatic starting of the heated rear window and door mirrors (p. 216)

## Activating and deactivating automatic starting of the heated rear window and door mirrors

The heated rear window and door mirrors are used to quickly remove mist and ice from the windows and mirrors.

It is possible to set whether automatic start of heated rear window and door mirrors should be activated/deactivated when the engine is started. With automatic start activated, heating will start when there is a risk of ice or misting on the windscreen/window. The heating switches off automatically when the windscreen/window is sufficiently warm and the ice or misting is gone.

1. Press **Settings** in the top view in the centre display.
2. Press **Climate**.
3. Select **Auto Rear Defroster** to activate/deactivate automatic start of heated rear window and door mirrors.

### Related information

- Activating and deactivating the heated rear window and door mirrors (p. 215)

## Regulating fan level for front seat<sup>2</sup>

The fan can be set to several different automatically controlled fan speeds for the front seat.



1. Open climate view in the centre display by pressing the symbol in the middle of the climate row.

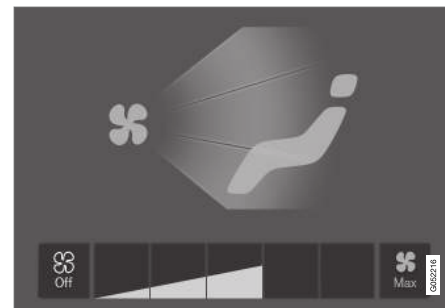

Fan control buttons in the climate view.

2. Tap on the desired fan level, **Off**, **1-5** or **Max**.
  - > Fan level is changed and the buttons for the selected level illuminate.

<sup>2</sup> For 2-zone climate, also rear seat.

**! IMPORTANT**

If the fan is fully switched off then the air conditioning is not engaged, which results in a risk of misting on the insides of the windows.

**i NOTE**

The climate control system automatically adjusts the air flow within the selected fan level based on requirements. This means that the fan speed may change even though the fan level is the same.

**Related information**

- Climate controls (p. 207)

**Regulating temperature for front seat<sup>3</sup>**

The temperature can be set to the desired number of degrees for the front seat's climate zones.



Temperature buttons in the climate row.

1. Press the left or right-hand side temperature button in the centre display's climate row to open the controls.



Temperature control.

2. Regulate the temperature by either of the following:
  - drag the control to the desired temperature, or
  - press +/– to raise/lower the temperature gradually.
    - > The temperature changes and the button shows the set temperature.

**i NOTE**

Heating or cooling cannot be hastened by selecting a higher or lower temperature than the actual desired temperature.

**Related information**

- Climate controls (p. 207)

<sup>3</sup> For 2-zone climate, also rear seat.

## Synchronising temperature

The temperature in the car's different climate zones can be synchronised with the temperature set on the driver's side.

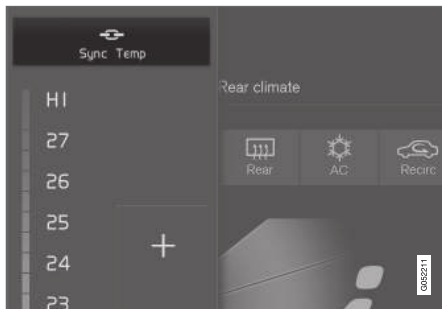

Synchronisation button on the driver's side temperature controls.

1. Press the driver's side temperature button in the centre display's climate row in order to open the controls.
2. Press **Synchronise temperature**.
  - > The temperature for all zones in the car is synchronised with the temperature set for the driver's side and the synchronisation symbol is shown adjacent to the temperature button.

The synchronisation is stopped by means of a further press on **Synchronise temperature** or by means of changing the temperature settings for a climate zone other than the driver's.

## Related information

- Climate controls (p. 207)

## Activating and deactivating air conditioning

The air conditioning cools and dehumidifies incoming air as required.

When the air conditioning is activated, the climate control system automatically controls starting and switching off as required.



1. Open climate view in the centre display by pressing the symbol in the middle of the climate row.



2. Press **AC**.
  - > The air conditioning is activated/deactivated and the button illuminates/extinguishes.

### **i** NOTE

Close all side windows and the panoramic roof\* for air conditioning to work optimally.

**i NOTE**

It is not possible to activate the air conditioning when the fan control is in **Off** position.

**Related information**

- Climate controls (p. 207)

**Parking climate**

Parking climate control is a generic term for various functions that improve the passenger compartment climate when the car is parked, e.g. preconditioning.



Functions belonging to the parking climate control are controlled from the **Parking climate** in climate view in the centre display. Open climate view by pressing the symbol in the middle of the climate row.

**Related information**

- Climate (p. 196)
- Preconditioning (p. 219)
- Climate comfort when parking (p. 225)
- Symbols and messages for parking climate control (p. 226)

**Preconditioning**

Preconditioning is a climate function which, if possible, attempts to reach comfort temperature in the passenger compartment before departure.

Preconditioning can use direct start or be set via the timer.

The function utilises several systems in different cases:

- In a cold climate, the parking heater warms up the passenger compartment to a comfortable temperature.
- The air conditioning, in a hot climate, cools the passenger compartment to the comfort temperature.
- Activation of heated steering wheel\* and heated seats\* for driver and passenger can be selected.
- Heated windscreen, rear window and door mirrors are automatically activated as required.

During preconditioning in a hot climate, condensation from the air conditioning may drip under the car. This is normal.





### **i** NOTE

Preconditioning is available only when the car is connected to an electrical socket<sup>4</sup>. A charging station which is not always active, e.g. on account of a timer, may cause preconditioning to malfunction.

If the car is not connected to an electrical socket, it is still possible to cool the passenger compartment briefly in a warm climate by starting preconditioning directly.

### **i** NOTE

During preconditioning of the passenger compartment, the car works to reach comfort temperature and not the temperature set in the climate control system.

### Related information

- Parking climate (p. 219)
- Start and switch off preconditioning (p. 220)
- Preconditioning time setting (p. 221)

## Start and switch off preconditioning

Preconditioning heats or cools the passenger compartment, if possible, prior to driving. The function can use direct start from the centre display or a mobile phone.

### Start and switch off from car



1. Open climate view in the centre display by pressing the symbol in the middle of the climate row.
2. Select the **Parking climate** tab.
3. Select whether seat heating and steering wheel heating should be activated during preconditioning by ticking/unticking the boxes for the respective function.
4. Press **Preconditioning**.
  - > Preconditioning is started/switched off and the button is illuminated/extinguished.

### **i** NOTE

Preconditioning is available only when the car is connected to an electrical socket<sup>5</sup>. A charging station which is not always active, e.g. on account of a timer, may cause preconditioning to malfunction.

If the car is not connected to an electrical socket, it is still possible to cool the passenger compartment briefly in a warm climate by starting preconditioning directly.

### **i** NOTE

The car's doors and windows should be closed during the preconditioning of the passenger compartment.

<sup>4</sup> Applicable to electric heater.

<sup>5</sup> Applicable to electric heater.

**⚠ WARNING**

Do not use preconditioning<sup>6</sup>:

- In unventilated spaces indoors. Exhaust gases are emitted if the heater starts.
- In locations with combustible or flammable material nearby. Fuel, gas, long grass, sawdust, etc. may ignite.
- When there is a risk that the heater's exhaust line may be blocked. For example, deep snow inside the front right-hand wheel housing can obstruct the heater's ventilation.

Remember that the preconditioning can be started by a timer that has been set for a long time in advance.

**Starting from the app\***

Start of preconditioning and information about the selected settings can be managed from a device that has the Volvo On Call\* app. Preconditioning heats or cools the passenger compartment (using the car's air conditioning) to comfort temperature.

The passenger compartment can also be preconditioned with the car remote start function (Engine Remote Start - ERS)<sup>7</sup> via the Volvo On Call\* app.

<sup>6</sup> Applicable to fuel-driven auxiliary heater.

<sup>7</sup> Certain markets.

<sup>8</sup> Applicable to electric heater.

**Related information**

- Parking climate (p. 219)
- Preconditioning (p. 219)
- Preconditioning time setting (p. 221)

**Preconditioning time setting**

The timer can be set so that the preconditioning is finished at a predetermined time.

The timer can handle up to 8 different settings for:

- A time on a single date
- A time on one or more days of the week, with or without repetition.

**i NOTE**

Preconditioning is available only when the car is connected to an electrical socket<sup>8</sup>. A charging station which is not always active, e.g. on account of a timer, may cause preconditioning to malfunction.

If the car is not connected to an electrical socket, it is still possible to cool the passenger compartment briefly in a warm climate by starting preconditioning directly.

**Related information**

- Preconditioning (p. 219)
- Adding and editing time setting for preconditioning (p. 222)



- Activating and deactivating time setting for preconditioning (p. 223)
- Removing time setting for preconditioning (p. 224)

### Adding and editing time setting for preconditioning

The timer for preconditioning can manage up to 8 time settings.

#### Adding a time setting

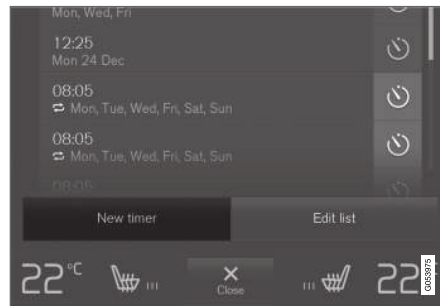

The button to add a time setting in the **Parking climate** tab in the climate view.

1. Open the climate view in the centre display.
2. Select the **Parking climate** tab.

3. Press **Add timer**.  
> A pop-up window is shown.

**i NOTE**

It is not possible to add a time setting if there already are 8 settings entered for the timer. Delete a time setting in order to be able to add a new one.

4. Tap on **Date** to set the time for a single date.  
Tap on **Days** to set the time for one or more days of the week.  
With **Days**: Activate/deactivate repetition by ticking/unticking the box for **Repeat weekly**.
5. With **Date**: Select the date for preconditioning by scrolling the date list with the arrows.  
With **Days**: Select the days of the week for preconditioning by tapping on the buttons for the days of the week.
6. Set the time when the preconditioning should be finished by scrolling with the arrows.



7. Tap on **Confirm** in order to add the time setting.
  - > The time setting is added to the list and is activated.

### **WARNING**

Do not use preconditioning<sup>9</sup>:

- In unventilated spaces indoors. Exhaust gases are emitted if the heater starts.
- In locations with combustible or flammable material nearby. Fuel, gas, long grass, sawdust, etc. may ignite.
- When there is a risk that the heater's exhaust line may be blocked. For example, deep snow inside the front right-hand wheel housing can obstruct the heater's ventilation.

Remember that the preconditioning can be started by a timer that has been set for a long time in advance.

### **Editing a time setting**

1. Open the climate view in the centre display.
2. Select the **Parking climate** tab.
3. Press the time setting that is to be changed.
  - > A pop-up window is shown.
4. Edit the time setting in the same way as described in "Adding a time setting" above.

### **Related information**

- Preconditioning (p. 219)
- Preconditioning time setting (p. 221)
- Activating and deactivating time setting for preconditioning (p. 223)
- Removing time setting for preconditioning (p. 224)

### **Activating and deactivating time setting for preconditioning**

A time setting in the timer for preconditioning can be activated or deactivated based on need.

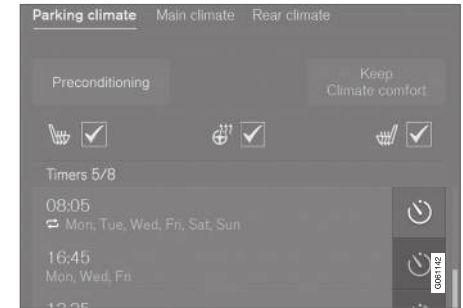

The timer buttons in the **Parking climate** tab in the climate view.

1. Open the climate view in the centre display.
2. Select the **Parking climate** tab.
3. Activate/deactivate a time setting by tapping on the timer button to the right of the setting.
  - > The time setting is activated/deactivated and the button illuminates/extinguishes.

<sup>9</sup> Applicable to fuel-driven auxiliary heater.



## ⚠ WARNING

Do not use preconditioning<sup>10</sup>:

- In unventilated spaces indoors. Exhaust gases are emitted if the heater starts.
- In locations with combustible or flammable material nearby. Fuel, gas, long grass, sawdust, etc. may ignite.
- When there is a risk that the heater's exhaust line may be blocked. For example, deep snow inside the front right-hand wheel housing can obstruct the heater's ventilation.

Remember that the preconditioning can be started by a timer that has been set for a long time in advance.

### Related information

- Preconditioning (p. 219)
- Preconditioning time setting (p. 221)
- Adding and editing time setting for preconditioning (p. 222)
- Removing time setting for preconditioning (p. 224)

## Removing time setting for preconditioning

A time setting for preconditioning that is no longer required can be deleted.

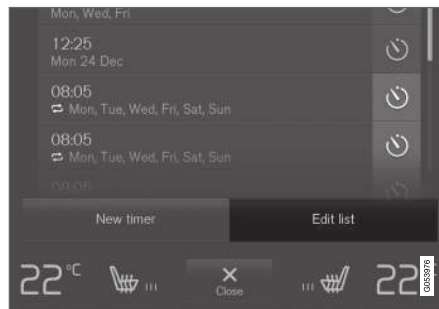

The button for editing the list/deleting the time setting in the tab **Parking climate** in the climate view.

1. Open the climate view in the centre display.
2. Select the **Parking climate** tab.
3. Press **Edit list**.
4. Press the delete icon to the right in the list.
  - > The icon changes to the text **Delete**.
5. Press **Delete** to confirm.
  - > The time setting is removed from the list.

### Related information

- Preconditioning (p. 219)
- Preconditioning time setting (p. 221)
- Adding and editing time setting for preconditioning (p. 222)
- Activating and deactivating time setting for preconditioning (p. 223)

<sup>10</sup> Applicable to fuel-driven auxiliary heater.

## Climate comfort when parking

The climate in the car's passenger compartment can be maintained while the car is parked, e.g. if the engine needs to be switched off but the driver or passenger(s) wants to remain in the car and maintain the level of climate comfort.

Starting climate comfort retention is only possible via direct start.

The function utilises several systems in different cases:

- Residual heat from the engine, in a cold climate, heats the passenger compartment to comfort temperature.
- When it is warm, the ventilation cools the passenger compartment by blowing in air from outside the car.

### **i** NOTE

Climate comfort retention is switched off when the car is locked from the outside to avoid using residual heat unnecessarily. Use of the function is intended to maintain climate comfort when driver or passengers remain inside the car.

### Related information

- Parking climate (p. 219)
- Starting and switching off climate comfort when parking (p. 225)

## Starting and switching off climate comfort when parking

Climate comfort retention maintains the climate in the passenger compartment after driving. The function can use direct start from the centre display.



1. Open climate view in the centre display by pressing the symbol in the middle of the climate row.
2. Select the **Parking climate** tab.
3. Press **Keep climate comfort**.
  - > Climate comfort retention is started/switched off and the button illuminates/extinguishes.

### **i** NOTE

It is not possible to start climate comfort retention if there is not enough residual heat in the engine to maintain the passenger compartment climate, or if the outside temperature is above approx. 20°C (68°F).

### **i** NOTE

Climate comfort retention is switched off when the car is locked from the outside to avoid using residual heat unnecessarily. Use of the function is intended to maintain climate comfort when driver or passengers remain inside the car.

### Related information

- Climate comfort when parking (p. 225)





## Symbols and messages for parking climate control

A number of symbols and messages regarding parking climate control can be shown in the driver display.



Messages relating to parking climate control can also be displayed in a device which has the Volvo On Call\* app.



This symbol illuminates in the driver display<sup>11</sup> when the parking heater is active.

Symbol	Message	Specification
	<b>Parking climate Service required</b>	Parking climate control is disengaged. Contact a workshop <sup>A</sup> to check the function as soon as possible.
	<b>Parking climate Temporarily unavailable</b>	Parking climate control is temporarily disengaged. If the problem persists for some time, contact a workshop <sup>A</sup> to check the function.
	<b>Parking climate Unavailable Fuel level too low<sup>B</sup></b>	Parking climate control cannot be activated when the fuel level is too low to start the parking heater. Fill the vehicle's fuel tank.
	<b>Parking climate Unavailable Charge level too low</b>	Parking climate control cannot be activated if the charge level of the hybrid battery is too low to start the parking heater. Start the car.

<sup>11</sup> Applies to fuel-driven heater.

Symbol	Message	Specification
	<b>Parking climate</b> <b>Unavailable, not connected to the mains<sup>C</sup></b>	The parking climate control cannot be activated if the charging cable is not connected. Connect the charging cable.
	<b>Parking climate</b> <b>Limited Charge level too low</b>	The running time for parking climate control is limited when the state of charge in the hybrid battery is low. Start the car.

A An authorised Volvo workshop is recommended.

B Applies to fuel-driven heater.

C Applies to electric heater.

### Related information

- Parking climate (p. 219)

## Heater

The heater has two subfunctions that help to heat the passenger compartment or engine in different situations.

The heater has two subfunctions:

- Parking heater - heats the passenger compartment, if necessary, when the parking climate control's preconditioning is activated.
- Additional heater - heats the passenger compartment and engine, if necessary, during driving.

Either a fuel-driven heater or an electric heater is used, depending on the market<sup>12</sup>.

The heater is fitted in the front right-hand wheel housing.

### **i** NOTE

When the heater is running<sup>13</sup>, smoke may be emitted from the right-hand front wheel housing and a low hum may be heard. A ticking sound from the fuel pump may also be heard from the rear section of the car. This is perfectly normal.

## Battery and charging

The heater is powered by the car's hybrid battery. If the charge level of the hybrid battery is too low, then the heater is switched off automatically and the driver display shows a message.

### **i** NOTE

Make sure that there is enough charge in the battery if the heater needs to be used.

## Fuel and refuelling<sup>14</sup>

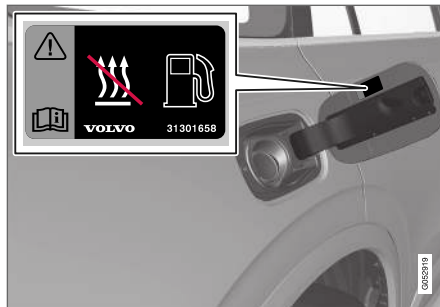

Warning label on fuel filler flap.

The heater uses fuel from the car's normal fuel tank.

If the car is parked on a steep hill, the front of the car should point downhill to ensure that there is a supply of fuel to the heater.

If the level in the fuel tank is too low then the heater is switched off automatically and the driver display shows a message.

### **i** NOTE

Make sure there is enough fuel in the car's fuel tank if the heater needs to be used.

### **!** WARNING

Fuel which spills out could be ignited. Switch off the fuel-driven heater before starting to refuel.



Check in the driver display that the heater is switched off. This symbol is lit when it is working as a parking heater.

## Related information

- Climate (p. 196)
- Parking heater (p. 229)
- Additional heater (p. 230)

<sup>12</sup> An authorised Volvo dealer has information regarding which markets use which type of heater.

<sup>13</sup> Applicable to fuel-driven auxiliary heater.

<sup>14</sup> Applies to fuel-driven heater.

## Parking heater

The parking heater heats the passenger compartment as necessary before driving if the car's preconditioning is activated.

The parking heater is one of two subfunctions of the car's heater. The heater is fitted in the front right-hand wheel housing.



When this symbol illuminates in the driver display, the parking heater may be active<sup>15</sup>.

### **i** NOTE

When the heater is running<sup>16</sup>, smoke may be emitted from the right-hand front wheel housing and a low hum may be heard. A ticking sound from the fuel pump may also be heard from the rear section of the car. This is perfectly normal.

The parking heater starts automatically if the parking climate's preconditioning is activated and the passenger compartment needs to be heated up.

It switches off automatically when a set timer time expires, or if the car is started.

### **i** NOTE

Make sure there is enough fuel in the car's fuel tank if the parking heater needs to be used<sup>17</sup>.

Make sure that there is enough charge in the hybrid battery if the parking heater needs to be used.

### **!** WARNING

Do not use preconditioning<sup>18</sup>:

- In unventilated spaces indoors. Exhaust gases are emitted if the heater starts.
- In locations with combustible or flammable material nearby. Fuel, gas, long grass, sawdust, etc. may ignite.
- When there is a risk that the heater's exhaust line may be blocked. For example, deep snow inside the front right-hand wheel housing can obstruct the heater's ventilation.

Remember that the preconditioning can be started by a timer that has been set for a long time in advance.

### **!** WARNING

If there is a smell of fuel, unusual amounts of smoke, black smoke, or unusual sounds coming from the parking heater<sup>19</sup>, switch off the heater and, if possible, pull out its fuse. Volvo recommends that an authorised Volvo workshop should be contacted for repair.

<sup>15</sup> Applies to fuel-driven heater.

<sup>16</sup> Applicable to fuel-driven auxiliary heater.

<sup>17</sup> Applicable to fuel-driven auxiliary heater.

<sup>18</sup> Applicable to fuel-driven auxiliary heater.

<sup>19</sup> Applicable to fuel-driven auxiliary heater.

◀◀ **Related information**

- Heater (p. 228)
- Additional heater (p. 230)

**Additional heater**

The auxiliary heater helps to heat the passenger compartment and engine while driving.

The additional heater is one of two subfunctions of the car's heater. The heater is fitted in the front right-hand wheel housing.

**i NOTE**

When the heater is running<sup>20</sup>, smoke may be emitted from the right-hand front wheel housing and a low hum may be heard. A ticking sound from the fuel pump may also be heard from the rear section of the car. This is perfectly normal.

The additional heater starts and is controlled automatically when heating is required while the car is being driven.

It switches off automatically when the car is switched off.

**i NOTE**

Make sure there is enough fuel in the car's fuel tank if the auxiliary heater needs to be used<sup>21</sup>.

**Related information**

- Heater (p. 228)
- Parking heater (p. 229)
- Activating and deactivating automatic start of auxiliary heater (p. 231)

<sup>20</sup> Applicable to fuel-driven auxiliary heater.

<sup>21</sup> Applicable to fuel-driven auxiliary heater.



## Activating and deactivating automatic start of auxiliary heater

The auxiliary heater helps to heat the passenger compartment and engine while driving.

It is possible to set whether automatic start for the additional heater should be activated/deactivated.

1. Press **Settings** in the top view in the centre display.
2. Press **Climate**.
3. Select **Additional Heater** to activate/deactivate automatic start of the additional heater.

### **i** NOTE

Volvo recommends that the automatic start for the additional heater should be switched off for short driving distances<sup>22</sup>.

### **i** NOTE

If the auxiliary heater's automatic starting is deactivated, this may impede comfort in the passenger compartment as the climate control system will then have no heat source during electrical operation.

### Related information

- Additional heater (p. 230)

<sup>22</sup> Applicable to fuel-driven auxiliary heater.



KEY, LOCKS AND ALARM

## Lock confirmation

The car indicates with hazard warning flashers when the car is locked or unlocked.

## Exterior indication

Locking

- The car's hazard warning flashers indicate locking by flashing and retracting the door mirrors<sup>1</sup>.

Unlocking

- The car's hazard warning flashers indicate unlocking by two flashes and extending the door mirrors<sup>1</sup>.

All doors, the tailgate and the bonnet must be closed for the car to indicate that it is locked. If locking takes place with just the driver door closed<sup>2</sup>, locking will take place but the lock indication with hazard warning flashers will only take place when all doors, the tailgate and the bonnet have been closed.

## Lock and alarm indicator on the instrument panel

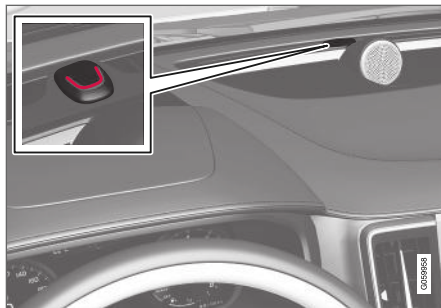

The lock and alarm indicator shows the status of the locking system:

- A long flash indicates locking.
- Short flashes indicate that the car is locked.
- Rapid flashes after disarming the alarm\* indicate that the alarm has been triggered.

## Indication in lock buttons

### Front door



Lock buttons with indicator lamp in the front door.

An illuminated indicator lamp in the lock button of either front door indicates that all doors are locked. If any door is opened, the lamp will extinguish in both doors.

<sup>1</sup> Only for cars with retractable power door mirrors.

<sup>2</sup> Not applicable to with cars equipped with keyless locking/unlocking\*.

**Rear door\***

Lock button with indicator lamp in the rear door.

An illuminated indicator lamp in the lock button for one of the doors indicates that the door in question is locked. If any door is unlocked, its lamp will extinguish while the others will continue to illuminate.

**Other indication**

The home safe lighting and approach light functions can also be activated when locking and unlocking.

**Related information**

- Lock indication setting (p. 235)
- Approach light duration (p. 154)
- Using home safe lighting (p. 154)

**Lock indication setting**

It is possible to select various options for how the car confirms locking and unlocking in the settings menu in the centre display.

To change the locking response setting:

1. Tap on **Settings** in the centre display's top view.
2. Press **My Car** → **Locking**.
3. Press **Visible Locking Feedback** to select when the car is to give a visible response:
  - **Lock**
  - **Unlock**
  - **Both**

Or switch off the function by selecting **Off**.

To change the setting for retractable rearview mirrors\* when locking:

1. Tap on **Settings** in the centre display's top view.
2. Press **My Car** → **Mirrors and Convenience**.
3. Select **Fold Mirror When Locked** to activate or deactivate the function.

**Related information**

- Lock confirmation (p. 234)

**Remote control key**

The remote control key locks and unlocks the doors and tailgate. The remote control key needs to be inside the car for it to be started.



Remote control key<sup>3</sup> or key tag (Key Tag)\*.

The remote control key is not physically used when starting since the car is equipped with support for keyless starting (Passive Start) as standard. You simply need to have the key in the front part of the passenger compartment.

For cars equipped with keyless locking and unlocking (Passive Entry)\* the key can be anywhere in the car to start the car. In this case, a slightly smaller, lighter key tag (Key Tag) is also supplied.

<sup>3</sup> The figure is schematic - parts may vary depending on car model.

- ◀◀ The remote control keys can be linked to different driver profiles to save personal preferences in the car.

### Remote control key buttons



The remote control key has four buttons - one on the left-hand side and three on the right-hand side.

-  **Locking** - Pressing the button locks the doors, tailgate and fuel filler flap and also arms the alarm\*.

Press and hold to close all of the windows and the panorama roof\* simultaneously.

-  **Unlocking** - Pressing the button unlocks the doors, tailgate and fuel filler flap and also deactivates the alarm.

A longer press opens all windows simultaneously. This total airing function can be used, for example, to quickly air the car in hot weather.

-  **Tailgate** - Unlocks the tailgate only and disarms its alarm. On cars with power operated tailgate\*, the tailgate is opened automatically when the button is held depressed. The tailgate is also closed with a long press - acoustic warning signals sound.

-  **Panic function** - Used to attract attention in an emergency. Press and hold the button for at least 3 seconds or press it twice within 3 seconds to activate the direction indicators and the horn. The function can be turned off with the same button once it has been active for at least 5 seconds. Otherwise the function switches off automatically after 3 minutes.

### WARNING

If anyone is left in the car, make sure the power windows and panoramic roof\* are de-energised by always taking the remote control key with you when you leave the car.

 **NOTE**

Be aware of the risk of locking the remote control key in the car.

- A remote control key or key tag left in the car will be deactivated when the car is locked and the alarm is armed using another valid key. The "Double lock" function is also deactivated. The key left behind is reactivated when the car is unlocked.
- A Red Key left in the car will be deactivated even when the car is locked using Volvo On Call, and reactivated when the car is unlocked using Volvo On Call or with another valid key.

### Button-less key (Key Tag)\*

The key tag provided with the keyless locking and unlocking function works in the same way as the standard remote control key as regards keyless starting and locking and unlocking. The key is waterproof to a depth of approx. 10 metres (30 feet) for up to 60 minutes. It has no detachable key blade and the battery cannot be replaced.

### Red Key - restricted remote control key\*

A Red Key is a key that makes it possible to set restrictions for some of the car's properties, e.g. the car's maximum speed and the loudspeaker system's maximum volume. A key for any car

owner who wants their car to be driven responsibly even when someone else is driving it.

### Interference

Remote control key functions for keyless starting and keyless locking and unlocking\* can be disrupted by electromagnetic fields and screening.

#### **i** NOTE

Avoid storing the remote control key close to metal objects or electronic apparatus, e.g. mobile phones, tablets, laptops or chargers - preferably no closer than 10-15 cm (4-6 inches).

If there is still interference - use the remote control key's detachable key blade to unlock and then place the key in the backup reader in the cup holder to disarm the car.

#### **i** NOTE

When the remote control key is placed in the cup holder, make sure that no other car keys, metal objects or electronic apparatus (e.g. mobile phones, tablets, laptops or chargers) are in the cup holder. Several car keys close to each other in the cup holder can cause interference with each other.

### Related information

- Locking and unlocking with the remote control key (p. 237)
- Remote control key range (p. 239)
- Replacing the battery in the remote control key (p. 240)
- Detachable key blade (p. 245)
- Immobiliser (p. 248)
- Linking remote control key to driver profile (p. 131)

### Locking and unlocking with the remote control key

The buttons on the remote control key can be used to lock and unlock all doors and the tailgate simultaneously.

#### Locking with the remote control key



The figure is schematic - parts may vary depending on car model.

- Press the remote control key  button to lock the car.

For the lock sequence to be activated, the driver door must be closed<sup>4</sup>. If any of the other doors or the tailgate are open, these are locked and alarmed\* only when they are closed. The alarm's movement detectors\* are activated when all the doors and the tailgate are closed and locked.

<sup>4</sup> If the car is equipped with keyless locking/unlocking\* then all side doors must be closed.



### **i** NOTE

Be aware of the risk of locking the remote control key in the car.

- A remote control key or key tag left in the car will be deactivated when the car is locked and the alarm is armed using another valid key. The "Double lock" function is also deactivated. The key left behind is reactivated when the car is unlocked.
- A Red Key left in the car will be deactivated even when the car is locked using Volvo On Call, and reactivated when the car is unlocked using Volvo On Call or with another valid key.

### Locking when the tailgate is open

### **i** NOTE

If the car has been locked while the tailgate is open, be careful not to leave the remote control key in the cargo area when the tailgate is closed and the car is completely locked<sup>5</sup>.

### Unlocking with the remote control key

- Press the remote control key  button to unlock the car.

### Automatic relocking

If none of the doors or the tailgate is opened within 2 minutes of unlocking, they are locked automatically. This function prevents the car from being left unlocked unintentionally.

### When the remote control key does not work

### **i** NOTE

Always try moving closer to the car and making another unlock attempt.

If it is not possible to lock or unlock with the remote control key, the battery may be discharged - in which case, lock or unlock the driver's door with the detachable key blade.

### Related information

- Settings for remotely controlled and inside unlocking (p. 238)
- Unlocking the tailgate with the remote control key (p. 239)
- Remote control key (p. 235)
- Replacing the battery in the remote control key (p. 240)
- Locking and unlocking with the detachable key blade (p. 247)

### Settings for remotely controlled and inside unlocking

It is possible to select different sequences for remotely controlled unlocking.

To change setting:

1. Tap on **Settings** in the centre display's top view.
2. Press **My Car** → **Locking** → **Remote and Interior Unlock**.
3. Select option:
  - **All Doors** - unlocks all doors simultaneously.
  - **Single Door** - unlocks the driver's door. Unlocking all of the doors requires two presses on the remote control key's unlock button.

The settings made here also affect central unlocking via opening handles from the inside.

### Related information

- Locking and unlocking with the remote control key (p. 237)
- Locking and unlocking from inside the car (p. 262)

<sup>5</sup> If the car is equipped with keyless locking/unlocking and the key is detected inside the car, the tailgate will not lock when it is closed.\*



## Unlocking the tailgate with the remote control key

It is possible to unlock just the tailgate by pressing a button on the remote control key.

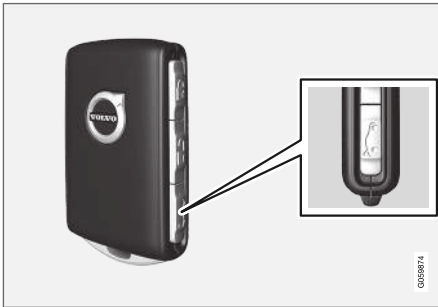

1. Press the remote control key's  button.
  - > The tailgate is unlocked but remains closed.

The side doors are still locked and the alarm is armed\*. The lock and alarm indicator on the instrument panel extinguishes in order to show that the entire car is not locked.

Lightly grasp the rubberised pressure plate beneath the tailgate handle to open the tailgate. If the tailgate is not opened within 2 minutes then it is relocked and the alarm is re-armed.

2. With the power operated tailgate option\* - Long press (approx. 1.5 seconds) on the remote control key's  button
  - > The tailgate is unlocked and opened, while the side doors remain locked and their alarm functions armed.



### Related information

- Locking and unlocking with the remote control key (p. 237)
- Opening and closing the power\*-operated tailgate (p. 266)

## Remote control key range

In order for the remote control key to work properly it needs to be within a certain distance from the car.

### For manual use

The remote control key's functions for e.g. locking/unlocking that are activated by pressing on  or  have a range that extends approx. 20 metres (65 feet) from the car.

If the car does not verify a button being pressed - move closer and try again.

### For keyless\* use

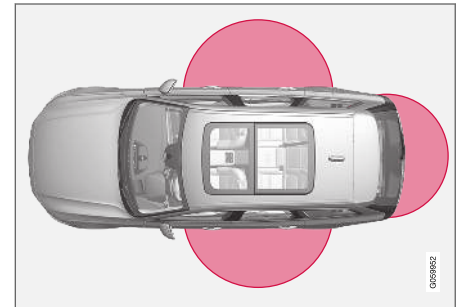

The marked area in the illustration shows areas covered by the system's antennas.

For keyless use, a remote control key or the button-less key (Key Tag) must be within a semicircular area with a radius of approx. 1.5 metres



- ◀◀ (5 feet) on both long sides and approx. 1 metre (3 feet) from the tailgate.

**i NOTE**

The remote control key functions may be disrupted by surrounding radio waves, buildings, topographical conditions, etc. The car can always be locked/unlocked with the key blade.

**If the remote control key is removed from the car**



If the remote control key is removed from the car when the engine is running, the warning message **Car key not found Removed from car** is shown in the driver display and an acoustic reminder sounds when the last door is closed.

The message extinguishes when the key is returned to the car, followed by a press of the right-hand keypad's **O** button, or when the last door is closed.

**Related information**

- Remote control key (p. 235)
- Antenna locations for the start and lock systems (p. 261)
- Keyless and touch-sensitive surfaces\* (p. 258)

<sup>6</sup> Supplied with cars equipped with keyless locking/unlocking\*.

**Replacing the battery in the remote control key**

The battery in the remote control key needs to be replaced when it has become discharged.

**i NOTE**

All batteries have a limited service life and must eventually be replaced (does not apply to Key Tag). The service life of the battery varies depending on how often the vehicle/key is used.



The battery for the remote control key should be replaced if

- the information symbol illuminates and the message **Car key battery low** is shown in the driver display
- the locks repeatedly do not react to signals from the remote control key within 20 metres (65 feet) of the car.

**i NOTE**

Always try moving closer to the car and making another unlock attempt.

The battery in the button-less key<sup>6</sup> (Key Tag) cannot be replaced - a new key can be ordered from an authorised Volvo workshop.

**i IMPORTANT**

A discharged Key Tag must be handed over to an authorised Volvo workshop. The key must be deleted from the car since it is still possible to use it to start the car via back-up start.

## Opening the key and changing the battery



1 Hold the remote control key with the front visible and the Volvo logo facing the right way - slide the button at bottom edge by the key ring to the right. Slide the front side's shell a few millimetres upwards.

The shell will then come free and can be lifted off the key.

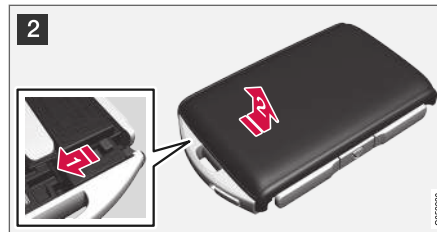

2 Turn the key, move the button to the side and slide the back shell a few millimetres upwards.

The shell will then come free and can be lifted off the key.

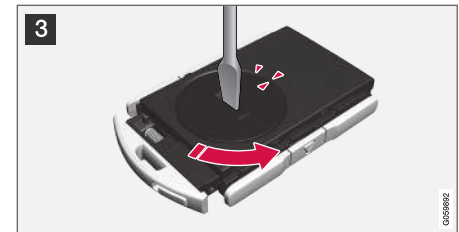

3 Use a screwdriver or similar to turn the battery cover anticlockwise until the markings meet at the **OPEN** text.

Carefully lift away the battery cover by pressing e.g. a fingernail into the recess.

Then prize the battery cover upwards.



4 The battery (+) side is facing upwards. Then carefully prize loose the battery as illustrated.

**! IMPORTANT**

Avoid touching new batteries and their contact surfaces with your fingers as this may impair their function.

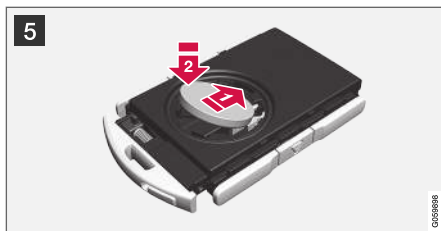

5 Install a new battery with the (+) side up. Avoid touching the remote control key's battery contacts with your fingers.

➡ Place the battery in the holder with the edge down. Then slide the battery forwards so that it fastens under the two plastic catches.

➡ Press the battery down so that it fastens under the upper black plastic catch.

**i NOTE**

Use batteries with the designation CR2032, 3 V.

**i NOTE**  
Volvo recommends that the batteries to be used in the remote control key fulfil UN Manual of Test and Criteria, Part III, sub-section 38.3. Batteries fitted in the factory or replaced by an authorised Volvo workshop fulfil the above criteria.

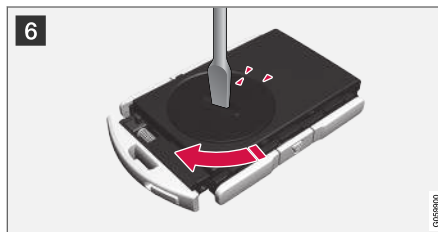

6 Refit the battery cover and turn it clockwise until the marking aligns with the **CLOSE** text.



- 7** Reposition the rear side's shell and press it down until a clicking sound can be heard.
- Then slide the shell back.
- > A further click will indicate that the shell is properly positioned and securely attached.



- 8** Turn the remote control key over and refit the front side's shell by pressing it down until a clicking sound can be heard.
- Then slide the shell back.
- > A further click will indicate that the shell is securely attached.

### **IMPORTANT**

Make sure that exhausted batteries are disposed of in a manner which is kind to the environment.

#### **Related information**

- Remote control key (p. 235)

### **Ordering more remote control keys**

The car is supplied with two remote control keys. A button-less key is supplied if the car is equipped with keyless locking and unlocking\*. Additional keys can be ordered.

A total of twelve keys can be programmed and used for one single car. If additional keys are ordered, additional driver profiles are added - one per new remote control key. This also applies for the key tag.

#### **Loss of a remote control key**

If you lose a remote control key then a new one can be ordered at a workshop - an authorised Volvo workshop is recommended. The remaining remote control keys must be taken to the workshop. The code of the missing key must be erased from the system as a theft prevention measure.

The current number of keys registered to the car can be checked via driver profiles in the centre display's top view, select **Settings** → **System** → **Driver Profiles**.

#### **Related information**

- Remote control key (p. 235)

## Red Key - restricted remote control key\*

A Red Key makes it possible for the car's owner to set limitations for certain of the car's properties. The limitations are intended to encourage the car to be driven in a safe manner, e.g. when being loaned out.



For a Red Key, it is possible to define the car's maximum speed, set speed reminders and determine the loudspeaker system's maximum volume. In addition, some of the car's driver support systems will always be active. Other functions of the key are the same as those of a normal remote control key.

The restrictions are intended to act as measures to reduce the risk of accidents, thereby making it feel safer to hand over the car to e.g. young drivers, valet parking or a workshop.

## Driver profile for Red Key

A Red Key is connected to a special Red Key driver profile, and when it is active, the key's settings cannot be changed. It is not possible to change to another driver profile either; this requires a normal remote control key.

The Red Key driver profile is activated when the car is unlocked with a Red Key without a normal remote control key in the vicinity.

### **i** NOTE

In the event of a change of driver, the car must be locked and unlocked in order to activate a new driver profile.

## Ordering Red Key

One or more Red Key can be ordered from a Volvo dealer. A total of eleven keys with restrictions can be programmed and used for a single car - at least one must be a normal remote control key.

## Related information

- Settings for Red Key\* (p. 244)
- Remote control key (p. 235)

## Settings for Red Key\*

The holder of a regular remote control key can change settings for a Red Key. However, certain driver support functions are always active.

To change setting:

1. Unlock the car with the normal remote control key.
2. Tap on **Settings** in the centre display's top view.
3. Press **System** → **Driver Profiles** → **Red Key**.
  - > The following settings can be defined:
    - **Set Time Gap For Adaptive Cruise Control\***
    - **Reduced Maximum Volume**
    - **Max Speed Limit**
    - **Speed Limit Warning**

## Details and settings on first use

### **Set Time Gap For Adaptive Cruise Control**

Set the time gap (1 is the shortest and 5 is the longest gap).

On first use, the setting is **5.0**.

### **Reduced Maximum Volume**

**Lower maximum volume for media sources.**

On first use, the function is "On".

**Max Speed Limit**

Set a maximum speed for this key.

On first use, the function is "On" and the speed is 120 km/h (75 mph).

- Setting interval: 50-250 km/h (30-160 mph)
- Increments: 1 km/h (1 mph)



Speed restriction symbol.

**Speed Limit Warning**

Warns when car moves above set values.

On first use, the function is "On" and the values are 50, 70 and 90 km/h (30, 45 and 55 mph).

- Setting interval: 0-250 km/h (0-160 mph)
- Increments: 1 km/h (1 mph)
- Max. number of simultaneous reminders: 6

**Driver support functions**

The following driver support functions will always be active for the user of a Red Key:

- Blind Spot Information (BLIS)\*
- Lane assistance (LKA)\*
- Distance Warning\*
- City Safety
- Driver Alert Control (DAC)\*
- Road Sign Information\*

**Related information**

- Red Key - restricted remote control key\* (p. 244)

**Detachable key blade**

The remote control key contains a detachable key blade of metal with which a number of functions can be activated and some operations carried out.

The key blade's unique code is provided by authorised Volvo workshops, which are recommended when ordering new key blades.



## ◀ The key blade's application areas

Using the remote control key's detachable key blade

- the left-hand<sup>7</sup> front door can be opened manually if central locking cannot be activated with the remote control key
- all doors are emergency-locked
- the rear doors' mechanical child safety locks can be activated and deactivated.

The button-less key<sup>8</sup> does not have a detachable key blade. If necessary, use the detachable key blade from the normal remote control key.

## Detaching the key blade



- 1 Hold the remote control key with the front visible and the Volvo logo facing the right way - slide the button at bottom edge by the key ring to the right. Guide the front side's shell a few millimetres upwards.

The shell will then come free and can be lifted off the key.



- 2 Detach the key blade by angling it up.



- 3 Return the key blade to its intended position in the remote control key after use.

Refit the shell by pressing it downward until a clicking sound is heard.

Then slide the shell back.

> A further click will indicate that the shell is securely attached.

## Related information

- Locking and unlocking with the detachable key blade (p. 247)
- Remote control key (p. 235)

<sup>7</sup> This applies whether the car is left-hand drive or right-hand drive.

<sup>8</sup> Supplied with cars equipped with keyless locking/unlocking\*.



## Locking and unlocking with the detachable key blade

Amongst other things, the detachable key blade can be used to unlock the car from the outside - e.g. if the remote control key's battery has become discharged.

### Unlocking

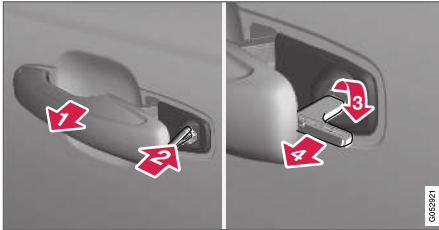

- 1 Pull out the front door handle on the left-hand side<sup>9</sup> to its end position so that the lock cylinder become visible.
- 2 Insert the key in the lock cylinder.
- 3 Turn clockwise 45 degrees so that the key blade is pointing straight back.
- 4 Turn the key back 45 degrees to its starting position. Remove the key from the lock cylinder and release the handle so that the rear section of the handle is resting against the car again.

5. Pull out the handle.
  - > The door opens.

Locking will be performed in the same way, but with an anticlockwise turn 45 degrees instead of clockwise in step (3).

### Switching off the alarm\*

#### **i** NOTE

When the door is unlocked using the key blade and is then opened, the alarm is triggered.



The backup reader's location in the cup holder.

Deactivate the alarm as follows:

1. Place the remote control key on the key symbol in the backup reader in the bottom of the cup holder in the tunnel console.

2. Then turn the start knob clockwise and release it.
  - > The alarm signal stops sounding and the alarm is switched off.

### Locking

It is also possible to lock the car with the remote control key's detachable key blade e.g. in the event of a loss of power or if the key's battery has become discharged.

The left-hand front door can be locked with its lock cylinder and the detachable key blade.

Other doors have no lock cylinders and instead have a lock switch on the end of each door which must be depressed using the key blade - they are then mechanically locked/blocked to prevent them being opened from outside.

The doors can still be opened from the inside.

<sup>9</sup> This applies whether the car is right-hand drive or left-hand drive.

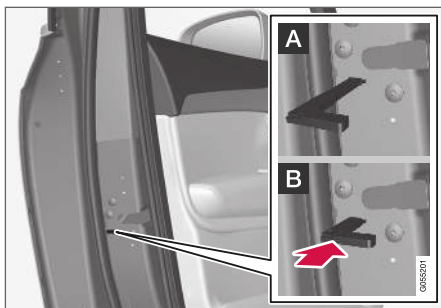

Manual locking of the door. Not to be mixed up with the child safety locks.

- Remove the detachable key blade from the remote control key. Insert the key blade in the hole for lock reset and press the key in until it bottoms, approx. 12 mm (0.5 inches).

**A** The door can be opened from both the outside and the inside.

**B** The door is blocked against opening from the outside. To return to position A, the inner door handle must be opened.

The doors can also be unlocked with the unlock button on the remote control key or with the central locking button on the driver's door.

**i NOTE**

- A door's lock reset only locks that particular door - not all doors simultaneously.
- A manually locked rear door with activated manual or electric child safety locks cannot be opened from either the outside or the inside. A rear door that is locked in this way can only be unlocked with the remote control key or central locking button.

**Related information**

- Detachable key blade (p. 245)
- Activating and deactivating alarms\* (p. 274)
- Replacing the battery in the remote control key (p. 240)
- Remote control key (p. 235)

**Immobiliser**

The electronic immobiliser is a theft protection system that prevents an unauthorised person from starting the car.

The car can only be started with the correct remote control key.

The following error message in the driver display is related to the electronic immobiliser:

Symbol	Message	Specification
	<b>Car key not found</b> <b>See Owner's manual</b>	Error reading the remote control key during starting - place the key on the key symbol in the cup holder and try again.

**Related information**

- Remote control key (p. 235)
- Ordering more remote control keys (p. 243)

## Type approval for the remote control key system

Type approval for the car's remote key system can be seen in the following tables.

For more information about type approval, see [support.volvocars.com](http://support.volvocars.com).

## Lock system keyless start (Passive Start) and keyless locking/unlocking (Passive Entry\*)

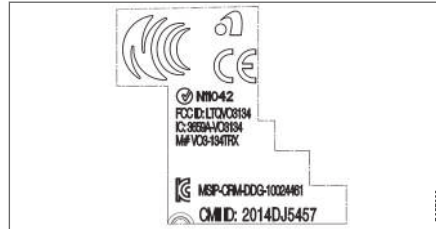

CEM marking for the remote control key system. For supplementary type approval numbers, see following tables.



Country/Area	Type approval	
Europe	Delphi Deutschland GmbH, 42367 Wuppertal hereby declares that this V03-134TRX conforms to the essential property requirements and other relevant provisions contained in directive 2014/53/EU (RED). The full text of the EU declaration of conformity can be found at <a href="http://support.volvocars.com">support.volvocars.com</a> .	
Jordan	TRC/LPD/2014/250	
Serbia	P1614120100	
Argentina	CNC ID: C-14771	



KEY, LOCKS AND ALARM



Country/Area	Type approval	
Brazil	MT-3245/2015	 <p data-bbox="1209 283 1342 303">0589-15-6830</p>  <p data-bbox="1174 381 1374 402">(01) 0 7897843840961</p> <p data-bbox="1476 370 1489 404" style="writing-mode: vertical-rl; font-size: small;">01058122</p>
Indonesia	Nomor: 38301/SDPPI/2015	
Malaysia	RAAT/37A/1215/S(15-5198)	
Mexico	IFETEL: RLVDEVO15-0396	
Russia		 <p data-bbox="1476 748 1489 781" style="writing-mode: vertical-rl; font-size: small;">0087905</p>
The United Arab Emirates	ER37847/15 DA0062437/11	

Country/Area	Type approval	
Namibia	TA-2016-02	
South Africa	TA-2014-1868	

### Remote control key

Country/Area	Type approval	
Europe	<p>Huf Hüsbeck &amp; Fürst GmbH &amp; Co. KG hereby declares that this type of radio equipment HUF8423 conforms to directive 2014/53/EU.</p> <p>The full text of the EU declaration of conformity can be found at <a href="http://support.volvocars.com">support.volvocars.com</a>.</p> <p>Wavelength: 433.92 MHz</p> <p>Maximum radiated transmission power: 10 mW</p> <p>Manufacturer: Huf Hüsbeck &amp; Fürst GmbH &amp; Co. KG, Steeger Str. 17, 42551 Velbert, Germany</p>	
Jordan	TRC/LPD/2015/104	

KEY, LOCKS AND ALARM



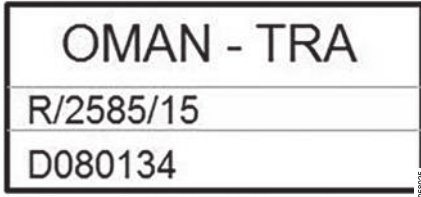
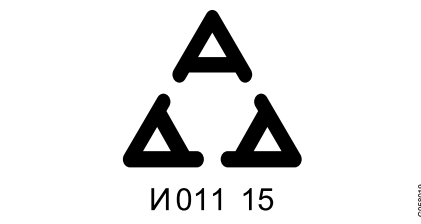

Country/Area	Type approval	
Morocco	AGREE PAR L'ANRT MAROC Numéro d'agrément: MR 10668 ANRT 2015 Date d'agrément: 24/07/2015	
Mexico	IFETEL Marca: HUF Modelo (s): HUF8423 NOM-121-SCT1-2009 La operación de este equipo está sujeta a las siguientes dos condiciones: (1) es posible que este equipo o dispositivo no cause interferencia perjudicial y (2) este equipo o dispositivo debe aceptar cualquier interferencia, incluyendo la que pueda causar su operación no deseada.	
Namibia	TA-2015-102	

Country/Area	Type approval	
Oman		 <p>OMAN - TRA R/2585/15 D080134</p> <small>03050203</small>
Serbia		 <p>A I011 15</p> <small>03050119</small>

KEY, LOCKS AND ALARM



Country/Area	Type approval	
South Africa	TA-2015-432	
The United Arab Emirates		

**Key Tag**



Country/Area	Type approval	
Europe	<p>Huf Hüsbeck &amp; Fürst GmbH &amp; Co. KG hereby declares that this type of radio equipment HUF8432 conforms to directive 2014/53/EU.</p> <p>The full text of the EU declaration of conformity can be found at <a href="http://support.volvocars.com">support.volvocars.com</a>.</p> <p>Wavelength: 433.92 MHz</p> <p>Maximum radiated transmission power: 10 mW</p> <p>Manufacturer: Huf Hüsbeck &amp; Fürst GmbH &amp; Co. KG, Steeger Str. 17, 42551 Velbert, Germany</p>	
Jordan	TRC/LPD/2015/107	



Country/Area	Type approval	
Morocco	AGREE PAR L'ANRT MAROC Numéro d'agrément: MR 10667 ANRT 2015 Date d'agrément: 24/07/2015	
Mexico	IFETEL Marca: HUF Modelo (s): HUF8432 NOM-121-SCT1-2009 La operación de este equipo está sujeta a las siguientes dos condiciones: (1) es posible que este equipo o dispositivo no cause interferencia perjudicial y (2) este equipo o dispositivo debe aceptar cualquier interferencia, incluyendo la que pueda causar su operación no deseada.	
Namibia	TA-2015-103	 <p>The logo for CRAN (Communications Regulatory Authority of Namibia) features a stylized satellite dish or signal icon on the left, followed by the acronym 'CRAN' in large, bold, black letters. Below the acronym, the full name 'Communications Regulatory Authority of Namibia' is written in a smaller font. A small vertical number '006337' is located in the bottom right corner of the logo area.</p>

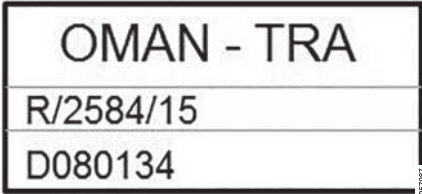

Country/Area	Type approval	
Oman		 <p>OMAN - TRA R/2584/15 D080134</p>
Serbia		 <p>A I011 15</p>

Country/Area	Type approval	
South Africa	TA-2015-414	
The United Arab Emirates		

### Related information

- Remote control key (p. 235)

## Keyless and touch-sensitive surfaces\*

With the keyless locking and unlocking function, carrying the remote control key in a pocket or bag will suffice. The car is locked or unlocked via a touch-sensitive surface on the door handle.

### Touch-sensitive surfaces

#### Door handle

The outside of the door handles contains a recess for locking, while the inside contains a touch-sensitive surface for unlocking.

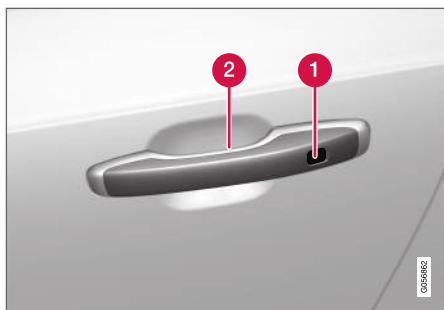

- 1 Touch-sensitive recess for locking
- 2 Touch-sensitive surface for unlocking

#### **i** NOTE

It is important that only one touch-sensitive surface is activated at a time. Gripping the handle while touching the lock surface risks giving double commands. This means that the requested activity (locking/unlocking) will not be executed, or will be executed with a delay.

#### Tailgate handle

The tailgate handle has a rubberised pressure plate that is only used for unlocking.

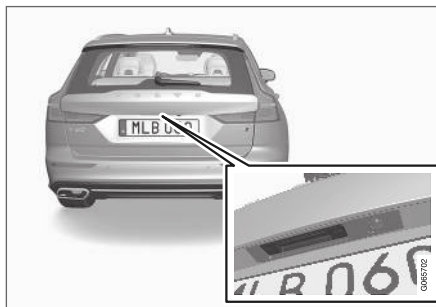

#### **i** NOTE

Be aware that the system may be activated in connection with car washing if the remote control key is in range.

### Related information

- Keyless locking and unlocking\* (p. 259)
- Keyless unlocking of the tailgate\* (p. 261)

## Keyless locking and unlocking\*

With keyless locking and unlocking, it is sufficient to touch the door handle's touch-sensitive surface to lock or unlock the car.

### **i** NOTE

One of the car's remote control keys must be within range for locking and unlocking to work.

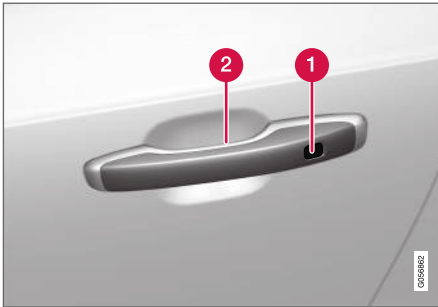

- 1** Touch-sensitive recess for locking
- 2** Touch-sensitive surface for unlocking

### **i** NOTE

Be aware that the system may be activated in connection with car washing if the remote control key is in range.

## Keyless locking

All side doors must be closed to be able to lock the car. The tailgate, on the other hand, can be open when locking the car with a side door handle.

- Touch the marked surface towards the rear on the outside of a door handle after the door has been closed. Or press the  button on the underside of the tailgate<sup>10</sup> before it closes.
  - > The lock indicator on the instrument panel starts to flash to indicate the car is locked.

To close all side windows and the panoramic roof\* simultaneously - place a finger against the touch-sensitive recess on the outside of the door handle and hold it there until all of the side windows and the panoramic roof have been closed.

## Locking when the tailgate is open

### **i** NOTE

If the car has been locked while the tailgate is open, be careful not to leave the remote control key in the cargo area when the tailgate is closed.

If the key is detected inside the car, the tailgate will not lock when it is closed.

<sup>10</sup> Applies with power operated tailgate\*.

### ◀ Keyless unlocking

- Grasp a door handle or gently press the rubberised pressure plate beneath the tailgate handle to unlock the car.
  - > The lock indicator on the instrument panel stops flashing to indicate that the car is unlocked.

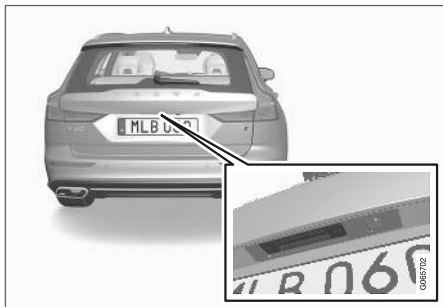

Rubberised pressure plate on the tailgate can only be used for unlocking.

### Automatic relocking

If none of the doors or the tailgate is opened within 2 minutes of unlocking, they are locked automatically. This function prevents the car from being left unlocked unintentionally.

### Related information

- Settings for Keyless entry\* (p. 260)
- Keyless unlocking of the tailgate\* (p. 261)

- Keyless and touch-sensitive surfaces\* (p. 258)

### Settings for Keyless entry\*

It is possible to select different sequences for Keyless entry.

To change setting:

1. Tap on **Settings** in the centre display's top view.
2. Tap on **My Car** → **Locking** → **Keyless Unlock**
3. Select option:
  - **All Doors** - unlocks all doors simultaneously.
  - **Single Door** - unlocks selected door.

### Related information

- Keyless locking and unlocking\* (p. 259)
- Keyless and touch-sensitive surfaces\* (p. 258)

## Keyless unlocking of the tailgate\*

With keyless locking and unlocking, it is sufficient to touch the touch-sensitive surface on the tailgate handle to unlock the tailgate.

### **i** NOTE

One of the car's remote control keys must be within range behind the car for unlocking to work.

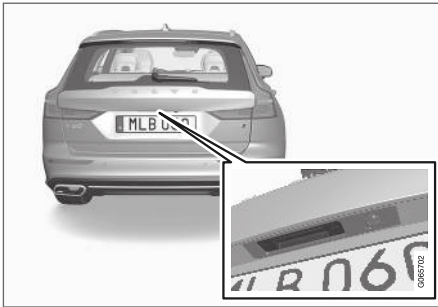

The tailgate is held closed by an electrical lock.

To open:

1. Press gently on the rubberised pressure plate beneath the tailgate handle.
  - > The lock is released.

2. Lift by the outside handle in order to open the tailgate.

### **!** IMPORTANT

- Minimal force is required to release the rear hatch lock - just gently press the rubberised panel.
- Do not place the lift force on the rubber panel when opening the rear hatch - lift the handle. Using too much force may damage the electrical contacts on the rubber panel.

It is also possible to unlock the tailgate hands-free with a foot movement under the rear bumper, see separate section.

### **!** WARNING

Do not drive with an open tailgate! Toxic exhaust fumes could be drawn into the car through the cargo area.

### Related information

- Keyless locking and unlocking\* (p. 259)
- Keyless and touch-sensitive surfaces\* (p. 258)
- Remote control key range (p. 239)
- Opening and closing the tailgate with foot movement\* (p. 269)

## Antenna locations for the start and lock systems

An antenna for the keyless starting system and antennas for the keyless locking system\* are built into the car.

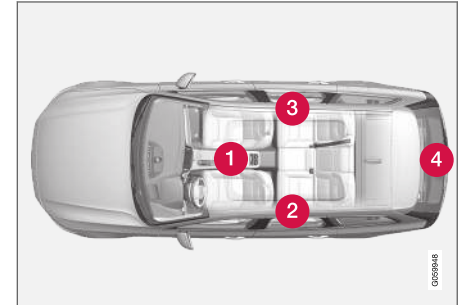

### ◀ Antenna locations:

- 1 Under the cup holder in the front section of the tunnel console
- 2 In the upper front section of the left-hand rear door<sup>11</sup>
- 3 In the upper front section of the right-hand rear door<sup>11</sup>
- 4 In the cargo area<sup>11</sup>

### **WARNING**

People with pacemaker operations should not come closer than 22 cm (9 inches) to the keyless system's antennas with their pacemaker. This is to prevent interference between the pacemaker and the keyless system.

### Related information

- Keyless and touch-sensitive surfaces\* (p. 258)
- Remote control key range (p. 239)

### Locking and unlocking from inside the car

The doors and tailgate can be locked and unlocked from inside using the central locking controls in the front doors.

#### Central locking



Locking and unlocking button with indicator lamp in the front door.

#### Unlocking using a button in the front door

- Press the  button to unlock all side doors and the tailgate.

#### Alternative unlocking method



Opening handle for alternative unlocking in the side door<sup>12</sup>.

- Pull the opening handle on one of the side doors and release.
  - > Depending on the settings in the remote control key, either all doors will be unlocked or only the selected door will be unlocked and opened.

To change this setting, tap on **Settings** → **My Car** → **Locking** → **Remote and Interior Unlock** in the centre display's top view.

<sup>11</sup> Only in cars equipped with keyless locking and unlocking\*.

<sup>12</sup> The figure is schematic - parts may vary depending on car model.



### Locking using a button in the front door

- Press the  button - both front doors must be closed.
  - > All doors and the tailgate are locked.

### Locking using a button in the rear door\*



Locking button with indicator lamp in the rear door.

The rear door lock buttons lock their respective rear door.

### Unlocking the rear door

- Pull the opening handle.
  - > The rear door is unlocked and opened<sup>13</sup>.

### Related information

- Settings for remotely controlled and inside unlocking (p. 238)
- Unlocking the tailgate from the inside of the car (p. 263)
- Activating and deactivating child safety locks (p. 264)

### Unlocking the tailgate from the inside of the car

The tailgate can be unlocked from inside by pressing the button on the instrument panel.



- Brief press on the  button on the instrument panel.
  - > The tailgate can be unlocked and opened from the outside by grasping the rubberised pressure plate.

With the power operated tailgate option\*:

- Long press on the  button on the instrument panel.
  - > The tailgate is opened.

<sup>13</sup> Provided that the child safety lock is not activated.

◀◀ **Related information**

- Locking and unlocking from inside the car (p. 262)
- Opening and closing the power\*-operated tailgate (p. 266)

**Activating and deactivating child safety locks**

The child safety locks prevent the rear doors being opened from inside.

The child safety locks may be either manual or electric\*.

**Activating and deactivating manual child safety locks**

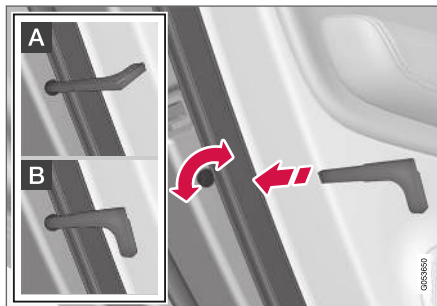

Manual child safety locks. Not to be confused with manual door locks.

- Use the remote control key's detachable key blade to turn the knob.

- A** The door is blocked against opening from the inside.
- B** The door can be opened from both the outside and the inside.

<b>i</b>	<b>NOTE</b>
<ul style="list-style-type: none"> <li>• A door's knob control only blocks that particular door - not both rear doors simultaneously.</li> <li>• Cars with an electric child safety lock do not have a manual child lock.</li> </ul>	

**Activating and deactivating electric\* child safety locks**

The electric child safety locks can be activated and deactivated in all ignition positions higher than **0**. Activation and deactivation can be performed up to 2 minutes after switching off the car, provided that no door is opened.



Button for electric activation and deactivation.

1. Start the car or choose an ignition position higher than **0**.

2. Press the button in the driver's door control panel.
  - > The driver display shows the message **Rear child lock Activated** and the button's lamp illuminates - the locks are active.



When the electric child safety lock is active then the rear

- windows can only be opened with the driver's door control panel
- doors cannot be opened from inside.

To deactivate the locks:

- Press the button in the driver's door control panel.
  - > The driver display shows the message **Rear child lock Deactivated** and the button's lamp goes out - the locks are deactivated.

When the car is switched off, the current setting is stored - if the child safety locks are activated when the car is switched off, the function will continue to be activated next time the car is started.

Symbol	Message	Specification
	<b>Rear child lock Activated</b>	Child safety locks are activated.
	<b>Rear child lock Deactivated</b>	Child safety locks are deactivated.

### Related information

- Locking and unlocking from inside the car (p. 262)
- Detachable key blade (p. 245)

## Automatic locking when driving

The doors and tailgate are locked automatically when the car starts to move.

To change this setting:

1. Tap on **Settings** in the centre display's top view.
2. Press **My Car** → **Locking**.
3. Select **Auto Lock Doors While Driving** to deactivate or activate this function.

### Related information

- Locking and unlocking from inside the car (p. 262)

## Opening and closing the power\*-operated tailgate

Function where the tailgate can be opened and closed at the touch of a button.

### Opening

Choose one of the following options to open the power operated tailgate:

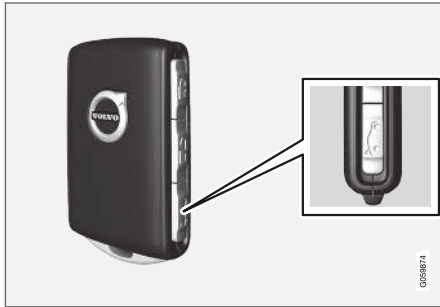

- Long press on the remote control key's  button. Keep it depressed until the tailgate starts to open.



- Long press on the instrument panel's  button. Keep it depressed until the tailgate starts to open.

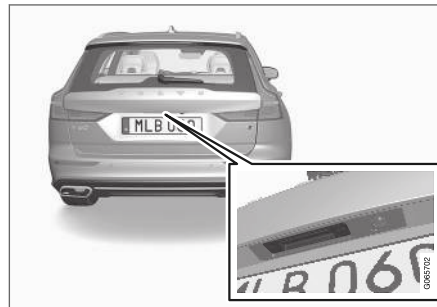

- Light press on the tailgate handle.





- Foot movement\* under the rear bumper.

### Closing

Choose one of the following options to close<sup>14</sup> the power operated tailgate:

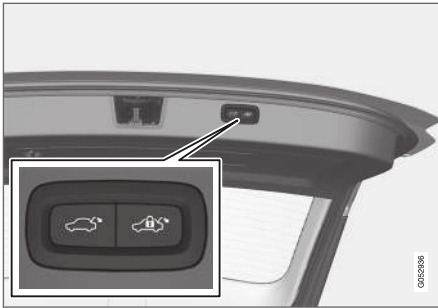

<sup>14</sup> A car with keyless locking and unlocking\* has one button for closing and one button for closing and locking.



- Press the  button on the underside of the tailgate to close.
  - > The tailgate closes automatically and remains unlocked.

### NOTE

- The button is active 24 hours after the hatch has been left open. Thereafter, it must be closed manually.
- If the flap has been open for more than 30 minutes, it will close at a slow speed.

- Long press on the  button on the remote control key.
  - > The tailgate closes automatically and acoustic signals sound – the tailgate remains unlocked.
- Long press on the  button on the instrument panel.
  - > The tailgate closes automatically and acoustic signals sound – the tailgate remains unlocked.
- Foot movement\* under the rear bumper.
  - > The tailgate closes automatically and acoustic signals sound – the tailgate remains unlocked.

### Closing and locking



- Press the  button on the underside of the tailgate to close it and simultaneously lock<sup>14</sup> the tailgate and doors (all doors must be closed for locking).
  - > The tailgate closes automatically – the tailgate and doors are locked, and the alarm\* is armed.

<sup>14</sup> A car with keyless locking and unlocking\* has one button for closing and one button for closing and locking.



### **i** NOTE

- One of the car's remote control keys must be within range for locking and unlocking to work.
- When using keyless\* locking or closing, three signals will sound if the key is not detected sufficiently close to the tailgate.

### **!** IMPORTANT

During manual tailgate operation, open or close it slowly. Do not use force to open/close it if there is resistance. It may be damaged and stop working correctly.

### Cancel opening or closing

Cancel opening or closing in one of the following ways:

- Press the button on the instrument panel.
- Press the remote control key's button.
- Press the closing button on the underside of the tailgate.
- Press the rubberised pressure plate beneath the outside handle.
- Using a foot movement\*.

The tailgate's movement is interrupted and stops. The tailgate can then be operated manually.

If the tailgate is stopped close to closed position, the next activation will open the tailgate.

### Pinch protection

If something with sufficient resistance prevents the tailgate from opening or closing then the pinch protection is activated.

- During opening - movement is interrupted, the tailgate stops and a long acoustic signal sounds.
- During closing - movement is interrupted, the tailgate stops, a long acoustic signal sounds and the tailgate returns to the programmed max. position.

### **!** WARNING

Watch out for the risk of crushing when opening and closing.

Check that there is nobody near the tailgate before starting to open or close it as a crush injury may have severe consequences.

Always operate the tailgate with caution.

### Pre-tensioned springs

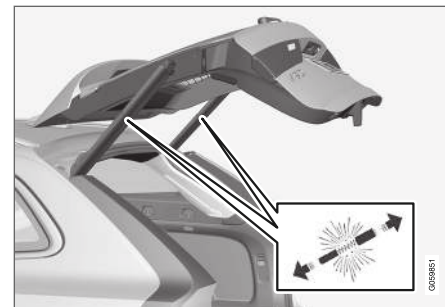

The pre-tensioned springs for the power operated tailgate.

### **!** WARNING

Do not open the pre-tensioned springs for the power operated tailgate. They are pre-tensioned with high pressure and can cause injury if opened.

### Related information

- Programming maximum opening for power operated tailgate\* (p. 269)
- Opening and closing the tailgate with foot movement\* (p. 269)
- Remote control key range (p. 239)

## Programming maximum opening for power operated tailgate\*

Adapt the tailgate's opening position to low roof height.

To adjust max. opening:

1. Open the tailgate - stop it in the open position.

### NOTE

It is not possible to program an opening position lower than half-open tailgate.

2. Press the  button on the underside of the tailgate for at least 3 seconds.
  - > Two short acoustic signals sound to indicate that the set position has been saved.

To reset max. opening:

- Manually move the tailgate to its highest possible position – press and hold the  button on the tailgate for at least 3 seconds.
  - > Two acoustic signals sound to indicate that the set position has been cleared. The tailgate will then assume its maximum position when opened.

### NOTE

- If the system has been operating continuously for a long time, it is switched off to avoid overload. It can be used again after about 2 minutes.

### Related information

- Opening and closing the power\*-operated tailgate (p. 266)

## Opening and closing the tailgate with foot movement\*

A function which allows the tailgate to open and close by moving a foot under the rear bumper makes life easier when your hands are full.

If the car is equipped with keyless locking and unlocking\* then you can unlock the tailgate with a foot movement.

The function with both opening and closing of the tailgate is also available when the car is equipped with power operated tailgate\*.

### NOTE

The foot-operated tailgate function is available in two versions:

- Opening and closing with foot movement
- Only unlocking with foot movement (lift up the tailgate manually to open it)

Note that the function for opening and closing with foot movement requires power operated tailgate\*.

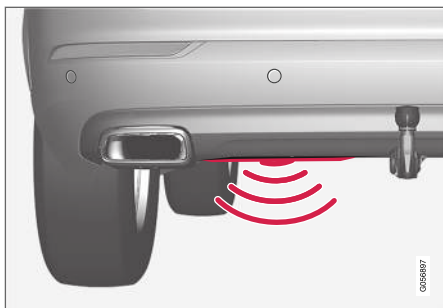

The sensor is located on left of centre in the bumper.

One of the car's remote control keys must be within range behind the car, approx. 1 metre (3 feet), for opening and closing to be possible. This also applies to an already unlocked car in order to avoid accidental opening e.g. in a car wash.

### Opening and closing with foot movement



Kicking motion within the detector's activation area.

- Make **one** slow, forward kicking motion under the left part of the rear bumper. Then take a step back. The bumper must not be touched.
  - > A short acoustic signal sounds when opening or closing is activated - the tailgate is opened/closed.

If several kicking motions take place without an approved remote control key being located behind the car, opening will not be possible until after a certain delay.

Do not leave your foot positioned under the car during the kicking motion. This could cause activation to fail.

### Cancelling opening or closing with foot movement

- Make **one** slow forward kicking motion when opening or closing is in progress in order to stop the movement of the tailgate.

The remote control key does not have to be in the vicinity of the car to cancel opening or closing of the tailgate.

If the tailgate is stopped close to closed position, the next activation will open the tailgate.

#### **i** NOTE

There is a risk of reduced function, or no function, if the rear bumper is loaded with large amounts of ice, snow, dirt or similar. For this reason, make sure you keep it clean.

#### **i** NOTE

Pay attention to the possibility that the system may be activated in a car wash or similar if the remote key is within range.

### Related information

- Keyless and touch-sensitive surfaces\* (p. 258)
- Opening and closing the power\*-operated tailgate (p. 266)
- Remote control key range (p. 239)



## Private locking

The tailgate can be locked with the private locking function which prevents it from being opened, e.g. when the car is taken in for service, left at a hotel or similar.



The private locking function button is located in the centre display function view. Depending on the current status of the lock, **Private Locking Unlocked** or **Private Locking Locked** is shown.

### Related information

- Activating and deactivating private locking (p. 271)

## Activating and deactivating private locking

Private locking is activated with a function button in the centre display and an optional PIN code.

### NOTE

The car needs to be in ignition mode I as a minimum for the private locking function to be activated.

Private locking has two codes:

- A security code is created the first time the function is used.
- A new PIN code is selected every time the function is activated.

### Enter the security code before using for the first time

A security code needs to be selected during the first time the function is used. It can then be used to deactivate private locking if the selected PIN code has been forgotten or lost. The security code acts as a PUK code for all subsequent PIN codes set for the private locking function.

Save the security code in a safe place.

To create a security code:

1. Press the button for private locking in the function view.



> A pop-up window is shown.

2. Enter the preferred security code and press **Confirm**.
  - > The security code is saved. The private locking function is now ready for activation.

### Activate private locking

1. Press the button for private locking in the function view.



> A pop-up window is shown.

- ◀ 2. Enter the code to be used in order to unlock the tailgate after locking and tap on **Confirm**.
- > The tailgate is locked. Confirmation of locking takes place by means of a green indicator being shown by the button in the function view.

### Deactivate private locking

1. Press the button for private locking in the function view.



- > A pop-up window is shown.
2. Enter the code that was used for locking and tap on **Confirm**.
- > The tailgate is unlocked. Confirmation of unlocking takes place by means of the green indicator by the button in the function view extinguishing.

### Forgotten PIN code

If the PIN code has been forgotten or the wrong PIN code has been entered more than three times, the security code can be used to deactivate private locking.

If the car is unlocked via Volvo On Call\* or the Volvo On Call app, private locking will be deactivated automatically.

### Forgotten security code

If the security code has also been forgotten, contact an authorised Volvo dealer for help with deactivating private locking.

### Related information

- Private locking (p. 271)

### Alarm\*

The alarm provides audible and visual warnings if anyone enters the car without a valid remote control key or manipulates the starter battery or alarm siren.

When armed, the alarm is triggered if:

- a door, the bonnet or the tailgate is opened<sup>15</sup>
- a movement is detected in the passenger compartment (if fitted with a movement detector\*)
- the car is raised or towed away (if fitted with a tilt detector\*)
- the starter battery's cable is disconnected
- the siren is disconnected.

### Alarm signals

When the alarm has been triggered, the following happens:

- A siren sounds for 30 seconds or until the alarm is switched off.
- Hazard warning flashers flash for 5 minutes or until the alarm is switched off.

If the cause of alarm activation is not rectified, the alarm cycle is repeated up to 10 times<sup>15</sup>.

<sup>15</sup> Applies to certain markets.

## Alarm indicator

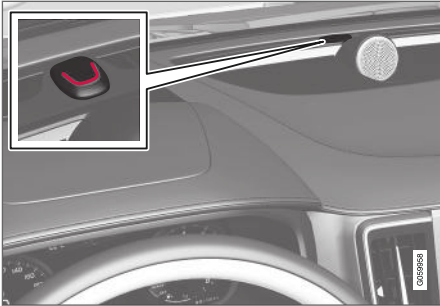

A red LED on the instrument panel indicates the alarm system's status:

- LED not lit – alarm not armed.
- The LED flashes once every other second – alarm is armed.
- After the alarm has been disarmed, the LED flashes rapidly for a maximum of 30 seconds or until ignition position **I** has been activated – the alarm has been triggered.

## Movement and tilt sensors\*

Movement and tilt sensors react to movements inside the car, if the window is broken or if anyone tries to steal the wheels or tow the vehicle away.

The movement sensor triggers an alarm in the event of movement in the passenger compart-

ment - air currents are also registered. For this reason the alarm is triggered if the car is left with a window or the panoramic roof\* open or if the passenger compartment heater is used.

To avoid this:

- Close the window and panoramic roof when leaving the car.
- If the passenger compartment or parking heater is to be used – direct the airflow from the air vents so that they do not point upwards in the passenger compartment.

Alternatively, use a reduced alarm level to temporarily deactivate the movement and tilt sensors.

Also switch off the movement and tilt sensors when the car is being transported on a ferry or train as these movements may affect the car and trigger the alarm.

## In the event of an alarm system fault



If there is a fault in the alarm system, the driver display shows the symbol and the message **Alarm system failure Service required**. In which case, contact a workshop - an authorised Volvo workshop is recommended.

## **i** NOTE

Do not attempt to repair or alter components in the alarm system yourself. Any such attempts may affect the terms of the insurance.

## Related information

- Activating and deactivating alarms\* (p. 274)
- Reduced alarm level\* (p. 275)
- Double lock\* (p. 275)

## Activating and deactivating alarms\*

The alarm is armed when the car is locked.

### Arming the alarm

Lock and arm the car alarm as follows

- press the remote control key's lock button .
- touch the marked surface on the outside of the door handles or the tailgate's rubberised pressure plate<sup>16</sup>.

If the car is equipped with both keyless locking/unlocking\* and a power-operated tailgate\*, the  button on the underside of the tailgate can also be used to lock the car and arm the car alarm.

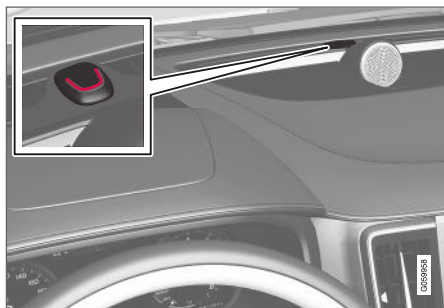

A red LED on the instrument panel flashes once every two seconds when the car is locked and the alarm is armed.

<sup>16</sup> Applies to cars with keyless locking and unlocking\*.

### Deactivate the alarm

Unlock and disarm the car alarm as follows

- press the remote control key's unlock button .
- grip one of the door handles or press gently on the tailgate's rubberised pressure plate<sup>16</sup>.

### Deactivate the alarm without a functioning remote control key

The car can be unlocked and disarmed even if the remote control key does not work, e.g. if the remote control key's battery is dead.

1. Open the driver's door with the detachable key blade.
  - > The alarm is triggered.



The backup reader's location in the cup holder.

2. Place the remote control key on the key symbol in the backup reader in the tunnel console's cup holder.

3. Turn the start knob clockwise and release it.
  - > The alarm is deactivated.

### Switching off a triggered alarm

- Press the remote control key's unlock button or set the car in ignition position **I** by turning the start knob clockwise and then releasing.

### Automatic arming and rearming of the alarm

Automatic rearming of the alarm prevents the car being left with the alarm disarmed unintentionally.

If the car is unlocked with the remote control key (which disarms the alarm) but none of the doors or the tailgate is opened within two minutes, then the alarm is automatically re-armed. The car is relocked at the same time.

In certain markets, the alarm is armed automatically after a certain delay after the driver's door has been opened and closed without being locked.

To change this setting:

1. Tap on **Settings** in the centre display's top view.
2. Press **My Car** → **Locking**.
3. Select **Passive Arming Deactivation** to deactivate the function temporarily.

## Related information

- Alarm\* (p. 272)

## Reduced alarm level\*

A reduced alarm level means that the movement and tilt sensors are temporarily switched off.

Switch off the movement and tilt detectors in order to avoid accidental triggering of the alarm - e.g. if a dog is left in a locked car or during transport on a car train or car ferry.



Press the **Reduced Guard** button in the centre display function view to switch off the movement and tilt sensors when subsequently locking the car.

At the same time, the double lock function is deactivated, i.e. unlocking from inside is possible.

If the car is unlocked and then locked again, the reduced alarm level must be reactivated.

## Related information

- Alarm\* (p. 272)
- Double lock\* (p. 275)

## Double lock\*

Double lock means that all opening handles are released mechanically when locking from the outside, which makes it impossible to open the doors from the inside.

Double lock is activated when locking with a remote control key or with keyless locking\*, and takes place with a delay of approx. 10 seconds after the doors have locked. If a door is opened within the delay time then the sequence is interrupted and the alarm is deactivated.

The car can only be unlocked with a remote control key, keyless unlocking\* or the Volvo On Call\* app when double lock is activated.

The front left door can also be unlocked with the detachable key blade. If the car is unlocked with the detachable key blade, the alarm will be triggered.

### **i** NOTE

- Remember that the alarm is activated when the car is locked.
- The alarm is triggered if anyone attempts to open the doors from inside.

### **⚠** WARNING

Do not allow anyone to remain in the car without first deactivating the function in order to avoid the risk of anyone being locked in.



#### ◀◀ **Related information**

- Temporarily\* deactivating double locks (p. 276)
- Alarm\* (p. 272)

### **Temporarily\* deactivating double locks**

If someone is going to stay in the car but the doors must be locked from the outside, then the double lock function should be deactivated, to allow unlocking from the inside.

#### **WARNING**

Do not allow anyone to remain in the car without first deactivating the function in order to avoid the risk of anyone being locked in.



Press the **Reduced Guard** button in the centre display's function view in order to deactivate the double lock function temporarily.

This also means that the alarm's movement and tilt detectors\* are switched off.

After this, **Reduced Guard** is shown in the centre display and double locks are temporarily deactivated in the subsequent locking of the car.

In conventional locking, the electrical sockets are deactivated immediately, but when double locks are temporarily deactivated, they will be active for a maximum of 10 minutes after locking.

If the car is unlocked and then locked again, the double lock function must be deactivated again.

The system is reset the next time the engine is started.

#### **Related information**

- Double lock\* (p. 275)
- Alarm\* (p. 272)

DRIVER SUPPORT

## Driving support systems

The car is equipped with different driver support systems which can assist the driver in different situations, either actively or passively.

For example, the systems can help the driver to:

- maintain a set speed
- maintain a certain time interval to the vehicle ahead
- prevent a collision by giving a warning to the driver and braking the car
- help the driver to park.

Some of the systems are fitted as standard while others are options – which alternative applies is market dependent.

### Related information

- IntelliSafe – driver support and safety (p. 31)
- Speed-dependent steering force (p. 278)
- Electronic stability control (p. 279)
- Speed limiter (p. 284)
- Automatic speed limiter (p. 288)
- Distance Warning\* (p. 296)
- Cruise control (p. 291)
- Adaptive cruise control\* (p. 298)
- Pilot Assist (p. 307)
- Radar unit (p. 323)
- Camera unit (p. 329)

- City Safety™ (p. 335)
- Rear Collision Warning (p. 350)
- BLIS\* (p. 351)
- Cross Traffic Alert\* (p. 355)
- Road Sign Information\* (p. 359)
- Driver Alert Control (p. 366)
- Lane assistance (p. 368)
- Steering assistance at risk of collision (p. 375)
- Park Assist\* (p. 381)
- Park assist camera\* (p. 386)
- Park Assist Pilot\* (p. 394)

## Speed-dependent steering force

Speed related power steering causes the steering wheel force to increase with the speed of the car in order to give the driver enhanced sensitivity.

On motorways the steering feels firmer. When parking and at low speed steering is light and requires only a slight effort.

### NOTE



In rare situations the power steering may become too hot and then needs to be temporarily cooled – during this time the power steering operates with reduced power and turning the steering wheel may then be perceived to be slightly heavier.

In parallel with the temporarily reduced steering assistance, the driver display shows the message **Power steering Assistance temporarily reduced** as well as this symbol.

While the power steering is working at reduced power, the driver support functions and steering assistance system are not available.



**⚠ WARNING**

If the temperature increases too much, the servo may be forced to switch off completely. In such a situation, the driver display shows the **Power steering failure Stop safely** message, combined with a symbol.

**Change the steering force level\***

Steering wheel resistance can be adjusted when using INDIVIDUAL drive mode.

1. Tap on **Settings** in the centre display's top view.
2. Select **My Car → Drive Modes → Steering Force**.

Steering wheel resistance selection can only be accessed if the car is stationary or is moving at low speed and in a straight line.

**Related information**

- Driving support systems (p. 278)
- Drive modes (p. 447)

**Electronic stability control**

Electronic Stability Control (ESC<sup>1</sup>) helps the driver to avoid skidding and improves the car's traction.



The driver display shows this symbol when the system is engaged.

Braking from the system may be heard as a pulsing sound, and the car may accelerate

more slowly than expected when applying the throttle.

The system consists of the following subfunctions:

- Stability function<sup>2</sup>
- Spin control and traction control system
- Engine Drag Control
- Trailer stability assist

**⚠ WARNING**

- The function is supplementary driver support intended to facilitate driving and make it safer – it cannot handle all situations in all traffic, weather and road conditions.
- The driver is advised to read all sections in the Owner's Manual that relate to this function to learn about factors such as its limitations and what the driver should be aware of before using the system.
- Driver support functions are not a substitute for the driver's attention and judgement. The driver is always responsible for ensuring the car is driven in a safe manner, at the appropriate speed, with an appropriate distance to other vehicles, and in accordance with current traffic rules and regulations.

**Stability function<sup>2</sup>**

The function checks the driving and brake force of the wheels individually in order to stabilise the car.

**Spin control and traction control system**

The function is active at low speed and brakes the drive wheels that spin so that additional trac-

<sup>1</sup> Electronic Stability Control

<sup>2</sup> Also known as Active Yaw Control.

- ◀ tion shall be transferred from the drive wheels that are not spinning.

The function also prevents the driving wheels from spinning against the road surface during acceleration.

### Engine Drag Control

Engine Drag Control (EDC<sup>3</sup>) prevents involuntary wheel locking, e.g. after shifting down or engine braking when driving in low gear on slippery road surfaces.

Involuntary wheel locking while driving can, amongst other things, impair the driver's ability to steer the car.

### Trailer stability assist\*<sup>4</sup>

Trailer stability assist (TSA<sup>5</sup>) stabilises a car towing a trailer in situations where they begin snaking.

#### NOTE

Trailer Stability Assist is deactivated if **ESC Sport Mode** is activated.

### Related information

- Driving support systems (p. 278)
- Activating/deactivating sport mode for Electronic Stability Control (p. 281)

<sup>3</sup> Engine Drag Control

<sup>4</sup> Trailer stability assist is included when the Volvo genuine towbar is installed.

<sup>5</sup> Trailer Stability Assist

- Symbols and messages for electronic stability control (p. 282)
- Trailer stability assist\* (p. 474)

## Electronic Stability Control in sport mode

The stability system (ESC<sup>6</sup>) is always activated – it cannot be switched off. However, the driver can select **ESC Sport Mode**, which allows for a more active driving experience.

With the **ESC Sport Mode** subfunction selected, intervention from the system is reduced and the car is allowed to skid more and greater control than normal is thus transferred to the driver.

When **ESC Sport Mode** is selected, the function can be considered as deactivated, despite the function continuing to help the driver in many cases.

#### NOTE

With **ESC Sport Mode** selected, Trailer Stability Assist (TSA<sup>7</sup>) is deactivated.

**ESC Sport Mode** also provides maximum traction if the car has become bogged down or is driving on a loose surface, such as in sand or deep snow.

The **ESC Sport Mode** function cannot be selected when one of the following functions is activated:

- Speed limiter
- Cruise control
- Adaptive cruise control\*
- Pilot Assist

### Related information

- Electronic stability control (p. 279)
- Activating/deactivating sport mode for Electronic Stability Control (p. 281)
- Trailer stability assist\* (p. 474)

## Activating/deactivating sport mode for Electronic Stability Control

The stability system (ESC<sup>6</sup>) is always activated – it cannot be switched off. However, the driver can select sport mode, which allows for a more active driving experience.



Activate or deactivate the function using this button in the centre display's function view.

- GREEN button indication – the function is activated.
- GREY button indication – the function is deactivated.



The driver display indicates activated **ESC Sport Mode** by displaying this symbol with a constant glow until the function is deactivated or the engine is switched off. The next time the engine is started, the system is back in its normal mode again.

### Related information

- Electronic Stability Control in sport mode (p. 280)
- Electronic stability control (p. 279)

<sup>6</sup> Electronic Stability Control





<sup>7</sup> Trailer Stability Assist

<sup>8</sup> Electronic Stability Control

## Symbols and messages for electronic stability control

A number of symbols and messages regarding electronic stability control (ESC<sup>9</sup>) can be shown on the driver display.

The following table shows some examples.

Symbol	Message	Specification
	Constant glow for approx. 2 seconds.	System check when the engine is started.
	Flashing light.	The system is being activated.
	Constant glow.	Sport mode is selected. <b>NOTE:</b> The system is not deactivated in this mode — it is partly reduced.
	ESC Temporarily off	The system has been temporarily reduced due to excessive brake temperature - the function is reactivated automatically when the brakes have cooled. See the message in the driver display.
	ESC Service required	The system is disengaged. <ul style="list-style-type: none"> <li>Stop the car in a safe place, switch off the engine and start it again.</li> </ul>

<sup>9</sup> Electronic Stability Control

A text message can be cleared by briefly pressing the  button, located in the centre of the steering wheel's right-hand keypad.

If a message remains: Contact a workshop – an authorised Volvo workshop is recommended.

**Related information**



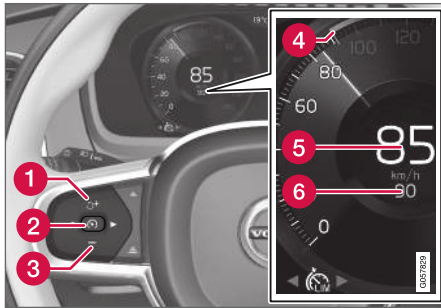

- Electronic stability control (p. 279)

## Speed limiter

A speed limiter (SL<sup>10</sup>) can be likened to a reverse cruise control - the driver regulates the speed using the accelerator pedal but is prevented from accidentally exceeding a pre-selected/set maximum speed by the speed limiter.



Buttons and symbols for the function.

- 1  : Activates the speed limiter from standby mode and resumes stored maximum speed
- 1  : Increases the stored maximum speed
- 2  : **From standby mode** – activates the speed limiter and stores current speed
- 2  : **From active mode** – deactivates/changes the speed limiter to standby mode

- 3  : Reduces stored maximum speed
- 4 Marker for stored max speed
- 5 The car's current speed
- 6 Stored maximum speed

### WARNING

- The function is supplementary driver support intended to facilitate driving and make it safer – it cannot handle all situations in all traffic, weather and road conditions.
- The driver is advised to read all sections in the Owner's Manual that relate to this function to learn about factors such as its limitations and what the driver should be aware of before using the system.
- Driver support functions are not a substitute for the driver's attention and judgement. The driver is always responsible for ensuring the car is driven in a safe manner, at the appropriate speed, with an appropriate distance to other vehicles, and in accordance with current traffic rules and regulations.

### Related information

- Driving support systems (p. 278)
- Limitations for speed limiter (p. 287)
- Activating and starting the Speed Limiter (p. 285)
- Deactivating the speed limiter (p. 287)
- Deactivate the speed limiter and set it in standby mode (p. 285)
- Reactivating the speed limiter from standby mode (p. 286)
- Set the stored speed for driver support (p. 319)
- Automatic speed limiter (p. 288)

<sup>10</sup> Speed Limiter

## Activating and starting the Speed Limiter

The speed limiter function (SL<sup>11</sup>) must first be selected and activated in order to be able to regulate the speed.

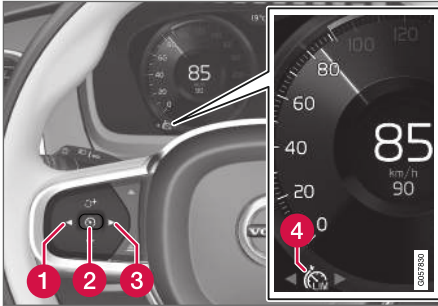

### Set the speed limiter in standby mode



- Press ◀ (1) or ▶ (3) to browse to the symbol/function for speed limiter  (4).
  - > Symbol (4) is shown and the speed limiter is set in standby mode.

### Start the Speed Limiter

The speed limiter cannot be activated until after the engine has been started. The lowest maximum speed that can be stored is 30 km/h (20 mph).

- When the speed limiter is in standby mode and the  symbol is shown – press the steering wheel button  (2).
  - > The Speed Limiter starts and the current speed is stored as the maximum speed.

### Related information

- Speed limiter (p. 284)
- Deactivating the speed limiter (p. 287)
- Reactivating the speed limiter from standby mode (p. 286)
- Deactivate the speed limiter and set it in standby mode (p. 285)

## Deactivate the speed limiter and set it in standby mode

The speed limiter (SL<sup>12</sup>) can be temporarily deactivated and set in standby mode.

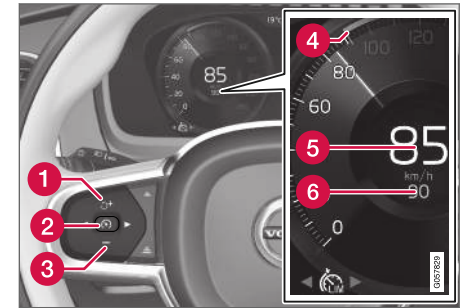

To deactivate the Speed Limiter and set it in standby mode:

- Press the steering wheel button  (2).
  - > The speed limit markings and symbols in the driver display change colour from WHITE to GREY – the speed limiter is now temporarily deactivated and the driver can exceed the maximum speed setting.

<sup>11</sup> Speed Limiter

<sup>12</sup> Speed Limiter

#### ◀ Temporary deactivation with the accelerator pedal

The speed limiter can also be temporarily deactivated and overridden with the accelerator pedal without the speed limiter first having to be set in standby mode - e.g. to be able to quickly accelerate the car out of a situation.

In which case, proceed as follows:

1. Fully depress the accelerator pedal and release it to interrupt acceleration when the desired speed has been reached.
  - > In this mode, the speed limiter is still activated and the driver display's symbol is therefore WHITE.
2. Fully release the accelerator pedal when the temporary acceleration is finished.
  - > The car is then engine-braked automatically to below the last stored maximum speed.

#### Related information

- Speed limiter (p. 284)
- Reactivating the speed limiter from standby mode (p. 286)
- Activating and starting the Speed Limiter (p. 285)
- Deactivating the speed limiter (p. 287)

#### Reactivating the speed limiter from standby mode

The speed limiter (SL<sup>13</sup>) can be reactivated after having been temporarily deactivated and placed in standby mode.

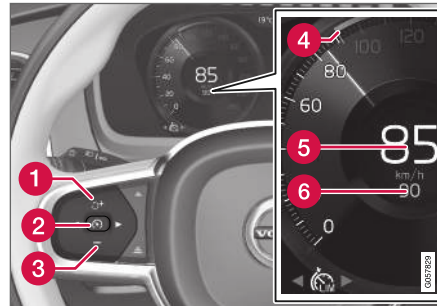

To reactivate the Speed Limiter from standby mode:

- Press the steering wheel button  (1).
  - > The driver display's speed limit markings change colour from GREY to WHITE - the car's speed is then limited again by the last stored maximum speed.

or

- Press the steering wheel button  (2).
  - > The speed limiter indicators and symbols in the driver display change colour from GREY to WHITE - the car will now apply its current speed as the maximum speed.

#### Related information

- Speed limiter (p. 284)
- Deactivate the speed limiter and set it in standby mode (p. 285)
- Activating and starting the Speed Limiter (p. 285)
- Deactivating the speed limiter (p. 287)

<sup>13</sup> Speed Limiter





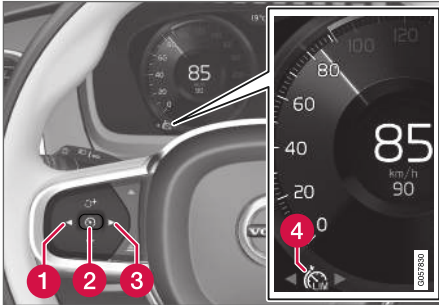

## Deactivating the speed limiter

The speed limiter (SL<sup>14</sup>) can be deactivated.



To deactivate the cruise control:

1. Press the steering wheel button  (2).
  - > The speed limiter is set in standby mode.
2. Press the steering wheel button  (1) or  (3) to change to another function.
  - > The driver display's symbol and indicator for speed limiter (4) are switched off - which deletes the set/stored maximum speed.
3. Press the steering wheel button  (2) again.
  - > Another function is activated.

## Related information

- Speed limiter (p. 284)
- Activating and starting the Speed Limiter (p. 285)
- Reactivating the speed limiter from standby mode (p. 286)
- Deactivate the speed limiter and set it in standby mode (p. 285)

## Limitations for speed limiter

On steep downhill gradients the speed limiter's (SL<sup>15</sup>) braking effect may be inadequate and hence the stored maximum speed may be exceeded. In this case, the driver is alerted by the message **Speed limit exceeded** in the driver display.

### NOTE

A text message that the maximum speed is exceeded will be activated if the speed has been exceeded by at least 3 km/h (approx. 2 mph).

## Related information

- Speed limiter (p. 284)

<sup>14</sup> Speed Limiter

<sup>15</sup> Speed Limiter

## Automatic speed limiter

The Automatic Speed Limiter (ASL<sup>16</sup>) function helps the driver to adapt the car's maximum speed to the speed shown on the road signs.

The Speed Limiter function (SL<sup>17</sup>) can be changed to Automatic Speed Limiter (ASL).

The automatic speed limiter uses speed information from the Road Sign Information\* (RSI<sup>18</sup>) function to automatically adapt the car's maximum speed.

### WARNING



- Even if the driver clearly sees the speed-related road sign, the speed information from the Road Sign Information\* (RSI) function to ASL may be incorrect – in such cases the driver must intervene him/herself and accelerate or brake to a suitable speed.

### WARNING

- The function is supplementary driver support intended to facilitate driving and make it safer – it cannot handle all situations in all traffic, weather and road conditions.
- The driver is advised to read all sections in the Owner's Manual that relate to this function to learn about factors such as its limitations and what the driver should be aware of before using the system.
- Driver support functions are not a substitute for the driver's attention and judgement. The driver is always responsible for ensuring the car is driven in a safe manner, at the appropriate speed, with an appropriate distance to other vehicles, and in accordance with current traffic rules and regulations.

## Is SL or ASL active?

Symbols in the driver display show which speed limiter function is active:

Symbol	SL	ASL
 A	✓	✓
 Sign symbol after "70" = ASL is activated.		✓

A WHITE symbol: Function active, GREY symbol: Standby mode.

<sup>16</sup> Automatic Speed Limiter

<sup>17</sup> Speed Limiter

<sup>18</sup> Road Sign Information

## The ASL symbol



The sign symbol (displayed alongside the stored speed, "70", in the centre of the speedometer) can be shown in three colours with the following meanings:

Colour of sign symbol	Meaning
Greenish yellow	ASL is active
Grey	ASL has been set in standby mode
Amber/Orange	ASL is in temporary standby mode - e.g. due to a traffic sign not being read.

## Related information

- Driving support systems (p. 278)
- Activate/deactivate Automatic Speed Limiter (p. 289)
- Changing the tolerance for the automatic speed limiter (p. 290)
- Limitations for automatic speed limiter (p. 291)
- Speed limiter (p. 284)
- Road Sign Information\* (p. 359)

<sup>19</sup> Automatic Speed Limiter

<sup>20</sup> Speed Limiter

<sup>21</sup> Road Sign Information – RSI

## Activate/deactivate Automatic Speed Limiter

The automatic speed limiter function (ASL<sup>19</sup>) can be activated and deactivated as a supplement to the speed limiter (SL<sup>20</sup>).

### Activate ASL



The **Speed Sign Assist** button is located in the function view of the centre display.

To activate the automatic speed limiter:

1. Press the **Speed Sign Assist** button.
  - > ASL is set in standby mode, a green indicator appears on the button, and the driver display shows a sign symbol in the centre of the speedometer.
2. Press the steering wheel button .
  - > ASL is activated with the car's current speed.

### NOTE

- If the automatic speed limiter function is activated, Road Sign Information\* is shown in the driver display even if RSI<sup>21</sup> is not activated.
- To remove road sign information from the driver display, you must deactivate **both** automatic speed limiter and RSI.
- When the Automatic Speed Limiter function is activated but RSI is deactivated, no warnings are given from RSI. RSI must also be activated in order to receive warnings.

### Deactivate ASL

To deactivate the automatic speed limiter:

- Tap on the **Speed Sign Assist** button in the function view.
  - > ASL is deactivated and the button's indication becomes GREY - SL is activated instead.

### WARNING

After switching from ASL to SL the car will no longer follow the signed speed limit but only the maximum speed stored in memory.



## ◀ Related information

- Speed limiter (p. 284)
- Automatic speed limiter (p. 288)
- Limitations for automatic speed limiter (p. 291)
- Road Sign Information\* (p. 359)

## Changing the tolerance for the automatic speed limiter

The Automatic Speed Limiter function (ASL<sup>22</sup>) can be set for different tolerance levels.

It is possible to increase/decrease the signed speed limit. If, for example, the car follows a signed speed limit of 70km/h (43 mph) the driver can instead choose to allow the car to maintain 75 km/h (47 mph).

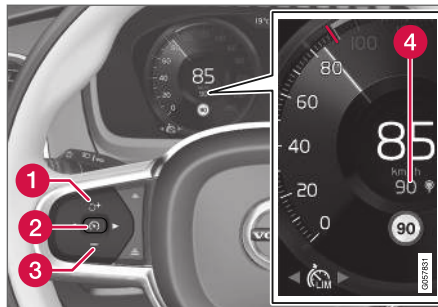

Buttons and symbols for the function.

- Press the steering wheel button **+** (1) until 70 km/h (43 mph) in the centre of the speedometer (4) changes to 75 km/h (47 mph).
  - > After which, the car uses the selected tolerance 5 km/h (4 mph) as long as signs passed are showing 70 km/h (43 mph).  
The tolerance is followed until a road sign with a lower or higher speed is passed - then the car follows the new signed speed limit instead and the tolerance is deleted from the memory.

If the Road Sign Information\*<sup>23</sup> function is activated, the signed speed limit will also be shown with a coloured indicator on the speedometer.

The tolerance is adjusted in the same way as the speed setting is in the speed limiter.

### **i** NOTE

The maximum selectable tolerance is +/- 10 km/h (5 mph).

<sup>22</sup> Automatic Speed Limiter

<sup>23</sup> Road Sign Information - RSI

## Related information

- Automatic speed limiter (p. 288)
- Limitations for automatic speed limiter (p. 291)
- Road Sign Information\* (p. 359)

## Limitations for automatic speed limiter

Automatic speed limitation (ASL<sup>24</sup>) takes place using speed information from the Road Sign Information function\* (RSI<sup>25</sup>) – not from the speed limit road signs that the car passes.

If RSI cannot interpret and provide speed information to the ASL, then the ASL is set in standby mode and changes over to SL. In such cases the driver must intervene and brake to a suitable speed.

The ASL will be reactivated when the RSI function can once again interpret and provide speed information to the ASL.

## Related information

- Speed limiter (p. 284)
- Automatic speed limiter (p. 288)
- Road Sign Information\* (p. 359)

## Cruise control

The cruise control (CC<sup>26</sup>) helps the driver maintain an even speed, which can result in more relaxed driving on motorways and long, straight roads in regular traffic flows.

### Overview

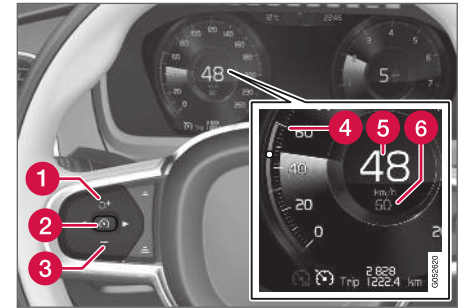

Buttons and symbols for the function.

- 1 : Activates cruise control from standby mode and resumes stored speed
- 1 : Increases the stored speed
- 2 : **From standby mode** – activates cruise control and stores current speed
- 2 : **From active mode** – deactivates/changes cruise control to standby mode

<sup>24</sup> Automatic Speed Limiter

<sup>25</sup> Road Sign Information – RSI

<sup>26</sup> Cruise Control

- ◀◀ **3** — : Reduces stored speed
- 4** Marker for stored speed
- 5** The car's current speed
- 6** Stored speed

**i NOTE**

In cars equipped with adaptive cruise control\* (ACC<sup>27</sup>), it is possible to switch between cruise control and adaptive cruise control.

**⚠ WARNING**

- The function is supplementary driver support intended to facilitate driving and make it safer – it cannot handle all situations in all traffic, weather and road conditions.
- The driver is advised to read all sections in the Owner's Manual that relate to this function to learn about factors such as its limitations and what the driver should be aware of before using the system.
- Driver support functions are not a substitute for the driver's attention and judgement. The driver is always responsible for ensuring the car is driven in a safe manner, at the appropriate speed, with an appropriate distance to other vehicles, and in accordance with current traffic rules and regulations.

**Using engine braking instead of the foot brake**

With Cruise Control, speed is regulated with less frequent application of the foot brake. On a downhill gradient it may sometimes be desirable to start moving a little faster and limit the acceleration by engine braking. In this case the driver can temporarily disable foot brake application by Cruise Control.

To do so, proceed as follows:

- Depress the accelerator pedal about halfway down and release.
  - > Cruise Control will disengage its automatic foot braking and then uses engine braking only.

**Related information**

- Driving support systems (p. 278)
- Activating and starting Cruise Control (p. 293)
- Deactivate cruise control and set it in standby mode (p. 293)
- Reactivating cruise control from standby mode (p. 294)
- Deactivating cruise control (p. 295)
- Set the stored speed for driver support (p. 319)
- Change between cruise control and adaptive cruise control\* (p. 303)

<sup>27</sup> Adaptive Cruise Control

## Activating and starting Cruise Control

The cruise control function (CC<sup>28</sup>) must first be selected and activated in order to be able to regulate the speed.

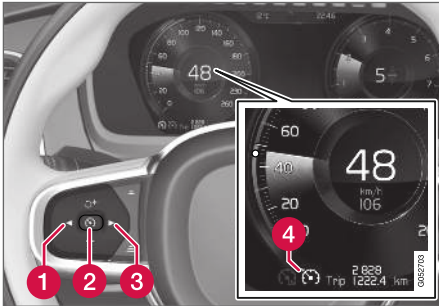

### Set cruise control in standby mode

To set cruise control in standby mode:



- Press ◀ (1) or ▶ (3) to browse to the symbol/function  (4).
- > The symbol is shown and the cruise control can then be activated.

### Activating/starting cruise control

In order to start the cruise control from the standby mode, the car's current speed must be

30 km/h (20 mph) or higher. The lowest speed that can be stored is 30 km/h (20 mph).

To start the cruise control:

- With the symbol/function  displayed, press the steering wheel button  (2).
- > Cruise Control starts and the current speed becomes the stored speed.

### NOTE

Cruise Control cannot be enabled at speeds below 30 km/h (20 mph).

### Related information

- Cruise control (p. 291)
- Deactivating cruise control (p. 295)
- Deactivate cruise control and set it in standby mode (p. 293)
- Reactivating cruise control from standby mode (p. 294)

## Deactivate cruise control and set it in standby mode

Cruise control (CC<sup>29</sup>) can be temporarily deactivated so that it is set in the standby mode and can be reactivated later.

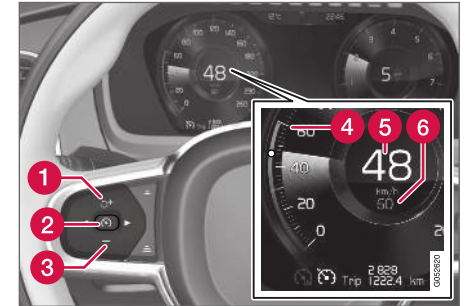

To set cruise control in standby mode:

- Press the steering wheel button  (2).
- > The cruise control markings and symbols in the driver display change colour from WHITE to GREY – cruise control is now temporarily deactivated and the driver must then manually control the speed.

<sup>28</sup> Cruise Control

<sup>29</sup> Cruise Control

#### ◀ **Standby mode on driver intervention**

The cruise control is temporarily deactivated and set in standby mode if:

- the foot brake is used
- the gear selector is moved to **N** position
- the clutch pedal is held depressed for longer than 1 minute
- the driver maintains a speed higher than the stored speed for longer than 1 minute.

The driver must then control the speed himself/herself.

A temporary increase in speed with the accelerator pedal, e.g. during overtaking, does not affect the setting - the car returns to the last stored speed when the accelerator pedal is released.

#### **Automatic standby mode**

Cruise control is temporarily disengaged and set in standby mode if:

- wheels lose traction
- engine speed is too low/high
- brake temperature is too high
- speed falls below 30 km/h (20 mph).

The driver must then control the speed himself/herself.

#### **Related information**

- Cruise control (p. 291)
- Reactivating cruise control from standby mode (p. 294)
- Activating and starting Cruise Control (p. 293)
- Deactivating cruise control (p. 295)

#### **Reactivating cruise control from standby mode**

Cruise control (CC<sup>30</sup>) can be temporarily deactivated so that it is set in the standby mode and can be reactivated later.

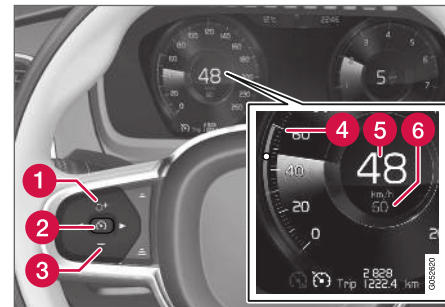

To start cruise control from standby mode:

- Press the steering wheel button  (1).
  - > The cruise control markings and symbols in the driver display change colour from GREY to WHITE — the car will now follow the most recently stored speed again.

or

<sup>30</sup> Cruise Control



To start cruise control from standby mode:

- Press the steering wheel button  (2).
  - > The cruise control markings and symbols in the driver display change colour from GREY to WHITE — the car will now follow the current speed.

### WARNING

A significant increase in speed may follow when the speed is resumed with the  steering wheel button.

### Related information

- Cruise control (p. 291)
- Deactivating cruise control (p. 295)
- Deactivate cruise control and set it in standby mode (p. 293)
- Activating and starting Cruise Control (p. 293)



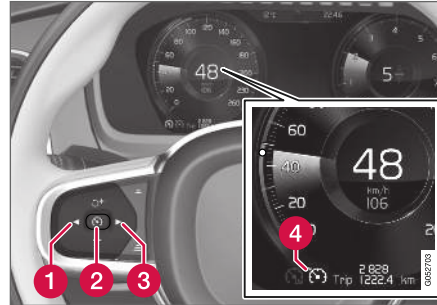

## Deactivating cruise control

Cruise control (CC<sup>31</sup>) can be deactivated.



Buttons and symbols for the function.

To deactivate cruise control:

1. Press the steering wheel button  (2).
  - > Cruise control is set in standby mode.
2. Press the steering wheel button  (1) or  (3) to change to another function.
  - > The driver display's symbol for cruise control  (4) is extinguished - which deletes the set/stored speed.
3. Press the steering wheel button  (2) again.
  - > Another function is activated.

### Related information

- Cruise control (p. 291)
- Change between cruise control and adaptive cruise control\* (p. 303)
- Activating and starting Cruise Control (p. 293)
- Reactivating cruise control from standby mode (p. 294)
- Deactivate cruise control and set it in standby mode (p. 293)

## Distance Warning\*<sup>32</sup>

The Distance Warning function can assist the driver to notice that the time interval to the vehicle ahead may be too short. This requires the car to be equipped with a head-up display\* to be able to display Distance Warning.



Distance Warning symbol on the windscreen with head-up display.

In cars equipped with head-up display, a symbol is shown on the windscreen for as long as the time interval to the vehicle ahead is shorter than the preset value. However, this assumes that the **Show Driver Support** function is activated via the settings in the car's menu system.

Distance warning is active at speeds above 30 km/h (20 mph) and only reacts to the

vehicle ahead travelling in the same direction. No distance information is provided for oncoming, slow or stationary vehicles.

### **i** NOTE

Strong sunlight, reflections, extreme light contrasts, the use of sunglasses, or if the driver is not looking straight ahead may make the visual warning signal in the windscreen difficult to recognise.

### **i** NOTE

Distance warning is deactivated during the time the adaptive cruise control (ACC<sup>33</sup>) or Pilot Assist is active.

### **⚠** WARNING

Distance warning only reacts if the time window to the vehicle ahead is shorter than the preset value – the speed of the driver's vehicle is not affected.

### Related information

- First aid kit\* (p. 587)
- Activating/deactivating Distance warning (p. 297)
- Limitations of Distance Warning (p. 297)

- Set time interval for driver support (p. 318)
- Warning from driver support in the event of a collision risk (p. 316)
- Head-up display\* (p. 135)

<sup>32</sup> Distance Alert

<sup>33</sup> Adaptive Cruise Control

## Activating/deactivating Distance warning<sup>34</sup>

The distance warning function can be deactivated. The function is only available in cars that can show information on the windscreen with a so-called head-up display\*.



Activate or deactivate the function using this button in the centre display's function view.

- GREEN button indication – the function is activated.
- GREY button indication – the function is deactivated.

Distance Warning is activated automatically each time the engine is started.

### Related information

- Distance Warning\* (p. 296)
- Limitations of Distance Warning (p. 297)

## Limitations of Distance Warning<sup>35</sup>

The Distance Warning function may have limitations in certain situations. The function is only available in cars that can show information on the windscreen with a so-called head-up display\*.

### WARNING

- A vehicle's size may affect the ability to be detected, e.g. motorcycles, which could mean that the warning lamp illuminates at a shorter time window than set or that the warning is temporarily absent.
- Extremely high speeds can cause the lamp to illuminate at a shorter time window than that set due to limitations in radar unit range.

### WARNING

- The function is supplementary driver support intended to facilitate driving and make it safer – it cannot handle all situations in all traffic, weather and road conditions.
- The driver is advised to read all sections in the Owner's Manual that relate to this function to learn about factors such as its limitations and what the driver should be aware of before using the system.
- Driver support functions are not a substitute for the driver's attention and judgement. The driver is always responsible for ensuring the car is driven in a safe manner, at the appropriate speed, with an appropriate distance to other vehicles, and in accordance with current traffic rules and regulations.

### NOTE

This function uses the car's camera and radar units, which have certain general limitations.

<sup>34</sup> Distance Alert

<sup>35</sup> Distance Alert

◀◀ **Related information**

- Distance Warning\* (p. 296)
- Limitations for camera and radar unit (p. 330)
- Head-up display\* (p. 135)

**Adaptive cruise control\*<sup>36</sup>**

The adaptive cruise control (ACC<sup>37</sup>) helps the driver to maintain an even speed combined with a pre-selected time interval to the vehicle ahead.

An adaptive cruise control can provide a more relaxing driving experience on long journeys on motorways and long straight main roads in smooth traffic flows.

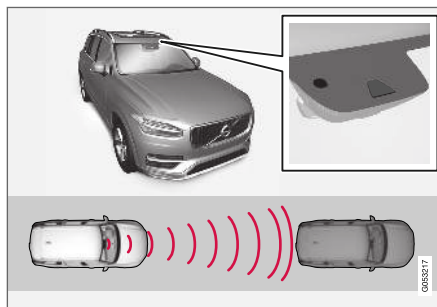

The camera and radar unit measures the distance to the vehicle ahead.

The driver selects the desired speed and a time interval to the vehicle ahead. If the camera and radar unit detects a slower vehicle in front of the car, the speed is adapted automatically via the preset time interval to the vehicle. When the road

is clear again the car returns to the selected speed.

**⚠ WARNING**

- The function is supplementary driver support intended to facilitate driving and make it safer – it cannot handle all situations in all traffic, weather and road conditions.
- The driver is advised to read all sections in the Owner's Manual that relate to this function to learn about factors such as its limitations and what the driver should be aware of before using the system.
- Driver support functions are not a substitute for the driver's attention and judgement. The driver is always responsible for ensuring the car is driven in a safe manner, at the appropriate speed, with an appropriate distance to other vehicles, and in accordance with current traffic rules and regulations.

Adaptive Cruise Control regulates the speed with acceleration and braking. It is normal for the brakes to emit a low sound when they are being used to adjust the speed.

<sup>36</sup> This function can be either standard or optional, depending on market.

<sup>37</sup> Adaptive Cruise Control

The adaptive cruise control aims to control the speed in a smooth way. In situations that demand sudden braking the driver must brake himself/herself. This applies in cases of large speed differences or if the vehicle in front brakes suddenly. Due to the limitations of the radar unit, braking may come unexpectedly or not at all.

The adaptive cruise control aims to follow the vehicle ahead in the same lane at a time interval set by the driver. If the radar unit cannot see any vehicle in front then the car will instead maintain the speed set and stored by the driver. This also takes place if the speed of the vehicle ahead increases and exceeds the stored speed.

### **WARNING**

- This is not a collision avoidance system. The driver is always responsible and must intervene if the system does not detect a vehicle ahead.
- The function does not brake for humans or animals, and not for small vehicles such as bicycles and motorcycles. Nor for low trailers, oncoming, slow or stationary vehicles and objects.
- Do not use the function in demanding situations, such as in city traffic, at junctions, on slippery surfaces, with a lot of water or slush on the road, in heavy rain/snow, in poor visibility, on winding roads or on slip roads.

### **IMPORTANT**

Maintenance of driver support components may only be performed at a workshop<sup>38</sup>.

### **Related information**

- Driving support systems (p. 278)
- Controls and display view for adaptive cruise control\* (p. 300)
- Activating and starting adaptive cruise control\* (p. 300)

- Limitations for adaptive cruise control\* (p. 303)
- Symbols and messages for adaptive cruise control\* (p. 305)
- Warning from driver support in the event of a collision risk (p. 316)
- Set time interval for driver support (p. 318)
- Set the stored speed for driver support (p. 319)
- Automatic braking with driver support (p. 320)
- Change of target with driver support (p. 317)
- Overtaking Assistance (p. 321)

<sup>38</sup> An authorised Volvo workshop is recommended.

## Controls and display view for adaptive cruise control\*

A summary of how adaptive cruise control is controlled using the left-hand keypad on the steering wheel and how the function is shown in the display.

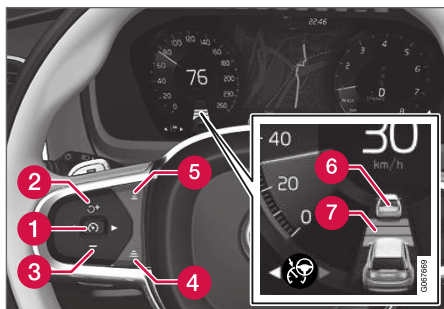

- 1 : **From standby mode** - activates and stores the current speed
- 1 : **From active mode** - deactivates/changes to standby mode
- 2 : Activates the function from standby mode and resumes stored speed
- 2 : Increases the stored speed
- 3 : Reduces stored speed
- 4 : Increases the time interval to vehicles ahead

- 5 Reduces the time interval to vehicles ahead
- 6 Target vehicle indicator: the function has detected and is following a target vehicle at the preset time interval
- 7 Symbol for time interval to vehicles ahead

## Driver display

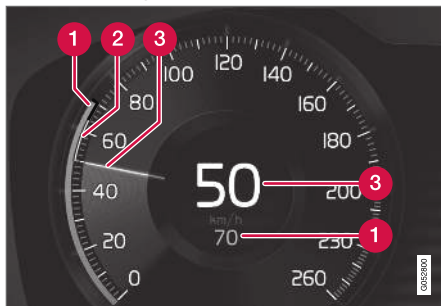

Indication of speeds.

- 1 Stored speed
- 2 Speed of vehicle ahead.
- 3 Current speed of your car.

## Related information

- Adaptive cruise control\* (p. 298)

## Activating and starting adaptive cruise control\*

Adaptive cruise control (ACC<sup>39</sup>) must first be activated and then started if it is to control the speed and distance.

## Setting the adaptive cruise control in standby mode

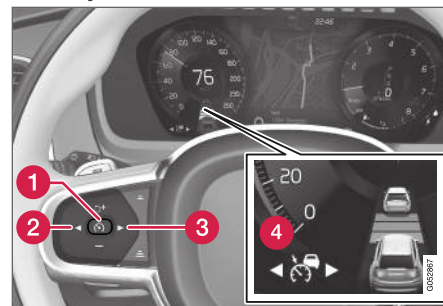

Immediately after the engine is started the Adaptive Cruise Control is in the standby mode. To set it in standby mode from active mode, proceed as follows:



- Press steering wheel button (2) or (3) to scroll to the symbol/function (4).
- > The symbol is displayed and Adaptive Cruise Control is set in standby mode.

## Starting/activating the adaptive cruise control

In order to start the ACC the following requirements apply:

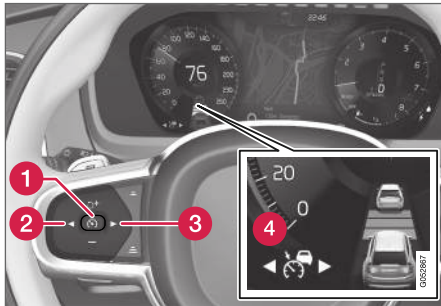
- The driver's seatbelt must be buckled and the driver's door must be closed.
- There must be a vehicle (the "target vehicle") within reasonable distance in front of the car, or the current speed must be at least 15 km/h (9 mph).
- For cars with manual gearbox. Speed must be at the lowest 30 km/h (20 mph).



- With the symbol/function  (4) displayed, press the steering wheel button  (1).
- > Adaptive cruise control starts and the current speed is stored, which is shown in figures in the centre of the speedometer.

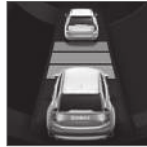

The time interval is only adjusted to the vehicle ahead by the ACC when the distance symbol shows two vehicles.



At the same time a speed range is marked.

The higher speed is the stored/selected speed and the lower speed is that of the vehicle ahead (target vehicle).

## Related information

- Adaptive cruise control\* (p. 298)
- Deactivating/reactivating adaptive cruise control\* (p. 301)
- Change between cruise control and adaptive cruise control\* (p. 303)

## Deactivating/reactivating adaptive cruise control\*

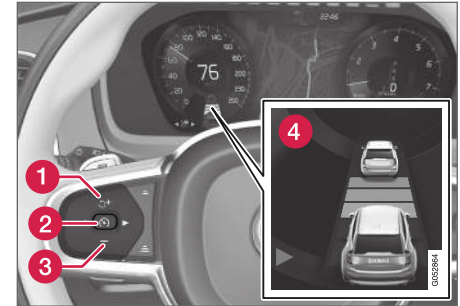

The Adaptive cruise control (ACC<sup>40</sup>) can be temporarily deactivated so that it is set in the standby mode and can later be reactivated.

## Deactivate Adaptive Cruise Control and set it in standby mode



<sup>39</sup> Adaptive Cruise Control

<sup>40</sup> Adaptive Cruise Control

- ◀◀ To temporarily switch off Adaptive Cruise Control and set it in standby mode:
  - Press the steering wheel button  (2).
    - > The  symbol on the driver display changes colour from WHITE to GREY and the stored speed in the centre of the speedometer changes from BEIGE to GREY.

**⚠ WARNING**

- With the adaptive cruise control in standby mode, the driver must intervene and regulate both speed and distance to the vehicle ahead.
- When the adaptive cruise control is in standby mode and the car comes too close to a vehicle ahead, the driver may be warned of the short distance by the Distance Warning\* function instead.

**Standby mode on driver intervention**

The Adaptive cruise control is temporarily deactivated and set in standby mode if:

- the foot brake is used.
- the gear selector is moved to **N** position.
- the driver maintains a speed higher than the stored speed for longer than 1 minute.

- the clutch pedal is depressed for approx. 1 minute - applies to cars with manual gearbox.

A temporary increase in speed with the accelerator pedal, e.g. during overtaking, does not affect the setting - the car returns to the last stored speed when the accelerator pedal is released.

**Automatic standby mode**

Adaptive cruise control is dependent on other systems, e.g. stability control/anti-skid ESC<sup>41</sup>. If any of these other systems stops working, adaptive cruise control is switched off automatically.

**⚠ WARNING**

With automatic standby mode, the driver is warned via an acoustic signal and a message on the driver display.

- The driver must then regulate the car's speed, apply the brakes as needed and maintain a safe distance to other vehicles.

Automatic standby mode may occur if:

- the speed is below 5 km/h ((3 mph)) and ACC is uncertain whether the vehicle ahead is a stationary vehicle or an object, such as a speed bump.
- the speed is below 5 km/h ((3 mph)) and the vehicle ahead turns off so that ACC no longer has a vehicle to follow.

- speed is reduced to below 30 km/h (20 mph) - only applies to cars with manual gearbox.
- the driver opens the door.
- the driver takes off the seatbelt.
- engine speed is too low/high.
- one or more wheels lose traction.
- brake temperature is high.
- the parking brake is applied.
- the camera and radar unit is covered by e.g. snow or heavy rainfall (camera lens/radio waves are blocked).

**Reactivating adaptive cruise control from standby mode**

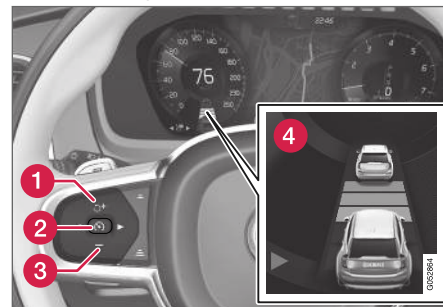

<sup>41</sup> Electronic Stability Control



To reactivate ACC from standby mode:

- Press the steering wheel button  (1).
  - > The speed is then set to the most recently stored speed.

### WARNING

A significant increase in speed may follow when the speed is resumed with the .

### Related information

- Adaptive cruise control\* (p. 298)
- Activating and starting adaptive cruise control\* (p. 300)
- Change between cruise control and adaptive cruise control\* (p. 303)

## Limitations for adaptive cruise control\*

Adaptive Cruise Control (ACC<sup>42</sup>) may have limitations in certain situations.

### Steep roads and/or heavy load

Bear in mind that the adaptive cruise control is primarily intended for use when driving on level road surfaces. The function may have difficulty in keeping the correct distance from the vehicle ahead when driving on steep downhill slopes - in which case, be extra attentive and ready to brake.

- Do not use adaptive cruise control if the car has a heavy load or a trailer is connected to the car.

### Miscellaneous

- Drive mode **Off Road** cannot be selected when the adaptive cruise control is activated.

### NOTE

This function uses the car's camera and radar units, which have certain general limitations.



### Related information

- Adaptive cruise control\* (p. 298)
- Limitations for camera and radar unit (p. 330)

## Change between cruise control and adaptive cruise control\*

In a car with Adaptive Cruise Control (ACC<sup>43</sup>) the driver can change between Cruise Control (CC<sup>44</sup>) and ACC.

A symbol in the driver display shows which cruise control is active:

CC	ACC
	
Cruise control	Adaptive cruise control

A WHITE symbol: Function active, GREY symbol: Standby mode

### Changing from ACC to CC



Proceed as follows:

1. Set adaptive cruise control to standby mode using steering wheel button .

<sup>42</sup> Adaptive Cruise Control

<sup>43</sup> Adaptive Cruise Control

<sup>44</sup> Cruise Control

2. Press the **Cruise Control** button in the centre display's function view - the button's indicator changes colour from GREY to GREEN.
  - > The symbol in the driver display changes from  ACC to  CC. Adaptive Cruise Control is now switched off and Cruise Control is set to standby mode.
3. Press the steering wheel button .
- > Cruise control starts and stores the current speed.

**WARNING**

Switching from ACC to CC means that the car:



- no longer maintains a preset time interval to the vehicle ahead.
- only follows the stored speed, and the driver must therefore apply the brakes when necessary.

If CC is active when the engine is switched off, ACC will be activated automatically the next time the engine is started.

**Changing from CC to ACC**

Proceed as follows:

1. Set cruise control to standby mode using the  steering wheel button.

2. Tap on the **Cruise Control** button in the function view - the button's indicator changes colour from GREEN to GREY.
  - > The symbol in the driver display changes from  CC to  ACC. Adaptive Cruise Control is now activated and set to standby mode.
3. Press the steering wheel button .
- > Adaptive cruise control starts and stores the current speed, together with the preset time interval to the vehicle ahead.

**Related information**

- Adaptive cruise control\* (p. 298)
- Cruise control (p. 291)

## Symbols and messages for adaptive cruise control\*

A number of symbols and messages regarding the adaptive cruise control (ACC<sup>45</sup>) can be shown via the driver display and/or the head-up display\*.

In the following illustrative example, the RSI\* (Road Sign Information) function informs the driver that the maximum permitted speed is 130 km/h (80 mph).

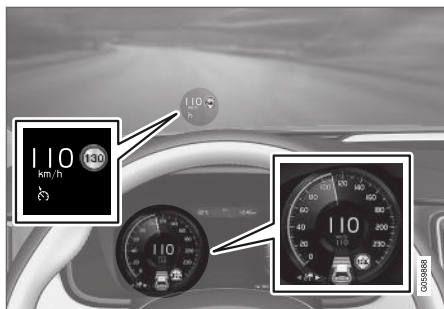

The previous illustration shows that the adaptive cruise control is set to maintain 110 km/h (68 mph) and that there is no vehicle ahead to follow.

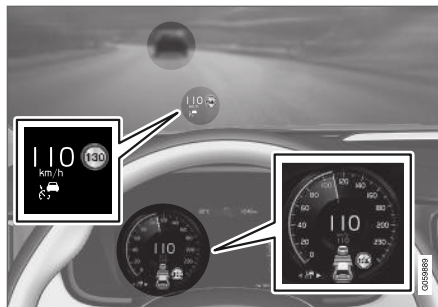

The previous illustration shows that the adaptive cruise control is set to maintain 110 km/h (68 mph) and at the same time is following a vehicle ahead which is keeping the same speed.

<sup>45</sup> Adaptive Cruise Control



Symbol	Message	Specification
	The symbol is WHITE.	The car is maintaining the stored/selected speed.
	<b>Adaptive Cruise Contr. Unavailable</b> The symbol is GREY.	Adaptive cruise control is set to standby mode.
	<b>Adaptive Cruise Contr. Service required</b> The symbol is GREY.	The system does not function as it should. A workshop should be contacted - an authorised Volvo workshop is recommended.
	<b>Windscreen sensor Sensor blocked, see Owner's manual</b>	Clean the windscreen in front of the camera and radar unit's detectors.

A text message can be cleared by briefly pressing the  button, located in the centre of the steering wheel's right-hand keypad.

If a message remains: Contact a workshop – an authorised Volvo workshop is recommended.

### Related information

- Adaptive cruise control\* (p. 298)

## Pilot Assist<sup>46</sup>

Pilot Assist helps the driver to drive the car between the lane's side markings using steering assistance as well as to maintain an even speed, combined with a preselected time interval to the vehicle ahead.

### How Pilot Assist works

The Pilot Assist function is primarily intended for use on motorways and similar major roads where it can contribute to more comfortable driving and a more relaxed driving experience.

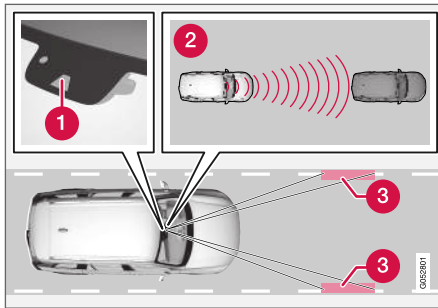

The camera and radar unit measures the distance to the vehicle ahead and detects side markings.

- 1 Camera and radar unit
- 2 Distance readers
- 3 Readers, side markings

The driver selects the desired speed and a time interval to the vehicle ahead. Pilot Assist scans the distance to the vehicle ahead and the lane's side markings on the road surface using the camera and radar unit. The preset time interval is maintained with automatic speed adjustment whilst the steering assistance helps to position the car in the lane.

Pilot Assist steering assistance takes into account the speed of the preceding car and the lane markings. The driver can at any time ignore the Pilot Assist steering recommendation and steer in another direction, e.g. to change lane or avoid an obstruction on the road.

If Pilot Assist cannot interpret the lane unambiguously, e.g. if the camera and radar unit does not see the lane's side markings, Pilot Assist temporarily deactivates steering assistance, but resumes it if the lane can be interpreted again - although the speed and distance control functions remain active.

### **WARNING**

Pilot Assist steering assistance is automatically deactivated and is resumed without prior warning.

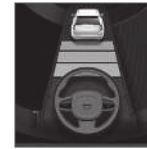

The current status of steering assistance is indicated by the colour of the steering wheel's symbol:

- GREEN steering wheel indicates active steering assistance
- GREY steering wheel (as in illustration) indicates deactivated steering assistance.

### **WARNING**

Pilot Assist must only be used if there are clear lane lines painted on each side of the lane. All other use involves increased risk of contact with surrounding obstacles that cannot be detected by the function.

<sup>46</sup> This function can be either standard or optional, depending on market.



### **WARNING**

- The function is supplementary driver support intended to facilitate driving and make it safer – it cannot handle all situations in all traffic, weather and road conditions.
- The driver is advised to read all sections in the Owner's Manual that relate to this function to learn about factors such as its limitations and what the driver should be aware of before using the system.
- Driver support functions are not a substitute for the driver's attention and judgement. The driver is always responsible for ensuring the car is driven in a safe manner, at the appropriate speed, with an appropriate distance to other vehicles, and in accordance with current traffic rules and regulations.

Pilot Assist regulates the speed with acceleration and braking. It is normal for the brakes to emit a low sound when they are being used to adjust the speed.

Pilot Assist attempts to regulate the speed smoothly. In situations that demand sudden braking the driver must brake himself/herself. This applies in cases of large speed differences or if the car in front brakes suddenly. Due to the limi-

tations of the camera and radar unit, braking may come unexpectedly or not at all.

Pilot Assist aims to follow the vehicle ahead in the same lane at a time interval set by the driver. If the radar unit cannot see any vehicle in front then the car will instead maintain the speed set and stored by the driver. This also takes place if the speed of the vehicle ahead increases and exceeds the stored speed.

### **WARNING**

- This is not a collision avoidance system. The driver is always responsible and must intervene if the system does not detect a vehicle ahead.
- The function does not brake for humans or animals, and not for small vehicles such as bicycles and motorcycles. Nor for low trailers, oncoming, slow or stationary vehicles and objects.
- Do not use the function in demanding situations, such as in city traffic, at junctions, on slippery surfaces, with a lot of water or slush on the road, in heavy rain/snow, in poor visibility, on winding roads or on slip roads.

### **IMPORTANT**

Maintenance of driver support components may only be performed at a workshop<sup>47</sup>.

### **Round bends and when the road splits**

Pilot Assist interacts with the driver, who should therefore not wait for the steering assistance from Pilot Assist but should always be prepared to increase his/her own steering input, especially in bends.

- When the car approaches an exit or if the lane splits, the driver should steer towards the desired lane in order to specify the desired direction to Pilot Assist.

### **Pilot Assist strives to keep the car in the middle of the lane**

When Pilot Assist helps to steer, it strives to position the car in between the lane markings and therefore it is recommended to let the car find the optimal placement to achieve as smooth a driving experience as possible. The driver checks that the car is positioned safely in the lane, and always has the ability to adjust the position by making his/her own steering corrections.

- If Pilot Assist does not position the car in an appropriate way in the lane, it is recommended to turn Pilot Assist off or switch to Adaptive cruise control.

<sup>47</sup> An authorised Volvo workshop is recommended.

## Related information

- Driving support systems (p. 278)
- Controls and display view for Pilot Assist (p. 309)
- Activating and starting Pilot Assist (p. 310)
- Limitations of Pilot Assist (p. 313)
- Symbols and messages for Pilot Assist\* (p. 314)
- Warning from driver support in the event of a collision risk (p. 316)
- Change of target with driver support (p. 317)
- Set time interval for driver support (p. 318)
- Set the stored speed for driver support (p. 319)
- Automatic braking with driver support (p. 320)
- Overtaking Assistance (p. 321)

## Controls and display view for Pilot Assist

A summary of how Pilot Assist is controlled using the left-hand keypad on the steering wheel and how the function is shown in the display.

### Controls

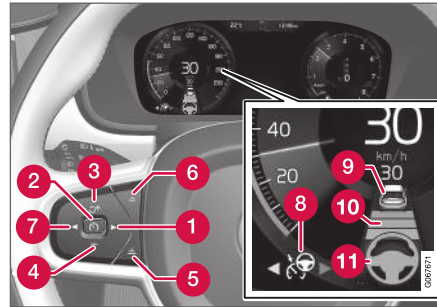

Buttons and symbols for the function.

- 1 ▶: Switches from adaptive cruise control to Pilot Assist
- 2 Ⓜ: **From standby mode** - activates Pilot Assist and stores the current speed
- 2 Ⓜ: **From active mode** - deactivates/changes Pilot Assist to standby mode
- 3 ↺: Activates Pilot Assist from standby mode and resumes the stored speed and time interval
- 3 +: Increases the stored speed

- 4 —: Reduces stored speed
- 5 Increases the time interval to vehicles ahead
- 6 Reduces the time interval to vehicles ahead
- 7 ◀: Switches from Pilot Assist to adaptive cruise control
- 8 Function symbol
- 9 Symbols for target car
- 10 Symbol for time interval to vehicles ahead
- 11 Symbol for activated/deactivated steering assistance



◀ Driver display

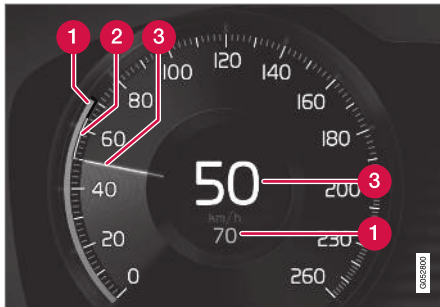

Indication of speeds.

- 1 Stored speed
- 2 Speed of vehicle ahead
- 3 Current speed of your car

**Related information**

- Pilot Assist (p. 307)

**Activating and starting Pilot Assist**

Pilot Assist must first be activated and then started to be able to control speed and distance and to give steering assistance.

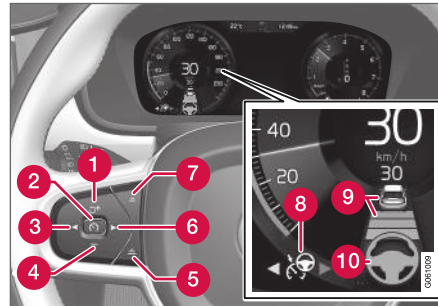

NOTE: The illustration is schematic - details may vary depending on car model.

In order to start the Pilot Assist it is required that:

- The driver's seatbelt must be buckled and the driver's door must be closed.
- There must be a vehicle (the "target vehicle") within reasonable distance in front of the car, or the current speed must be at least 15 km/h (9 mph).
- For cars with manual gearbox. Speed must be at the lowest 30 km/h (20 mph).

With the adaptive cruise control **in standby mode**:

1. Press the steering wheel button ▶ (6).
  - > The symbol changes to Pilot Assist in standby mode (8).
2. Press the steering wheel button (2).
  - > Pilot Assist is started and current speed is stored, which is shown with figures in the centre of the speedometer.

...or...

With the Adaptive cruise control **started**:

- Press the steering wheel button ▶ (6).
  - > Pilot Assist is started.

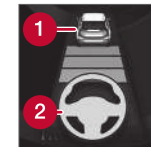

Pilot Assist steering assistance is only active when the steering wheel symbol (2) has changed from GREY to GREEN.

Pilot Assist only regulates the time interval to the vehicle ahead when the distance symbol shows a vehicle (1) above the steering wheel symbol.



At the same time a speed range is marked.

The higher speed is the stored/selected speed and the lower speed is that of the vehicle ahead (target vehicle).



## Hands on the steering wheel

In order for Pilot Assist to function, the driver's hands must be on the steering wheel.



If Pilot Assist detects that the driver is not holding the steering wheel, the driver is prompted after a pause to actively steer the car, via a symbol and a text message.

If the driver's hands still cannot be detected on the steering wheel after a few seconds, the prompt to actively steer the car is repeated, supplemented by an acoustic warning signal.

If Pilot Assist cannot detect the driver's hands on the steering wheel after a further few seconds, the warning signal becomes intensive and the steering function is deactivated. Pilot Assist must then be restarted using the steering wheel button .

### NOTE

Note that Pilot Assist only works when the driver has hands on the steering wheel.

## Related information

- Pilot Assist (p. 307)
- Deactivating/activating Pilot Assist (p. 311)

## Deactivating/activating Pilot Assist

Pilot Assist can be temporarily deactivated so that it is set in the standby mode and can be reactivated later.

### Deactivating and setting Pilot Assist in standby mode

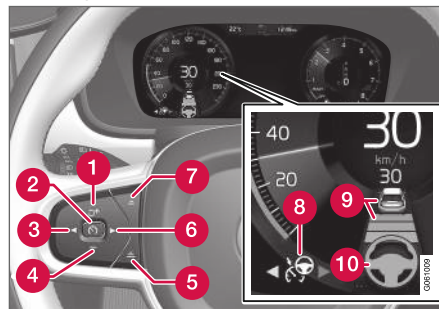

NOTE: The illustration is schematic - details may vary depending on car model.

To temporarily switch off Pilot Assist and set it in standby mode:

- Press the steering wheel button  (2).
  - > Pilot Assist is set in standby mode - the symbol (8) in the driver display changes colour from WHITE to GREY and the stored speed in the centre of the speedometer changes from BEIGE to GREY.

...Or...

- Press the steering wheel button  (3).
  - > Pilot Assist is switched off and changes to the Adaptive cruise control in active mode.

### WARNING

- With Pilot Assist in standby mode, the driver must intervene and steer, regulating both speed and distance to the vehicle ahead.
- When Pilot Assist is in standby mode and the car comes too close to a vehicle ahead, the driver is warned of the short distance by the distance warning\* function instead.



#### ◀ **Standby mode on driver intervention**

Pilot Assist is temporarily deactivated and set in standby mode if:

- the foot brake is used.
- the gear selector is moved to **N** position.
- the direction indicators are used for longer than 1 minute.
- the driver maintains a speed higher than the stored speed for longer than 1 minute.
- the clutch pedal is depressed for approx. 1 minute - applies to cars with manual gearbox.

A temporary increase in speed with the accelerator pedal, e.g. during overtaking, does not affect the setting - the car returns to the last stored speed when the accelerator pedal is released.

When the direction indicators are used, Pilot Assist steering assistance is temporarily disengaged. When this is no longer the case, steering assistance is automatically reactivated if the lane's side markings can still be detected.

#### **Automatic standby mode**

Pilot Assist is dependent on other systems, e.g. stability control/anti-skid ESC<sup>48</sup>. If any of these other systems stops working, Pilot Assist is switched off automatically.

**⚠ WARNING**

With automatic standby mode, the driver is warned via an acoustic signal and a message on the driver display.

- The driver must then regulate the car's speed, apply the brakes as needed and maintain a safe distance to other vehicles.

Automatic standby mode may occur if, for example:

- the driver opens the door.
- brake temperature is high.
- the driver's hands are not on the steering wheel.
- the parking brake is applied.
- engine speed is too low/high.
- the driver takes off the seatbelt.
- one or more wheels lose traction.
- the camera and radar unit is covered by e.g. snow or heavy rainfall (camera lens/radio waves are blocked).
- the speed is below 5 km/h (3 mph) and Pilot Assist is uncertain whether the vehicle ahead is a stationary vehicle or an object, such as a speed bump.

- the speed is below 5 km/h (3 mph) and the vehicle ahead turns off so that Pilot Assist no longer has a vehicle to follow.
- speed is reduced to below 30 km/h (20 mph) - only applies to cars with manual gearbox.

#### **Reactivating Pilot Assist from the standby mode**

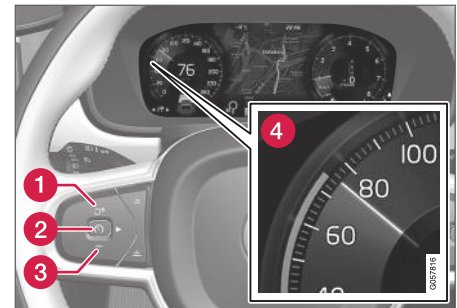

NOTE: The illustration is schematic - details may vary depending on car model.

To reactivate Pilot Assist:

- Press the steering wheel button (1).
  - > The speed is then set to the most recently stored speed.

<sup>48</sup> Electronic Stability Control

**⚠ WARNING**

A significant increase in speed may follow when the speed is resumed with the  steering wheel button.

**Related information**

- Pilot Assist (p. 307)
- Activating and starting Pilot Assist (p. 310)

**Limitations of Pilot Assist**

The Pilot Assist function may have limitations in certain situations.

The Pilot Assist function is an aid which can help the driver in many situations. But the driver is at all times responsible for maintaining a safe distance to surrounding objects and a correct position in the lane.

**⚠ WARNING**

In certain situations, Pilot Assist steering assistance may have difficulty helping the driver in the right way or it may be automatically deactivated - in which case, the use of Pilot Assist is not recommended. Examples of such situations may be that:

- the lane markings are worn, missing or cross each other.
- lane division is unclear, for example, when the lanes divide or merge or at exits or in the event of multiple sets of markings.
- edges or other lines than lane markings are present on or near the road, e.g. kerbs, joints or repairs to the road surface, edges of barriers, roadside edges or strong shadows.
- the lane is narrow or winding.
- the lane contains ridges or holes.
- weather conditions are poor, e.g. rain, snow or fog or slush or impaired view with poor light conditions, back-lighting, wet road surface etc.

The driver should also note that Pilot Assist has the following limitations:

- High kerbs, roadside barriers, temporary obstacles (traffic cones, safety barriers, etc.) are not detected. Alternatively, they may be detected incorrectly as lane markings, with a subsequent risk of contact





between the car and such obstacles. The driver must ensure him/herself that the car is at a suitable distance from such obstacles.

- The camera and radar sensor does not have the capacity to detect all oncoming objects and obstacles in traffic environments, e.g. potholes, stationary obstacles or objects which completely or partially block the route.
- Pilot Assist does not "see" pedestrians, animals, etc.
- The recommended steering input is force limited, which means that it cannot always help the driver to steer and keep the car within the lane.
- In cars equipped with Sensus Navigation\*, the function has the option of using information from map data, which may result in varied performance.
- Pilot Assist is switched off if the power steering for speed related steering force is working with reduced power – e.g. during cooling due to overheating.

The driver always has the possibility of correcting or adjusting a steering intervention imposed by Pilot Assist and can turn the steering wheel to the desired position.

### Steep roads and/or heavy load

Bear in mind that Pilot Assist is primarily intended for use when driving on level road surfaces. The function may have difficulty in keeping the correct distance from the vehicle ahead when driving on steep downhill slopes - in which case, be extra attentive and ready to brake.

- Do not use Pilot Assist if the car has a heavy load or a trailer is connected to the car.

#### **NOTE**

Pilot Assist cannot be activated if a trailer, bicycle rack or similar is connected to the car's electrical system.

### Miscellaneous

- **Off Road** drive mode cannot be selected when Pilot Assist is activated.

#### **NOTE**

This function uses the car's camera and radar units, which have certain general limitations.

### Related information

- Pilot Assist (p. 307)
- Limitations for camera and radar unit (p. 330)
- Speed-dependent steering force (p. 278)
- Drive modes (p. 447)

## Symbols and messages for Pilot Assist\*

A number of symbols and messages regarding Pilot Assist can be shown via the driver display and/or the head-up display\*.

Here are some examples<sup>49</sup>.

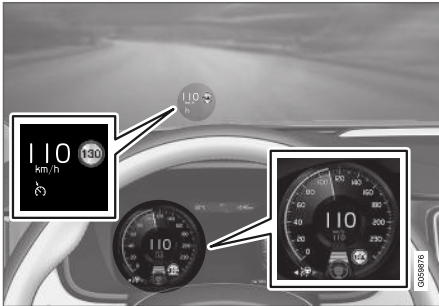

The previous illustration<sup>50</sup> shows that Pilot Assist is set to maintain 110 km/h (68 mph) and that there is no vehicle ahead to follow.

Pilot Assist provides no steering assistance since the lane's side markings cannot be detected.

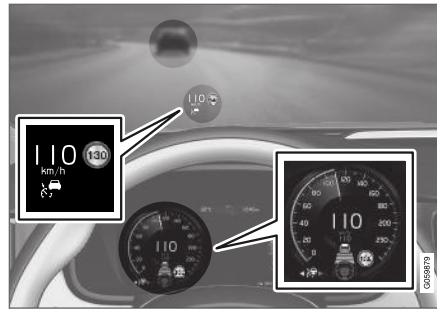

The previous illustration<sup>50</sup> shows that Pilot Assist is set to maintain 110 km/h (68 mph) and at the same time is following a vehicle ahead which is keeping the same speed.

Pilot Assist provides no steering assistance since the lane's side markings cannot be detected.

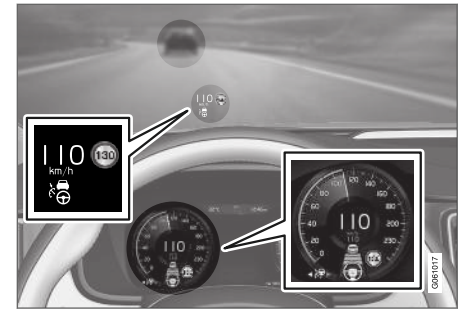

The previous illustration<sup>50</sup> shows that Pilot Assist is set to maintain 110 km/h (68 mph) and at the same time is following a vehicle ahead which is keeping the same speed.

Here, Pilot Assist also provides steering assistance since the lane's side markings can be detected.

<sup>49</sup> In the following illustrative example, the RSI (Road Sign Information) function informs the driver that the maximum permitted speed is 130 km/h (80 mph).

<sup>50</sup> NOTE: The illustration is schematic - details may vary depending on car model.

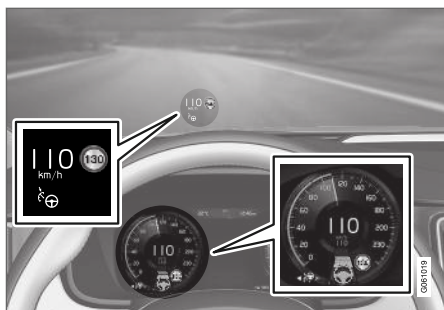

The previous illustration<sup>50</sup> shows that Pilot Assist is set to maintain 110 km/h (68 mph) and that there is no vehicle ahead to follow.

Pilot Assist provides steering assistance as the lane markings can be detected.

### Related information

- Pilot Assist (p. 307)

## Warning from driver support in the event of a collision risk

The driver support systems Pilot Assist, and Adaptive Cruise Control (ACC)<sup>51</sup> can warn the driver if the distance to the vehicle ahead suddenly becomes too short.

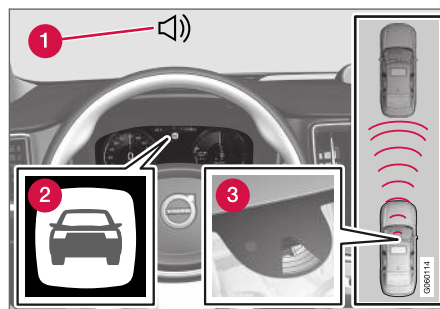

Audio and symbol for collision warning.

- 1 Acoustic warning signal in the event of a risk of collision
- 2 Warning signal in the event of a risk of collision
- 3 Distance measurement with the camera and radar unit

The driver support uses approx. 40% of the foot brake's capacity. If the car needs to be braked more heavily than the driver support is capable of

and the driver does not brake, the warning lamp and acoustic warning are activated to alert the driver that immediate intervention is required.

### **⚠ WARNING**

The driver support systems only warn of vehicles which their radar unit has detected – hence a warning may not be given, or it may be given with a certain delay. Never wait for a warning. Apply the brakes when the situation requires.

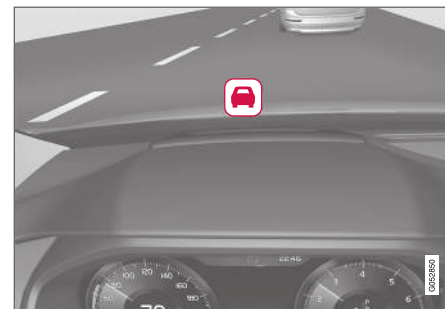

Symbol for collision warning on the windscreen.

In cars equipped with a head up display\*, the warning is shown on the windscreen by a flashing symbol.

<sup>50</sup> NOTE: The illustration is schematic - details may vary depending on car model.

<sup>51</sup> Adaptive Cruise Control

**i NOTE**

Strong sunlight, reflections, extreme light contrasts, the use of sunglasses, or if the driver is not looking straight ahead may make the visual warning signal in the windscreen difficult to recognise.

**Related information**

- Driving support systems (p. 278)
- Adaptive cruise control\* (p. 298)
- Pilot Assist (p. 307)
- Distance Warning\* (p. 296)
- Head-up display\* (p. 135)

**Change of target with driver support**

The driver supports of Adaptive Cruise Control (ACC)<sup>52</sup> and Pilot Assist, in combination with automatic transmission, have a change of target function at certain speeds.

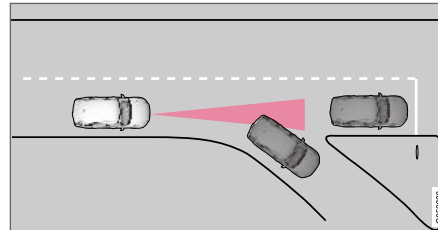
**Change of target**

If the target vehicle in front suddenly turns then there may be stationary traffic in front.

When the driver supports are following another vehicle at speeds **below** 30 km/h (20 mph) and changes target vehicle – from a moving vehicle to a stationary vehicle – the driver supports will slow down for the stationary vehicle.

**⚠ WARNING**

When the driver supports are following another vehicle at speeds **in excess of** approx. 30 km/h (20 mph) and the target is changed from a moving vehicle to a stationary vehicle, the driver supports will **ignore** the stationary vehicle and instead accelerate to the stored speed.

- The driver must then intervene him/herself and brake.

**Automatic standby mode with change of target**

The driver supports are disengaged and set in standby mode:

- when the speed is below 5 km/h (3 mph) and the driver supports are uncertain whether the target object is a stationary vehicle or another object, such as a speed bump.
- when the speed is below 5 km/h (3 mph) and the vehicle ahead turns off so that the driver supports no longer have a vehicle to follow.

**Related information**

- Driving support systems (p. 278)
- Adaptive cruise control\* (p. 298)
- Pilot Assist (p. 307)

## Set time interval for driver support

It is possible to set the time interval to the vehicle ahead to be maintained by the Adaptive Cruise Control (ACC)\*<sup>53</sup>, Pilot Assist and Distance Warning\* functions.



Different time intervals to the vehicle in front can be selected and shown in the driver display as 1-5 horizontal lines - the more lines the longer the time interval. One line represents about 1 second to the vehicle in front, 5 lines represents about 3 seconds.

### **i** NOTE

When the symbol in the driver display shows a car and a steering wheel, Pilot Assist follows a vehicle in front at a preset time gap.

When only one steering wheel is shown, there is no vehicle within a reasonable distance ahead.

### **i** NOTE

When the symbol in the driver display shows two cars, ACC is following the vehicle in front at a pre-set time interval.

When only one car is shown, there is no vehicle within a reasonable distance ahead.

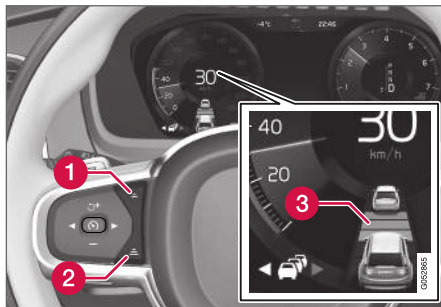

Control for time interval.

- 1** Decrease time interval
  - 2** Increase time interval
  - 3** Distance indicator
- Press the steering wheel button (1) or (2) to increase or decrease the time interval.
- > The distance indicator (3) shows the current time interval.

The adaptive cruise control allows the time interval to vary significantly in certain situations in order to allow the car to follow the vehicle in front smoothly and comfortably. At low speed, when the distances are short, the adaptive cruise control increases the time interval slightly.

### **i** NOTE

- The higher the speed the longer the calculated distance in metres for a given time interval.
- Only use the time intervals permitted by local traffic regulations.
- If the driver supports do not seem to respond with a speed increase when activated, it may be because the time window to the vehicle ahead is shorter than the set time window.

### **!** WARNING

- Only use a time window that suits the current traffic conditions.
- The driver should be aware that short time windows limit the amount of time available to react and take action in an unexpected traffic situation.

<sup>53</sup> Adaptive Cruise Control



### Related information

- Driving support systems (p. 278)
- Adaptive cruise control\* (p. 298)
- Pilot Assist (p. 307)
- Distance Warning\* (p. 296)
- Head-up display\* (p. 135)

### Drive mode for driver support

The driver can select different driving styles for how driver support should maintain the preset time interval to the vehicle ahead.

Selection is made via the drive mode control **DRIVE MODE**.

Select one of the following options:

- **Pure** – The driver support focuses on optimal fuel economy, which means longer time interval to the vehicle ahead.
- **Hybrid** – The driver support focuses on following the set time interval to the vehicle ahead as smoothly as possible.
- **Power** – The driver support focuses on following the set time interval to the vehicle ahead more closely, which in certain cases may mean heavier acceleration and braking.

### Related information

- Driving support systems (p. 278)
- Drive modes (p. 447)

### Set the stored speed for driver support

It is possible to set stored speed for the Speed Limiter, Cruise Control, Adaptive Cruise Control (ACC)\*<sup>54</sup> and Pilot Assist functions.

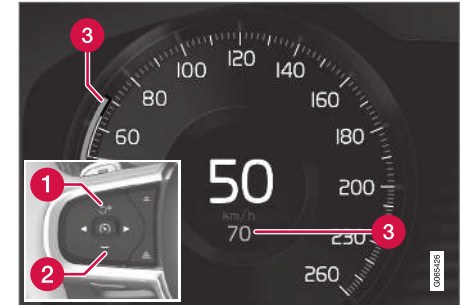

- ① + : Increases the stored speed.
- ② - : Reduces stored speed.
- ③ Stored speed.

- ◀ – Change a set speed with short presses on the steering wheel buttons **+** (1) or **–** (2) or by pressing and holding them.
  - **Short** presses: Each press changes the speed in increments of +/- 5 km/h (+/- 5 mph).
  - **Press and hold:** Release the button when the speed indicator (3) has moved to the desired speed.
  - The speed set after the last button press is stored in the memory.

If the driver increases the car's speed using the accelerator pedal before pressing the steering wheel button **+** (1), the speed stored will be the car's speed when the button is depressed, provided the driver's foot is on the accelerator pedal at the moment when the button is depressed.

A temporary increase in speed with the accelerator pedal, e.g. during overtaking, does not affect the setting - the car returns to the last stored speed when the accelerator pedal is released.

### Automatic gearbox

The driver support functions can follow another vehicle at speeds from 0 km/h up to 200 km/h (125 mph).

Pilot Assist can give steering assistance from almost stationary up to 140 km/h (87 mph).

Note that the lowest programmable speed is 30 km/h (20 mph) – even though it is capable of following another vehicle down to 0 km/h, a speed lower than 30 km/h (20 mph) cannot be selected/stored.

### Manual gearbox

the driver support functions can follow another vehicle at speeds from 30 km/h (20 mph) up to 200 km/h (125 mph).

Pilot Assist can give steering assistance from 30 km/h (20 mph) up to 140 km/h (87 mph).

The lowest programmable speed is 30 km/h (20 mph) – the maximum speed is 200 km/h (125 mph).

### Related information

- Driving support systems (p. 278)
- Speed limiter (p. 284)
- Cruise control (p. 291)
- Adaptive cruise control\* (p. 298)
- Pilot Assist (p. 307)

## Automatic braking with driver support

Pilot Assist and adaptive cruise control\* (ACC<sup>55</sup>) have a special brake function in slow traffic and while stationary.

### Brake function in slow queues and while stationary

For shorter stops in connection with inching in slow traffic or at traffic lights, driving is automatically resumed if the stops do not exceed approx. 3 seconds - if it takes longer before the vehicle in front starts moving again then the driver support function is set in standby mode with automatic braking.

- The function is reactivated in one of the following ways:
  - Press the steering wheel button .
  - Depress the accelerator pedal.
  - > The function resumes following the vehicle ahead if it starts moving forward within approx. 6 seconds.

<sup>55</sup> Adaptive Cruise Control

**i NOTE**

The driver supports can hold the car stationary for a maximum of 5 minutes – then the parking brake is applied and the function is disengaged.

Before the driver supports can be reactivated, the parking brake must be released.

**Cessation of automatic braking**

In some situations, automatic braking ceases on coming to a standstill and the function is set in standby mode. This means that the brakes are released and the car may start to roll - the driver must therefore intervene and brake the car himself/herself to keep it stationary.

This may take place in the following situations:

- the driver puts his/her foot on the brake pedal
- the parking brake is applied
- the gear selector is moved to **P**, **N**, or **R** position
- the driver sets the function in the standby mode.

**Automatic activation of parking brake**

In certain situations, the parking brake is applied in order to keep the car stationary.

This takes place if the function is holding the car stationary with the foot brake and:

- the driver opens the door or takes off his/her seatbelt
- the function has kept the car stationary for more than approx. 5 minutes
- the brakes have overheated
- the driver switches the engine off manually.

**Related information**

- Driving support systems (p. 278)
- Adaptive cruise control\* (p. 298)
- Pilot Assist (p. 307)
- Brake functions (p. 431)

**Overtaking Assistance**

Overtaking Assistance can help the driver when overtaking other vehicles. This function can be used with Pilot Assist or adaptive cruise control\* (ACC<sup>56</sup>).

**How overtaking assistance works**

When Pilot Assist or ACC is following another vehicle and the driver indicates the intention to overtake by activating the direction indicator<sup>57</sup>, the systems help by accelerating the vehicle towards the vehicle in front **before** the driver's vehicle reaches the overtaking lane.

The function then delays reducing speed in order to avoid premature braking when the driver's car is approaching a slower vehicle.

The function remains active until the driver's vehicle has cleared the overtaken vehicle.

**⚠ WARNING**

Be aware that this function can be activated in more situations than during overtaking, e.g. when a direction indicator is used to indicate a change of lane or exit to another road – the car will then accelerate briefly.

<sup>56</sup> Adaptive Cruise Control

<sup>57</sup> On left flash only in left-hand-drive car, or right flash in right-hand-drive car.

## ◀◀ Related information

- Driving support systems (p. 278)
- Use Overtaking Assistance (p. 322)
- Adaptive cruise control\* (p. 298)
- Pilot Assist (p. 307)

## Use Overtaking Assistance

There are a number of criteria if Overtaking Assistance is to be used.

The following conditions must exist for Overtaking Assistance to be activated:

- there must be a vehicle in front (the "target vehicle")
- your car's **current speed** is at least 70 km/h (43 mph)
- **the stored speed** must be high enough for overtaking to take place safely.

To start the Overtaking Assistance:

- Activate the direction indicator.

Use the left-hand direction indicator in a left-hand drive car right in a right-hand drive car.

> Overtaking Assistance is started.

** WARNING**

When using the Overtaking Assistance System, the driver should be aware that there may be undesired acceleration if the conditions suddenly change.

Some situations should therefore be avoided, such as if:

- the car is approaching an exit for turn-of that is in the same direction as overtaking would normally occur
- the vehicle ahead slows down before the driver's car has crossed over into the overtaking lane.
- the traffic in the overtaking lane slows down.
- a right-hand drive car is driven in a county with left-hand traffic (or vice versa).

Situations of this type are avoided by temporarily setting adaptive cruise control or Pilot Assist to standby mode.

## Related information

- Overtaking Assistance (p. 321)
- Adaptive cruise control\* (p. 298)
- Pilot Assist (p. 307)

## Radar unit

The radar unit is used by several driver support systems and has the task of sensing other vehicles.



Radar unit location.

The radar unit is used by the following functions:

- Distance Warning\*
- Adaptive cruise control\*
- Lane assistance
- Pilot Assist\*
- City Safety

Modification of the radar unit could result in its use being illegal.

## Related information

- Driving support systems (p. 278)
- Limitations for camera and radar unit (p. 330)
- Recommended maintenance for camera and radar unit (p. 334)
- Type approval for radar device (p. 324)

## Type approval for radar device



The type approval for the car's radar units in the ACC<sup>58</sup>, PA<sup>59</sup> and BLIS<sup>60</sup> functions can be read out here.

Market	ACC & PA	BLIS	Symbol	Type approval
Botswana		✓		
Brazil	✓			<p>Este equipamento opera em caráter secundário, isto é, não tem direito à proteção contra interferência prejudicial, mesmo de estações do mesmo tipo, e não pode causar interferência a sistemas operando em caráter primário.</p> <p>Modelo: L2C0054TR 4122-14-8645</p>
		✓		03563-17-05364

<sup>58</sup> Adaptive Cruise Control



<sup>59</sup> Pilot Assist

<sup>60</sup> Blind Spot Information



Market	ACC & PA	BLIS	Symbol	Type approval
Europe	✓			<p>Hereby, Delphi Electronics and Safety declares that L2C0054TR is in compliance with the essential requirements and other relevant provisions of Directive 2014/53/EU (RED). The original declaration of conformity can be accessed at the following link <a href="http://www.delphi.com/automotive-homologation">www.delphi.com/automotive-homologation</a>.</p> <p>Frequency Band: 76GHz – 77GHz</p> <p>Maximum Output Power: 55dBm EIRP</p> <p>The Declaration of Conformity may be consulted at Delphi Electronics &amp; Safety / 2151 E. Lincoln Road / Kokomo, Indiana 46902 USA</p>
		✓		<p>Hereby, Hella KgaA Hueck &amp; Co., declares that RS4 is in compliance with the essential requirements and other relevant provisions of Directive 2014/53/EU.</p> <p>The Declaration of conformity may be consulted at Hella KGaA Hueck &amp; Co., Rixbecker Straße 75/ 59552 Lippstadt, Germany and on the website <a href="http://www.hella.com/vcc">www.hella.com/vcc</a>.</p> <p>Frequency Band: 24050-24250 MHz</p> <p>Maximum Output Power: 20 dBm EIRP</p>
The United Arab Emirates (UAE)	✓			<p>Registered No: ER37536/15</p> <p>Dealer No: DA37380/15</p>
		✓		<p>Registered No: ER53878/17</p> <p>Dealer No: DA44932/15</p>
Indonesia	✓			<p>37295/POSTEL/2014</p> <p>4927</p>
		✓		<p>Certificate number: 50459/SDPPI/2017</p> <p>PLG ID: 6051</p>





Market	ACC & PA	BLIS	Symbol	Type approval
Jordan	✓			Type Approval No.: TRC/LPD/2014/255 Equipment Type: Low Power Device (LPD)
		✓		TRC/LPD/2017/63
Korea	✓			Certification No. MSIP-CMI- DPH-L2C0054TR
		✓		MSIP-CMM-HLA-RS4
Morocco	✓			AGREE PAR L'ANRT MAROC NUMÉRO D'AGRÉMENT: MR 9929 ANRT 2014 DATE D'AGRÉMENT: 26/12/2014
Mexico	✓			IFETEL: RLVDEL215-0299
		✓		Radar de corto alcance RS4 Hella KGaA Hueck & Co IFETEL: RLVHERS17-0286
Moldova	✓	✓		

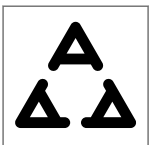
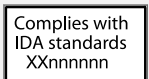

Market	ACC & PA	BLIS	Symbol	Type approval
Russia		✓		
Serbia	✓			I011 14
		✓		I011 17
Singapore	✓			DA 105753
		✓		DA 103238
South Africa	✓			TA-2014/1824
		✓		TA-2016/3407
Taiwan	✓			CCAB15LP0560T3
		✓		CCAB17LP0470T5



Market	ACC & PA	BLIS	Symbol	Type approval
Ukraine	✓			Delphi цім стверджує, що обладнання RACAM відповідає вимогам Про затвердження Технічного регламенту радіообладнання і телекомунікаційного кінцевого (термінального) обладнання (Постанова КМУ № 679 від 24 червня 2009 р.) Декларація відповідності знаходиться на сайті Delphi за адресою: Delphi.
		✓		

### Type approval for radio equipment

Market	Symbol	Type approval
Europe		Hereby, Volvo cars, declares that all radio equipment's are in compliance with the essential requirements and other relevant provisions of Directive 2014/53/EU.

### Related information

- Radar unit (p. 323)

## Camera unit

The camera unit is used by several driver support systems and has the task of for example detecting lane lines or traffic signs.



Location of the camera unit.

The camera unit is used by the following functions:

- Adaptive cruise control\*
- Pilot Assist\*
- Lane assistance\*
- Steering assistance at risk of collision
- City Safety
- Driver Alert Control\*
- Road Sign Information\*
- Active main beam\*

## Related information

- Driving support systems (p. 278)
- Limitations for camera and radar unit (p. 330)
- Recommended maintenance for camera and radar unit (p. 334)

## Limitations for camera and radar unit

The camera and radar unit has certain limitations – which in turn also limit those functions that use the unit. A driver should be aware about the following examples of limitations.

### Camera and radar

#### Blocked unit



The marked area must be cleaned regularly and kept free from stickers, objects, shade film, etc.

The camera unit is placed inside the upper section of the windscreen together with the car's radar unit.

Do not place, stick or mount anything on the inside or outside of the windscreen, in front of or around the camera and radar unit – this may interfere with camera and radar-based functions. This may result functions being reduced, being switched off completely or giving incorrect function responses.



If the driver display shows this symbol and the message "**Windscreen sensor Sensor blocked, see Owner's manual**", this means that the camera and radar unit cannot detect other vehicles, cyclists, pedestrians and large animals in front of the car, and that the car's camera-based and radar-based functions may be disrupted, reduced, completely deactivated or give an incorrect function response.

The following table presents examples of possible causes for a message being shown, along with the appropriate action:

Cause	Action
The windscreen surface in front of the camera and radar unit is dirty or covered with ice or snow.	Clean dirt, ice and snow from the windscreen surface in front of the camera and radar unit.
Thick fog and heavy rain or snow block the radar signals or the camera view.	No action. Sometimes the unit does not work during heavy rain or snowfall.

Cause	Action
Water or snow from the road surface swirls up and blocks the radar signals or camera view.	No action. Sometimes the unit does not work on a very wet or snow-covered road surface.
Dirt has appeared between the inside of the windscreen and the camera and radar unit.	Visit a workshop to have the windscreen inside the unit's cover cleaned - an authorised Volvo workshop is recommended.
Strong oncoming light	No action. The camera unit is reset automatically in more favourable light conditions.

### High temperature

At very high temperatures the camera and radar unit can temporarily be switched off for about 15 minutes after the engine is started so as to protect the unit's electronics. The camera and radar unit restarts automatically when the temperature has fallen sufficiently.

### Damaged windscreen

#### NOTE

If not rectified it can lead to reduced performance for the driver support systems that use the camera and radar unit. This may result in functions being reduced, being switched off completely or giving incorrect function responses.

The following is also applicable so as not to risk incorrect or reduced function or function failure for the driver supports that use the radar unit:

- If a scratch, crack or stone chip appears on the windscreen in front of any of the "windows" for the camera and radar unit and covers an area of approx. 0.5 × 3.0 mm (0.02 × 0.12 in.) or more, a workshop<sup>61</sup> must be contacted so that the windscreen can be replaced.
- Volvo recommends **not** repairing cracks, scratches or stone chips in the area in front of the camera and radar unit – the entire windscreen should be replaced instead.
- Before replacing a windscreen, contact a workshop<sup>61</sup> to verify that the correct windscreen has been ordered and will be fitted.

- The same type of windscreen wipers or windscreen wipers approved by Volvo must be fitted when the windscreen is replaced.
- When replacing the windscreen, the camera and radar unit must be recalibrated by a workshop<sup>61</sup> to ensure that all the camera and radar-based systems in the car function.

### Radar

#### Vehicle speed

The radar unit's ability to detect a vehicle ahead is greatly reduced if the speed of the vehicle ahead is very different to the speed of your own car.

<sup>61</sup> An authorised Volvo workshop is recommended.

◀◀ **Limited field of vision**

The radar unit has a limited field of vision. In some situations another vehicle is not detected, or the detection is made later than expected.

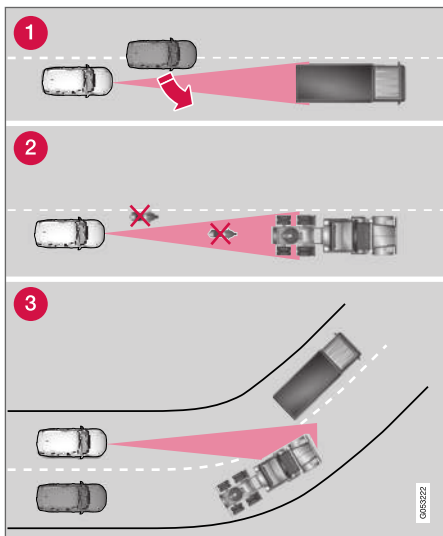

The radar unit's field of vision.

- 1 Sometimes the radar unit is late at detecting vehicles at close distances - e.g. a vehicle

that drives in between your car and the vehicle ahead.

- 2 Small vehicles, such as motorcycles, or vehicles not driving in the centre of the lane can remain undetected.
- 3 In bends, the radar unit may detect the wrong vehicle or lose a detected vehicle from view.

**Low trailers**

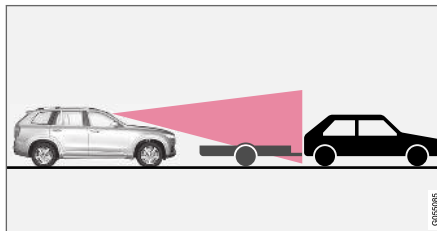

Low trailer in radar shadow.

Low trailers can also be difficult for the radar unit to detect, or are not detected at all - the driver should therefore be particularly careful when driving behind low trailers when the adaptive cruise control or Pilot Assist is activated.

**Camera**

**Impaired vision**

The cameras have limitations similar to the human eye, i.e. may "see" worse in for example intense snowfall or rain, dense fog, heavy dust storms and snow flurries. Under such conditions,

the functions of camera-dependent systems could be significantly reduced or temporarily disengaged.

Strong oncoming light, reflections in the carriageway, snow or ice on the road surface, dirty road surfaces or unclear lane markings can also significantly reduce camera function when it is used to scan the carriageway to detect pedestrians, cyclists, large animals and other vehicles.

## Park assist camera\*

### Blind sectors

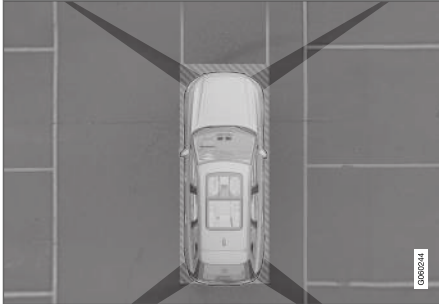

There are "blind" sectors between the cameras' fields of vision.

In the park assist camera's 360° view\* obstacles/objects may "vanish" in the gaps between the individual cameras.

### WARNING

Pay attention to the possibility that, even if it only looks like a relatively small part of the image is obscured, a relatively large sector could be hidden from view. An obstacle could thereby go undetected until the car is very close to it.

## Defective camera



If a camera sector is black and contains this symbol then it means that the camera is out of order.

The following illustration shows an example.

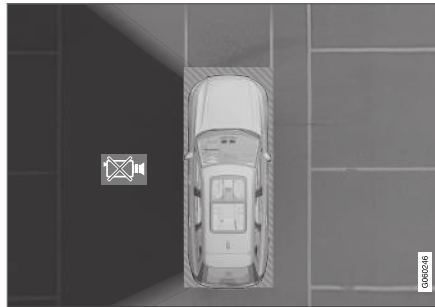

The car's left-hand camera is out of order.

A black camera sector is also shown in the following instances, but then **without** the symbol for defective camera:

- open door
- open tailgate
- folded-in door mirror.

### Light conditions

The camera image is adjusted automatically according to prevailing light conditions. Because of this, the image may vary slightly in brightness

and quality. Poor light conditions can result in reduced image quality.

## Rear parking camera

### WARNING



Pay additional attention while reversing when this symbol is shown if a trailer, bicycle rack or similar is mounted and electrically connected to the car.

The symbol indicates that the parking assistance sensors rearward are **switched off** and will not warn of any obstacles.

### NOTE

A bike carrier or other accessory mounted on the rear of the car could obscure the camera's view.

## Related information

- Camera unit (p. 329)
- Radar unit (p. 323)
- Recommended maintenance for camera and radar unit (p. 334)
- Park assist camera\* (p. 386)

## Recommended maintenance for camera and radar unit

In order that the camera and radar unit shall function correctly, they must be kept clear of dirt, ice and snow, and be cleaned regularly with water and car shampoo.

### **i** NOTE

Dirt, ice and snow covering the sensors may cause incorrect warning signals, reduced or no function.

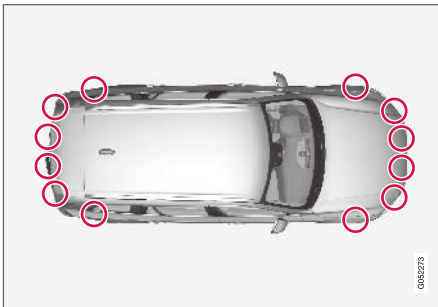

Location of the parking sensors.

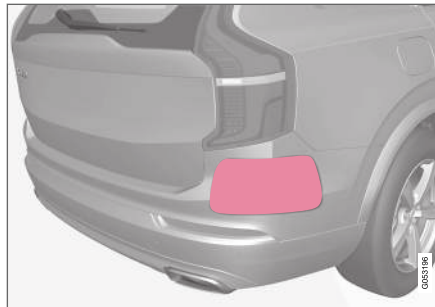

Location of rear radar units. Keep the surface indicated clean – on both the left and right-hand sides of the car.

- To ensure optimal functionality, the surfaces in front of the sensors must be kept clean.
- Do not affix any objects, tape or labels in the area of the sensors.
- Clean camera lenses regularly with lukewarm water and car shampoo - be careful not to scratch the lenses.

### **!** IMPORTANT

Maintenance of driver support components may only be performed at a workshop<sup>62</sup>.

### Related information

- Camera unit (p. 329)
- Radar unit (p. 323)

- Limitations for camera and radar unit (p. 330)
- Park assist camera\* (p. 386)

<sup>62</sup> An authorised Volvo workshop is recommended.



## City Safety™

City Safety<sup>63</sup> can alert the driver using a visual, acoustic and brake pulse warning to help him/her detect pedestrians, cyclists, larger animals and vehicles that suddenly appear - the car then attempts to brake automatically unless the driver acts within a reasonable time him/herself.

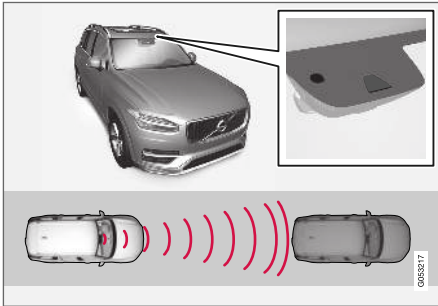

Location of the radar unit.

City Safety can prevent a collision or reduce collision speed.

City Safety is an aid to assist a driver who is at risk of colliding with a pedestrian, large animal, cyclist or a vehicle.

The City Safety function can help the driver to avoid a collision when driving in queues, e.g. when changes in the traffic ahead, combined with a lapse in attention, could lead to an incident.

The function helps the driver by automatically braking the car in the event of an imminent risk of collision if the driver does not react in time by braking and/or swerving.

City Safety activates a short, sharp braking procedure, normally stopping the car just behind the vehicle in front.

City Safety is activated in situations where the driver should have started braking earlier, which is why it cannot help the driver in every situation.

City Safety is designed to be activated as late as possible in order to avoid unnecessary intervention.

The driver or passengers are not normally aware of City Safety - it only intervenes in a situation where a collision is immediately imminent.

## WARNING

- The City Safety auto-brake function can prevent a collision or reduce collision speed, but to ensure full brake performance the driver should always depress the brake pedal – even when the car auto-brakes.
- The warning and steering assistance are only activated if there is a high risk of collision – you must therefore never wait for a collision warning or for City Safety to intervene.
- The warning and brake intervention for pedestrians and cyclists are deactivated at vehicle speeds exceeding 80 km/h (50 mph).
- City Safety does not activate any auto-brake functions in the event of heavy acceleration.

<sup>63</sup> The function is not available in all markets.



### **WARNING**

- The function is supplementary driver support intended to facilitate driving and make it safer – it cannot handle all situations in all traffic, weather and road conditions.
- The driver is advised to read all sections in the Owner's Manual that relate to this function to learn about factors such as its limitations and what the driver should be aware of before using the system.
- Driver support functions are not a substitute for the driver's attention and judgement. The driver is always responsible for ensuring the car is driven in a safe manner, at the appropriate speed, with an appropriate distance to other vehicles, and in accordance with current traffic rules and regulations.

### **Related information**

- Driving support systems (p. 278)
- Parameters and subfunctions for City Safety (p. 336)
- Setting the warning distance for City Safety (p. 338)
- Detection of obstacles with City Safety (p. 339)
- City Safety brakes for oncoming vehicles (p. 345)

- City Safety when evasive manoeuvres are prevented (p. 344)
- City Safety in cross traffic (p. 341)
- City Safety steering assistance for evasive manoeuvre (p. 343)
- Limitations for City Safety in cross traffic (p. 342)
- Limitations of City Safety steering assistance when taking evasive action (p. 344)
- Limitations of City Safety (p. 346)
- Messages for City Safety (p. 349)

### **Parameters and subfunctions for City Safety**

City Safety can avoid a collision with a vehicle, a cyclist, a pedestrian or a larger animal in front by reducing the car's speed with the auto-brake function.

If the speed difference is greater than the following specified speeds, the City Safety auto-brake function cannot prevent a collision but mitigates the consequences of it.

#### **Vehicles**

For a vehicle in front, City Safety can reduce the speed by up to 60 km/h (37 mph).

#### **cyclists**

For a cyclist, City Safety can reduce the speed by up to 50 km/h (30 mph).

#### **Pedestrians**

For a pedestrian, City Safety can reduce speed by up to 45 km/h (28 mph).

#### **Large animals**

In the event of a risk of a collision with a large animal, City Safety can reduce the car's speed by up to 15 km/h (9 mph).

The brake function for large animals is primarily intended to reduce the force of the impact at higher speeds and is most effective at speeds above 70 km/h (43 mph) but less effective at lower speed.

## Subfunctions for City Safety

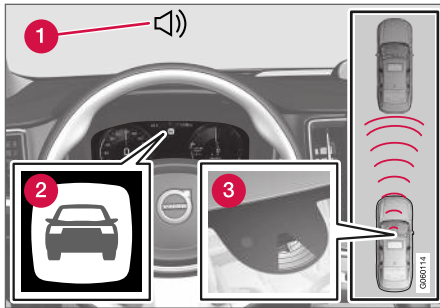

Function overview.

- 1 Acoustic warning signal in the event of a risk of collision
- 2 Warning signal in the event of a risk of collision
- 3 Distance measurement with the camera and radar unit

City Safety carries out three steps in the following order:

1. Collision warning
2. Brake support
3. Auto Brake

The following text explains what happens during the three steps:

### 1 - Collision warning

The driver is first warned of a potentially imminent collision.

In cars equipped with a head up display\*, the warning is shown on the windscreen by a flashing symbol.

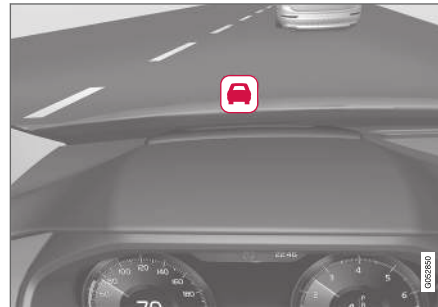

Symbol for collision warning on the windscreen.

### **i** NOTE

Strong sunlight, reflections, extreme light contrasts, the use of sunglasses, or if the driver is not looking straight ahead may make the visual warning signal in the windscreen difficult to recognise.

City Safety can detect pedestrians, cyclists or vehicles that are stationary or moving in the same direction as the car and are ahead. City Safety

can also detect pedestrians, cyclists or large animals that are crossing the road in front of the car.

In the event of a risk of collision with a pedestrian, larger animal, cyclist or vehicle/vehicles the driver's attention is alerted by means of a visual, acoustic and brake pulse warning. There is no brake pulse warning at lower speeds, sudden driver braking or acceleration. The brake pulse frequency varies according to the car's speed.

### 2 - Brake support

If the risk of collision has increased further after the collision warning then the brake support is activated.

Brake support reinforces the driver's braking action if the system considers that the braking is not sufficient to avoid a collision.



### ◀ 3 - Auto Brake

The automatic brake function is activated last.

If in this situation the driver has not yet started to take evasive action and the risk of collision is imminent then the automatic braking function is deployed - this takes place irrespective of whether or not the driver brakes. Braking then takes place with full brake force in order to reduce collision speed, or with limited brake force if it is sufficient to avoid a collision.

The seatbelt tensioner can be activated in connection with the engagement of the automatic brake function.

In some situations, the action of Auto-brake may begin with light braking and then progress to full brake action.

When City Safety has prevented a collision with a stationary object, the car remains stationary in anticipation of positive action by the driver. If the car has been braked to avoid collision with a slower vehicle in front, its speed is reduced to match that of the vehicle in front.

#### **i NOTE**

On cars with manual gearbox, the engine stops when the Auto-brake function has stopped the car, unless the driver has managed to depress the clutch pedal beforehand.

The driver can always interrupt a braking intervention by firmly depressing the accelerator pedal.

#### **i NOTE**

When City Safety brakes, the brake lights come on.

When City Safety is activated and brakes the vehicle, the driver display shows a text message to the effect that the function is/has been active.

#### **⚠ WARNING**

City Safety must not be used by the driver to change his/her driving style - the driver must not rely on City Safety alone and allow it to do the braking.

#### **Related information**

- City Safety™ (p. 335)
- Head-up display\* (p. 135)
- Seatbelt tensioner (p. 47)

### **Setting the warning distance for City Safety**

City Safety is always activated but the driver can select the warning distance for the function.

#### **i NOTE**

The City Safety function cannot be deactivated. It is activated automatically when the engine/electric operation is started and remains switched on until the engine/electric operation is switched off.

The warning distance determines the sensitivity of the system and regulates the distance at which a visual, acoustic and brake pulse warning should be deployed.

To select warning distance:

1. Select **Settings** → **My Car** → **IntelliSafe** in the centre display's top view.
2. Under **City Safety Warning**, select **Late**, **Normal** or **Early** to set the desired warning distance.

If the **Early** setting produces too many warnings, which could be perceived as irritating in certain situations, the **Normal** or **Late** warning distance can be selected.

When warnings are perceived as being too frequent or disturbing, the warning distance can be reduced, which reduces the total number of

warnings and instead leads to City Safety giving a warning at a later stage.

The **Late** warning distance should therefore only be used in exceptional cases, as in dynamic driving.

### **WARNING**

- No automatic system can guarantee 100% correct function in all situations. Therefore, never test City Safety by driving at people, animals or vehicles - this may cause severe damage and injury and risk lives.
- City Safety warns the driver when there is a risk of a collision, but it cannot shorten the driver's reaction time.
- Even if the warning distance has been set to **Early** warnings could be perceived as being late in certain situations, e.g. when there are large differences in speed or if vehicles ahead suddenly brake heavily.
- With the warning distance set at **Early**, the warnings will come more in advance. This may mean that the warnings come more frequently than at the warning distance **Normal**, but it is recommended since it can make City Safety more effective.

### **NOTE**

The warning with direction indicators for Rear Collision Warning is deactivated if the warning distance for collision warning in the City Safety function is set at the lowest level "**Late**".

The seat belt pre-tensioning and braking functions are, however, still active.

### **Related information**

- City Safety™ (p. 335)
- Rear Collision Warning (p. 350)

## **Detection of obstacles with City Safety**

City Safety can help the driver to detect vehicles, cyclists, large animals and pedestrians.

### **Vehicles**

City Safety detect most vehicles that are stationary or moving in the same direction as the driver's own car. This function can also detect oncoming vehicles and cross traffic in certain cases.

In order that City Safety shall be able to detect a vehicle in the dark, the vehicle's front and rear lights must be working and clearly illuminated.

### **Cyclists**

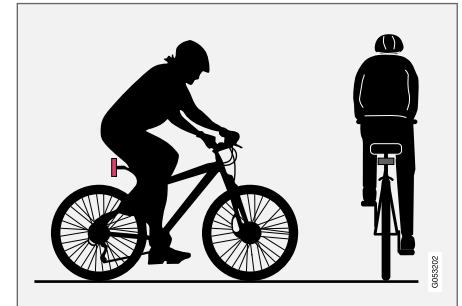

Optimal examples of what City Safety interprets as a cyclist — with clear body outline and bicycle outline.

Optimal performance requires that the system function that detects a cyclist must receive the clearest possible information about the body and



## DRIVER SUPPORT

- ◀◀ bicycle outline, requiring the ability to identify the bicycle, head, arms, shoulders, legs, upper and lower body plus a normal human pattern of movement.

If large parts of the cyclist's body or bicycle are not visible to the function's camera then the system cannot detect a cyclist.

For the function to be able to detect a cyclist, he/she must be an adult and riding a bicycle designed for adults.

### WARNING

City Safety is supplementary driver support, but it cannot detect all cyclists in all situations and, for example, cannot see:

- partially obscured cyclists.
- cyclists if the background contrast of the cyclist is poor – warning and brake interventions may then be late or not occur at all.
- cyclists wearing clothing that obscures the body outline.
- bicycles loaded with large objects.

The driver is always responsible that the vehicle is driven correctly and with a safety distance adapted to the speed.

## Pedestrians

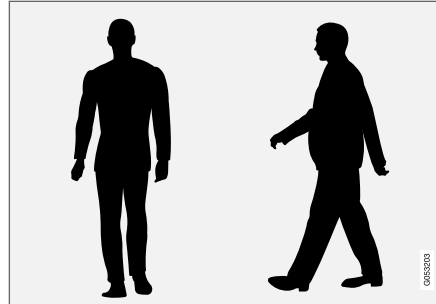

Optimal examples of what the system regards as pedestrians with clear body outlines.

For optimal performance, the system function that detects pedestrians must receive the clearest possible information about the body outline, requiring the ability to identify the head, arms, shoulders, legs, upper and lower body plus a normal human pattern of movement.

In order that it shall be possible to detect a pedestrian there must be a contrast with the background and this will be affected by such things as clothes, the background and the weather. With poor contrast the pedestrian may either be detected late or not at all, which may mean that warnings and braking are late or omitted.

City Safety can also detect pedestrians in the dark if they are illuminated by the car's headlamps.

### WARNING

City Safety is supplementary driver support, but it cannot detect all pedestrians in all situations and, for example, cannot see:

- partially obscured pedestrians, people in clothing that hides their body contour or pedestrians shorter than 80 cm (32 in.).
- pedestrians if the background contrast of the pedestrians is poor - warning and brake interventions may then be late or not occur at all.
- pedestrians who are carrying larger objects.

The driver is always responsible that the vehicle is driven correctly and with a safety distance adapted to the speed.

## Large animals

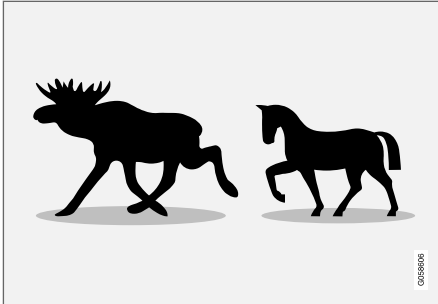

Optimum examples of what City Safety interprets as large animals - standing still or walking slowly and with clear body outline.

If a large animal appears in front of your car, Large Animal Detection, which is part of City Safety, can warn you of the animal in certain situations and provide braking assistance.

Optimal performance requires that the system function that detects a large animal (e.g. elk and horse) must receive the clearest possible information about the body outline, requiring the ability to identify the animal directly from the side in combination with what is a normal pattern of movement for the animal.

If parts of the animal's body are not visible to the function's camera then the system cannot detect the animal.

City Safety can also detect large animals in the dark if they are illuminated by the car's headlamps.

### WARNING

City Safety is supplementary driver support, but it cannot detect all large animals in all situations and, for example, cannot see:

- partially obscured large animals.
- large animals seen from the front or from behind.
- large animals that run or move quickly.
- large animals if the background contrast of the animals is poor - warning and brake interventions may then be late or not occur at all.
- small animals such as dogs and cats, for example.

The driver is always responsible that the vehicle is driven correctly and with a safety distance adapted to the speed.

### Related information

- City Safety™ (p. 335)
- Limitations of City Safety (p. 346)
- Limitations for City Safety in cross traffic (p. 342)
- Limitations of City Safety steering assistance when taking evasive action (p. 344)

## City Safety in cross traffic

City Safety can help the driver when turning and crossing the path of another oncoming vehicle at an intersection.

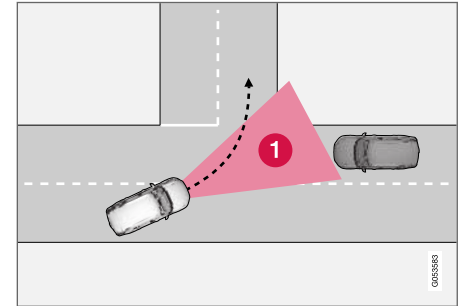

**1** Sector in which City Safety can detect oncoming crossing vehicles.

For City Safety to detect an oncoming vehicle on a collision course, the oncoming vehicle must first enter the sector in which City Safety can analyse the situation.

◀◀ The following further criteria must also be fulfilled:

- your car must be travelling at no less than 4 km/h (3 mph)
- your car must turn to the left in markets with right-hand traffic (or to the right in left-hand traffic)
- the oncoming vehicle must have its headlamps switched on.

### WARNING

Driver supports only warn of obstacles which their radar unit has detected – hence a warning may not be given, or it may be given with a certain delay.

- Never wait for a warning or intervention. Apply the brakes when the situation requires.

### WARNING

- The function is supplementary driver support intended to facilitate driving and make it safer – it cannot handle all situations in all traffic, weather and road conditions.
- The driver is advised to read all sections in the Owner's Manual that relate to this function to learn about factors such as its limitations and what the driver should be aware of before using the system.
- Driver support functions are not a substitute for the driver's attention and judgement. The driver is always responsible for ensuring the car is driven in a safe manner, at the appropriate speed, with an appropriate distance to other vehicles, and in accordance with current traffic rules and regulations.

### Related information

- City Safety™ (p. 335)
- Limitations for City Safety in cross traffic (p. 342)

## Limitations for City Safety in cross traffic

In some cases City Safety may have difficulty helping the driver deal with collision risks due to oncoming cross traffic.

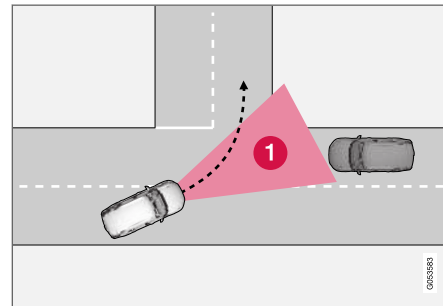

Examples are:

- stability control ESC intervenes in the event of slippery driving conditions
- if the oncoming vehicle is detected too late
- if the oncoming vehicle is obscured by something
- if the oncoming vehicle has headlamps switched off
- if the oncoming vehicle drives in an unpredictable manner, for example, abruptly changes lanes at a late stage.



**i NOTE**

This function uses the car's camera and radar units, which have certain general limitations.

**Related information**

- City Safety in cross traffic (p. 341)
- Limitations of City Safety (p. 346)
- Limitations for camera and radar unit (p. 330)

**City Safety steering assistance for evasive manoeuvre**

City Safety steering assistance can help the driver to steer away from a vehicle/obstacle when it is not possible to avoid a collision simply by braking. City Safety steering assistance cannot be switched off, it is always activated.

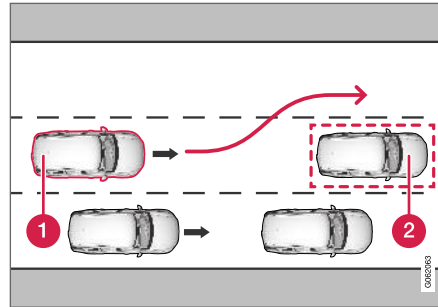

- 1 Your car steers away
- 2 Slow moving/stationary vehicles or obstacles.

City Safety engages by amplifying the driver's steering input, which only occurs after the driver has begun an evasive manoeuvre - and then only if the driver is not steering enough to avoid a collision.

In parallel with the amplified steering input, the brake system is also used to further amplify the steering input. The function also helps to

straighten the car again after passing the obstacle.

City Safety steering assistance can detect:

- Vehicles
- cyclists
- Pedestrians
- larger animals.

**⚠ WARNING**

- The function is supplementary driver support intended to facilitate driving and make it safer – it cannot handle all situations in all traffic, weather and road conditions.
- The driver is advised to read all sections in the Owner's Manual that relate to this function to learn about factors such as its limitations and what the driver should be aware of before using the system.
- Driver support functions are not a substitute for the driver's attention and judgement. The driver is always responsible for ensuring the car is driven in a safe manner, at the appropriate speed, with an appropriate distance to other vehicles, and in accordance with current traffic rules and regulations.

◀◀ **Related information**

- City Safety™ (p. 335)
- Limitations of City Safety steering assistance when taking evasive action (p. 344)

**Limitations of City Safety steering assistance when taking evasive action**

City Safety may have limited functionality in certain situations and fail to intervene e.g.:

- outside the speed range 50-100 km/h (30-62 mph)
- if the driver initiates an evasive manoeuvre
- if the steering servo creating speed-dependent steering wheel resistance is working at reduced power – e.g. when cooling due to overheating.

<b>i</b>	<b>NOTE</b>
This function uses the car's camera and radar units, which have certain general limitations.	

**Related information**

- City Safety steering assistance for evasive manoeuvre (p. 343)
- Limitations of City Safety (p. 346)
- Speed-dependent steering force (p. 278)
- Limitations for camera and radar unit (p. 330)

**City Safety when evasive manoeuvres are prevented**

City Safety has the facility to assist the driver by automatically braking the car earlier when it is not possible to avoid a collision by only steering away.

City Safety assists the driver by continuously attempting to anticipate whether there are "escape routes" to the side in case a slow or stationary vehicle ahead is discovered at a late stage.

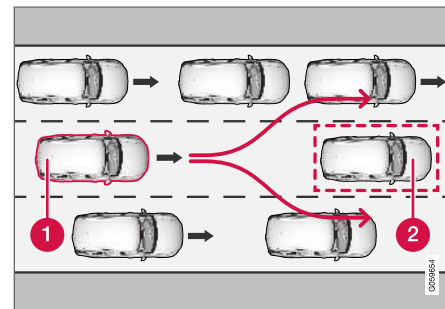

Your car (1) "sees" no options for evading the vehicle ahead (2) and can therefore auto-brake earlier.

- 1** Your car
- 2** Slow/stationary vehicle

City Safety does not intervene with the auto-brake function as long as the driver him/herself

has the opportunity to avoid a collision via a steering manoeuvre.

However, if City Safety anticipates that an evasive manoeuvre is not possible due to traffic in an adjacent lane, the function can assist the driver by automatically starting to brake at an earlier stage.

## **WARNING**

- The function is supplementary driver support intended to facilitate driving and make it safer – it cannot handle all situations in all traffic, weather and road conditions.
- The driver is advised to read all sections in the Owner's Manual that relate to this function to learn about factors such as its limitations and what the driver should be aware of before using the system.
- Driver support functions are not a substitute for the driver's attention and judgement. The driver is always responsible for ensuring the car is driven in a safe manner, at the appropriate speed, with an appropriate distance to other vehicles, and in accordance with current traffic rules and regulations.

## **NOTE**

This function uses the car's camera and radar units, which have certain general limitations.

## **Related information**

- City Safety™ (p. 335)
- Limitations of City Safety (p. 346)
- Limitations for camera and radar unit (p. 330)

## **City Safety brakes for oncoming vehicles**

City Safety can assist the driver to use emergency braking for an oncoming vehicle in your car's lane.

If an oncoming vehicle enters your car's lane and a collision is unavoidable, City Safety can reduce the car's speed with a view to reducing the violence of the impact.

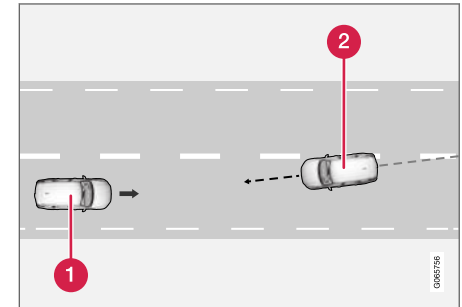

- 1 Your car
- 2 Oncoming vehicles

For this function to work, the following criteria must be met:

- your car must be travelling at more than 4 km/h (3 mph)
- the road section must be straight



- your car's lane must have clear lane markings
- your car must be positioned straight in its own lane
- the oncoming vehicle must be within your car's lane markings
- the oncoming vehicle must have its headlights switched on
- this function can only handle "front to front" collisions
- this function can only detect vehicles with four wheels.

### NOTE

This function uses the car's camera and radar units, which have certain general limitations.

### WARNING

Driver supports only warn of obstacles which their radar unit has detected – hence a warning may not be given, or it may be given with a certain delay.

- Never wait for a warning or intervention. Apply the brakes when the situation requires.

### WARNING

- The function is supplementary driver support intended to facilitate driving and make it safer – it cannot handle all situations in all traffic, weather and road conditions.
- The driver is advised to read all sections in the Owner's Manual that relate to this function to learn about factors such as its limitations and what the driver should be aware of before using the system.
- Driver support functions are not a substitute for the driver's attention and judgement. The driver is always responsible for ensuring the car is driven in a safe manner, at the appropriate speed, with an appropriate distance to other vehicles, and in accordance with current traffic rules and regulations.

### Related information

- City Safety™ (p. 335)
- Limitations of City Safety (p. 346)
- Limitations for camera and radar unit (p. 330)

## Limitations of City Safety

The City Safety<sup>64</sup> function may have limitations in certain situations.

### Surroundings

#### Low objects

Low-hanging objects, e.g. a flag/pennant for projecting load, or accessories such as auxiliary lamps and bull bars that are higher than the bonnet limit the function.

#### Skidding

On slippery road surfaces the braking distance is extended, which may reduce the capacity of City Safety to avoid a collision. In such situations, the anti-lock brakes and the stability control ESC<sup>65</sup> will give the best possible braking force with maintained stability.

#### Oncoming light

The visual warning signal in the windscreen may be difficult to notice in the event of strong sunlight, reflections, when sunglasses are being worn or if the driver is not looking straight ahead.

#### Heat

In the event of high passenger compartment temperature caused by e.g. strong sunlight, the visual warning signal in the windscreen may be temporarily disengaged.

<sup>64</sup> The function is not available in all markets.

<sup>65</sup> Electronic Stability Control

### The camera and radar unit's field of view

The camera's field of vision is limited, which is why pedestrians, large animals, cyclists and vehicles in some situations cannot be detected, or they are detected later than anticipated.

Dirty vehicles may be detected later than others and if it is dark, motorcycles may be detected late or not at all.

If a text message in the driver display indicates that the camera and radar unit is obstructed, City Safety may be unable to detect pedestrians, large animals, cyclists, vehicles or road lines ahead of the car. This means that the functionality of City Safety may be reduced.

However, an error message is not shown in all situations where the windscreen sensors are obstructed. The driver must therefore take care to keep the area of windscreen in front of the camera and radar unit clear.

#### IMPORTANT

Maintenance of driver support components may only be performed at a workshop<sup>66</sup>.

### Driver intervention

#### Reversing

When your own car is reversing, City Safety is temporarily deactivated.

### Low speed

City Safety is not activated at very low speeds - below 4 km/h (3 mph) - and the system therefore does not intervene in situations where your car is approaching a vehicle ahead very slowly, e.g. when parking.

#### Active driver

Driver commands are always prioritised, which is why City Safety does not intervene or postpone warning/intervention in situations where the driver is steering and accelerating in a decisive manner, even if a collision is unavoidable.

Active and aware driving behaviour can therefore delay a collision warning and intervention in order to minimise unnecessary warnings.

### Miscellaneous

#### WARNING

- Warnings and brake interventions could be implemented late or not at all if a traffic situation or external influences mean that the camera and radar unit cannot detect pedestrians, cyclists, large animals or vehicles correctly.
- For vehicles to be detected at night, their headlamps and rear lamp cluster must be switched on and shining clearly.
- The camera and radar unit has a limited range for pedestrians and cyclists. The system can provide effective warnings and brake interventions as long as the relative speed is below 50 km/h (30 mph). For stationary or slow-moving vehicles, warnings and brake interventions are effective at vehicle speeds up to 70 km/h (43 mph). Speed reduction for large animals is less than 15 km/h (9 mph) and can be achieved at vehicle speeds above 70 km/h (43 mph). The warning and brake intervention for large animals is less effective at lower speeds.
- Warnings for stationary or slow-moving vehicles and large animals could be dis-

<sup>66</sup> An authorised Volvo workshop is recommended.



engaged due to darkness or poor visibility.

- Warnings and brake interventions for pedestrians and cyclists are deactivated at vehicle speeds exceeding 80 km/h (50 mph).
- Do not place, stick or mount anything on the outside or inside of the windscreen in front of or around the camera and radar unit — this can interfere with camera-dependent functions.
- Objects, snow, ice or dirt in the area of the camera sensor may reduce its functionality, fully deactivate it or give incorrect function response.

### **NOTE**

This function uses the car's camera and radar units, which have certain general limitations.

### **Market limitation**

City Safety is not available in all countries. If City Safety does not appear in the centre display's **Settings** menu, the car is not equipped with this function.

Search path in the top view of the centre display:

- **Settings → My Car → IntelliSafe**

### **Related information**

- City Safety™ (p. 335)
- Limitations for City Safety in cross traffic (p. 342)
- Limitations of City Safety steering assistance when taking evasive action (p. 344)
- Limitations for camera and radar unit (p. 330)

## Messages for City Safety

A number of messages regarding City Safety can be shown in the driver display.

The following table shows some examples.

Message	Specification
<b>City Safety</b> <b>Automatic intervention</b>	When City Safety brakes or has done an automatic braking, several of the driver display symbols may be illuminated in connection with a text message being shown.
<b>City Safety</b> <b>Reduced functionality Service required</b>	The system does not function as it should. A workshop should be contacted - an authorised Volvo workshop is recommended.

A text message can be cleared by briefly pressing the  button, located in the centre of the steering wheel's right-hand keypad.

If a message remains: Contact a workshop – an authorised Volvo workshop is recommended.

### Related information

- City Safety™ (p. 335)

## Rear Collision Warning<sup>67</sup>

The Rear Collision Warning<sup>68</sup> (RCW) function can help the driver to avoid being hit by a vehicle approaching from behind.

This function is activated automatically each time the engine is started.

Drivers in vehicles behind can be warned about an imminent collision by the function flashing intensively with the direction indicators.

If, at a speed below 30 km/h (20 mph), the function detects that the car is in danger of being hit from behind, the seatbelt tensioners may tension the front seatbelts and activate the Whiplash Protection System safety system.

Immediately before a collision from behind, this function may also activate the foot brake in order to reduce the forward acceleration of the car during the collision. However, the foot brake is only activated if the car is stationary. The foot brake releases immediately if the accelerator pedal is depressed.

### Related information

- Driving support systems (p. 278)
- Limitations of Rear Collision Warning (p. 350)
- Whiplash Protection System (p. 43)

<sup>67</sup> RCW: Rear collision warning.

<sup>68</sup> The function is not available in all markets.

<sup>69</sup> RCW: Rear collision warning.

## Limitations of Rear Collision Warning<sup>69</sup>

In certain cases the Rear Collision Warning (RCW) may have difficulty helping the driver in the event of a collision risk.

This can, for example, be if:

- the vehicle approaching from behind is detected too late
- the vehicle approaching from behind changes lane at the last moment
- a trailer, bicycle rack or similar is connected to the car's electrical system - the function is then deactivated automatically.

### NOTE

In certain markets, RCW does **not** give a warning with the direction indicators due to local traffic regulations - in such cases, this part of the function is deactivated.

### NOTE

The warning with direction indicators for Rear Collision Warning is deactivated if the warning distance for collision warning in the City Safety function is set at the lowest level "**Late**".

The seat belt pre-tensioning and braking functions are, however, still active.

### Related information

- Rear Collision Warning (p. 350)



## BLIS\*

The BLIS<sup>70</sup> function is intended to help the driver detect vehicles diagonally behind and to the side of the car so as to provide assistance in heavy traffic on roads with several lanes in the same direction.

BLIS is a driver aid intended to give a warning of:

- vehicles in the car's blind spot
- quickly approaching vehicles in the left and right lanes closest to the car.

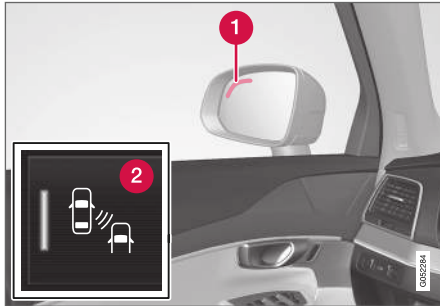

Location of BLIS lamp<sup>71</sup>.

- 1 Indicator lamp
- 2 The function is activated/deactivated using the BLIS button in the centre display's function view.

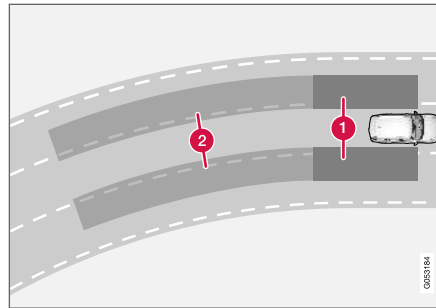

Principle of BLIS

- 1 Zone in blind spot
- 2 Zone for quickly approaching vehicle.

The BLIS function is active at speeds above 10 km/h (6 mph).

The system is designed to react when:

- your car is overtaken by other vehicles
- another vehicle is quickly approaching your car.

When BLIS detects a vehicle in Zone 1 or a quickly approaching vehicle in Zone 2, the indicator lamp on the door mirror on the affected side illuminates with a constant glow. If the driver activates the direction indicator on the same side as the warning, the indicator lamp will change over

from a constant glow to flashing with a more intense light.

### **i** NOTE

The lamp illuminates on the side of the car where the system has detected the vehicle. If the car is overtaken on both sides at the same time then both lamps illuminate.

<sup>70</sup> Blind Spot Information Systems

<sup>71</sup> NOTE: The illustration is schematic - details may vary depending on car model.



## **⚠ WARNING**

- The function is supplementary driver support intended to facilitate driving and make it safer – it cannot handle all situations in all traffic, weather and road conditions.
- The driver is advised to read all sections in the Owner's Manual that relate to this function to learn about factors such as its limitations and what the driver should be aware of before using the system.
- Driver support functions are not a substitute for the driver's attention and judgement. The driver is always responsible for ensuring the car is driven in a safe manner, at the appropriate speed, with an appropriate distance to other vehicles, and in accordance with current traffic rules and regulations.

## **i NOTE**

This function uses the car's camera and radar units, which have certain general limitations.

## **Related information**

- Driving support systems (p. 278)
- Activating or deactivating BLIS (p. 352)
- Limitations of BLIS (p. 353)
- Messages for BLIS (p. 354)

## **Activating or deactivating BLIS**

The BLIS<sup>72</sup> function can be activated or deactivated.

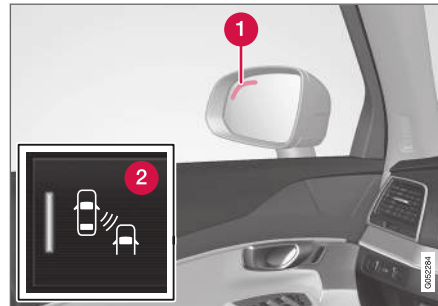

Location of BLIS lamp.

- 1** Indicator lamp
- 2** Activate or deactivate the function using this button in the centre display's function view.
  - GREEN button indication – the function is activated.
  - GREY button indication – the function is deactivated.

If BLIS is activated when starting the engine, the function is confirmed by the door mirror indicator lamps blinking once.

If BLIS was deactivated when the engine was switched off, it will continue to be deactivated when the engine is next started and no indicator lights will then be illuminated.

## **Related information**

- BLIS\* (p. 351)

## Limitations of BLIS

The BLIS<sup>73</sup> function may have limitations in certain situations.

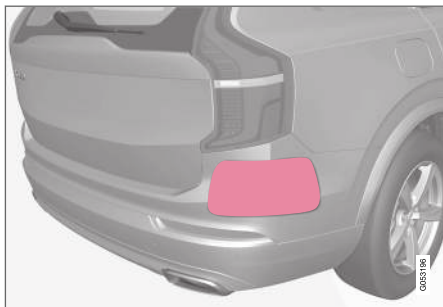

Keep the surface indicated clean – on both the left and right-hand sides of the car<sup>74</sup>.

Examples of limitations:

- Dirt, ice and snow covering the sensors may reduce the functions and deactivate alerts.
- The BLIS function is automatically deactivated if a trailer, bicycle rack or similar is connected to the car's electrical system.
- For optimal performance of BLIS, no bicycle rack, luggage carrier or similar should be mounted on the car's towbar.

### WARNING

- BLIS does not work on sharp bends.
- BLIS does not work when the car is reversing.

### NOTE

This function uses the car's camera and radar units, which have certain general limitations.

### Related information

- BLIS\* (p. 351)
- Limitations for camera and radar unit (p. 330)

<sup>72</sup> Blind Spot Information Systems

<sup>73</sup> Blind Spot Information Systems

<sup>74</sup> NOTE: The illustration is schematic - details may vary depending on car model.

## Messages for BLIS

A number of messages regarding BLIS<sup>75</sup> can be shown in the driver display.

The following table shows some examples.

Message	Specification
<b>Blind spot sensor Service required</b>	The system does not function as it should. A workshop should be contacted - an authorised Volvo workshop is recommended.
<b>Blind spot system off Trailer attached</b>	BLIS and CTA <sup>A</sup> have been deactivated as a trailer has been connected to the car's electrical system.

<sup>A</sup> Cross Traffic Alert\*

A text message can be cleared by briefly pressing the  button, located in the centre of the steering wheel's right-hand keypad.

If a message remains: Contact a workshop – an authorised Volvo workshop is recommended.

### Related information

- BLIS\* (p. 351)
- Cross Traffic Alert\* (p. 355)

<sup>75</sup> Blind Spot Information System

## Cross Traffic Alert<sup>76\*</sup>

Cross Traffic Alert (CTA) is a driver support that supplements BLIS<sup>77</sup> and is designed to help the driver detect traffic crossing behind the car when it is reversing.

The **auto-brake** subfunction can stop the car in the event of a risk of collision with an unobserved vehicle.

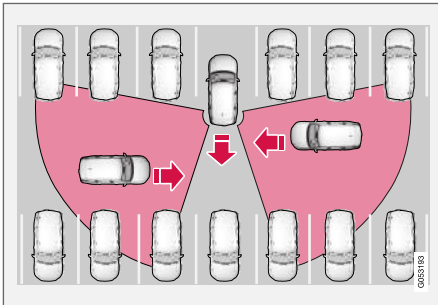

Principle of CTA

CTA supplements BLIS by detecting the approach of crossing traffic during reversing, such as when reversing out of a parking space.

CTA is primarily designed to detect vehicles. In favourable conditions it may also be able to detect smaller objects, such as cyclists and pedestrians.

<sup>76</sup> Cross traffic alert when the car is reversing.

<sup>77</sup> Blind Spot Information

CTA is only active if the car rolls backwards or if reverse gear has been selected.

If CTA senses that something is approaching from the side, this is also indicated with:

- an acoustic signal - the sound is heard in the left-hand or right-hand speaker according to the direction from which the object approaches.
- an illuminated icon in the **Park Assist System** graphic on the screen.
- an icon on the Park assist camera top view.

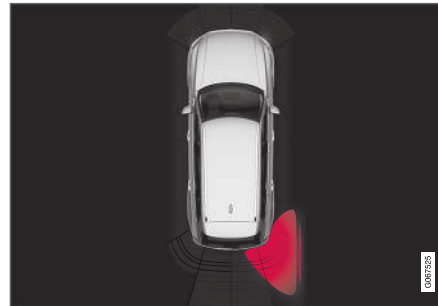

Illuminated icon for CTA in the **Park Assist System** graphic on the screen.

- If the driver does not observe the warning from CTA and a collision is unavoidable, the **auto-brake** function takes effect to stop the

car, after which the driver display shows an explanatory text message on why the car was braked.

### **WARNING**

The **auto-brake** subfunction can only detect and brake for other vehicles that are moving – **not** for stationary obstacles, a cyclist or a pedestrian, for example.



**⚠ WARNING**

- The function is supplementary driver support intended to facilitate driving and make it safer – it cannot handle all situations in all traffic, weather and road conditions.
- The driver is advised to read all sections in the Owner's Manual that relate to this function to learn about factors such as its limitations and what the driver should be aware of before using the system.
- Driver support functions are not a substitute for the driver's attention and judgement. The driver is always responsible for ensuring the car is driven in a safe manner, at the appropriate speed, with an appropriate distance to other vehicles, and in accordance with current traffic rules and regulations.

**Related information**

- Driving support systems (p. 278)
- Activate/deactivate Cross Traffic Alert (p. 356)
- Limitations of Cross Traffic Alert (p. 356)
- Messages for Cross Traffic Alert (p. 358)
- BLIS\* (p. 351)
- Park Assist\* (p. 381)

<sup>78</sup> Cross traffic alert when the car is reversing.

**Activate/deactivate Cross Traffic Alert<sup>78</sup>**

The driver can select to switch off the **warning** in the function CTA<sup>79</sup> – the subfunction **auto brake** cannot be switched off and continues to be active.



Activate or deactivate the function using this button in the centre display's function view.

- GREEN button indication – the function is activated.
- GREY button indication – warning signal and indication on display for the function is deactivated.

The function is activated automatically each time the engine is started.

**Related information**

- Cross Traffic Alert\* (p. 355)

**Limitations of Cross Traffic Alert<sup>80</sup>**

The CTA<sup>81</sup> function with **auto-brake** may have limited functionality in certain situations. Brake intervention is active at speeds below 15 km/h.

CTA does not perform optimally in all situations but has some limitations. For example, the CTA sensors cannot "see" through other parked vehicles or obstructing obstacles.

Here are some examples of situations where CTA's "field of vision" may be already limited and approaching vehicles cannot therefore be detected until they are very close:

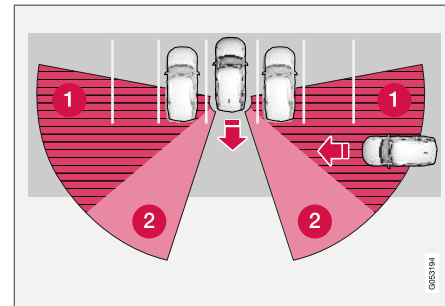

The car is parked deep inside a parking slot.

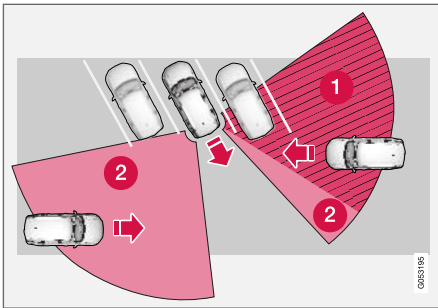

In an angled parking slot CTA may be completely "blind" on one side.

- 1 Blind CTA sector.
- 2 Sector in which CTA can detect/"see".

However, as your car slowly reverses, the angle it makes with the obstructing vehicle/object changes and the blind sector rapidly decreases.

#### Examples of further limitations

- The **auto-brake** subfunction only detects moving vehicles and therefore **cannot** "see" and brake for stationary obstacles, a cyclist or a pedestrian, for example.
- Dirt, ice and snow covering the sensors may reduce the functions and deactivate alerts.

- CTA is automatically deactivated if a trailer, bicycle rack or similar is connected to the car's electrical system.
- For optimal performance of CTA, no bicycle rack, luggage carrier or similar should be mounted on the car's towbar.

#### **i** NOTE

This function uses the car's camera and radar units, which have certain general limitations.

#### Related information

- Cross Traffic Alert\* (p. 355)
- Limitations for camera and radar unit (p. 330)

<sup>79</sup> Cross Traffic Alert

<sup>80</sup> Cross traffic alert when the car is reversing.

<sup>81</sup> Cross Traffic Alert

## Messages for Cross Traffic Alert<sup>82</sup>

A number of messages regarding CTA<sup>83</sup> with **auto-brake** can be shown in the driver display. The following table shows examples.

Message	Specification
Blind spot sensor Service required	The system does not function as it should. A workshop should be contacted - an authorised Volvo workshop is recommended.
Blind spot system off Trailer attached	BLIS <sup>A</sup> and CTA have been deactivated as a trailer has been connected to the car's electrical system.

<sup>A</sup> Blind Spot Information System

A text message can be cleared by briefly pressing the  button, located in the centre of the steering wheel's right-hand keypad.

If a message remains: Contact a workshop – an authorised Volvo workshop is recommended.

### Related information

- Cross Traffic Alert\* (p. 355)
- BLIS\* (p. 351)

<sup>82</sup> Cross traffic alert when the car is reversing.

<sup>83</sup> Cross Traffic Alert



## Road Sign Information\*

The Road Sign Information function (RSI<sup>84</sup>) can help the driver to observe speed-related road signs and certain prohibition signs.

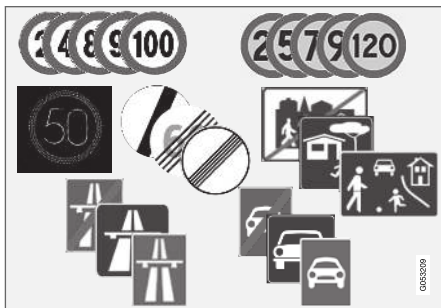

Examples of readable signs<sup>85</sup>.

RSI can provide information about such things as current speed, when a motorway or road is starting/ending, when overtaking is prohibited or when the direction of travel is one-way.

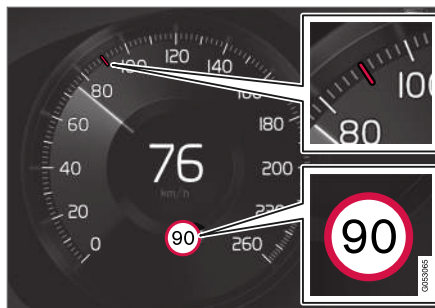

Example<sup>85</sup> of detected speed information.

If the car passes a speed limit sign, it will be shown on the driver's display and the head-up display\*.

### **i** NOTE

In certain markets, the Road Sign Information function\* is only available in combination with Sensus Navigation\*.

### **⚠** WARNING

- The function is supplementary driver support intended to facilitate driving and make it safer – it cannot handle all situations in all traffic, weather and road conditions.
- The driver is advised to read all sections in the Owner's Manual that relate to this function to learn about factors such as its limitations and what the driver should be aware of before using the system.
- Driver support functions are not a substitute for the driver's attention and judgement. The driver is always responsible for ensuring the car is driven in a safe manner, at the appropriate speed, with an appropriate distance to other vehicles, and in accordance with current traffic rules and regulations.

### Related information

- Driving support systems (p. 278)
- Activating/deactivating Road Sign Information\* (p. 360)
- Road Sign Information and sign display\* (p. 361)
- Road Sign Information and Sensus Navigation\* (p. 363)

<sup>84</sup> Road Sign Information

<sup>85</sup> Road signs are market-dependent - illustrations in these instructions only show a few examples.

- Road Sign Information with speed warning and settings\* (p. 363)
- Road Sign Information with Speed Camera Information\* (p. 365)
- Limitations of Road Sign Information\* (p. 365)

### Activating/deactivating Road Sign Information\*

The Road Sign Information function (RSI<sup>86</sup>) is optional – the driver can choose to activate or deactivate this function.



Activate or deactivate the function using this button in the centre display's function view.

- GREEN button indication – the function is activated.
- GREY button indication – the function is deactivated.

Road Sign Information is activated automatically each time the engine is started.

<b>i NOTE</b>
<ul style="list-style-type: none"><li>• If the automatic speed limiter function is activated, road sign information is shown in the driver display even if the Road Sign Information function is not activated.</li><li>• To remove road sign information from the driver display, you must deactivate <b>both</b> the automatic speed limiter and Road Sign Information.</li><li>• When the automatic speed limiter function is activated but Road Sign Information is deactivated, no warnings are given from Road Sign Information. Road Sign Information must also be activated in order to receive warnings.</li></ul>

#### Related information

- Road Sign Information\* (p. 359)
- Automatic speed limiter (p. 288)

<sup>86</sup> RSI: Road Sign Information.

## Road Sign Information and sign display\*

The Road Sign Information function (RSI<sup>87</sup>) shows road signs in different ways depending on the sign and the situation.

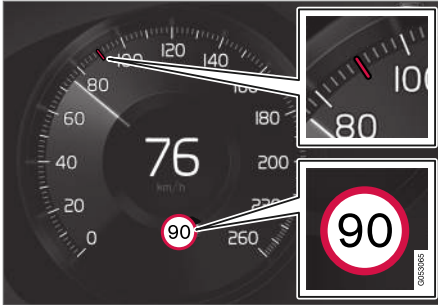

Example<sup>88</sup> of detected speed information.

When the function detects a road sign with an imposed speed limit, the driver display shows the sign as a symbol combined with a coloured indication on the speedometer.

If the car is fitted with Sensus Navigation\*, speed-related information is also obtained from map data, which means that the driver display can show or change information on the speed limit without having passed a speed-related sign.



An additional<sup>88</sup> sign, such as "no overtaking", may be shown together with the speed limit symbol.

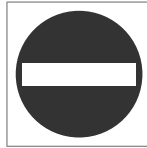

If the driver enters a road marked with a no-entry sign at the roadside, the symbol for this sign<sup>88</sup> flashes on and off on the driver display as a warning.

If the car is equipped with Sensus Navigation\*, information from map data is used to determine whether the car is being driven in the wrong direction.

The driver can also get an acoustic warning when driving towards a road marked with a no-entry sign if the **Road Sign Audio Warning** function is activated.

### Speed limit or end of motorway

When the function detects an "indirect speed limit sign" stating the end of the current speed limit – e.g. at the end of a motorway – a symbol appears with the corresponding road sign in the driver's display.

If the car is equipped with Sensus Navigation\*, direct speed limit signs are normally displayed – indirect speed limit signs are only displayed if map data has no information on the speed limit for the road section in question.

Example of indirect speed limit sign<sup>88</sup>:

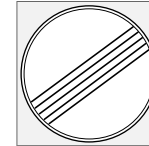

End of all restrictions.



End of motorway.

The driver display symbol extinguishes after 10-30 seconds and remains so until the next speed related sign is passed.

### Changed speed limit

When passing a direct speed limit sign when a speed limit changes, a symbol with the corresponding road sign appears in the driver's display.

<sup>87</sup> Road Sign Information

<sup>88</sup> Road signs are market-dependent - the illustrations in these instructions only show examples.



Example of direct speed limit sign<sup>88</sup>.

The driver display symbol extinguishes after about 5 minutes until the next speed-related sign is passed.

If the car is fitted with Sensus Navigation\*, speed limit signs are shown in the driver display when map data contains information on the speed limit for the road section in question, even if no direct sign has been passed. If there is no information in map data, the sign goes off after approx. 3 minutes after the last passing of a speed limit sign.

### Additional signs

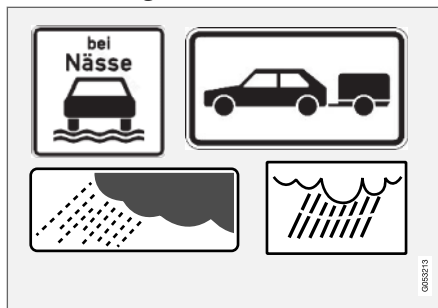

Examples of additional signs<sup>88</sup>.

Sometimes different speed limits are signed for the same road - an additional sign then indicates the circumstances under which the different speeds apply. The road section may be particularly susceptible to accidents in rain and/or fog, for example.

An additional sign relating to rain is displayed only if the windscreen wipers are in use.

If a trailer is connected to the car's electrical system and you pass a speed sign with the additional sign "trailer", the indicated speed will appear on the driver display.

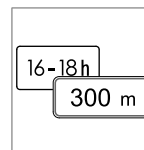

Some speed limits only apply after a certain distance or at a certain time of day. The driver's attention is drawn to this fact by means of a symbol for an additional sign below the speed symbol. The additional symbol

in the driver display will show either "DIST" or "TIME".

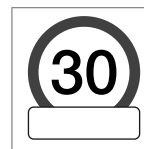

A symbol for additional sign in the form of an empty frame under the driver display's speed symbol<sup>88</sup> means that the function has detected an additional sign with supplementary information for the current speed

limit.

### Sign for "School" and "Children at play"



If a warning sign<sup>88</sup> for "School" or "Children at play" is included in the satellite navigator's map data<sup>89</sup>, the driver display shows a sign of this type.

### Related information

- Road Sign Information\* (p. 359)

<sup>88</sup> Road signs are market-dependent - the illustrations in these instructions only show examples.

<sup>89</sup> Only in cars with Sensus Navigation\*.

## Road Sign Information and Sensus Navigation\*

If the car is equipped with Sensus Navigation\*, speed information is read from the navigation unit in the following cases:

- On detection of signs that indirectly indicate a speed limit, such as motorway, dual carriageway and city limit signs.
- If a previously detected speed sign is assumed not to apply any longer, but no new sign has been detected.

### **i** NOTE

In certain markets, the Road Sign Information function\* is only available in combination with Sensus Navigation\*.

### **i** NOTE

If a downloaded third-party app is used for navigation then there is no support for speed-related information.

## Related information

- Road Sign Information\* (p. 359)

## Road Sign Information with speed warning and settings\*

The subfunction **Speed Limit Warning** for Road Sign Information (RSI<sup>90</sup>) is optional – the driver can choose to activate or deactivate this subfunction.

**Speed Limit Warning** warns the driver when the applicable speed limit or a preselected "top speed" is exceeded – this warning is repeated once after approx. 30 seconds within the same speed limit area unless the driver reduces the speed.

Another warning is available only when the driver has reduced the speed by at least 5 km/h (3 mph) and then exceeds the speed limit again, or when the car reaches a new/different speed limit area.



The speed warning is given by the driver display symbol<sup>91</sup> showing the applicable maximum permitted speed temporarily flashing when this speed is exceeded.



A speed warning is always given if the speed limit is exceeded in connection with speed camera information.

## Settings

### Adjust the limit for Speed Warning

The driver can select to receive a warning at a higher speed than the signed speed.

Select limit for speed warning as follows:

1. Select **Settings** → **My Car** → **IntelliSafe** → **Road Sign Information** in the centre display's top view.
2. Select **Speed Limit Warning**.
  - > The function is activated and a speed limit selector appears.
3. Adjust the limit for Speed Warning by pressing the up/down arrows on the screen.



Note that the function does not give any consideration to selected limit adjustment when the driver display shows the speed camera symbol.

<sup>90</sup> Road Sign Information

<sup>91</sup> Road signs are customised for each market – the one shown here is just an example.

#### ◀ **Audible warning activated/deactivated**

It is also possible to receive an audible warning in connection with Speed Warning.

Change setting for acoustic warning as follows:

1. Select **Settings → My Car → IntelliSafe → Road Sign Information** in the centre display's top view.
2. Select/deselect **Road Sign Audio Warning** to activate/switch off the acoustic warning.

With the **Road Sign Audio Warning** function activated, the driver is also warned when driving towards one-way traffic/no-entry entrance.

#### **Speed camera warning activated/deactivated**



If the car is fitted with Sensus Navigation\* and map data contains information on speed cameras, the driver can opt to receive an audible warning when approaching a speed camera.

Change setting for acoustic warning as follows:

1. Select **Settings → My Car → IntelliSafe → Road Sign Information** in the centre display's top view.
2. Select/deselect **Speed Camera Audio Warning** to activate/switch off the audible speed camera warning.

#### **Related information**

- Road Sign Information\* (p. 359)
- Activating/deactivating Speed warning in Road Sign Information (p. 364)

#### **Activating/deactivating Speed warning in Road Sign Information**

The subfunction **Speed Limit Warning** is activated as follows:

1. Select **Settings → My Car → IntelliSafe → Road Sign Information** in the centre display's top view.
2. Select **Speed Limit Warning**.
  - > The function is activated and a speed limit selector appears.

#### **Related information**

- Road Sign Information\* (p. 359)
- Road Sign Information with speed warning and settings\* (p. 363)

## Road Sign Information with Speed Camera Information\*

A car equipped with Road Sign Information (RSI<sup>92</sup>) and Sensus Navigation\* can provide information on an upcoming speed camera in the driver display.



Speed camera information in the driver display.



If the car exceeds a detected speed limit with the **Speed Limit Warning** function activated, a speed warning is given when the car approaches a speed camera, provided that the navigation map for the area

in question contains information on speed cameras.

### **i** NOTE

- To get an acoustic warning if you exceed the required speed, the **Speed Limit Warning** function must be activated and the **Road Sign Audio Warning** sub-function must be set to **On**. An acoustic warning is then given if the car's speed exceeds the speed indicated by the RSI function in the driver display.
- An option is available to receive an acoustic warning for speed cameras independently of the car's speed and exceeded speed limit, and even if the **Road Sign Audio Warning** function is deactivated.
- Information about speed cameras on the navigation map is not available for all markets/areas.

### Related information

- Road Sign Information\* (p. 359)

## Limitations of Road Sign Information\*

The Road Sign Information (RSI<sup>93</sup>) function may have limitations in certain situations.

Examples of what can reduce the function are as follows:

- Faded signs
- Signs positioned on bends
- Rotated or damaged signs
- Signs positioned high above the roadway
- Fully/partially obscured or poorly positioned signs

<sup>92</sup> Road Sign Information

<sup>93</sup> Road Sign Information

- ◀ • signs completely or partly covered with frost, snow and/or dirt
- digital road maps<sup>94</sup> are out-of-date, inaccurate or have no speed information<sup>95</sup>.

**i NOTE**

The RSI function may interpret some types of bicycle rack, connected to the electrical socket for trailers, as a connected trailer. In such cases, the driver display may show incorrect speed information.

**i NOTE**

This function uses the car's camera and radar units, which have certain general limitations.

**Related information**

- Road Sign Information\* (p. 359)
- Limitations for camera and radar unit (p. 330)

**Driver Alert Control**

The Driver Alert Control (DAC) function is intended to help make the driver aware that he or she is starting to drive less consistently, e.g. if the driver becomes distracted or starts to fall asleep.

The objective for DAC is to detect slowly deteriorating driving ability and it is primarily intended for major roads. The function is not intended for city traffic.

The function is activated when speed exceeds 65 km/h (40 mph) and remains active as long as the speed is over 60 km/h (37 mph).

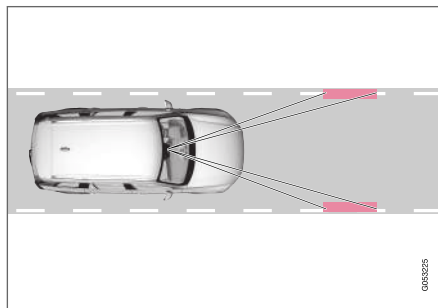

DAC reads the position of the car in the lane.

A camera detects the edge markings painted on the carriageway and compares the alignment of

the road with the driver's steering wheel movements.

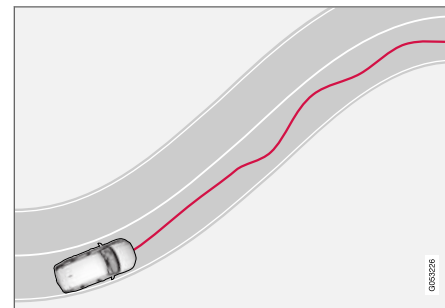

The car is being driven erratically in the lane.



If driving behaviour becomes noticeably inconsistent, the driver is alerted by this symbol in the driver display, combined with an acoustic signal and the text message **Time to take a**

**break.**

If the car is equipped with Sensus Navigation\* and has the function **Rest Stop Guidance** activated, suggestions for an appropriate place for a break are also displayed.

<sup>94</sup> In cars equipped with Sensus Navigation\*.

<sup>95</sup> Map data with speed information does not exist for all areas.



The warning is repeated after a time if driving behaviour has not improved.

### WARNING

Driver Alert Control should not be used to extend a period of driving. The driver should instead plan for breaks at regular intervals and make sure they are well rested.

### WARNING

- The function is supplementary driver support intended to facilitate driving and make it safer – it cannot handle all situations in all traffic, weather and road conditions.
- The driver is advised to read all sections in the Owner's Manual that relate to this function to learn about factors such as its limitations and what the driver should be aware of before using the system.
- Driver support functions are not a substitute for the driver's attention and judgement. The driver is always responsible for ensuring the car is driven in a safe manner, at the appropriate speed, with an appropriate distance to other vehicles, and in accordance with current traffic rules and regulations.

### WARNING

An alarm from Driver Alert Control should be taken very seriously, as a sleepy driver is often not aware of his/her own condition.

If the alarm sounds or you feel fatigued:

- Stop the car safely as soon as possible and rest.

Studies have shown that it is just as dangerous to drive while tired as it is to drive under the influence of alcohol or other stimulants.

#### Related information

- Driving support systems (p. 278)
- Activate/deactivate Driver Alert Control (p. 367)
- Select rest stop guidance in the event of a warning from Driver Alert Control (p. 368)
- Limitations of Driver Alert Control (p. 368)

## Activate/deactivate Driver Alert Control

The Driver Alert Control (DAC) function can be activated/deactivated.

### On/Off

To change settings in DAC:

1. Tap on **Settings** in the centre display's top view.
2. Select **My Car** → **IntelliSafe** → **Driver Alert Control**.
3. Select/deselect **Alertness Warning** to activate/deactivate DAC.

### Related information

- Driver Alert Control (p. 366)
- Limitations of Driver Alert Control (p. 368)

## Select rest stop guidance in the event of a warning from Driver Alert Control

It is possible to select whether the **Rest Stop Guidance** function should be activated/deactivated.

In cars equipped with Sensus Navigation\*, the driver can activate a guide that can automatically suggest an appropriate rest area when DAC issues a warning.

To select **Rest Stop Guidance**:

1. Tap on **Settings** in the centre display's top view.
2. Select **My Car** → **IntelliSafe** → **Driver Alert Control**.
3. Select/deselect **Rest Stop Guidance** to activate/deactivate the function.

### Related information

- Driver Alert Control (p. 366)

## Limitations of Driver Alert Control

The Driver Alert Control (DAC) function may have limitations in certain situations.

In some cases the system may issue a warning despite driving ability not deteriorating, for example:

- in strong side winds
- on rutted road surfaces.

### WARNING

In some cases, driving behaviour is not affected despite driver fatigue – e.g. when using the Pilot Assist function – resulting in the driver not getting a warning from DAC.

It is therefore important to always stop and take a break at the slightest feeling of fatigue, whether the DAC function has given a warning or not.

### NOTE

This function uses the car's camera and radar units, which have certain general limitations.

### Related information

- Driver Alert Control (p. 366)
- Limitations for camera and radar unit (p. 330)

## Lane assistance

The function of the Lane Keeping Aid (LKA<sup>96</sup>) is to help the driver to reduce the risk of the car accidentally leaving its own lane on motorways and similar major routes.

Lane Keeping Aid steers the car back into its lane and/or alerts the driver with vibrations in the steering wheel.

Lane Keeping Aid is active within the speed range 65–200 km/h (40–125 mph) on roads with clearly visible side lines.

On narrow roads the function may be unavailable, in which case it goes into standby mode. The function becomes available again when the road is wide enough.

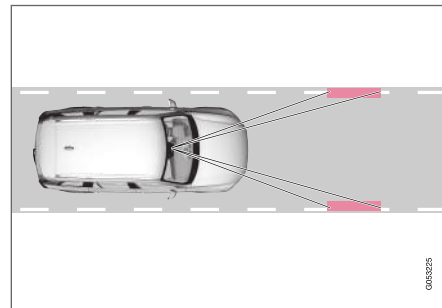

A camera reads the side lines of the road/lane.

<sup>96</sup> Lane Keeping Aid

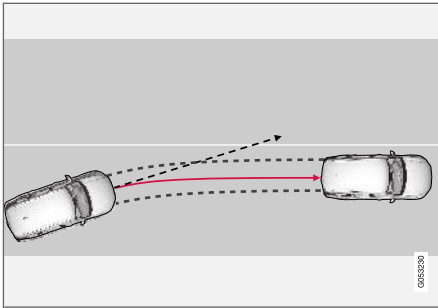

Lane assistance steers the car back into its lane.

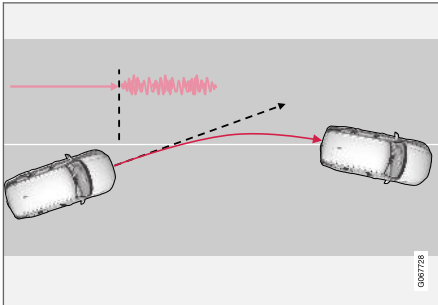

Lane assistance warns with steering wheel vibrations.

Depending on settings, lane assistance acts in accordance with the following:

- **Assist** activated: When the car is approaching a lane line, the function will actively steer

the car back into its lane by applying a slight torque to the steering wheel.

- **Warning** activated: If the car is about to cross a lane line, the driver is warned by means of vibrations in the steering wheel.

#### **i** NOTE

When a direction indicator/flasher is switched on, there are no steering corrections or alerts from lane assistance.

#### **⚠** WARNING

- The function is supplementary driver support intended to facilitate driving and make it safer – it cannot handle all situations in all traffic, weather and road conditions.
- The driver is advised to read all sections in the Owner's Manual that relate to this function to learn about factors such as its limitations and what the driver should be aware of before using the system.
- Driver support functions are not a substitute for the driver's attention and judgement. The driver is always responsible for ensuring the car is driven in a safe manner, at the appropriate speed, with an appropriate distance to other vehicles, and in accordance with current traffic rules and regulations.

#### Lane assistance does not intervene

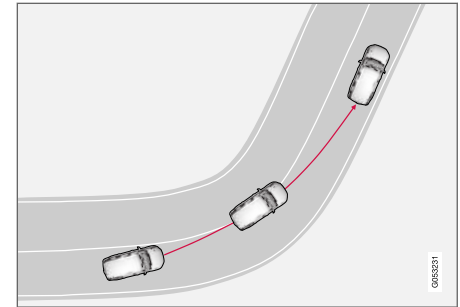

Lane assistance does not engage on sharp inside curves.

In some situations, lane assistance allows lane lines to be crossed without intervening with either steering assistance or a warning – e.g. when using the direction indicators or cutting bends.

#### Related information

- Driving support systems (p. 278)
- Steering assistance with lane assistance (p. 370)
- Activate/deactivate Lane Keeping Aid (p. 370)
- Limitations of Lane assistance (p. 371)
- Symbols and messages for lane assistance (p. 372)

## Steering assistance with lane assistance

For steering assistance with Lane Keeping Aid (LKA<sup>97</sup>) to work, the driver must have his/her hands on the steering wheel, which the system will continue to control.



If the driver does not keep his/her hands on the steering wheel, a warning signal is heard and a message encourages the driver to steer the car actively:

- **Lane Keeping Aid Apply steering**

If the driver follows the prompt to start steering, the function is set in standby mode and this message is shown:

- **Lane Keeping Aid Standby until steering applied**

The function will then be unavailable until the driver starts to steer the car again.

### Related information

- Lane assistance (p. 368)

## Activate/deactivate Lane Keeping Aid

The Lane Keeping Aid (LKA) function (LKA<sup>98</sup>) is optional – the driver can choose to activate or deactivate this function.

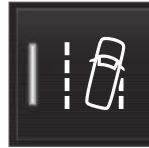

Activate or deactivate the function using this button in the centre display's function view.

- GREEN button indication – the function is activated.
- GREY button indication – the function is deactivated.

### Related information

- Lane assistance (p. 368)
- Select assistance option for lane assistance (p. 370)

## Select assistance option for lane assistance

The driver can select how the Lane Keeping Aid (LKA<sup>99</sup>) should react if the car leaves its lane.

1. Select **Settings** → **My Car** → **IntelliSafe** in the centre display's top view.
2. In the event of **Lane Keeping Aid Mode**, select how the function should react:
  - **Assist** - the driver is given steering assistance without a warning.
  - **Both** – the driver is given a warning both from the steering wheel vibrating and from steering assistance.
  - **Warning** – the driver is only warned by steering wheel vibration.

### Related information

- Lane assistance (p. 368)

<sup>97</sup> Lane Keeping Aid

<sup>98</sup> Lane Keeping Aid

<sup>99</sup> Lane Keeping Aid

## Limitations of Lane assistance

In certain demanding conditions lane assistance (LKA<sup>100</sup>) may have difficulty helping the driver correctly. In such cases it is recommended to switch off this function.

Examples of such conditions are:

- road works
- winter road conditions
- poor road surface
- a very "sporty" driving style
- poor weather with reduced visibility
- roads with unclear or non-existent side markings
- sharp edges or lines other than the lane's side markings
- as the steering servo for speed-dependent steering wheel resistance is working at reduced power – e.g. when cooling due to overheating.

The function is unable to detect barriers, rails or similar obstacles at the side of the carriageway.

### NOTE

This function uses the car's camera and radar units, which have certain general limitations.

## Related information

- Lane assistance (p. 368)
- Speed-dependent steering force (p. 278)
- Limitations for camera and radar unit (p. 330)





---

<sup>100</sup>Lane Keeping Aid

## Symbols and messages for lane assistance

A number of symbols and messages regarding lane assistance (LKA<sup>101</sup>) can be shown on the driver display.

The following table shows some examples.

Symbol	Message	Specification
	<b>Driver support system</b> <b>Reduced functionality Service required</b>	The system does not function as it should. A workshop should be contacted - an authorised Volvo workshop is recommended.
	<b>Windscreen sensor</b> <b>Sensor blocked, see Owner's manual</b>	The ability of the camera to scan the roadway in front of the car is reduced.
	<b>Lane Keeping Aid</b> <b>Apply steering</b>	The LKA steering assistance does not function if the driver does not have his/her hands on the steering wheel. Follow the instruction and steer the car.
	<b>Lane Keeping Aid</b> <b>Standby until steering applied</b>	LKA is set in standby mode until the driver starts to steer the car again.

<sup>101</sup>Lane Keeping Aid

A text message can be cleared by briefly pressing the  button, located in the centre of the steering wheel's right-hand keypad.

If a message remains: Contact a workshop – an authorised Volvo workshop is recommended.

**Related information**

- Lane assistance (p. 368)
- Lane assistance symbols in the driver display (p. 374)

## Lane assistance symbols in the driver display

Lane assistance (LKA<sup>102</sup>) is visualised by symbols in the driver display depending on the situation.



Here are some examples of symbols and the situations in which they are shown:

### Available



Available — the lane lines in the symbol are WHITE.

Lane assistance is scanning one or both lane lines.

### Unavailable



Unavailable — the lane lines in the symbol are GREY.

The Lane assistance cannot detect the lane lines, the speed is too low or the road is too narrow.

### Indication of steering assistance/warning



Steering assistance/warning - the lane lines in the symbol are COLOURED.

Lane assistance indicates that the system is giving a warning and/or attempting to steer the car back into the lane.

### Related information

- Lane assistance (p. 368)

<sup>102</sup>Lane Keeping Aid



## Steering assistance at risk of collision

The function **Collision avoidance assistance** can help the driver reduce the risk of the car leaving its lane unintentionally and/or colliding with another vehicle or obstacle by actively steering the car back into its lane and/or swerving.

The function consists of these subfunctions:

- Steering assistance upon risk of run-off
- Steering assistance upon risk of head-on collision

After automatic engagement, the driver display indicates that this has occurred via a text message:

- **Collision avoidance assistance  
Automatic intervention**

### WARNING

- The function is supplementary driver support intended to facilitate driving and make it safer – it cannot handle all situations in all traffic, weather and road conditions.
- The driver is advised to read all sections in the Owner's Manual that relate to this function to learn about factors such as its limitations and what the driver should be aware of before using the system.
- Driver support functions are not a substitute for the driver's attention and judgement. The driver is always responsible for ensuring the car is driven in a safe manner, at the appropriate speed, with an appropriate distance to other vehicles, and in accordance with current traffic rules and regulations.

### NOTE

It is always the driver who decides how much the car should steer – the car can never take command.

### Related information

- Driving support systems (p. 278)
- Activating/deactivating Steering assistance in the event of a collision risk (p. 376)

- Steering assistance level in the event of a run-off risk (p. 376)
- Limitations for steering assistance at risk of collision (p. 379)
- Symbols and messages for steering assistance upon risk of collision (p. 380)

## Activating/deactivating Steering assistance in the event of a collision risk

The steering assistance function is optional – the driver can choose to activate or deactivate it.

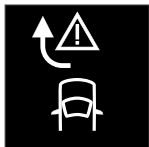

Activate or deactivate the function using this button in the centre display's function view.

- GREEN button indication – the function is activated.
- GREY button indication – the function is deactivated.

This function is activated automatically each time the engine is started<sup>103</sup>.

<b>i</b>	<b>NOTE</b>
<p>When the <b>Collision avoidance assistance</b> function is deactivated, all subfunctions are switched off:</p> <ul style="list-style-type: none"> <li>• Steering assistance at risk of road departure</li> <li>• Steering assistance at risk of oncoming collision</li> </ul> <p>Even though it is possible to deactivate the function, it is advisable for the driver to always have it activated since it improves driving safety in most cases.</p>	

### Related information

- Steering assistance at risk of collision (p. 375)

## Steering assistance level in the event of a run-off risk

The function has two activation levels on intervention:

- Steering assistance only
- Steering assistance with brake intervention

### Steering assistance only

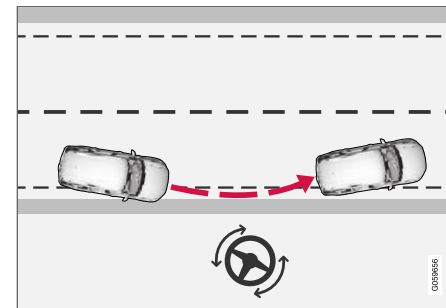

Intervention with steering assistance.

<sup>103</sup>In certain markets, the setting used when the engine is switched off is reactivated.

### Steering assistance with brake intervention

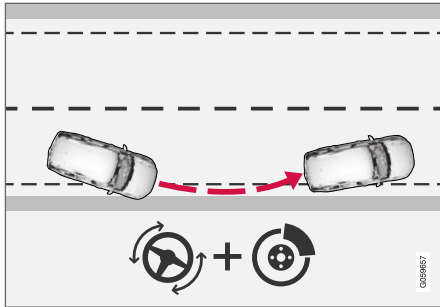

Intervention with steering assistance and braking.

Brake intervention helps in situations where steering assistance alone is not sufficient. The brake force is adapted automatically depending on the situation at the time of road run-off.

### Related information

- Steering assistance at risk of collision (p. 375)

### Steering assistance upon risk of run-off

Steering assistance has a number of subfunctions. Steering assistance in the event of run-off risk can help the driver and reduce the risk of the car accidentally leaving the road by actively steering the car back onto the road.

The function is active within the speed range 65-140 km/h (40-87 mph) on roads with clearly visible lane markings/lines.

A camera scans the edges of the road and the painted side markings. If the car is about to leave the side of the road, the car is steered back onto the road and if the steering intervention is not enough to avoid run-off, the brakes are also activated.

However, the function does **not** intervene with either steering assistance or brake intervention if the direction indicators are used. And if the function detects that the driver is actively driving the car, activation of the function will be delayed.

After automatic engagement, the driver display indicates that this has occurred via a text message:

- **Collision avoidance assistance  
Automatic intervention**

### WARNING

- The function is supplementary driver support intended to facilitate driving and make it safer – it cannot handle all situations in all traffic, weather and road conditions.
- The driver is advised to read all sections in the Owner's Manual that relate to this function to learn about factors such as its limitations and what the driver should be aware of before using the system.
- Driver support functions are not a substitute for the driver's attention and judgement. The driver is always responsible for ensuring the car is driven in a safe manner, at the appropriate speed, with an appropriate distance to other vehicles, and in accordance with current traffic rules and regulations.

### Related information

- Steering assistance at risk of collision (p. 375)

## Steering assistance upon risk of head-on collision

Steering assistance has a number of subfunctions. Steering assistance upon risk of head-on collision can help a distracted driver who does not notice that the car is heading into the opposite lane.

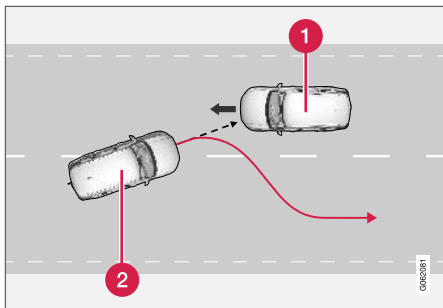

The function can assist by guiding the car back to its own lane.

- 1 Oncoming vehicles
- 2 Your car

At the same time as steering intervention is activated, collision warning for driver support is also activated. However, the brake pulse included in the collision warning will not be activated.

The function is active within the speed range 60-140 km/h (37-87 mph) on roads with clearly visible lane markings/lines.

If the car is about to leave its own lane while an oncoming vehicle is approaching at the same time, the function can help the driver to steer the car back into its own lane.

However, the function does **not** intervene with steering assistance if the direction indicator is used. And if the function detects that the driver is actively driving the car, activation of the function will be delayed.

After automatic engagement, the driver display indicates that this has occurred via a text message:

- **Collision avoidance assistance  
Automatic intervention**

### **WARNING**

- The function is supplementary driver support intended to facilitate driving and make it safer – it cannot handle all situations in all traffic, weather and road conditions.
- The driver is advised to read all sections in the Owner's Manual that relate to this function to learn about factors such as its limitations and what the driver should be aware of before using the system.
- Driver support functions are not a substitute for the driver's attention and judgement. The driver is always responsible for ensuring the car is driven in a safe manner, at the appropriate speed, with an appropriate distance to other vehicles, and in accordance with current traffic rules and regulations.

### Related information

- Steering assistance at risk of collision (p. 375)
- Warning from driver support in the event of a collision risk (p. 316)

## Limitations for steering assistance at risk of collision

In certain situations the function may have limited functionality and fail to intervene in the following cases, for example:

- for small vehicles, such as motorcycles
- if the majority of the car has steered into the adjacent lane
- on roads/in lanes with unclear or non-existent lane markings
- outside the speed range 60-140 km/h (37-87 mph)
- as the steering servo for speed-dependent steering wheel resistance is working at reduced power – e.g. when cooling due to overheating.

Other demanding situations can include:

- road works
- winter road conditions
- narrow roads
- poor road surface
- a very “sporty” driving style
- poor weather with reduced visibility.

In these demanding situations, the function may have difficulty helping the driver correctly. In such cases it is recommended to switch off this function.

### NOTE



This function uses the car's camera and radar units, which have certain general limitations.

### Related information

- Steering assistance at risk of collision (p. 375)
- Steering assistance upon risk of run-off (p. 377)
- Steering assistance upon risk of head-on collision (p. 378)

## Symbols and messages for steering assistance upon risk of collision

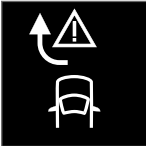
A number of symbols and messages regarding the function can be shown on the driver display. The following table shows some examples.

Symbol	Message	Specification
	<b>Collision avoidance assistance</b> <b>Automatic intervention</b>	When the function is activated, a message is shown to the driver indicating that the system has been activated.
	<b>Windscreen sensor</b> <b>Sensor blocked, see Owner's manual</b>	The ability of the camera to scan the roadway in front of the car is reduced.

A text message can be cleared by briefly pressing the  button, located in the centre of the steering wheel's right-hand keypad.

If a message remains: Contact a workshop – an authorised Volvo workshop is recommended.

### Related information

- Steering assistance at risk of collision (p. 375)

## Park Assist\*

The Park Assist Pilot function can assist the driver when manoeuvring in tight spaces by indicating the distance to obstacles through acoustic signals combined with a graphic in the centre display.



Screen view showing obstacle zones and sensor sectors.

The centre display shows an overview of the relationship between the car and detected obstacles.

The highlighted sector indicates the location of the obstacle. The closer the car symbol is to a highlighted sector box at the front/back, the shorter the distance between the car and detected obstacle.

The side sectors change colour as the distance between the car and an object is reduced.

The shorter the distance to the obstacle, the faster the signal sounds. Other sound from the audio system is muted automatically.

The acoustic signal for obstacles ahead and to the sides is active when the car is moving but stops after the car has been stationary for approx. 2 seconds. The acoustic signal for obstacles behind is also active when the car is stationary.

At a distance within approx. 30 cm (1 ft) from an obstacle behind or in front of the car, the tone is constant and the active sensor's field closest to the car symbol is filled.

At a distance within approx. 25 cm (0.8 ft) from an obstacle To the sides, the tone pulses intensively and the active sector field changes colour from ORANGE to RED.

The volume of the parking assistance signal can be adjusted while the signal is sounding by means of the **[>II]** knob on the centre console. Adjustment can also be performed in the top view's **Settings** menu option.

### **i** NOTE

- Except in the sector nearest to the car symbol, audible warnings are only given for objects directly in the path of the car.

### **!** WARNING

- The parking sensors have blind spots where obstacles cannot be detected.
- Pay particular attention if there are people and animals near the car.
- Bear in mind that the front of the car may swing out towards oncoming traffic during the parking manoeuvre.

### **!** WARNING

- The function is supplementary driver support intended to facilitate driving and make it safer – it cannot handle all situations in all traffic, weather and road conditions.
- The driver is advised to read all sections in the Owner's Manual that relate to this function to learn about factors such as its limitations and what the driver should be aware of before using the system.
- Driver support functions are not a substitute for the driver's attention and judgement. The driver is always responsible for ensuring the car is driven in a safe manner, at the appropriate speed, with an appropriate distance to other vehicles, and in accordance with current traffic rules and regulations.



◀◀ **Related information**

- Driving support systems (p. 278)
- Park Assist Pilot front, rear and along the sides\* (p. 382)
- Activating/deactivating Park Assist Pilot\* (p. 383)
- Symbols and messages for Park Assist Pilot (p. 385)
- Limitations for camera and radar unit (p. 330)

**Park Assist Pilot front, rear and along the sides\***

Park Assist Pilot has different behaviour depending on which part of the car is approaching an obstacle.

**Forwards**

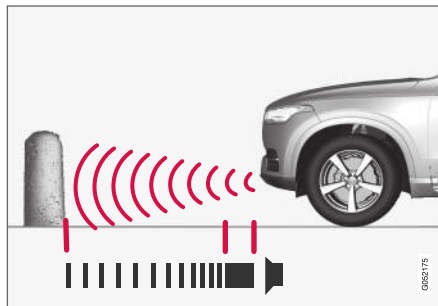

The warning signal has a constant tone at less than approx. 30 cm (1 ft) from an obstacle.

The Parking Assistance System's front detectors are activated automatically when the engine is started. They are active at speeds below 10 km/h (6 mph).

The measuring range is approx. 80 cm (2.5 ft) in front of the car.

**i NOTE**

Parking assistance is deactivated when the parking brake is used or **P** mode is selected in a car with an automatic gearbox.

**! IMPORTANT**

When auxiliary lamps are fitted: Remember that these must not obscure the sensors - the auxiliary lamps may then be perceived as an obstacle.

**Backwards**

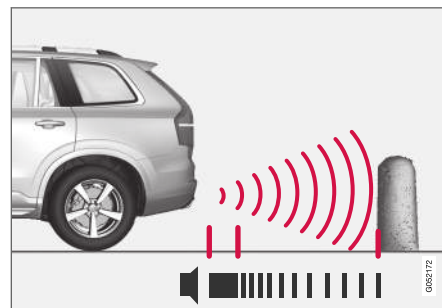

The warning signal has a constant tone at less than approx. 30 cm (1 ft) from an obstacle.

The sensors for reverse are activated if the car rolls backward without a gear engaged or when the gear lever is moved to reverse position.



The measuring range is approx. 1.5 metres (5 ft) behind the car.

When reversing with a trailer connected to the car's electrical system, parking assistance backward is deactivated automatically.

### **i** NOTE

When reversing with e.g. a trailer or bike carrier on the towbar - without Volvo genuine trailer wiring - parking assistance may need to be switched off manually in order that the sensors do not react to them.

### Along the sides

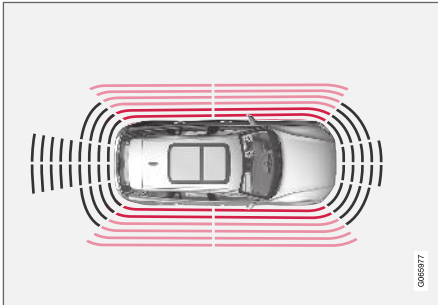

The warning signal pulses intensively at less than approx. 25 cm (0.8 ft) from an obstacle.

Parking assistance side sensors are activated automatically when the engine is started. They are active at speeds below 10 km/h (6 mph).

The measuring range is approx. 25 cm (0.8 ft) from the sides.

However, the detection range of the side sensors increases significantly when the steering angle of the front wheels is increased, and obstacles of up to approx. 90 cm (3 ft) located diagonally behind or in front of the vehicle are detected when the steering wheel is turned.

### Related information

- Park Assist\* (p. 381)
- Sensor fields from Park Assist Pilot for parking camera (p. 391)

### Activating/deactivating Park Assist Pilot\*

The Park Assist Pilot function can be activated/deactivated.

The front and side parking assistance detectors are activated automatically when the engine is started. The rear detectors are activated if the car rolls backwards or when reverse gear is engaged.



Activate or deactivate the function using this button in the centre display's function view.

- GREEN button indication – the function is activated.
- GREY button indication – the function is deactivated.

In cars equipped with a park assist camera\*, Park Assist Pilot can also be activated or deactivated from the relevant camera view.

### Related information

- Park Assist\* (p. 381)

## Limitations of Parking assistance

The Parking Assistance System cannot detect everything in all situations and may therefore have limited functionality in some cases.

A driver should be aware about the following examples of Park Assist Pilot's limitations:

**⚠ WARNING**



Pay additional attention while reversing when this symbol is shown if a trailer, bicycle rack or similar is mounted and electrically connected to the car.

The symbol indicates that the parking assistance sensors rearward are **switched off** and will not warn of any obstacles.

**! IMPORTANT**

Objects e.g. chains, thin glossy poles or low barriers may be in the "signal shadow" and are then temporarily not detected by the sensors - the pulsating tone may then unexpectedly stop instead of changing over to the expected constant tone.

The sensors cannot detect high objects, such as projecting loading docks.

- In such situations, pay extra attention and manoeuvre/reposition the car particularly slowly or stop the current parking manoeuvre - there may be a high risk of damage to vehicles or other objects since information from the sensors is not always reliable in such situations.

**! IMPORTANT**

In certain conditions the parking assistance system may produce incorrect warning signals that are caused by external sound sources with the same ultrasonic frequencies that the system works with.

Examples of such sources include horns, wet tyres on asphalt, pneumatic brakes, exhaust noises from motorcycles, etc.

**i NOTE**

Since a towbar is configured with the car's electrical system, towbar protrusion is included when the function measures the distance to an object behind the car.

### Related information

- Park Assist\* (p. 381)

## Symbols and messages for Park Assist Pilot

Symbols and messages for Park Assist Pilot can be shown in the driver display and/or the centre display.

The following table shows some examples.

Symbol	Message	Specification
		The rearward parking assistance sensors are <b>deactivated</b> , so there are no acoustic warnings for obstacles/objects.
	<b>Park Assist System Sensors blocked, cleaning needed</b>	One or more of the function's sensors are blocked - check and correct as soon as possible.
	<b>Park Assist System Unavailable Service required</b>	The system does not function as it should. A workshop should be contacted - an authorised Volvo workshop is recommended.

A text message can be cleared by briefly pressing the  button, located in the centre of the steering wheel's right-hand keypad.

If a message remains: Contact a workshop – an authorised Volvo workshop is recommended.

### Related information

- Park Assist\* (p. 381)

## Park assist camera\*

The park assist camera can assist the driver when manoeuvring in tight spaces by indicating obstacles with a camera image and graphics in the centre display.

The parking assistance camera is a support function which is activated automatically when reverse gear is selected or manually via the centre display.



Example of camera view.

- 1 **Zoom**<sup>104</sup> - zoom in/out
- 2 **360° view**\* - activates/deactivates all cameras
- 3 **PAS**\* - activates/deactivates the Parking Assistance System
- 4 **Lines** - activates/deactivates park assist lines

- 5 **Towbar**\* - activates/deactivates the towbar park assist line\*<sup>105</sup>
- 6 **CTA**\* - activates/deactivates Cross Traffic Alert

Objects/obstacles may be closer to the car than they appear to be on screen.

### **WARNING**

- The parking sensors have blind spots where obstacles cannot be detected.
- Pay particular attention if there are people and animals near the car.
- Bear in mind that the front of the car may swing out towards oncoming traffic during the parking manoeuvre.

<sup>104</sup>The park assist lines are switched off when zooming in.

<sup>105</sup>Not available on all markets.

**⚠ WARNING**

- The function is supplementary driver support intended to facilitate driving and make it safer – it cannot handle all situations in all traffic, weather and road conditions.
- The driver is advised to read all sections in the Owner's Manual that relate to this function to learn about factors such as its limitations and what the driver should be aware of before using the system.
- Driver support functions are not a substitute for the driver's attention and judgement. The driver is always responsible for ensuring the car is driven in a safe manner, at the appropriate speed, with an appropriate distance to other vehicles, and in accordance with current traffic rules and regulations.

**Related information**

- Driving support systems (p. 278)
- Parking camera views\* (p. 387)
- Park assist lines for parking camera\* (p. 389)
- Sensor fields from Park Assist Pilot for parking camera (p. 391)
- Starting the park assist camera (p. 392)

- Symbols and messages for Park assist camera (p. 393)
- Limitations for camera and radar unit (p. 330)
- Park Assist\* (p. 381)
- Cross Traffic Alert\* (p. 355)

**Parking camera views\***

The function can display a composite 360° view and separate views for each of the four cameras: rear, front, left or right camera view.



◀◀ **360° view\***

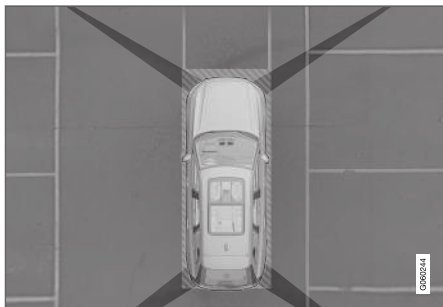

The "field of vision" of the parking cameras with approximate coverage area.

The **360° view** function activates all parking cameras, whereupon the four sides of the car are shown simultaneously in the centre display, which helps the driver to observe what is around the car when manoeuvring at slow speeds.

From the 360° view, each camera view can be activated separately:

- Press the screen for the desired "field of vision" of the camera, e.g. on the surface in front of/above the front camera.



A camera symbol on the centre display's car symbol indicates which of the cameras is active.

If the car is also equipped with **Park Assist System\*** then distance to detected obstacles is illustrated with fields in different colours.

The cameras can be activated automatically or manually.

**Backwards**

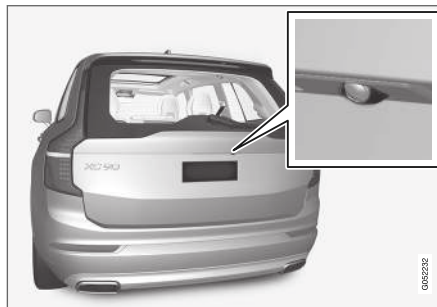

The backwards-facing camera is fitted above the registration plate.

The backward-facing camera shows a wide area behind the car. For certain models, part of the bumper can be seen as well as the towbar in some cases.

Objects shown in the centre display may appear slightly tilted — this is normal.

**Forwards**

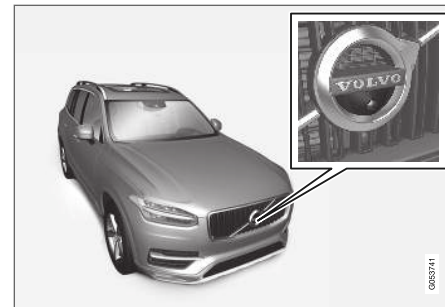

The forwards parking camera is located in the grille.

The front camera can be helpful on an exit road with limited visibility to the sides, e.g. when there are high hedges. It is active at speeds up to 25 km/h (16 mph) - following which, the front camera is switched off.

If the car does not reach 50 km/h (30 mph) and the speed falls below 22 km/h (14 mph) within 1 minute after the forward-facing camera has been extinguished, the camera is reactivated.

## The sides



The side cameras are positioned in each door mirror.

The side cameras can show what is along each side of the car.

## Related information

- Park assist camera\* (p. 386)
- Starting the park assist camera (p. 392)

## Park assist lines for parking camera\*

The Park assist cameras indicate the position of the car in relation to its surroundings by displaying lines on the screen.



Example of park assist lines.

Park assist lines show the intended route for the car's external dimensions with the current steering wheel angle - this facilitates parallel parking,

reversing into tight spaces and when connecting a trailer.

The lines on the screen are projected as if they were at ground level behind the car and respond directly to steering wheel movements, showing the driver the path the car will take - also when the car is turning.

These park assist lines include the car's most protruding parts, e.g. towbar, door mirrors and corners.

### **i** NOTE

- When reversing with a trailer which is not connected electrically to the car, the park assist lines on the display show the route the **car** will take - not the trailer.
- The screen shows no park assist lines when a trailer is connected electrically to the car's electrical system.
- Park assist lines are not shown when zooming in.





**! IMPORTANT**

- Remember, that with the rear camera view selected, the monitor only displays the area behind the car. Be aware of the sides and front of the car when manoeuvring in reverse.
- The same applies vice versa - note what happens to the rear parts of the car when the front camera view is selected.
- Note that the park assist lines show the **shortest** route. Therefore, pay extra attention to the car's sides so that they do not go against/over something when the steering wheel is turned when driving forward or that the front sweeps against/over something when the steering wheel is turned when reversing.

### Park assist lines in 360° view\*

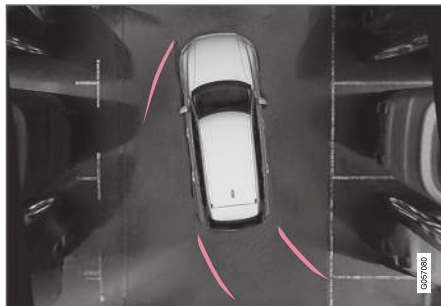

360° view with park assist lines.

With the 360° view, park assist lines are shown behind, in front of and at the side of the car (depending on the direction of travel):

- When driving forwards: Front lines
- When reversing: Side lines and reversing lines.

With front or rear camera selected, the park assist lines appear regardless of the car's direction of travel.

With one side camera selected, the park assist lines only appear when reversing.

### Towbar assist line\*



Towbar with park assist line.

**1 Towbar** - activates the towbar assist line.

**2 Zoom** - zoom in/out.

The camera can facilitate connecting up to a trailer by showing an assist line representing the towbar's intended "path" to the trailer.



1. Press **Towbar** (1).
  - > The park assist lines for the towbar's intended "path" appear - the car's park assist lines disappear simultaneously.
  - Park assist lines for both car and towbar cannot be shown at the same time.
2. Press **Zoom** (2) when a more precise manoeuvring is required.
  - > The camera view zooms in.

### Related information

- Park assist camera\* (p. 386)

## Sensor fields from Park Assist Pilot for parking camera

If the car is equipped with Parking assistance then the distance is shown in the 360° view with coloured fields for each sensor that registers an obstacle.

### Sensor fields backwards and forwards



The screen can show coloured sensor fields on the car symbol.

The fields for the sensors for forwards and reverse change colour as the distance to the obstacle decreases – from AMBER through ORANGE to RED.

Field colour reverse	Distance in metres (feet)
Yellow	0,6-1,5 (2,0-4,9)
Orange	0,3-0,6 (1,0-2,0)
Red	0-0,3 (0-1,0)

Field colour forwards	Distance in metres (feet)
Yellow	0,6-0,8 (2,0-2,6)
Orange	0,3-0,6 (1,0-2,0)
Red	0-0,3 (0-1,0)

For RED sensor fields, the pulsating acoustic signal changes over to a constant tone.

#### ◀ Sensor field to the sides

Warning signals depend on the intended route of the car. When the steering wheel is turned, therefore, there may also be a warning for obstacles diagonally in front of or diagonally behind the car, not just straight ahead or directly behind.

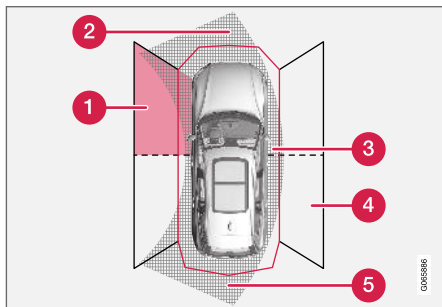

Parking sensor sectors where obstacles can be detected.

- 1 Left-hand side front sensor field
- 2 Obstacle sector in the car's intended route forwards – depending on steering wheel angle
- 3 Sector with RED field colour and intensively pulsing tone
- 4 Right-hand side rear sensor field
- 5 Obstacle sector in the car's intended route in reverse – depending on steering wheel angle.

The colour of the side fields changes with reduced distance to the obstacle – from AMBER to RED.

Colour of side fields	Distance in metres (feet)
Yellow	0,25–0,9 (0,8–3,0)
Red	0–0,25 (0–0,8)

In the case of RED sensor fields, the acoustic signal changes from pulsing to intensively pulsing.

#### Related information

- Park assist camera\* (p. 386)

#### Starting the park assist camera

The park assist camera starts automatically when reverse gear is engaged or manually with one of the centre display's function buttons.

#### Camera view when reversing

When reverse gear is engaged, the screen shows the 360° view if it or any of the side views was the last used camera view, otherwise the rear view is shown.

#### Camera view for manual camera start



Start the parking camera with this button in the centre display's function view.

The screen then initially shows the last used camera view.

However, after each engine start, the previously shown side view is replaced by the 360° view and the previously shown zoomed rear view is replaced by the rear view.

#### Automatic deactivation of camera

The front view extinguishes at 25 km/h (16 mph) to avoid distracting the driver – it reactivates automatically if the speed drops to 22 km/h (14 mph) within 1 minute, on the condition that the speed has not exceeded 50 km/h (31 mph).

Other camera views are extinguished at 15 km/h (9 mph) and not reactivated.

#### Related information



- Park assist camera\* (p. 386)

\* Option/accessory.

## Symbols and messages for Park assist camera

Symbols and messages for Park assist camera can be shown in the driver display and/or the centre display.

The following table shows examples.

Symbol	Message	Specification
		The rearward parking assistance sensors are <b>deactivated</b> , so there are no acoustic warnings and field marks for obstacles/objects.
		The camera is disengaged.
	<b>Park Assist System</b> <b>Sensors blocked, cleaning needed</b>	One or more of the function's sensors are blocked - check and correct as soon as possible.
	<b>Park Assist System</b> <b>Unavailable Service required</b>	The system does not function as it should. A workshop should be contacted - an authorised Volvo workshop is recommended.

A text message can be cleared by briefly pressing the  button, located in the centre of the steering wheel's right-hand keypad.

If a message remains: Contact a workshop – an authorised Volvo workshop is recommended.

### Related information

- Park assist camera\* (p. 386)

## Park Assist Pilot\*

Park Assist Pilot (PAP<sup>106</sup>) can assist the driver to manoeuvre the car while parking. The function can also assist with steering when driving out from parallel parking.



The function first checks if a space is large enough and if so then assists the driver to steer the car into the space.

The centre display indicates with symbols, graphics and text the various operations to be carried out and when to do so.

### WARNING

- The parking sensors have blind spots where obstacles cannot be detected.
- Pay particular attention if there are people and animals near the car.
- Bear in mind that the front of the car may swing out towards oncoming traffic during the parking manoeuvre.

### WARNING

- The function is supplementary driver support intended to facilitate driving and make it safer – it cannot handle all situations in all traffic, weather and road conditions.
- The driver is advised to read all sections in the Owner's Manual that relate to this function to learn about factors such as its limitations and what the driver should be aware of before using the system.
- Driver support functions are not a substitute for the driver's attention and judgement. The driver is always responsible for ensuring the car is driven in a safe manner, at the appropriate speed, with an appropriate distance to other vehicles, and in accordance with current traffic rules and regulations.

### NOTE

The PAP function measures the space and steers the car - the driver's task is to:

- keep a close watch around the car
- follow the instructions in the centre display
- select gear (reverse/forward) - a "ping" sound indicates when the driver should change gear
- control and maintain a safe speed
- brake and stop.

### Related information

- Driving support systems (p. 278)
- Parking variants with Park Assist Pilot\* (p. 395)
- Parking with Park Assist Pilot\* (p. 396)
- Leaving parallel parking with Park Assist Pilot\* (p. 398)
- Limitations of Park Assist Pilot\* (p. 399)
- Limitations for camera and radar unit (p. 330)
- Messages for Park Assist Pilot\* (p. 402)

<sup>106</sup>Park Assist Pilot

## Parking variants with Park Assist Pilot\*

Park Assist Pilot (PAP<sup>107</sup>) can be used for the following different parking situations.

### Parallel parking

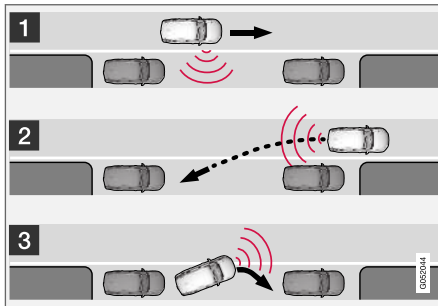

The principal of parallel parking.

The function parks the car using the following steps:

1. A parking space is identified and measured.
2. The car is reversed into the space.
3. The car is positioned in the space by means of driving forward/backward.

With the **Park Out** function, a parallel-parked car can also get help from the function with leaving the parking space.

### Perpendicular parking

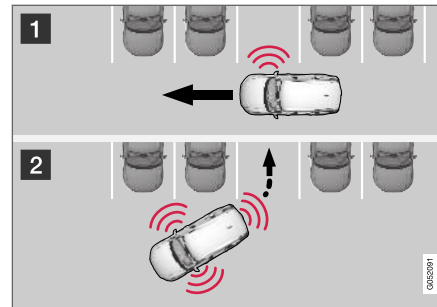

Principle for perpendicular parking.

The function parks the car using the following steps:

1. A parking space is identified and measured.
2. The car is reversed into the space and then positioned in the space by means of driving forward/backward.

#### **i** NOTE

When leaving a parking space, the **Park Out** function must only be used for a parallel-parked car - it does not work for a perpendicular-parked car.

### Related information

- Park Assist Pilot\* (p. 394)
- Leaving parallel parking with Park Assist Pilot\* (p. 398)

<sup>107</sup>Park Assist Pilot

## Parking with Park Assist Pilot\*

Park Assist Pilot (PAP<sup>108</sup>) helps the driver park via three steps. The function can also help the driver to leave a parking space.

This function measures space and steers the car – the driver's job is to:

- keep an eye on what is happening around the car
- follow the instructions in the centre display
- select a gear (reverse/forward) – a "pling" sound indicates when the driver should change gear
- regulate and maintain a safe speed
- brake and stop.

Symbols, graphics and/or text appear on the centre display's screen when the different steps are to be performed.

The function can be activated if the following criteria are met once the engine has been started:

- No trailer is attached to the car
- Speed is lower than 30 km/h (20 mph).

**NOTE**

The distance between the car and parking spaces should be 0.5–1.5 metres (1.6–5.0 ft) while the function is searching for a parking space.

### Parking

The function parks the car using the following steps:

1. A parking space is identified and measured.
2. The car is reversed into the space.
3. The car is positioned into the space - the system may then request that the driver changes gear and brakes.

### Finding and measuring parking spaces



The function can be activated in the centre display's function view.

It can also be accessed from the camera views.

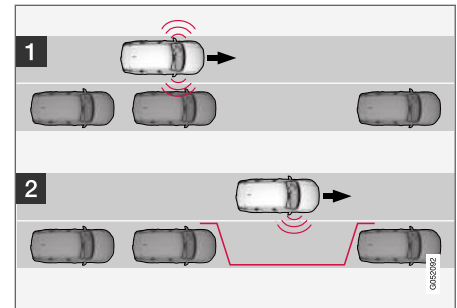

Principle for parallel parking.

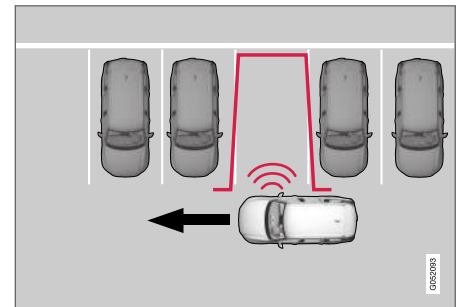

Principle for perpendicular parking.

Drive at a maximum of 30 km/h (20 mph) before parking.

<sup>108</sup>Park Assist Pilot

1. Tap on the **Park In** button in the function view or in the camera view.
  - > PAP searches for a parking space and checks whether it is big enough.
2. Be prepared to stop the car when the graphic and message on the centre display state that a suitable parking space has been found.
  - > A pop-up window is shown.
3. Select **Parallel parking** or **Perpendicular parking** and select reverse gear.

### **i** NOTE

The function searches the area for parking, displays instructions and guides the car in on its passenger side. But if required the car can also be parked on the driver's side of the street:

- Activate the direction indicator to the driver's side - then the system searches for a parking space on that side of the car instead.

### Reversing in to the parking space

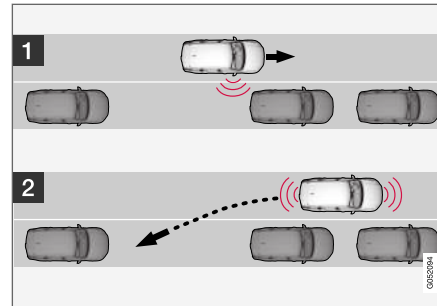

Parallel.

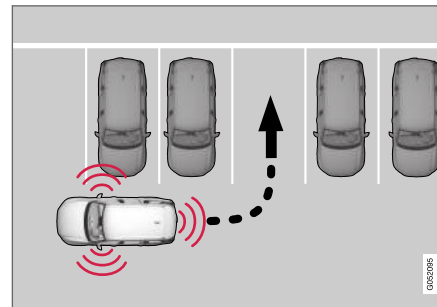

Perpendicular.

Perform the following to reverse the car into the parking space:

1. Check that the area behind the car is clear, then engage reverse gear.
2. Reverse slowly and carefully without touching the steering wheel - and no faster than 7 km/h (4 mph).
3. Be prepared to stop the car when instructed by the graphic and message on the centre display.

### **i** NOTE

- Keep your hands away from the steering wheel when the function is activated.
- Make sure that the steering wheel is not hindered in any way and can rotate freely.
- To achieve optimum results - wait until the steering wheel is fully turned before starting to drive backward/forward.

## Positioning the car in the parking space

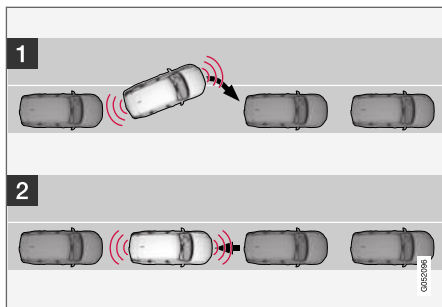

Principles for parallel parking.

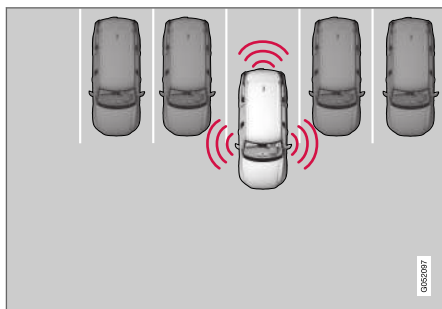

Principles for perpendicular parking.

Proceed as follows:

1. Move the gear selector to the gear position as instructed by the system, wait until the steering wheel has been turned and drive forward slowly.
2. Be prepared to stop the car when instructed by the graphic and message on the centre display.
3. Select reverse gear and drive slowly backwards.
4. Be prepared to brake the car when instructed by the graphic and message on the centre display.

The function is deactivated automatically and the graphics and message show that parking is complete. It may be necessary for the driver to correct the car's position. Only the driver can determine whether the car is properly parked.

### IMPORTANT

The warning distance is shorter when the sensors are used by Park Assist Pilot (PAP<sup>109</sup>) compared with when Park Assist System uses the sensors.

### Related information

- Park Assist Pilot\* (p. 394)

## Leaving parallel parking with Park Assist Pilot\*

The **Park Out** function can help the driver to leave a parking space when the car is parallel parked.

### NOTE

When leaving a parking space, the **Park Out** function must only be used for a parallel-parked car - it does not work for a perpendicular-parked car.



The **Park Out** function is activated in the centre display's function view or in the camera view.

Proceed as follows:

1. Tap on the **Park Out** button in the function view or in the camera view.
2. Use the direction indicator to select the direction in which the car should leave the parking space.
3. Be prepared to stop the car when instructed by the graphic and message on the centre display - follow the instructions in the same way as for the parking procedure.

<sup>109</sup>Park Assist Pilot



Note the steering wheel can "spring" back when the function is completed - the driver may then need to turn the steering wheel back to the maximum steering angle in order to leave the parking space.

If the function considers that the driver can leave the parking space without any extra manoeuvring then the function will be stopped, even if the driver may consider that the car is still in the parking space.

### Related information

- Park Assist Pilot\* (p. 394)

## Limitations of Park Assist Pilot\*

The Park Assist Pilot (PAP<sup>110</sup>) function cannot detect everything in all situations and may therefore have limited functionality.

### WARNING

- The parking sensors have blind spots where obstacles cannot be detected.
- Pay particular attention if there are people and animals near the car.
- Bear in mind that the front of the car may swing out towards oncoming traffic during the parking manoeuvre.

### WARNING

- The function is supplementary driver support intended to facilitate driving and make it safer – it cannot handle all situations in all traffic, weather and road conditions.
- The driver is advised to read all sections in the Owner's Manual that relate to this function to learn about factors such as its limitations and what the driver should be aware of before using the system.
- Driver support functions are not a substitute for the driver's attention and judgement. The driver is always responsible for ensuring the car is driven in a safe manner, at the appropriate speed, with an appropriate distance to other vehicles, and in accordance with current traffic rules and regulations.

### IMPORTANT

Objects situated higher than the sensor detection area are not included when calculating the parking manoeuvre, which could cause the function to swing into the parking space too early – such parking spaces should be avoided for this reason.

- ◀◀ A driver should be aware about the following examples of Park Assist Pilot limitations:

### Parking is discontinued

A parking sequence will be discontinued:

- if the driver moves the steering wheel
- if the car is driven too quickly - above 7 km/h (4 mph)
- if the driver presses **Cancel** in the centre display
- when the anti-lock brakes or the Electronic stability control are engaged - e.g. when a wheel loses grip on a slippery road
- as the steering servo for speed-dependent steering wheel resistance is working at reduced power – e.g. when cooling due to overheating.

Where applicable, a message in the centre display states the reason for a parking sequence being discontinued.

<b>!</b> <b>IMPORTANT</b>
Under certain circumstances, the function is unable to find parking spaces - one reason for this may be the fact that there is interference with the sensors from external sound sources which emit the same ultrasound frequencies as those with which the system works.  Examples of such sources include horns, wet tyres on asphalt, pneumatic brakes and exhaust noises from motorcycles etc.

<b>i</b> <b>NOTE</b>
Dirt, ice and snow covering the sensors will reduce their function and may prevent measurement.

### Driver responsibility

The driver should bear in mind that the function is an aid – not an infallible, fully-automatic function. The driver must therefore be prepared to interrupt a parking step.

There are also a few details to bear in mind while parking, e.g.:

- The driver is always responsible for determining whether the space selected by the function is suitable for parking.
- Do not use the function if snow chains or a spare wheel are fitted.
- Do not use the function if cargo items are protruding from the car.
- Heavy rain or snow may cause the system to measure the parking space incorrectly.
- During the search and check-measurement of the parking space, the function may miss objects positioned deep in the parking space.
- Parking spaces on narrow streets are not always feasible, since the space required for manoeuvring may not be sufficient.
- Use approved tyres<sup>111</sup> with the correct tyre pressure - this affects the ability of the function to park the car.
- The function bases itself on the locations of vehicles already parked nearby – if they are inappropriately parked, your own car's tyres and wheel rims may be damaged by contact with the kerb.

<sup>111</sup>"Approved tyres" refers to tyres of the same type and make as those fitted new on delivery from the factory.

- Perpendicular parking spaces may be missed or offered unnecessarily if one parked car is protruding more than other parked cars.
- The function is designed for parking on straight streets – not sharp curves or bends. For this reason, make sure the car is parallel to the potential parking spaces when the function measures the space.

**! IMPORTANT**

Changing to another approved wheel rim and/or tyre dimension may involve a changed tyre circumference, which means that the system's parameters may then need to be updated. Consult a workshop - an authorised Volvo workshop is recommended.

**Related information**

- Park Assist Pilot\* (p. 394)
- Speed-dependent steering force (p. 278)
- Limitations for camera and radar unit (p. 330)

## Messages for Park Assist Pilot\*

Messages for Park Assist Pilot (PAP<sup>112</sup>) can be shown in the driver display and/or the centre display.

The following table shows examples.

Message	Specification
<b>Park Assist System</b> <b>Sensors blocked, cleaning needed</b>	One or more of the function's sensors are blocked - check and correct as soon as possible.
<b>Park Assist System</b> <b>Unavailable Service required</b>	The system does not function as it should. A workshop should be contacted - an authorised Volvo workshop is recommended.

A text message can be cleared by briefly pressing the  button, located in the centre of the steering wheel's right-hand keypad.

If a message remains: Contact a workshop – an authorised Volvo workshop is recommended.

### Related information

- Park Assist Pilot\* (p. 394)

---

<sup>112</sup>Park Assist Pilot

HYBRID INFORMATION

## General information about Twin Engine

Twin Engine runs like a regular car, but certain functions differ from a car that only runs on petrol or diesel. The electric motor drives the car mostly at low speeds, the petrol engine at higher speeds, as well as during more active driving.

The driver display shows some information that is unique to the Twin Engine - charging information, selected drive mode, distance to empty battery as well as the hybrid battery's charge level.

It is possible to set the car in different drive modes while driving, e.g. electric operation only or, when power is required, both electric motor and petrol engine. The car calculates an optimal combination of drivability, driving experience, environmental impact and fuel economy according to the drive mode selected.

In order that the car should have optimal function it is important that the hybrid battery with associated electrical drive systems, as well as the petrol engine and its drive systems, have the correct operating temperature. Battery capacity may be reduced considerably if the battery is too cold or too hot. Preconditioning prepares the car's drive systems and the passenger compartment before departure so that both wear and energy needs during the journey are reduced. The range for the hybrid battery increases.

The hybrid battery which drives the electric motor is charged via a charging cable but can also be

charged by gentle braking and engine braking in gear position **B**. The hybrid battery can also be charged by the car's engine.

### Important to know

#### Car without power

Bear in mind that important functions such as the brakes and power steering are inoperable when the car is without power.

#### WARNING

In a de-energised car with the electric motor and fuel-driven engine switched off it is not possible to brake the car.

#### Towing not permitted

Towing the Twin Engine is not permitted since this damages the electric motor.

#### Exterior engine noise

#### WARNING

Remember that the car does not emit any engine noise when it is only powered by the electric motor and may therefore be difficult to notice by children, pedestrians, cyclists and animals. This is especially true at low speeds, such as in car parks.

### High-voltage current

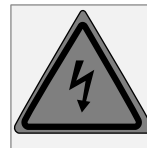

#### WARNING

Several components in the car work with high-voltage current that could be dangerous in the event of incorrect intervention. These components, and all orange-coloured cables, must only be handled by qualified personnel.

Do not touch anything that is not clearly described in the owner's manual.

### Related information

- Charging the hybrid battery (p. 405)
- Hybrid gauge (p. 80)
- Drive modes (p. 447)
- Start and switch off preconditioning (p. 220)
- Hybrid battery (p. 610)
- Factors that affect range when running on electricity (p. 456)
- Gear positions for automatic gearbox (p. 441)
- Towing (p. 477)

## Charging the hybrid battery

In addition to the fuel tank, as in a conventional car, the car is equipped with a rechargeable battery - a so-called hybrid battery of the lithium-ion type.

The hybrid battery is charged using a charging cable which is located in a storage compartment in the cargo area.

### **i** NOTE

Volvo recommends a charging cable in accordance with IEC 62196 and IEC 61851 which supports temperature monitoring.

The time it takes for the hybrid battery to be charged is dependent on the charging current that is used.

### **i** NOTE

The capacity of the hybrid battery decreases slightly with age and use, which may result in increased use of the petrol engine and thereby slightly increased fuel consumption.

### **⚠** WARNING

Replacing the hybrid battery must only be performed by a workshop - an authorised Volvo workshop is recommended.

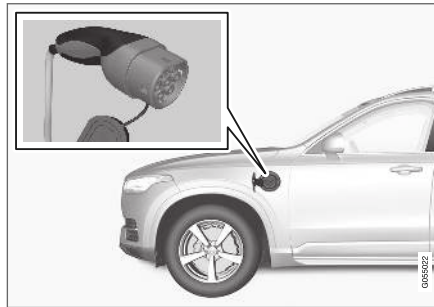

Charging cable handle and charging input socket.

Charging status is indicated in three ways:

- Indicators on the charging cable's control unit.
- Indicator lamp in the car's charging input socket.
- Illustration and text in the driver display.

The starter battery is charged when the hybrid battery is charging and terminated when the hybrid battery is fully charged.

If the hybrid battery's temperature is below  $-10^{\circ}\text{C}$  ( $14^{\circ}\text{F}$ ) or above  $40^{\circ}\text{C}$  ( $104^{\circ}\text{F}$ ) then it may mean that some of the car's functions are changed or unavailable because the capacity of the hybrid batteries is reduced outside this temperature range.

Electric operation is not possible if the temperature of the battery is too low or too high. If drive mode PURE is then selected, the combustion engine starts.

### Charging with fixed control unit in accordance with mode 3<sup>1</sup>

In certain markets the control unit is installed within a charging station connected to the mains power circuit. In which case, the charging cable has no control unit of its own. Instead, it has a special connector that is used to connect the charging cable to the charging station. Follow the instructions at the charging station.

<sup>1</sup> European standard - EN 61851-1.

## ◀ Charging with the petrol engine



The car generates current to the battery and the battery is charged, e.g. when the brake pedal is pressed gently or during engine braking down a hill.

The car can also generate power for the hybrid battery and the battery is charged.

- The hybrid battery is recharged during gentle braking with the brake pedal. The car's kinetic energy is then converted to electrical energy, which is used to charge the hybrid battery.
- In gear position **B**, the car uses electric motor braking when the accelerator pedal is released, while the hybrid battery is recharged at the same time.
- The hybrid battery can also be charged by the car's engine.

## Related information

- Charging cable (p. 407)
- Charging current (p. 406)
- Opening and closing the hatch for the charging input socket (p. 410)
- Start charging the hybrid battery (p. 410)
- Stop charging of hybrid battery (p. 419)
- Charging status in the charging cable's control unit (p. 414)
- Charging status in the car's charging input socket (p. 413)
- Charging status in the car's driver display (p. 417)
- Symbols and messages relating to Twin Engine in the driver display (p. 421)
- Gear positions for automatic gearbox (p. 441)
- Changing drive mode (p. 451)
- Long-term storage of vehicles with hybrid batteries (p. 423)

## Charging current

Charging current is used for charging the hybrid battery as well as preconditioning of the car. Charging takes place with a charging cable connected to the car's charging input socket and a 230 V socket<sup>2</sup> (alternating current).

When the charging cable is activated, the driver display shows a message and a lamp in the car's charging input socket illuminates. The charging current is mainly used for battery charging, but is also used for preconditioning the car. When the car's hybrid battery is charged, the starter battery is also charged.

### ! IMPORTANT

Never unplug the charging cable from the 230 V socket (alternating current) while charging is in progress - there is then a risk of damaging the 230 V socket. Always stop charging first before unplugging the charging cable from the car's charging input socket and then from the 230 V socket.

<sup>2</sup> The voltage in the socket may vary depending on market.



**i NOTE**

- If the weather is very hot or very cold, some of the charging current is used to heat/cool the hybrid battery and the passenger compartment, which results in a longer charging time.
- The charging time is extended if preconditioning has been selected. The time required depends mainly on the outside temperature.

**Fuse**

Normally several 230 V consumers are included in a fuse circuit, so additional consumers (e.g. lighting, vacuum cleaner, electric drill, etc.) can be on the same fuse.

**Related information**

- Charging cable (p. 407)
- Charging status in the car's driver display (p. 417)
- Charging status in the car's charging input socket (p. 413)
- Start and switch off preconditioning (p. 220)
- Stop charging of hybrid battery (p. 419)

**Charging cable**

The charging cable with its control unit is used to charge the car's hybrid battery.

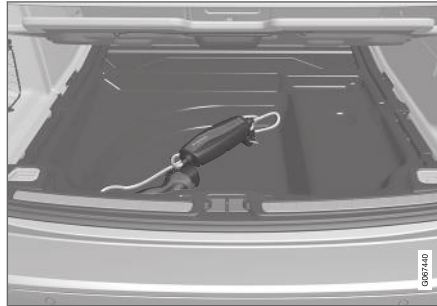

The charging cable is located in the storage compartment under the cargo area's floor hatch.

**⚠ WARNING**

Only use the charging cable provided with your car or a replacement cable recommended by Volvo.

<b>Specifications, charging cable</b>	
Ambient temperature	-32 °C to 50 °C (-25 °F to 122 °F)

**⚠ WARNING**

- The charging cable has a built-in circuit breaker. Charging must only take place with grounded and approved sockets.
- Children should be supervised when in the vicinity of the charging cable when it is plugged in.
- High voltage in the charging cable. Contact with high voltage can cause death or serious personal injury.
- Do not use the charging cable if it is damaged in any way. A damaged or inoperative charging cable must only be repaired by a workshop - an authorised Volvo workshop is recommended.
- Always position the charging cable so that it will not be driven over, stepped on, tripped over or damaged in some other way, or cause personal injury.
- Disconnect the charger from the wall outlet before cleaning it.
- Never connect the charging cable to an extension cord or a multiple plug socket.

Also, refer to the manufacturer's instructions for using the charging cable and its components.



### ! IMPORTANT

Multiple plugs, extension cables, overvoltage protection or similar devices must not be used together with the charging cable since this may involve a risk of fire, electric shocks, etc.

An adapter between the 230 V socket (alternating current) and the charging cable may only be used if the adapter is approved in accordance with IEC 61851 and IEC 62196.

### ! IMPORTANT

Never unplug the charging cable from the 230 V socket (alternating current) while charging is in progress - there is then a risk of damaging the 230 V socket. Always stop charging first before unplugging the charging cable from the car's charging input socket and then from the 230 V socket.

### ! IMPORTANT

Clean the charging cable with a clean cloth, moistened with water or a mild detergent. Do not use chemicals or solvents.

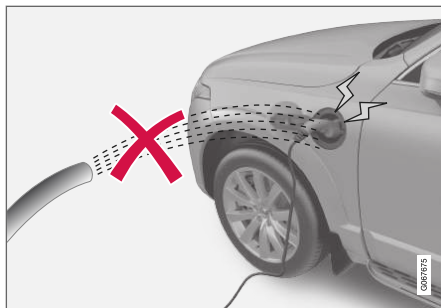

### ! WARNING

The charging cable and its associated parts must not be swamped or immersed in water.

### ! IMPORTANT

Avoid exposing the control unit and its plug to direct sunlight. In such cases, the overheating protection in the plug is at risk of reducing or interrupting the charging of the hybrid battery.

### Related information

- Ground fault breaker in the charging cable (p. 408)
- Temperature monitoring of the charging cable (p. 409)
- Charging the hybrid battery (p. 405)

## Ground fault breaker in the charging cable

The control unit for the charging cable charging cable has a built-in ground fault breaker that protects the car and the user from electric shocks caused by system faults.

### ! WARNING

Charging the hybrid battery must only take place with grounded and approved 230 V sockets (alternating current). If the capacity for the socket or fuse circuit is unknown, ask a licensed electrician to check the capacity. Charging above the capacity of a fuse circuit may lead to fire or damage the fuse circuit.

### ! WARNING

- The charging cable's overvoltage protection helps to protect the car's charging system, but cannot guarantee that overload will never occur.
- Never use visibly worn or damaged electrical sockets. This could cause fire or serious injury.
- Never connect the charging cable to a cable extension.
- Maintenance or replacement of the hybrid battery must only be performed by a trained and qualified Volvo service technician.

**! IMPORTANT**

The ground fault breaker does not protect the 230 V socket (alternating current)/electrical installation.

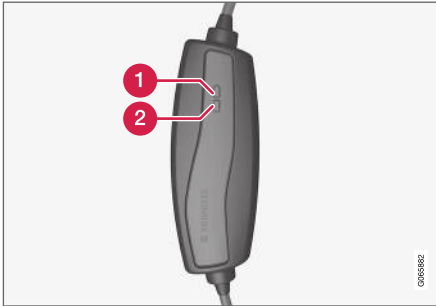

Control unit LED<sup>3</sup> lamps.

- 1** LED lamp 1
- 2** LED lamp 2

If the control module's built-in ground fault breaker is tripped, LED lamp 2 flashes red while LED lamp 1 is extinguished - check the 230 V socket (alternating current).

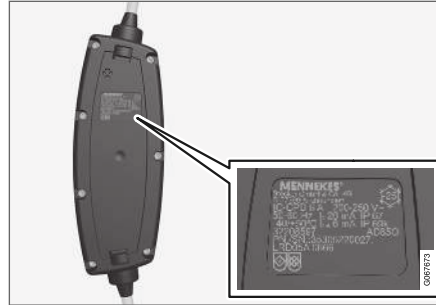
**! IMPORTANT**

- Check the capacity of the socket.
- Other electronic equipment connected to the same fuse circuit must be disconnected if the total load is exceeded.
- Do not connect the charging cable if the socket is damaged.

**Related information**

- Charging cable (p. 407)
- Charging status in the charging cable's control unit (p. 414)

**Temperature monitoring of the charging cable**

For the car's hybrid battery to be charged safely every time, the control unit for the charging cable and the plug have built-in monitoring devices for the temperature.

Temperature monitoring takes place in the control unit and the plug.

**i NOTE**

Volvo recommends a charging cable in accordance with IEC 62196 and IEC 61851 which supports temperature monitoring.

**Monitoring in the control unit**

Charging is switched off if the temperature of the control unit is too high. This is to protect the electronics. This may take place at a high outside temperature, for example, and/or when strong sunlight shines directly on the control unit.

<sup>3</sup> LED (Light Emitting Diode)

#### ◀ Monitoring at the plug

If the temperature at the power source to which the charging cable is connected is too high, the charging current is reduced. If the temperature exceeds a critical level, charging is stopped completely.

#### ! IMPORTANT

If the temperature monitoring has automatically lowered the charging current repeatedly and charging has been interrupted then the cause of the overheating must be investigated and rectified.

#### Related information

- Charging cable (p. 407)

#### Opening and closing the hatch for the charging input socket

The flap for the hybrid battery's charging input socket is opened manually.

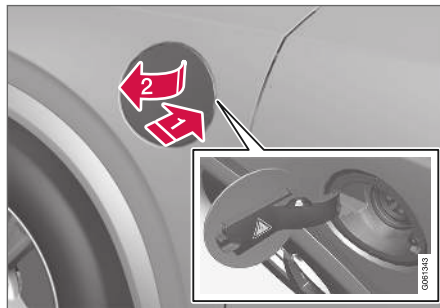

➔ Press in the rear section of the cover and release.

➔ Open the cover.

Close the cover for the charging input socket in reverse order.

#### Related information

- Start charging the hybrid battery (p. 410)
- Stop charging of hybrid battery (p. 419)
- Charging the hybrid battery (p. 405)

#### Start charging the hybrid battery

The car's hybrid battery is charged with a charging cable between the car and a 230 V socket<sup>4</sup> (alternating current).

Only use the charging cable supplied with the car or a replacement cable recommended by Volvo.

#### ! IMPORTANT

Never connect the charging cable when there is a risk of thunderstorm or lightning strike.

#### i NOTE

Volvo recommends a charging cable in accordance with IEC 62196 and IEC 61851 which supports temperature monitoring.

<sup>4</sup> The voltage in the socket may vary depending on market.

**⚠ WARNING**

- The hybrid battery must only be charged at maximum permitted charging current or lower in accordance with applicable local and national recommendations for hybrid charging from 230 V sockets (alternating current)/plugs.
- Charging the hybrid battery must only take place from an approved grounded 230 V socket<sup>5</sup> or from a charging station with a loose charging cable (Mode 3) supplied by Volvo.
- The control unit's ground fault breaker protects the car, but there may still be a risk of overloading the 230 V mains power circuit.
- Avoid visible worn or damaged mains sockets since they may lead to fire damage and/or personal injury if used.
- Never use an extension cable.
- Never use an adapter.

**⚠ WARNING**

- The charging cable has a built-in circuit breaker. Charging must only take place with grounded and approved sockets.
- Children should be supervised when in the vicinity of the charging cable when it is plugged in.
- High voltage in the charging cable. Contact with high voltage can cause death or serious personal injury.
- Do not use the charging cable if it is damaged in any way. A damaged or inoperative charging cable must only be repaired by a workshop - an authorised Volvo workshop is recommended.
- Always position the charging cable so that it will not be driven over, stepped on, tripped over or damaged in some other way, or cause personal injury.
- Disconnect the charger from the wall outlet before cleaning it.
- Never connect the charging cable to an extension cord or a multiple plug socket.

Also, refer to the manufacturer's instructions for using the charging cable and its components.

**ⓘ IMPORTANT**

Check that the 230 V socket (alternating current) has adequate power capacity for charging electric vehicles – in the event of uncertainty, the socket must be checked by a qualified professional.

Take the charging cable out from the storage compartment under the cargo area floor. Note that the car must be switched off prior to charging.

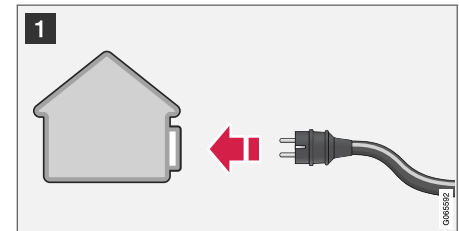

- 1 Connect the charging cable to a 230 V socket. Never use an extension cable.

<sup>5</sup> Or equivalent sockets with a different voltage, depending on market.



**2** Open the charging hatch. Remove the charging handle's protective cover and then press the handle the whole way into the socket for the car.

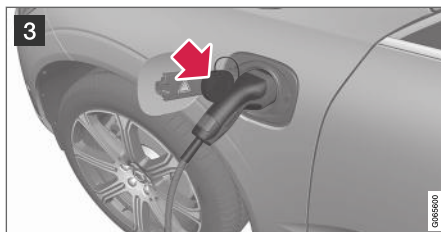

**3** Clamp the charging handle's cover in place as illustrated.

**!** **IMPORTANT**

To avoid damage to the paint, e.g. in the event of high winds, position the charging handle's protective cover so that it does not touch the car.

**3.** The charging cable's charging handle is fastened/locked in, and charging starts within 5 seconds. When charging has started, the LED lamp in the charging input socket flashes with a green glow. The driver display shows the remaining estimated charging time or whether charging is not working as intended.

Battery charging can be interrupted for a while if the car is unlocked:

- and the door is opened - charging restarts within a few minutes.
- without the door being opened - the car is relocked automatically. Charging restarts after 1 minute.

**!** **IMPORTANT**

Never unplug the charging cable from the 230 V socket (alternating current) while charging is in progress - there is then a risk of damaging the 230 V socket. Always stop charging first before unplugging the charging cable from the car's charging input socket and then from the 230 V socket.

Condensation from the air conditioning may drip under the car during charging. This is normal and takes place due to cooling of the hybrid battery.

### Related information

- Charging the hybrid battery (p. 405)
- Opening and closing the hatch for the charging input socket (p. 410)
- Charging status in the car's charging input socket (p. 413)
- Charging status in the car's driver display (p. 417)
- Charging status in the charging cable's control unit (p. 414)
- Stop charging of hybrid battery (p. 419)

### Charging status in the car's charging input socket

The charging input socket shows the charging status using an LED lamp.

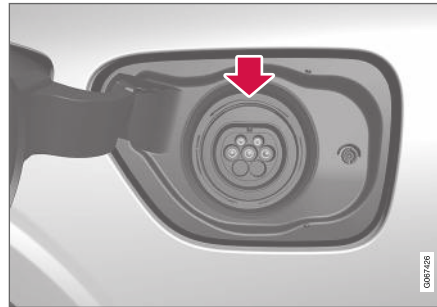

LED lamp location in the car's charging input socket.

The LED lamp shows the existing status while charging is in progress. If the LED lamp does not illuminate, check that the cable is firmly plugged into the wall socket and the socket in the car.

The white, red or yellow lamps are activated when the passenger compartment lighting is switched on - they remain switched on for a while after the passenger compartment lighting has been switched off.

LED lamp's glow	Specification
White	LED light.
Yellow	Waiting mode <sup>A</sup> - waiting for charging to start.
Flashing green	Charging in progress <sup>B</sup> .
Green	Charging complete <sup>C</sup> .
Red	A fault has arisen.

<sup>A</sup> For example, after a door has been opened or if the charging cable's handle is not locked in.

<sup>B</sup> The slower the flashing, the closer to fully charged.

<sup>C</sup> Extinguishes after a while.

### Related information

- Charging the hybrid battery (p. 405)
- Charging status in the car's driver display (p. 417)
- Charging status in the charging cable's control unit (p. 414)
- Stop charging of hybrid battery (p. 419)

### Charging status in the charging cable's control unit

Different indicators on the charging cable's control unit show the status of ongoing charging as well as status after completed charging.



- 1 LED lamp 1
- 2 LED lamp 2

Control unit LED<sup>6</sup> lamps.

---

<sup>6</sup> LED (Light Emitting Diode)



LED 1	LED 2	Status	Specification	Recommended action
Flashes blue, amber and red	Flashes blue, amber and red	Initiation	Self-test.	Wait until the self-test is completed.
Illuminates in blue	Extinguished	Standby	The charging cable is not connected to the car.	Connect the charging cable to the car's charging input socket.
Flashes blue	Extinguished	Standby	Charging is possible but is not activated by the electronics in the car.	Wait until charging starts.
Flashes blue	Flashes blue	Charging in progress.	<ul style="list-style-type: none"> <li>The car's electronics have started charging.</li> <li>Charging in progress.</li> </ul>	Wait until the battery is fully charged.
Extinguished	Flashes amber	Charging in progress.	Temperature monitoring has detected an increased temperature. Charging continues with reduced power level.	Restart charging. If the problem persists - consult a qualified professional.
Extinguished	Illuminates in amber	Charging is not possible.	Temperature monitoring has triggered for the 230 V socket.	Restart charging. If the problem persists - consult a qualified professional.
Extinguished	Flashes red	Charging is not possible.	The ground fault breaker on the charging cable has triggered.	<ol style="list-style-type: none"> <li>Unplug the charging cable from the 230 V socket.</li> <li>The ground fault breaker is reset after 10 seconds and the unit restarts.</li> <li>Plug the charging cable into the 230 V socket.</li> <li>If the problem persists - consult a qualified professional.</li> </ol>
Flashes red	Illuminates in red	Charging is not possible.	Charging cable connected to ungrounded 230 V socket.	Plug the charging cable into a grounded 230 V socket. If the problem persists - consult a qualified professional.





LED 1	LED 2	Status	Specification	Recommended action
Flashes red	Flashes red	Charging is not possible.	Internal fault. The charging cable is damaged and must be repaired.	Contact a qualified professional.



**Related information**

- Charging the hybrid battery (p. 405)
- Charging status in the car's charging input socket (p. 413)
- Charging status in the car's driver display (p. 417)
- Stop charging of hybrid battery (p. 419)

## Charging status in the car's driver display

The driver display shows the status for charging with both image and text. The information is

shown for as long as the driver display is operating.

Image	Message	Specification
	<p><b>Fully charged at: [Time]</b> is shown together with an animation with blue pulsating light through the charging cable.</p>	<p>Charging continues and an approximate time for when the battery is estimated to be fully charged is shown.</p>
	<p>The text <b>Charging complete</b> is shown. An illustration of the car is shown with an LED indicator at the charging input socket that illuminates in green.</p>	<p>The battery is fully charged.</p>
	<p>The text <b>Charging error</b> is shown. The LED indicator at the charging input socket illuminates in red.</p>	<p>A fault has occurred, check the connection of the charging cable to the car's charging input socket and to the 230 V socket<sup>A</sup> (alternating current).</p>

<sup>A</sup> The voltage in the socket may vary depending on market.



**i NOTE**

If the driver display is not used for a while then it is dimmed. Reactivate the display by means of one of the following:

- depress the brake pedal
- open one of the doors
- set the car in ignition position **I** by turning the **START** knob clockwise and releasing.

**Related information**

- Charging the hybrid battery (p. 405)
- Symbols and messages relating to Twin Engine in the driver display (p. 421)
- Charging status in the car's charging input socket (p. 413)
- Charging status in the charging cable's control unit (p. 414)
- Stop charging of hybrid battery (p. 419)

## Stop charging of hybrid battery

Finish charging by unlocking the car, unplugging the charging cable from the car's charging input socket and then from the 230 V socket<sup>7</sup> (alternating current).

### ! IMPORTANT

Before the charging cable is disconnected from the car's charging input socket, the car must be unlocked using the unlock button on the remote control key. This must be carried out even if the doors on the car are already unlocked. If the car is not unlocked using the unlock button, this may lead to damage to the charging cable or to the system.

### i NOTE

Always unlock the car so that charging is stopped before the connection to the 230 V socket (alternating current) is unplugged. Note that the charging cable must be unplugged from the car's charging input socket before being unplugged from the 230 V socket, partly to avoid damage to the system and partly to avoid stopping the charging unintentionally.

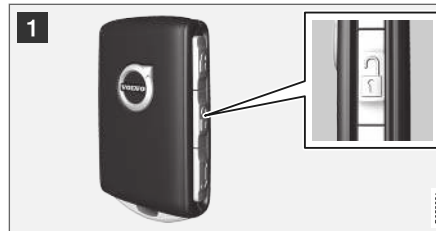

- 1 Unlock the car with the remote control key - charging is finished and the charging cable's locked handle releases/is unlocked.

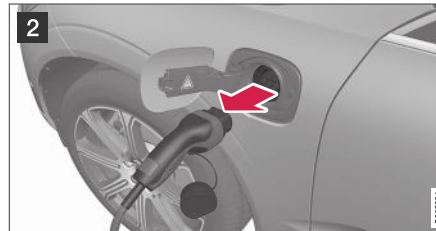

- 2 Unplug the cable from the car's charging input socket and close the hatch.

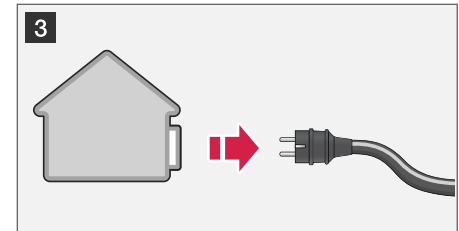

- 3 Unplug the cable from the 230 V socket. Return the charging cable to the storage compartment under the cargo area floor.

## The charging cable is locked automatically

If the charging cable is not unplugged from the charging input socket, it is locked in again automatically shortly after unlocking in order to maximise charging and range, as well as to facilitate preconditioning prior to the journey. The charging cable can be unplugged again if the car is unlocked using the remote control key. For cars with Passive Entry\*, you can lock and unlock using the handle again.

## Related information

- Opening and closing the hatch for the charging input socket (p. 410)
- Charging cable (p. 407)

<sup>7</sup> The voltage in the socket may vary depending on market.







## HYBRID INFORMATION

- ◀◀ • Charging the hybrid battery (p. 405)
- Start charging the hybrid battery (p. 410)



## Symbols and messages relating to Twin Engine in the driver display

A number of symbols and messages regarding Twin Engine can be shown in the driver display.

They may also be shown in combination with general indicator and warning symbols and are then extinguished when the problems have been rectified.

Symbol	Message	Specification
	12 V Battery Charging fault, service urgent. Drive to workshop	Hybrid battery fault. Contact a workshop <sup>A</sup> to check the battery as soon as possible.
	12 V Battery Charging fault Stop safely	Hybrid battery fault. Stop the car safely and contact a workshop <sup>A</sup> to have the battery checked as soon as possible.
	12 V Battery Fuse failure Service required	Hybrid battery fault. Contact a workshop <sup>A</sup> to check the function as soon as possible.
	Hybrid battery Overheated, stop safely	The temperature of the hybrid battery seems to be rising abnormally. Stop the car and switch off the engine. Wait at least 5 minutes before continuing to drive. Call a workshop <sup>A</sup> or check from the outside that everything seems normal before continuing to drive.
	Reduced performance Max car speed limited	The hybrid battery is not sufficiently charged for driving at high speeds. Charge the battery as soon as possible.
	Hybrid system Harsh behaviour at low speed, car ok to use	The hybrid system does not function as intended. Contact a workshop <sup>A</sup> to check the function as soon as possible.



Symbol	Message	Specification
	<b>Hybrid system failure</b> <b>Service required</b>	The hybrid system is disengaged. Contact a workshop <sup>A</sup> to check the function as soon as possible.
	<b>Charge cable</b> <b>Remove before start</b>	Shown when the driver tries to start the car and the charging cable is connected to the car. Disconnect the charging cable and close the charging hatch.
	<b>Charge cable</b> <b>Removed? Turn and hold start knob</b> <b>7s</b>	Shown when the driver starts the car with the charging cable connected to the car after an earlier attempt. Disconnect the charging cable or investigate whether the cable actually is disconnected and that the charging hatch is closed.

<sup>A</sup> An authorised Volvo workshop is recommended.

### Related information

- Start charging the hybrid battery (p. 410)
- Stop charging of hybrid battery (p. 419)
- Charging the hybrid battery (p. 405)
- Warning symbols in the driver display (p. 89)
- Indicator symbols in the driver display (p. 87)
- Hybrid gauge (p. 80)
- Hybrid battery gauge (p. 81)



## Long-term storage of vehicles with hybrid batteries

To minimise hybrid battery degradation during prolonged storage (longer than 1 month) of the vehicle a charge level of approximately 25% is recommended as indicated on the driver display.

Proceed as follows:

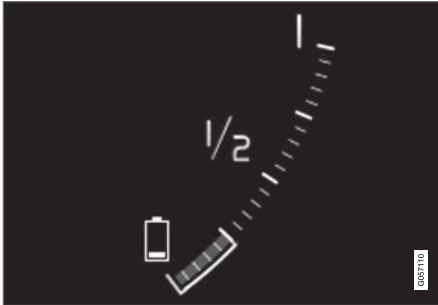

1. If the state of charge is high – run the car until approx. 25% remains. If the state of charge is low – charge the battery until a level of approx. 25% is reached.
2. If storage has lasted longer than 6 months or the hybrid battery charge level is significantly lower than 25% – charge the battery to approx. 25% again to compensate for the natural self-discharge that occurred during the prolonged storage. Continuously check the charge level in the driver display.

### NOTE

Choose the coolest location possible for the vehicle in order to minimise aging of the battery during long-term storage. During summer the vehicle should preferably remain indoors or outdoors in the shade, depending on where the temperature is lowest.

### Related information

- Start charging the hybrid battery (p. 410)
- Hybrid battery gauge (p. 81)
- Charging the hybrid battery (p. 405)



STARTING AND DRIVING

## Starting the car

The car is started using the start knob in the tunnel console when the remote control key is in the passenger compartment.



Start knob in the tunnel console.

### WARNING

Before starting:

- Fasten the seatbelt.
- Adjust the seat, steering wheel and mirrors.
- Make sure that the brake pedal can be fully depressed.

The remote control key is not physically used when starting the car since it is equipped with support for keyless starting (Passive start).

To start the car:

1. The remote control key must be inside the car. For cars with Passive Start, the key needs to be located in the front part of the passenger compartment. With the option for keyless locking/unlocking\* of the car, the key can be anywhere in the car.
2. Hold the brake pedal depressed<sup>1</sup> fully. For cars with automatic gear changing, make sure that gear position **P** or **N** is selected. For cars with a manual gearbox, make sure that the gear lever is in neutral position or that the clutch pedal is depressed.
3. Turn the start knob clockwise and then release it. The control automatically returns to its starting position.

When the engine is started, the starter motor works until the engine is started or until its overheating protection triggers.

When starting in normal conditions, the car's electric drive motor is prioritised - the petrol engine remains switched off. This means that after the start knob has been turned clockwise, the electric motor has "started" and the car is ready to drive. A started car is indicated by the

driver display's indicator lamps extinguishing and its preset theme illuminating.

However, there are situations where the petrol engine is started instead, e.g. in the event of the temperature being too low or if the hybrid battery needs charging.

The car should not be started with the charging cable connected but in the cases when it cannot be unplugged, or the car incorrectly detects the charging cable, it is possible to force start the car:

1. Depress the brake pedal and turn the start knob clockwise.
2. The text **Charge cable Remove before start** appears in the driver display.
3. Turn the start knob clockwise again.
4. The text **Removed? Turn and hold start knob 7s** appears, at which point, turn the knob clockwise and hold it for 7 seconds to start the car.

<sup>1</sup> If the car is moving, the engine can be started by turning the start knob clockwise.

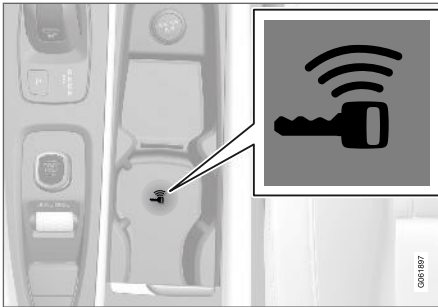

Backup reader's location in the tunnel console.

If the **Car key not found** message is shown in the driver display when starting, place the remote control key by the backup reader. Then try to start the car again.

#### **i** NOTE

When the remote control key is positioned by the backup reader, make sure that there are no car keys, metal objects or electronic apparatus by the backup reader, (e.g. mobile phones, tablets, laptops or chargers). Several car keys close to one another by the backup reader may cause interference with each other.

If the message **Car start System check**, wait is shown in the driver display when starting, wait

until the message disappears and then try to start the car again.

#### **!** IMPORTANT

If the engine fails to start after 3 attempts - wait for 3 minutes before making a further attempt. Starting capacity increases if the battery is allowed to recover.

#### **i** NOTE

The car cannot be started if the hybrid battery is discharged.

#### **!** WARNING

**Never** remove the remote control key from the car while driving.

#### **!** WARNING

Always take the remote control key out from the car when leaving the car and make sure the car's electrical system is in ignition position **0** - especially if there are children in the car.

#### **i** NOTE

The idling speed can be noticeably higher than normal for certain engine types during cold starting. This is done in order that the emissions system can reach normal operating temperature as quickly as possible, which minimises exhaust emissions and protects the environment.

#### Related information

- Switching off the car (p. 428)
- Ignition positions (p. 428)
- Adjusting the steering wheel (p. 193)
- Using jump starting with another battery (p. 467)
- Selecting ignition mode (p. 429)

### Switching off the car

The car is switched off using the start knob in the tunnel console.



Start knob in the tunnel console.

To switch off the car:

- Turn the start knob clockwise and release it - the car is switched off. The control automatically returns to its starting position.

If the gear selector for cars with an automatic gearbox is not in position **P** or if the car rolls:

- Turn the knob clockwise and hold it until the car is switched off.

### Related information

- Starting the car (p. 426)
- Ignition positions (p. 428)
- Adjusting the steering wheel (p. 193)

- Using jump starting with another battery (p. 467)
- Selecting ignition mode (p. 429)

### Ignition positions

The car's electrical system can be set in different levels/positions and in this way make the different functions available.

In order to facilitate the use of a limited number of functions with the engine switched off, the car's electrical system can be set in three different levels - **0**, **I** and **II**. These levels are described with the denomination "ignition position" throughout the owner's manual.

The following table shows the functions available in each ignition position/level:

Level	Functions
0	<ul style="list-style-type: none"> <li>• Odometer, clock and temperature gauge are illuminated<sup>A</sup>.</li> <li>• Power* seats can be adjusted.</li> <li>• The power windows can be used.</li> <li>• The centre display is started and can be used<sup>A</sup>.</li> <li>• The infotainment system can be used<sup>A</sup>.</li> </ul> <p>In this mode, the functions are controlled by time and are switched off automatically after a short while.</p>
I	<ul style="list-style-type: none"> <li>• Panorama roof, power windows, 12V power socket in the passenger compartment, Bluetooth, navigation, phone, ventilation fan and windscreen wipers can be used.</li> <li>• Power seats can be adjusted.</li> <li>• 12 V power sockets* in the cargo area can be used.</li> </ul> <p><b>Power is taken from the battery in this ignition position.</b></p>

Level	Functions
II	<ul style="list-style-type: none"> <li>• The headlamps come on.</li> <li>• Warning/indicator lamps illuminate for 5 seconds.</li> <li>• Several other systems are activated. However, heating in seat cushions and the rear window can only be activated after the car has been started.</li> </ul> <p><b>This ignition position consumes a lot of current from the battery and should therefore be avoided!</b></p>

<sup>A</sup> Also activated when the door is opened.

#### Related information

- Starting the car (p. 426)
- Adjusting the steering wheel (p. 193)
- Using jump starting with another battery (p. 467)
- Selecting ignition mode (p. 429)

## Selecting ignition mode

The car's electrical system can be set in different levels/positions and in this way make the different functions available.

### Selecting ignition position



Start knob in the tunnel console.

- **Ignition position 0** – Unlock the car and store the remote control key inside the car.

#### **i** NOTE

To reach level I or II **without** starting the engine - do **not** depress the brake pedal, or the clutch pedal for cars with manual gear changing, when these ignition positions are to be selected.



- **Ignition position I** – Turn the start knob clockwise and release it. The control automatically returns to its starting position.
- **Ignition position II** – Turn the start knob clockwise and hold it in position for approx. 5 seconds. Then release the knob, which automatically returns to its starting position.
- **Back to ignition position 0** – To return to ignition position **0** from position **I** and **II** – Turn the start knob clockwise and release. The control automatically returns to its starting position.

### Related information

- Starting the car (p. 426)
- Switching off the car (p. 428)
- Ignition positions (p. 428)
- Adjusting the steering wheel (p. 193)
- Using jump starting with another battery (p. 467)

### Alcohol lock\*

The function of the alcohol lock is to prevent the car from being driven by individuals under the influence of alcohol. Before the engine can be started the driver must take a breath test that verifies that he/she is not under the influence of alcohol. Alcohol lock calibration takes place in accordance with each market's limit value in force for driving legally.

The car has an interface for the electrical connection of the different makes and models of alcohol lock recommended by Volvo. The interface facilitates alcohol lock connection, and gives the option of an integrated function including messages related to the alcohol lock in the car's main display. For information about a specific alcohol lock, please refer to the owner's manual from the respective alcohol lock manufacturer.

### WARNING

The alcohol lock is an aid and does not exempt the driver from responsibility. It is always the responsibility of the driver to be sober and to drive the car safely.

### Related information

- Bypass of the alcohol lock\* (p. 430)
- Before starting the engine with the alcohol lock (p. 431)
- Starting the car (p. 426)
- Ignition positions (p. 428)

### Bypass of the alcohol lock\*

In the event of an emergency situation or if the alcohol lock is out of order, it is possible to bypass the alcohol lock in order to drive the car.

For deactivation via the alcohol lock, see the separate instructions for that specific lock.

### Activating the bypass function (Bypass)

#### NOTE

All bypass activation is logged and saved in the memory in the alcohol lock's control unit. It is not possible to undo a bypass.

The message, **Blow into alcolock Bypass instead?**, is shown in the screen:

- If "Cancel/Yes" is shown - select bypass by pressing the right arrow button on the steering wheel's right-hand keypad and then on the **0** button.
- If "Yes" is shown - select bypass by pressing the **0** button.

The alcohol lock is now bypassed and the car can be started.

The number of bypasses possible before service is required is selected during alcohol lock installation.



### Related information

- Alcohol lock\* (p. 430)
- Before starting the engine with the alcohol lock (p. 431)
- Starting the car (p. 426)
- Ignition positions (p. 428)

### Before starting the engine with the alcohol lock

The alcohol lock is activated automatically and is then ready for use when the car is opened.

#### To bear in mind

In order to obtain correct function and as accurate a measurement result as possible:

- Avoid eating or drinking approx. 5 minutes before the breath test.
- Avoid excess windscreen washing - the alcohol in the washer fluid may result in an incorrect measurement result.

#### NOTE

After a completed period of driving, the engine can be restarted within 30 minutes without a new breath test.

### Related information

- Bypass of the alcohol lock\* (p. 430)
- Alcohol lock\* (p. 430)
- Starting the car (p. 426)
- Ignition positions (p. 428)

### Brake functions

The car's brakes are used to reduce the speed or prevent the car from rolling.

Besides the foot brake and parking brake, the car is equipped with several automatic brake assist functions. These can assist the driver by not needing to keep his/her foot on the brake pedal when stationary at a traffic light, or when starting on an uphill gradient.

Depending on the car's equipment, the following auto braking functions are available:

- Automatic brake when stationary (Auto Hold)
- Hill start assist (Hill Start Assist)
- Auto braking after a collision
- City Safety

### Related information

- Foot brake (p. 432)
- Parking brake (p. 434)
- Automatic braking when stationary (p. 438)
- Auto braking after a collision (p. 439)
- Help when starting on a hill (p. 439)
- City Safety™ (p. 335)

## Foot brake

The foot brake is part of the brake system.

The car is equipped with two brake circuits. If a brake circuit is damaged, the brake pedal will engage deeper. Higher pressure on the pedal will therefore be needed to produce the normal braking effect.

### WARNING

The brake servo only works when the electric motor or internal combustion engine is running.

If the foot brake is used when the car is switched off, greater pedal pressure is required to brake the car.

In very hilly terrain or when driving with a heavy load the brakes can be relieved by using engine braking in gearshift mode **B**.

## Anti-lock braking system

The car has anti-lock brakes (ABS<sup>2</sup>), which prevents the wheels from locking while braking and allows maintained steering control. Vibration may be felt in the brake pedal when this is engaged and this is normal.

A short test of the ABS system is made automatically after the car has been started when the driver releases the brake pedal. A further auto-

matic test of the system may be made at low speed. The test may be felt as pulses in the brake pedal.

## Light braking charges the hybrid battery





The electric motor's engine brake is used during light braking. The car's kinetic energy is then converted to electrical energy instead, which is used to charge the hybrid battery. Battery charging with electric motor braking is indicated in the driver display.



The driver display indicates charging during electric motor braking.

This function is active in the speed interval 150-5 km/h (93-3 mph). During heavier braking, as well as outside the speed interval, braking is supplemented by the hydraulic brake system. The driver's display shows this by the indicator being down in the red zone.

## Symbols in the driver display

Symbol	Specification
	Check the brake fluid level. If the level is low, fill with brake fluid and check for the cause of the brake fluid loss.
	Fault in pedal sensor.
	Constant glow for 2 seconds when the engine is started: Automatic function check.  Constant glow for more than 2 seconds: Fault in the ABS system. The car's normal brake system is still working, but without the ABS function.
	If the message <b>Brake pedal Characteristics changed Service required</b> is shown, the system for "Brake-by-wire" is disengaged. A higher pedal pressure is required to produce braking effect.

<sup>2</sup> Anti-lock Braking System

**⚠ WARNING**

If both the warning lamps for brake fault and ABS fault illuminate at the same time, a fault has occurred in the brake system.

- If the level in the brake fluid reservoir is normal at this stage, drive carefully to the nearest workshop and have the brake system checked - an authorised Volvo workshop is recommended.
- If the brake fluid is below the **MIN** level in the brake fluid reservoir, do not drive further before topping up the brake fluid. The reason for the loss of brake fluid must be investigated.

**Related information**

- Brake assistance (p. 433)
- Automatic braking when stationary (p. 438)
- Help when starting on a hill (p. 439)
- Braking on wet roads (p. 433)
- Braking on gritted roads (p. 434)
- Brake system maintenance (p. 434)
- Brake lights (p. 153)

**Brake assistance**

The brake assist system (BAS<sup>3</sup>) helps to increase brake force during braking, and can thereby shorten the braking distance.

The system detects the way in which the driver brakes and increases brake force where necessary. The brake force can be boosted up to the level when the ABS system is engaged. The function is suspended when the pressure on the brake pedal decreases.

**Related information**

- Foot brake (p. 432)

**Braking on wet roads**

When driving for a prolonged period of time in heavy rain without braking, the braking effect may be delayed slightly when next using the brakes.

This may also be the case after a car wash. It is then necessary to depress the brake pedal more forcefully. You should therefore maintain a greater distance to the vehicles in front.

Brake the car firmly after driving on wet roads or using a car wash. This warms up the brake discs, enabling them to dry faster and protecting them against corrosion. Bear in mind the current traffic situation when braking.

**Related information**

- Foot brake (p. 432)
- Braking on gritted roads (p. 434)

<sup>3</sup> Brake Assist System

## Braking on gritted roads

When driving on salted roads, a layer of salt may form on the brake discs and brake linings.

This may extend braking distance. You should therefore maintain a greater safety distance to vehicles in front. In addition, make sure you do the following:

- Brake now and again to remove any layer of salt. Make sure that other road users are not put at risk by the braking.
- Gently depress the brake pedal after finishing driving and before starting your next trip.

### Related information

- Foot brake (p. 432)
- Braking on wet roads (p. 433)

## Brake system maintenance

Check brake system components regularly for wear.

To keep the car as safe and reliable as possible, follow the Volvo service intervals as specified in the Service and Warranty Booklet. New and replaced brake linings and brake discs do not provide optimal braking effect until they have been "worn in" for a few hundred kilometres (miles). Compensate for the reduced braking effect by depressing the brake pedal harder. Volvo recommends only fitting brake linings that are approved for your Volvo.

### **!** IMPORTANT

The wear on the brake system's components must be checked regularly.

Contact a workshop for information about the procedure or engage a workshop to carry out the inspection - an authorised Volvo workshop is recommended.

### Related information

- Foot brake (p. 432)

## Parking brake

The parking brake prevents the car from rolling away from stationary by means of mechanically locking/blocking two wheels.



The control for the parking brake is located in the tunnel console between the seats.

A faint electric motor noise can be heard when the electrically-operated parking brake is being applied. The noise can also be heard during the automatic function checking of the parking brake.

If the car is stationary when the parking brake is activated, it only acts on the rear wheels. If it is activated when the car is moving then the normal foot brake is used, i.e. the brake acts on all four wheels. Brake function changes over to the rear wheels when the car is almost stationary.

### Related information

- Activating and deactivating the parking brake (p. 435)
- Parking on a hill (p. 437)
- In the event of a fault in the parking brake (p. 437)
- Automatic braking when stationary (p. 438)

### Activating and deactivating the parking brake

Use the parking brake to prevent the car from rolling from stationary.

#### Activating the parking brake



1. Pull the control upward.
  - > The symbol in the driver display illuminates when the parking brake is activated.
2. Check that the car is stationary.

#### Symbol in the driver display

Symbol	Specification
	The symbol is illuminated when the parking brake is activated.
	If the symbol flashes, it indicates a fault has occurred. Read the message in the driver display.

### Automatic activation

The parking brake is activated automatically

- when the car is switched off and the setting for automatic activation of the parking brake is activated in the centre display.
- when gear position **P** is selected on a steep hill.
- if the Auto hold (Automatic brake when stationary) function is activated and
  - the car has been stationary for a long time (5-10 minutes)
  - the car is switched off
  - the driver leaves the car.

### Emergency brake

In an emergency, the parking brake can be activated when the car is in motion by pulling up and holding up the control. Braking stops when the control is released, or if the accelerator pedal is depressed.

#### **i** NOTE

An acoustic signal sounds while emergency braking is active at high speeds.

## ◀ Deactivating the parking brake



### Deactivate manually

1. Depress the brake pedal firmly.
2. Press the control down.
  - > The parking brake releases and the symbol in the driver display extinguishes.

### Deactivate automatically

1. Start the car.
2. Depress the brake pedal firmly. Select gear position **D** or **R** and depress the accelerator pedal.
  - > The parking brake releases and the symbol in the driver display extinguishes.

<b>i NOTE</b>
For automatic deactivation, either the driver has to have put on their seatbelt or the driver door has to be closed.

### Related information

- Automatic parking brake activation setting (p. 436)
- In the event of a fault in the parking brake (p. 437)
- Parking brake (p. 434)
- Parking on a hill (p. 437)

## Automatic parking brake activation setting

Choose whether the parking brake is to be activated automatically when the car is switched off.

To change setting:

1. Tap on **Settings** in the centre display's top view.
2. Press **My Car** → **Parking Brake and Suspension** to select or deselect the function **Auto Activate Parking Brake**.

### Related information

- Activating and deactivating the parking brake (p. 435)
- Parking brake (p. 434)

## Parking on a hill

Always use the parking brake when parking on a hill.

### WARNING

Always use the parking brake when parking on an inclined surface. Engaging a gear or the automatic transmission's **P** position is not sufficient to hold the car stationary in all situations.

If the car is parked facing uphill:

- Turn the wheels **away from** the kerb.

If the car is parked facing downhill:

- Turn the wheels **towards** the kerb.

## Heavy load uphill

A heavy load, such as a trailer, can cause the car to roll backward when the parking brake is released automatically on a steep incline. Avoid this by pulling the control upwards while driving the car away. Release the control when the engine achieves traction.

## Related information

- Activating and deactivating the parking brake (p. 435)

## In the event of a fault in the parking brake

Contact an authorised Volvo workshop if it is not possible to deactivate or activate the parking brake after several attempts.

An acoustic warning signal sounds when driving with the parking brake activated.

If the car must be parked before a possible fault is rectified, then the wheels must be turned as for parking on a hill and the gear selector must be in position **P**.



## Low battery voltage

If the battery voltage is too low then the parking brake can be neither deactivated nor activated. Connect a donor battery if the battery voltage is too low.

## Replacing the brake linings

The rear brake linings must be replaced at a workshop due to the design of the electrically-operated parking brake - an authorised Volvo workshop is recommended.

## Symbols in the driver display

Symbol	Specification
	If the symbol flashes, it indicates a fault has occurred. See the message in the driver display.
	Fault in brake system. See the message in the driver display.
	Information message in driver display.

## Related information

- Activating and deactivating the parking brake (p. 435)
- Parking on a hill (p. 437)
- Starter battery (p. 606)
- Volvo service programme (p. 590)

### Automatic braking when stationary

Automatic brake when stationary (Auto hold) means that the driver can release the brake pedal while maintaining braking effect when the car has stopped at traffic lights or a junction.



When the car has stopped, the brakes are activated automatically. The function can use either foot brake or parking brake to hold the car stationary and it works on all gradients. When driving away, the brakes disengage automatically if the driver is wearing the seatbelt.

<b>i NOTE</b>
When braking to a standstill on an uphill or downhill slope, the brake pedal should be depressed a little harder before being released to ensure the car does not roll.

The parking brake is activated if

- the car is switched off
- the driver's door is opened
- the driver's seatbelt is unbuckled
- the car has been stationary for a longer time (5-10 minutes).

### Symbols in the driver display

Symbol	Specification
	The symbol is illuminated when the function uses the foot brake to keep the car stationary.
	The symbol is illuminated when the function uses the parking brake to keep the car stationary.

### Related information

- Activating and deactivating the automatic brake at a standstill (p. 438)
- Foot brake (p. 432)
- Parking brake (p. 434)
- Help when starting on a hill (p. 439)

### Activating and deactivating the automatic brake at a standstill

The automatic brake function at a standstill is activated using the button in the tunnel console.



- Press the button in the tunnel console to activate or deactivate the function.
  - > The indicator in the button illuminates when the function is activated. Activated function remains even when the car is started next time.



### Applicable when switching off



If the function is active and holds the car with the foot brake (A-symbol illuminated) then the brake pedal must be depressed at the same time as the button is depressed in order to deactivate.

- The function remains deactivated until it is reactivated.
- When the function is deactivated, hill start assist (HSA) remains active to prevent the car from rolling backwards when starting on an uphill gradient.

### Related information

- Automatic braking when stationary (p. 438)

### Help when starting on a hill

Hill start assist (HSA<sup>4</sup>) prevents the car from rolling backwards when starting on an uphill gradient. When reversing uphill, it prevents the car from rolling forwards.

The function means that the pedal pressure in the brake system remains for several seconds while the driver's foot is moved from brake pedal to accelerator pedal.

The temporary braking effect releases after several seconds or when the driver starts to drive away.

Hill start assist is available even when the function for automatic brake when stationary (Auto hold) is deactivated.

### Related information

- Automatic braking when stationary (p. 438)
- Foot brake (p. 432)

### Auto braking after a collision

In the event of a collision in which the activation level is reached for the pyrotechnic seatbelt tensioners or airbags, or if a collision with a large animal is detected, the car's brakes are automatically applied. This function is to prevent or reduce the effects of any subsequent collision.

After a serious collision there is a risk that it is no longer possible to control and steer the car. In order to avoid or mitigate a possible further collision with a vehicle or an object in the vehicle's path, the auto braking system is activated automatically and brakes the car in a safe manner.

Brake lights and hazard warning lights are activated during braking. When the car has stopped, the hazard warning lights continue to flash and the parking brake is applied.

If braking is not appropriate, e.g. if there is a risk of being hit by following traffic, the system can be overridden by the driver depressing the accelerator pedal.

The function assumes that the brake system is intact after the collision.

Brake assist is included in the Rear Collision Warning and Blind Spot Information safety systems.

---

<sup>4</sup> Hill Start Assist

◀◀ **Related information**

- Rear Collision Warning (p. 350)
- BLIS\* (p. 351)
- Brake functions (p. 431)

**Gearbox**

The gearbox is part of the car's powertrain (power transmission) between engine and drive wheels. The function of the gearbox is to change the gear ratio depending on speed and power requirements.



The car has an eight-speed automatic gearbox, and an electric motor for rear-wheel drive. The number of gear changes means that the engine's torque and power range can be used effectively. Two of the gears are overdrive gears that save fuel when driving at constant engine speed. Using the steering wheel paddles\* it is possible to shift up or down manually. The driver display shows which gear position is currently in use.

 **IMPORTANT**

To prevent damage to any drive system components, the working temperature of the gearbox is checked. If there is a risk of overheating, a warning symbol illuminates in the driver display and a text message is shown - follow the recommendation given.

**Symbols in the driver display**

If a fault should occur in the gearbox, the driver display shows a symbol and a message.

Symbol	Specification
	Information or error message for gearbox. Follow the recommendation given.
	Hot or overheated gearbox. Follow the recommendation given.
	<b>Reduced performance/Acceleration performance reduced</b> In the event of a temporary powertrain fault, the car can go into a Limp home mode with reduced engine power to prevent damage to the powertrain.

**Related information**

- Gear positions for automatic gearbox (p. 441)
- Gear shift indicator (p. 444)

## Gear positions for automatic gearbox

With an automatic gearbox, the system chooses the gear so that driving is optimal. The gearbox also has a manual gearshift mode.



The driver display shows the gear position selected:

**P, R, N, D or B.**

During manual gear changing, the gear being used is also shown.

### Changing gear

The gear selector is the shift-by-wire-type where shifting is performed electronically instead of mechanically. This means simpler shifting and more distinct gear positions.

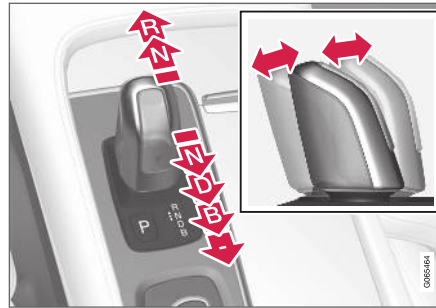

Change gear position by pressing the spring-loaded gear selector forwards or backwards.

### Gear positions

#### Park position - P



The park position is activated via the **P** button next to the gear selector.

Select the **P** position when the car is parked or when starting the engine. The car must be stationary when the park position is selected.

To select another gear position when the park position is selected, the brake pedal must be depressed and the ignition position must be **II**.

To park - first apply the parking brake and then select park position.

### **WARNING**

Always use the parking brake when parking on an inclined surface. Engaging a gear or the automatic transmission's **P** position is not sufficient to hold the car stationary in all situations.

### **NOTE**

The gear selector must be in **P** position to allow the car to be locked and alarmed.

## ◀ Help functions

The system will change to **P** position automatically

- if the car is switched off in position **D** or **R**.
- if the driver unfastens the seatbelt and opens the driver's door when the car is running with the gear selector in a position other than **P**.

To park a car without wearing the seatbelt and with the door open - exit the **P** position by selecting **R** or **D** again.

If the car is switched off in neutral position, there is no automatic change-over to **P** position. This is to allow you to wash the car in the type of car wash that requires the car to be rolled through the facility.

### Reverse position - R

Select position **R** to reverse. The car must be stationary when reverse position is selected.

### Neutral position - N

No gear is engaged and the engine can be started. Apply the parking brake if the car is stationary with the gear selector in **N** position.

To be able to change from the neutral position to another gear position, the brake pedal must be depressed and the ignition position must be **II**.

### Drive position - D

**D** is the normal driving position. Shifting up and down takes place automatically based on the level of acceleration and speed.

The car must be stationary when changing gear from **R** position to **D** position.

### Brake position - B



From **B** position, it is possible to gear down manually to lower gears. The **B** position can be selected at any time during travel. The car brakes using its electric motor when the accelerator pedal is released, while also charging the hybrid battery. This gives more opportunities for recharging the hybrid battery, since charging also takes place without the driver using the brake pedal.

Select brake position by moving the gear selector backwards from the **D** position. The driver display shows which gear is being used.

- Press the gear selector backwards once to change down to the next lower gear.
- Press the gear selector backwards once more to change down further.

To be able to change manually to a higher gear requires that the car is equipped with steering wheel paddles\*.

- Press the gear selector forwards to return to the **D** position.

The gearbox automatically shifts down if the speed decreases to a level lower than appropriate for the selected gear, in order to avoid jerking and stalling.

### Related information

- Gear selector inhibitor (p. 444)
- Changing gear with steering wheel paddles\* (p. 443)
- Kick-down function (p. 444)
- Gear shift indicator (p. 444)

## Changing gear with steering wheel paddles\*

The steering wheel paddles are a complement to the gear selector and make it possible to change gear manually without releasing hands from the steering wheel.



1 "-": Selects the next lower gear.

2 "+": Selects the next higher gear.

### Activating the steering wheel paddles

To be able to change gear with the steering wheel paddles they must first be activated:

- Pull one of the paddles toward the steering wheel.
  - > A figure in the driver display indicates current gear.

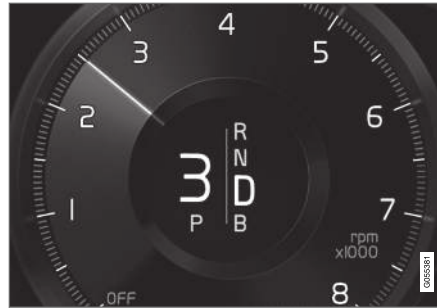

Driver display when changing gear with steering wheel paddles.

### Switch

To change gear one step:

- Pull one of the paddles backwards - towards the steering wheel - and release.

A gear change occurs at each pull of the paddle provided that the engine speed does not leave the permitted range. After each gear change the figure in the driver display changes to show the current gear.

## Deactivating the function

### Manual deactivation in gear position D and B

- Deactivate the steering wheel paddles by pulling the right-hand paddle (+) toward the steering wheel and holding in place until the figure in the driver display for the current gear extinguishes.
  - > The gearbox returns to gear position **D** and **B** depending on the position selected before the paddles were activated.

### Automatic deactivation

In gear position **D** the steering wheel paddles are deactivated after a short time if they are not used. This is indicated by means of the figure for the current gear extinguishing.

In gear position **B** there is no automatic deactivation.

### Related information

- Gear positions for automatic gearbox (p. 441)
- Gear shift indicator (p. 444)

### **Gear selector inhibitor**

The gear selector inhibitor prevents accidental changing between different gear positions in an automatic gearbox.

### **Automatic gear selector inhibitor**

The automatic gear selector inhibitor has special safety systems.

#### **From park position - P**

To select a gear position other than the **P** position, the brake pedal must be depressed and the ignition position must be **II**.

#### **From neutral position - N**

If the gear selector is in the **N** position and the car has been stationary for at least 3 seconds (irrespective of whether the engine is running) then the gear selector is locked.

To be able to move the gear selector from the **N** position to another gear position, the brake pedal must be depressed and the ignition position must be **II**.

### **Message in the driver display**

If the gear selector is inhibited, a message is shown in the driver display, e.g. **Gear lever Press brake pedal to activate gear lever.**

The gear selector is not inhibited mechanically.

### **Related information**

- Gear positions for automatic gearbox (p. 441)

### **Kick-down function**

Kick-down can be used when maximum acceleration is needed, such as for overtaking.

When the accelerator pedal is pressed all the way to the floor (beyond the position normally regarded as full acceleration) a lower gear is immediately engaged. This is known as kick-down.

If the accelerator is released from the kick-down position, the gearbox automatically changes up.

### **Safety function**

To prevent over-revving of the engine, the gearbox control program has a protective downshift inhibitor.

The gearbox does not permit downshifting/kick-down which would result in an engine speed high enough to damage the engine. Nothing happens if the driver still tries to shift down in this way at high engine speed – the original gear remains engaged.

On kick-down the car can shift down one or more steps at a time, depending in engine speed. The car shifts up when the engine has reached its maximum engine speed in order to prevent engine damage.

### **Related information**

- Gear positions for automatic gearbox (p. 441)

### **Gear shift indicator**

The gear shift indicator in the driver display shows the current gear during manual gearshifting and when it is appropriate to engage the next gear for optimum fuel economy.

For eco-driving during manual gear changing, it is important to drive in the right gear and to change gear in good time.



Gear shift indicator in the driver display<sup>5</sup>.

The gear shift indicator is shown in gear position **B**. The gear shift indicator shows the current gear in the driver display and uses an up arrow to indicate when shifting to a higher gear is recommended.

To change up a gear manually, the car has to be fitted with steering wheel paddles\*, the right-hand paddle (+) is then used to change up a gear. If the car is not equipped with steering wheel paddles, pressing the gear selector forwards changes to the position **D**.

### Related information

- Gear positions for automatic gearbox (p. 441)

### All-wheel drive

All-wheel drive (AWD<sup>6</sup>) means that the car is driving all four wheels at the same time, which improves traction.

The electric motor that drives the rear wheels enables electric all-wheel drive functionality. All-wheel drive characteristics vary depending on the selected drive mode.

### Related information

- Drive modes (p. 447)
- Gearbox (p. 440)

### Drive systems

Volvo's Twin Engine combines an internal combustion engine that drives the front wheels with an electric motor that drives the rear wheels.

### Two drive systems

Depending on the driver-selected drive mode and available electric energy, the two drive systems can be used either individually or in parallel.

The electric motor is supplied its energy from a hybrid battery fitted in the tunnel console. The hybrid battery can be charged in a wall socket, or in a special charging station. The internal combustion engine can also charge the hybrid battery with a special high-voltage generator.

Both the internal combustion engine and electric motor can generate motive force directly to the wheels. An advanced control system combines the properties of both drive systems in order to provide optimum driving economy.

<sup>5</sup> The figure is schematic – parts may vary depending on car model.

<sup>6</sup> All Wheel Drive

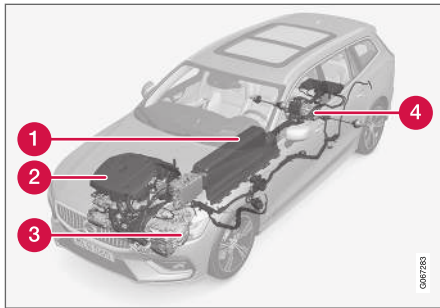

- 1 Hybrid battery - The function of the hybrid battery is to store energy. It receives energy when charging from the mains power circuit, during regenerative braking or from the high-voltage generator. It provides energy for electric operation as well as for temporarily operating the electric air conditioning during the preconditioning of the passenger compartment.
- 2 Internal combustion engine - The internal combustion engine starts when the energy level in the hybrid battery is insufficient for the engine power that the driver requests.
- 3 High voltage generator<sup>7</sup> - Charges the hybrid battery. Starter motor for the internal combustion engine. Can support the internal

combustion engine with extra electrical energy.

- 4 Electric motor - Powers the car in electric operation. If necessary, provides extra torque and power during acceleration. Provides electrical all-wheel drive functionality. Recycles brake energy to electrical energy.

### Related information

- General information about Twin Engine (p. 404)
- Starting and stopping the combustion engine in Twin Engine (p. 446)
- Drive modes (p. 447)
- Gearbox (p. 440)
- Factors that affect range when running on electricity (p. 456)

## Starting and stopping the combustion engine in Twin Engine

An advanced control system determines the extent to which the car is driven on internal combustion engine, electric motor or both in parallel. During electric operation, the car may sometimes need to start the internal combustion engine automatically due to external circumstances, e.g. in low outside temperatures, which is completely normal. In addition, the internal combustion engine always starts when the hybrid battery reaches its lowest state of charge.

### Climate settings at low temperatures

In low outside temperatures, the internal combustion engine sometimes starts automatically in order to achieve the desired passenger compartment temperature and air quality. The amount of time that the internal combustion engine runs can be affected by

- lowering the temperature
- reducing the fan strength
- activating drive mode **Pure**.

### Electric operation in low or high temperatures

In low or high outside temperatures, the car's range and output for electric operation may be reduced and affect how often the internal combustion engine is started automatically.

<sup>7</sup> CISG (Crank Integrated Starter Generator) - Combined high-voltage generator and starter motor.



## Emission control

To ensure optimal operation of the emission control, the internal combustion engine must be run for several minutes once it has been started. The duration of the internal combustion engine's running time varies depending on the temperature of the catalytic converter.

## Related information

- Drive systems (p. 445)
- Economical driving (p. 455)
- Drive modes (p. 447)

## Drive modes

Selection of drive mode affects the car's driving characteristics in order to enhance the driving experience and facilitate driving in special situations.

Using the drive modes it is possible to quickly have access to the car's numerous functions and settings for different driving needs. The following systems are adapted to obtain the best possible driving characteristics in each respective drive mode:

- Steering
- Engine/gearbox/all-wheel drive
- Brakes
- Shock absorption
- Driver display
- Climate settings

Select the drive mode that best suits the current driving conditions. Remember that not all drive modes are available in all situations.

## Selectable drive modes

### **WARNING**

Remember that the car does not emit any engine noise when it is only powered by the electric motor and may therefore be difficult to notice by children, pedestrians, cyclists and animals. This applies in particular at low speeds, such as in car parks.

### **WARNING**

Do not leave the car in an unventilated area with activated drive mode and the fuel-driven engine switched off - automatic engine start occurs at low energy level in the hybrid battery, and the exhaust gases could then cause serious injury to people and animals.

◀ **Hybrid**

- This is the car's normal mode where the electric motor and internal combustion engine work together.

When the car starts, it is in the **Hybrid** mode. The control system uses both the electric motor and internal combustion engine - individually or in parallel - and calculates optimal use with regard to performance, fuel consumption and comfort. The capacity to run solely with the electric motor depends on the hybrid battery's energy level and, for example, the need for heating or cooling in the passenger compartment.

If high power output is available, it is possible to drive with electrical power alone. When the accelerator pedal is depressed, only the electric motor is activated until a certain position is reached. The internal combustion engine starts when this position is exceeded and the energy level in the battery is insufficient for the engine power that the driver requests with the accelerator pedal.

At low energy level (hybrid battery almost empty) the battery's energy level must be maintained, leading to the internal combustion engine starting more often. Charge the hybrid battery from a 230 VAC socket with the charging cable, or activate **Charge** in the function view in order to restore the capacity to run on electricity alone.

The drive mode is designed for low energy consumption with an optimised mix of the electric motor and the internal combustion engine, with-

out compromising the climate comfort and driving experience. When higher acceleration is required, maximum additional power from the electric drive line is used.

The car also senses if the driving conditions require all-wheel drive and automatically engages it if necessary. All-wheel drive and electric additional power are always available regardless of the battery's state of charge.

**Information in the driver display**

When driving in hybrid mode the driver display shows a hybrid gauge. The pointer in the hybrid gauge indicates how much energy the driver requests with the accelerator pedal. The marking between the lightning bolt and the drop shows how much energy is available.



The driver display for propulsion with both the electric motor and internal combustion engine.



The driver display also shows when energy is returned to the battery (regenerated) during light braking.

**Pure**

- Drive the car with electric motor, with energy consumption as low as possible and with lowest possible carbon dioxide emissions.

The drive mode maximises driving on the hybrid battery. This means, for example, that the output of certain climate settings is reduced to provide the longest possible mileage on electric power alone.

The **Pure** mode is available when the hybrid battery has a sufficiently high energy level. The internal combustion engine also starts in the **Pure** mode if the energy level in the battery falls too low. The internal combustion engine also starts

- if the speed exceeds 125 km/h (78 mph)
- if the driver requests more motive force than electric drive can provide
- in the event of system/component limitations, e.g. low outside temperature.

The drive mode is optimised for maximum range with electric propulsion and especially developed for urban traffic. **Pure** means lowest combustion even when the hybrid battery is empty. The climate in the passenger compartment is regulated to Eco climate, and in slippery driving conditions, more wheel spin can be permitted before all-wheel drive is activated automatically.

### ECO climate control

In the **Pure** drive mode, eco climate control is activated automatically in the passenger compartment in order to reduce energy consumption.

#### **i** NOTE

When the **Pure** drive mode is activated, several parameters in the climate control system's settings are changed, and several electricity consumer functions are reduced. Certain settings can be reset manually, but full functionality is only regained by leaving **Pure** drive mode or adapting **Individual** drive mode with full climate functionality.

In the event of difficulties due to misting, press the button for max. defroster which has normal functionality.

### Constant AWD

- Improve the car's roadholding and traction with enhanced all-wheel drive.

The drive mode locks the car in all-wheel drive. An optimal distribution between the front and rear axle torque gives the best traction, stability and roadholding, for example on slippery roads, when driving with a heavy trailer, or when towing. **Constant AWD** drive mode is always available regardless of the battery's state of charge.

Both the internal combustion engine and electric motor are engaged in order to drive all four

wheels, which results in increased fuel consumption.

In the car's other drive modes, the car automatically adapts the need for all-wheel drive to the road surface, and can engage the electric motor or start the internal combustion engine when necessary.

### Power

- The car has sportier characteristics and faster response to accelerating.

The drive mode maximises the combined power from the internal combustion engine and electric motor by means of the car being driven by both front and rear wheels. The gear changes become faster and more distinct, and the gearbox prioritises a gear with greater traction. Steering response is faster and shock absorption is harder.

Both the internal combustion engine and electric motor are engaged in order to drive all four wheels, which results in increased fuel consumption.

The drive mode is optimised for maximum performance and response during acceleration. It changes the internal combustion engine's accelerator pedal response, gear shift pattern and boost pressure system. Chassis settings, steering and brake response are also optimised. **Power** drive mode is always available regardless of the battery's state of charge.

### Individual

- Adapting a drive mode according to individual preferences.

Select a drive mode to start from, and then adjust the settings according to the desired driving characteristics. These settings are saved in an individual driver profile.

An individual drive mode is only available if it is first activated in the centre display.

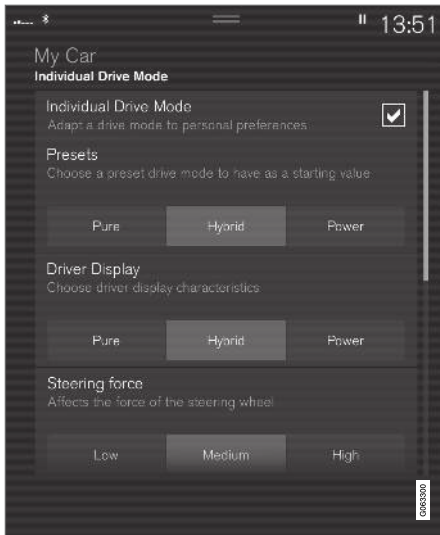

Settings view<sup>8</sup> for individual drive mode.

1. Press **Settings** in the top view.
2. Press **My Car** → **Individual Drive Mode** and select **Individual Drive Mode**.

3. In **Presets**, select a drive mode to start from: **Pure, Hybrid or Power**.

Possible adjustments apply to settings for:

- **Driver Display**
- **Steering Force**
- **Powertrain Characteristics**
- **Brake Characteristics**
- **Suspension Control**
- **ECO Climate**

### Using the electric motor or internal combustion engine

An advanced control system determines the extent to which the car is driven on internal combustion engine, electric motor or both in parallel.

The primary function is to use the engine or motor and the available energy in the hybrid battery as efficiently as possible, with regard to the characteristics of the different drive modes as well as the driver's request for power via the accelerator pedal.

There are also cases where temporary limitations in the system, or functions governed by legal requirements aimed at maintaining a low level of total emissions for the car, may use the internal combustion engine to a greater extent.

### Related information

- Changing drive mode (p. 451)
- Economical driving (p. 455)
- Energy distribution in hybrid drive using map data\* (p. 451)
- Hybrid gauge (p. 80)
- General information about Twin Engine (p. 404)

<sup>8</sup> The figure is schematic - parts may vary depending on car model.

## Changing drive mode

Select the drive mode that best suits the current driving conditions.

Change the drive mode using the control in the centre console.

Remember that not all drive modes are available in all situations.

To change drive mode:



1. Press the drive mode control **DRIVE MODE**.  
> A pop-up menu is opened in the centre display.
2. Roll the wheel upward or downward until the desired drive mode is highlighted.
3. Press the drive mode control or tap directly on the touch screen to confirm the selection.  
> The selected drive mode is indicated in the driver display.

## Related information

- Drive modes (p. 447)

## Energy distribution in hybrid drive using map data\*

The **Hybrid** drive mode is the car's normal mode where the electric motor and internal combustion engine work individually or together in hybrid drive. If a destination has been selected in the navigation system\*, the Predictive Efficiency<sup>9</sup> function distributes the electric energy consumption in an intelligent way along the whole driving distance using the map data.

Fuel consumption can then be reduced compared with normal hybrid drive when the car is first driven on electricity, to then change over to being driven by the internal combustion engine when the hybrid battery has been discharged.

## Function

If the distance to the selected destination is greater than the estimated range when running on electricity, this function distributes the electric energy to optimise consumption for the entire distance to be travelled. This makes it possible to avoid situations where normal hybrid drive would otherwise use a large proportion of the electric energy, for example, to run electric drive at high speed on a motorway and then use the internal combustion engine at low speed in urban driving.



## STARTING AND DRIVING

- ◀◀ The greatest fuel saving is achieved when
  - the distance to be travelled begins with driving on a motorway
  - the distance to be travelled is between 50 and 100 km (30 and 60 miles)
  - the hybrid battery is fully charged at the beginning.

### Conditions for the function

For the function to work requires that a number of conditions are met:

- A destination is set in the navigation system and the driving distance to the destination is longer than the range possible only on electric drive.
- **Hybrid** drive mode is selected.
- The **Hold** and **Charge** functions are deactivated.
- The hybrid battery is charged.

### Tips for use

If the car is used for commuting to work and it is not possible to charge the car at the place of work, specify the place of work as an intermediate destination and your home as the final destination. The discharging of the hybrid battery will then take place over your runs both to and from work.

Add similar commuting routes, i.e. the route between two charging points, as **Favourites** in the navigation system to facilitate arrival.

### Related information

- Drive modes (p. 447)
- Economical driving (p. 455)

---

<sup>9</sup> Certain markets only.

## Level control\* and shock absorption



Level control and shock absorption are regulated automatically in the car.

## Shock absorption (Four-C)

On a car equipped with Four-C the shock absorption is adapted according to the drive mode selected and the speed of the car. Shock absorp-



tion is normally set for the best possible comfort and is regulated continuously depending on the road surface, the car's acceleration, braking and cornering.

## Symbols and messages in driver display

Symbol	Message	Specification
	<b>Suspension</b> Deactivated by user	The active suspension has been switched off manually by the user.
	<b>Suspension</b> Temporarily reduced performance	The active suspension's performance has been temporarily reduced due to extensive system use. If this message appears frequently (e.g. several times in one week) contact a workshop <sup>A</sup> .
	<b>Suspension</b> Service required	A fault has occurred. Visit a workshop <sup>A</sup> as soon as possible.





Symbol	Message	Specification
	<b>Suspension failure</b> <b>Stop safely</b>	A critical fault has occurred. Stop safely, have the car transported (raised with all wheels on the flat-bed) to a workshop <sup>A</sup> .
	<b>Suspension</b> <b>Slow down Car too high</b>	A fault has occurred. If the message appears whilst driving, contact a workshop <sup>A</sup> .

<sup>A</sup> An authorised Volvo workshop is recommended.

### Related information

- Settings for level control\* (p. 455)
- Drive modes (p. 447)



## Settings for level control\*

Switch off the level control when the car is to be jacked up in order to prevent problems with automatic regulation.

## Settings in the centre display

### Disable Leveling Control

In certain cases, the function must be deactivated, e.g. before the car is raised with a jack\*. The difference in level created when lifting with a jack would otherwise mean the automatic control starting to adjust the height, creating an undesired effect.

Deactivating the function via the centre display:

1. Press **Settings** in the top view.
2. Press **My Car** → **Parking Brake and Suspension**.
3. Select **Disable Leveling Control**.

## Related information

- Level control\* and shock absorption (p. 453)
- Recommendations for loading (p. 578)

## Economical driving

Drive economically and in a more eco-friendly way by driving gently and anticipating situations.

Adapt your driving style and speed to the prevailing situation.

To achieve the longest driving distance possible and lowest energy consumption possible with Twin Engine, note the following:

### Charge

- Charge the car regularly from the mains power circuit. Make it a habit to always start a journey with fully-charged hybrid battery.
- Find out where the charging stations are located.
- If possible, select a parking space with a charging station.

### NOTE

Charge the car from the mains power circuit as often as possible!

### Precondition

- Precondition the car before driving if possible using the charging cable connected to the mains power circuit.
- Avoid parking the car in a way that the interior cools down or overheats while parking. Park the car in an acclimated garage, for example.

- During a short drive after preconditioning of the passenger compartment, switch off the ventilation fan or air conditioning in a hot climate, if possible.
- If preconditioning is not possible when it is cold outside, use seat heating and steering wheel heating first of all. Avoid warming up the whole of the interior which takes energy from the hybrid battery.



### ◀ Drive

- For lowest energy consumption, activate the **Pure** drive mode.
- Drive at a steady speed and keep a good distance to other vehicles and objects in order to avoid braking. This driving style results in the lowest energy consumption.
- Balance the power requirement using the accelerator pedal. Use the indicator for available electric motor power in the driver display in order to avoid starting the internal combustion engine unnecessarily. The electric motor is more efficient than the internal combustion engine, in particular at low speed.
- In the event of braking being necessary - brake gently with the brake pedal, this recharges the hybrid battery. A regenerative braking function is built into the brake pedal and can be reinforced with electric motor braking in gear position **B**.
- High speed results in increased energy consumption - the wind resistance increases with speed.
- Activate the **Hold** function in the function view at higher speeds during journeys that are longer than the range of the electricity.
- If possible, avoid using the **Charge** function to charge the hybrid battery. Charging with the internal combustion engine increases fuel consumption and involves increased carbon dioxide emissions.

- In a cold climate, reduce electrical heating of windows, mirrors, seats and steering wheel, if possible.
- Drive with the correct air pressure in the tyres and check this regularly - select ECO tyre pressure for best results.
- Choice of tyres can affect energy consumption - seek advice on suitable tyres from a dealer.
- Remove unnecessary items from the car - the greater the load the higher the consumption.
- A roof load and ski box increase air resistance, leading to higher consumption - remove the load carriers when not in use.
- Avoid driving with open windows.
- Do not hold the car stationary on a hill with the accelerator pedal. Use the foot brake instead.

### Related information

- Drive-E - cleaner driving pleasure (p. 28)
- Energy distribution in hybrid drive using map data\* (p. 451)
- Factors that affect range when running on electricity (p. 456)
- Hybrid gauge (p. 80)
- Checking tyre pressure (p. 548)

### Factors that affect range when running on electricity

The car's range for electric operation depends on several factors. The ability to achieve a long range varies according to the circumstances and conditions under which the car is being driven.

The certified value for the car's mileage on electric power should not be interpreted as an expected range. The certification value is a comparative value obtained by means of special EU drive cycles. The actual range is dependent on a number of factors.

### Factors that affect the range

The driver can influence some factors, but has no influence over others.

The longest range is achieved under extremely favourable conditions when all factors have a positive impact.

### Factors the driver cannot influence

There are several external factors that affect the range in varying degrees:

- traffic situation
- short driving distances
- topography
- outside temperature and headwind
- road condition and surface.

The table shows the approximate relationship between outside temperature and range, both in a car with deactivated passenger compartment climate control, as well as in a car with normal passenger compartment climate control.

A warmer outside temperature has a positive effect on range to a certain extent.

Outside temperature	Deactivated passenger compartment climate control	Normal passenger compartment climate control
30 °C (86 °F)	95 %	80 %
20 °C (68 °F)	100 %	90 %
10 °C (50 °F)	90 %	80 %
0 °C (32 °F)	80 %	60 %
-10 °C (14 °F)	70 %	40 %

### Factors the driver can influence

The driver should be aware that the following factors affect the range so he/she can operate the car in an energy-efficient manner:

- regular charging
- preconditioning
- drive mode **Pure**
- climate settings
- speed and acceleration
- **Hold** function
- tyres and tyre pressure.

The table shows the approximate relationship between constant speed and range, where a lower constant speed has a positive effect on range.

Constant speed	
100 km/h (62 mph)	50 %
80 km/h (50 mph)	70 %
60 km/h (37 mph)	90 %
50 km/h (31 mph)	100 %

### **i** NOTE

- The values shown in the tables relate to a new car.
- These values are not absolute, but are dependent upon driving behaviour, environment and other circumstances.

### Related information

- Economical driving (p. 455)
- Hold and Charge function (p. 458)
- Drive modes (p. 447)

## Hold and Charge function

In some situations, it can be useful to be able to control the hybrid battery's state of charge while driving is in progress. This is possible with the functions **Hold** and **Charge**.

**Hold** and **Charge** are available in all drive modes. The functions are cancelled if **Pure** drive mode is activated.

### Function buttons for Hold and Charge

The functions are activated in the centre display's function view.

#### Hold



**Battery level sustained for later use.**

The function maintains the charge in the hybrid battery for electric drive and saves available electricity for later use, e.g.

for driving in an urban environment or through a residential area.

The car works as for normal hybrid operation with discharged battery where, in addition to re-using brake-generated energy, for example, the car starts the internal combustion engine more often in order to maintain the charge in the battery.

#### Charge



**Engine charges hybrid battery.**

The function charges the hybrid battery with assistance from the internal combustion engine for using increased electric

operation at a later time.

### Symbols in the driver display



The symbol  is shown in the hybrid battery gauge when Hold is activated.

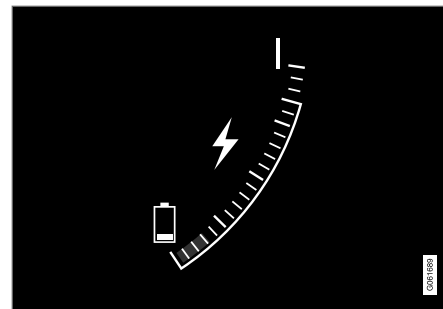

The symbol  is shown in the hybrid battery gauge when Charge is activated.

### Related information

- Economical driving (p. 455)
- Hybrid gauge (p. 80)

## Preparations for a long trip

Before a driving holiday or some other type of long journey, it is important to check the car's functions and equipment particularly carefully.

Check that

- the engine is working normally and that fuel consumption is normal
- there are no leaks (fuel, oil or other fluid)
- brake force during braking is optimal
- all lamps are working - adjust headlamp level if the car is heavily laden
- the tyres have sufficient tread depth and pressure. Change to winter tyres when driving to areas where there is a risk of snowy or icy road surfaces
- starter battery charging is good
- the wiper blades are in good condition
- a warning triangle and high-visibility vest are located in the car - legally required in certain countries

## Related information

- Checking tyre pressure (p. 548)
- Fuel consumption and CO<sub>2</sub> emissions (p. 658)
- Filling washer fluid (p. 641)
- Winter driving (p. 459)
- Economical driving (p. 455)

- Settings for car modem\* (p. 524)
- Recommendations for loading (p. 578)
- Driving with a trailer (p. 472)
- Pilot Assist (p. 307)
- Speed limiter (p. 284)
- Emergency puncture repair kit (p. 563)

## Winter driving

For winter driving it is important to perform certain checks of the car in order to ensure that it can be driven safely.

Check the following in particular before the cold season:

- The engine coolant must contain 50% glycol. This mixture protects the engine against frost down to approx. -35°C (-31°F). To avoid health risks, different types of glycol must not be mixed.
- The fuel tank must be kept filled to prevent condensation.
- Engine oil viscosity is important. Oils with lower viscosity (thinner oils) facilitate starting in cold weather and also reduce fuel consumption while the engine is cold.



### IMPORTANT

Low viscosity oil must not be used for hard driving or in hot weather.

- The condition of the starter battery and charge level must be inspected. Cold weather places great demands on the starter battery and its capacity is reduced by the cold.
- Use washer fluid with antifreeze to avoid ice forming in the washer fluid reservoir.



## ◀ Slippery driving conditions

To achieve optimum roadholding Volvo recommends using winter tyres on all wheels if there is a risk of snow or ice.

### **i** NOTE

The use of winter tyres is a legal requirement in certain countries. Studded tyres are not permitted in all countries.

Practise driving on slippery surfaces under controlled conditions to learn how the car reacts.

### Related information

- Winter tyres (p. 561)
- Snow chains (p. 562)
- Braking on gritted roads (p. 434)
- Braking on wet roads (p. 433)
- Filling washer fluid (p. 641)
- Starter battery (p. 606)
- Replacing windscreen wiper blades (p. 639)
- Replacing the wiper blade, rear window (p. 638)
- Topping up coolant (p. 603)
- Adverse driving conditions for engine oil (p. 654)

## Driving in water

Wading means the car being driven through water, e.g. on a flooded road. Driving in water must be performed with great caution.

Observe the following to prevent damage to the car when driving through water:

- The water level must not be higher than the floor of the car. If possible, check the depth at the deepest point before starting to drive through the water. Extra caution should be exercised when passing through flowing water.
- Do not drive faster than walking pace.
- Do not stop the car in the water. Drive forward carefully or reverse the car back out of the water.
- Remember that waves created by oncoming traffic may rise above the level for the floor of the car.
- Avoid driving through salt water (corrosion risk).

### **i** IMPORTANT

Parts of the car (e.g. engine, gearbox, drive-line or electrical components) may be damaged when driving through water with a level higher than the floor of the car. Damaged caused to a component caused by submersion, hydrolock or lack of oil is not covered by the warranty.

In the event of stalling in water, do not try to restart. Instead, tow the car out of the water and transported on a low loader to a workshop. An authorised Volvo workshop is recommended.

When the water has been passed, depress the brake pedal lightly and check that full brake function is achieved. Water and mud for example can make the brake linings wet resulting in delayed brake function.

If necessary, clean the contact for the trailer coupling after driving in water and mud.

### Related information

- Recovery (p. 479)

## Opening and closing the fuel filler flap

The fuel filler flap is unlocked by pressing a button on the instrument panel.



In the driver display, the arrow next to the tank symbol indicates which side of the car the fuel filler flap is located.



1. Press the button on the instrument panel.
  - > Pressure equalisation of the fuel tank involves a certain delay in opening the flap. The message **Fuel tank Fuel lid is opening** is shown in the driver display, and then **Fuel tank Ready for refuelling**.

### **i** NOTE

After the fuel filler flap has been opened, refuelling must take place within about 15 minutes. After this, the valve that was opened by pressing the button to open the fuel filler cap is closed, and it is no longer possible to refuel because the pump nozzle cuts out.

If the valve is closed before refuelling is complete - press the button again and wait until the driver display shows the message **Fuel tank Ready for refuelling**.

2. After refuelling is finished - close the flap with a gentle press.

### Related information

- Filling fuel (p. 462)

## Filling fuel

The fuel tank is fitted with a coverless fuel filler system.

### Refuelling the car at a petrol station

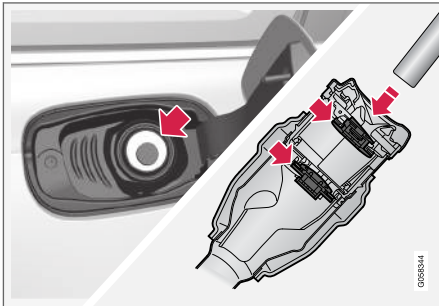

It is important to feed the pump nozzle past the filler pipe's two openable hatches before starting to fuel the car.

Fuelling instruction:

1. Switch off the car and open the fuel filler flap.

#### **i** NOTE

After the fuel filler flap has been opened, refuelling must take place within about 15 minutes. After this, the valve that was opened by pressing the button to open the fuel filler cap is closed, and it is no longer possible to refuel because the pump nozzle cuts out.

If the valve is closed before refuelling is complete - press the button again and wait until the driver display shows the message **Fuel tank Ready for refuelling**.

2.

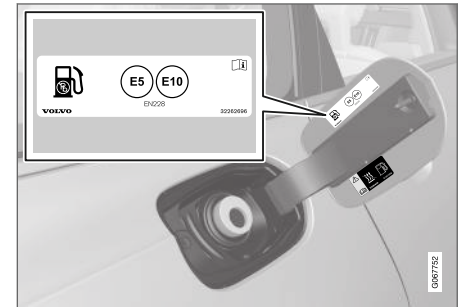

Choose fuel that is approved for use in the car in accordance with the identifier<sup>10</sup> on the inside of the fuel filler flap. See information on approved fuels and identifier in the section on "Petrol".

3. Insert the pump nozzle in the fuel filler opening. The filler pipe has two opening caps. The pump nozzle must be pushed past both caps before refuelling is started.

<sup>10</sup> The identifier in accordance with the CEN standard EN16942 is located on the inside of the fuel filler flap, and will be on corresponding fuel pumps and their nozzles at filling stations throughout Europe by 12 October 2018 at the latest.



4. Do not overfill the tank but fill until the pump nozzle cuts out the first time.
  - > The tank is full.

### **i NOTE**

Overfilled fuel in the tank can overflow in hot weather.

### **Topping up fuel from a fuel can**

When filling with a fuel can, use the funnel located in the foam block under the floor hatch in the cargo area.

1. Open the fuel filler flap.
2. Insert the funnel in the fuel filler opening. The filler pipe has two opening caps. The funnel's pipe must be pushed past both caps before filling can be started.

### **Applicable to cars with fuel-driven auxiliary heater\***

Never use the fuel-driven heater when the car is in a filling station area.

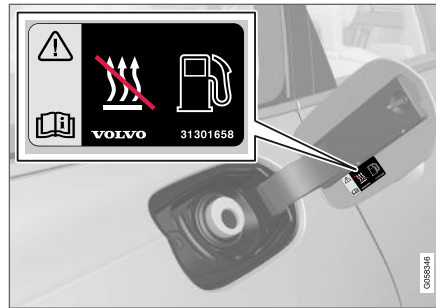

Decal on the inside of the fuel filler flap.

### **Related information**

- Opening and closing the fuel filler flap (p. 461)
- Petrol (p. 464)

## **Handling of fuel**

Do not use fuel with a lower quality than that recommended by Volvo, as this will negatively affect engine power and fuel consumption.

### **⚠ WARNING**

Always avoid inhaling fuel vapour and getting fuel splashes in the eyes.

In the event of fuel in the eyes, remove any contact lenses and rinse the eyes in plenty of water for at least 15 minutes and seek medical attention.

Never swallow fuel. Fuels such as petrol, bioethanol and mixtures of them and diesel are highly toxic and could cause permanent injury or be fatal if swallowed. Seek medical attention immediately if fuel has been swallowed.

### **⚠ WARNING**

Fuel which spills onto the ground can be ignited.

Switch off the fuel-driven heater before starting to refuel.

Never carry an activated mobile phone when refuelling. The ring signal could cause spark build-up and ignite petrol fumes, leading to fire and injury.





**! IMPORTANT**

Mixtures of various fuel types or use of fuels which are not recommended will invalidate Volvo's guarantees and any supplementary service agreements; this is applicable to all engines.

**Related information**

- Petrol (p. 464)

**Petrol**

Petrol is a type of engine fuel that is intended for cars with a petrol engine.

Only use petrol from well-known producers. Never use fuel of dubious quality. The petrol must fulfil the EN 228 standard.

**Identifier for petrol**

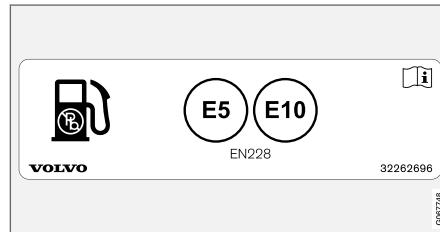

Decal on the inside of the fuel filler flap.

The identifier in accordance with the CEN standard EN16942 is located on the inside of the fuel filler flap, and will be on corresponding fuel pumps and their nozzles at filling stations throughout Europe by 12 October 2018 at the latest.

These are the identifiers that apply for current standard fuels in Europe. Petrol with the following identifiers may be used in cars with petrol engine:

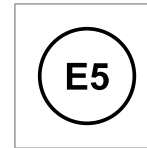

E5 is a petrol with maximum 2.7% oxygen and maximum 5 volume % ethanol.

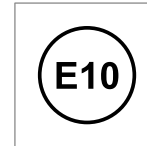

E10 is a petrol with maximum 3.7% oxygen and maximum 10 volume % ethanol.

**! IMPORTANT**

- Fuel that contains up to 10 percent by volume ethanol is permitted.
- EN 228 E10 petrol (max 10 percent by volume ethanol) is approved for use.
- Ethanol higher than E10 (max. 10 percent by volume ethanol) is not permitted, e.g. E85 is not permitted.

**Octane rating**

- RON 95 can be used for normal driving.
- RON 98 is recommended for optimum performance and minimum fuel consumption.
- An octane rating lower than RON 95 must not be used.

When driving in temperatures above +38 °C (100 °F), fuel with the highest octane rating is recommended for optimum performance and fuel economy.

### **!** IMPORTANT

- Use only unleaded petrol to avoid damaging the catalytic converter.
- Fuel containing metallic additives must not be used.
- Do not use any additives which have not been recommended by Volvo.

#### **Related information**

- Handling of fuel (p. 463)
- Filling fuel (p. 462)
- Petrol particle filter (p. 465)
- Fuel consumption and CO<sub>2</sub> emissions (p. 658)

### **Petrol particle filter**

**Petrol cars are fitted with particle filters for more efficient emission control.**

Particles in the exhaust gases are collected in the petrol particle filter during normal driving. In normal driving conditions, passive regeneration takes place, which leads to the particles being oxidised and burned away. The filter is emptied in this way.

If the car is driven at low speed or with repeated cold starts in low outside temperature, active regeneration may be necessary. Regeneration of the particulate filter is automatic and normally takes 10-20 minutes. There may be a smell of burning during regeneration.

Use the parking heater in cold weather - the engine then reaches normal operating temperature more quickly.

#### **When driving short distances at low speeds in a petrol car**

The capacity of the emissions system is affected by how the car is driven. It is important to drive varying distances at different speeds to achieve optimal performance.

Driving short distances at low speeds (or in cold climates) frequently, where the engine does not reach normal operating temperature, can lead to problems that can eventually cause a malfunction and trigger a warning message. If the vehicle is mostly driven in city traffic, it is important to regu-

larly drive at higher speeds to allow the emissions system to regenerate.

- The car should be driven on A-roads at speeds in excess of 60 km/h (38 mph) for at least 20 minutes between each refuelling.

#### **Related information**

- Petrol (p. 464)

## Overheating in the engine and drive system

Under certain conditions, e.g. hard driving in hilly terrain and hot climate, there is a risk that the engine and drive system may overheat – in particular with a heavy load.

- In the event of overheating, the engine's power may be limited temporarily.
- Remove any auxiliary lamps from in front of the grille when driving in hot climates.
- If the temperature in the engine's cooling system becomes too high then a warning symbol is illuminated and the driver display shows the message **Engine temperature High temperature Stop safely**. Stop the car in a safe way and allow the engine to run at idling speed for several minutes and cool down.
- If the message **Engine temperature High temperature Turn off engine** or **Engine coolant Level low, turn off engine** is shown, stop the car and switch off the engine.
- In the event of overheating in the gearbox, an alternative gear shift program will be selected. In addition, a built-in protection function is activated that, amongst other things, illuminates a warning symbol and the driver display shows the message **Transmission warm Reduce speed to lower temperature** or **Transmission hot**

**Stop safely, wait for cooling.** Follow the recommendation given, reduce speed or stop the car in a safe way and allow the engine to run at idling speed for several minutes to enable the gearbox to cool down.



- If the car overheats, the air conditioning may be switched off temporarily.
- Do not turn the engine off immediately you stop after a hard drive.

 <b>NOTE</b>
It is normal for the engine's cooling fan to operate for a time after the engine has been switched off.

## Related information

- Topping up coolant (p. 603)
- Driving with a trailer (p. 472)
- Preparations for a long trip (p. 459)
- Gear shift indicator (p. 444)

## Symbols in the driver display

Symbol	Specification
	High engine temperature. Follow the recommendation given.
	Low level, coolant. Follow the recommendation given.
	Gearbox hot/overheated/cooled. Follow the recommendation given.

## Overloading the starter battery

The electrical functions in the car load the starter battery to varying degrees. Avoid using the ignition position II when the car is switched off. Instead, use ignition position I - which uses less power.

Also, be aware of different accessories that load the electrical system. Do not use functions which use a lot of power when the car is switched off. Examples of such functions are:

- ventilation fan
- headlamps
- windscreen wiper
- audio system (high volume).

If the starter battery voltage is low, a message is shown in the driver display. The energy-saving function then shuts down certain functions or reduces certain functions such as the ventilation fan and/or audio system.

- In which case, charge the starter battery by starting the car and then running it for at least 15 minutes - starter battery charging is more effective during driving than running the engine at idling speed while stationary.

## Related information

- Starter battery (p. 606)
- Ignition positions (p. 428)

## Using jump starting with another battery

If the starter battery is discharged then the car can be started with current from another battery.

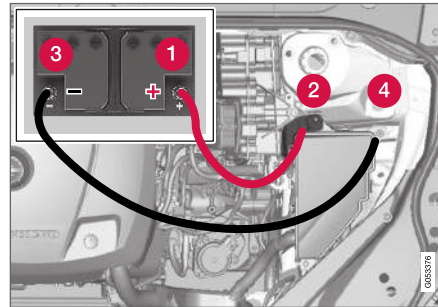

Charging point for jump-starting own car.

### ! IMPORTANT

The car's charging point is only intended for jump-starting the car itself. The charging point is not intended for jump-starting another car. Using the charging point to jump start another car may cause a fuse to blow, which means the charging point will stop working.

When a fuse has blown the message **12 V Battery Fuse failure Service required** is shown in the driver display. Volvo recommends that an authorised Volvo workshop is contacted.

When jump-starting the car, the following steps are recommended to avoid short circuits or other damage:

## STARTING AND DRIVING

1. Set the car's electrical system in ignition position **0**.
2. Check that the donor battery has a voltage of 12 V.
3. If the donor battery is installed in another car - switch off the donor car's engine and make sure that the two cars do not touch each other.
4. Connect one of the red jump lead's clamps to the donor battery's positive terminal (1).

### **IMPORTANT**

Connect the start cable carefully to avoid short circuits with other components in the engine compartment.

5. Open the positive jump-starting point's cover (2).
6. Connect the red jump lead's other clamp onto the car's positive jump-starting point (2).
7. Connect one of the black jump lead's clamps to the donor battery's negative terminal (3).
8. Connect the black jump lead's other clamp onto the car's negative jump-starting point (4).

9. Check that the jump lead clamps are affixed securely so that there are no sparks during the starting attempt.
10. Start the engine of the "donor car" and allow it to run a few minutes at a speed slightly higher than idle approx. 1500 rpm.
11. Start your own car's engine. If the start attempt fails then extend the charging time to 10 minutes, and then make a new start attempt.

### **NOTE**

When starting the engine in normal conditions the car's electric drive motor is prioritised - the petrol engine remains switched off. This means that after the start knob has been turned clockwise, the electric motor has "started" and the car is ready to move. A started motor is indicated by the driver display's indicator lamps extinguishing and its preset theme illuminating.

### **IMPORTANT**

Do not touch the connections between cable and car during the starting attempt. There is a risk of sparks forming.

12. Remove the jump leads in reverse order - first the black and then the red.

Make sure that none of the black jump lead's clamps comes into contact with the car's positive jump-starting point/donor battery's positive terminal or the clamp connected to the red jump lead.

### **WARNING**

- The battery can generate oxyhydrogen gas, which is highly explosive. A spark can be formed if a jump lead is connected incorrectly, and this can be enough for the battery to explode.
- Do not connect the jump leads to any fuel system component or any moving part. Be careful of hot engine parts.
- The battery contains sulphuric acid, which can cause serious burns.
- If sulphuric acid comes into contact with eyes, skin or clothing, flush with large quantities of water. If acid splashes into the eyes - seek medical attention immediately.
- Never smoke near the battery.

### **NOTE**

The car cannot be started if the hybrid battery is discharged.

**i NOTE**

If the starter battery has been discharged so much that the car has no normal electrical functions and the engine is then jump-started with an external battery or a battery charger, the Start/stop function may continue to be activated. If the Start/stop function then auto-stops the engine shortly afterwards, there is a great risk that engine auto-start will fail due to insufficient battery capacity, because the battery has not had the time to recharge.

If the car has been jump-started, or if there is insufficient time to charge the battery with a battery charger, the Start/stop function is temporarily deactivated until the battery has been recharged by the car. In an outside temperature of approx. +15 °C (approx. 60 °F), the battery needs to be charged for at least 1 hour by the car. In a lower outside temperature, the charging time may increase to 3–4 hours. The recommendation is to charge the battery using an external battery charger.

**Related information**

- Starting the car (p. 426)
- Ignition positions (p. 428)
- Adjusting the steering wheel (p. 193)
- Selecting ignition mode (p. 429)

**Towbar\***

The car can be equipped with a towbar that makes it possible to tow e.g. a trailer behind the car.

There may be different towbar variants available for the car. Contact a Volvo dealer for more information.

**i IMPORTANT**

When the engine is switched off, the constant battery voltage to the trailer connector can be switched off automatically so as not to drain the starter battery.

**i IMPORTANT**

The towball needs regular cleaning and lubrication with grease in order to prevent wear.

**i NOTE**

When a hitch with a vibration damper is used, the towball must not be lubricated.

This also applies when fitting a bicycle rack that is clamped in around the towball.

**i NOTE**

If the car is equipped with a towbar, there is no rear mounting for a towing eye.

**Related information**

- Extendable and retractable towbar\* (p. 470)
- Driving with a trailer (p. 472)
- Towbar-mounted bicycle rack\* (p. 476)
- Specifications for towbar\* (p. 470)

## Specifications for towbar\*

Dimensions and mounting points for towbar.

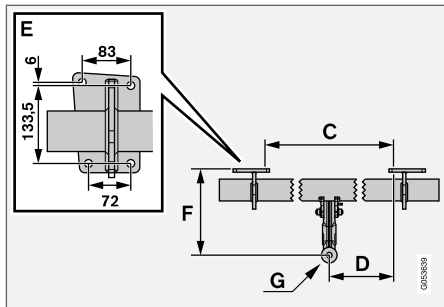
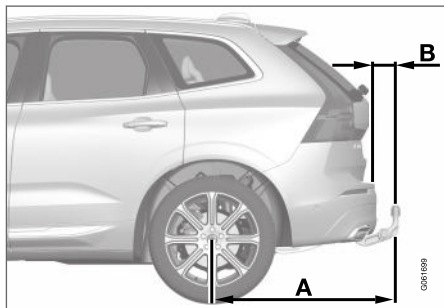

Dimensions, mounting points in mm (inches)	
A	1121,9 (44,2)
B	81,5 (3,2)
C	875 (34,4)
D	437,5 (17,2)
E	See the image above
F	273,7 (10,8)
G	Ball centre

### Related information

- Towbar\* (p. 469)
- Towing capacity and towball load (p. 650)

## Extendable and retractable towbar\*

The retractable tow hook is easy to retract or extend as required. In the retracted position, the towbar is completely concealed.

### **⚠ WARNING**

Follow the instructions for retracting and extending the towbar carefully.

### **⚠ WARNING**

Do not press the extend/retract button if a trailer is attached to the towbar.

### Extending the towbar

### **⚠ WARNING**

Avoid standing close to the bumper in the centre behind the car when extending the towing hitch.



1.

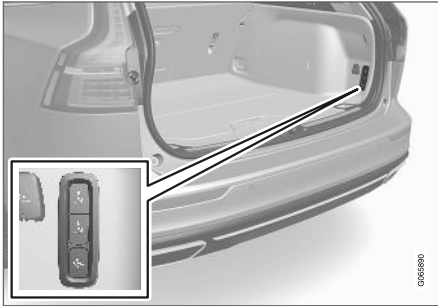

Open the tailgate. A button for extending/retracting the towbar is located on the right-hand side at the rear of the cargo area. An indicator lamp in the button must illuminate with a constant orange glow for the extension function to be active.

2. Press and release the button – extension might not start if the button is pressed for too long.



> The towbar extends out and down in an unlocked position - the indicator lamp flashes orange. The tow hook is ready to continue moving to the locked position.

3.



Move the towbar to its end position, where it is secured and locked in place - the indicator lamp illuminates with a constant orange glow.

> The towbar is ready for use.

**i NOTE**

The towbar must finish the extension procedure before it can then be moved to locked position. This procedure may take several seconds. If the towbar is not fixed in locked position, wait a few seconds and try again.

**⚠ WARNING**

Take care to secure the trailer's safety cable in the intended bracket.



**i NOTE**

Power save mode activates after a while and the indicator lamp goes out. The system is reactivated by closing and opening the tailgate. This applies when retracting or extending the towbar.

If the car detects a connected trailer electrically, the indicator lamp stops illuminating with a constant glow.

**Retracting the towbar**

**! IMPORTANT**

Make sure that there is no plug or adapter in the electrical socket when retracting the towbar.

1. Open the tailgate. Press and release the button on the right-hand side at the rear of the cargo area - retraction might not start if the button is pressed for too long.
  - > The towbar automatically lowers in an unlocked position - the indicator lamp in the button flashes orange.

2.

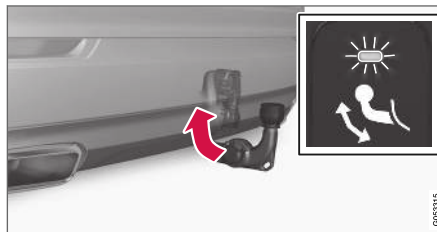

Lock the towbar by moving it back to its retracted position, where it is locked.

- > The indicator lamp will now illuminate with a constant glow if the towbar is correctly retracted.



**Related information**

- Driving with a trailer (p. 472)
- Towbar\* (p. 469)

**Driving with a trailer**

When driving with a trailer, there are a number of points that are important to think about regarding the towbar, the trailer and how the load is positioned in the trailer.

Payload depends on the car's kerb weight. The total of the weight of the passengers and all accessories, e.g. towbar, reduces the car's payload by a corresponding weight.

The car is supplied with the necessary equipment for towing a trailer.

- The car's towbar must be of an approved type.
- Distribute the load on the trailer so that the weight on the towbar complies with the specified maximum towball load. Towball load is calculated as part of the car's payload.
- Increase the tyre pressure to the recommended pressure for a full load.
- The engine is loaded more heavily than usual when driving with a trailer.
- Do not tow a heavy trailer when the car is brand new. Wait until it has been driven at least 1000 km (620 miles).
- The brakes are loaded much more than usual on long and steep downhill slopes. Downshift to a lower gear when shifting manually and adjust your speed.

- Follow the regulations in force for the permitted speeds and weights.
- Maintain a low speed when driving with a trailer up long, steep ascents.
- The maximum indicated trailer weight only applies to heights up to 1000 metres above sea level (3280 ft). At higher elevations, the engine output and the vehicle's climbing ability are reduced due to the reduced air density, and the maximum trailer load must therefore be reduced. The weight of the car and trailer must be decreased by 10% for each additional 1000 m (3280 ft) or part thereof.
- Avoid driving with a trailer on inclines of more than 12%.

#### **i NOTE**

Extreme weather conditions, driving with a trailer or driving at high altitudes, in combination with poorer fuel quality than recommended, are factors that considerably increase the car's fuel consumption.

#### **Trailer connector**

An adapter is required if the car's towbar has a 13 pin connector and the trailer has a 7 pin connector. Use an adapter approved by Volvo. Make sure the cable does not drag on the ground.

#### **! IMPORTANT**

When the engine is switched off, the constant battery voltage to the trailer connector can be switched off automatically so as not to drain the starter battery.

#### **Trailer weights**

#### **! WARNING**

Follow the stated recommendations for trailer weights. Otherwise, the car and trailer may be difficult to control in the event of sudden movement and braking.

#### **i NOTE**

The stated maximum permitted trailer weights are those permitted by Volvo. National vehicle regulations can further limit trailer weights and speeds. Towbars can be certified for higher towing weights than the car can actually tow.

#### **Level control\***

The car's system for level control endeavours to maintain a constant height regardless of load (up to the maximum permissible weight). When the car is stationary the rear of the car lowers slightly, which is normal.

#### **When driving in hilly terrain and hot climates**

Under certain circumstances, there may be a risk of overheating when towing a trailer. If the engine and drive system overheats, a warning symbol comes on in the driver display and a message is displayed.

The automatic gearbox selects the optimum gear depending on load and engine speed.

#### **Steep inclines**

Do not lock the automatic gearbox in a higher gear than the engine "can cope with" - it is not always a good idea to drive at a high gear with low engine speed.

#### **Parking on a hill**

1. Depress the brake pedal fully.
2. Activate the parking brake.
3. Select gear position **P**.
4. Release the brake pedal.

Block the wheels with chocks when parking a car with hitched trailer on a hill.

#### **Starting on a hill**

1. Depress the brake pedal fully.
2. Select gear position **D**.
3. Releasing the parking brake.
4. Release the brake pedal and start driving off.



◀◀ **Related information**

- Trailer stability assist\* (p. 474)
- Checking trailer lamps (p. 475)
- Towing capacity and towball load (p. 650)
- Overheating in the engine and drive system (p. 466)
- Adverse driving conditions for engine oil (p. 654)

**Trailer stability assist\***

The function of trailer stability assist (TSA<sup>11</sup>) is to stabilise cars towing trailers in situations where they begin snaking. The function is included in the stability system ESC<sup>12</sup>.

**Reasons for snaking**

The snaking phenomenon can occur with any car/trailer combination. Snaking normally occurs at high speeds. However, there is a risk of it occurring at lower speeds if the trailer is overloaded or the load is improperly distributed, e.g. too far back.

In order for snaking to occur, there must be a triggering factor, e.g.:

- Car with trailer subjected to a sudden and powerful side wind.
- Car with trailer drives on an uneven road surface or in a pothole.
- Sweeping steering wheel movements.

If snaking has started, it could be difficult or even impossible to suppress. This makes the car/trailer combination difficult to control and there is a risk that you could, for example, end up in the wrong lane or leave the carriageway.

**Trailer stability assist function**

The trailer stability assist function continually monitors the car's movements, particularly lateral movements. If snaking is detected, the front wheels are individually braked. This serves to stabilise the car/trailer combination. This is often enough to help the driver regain control of the car.

If snaking is not eliminated the first time that trailer stability assist intervenes, the car/trailer combination is braked with all wheels and engine power is reduced. Once snaking has been gradually suppressed and the car/trailer combination is stable once again, the system stops regulating and the driver once again has full control of the car.

 <b>NOTE</b>
The stability function is deactivated if the driver selects Sport mode by deactivating <b>ESC</b> via the menu system in the centre display.

Trailer stability assist may fail to intervene if the driver uses severe steering wheel movements to try to rectify the snaking because in such a situation the system cannot determine whether it is the trailer or the driver causing the snaking.

<sup>11</sup> Trailer Stability Assist  
<sup>12</sup> Electronic Stability Control



When Trailer Stability Assist (TSA) is operating, the ESC symbol flashes in the driver display.

### Related information



- Driving with a trailer (p. 472)
- Electronic stability control (p. 279)

## Checking trailer lamps

When connecting a trailer - check that all the trailer lamps work before departure.

### Direction indicators and brake lights on the trailer

If one or more of the trailer's direction indicators or brake light bulbs is broken, the driver display shows a symbol and a message. Other lights on the trailer must be checked manually by the driver before setting off.

Symbol	Message
	<ul style="list-style-type: none"> <li>• Trailer turn indicator Right turn indicator malfunction</li> <li>• Trailer turn indicator Left turn indicator malfunction</li> </ul>
	<ul style="list-style-type: none"> <li>• Trailer brake light Malfunction</li> </ul>

If any lamp for the trailer's direction indicators is broken, the driver display symbol for direction indicators will also flash more quickly than normal.

### Rear fog lamp on trailer

When connecting the trailer, the rear fog lamp may not light up on the car. In such cases, the rear fog lamp function switches to the trailer. Upon activation of the rear fog lamp, check

therefore that the trailer is equipped with a rear fog lamp to travel safely.

## Checking trailer lamps\*

### Automatic checking

After a trailer is connected electrically, it is possible to check that the trailer lamps are working via an automatic lamp activation. The function helps the driver check that the trailer lamps are working before starting off.

The car must be switched off to perform the check.

1. When a trailer is connected to the towbar, the **Automatic Trailer Lamp Check** message is shown in the driver display.
2. Confirm the message by pressing the right-hand steering wheel keypad's **O** button.
  - > The lamp check starts.
3. Exit the car to check lamp functionality.
  - > All trailer lamps start to flash - then the lamps are switched on one at a time.
4. Visually check that all lamps available on the trailer are operational.
5. After a moment, all lamps on the trailer flash again.
  - > The check is complete.



#### ◀ **Switching off automatic checking**

The automatic checking function can be switched off in the centre display.

1. Press **Settings** in the top view.
2. Press **My Car → Lights and Lighting**.
3. Deselect **Automatic Trailer Lamp Check**.

#### **Manual checking**

If the automatic checking is switched off then it is possible to start the check manually.

1. Press **Settings** in the top view.
2. Press **My Car → Lights and Lighting**.
3. Select **Manual Trailer Lamp Check**.
  - > The lamp check starts. Exit the car to check lamp functionality.

#### **Related information**

- Driving with a trailer (p. 472)

#### **Towbar-mounted bicycle rack\***

When using a bicycle rack, the bicycle racks that Volvo has developed are recommended.

This is in order to avoid damage to the car and in order to achieve the maximum possible safety during a journey. Volvo's bicycle racks are available for purchase at authorised Volvo dealers.

Carefully follow the instructions enclosed with the bicycle rack.

- Bicycle rack including load must weigh a maximum of 75 kg (165 pounds).
- The bicycle rack may be designed for a maximum of three bicycles.

#### **WARNING**

Incorrect use of the bicycle rack may cause damage to the towbar and car.

The bicycle rack can loosen from the towbar if it

- is incorrectly fitted on the towball
- is overloaded, see the bicycle rack's instructions for maximum load weight
- is used for carrying something other than bicycles.

The car's driving characteristics are affected when a bicycle rack is fitted on the towbar. For example, due to:

- increased weight
- reduced acceleration capacity
- reduced ground clearance
- changed braking capacity.

#### **Recommendations for loading bicycles on the bicycle rack**

The larger the distance between the load's centre of gravity and the towball, the greater the load on the towbar.

Load according to the following recommendations:

- Fit the heaviest bicycle furthest in, closest to the car.
- Keep the load symmetrical and as close to the centre of the car as possible, e.g. by loading the bicycles facing alternately if several bicycles are loaded.
- Remove loose objects from the bicycle for transportation, e.g. bicycle basket, battery, child seat. Partly to reduce the load on the towbar and bicycle rack, and partly to reduce the wind resistance, which affects fuel consumption.
- Do not use protective covers on the bicycles. This may affect manoeuvrability, impair visibil-

ity and increase fuel consumption. It may also lead to an increased load on the towbar.

### Related information

- Towbar\* (p. 469)

## Towing

During towing, the car is towed by another vehicle by means of a towline.

Towing a Twin Engine is not permitted as this will damage the electric motor. Instead, the car must be transported raised with all the wheels on a recovery vehicle's platform, neither of the wheel pairs may have road contact.

### When towing another car

Towing a car requires a lot of energy - use the **Constant AWD** drive mode. This then charges the hybrid battery, in combination with improving the car's driving characteristics and roadholding.

Find out the statutory maximum speed limit for towing before the towing begins.

### Jump starting

Tow-starting the motor is not permitted as this will damage the electric motor. Use a donor battery if the starter battery is discharged and the engine does not start.



### IMPORTANT

The electric drive motor and the catalytic converter may be damaged during attempts to tow-start the car.

## Related information

- Fitting and removing the towing eye (p. 478)
- Hazard warning flashers (p. 153)
- Recovery (p. 479)
- Using jump starting with another battery (p. 467)
- Selecting ignition mode (p. 429)

## Fitting and removing the towing eye

Use the towing eye if the car shall tow another vehicle. The towing eye is screwed into a threaded socket behind a cover on the right-hand side of the rear bumper.

### **i** NOTE

If the car is equipped with a towbar, there is no rear mounting for a towing eye.

### Fitting the towing eye

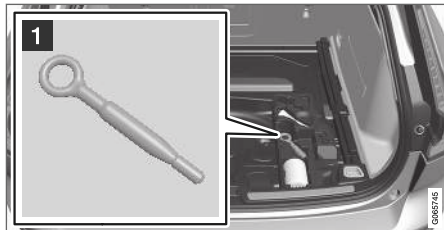

- 1 Take out the towing eye from the foam block under the floor in the cargo area.

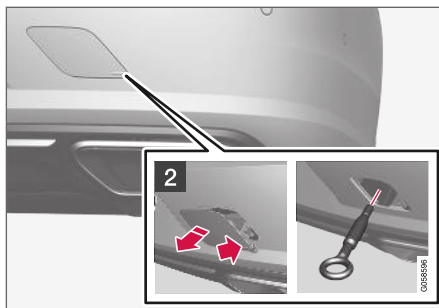

- 2 Remove the cover – press on the marking with a finger while you fold out the opposite side/corner.
  - > The cover pivots around its centre line and can then be removed.

3. Screw in the towing eye until it reaches its end stop.



Screw the eye in firmly. For example, thread through the wheel bolt wrench\* and use it as a lever.

### **i** IMPORTANT

It is important that the towing eye is firmly screwed into place - right in until it stops.

### Removing the towing eye

- Unscrew and remove the towing eye after use and return it to its place in the foam block.
  - Finish by refitting the cover onto the bumper.

### Related information

- Towing (p. 477)
- Recovery (p. 479)
- Tool kit (p. 555)



## Recovery

For recovery, the car is taken away with the help of another vehicle.

Call a recovery service for recovery assistance.

The towing eye can be used to pull the car up onto a recovery vehicle with a flatbed platform.

### ! IMPORTANT

Note that cars with Twin Engine must always be transported raised up with all the wheels on the recovery vehicle's platform.

The car's position and ground clearance determine whether it is possible to pull it up onto a flatbed platform. If the slope of the recovery vehicle's ramp is too steep, or if the ground clearance under the car is inadequate, then the car may be damaged if you try to pull it up. The car should then be lifted using the recovery vehicle's lifting device.

### ⚠ WARNING

No one/nothing is allowed to remain behind the recovery vehicle while the car pulled up onto the flatbed platform.

## Related information

- Fitting and removing the towing eye (p. 478)

<sup>13</sup> Applies to certain markets.

<sup>14</sup> HomeLink and the HomeLink house symbol are registered trademarks of Gentex Corporation.

## HomeLink®\*<sup>13</sup>

HomeLink®<sup>14</sup> is a programmable remote control, integrated in the car's electrical system, which can remotely control up to three different devices (e.g. garage door opener, alarm system, outdoor and indoor lighting) and thereby replace the remote controls for them.

### General

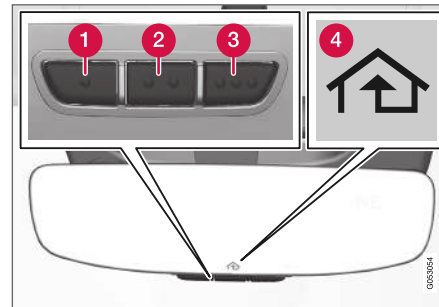

The figure is schematic - the version may vary.

- 1 Button 1
- 2 Button 2
- 3 Button 3
- 4 Indicator lamp

HomeLink® is supplied built-in to the interior rearview mirror. The HomeLink® panel consists of three programmable buttons and one indicator lamp in the mirror glass.

For more information about HomeLink®, visit [www.HomeLink.com](http://www.HomeLink.com) or call 00 8000 466 354 65 (or the toll number +49 6838 907 277)<sup>15</sup>.

Save the original remote controls for future programming (e.g. when changing to another car or for use in another vehicle). It is also recommended that the programming for the buttons is deleted when the car is sold.

## Related information

- Using HomeLink®\* (p. 482)
- Programming HomeLink®\* (p. 480)
- Type approval for HomeLink®\* (p. 482)

## Programming HomeLink®\*16

Follow these instructions to program HomeLink®, reset all programming or reprogram individual buttons.

### NOTE

In certain vehicles the ignition must be switched on or in "accessory position" before HomeLink® can be programmed or used. If possible, fit new batteries in the remote control that shall be replaced by HomeLink® for faster programming and improved transmission of the radio signal. The HomeLink® buttons should be reset before programming.

### WARNING

While programming HomeLink®, the garage door or gate being programmed may activate. For this reason, make sure that nobody is in the vicinity of the door or gate while programming is in progress. The car should be outside the garage while a garage door opener is being programmed.

1. Aim the remote control towards the HomeLink® button to be programmed and hold it approx. 2-8 cm (approx. 1-3 inches) from the button. Do not obstruct the indicator lamp on HomeLink®.  
**Note:** The ability of some remote controls to program HomeLink® is improved at a distance of approx. 15-20 cm (approx. 6-12 inches). Bear this in mind if problems occur with the programming.
2. Press and hold depressed both the button on the remote control and the button to be reprogrammed on HomeLink®.
3. Do not release the buttons until the indicator lamp has switched from flashing slowly (approx. once per second) to either flashing quickly (approx. 10 times per second) or illuminating with a constant glow.  
> **If the indicator lamp illuminates with a constant glow:** Indication that the programming has finished. Press the programmed button twice to activate.  
**If the indicator lamp flashes quickly:** The device to be programmed to HomeLink® may have a security function that requires extra steps. Test by pressing the programmed button twice to see whether the programming is working. Otherwise, continue with the following steps.

<sup>15</sup> Note that the toll-free number may not be available depending on operator.

<sup>16</sup> Applies to certain markets.

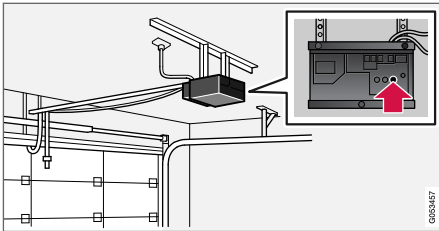

4. Locate programming button<sup>17</sup> on the receiver for the garage door or similar. It is normally located close to the antenna's bracket on the receiver.
5. Depress and release the receiver's programming button once. The programming must be completed within 30 seconds of the button being depressed.
6. Press and release the button on HomeLink<sup>®</sup> that you want to program. Repeat the sequence of pressing/holding/releasing a second time and, depending on the receiver model, even a third time.
  - > Programming is now complete and the garage door, gate or similar should now be activated when the programmed button is depressed.

In the event of programming problems, contact HomeLink<sup>®</sup> at [www.HomeLink.com](http://www.HomeLink.com), or call

00 8000 466 354 65 (or the toll number +49 6838 907 277)<sup>18</sup>.

### Reprogramming individual buttons

To reprogram an individual HomeLink<sup>®</sup> button, proceed as follows:

1. Press the desired button and hold it depressed for approx. 20 seconds.
2. Once the indicator lamp on HomeLink<sup>®</sup> starts to flash slowly, programming can continue as normal.

**Note:** If the button to be reprogrammed is not programmed with a new unit, it will resume the previously saved programming.

### Resetting the HomeLink<sup>®</sup> buttons

It is only possible to reset all of the HomeLink<sup>®</sup> buttons at the same time, not each button individually. Individual buttons can only be reprogrammed.

- Press and hold depressed the outer buttons (1 and 3) on HomeLink<sup>®</sup> for approx. 10 seconds.
  - > When the indicator lamp changes over from a constant glow to starting to flash, the buttons are reset and ready to be reprogrammed.

### Related information

- Using HomeLink<sup>®\*</sup> (p. 482)
- HomeLink<sup>®\*</sup> (p. 479)
- Type approval for HomeLink<sup>®\*</sup> (p. 482)

<sup>17</sup> Button designation and colour varies between manufacturers.

<sup>18</sup> Note that the toll-free number may not be available depending on operator.

## Using HomeLink®\*19

When HomeLink® is fully programmed it can be used in place of the separate original remote controls.

Depress the programmed button. The garage door, gate, alarm system or similar is activated (may take a few seconds). If the button is depressed for more than 20 seconds then the reprogramming is started. The indicator lamp illuminates or flashes when the button has been depressed. Naturally the original remote controls can still be used in parallel with HomeLink® if required.

### **i** NOTE

When the ignition has been switched off, HomeLink® works for at least 7 minutes.

### **i** NOTE

HomeLink® cannot be used if the car is locked and the alarm is armed\* from the outside.

19 Applies to certain markets.

20 Applies to certain markets.

## **⚠** WARNING

- If HomeLink® is used to control a garage door or gate, ensure that nobody is near the door or gate while it is in motion.
- Do not use HomeLink® for any garage door that does not have safety stop and safety reverse.

### Related information

- HomeLink®\* (p. 479)
- Programming HomeLink®\* (p. 480)
- Type approval for HomeLink®\* (p. 482)

## Type approval for HomeLink®\*20

### Type approval for EU

Gentex Corporation hereby declares that HomeLink® Model UAHL5 complies with the Radio equipment directive 2014/53/EU.

Wavelength within which the radio equipment functions:

- 433.05MHz-434.79MHz <10mW E.R.P.
- 868.00MHz-868.60MHz <25mW E.R.P.
- 868.70MHz-868.20MHz <25mW E.R.P.
- 869.40MHz-869.65MHz <25mW E.R.P.
- 869.70MHz-870.00MHz <25mW E.R.P.

Certificate holder address: Gentex Corporation, 600 North Centennial Street, Zeeland MI 49464, USA

For more information, see [support.volvocars.com](http://support.volvocars.com).

### Related information

- HomeLink®\* (p. 479)

## Compass\*

The upper right-hand corner of the rearview mirror has an integrated display that shows the compass direction<sup>21</sup> in which the front of the car is pointing.



Rearview mirror with compass.

Eight different compass directions are shown by their English abbreviations: **N** (north), **NE** (north east), **E** (east), **SE** (south east), **S** (south), **SW** (south west), **W** (west) and **NW** (north west).

### Related information

- Activating and deactivating the compass\* (p. 483)
- Calibrating the compass\* (p. 483)

## Activating and deactivating the compass\*

The upper right-hand corner of the rearview mirror has an integrated display that shows the compass direction<sup>22</sup> in which the front of the car is pointing.

### Activating and deactivating the compass

The compass is activated automatically when the car is started.

To deactivate/activate the compass manually:

- Depress the button on the underside of the rearview mirror using e.g. a paper clip.

### Related information

- Compass\* (p. 483)
- Calibrating the compass\* (p. 483)

## Calibrating the compass\*

The earth is divided into 15 magnetic zones. The compass<sup>23</sup> should be calibrated if the car is moved between several magnetic zones.

Proceed as follows to perform calibration:

1. Stop the car in a large open area free from steel structures and high-voltage power lines.
2. Start the car and switch off all electrical equipment (air conditioning, wipers, etc.) and ensure that all doors are closed.

### **i** NOTE

Calibration may fail or not start at all if electrical equipment is not switched off.

3. Hold the button on the underside of the rearview mirror depressed for approx. 3 seconds (use a paper clip, for example). The number for the current magnetic zone is shown.

<sup>21</sup> A rearview mirror with a compass is available as an option on certain markets and models only.

<sup>22</sup> A rearview mirror with a compass is available as an option on certain markets and models only.

<sup>23</sup> A rearview mirror with a compass is available as an option on certain markets and models only.

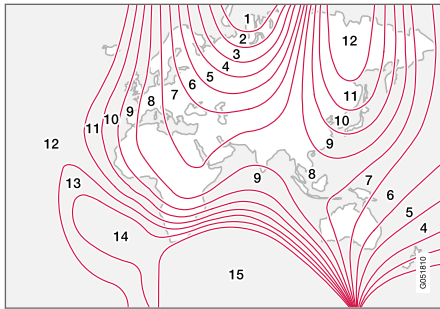

Magnetic zones.

- Press the button repeatedly until the required magnetic zone (1-15) is shown. See the map of magnetic zones for the compass.
- Wait until the display returns to showing the character **C**, or hold the button on the underside of the rearview mirror depressed for approx. 6 seconds until the character **C** is shown.
- Drive slowly in a circle at a speed of no more than 10 km/h (6 mph) until a compass direction is shown in the display, indicating that calibration is complete. Then drive a further 2 circles to fine-tune calibration.
- Cars with heated windscreen\*:** If the character **C** is shown in the display when the heated windscreen is activated, perform the calibration in accordance with point 6 above with the heated windscreen activated.
- Repeat the above procedure as necessary.

### Related information

- Compass\* (p. 483)
- Activating and deactivating the compass\* (p. 483)

SOUND, MEDIA AND INTERNET

## Sound, media and Internet

The audio and media system consists of media player and radio. You can also connect a phone via Bluetooth to use handsfree functions or play music wirelessly in the car. When the car is connected to the Internet you can also use apps for media playback.



Overview of audio and media

Control the functions with your voice, steering wheel keypad or the centre display. The number of speakers and amplifiers depends on which audio system the car is equipped with.

### System updating

The audio and media system is continuously improved. When the car is connected to the Internet, it is possible to download system updates for optimal functionality, see [support.volvocars.com](http://support.volvocars.com).

### Related information

- Media player (p. 497)
- Radio (p. 491)
- Phone (p. 512)
- Internet-connected car\* (p. 521)
- Apps (p. 488)
- Voice recognition (p. 138)
- Ignition positions (p. 428)
- Driver distraction (p. 39)
- Managing system updates via the Download Centre (p. 591)
- License agreement for audio and media (p. 529)

## Audio settings

The audio system is preset for optimum sound reproduction, but it can also be adapted.

The volume is normally adjusted with the volume control below the centre display or with the right-hand steering wheel keypad. This applies, for example, during playback of music, radio, ongoing phone calls and active traffic messages.

### Optimum sound reproduction

The audio system is pre-calibrated for optimum sound reproduction by means of digital signal processing. This calibration takes into account loudspeakers, amplifiers, passenger compartment acoustics, listener position, etc., for each combination of car model and audio system. There is also a dynamic calibration that takes into account the setting of the volume control and vehicle speed.

### Personal preferences

Various settings are available in the top view under **Settings** → **Sound** depending on the car's audio system.



**Premium Sound\* (Bowers & Wilkins)**

- **Tone** – settings for bass, treble, equalizer, etc.
- **Balance** - balance between right/left loudspeakers and balance between front/rear loudspeakers.
- **System Volumes** – adjusts volume in the various systems of the car, e.g. **Voice Control**, **Park Assist** and **Phone Ringtone**.

**High Performance Pro\* (Harman Kardon)**

- **Equaliser** – equalizer setting.
- **Balance** - balance between right/left loudspeakers and balance between front/rear loudspeakers.
- **System Volumes** – adjusts volume in the various systems of the car, e.g. **Voice Control**, **Park Assist** and **Phone Ringtone**.

**High Performance**

- **Tone** – settings for bass, treble, equalizer, etc.
- **Balance** - balance between right/left loudspeakers and balance between front/rear loudspeakers.
- **System Volumes** – adjusts volume in the various systems of the car, e.g. **Voice Control**, **Park Assist** and **Phone Ringtone**.

**Related information**

- Sound experience\* (p. 487)
- Media player (p. 497)
- Settings for voice recognition (p. 142)
- Settings for phone (p. 520)
- Sound, media and Internet (p. 486)
- Internet-connected car\* (p. 521)

**Sound experience\***

Sound experience is an app that provides access to further audio settings.

**Sound Experience** is opened from the app view in the centre display. The following settings can be defined, depending on the audio system fitted to the car:

**Premium Sound\* (Bowers & Wilkins)**

- **Studio** - the sound can be optimised for **Driver**, **All** and **Rear**.
- **Individual stage** - surround sound mode with settings for intensity and enclosure.
- **Concert hall** - reproduces the acoustics from Gothenburg's Concert Hall.



Recreating the acoustics from Gothenburg Concert Hall.



## ◀◀ High Performance Pro\* (Harman Kardon)

- **Seat Optimisation** - the sound can be optimised for **Driver, All** and **Rear**.
- **Surround** - surround sound mode with level settings.
- **Tone** - settings for bass, treble, equalizer, etc.

### Related information

- Audio settings (p. 486)
- Navigating in the centre display's views (p. 108)

## Apps

The app view contains applications (apps) that give access to certain of the car's services.

Swipe from right to left<sup>1</sup> across the centre display's screen in order to access the app view from the home view. Apps that have been downloaded (third-party apps) and apps for embedded functions, such as **FM radio**, are found here.



App view (generic image, basic apps vary by market and model)

Some basic apps are always available. More apps such as web radio and music services can be downloaded when the car is connected to the Internet.

Certain apps are only available for use if the car is connected to the Internet.

<sup>1</sup> Applies to left-hand drive cars. For right-hand drive cars - swipe in the opposite direction.

Start an app by pressing the app in the centre display's app view.

All the apps used should be updated to the latest version.

### Related information

- Downloading apps (p. 489)
- Updating apps (p. 490)
- Deleting apps (p. 490)
- Apple® CarPlay®\* (p. 506)
- Android Auto\* (p. 510)
- Internet-connected car\* (p. 521)
- Storage space on hard disk (p. 528)
- User terms and conditions and data sharing (p. 527)

## Downloading apps

New apps can be downloaded when the car is connected to the Internet.

### NOTE

Data download may affect other services that transmit data, e.g. Internet radio. If the effect on other services is experienced as disruptive then the download can be interrupted. Alternatively, it may be appropriate to switch off or interrupt other services.

### NOTE

When downloading using a phone, pay extra attention to the data traffic costs.

1. Open the **Download Centre** app in the app view.



2. Select **New apps** in order to open a list of apps that are available but not installed in the car.

3. Tap on the row for an app in order to expand in the list and get more information about the app.
4. Select **Install** in order to start the download and installation of the desired app.
  - > The status of the download and installation is shown while it is in progress.

A message is shown if a download cannot be started for the moment. The app will remain in the list and it is possible to try to start a download again.

### Cancelling the download

- Tap on **Abort** to cancel a download in progress.

Note that only the download can be cancelled, when the installation phase has started, this cannot be cancelled.

### Related information

- Apps (p. 488)
- Updating apps (p. 490)
- Deleting apps (p. 490)
- Internet-connected car\* (p. 521)
- Managing system updates via the Download Centre (p. 591)
- Storage space on hard disk (p. 528)

## Updating apps

The apps can be updated when the car is connected to the Internet.

### NOTE

Data download may affect other services that transmit data, e.g. Internet radio. If the effect on other services is experienced as disruptive then the download can be interrupted. Alternatively, it may be appropriate to switch off or interrupt other services.

### NOTE

When downloading using a phone, pay extra attention to the data traffic costs.

If an app is being used during an ongoing update, it will be restarted in order for the installation to be completed.

### Update all

1. Open the **Download Centre** app in the app view.



2. Select **Install all**.  
> Updating is started.

### Update some

1. Open the **Download Centre** app in the app view.
2. Select **Application updates** in order to open a list of all available updates.
3. Locate the desired app and select **Install**.  
> Updating is started.

### Related information

- Apps (p. 488)
- Downloading apps (p. 489)
- Deleting apps (p. 490)
- Managing system updates via the Download Centre (p. 591)
- Internet-connected car\* (p. 521)

## Deleting apps

Apps can be uninstalled when the car is connected to the Internet.

An app that is being used must be closed in order for the uninstallation to be completed.

1. Open the **Download Centre** app in the app view.



2. Select **Application updates** in order to open a list of all installed apps.
3. Locate the desired app and select **Uninstall** in order to start the uninstallation of the app.  
> When the app has been uninstalled, it disappears from the list.

### Related information

- Apps (p. 488)
- Downloading apps (p. 489)
- Updating apps (p. 490)
- Managing system updates via the Download Centre (p. 591)
- Internet-connected car\* (p. 521)

## Radio

It is possible to listen to the FM bands and to digital radio (DAB)\*. When the car is online, it is also possible to listen to Internet radio.

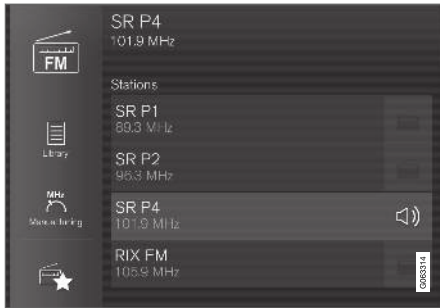

The radio can be operated using voice recognition, the steering wheel keypad or the centre display.

### Related information

- Start radio (p. 491)
- Changing radio band and radio station (p. 492)
- Setting radio favourites (p. 493)
- Settings for radio (p. 494)
- Digital radio\* (p. 496)

- RDS radio (p. 495)
- Internet-connected car\* (p. 521)
- Voice control of radio and media (p. 141)
- Media player (p. 497)

## Start radio

The radio is started from the centre display app view.

1. Open the required frequency band (e.g. FM) from the app view.



2. Select a radio station.

### Related information

- Radio (p. 491)
- Searching for radio stations (p. 493)



- Changing radio band and radio station (p. 492)
- Setting radio favourites (p. 493)
- Settings for radio (p. 494)
- Voice control of radio and media (p. 141)

## Changing radio band and radio station

There are instructions here for changing the radio band, the list in the radio band and the radio station in the selected list.

### Changing radio band

Swipe to show the app view in the centre display and select the preferred radio band (e.g. **FM**), or open the driver display's app menu using the right-hand keypad on the steering wheel and make your selection from there.

### Changing lists within the frequency band

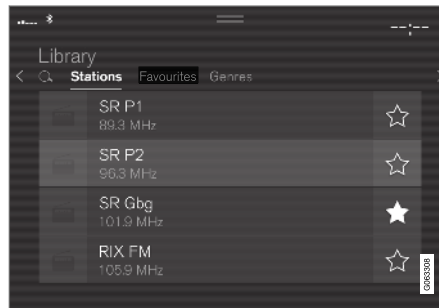

1. Press **Library**.

2. Select playback from **Stations**, **Favourites**, **Genres** or **Ensembles**<sup>2</sup>.
3. Tap on the desired station from the list.

**Favourites** - only plays back selected favourite channels.

**Genres** — only plays back channels broadcasting the selected genre/programme type, e.g. pop or classical.

### Changing stations within the selected list

- Press on **⏮** or **⏭** under the centre display or the steering wheel's right-hand keypad.
  - > The highlight moves up or down one place in the selected playlist.

You can also change radio station in the selected list via the centre display.

### Related information

- Radio (p. 491)
- Searching for radio stations (p. 493)
- Voice control of radio and media (p. 141)
- Setting radio favourites (p. 493)
- Settings for radio (p. 494)
- Application menu in driver display (p. 96)

<sup>2</sup> Only applies to digital radio (DAB\*).

## Searching for radio stations

The radio automatically compiles a station list of the radio stations within the area that are transmitting the strongest signals.



The parameters you can search on depend on the frequency band selected:

- FM — station, genre and frequency.
- DAB\* — ensembles and stations.

1. Press **Library**.
2. Press **Q**.  
> Search view with keyboard is opened.
3. Enter the search terms.  
> Searching takes place with each input of a character and the search results are shown by category.

## Manual tuning



On changing over to manual tuning, the radio no longer changes frequency automatically when reception is poor.

- Press **Manual tuning**, pull the control or press **⏪** or **⏩**. With a long press, the search jumps to the next available station in the frequency band. It is also possible to use the right keypad on the steering wheel.

## Related information

- Radio (p. 491)
- Start radio (p. 491)
- Changing radio band and radio station (p. 492)
- Voice control of radio and media (p. 141)
- Settings for radio (p. 494)

## Setting radio favourites

It is possible to add a radio channel to the **Radio favourites** app and the favourites list for the radio band (e.g. FM). Instructions on how to add and remove favourites can be found below.

### Radio Favourites



Radio Favourites shows saved favourites from all frequency bands.

1. Open the app **Radio favourites** from the app view.
2. Tap on the desired station in the list to start listening.

### Adding and removing radio favourites

- Tap on **☆** to add or remove a channel to or from frequency band favourites and Radio Favourites.

When a favourite is saved from a station list, the radio will automatically search for the best frequency. But if a favourite is saved from a manual station search, the radio does not automatically change to a stronger frequency.

When you remove a favourite, it will also be removed from frequency band favourites.



## ◀◀ Related information

- Radio (p. 491)
- Start radio (p. 491)
- Searching for radio stations (p. 493)
- Changing radio band and radio station (p. 492)
- Voice control of radio and media (p. 141)
- Settings for radio (p. 494)
- Application menu in driver display (p. 96)

## Settings for radio

There are various radio functions to activate and deactivate.

### Cancelling traffic messages

The broadcast of traffic messages etc. can be temporarily interrupted by tapping on  in the right-hand steering wheel keypad or by tapping on **Cancel** in the centre display.

### Activating and deactivating radio functions

Drag down the top view and select **Settings** → **Media** and the desired radio band to view available functions.

### FM Radio

- **Show Broadcast Information:** shows information on programme content, artists, etc.
- **Freeze Program Name:** select to stop the programme service name from scrolling continuously. Instead it freezes after 20 seconds.
- **Select Announcements:**
  - **Local Interruptions:** interrupts the current media playback and broadcasts information about traffic disruptions in the neighbourhood. Playback of previous media source is resumed when the message is finished. The **Local Interruptions** function is a geographically restricted version of the **Traffic Announcements** function. The **Traffic**

**Announcements** function must be activated at the same time.

- **News** : interrupts the current media playback and broadcasts news. Playback of previous media source is resumed when the news broadcast is finished.
- **Alarm:** interrupts the current media playback and sends alerts about major accidents and disasters. Playback of previous media source is resumed when the message is finished.
- **Traffic Announcements:** interrupts the current media playback and broadcasts information about traffic disruptions. Playback of previous media source is resumed when the message is finished.



**DAB\* (digital radio)**

- **Sort Services:** option for how channels will be sorted. Either alphabetically or by service number.
- **DAB To DAB Handover:** starts the function for linking within DAB. If reception of a radio channel is lost, another channel is found automatically in another channel group (ensemble).
- **DAB To FM Handover:** starts the function for linking between DAB and FM. If reception of a radio channel is lost, an alternative FM frequency is searched for automatically.
- **Show Broadcast Information:** select to show radio text or selected types of radio text, e.g. artist.
- **Show Program Related Images:** select whether or not to show images for programmes on the screen.
- **Select Announcements:** select the types of messages to be received while DAB is playing. Selected messages will interrupt the current media playback to play back the message. Playback of previous media source is resumed when the message is finished.
  - **Alarm:** interrupts the current media playback and sends alerts about major accidents and disasters. Playback of previous media

source is resumed when the message is finished.

- **Traffic Flash:** receives information about traffic disruptions.
- **News Flash:** receives news.
- **Transport Flash:** receives information about public transport, e.g. ferry and train timetables.
- **Warning/Services:** receives information about incidents of lower significance than the Alarm function, e.g. power failures.

**Related information**

- Radio (p. 491)
- Digital radio\* (p. 496)
- Symbols in the centre display's status bar (p. 117)

**RDS radio**

RDS (Radio Data System) means that the radio automatically changes to the strongest transmitter. RDS provides the ability to receive e.g. traffic information and to search for certain programme types.

RDS links FM transmitters into a network. An FM transmitter in such a network sends information that gives an RDS radio the following functions:

- Switch automatically to a stronger transmitter if reception in the area is poor.
- Search for programme category, e.g. programme types or traffic information.
- Receive text information on current radio programme.

**NOTE**

Some radio stations do not use RDS or only selected parts of its functionality.

When broadcasting news or traffic messages, the radio can switch stations, interrupting the audio source currently in use. For example, if the CD player\* is in use, it is paused. The radio returns to the previous audio source and volume when the set programme type is no longer broadcast. To go back earlier, press  on the right-hand steering wheel keypad or tap **Cancel** in the centre display.



## ◀ Related information

- Radio (p. 491)
- Settings for radio (p. 494)

### Digital radio\*

Digital radio (DAB<sup>3</sup>) is a digital broadcasting system for radio. The radio supports DAB, DAB+ and DMB<sup>4</sup>.



The radio can be operated using voice recognition, the steering wheel keypad or the centre display.



The digital radio app is launched from app view in the centre display.

Digital radio is played back in the same way as other radio bands, such as FM. Besides the option to select playback from **Stations**, **Favourites** and **Genres**, there is also the option to select playback from subchannels and **Ensembles**. An ensemble is a set of radio channels (a channel group) broadcasting on the same frequency.

In the cases where the radio channel transmits its logotype, it is downloaded and shown beside the station name (download time varies).

### DAB subchannel

Secondary components are usually named subchannels. These are temporary and can contain e.g. translations of the main programme into other languages. Subchannels are indicated with an arrow symbol in the channel list.

### Related information

- Link between FM and digital radio\* (p. 497)
- Changing radio band and radio station (p. 492)
- Searching for radio stations (p. 493)
- Setting radio favourites (p. 493)
- Voice control of radio and media (p. 141)
- Settings for radio (p. 494)

<sup>3</sup> Digital Audio Broadcasting  
<sup>4</sup> Digital Multimedia Broadcasting

## Link between FM and digital radio\*

The function enables the digital radio (DAB) to switch from a channel with poor or no reception to the same channel in another channel group (ensemble) with better reception, within DAB and/or between DAB and FM.

### DAB to DAB and DAB to FM linking

1. Press **Settings** in the top view.
2. Press **Media → DAB**.
3. Tick/untick **DAB To DAB Handover** and/or **DAB To FM Handover** in order to activate/deactivate the respective functions.

### Related information

- Digital radio\* (p. 496)
- Radio (p. 491)
- Settings for radio (p. 494)

## Media player

The media player can play back audio from the CD player\* and from external audio sources connected via the USB port or Bluetooth. It can also play back video format via the USB port.

When the car is connected to the internet, it is also possible to listen to web radio, audio books and music services via apps.



The media player is operated from the centre display, but several functions can be operated using the steering wheel's right-hand keypad or voice control.

The radio is operated in the media player and is described in a separate section.

### Related information

- Media playback (p. 498)
- Controlling and changing media (p. 499)
- Searching media (p. 500)
- Apps (p. 488)
- Radio (p. 491)
- CD player\* (p. 501)
- Video (p. 502)
- Media via Bluetooth® (p. 503)
- Media via USB port (p. 504)
- Internet-connected car\* (p. 521)

## Media playback

The media player is controlled from the centre display. Several functions can also be operated using the steering wheel's right-hand keypad or voice control.

The media player also operates the radio, which is described in a separate section.

### Starting the media source



App view. (Generic image, basic apps vary by market and model.)

### CD\*

1. Insert a CD.
2. Open the app **CD** from the app view.
3. Select what to play back.
  - > Playback begins.

### USB memory

1. Insert the USB memory.
2. Open the app **USB** from the app view.
3. Select what to play back.
  - > Playback begins.

### Mp3 player and iPod®

#### **NOTE**

To start playback from iPod, use the iPod app (not USB).

When an iPod is used as audio source, the car's audio and media system has a menu structure that is similar to the iPod player's own menu structure.

1. Connect media source.
2. Start playback from the connected media source.
3. Open the app (**iPod, USB**) from the app view.
  - > Playback begins.

### Bluetooth connected device

1. Activate Bluetooth in the media source.
2. Connect media source.
3. Start playback from the connected media source.
4. Open the app **Bluetooth** from the app view.
  - > Playback begins.

### Media with Internet connection

Play back media from Internet-connected apps:

1. Connect the car to the Internet.
2. Open the current app from the app view.
  - > Playback begins.

Read the separate section on how apps are downloaded.

### Video

1. Connect media source.
2. Open the app **USB** from the app view.
3. Tap on the title of the desired item to play back.
  - > Playback begins.

### Apple CarPlay

CarPlay is described in a separate section.

### Android Auto

Android Auto is described in a separate section.

## Related information

- Handling the application menu in the driver display (p. 97)
- Radio (p. 491)
- Controlling and changing media (p. 499)
- Connecting a device via USB port (p. 504)
- Connecting a device via Bluetooth® (p. 503)
- Downloading apps (p. 489)
- Internet-connected car\* (p. 521)
- Video (p. 502)
- Apple® CarPlay®\* (p. 506)
- Android Auto\* (p. 510)
- Voice control of radio and media (p. 141)
- Compatible media formats (p. 505)

## Controlling and changing media

The playback of media can be controlled with voice control, steering wheel keypad or the centre display.



The media player can be operated by voice recognition, from the steering wheel keypad or the centre display.



Volume - turn the control knob under the centre display or press ▲ ▼ on the steering wheel's right-hand keypad in order to increase or decrease the volume.

Play/pause - tap on the image belonging to the song being played back, the physical button under the centre display or ○ on the steering wheel's right-hand keypad.

Change track/song - tap on the desired track in the centre display, press on ⏮ or ⏭ under the centre display or on the steering wheel's right-hand keypad.

Fast forward/move in time - tap on the time axis in the centre display and drag sideways, or press and hold ⏮ or ⏭ under the centre display or on the steering wheel's right-hand keypad.

Changing media - select from previous sources in the app, in the app view, press on the desired app or select with the steering wheel's right-hand keypad via the app menu ☰.

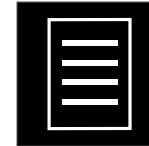

**Library** - tap on the button to play back from the library.



**Shuffle** - tap on the button to shuffle the playback order.





**Similar** - tap on the button in order to use Gracenote to search for similar music on the USB device and to create a playlist from it. The playlist can contain a maximum of 50 songs.

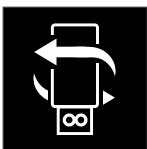

**Change device** - tap on the button in order to switch between USB devices when several are connected.

### Related information

- Media player (p. 497)
- Searching media (p. 500)
- Audio settings (p. 486)
- Apps (p. 488)
- Gracenote® (p. 501)
- Voice control of radio and media (p. 141)

## Searching media

It is possible to search by artist, composer, song titles, album, video, audio book, playlist and, when the car is connected to the Internet, podcasts (digital media via Internet).

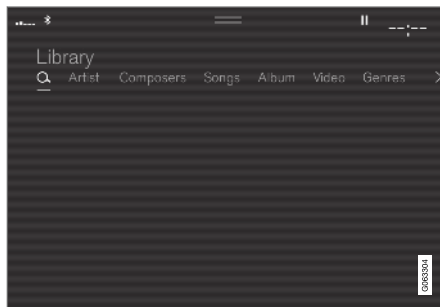

1. Press **Q**.  
> Search view with keyboard is opened.
2. Enter the search terms.
3. Press **Search**.  
> Connected devices are searched and the search results are listed by category.

Swipe sideways across the screen to show each category separately.

### Related information

- Media player (p. 497)
- Internet-connected car\* (p. 521)

- Media playback (p. 498)
- Enter the characters, letters and words manually in the centre display (p. 122)

## Gracenote®

Gracenote identifies artist, album, song titles and associated images, which are shown during playback.

Gracenote MusicID® is a standard for music recognition. Information on the music can be presented by means of the identification and analysis of the metadata in the music files. Sometimes metadata from different sources can be inconsistent or inadequate.

Gracenote has support for phonetic processing of artist name, album titles and genres, and in this way, voice control can be used to play back music.

1. Press **Settings** in the top view.
2. Press **Media** → **Gracenote**®.
3. Select settings for Gracenote data:
  - **Gracenote**® **Online Search** - searches in Gracenote's online database for playing media.
  - **Gracenote**® **Multiple Results** - selects how to display Gracenote data if there are more than one search results.
    - 1 - the file's original data are used.
    - 2 - Gracenote data are used.
    - 3 - Gracenote or original data can be selected.
  - **None** - no results are shown.

## Updating Gracenote

The content of the Gracenote database is updated continuously. Download the latest update for optimal functionality. For information and download, see support.volvocars.com.

## Related information

- Media playback (p. 498)
- License agreement for audio and media (p. 529)
- Voice control of radio and media (p. 141)

## CD player\*

The media player can play back CD discs with compatible audio files.



- 1 Disc insert and eject slot.
- 2 Disc eject button.

## Related information

- Media playback (p. 498)
- Voice control of radio and media (p. 141)
- Compatible media formats (p. 505)

## Video

Videos on USB-connected devices can be played back using the media player.

No picture is shown when the car starts to move, but only the audio is played back. The picture is shown again when the car is stationary.

Information on compatible formats for media can be found in a separate section.

### Related information

- Playing a video (p. 502)
- Playing back DivX® (p. 502)
- Settings for video (p. 503)
- Compatible media formats (p. 505)

## Playing a video

Videos are played using the **USB** app in the app view.

1. Connecting a media source (USB device).
2. Open the app **USB** from the app view.
3. Tap on the title of the desired item to play back.  
> Playback begins.

### Related information

- Video (p. 502)
- Playing back DivX® (p. 502)
- Settings for video (p. 503)
- Compatible media formats (p. 505)

## Playing back DivX®

This DivX Certified® device must be registered in order to play back purchased DivX Video-on-Demand (VOD) films.

1. Press **Settings** in the top view.
2. Tap **Video → DivX® VOD** and retrieve the registration code.
3. Go to vod.divx.com for more information and to complete the registration.

### Related information

- Video (p. 502)
- Playing a video (p. 502)
- Settings for video (p. 503)
- Compatible media formats (p. 505)



## Settings for video

It is possible to change certain video playback settings, e.g. language.

With the video player in full screen mode, or by opening the top view and pressing **Settings** → **Video**, the following can be adjusted: **Audio Language**, **Off** and **Subtitle Language**.

### Related information

- Video (p. 502)

## Media via Bluetooth®

The car's media player is equipped with Bluetooth and can wirelessly play audio files from external Bluetooth devices, such as mobile phones and tablets.

For the media player to be able to play back audio files wirelessly from an external device, the device must first be connected to the car via Bluetooth.

### Related information

- Connecting a device via Bluetooth® (p. 503)
- Connecting a phone to the car via Bluetooth for the first time (p. 513)
- Media playback (p. 498)
- Compatible media formats (p. 505)

## Connecting a device via Bluetooth®

Connect a Bluetooth® device to the car for wireless playback of media and to provide the car with an Internet connection where possible.

Many phones on the market now have wireless Bluetooth® technology, but not all of them are fully compatible with the car.

For information on compatibility, see [support.volvocars.com](http://support.volvocars.com).

The procedure for connecting a media device is the same as for connecting a phone to the car via Bluetooth®.

### Related information

- Media via Bluetooth® (p. 503)
- Connecting a phone to the car via Bluetooth for the first time (p. 513)
- Media playback (p. 498)

## Media via USB port

An external audio source, e.g. an iPod® or MP3 player, can be connected to the audio system via the car's USB port.

Devices with rechargeable batteries are recharged when connected via USB and the ignition is in position **I, II** or the engine is running.

The content of the external source can be loaded more quickly if it only consists of compatible formats. Video files can also be played back via the USB port.

Certain MP3 players have their own file system that the car does not support.

### Related information

- Connecting a device via USB port (p. 504)
- Media playback (p. 498)
- Video (p. 502)
- Ignition positions (p. 428)
- Technical specifications for USB devices (p. 505)
- Apple® CarPlay®\* (p. 506)
- Android Auto\* (p. 510)

## Connecting a device via USB port

An external audio source, e.g. an iPod® or MP3 player, can be connected to the audio system via one of the car's USB ports.

The phone must be connected to the USB port with white frame (when there are two USB ports) when using Apple CarPlay\* and Android Auto\*.



USB inputs (type A) in the tunnel console. Allow the cable to lie forwards so that it is not trapped when the lid is closed.

### Related information

- Media playback (p. 498)
- Media via USB port (p. 504)
- Media player (p. 497)
- Technical specifications for USB devices (p. 505)
- Technical specifications for USB devices (p. 505)

- Apple® CarPlay®\* (p. 506)
- Android Auto\* (p. 510)

## Technical specifications for USB devices

The following specifications must be met to allow the contents of the USB devices to be read.

No folder structure will be shown in the centre display during playback.

	Max number
Files	15 000
Folders	1 000
Folder levels	8
Playlists	100
Items in a playlist	1 000
Subfolders	No limit

## Technical specification for USB A connector

- Type A socket
- Version 2.0
- Voltage supply 5 V
- Current supply max. 2.1 A

## Related information

- Media via USB port (p. 504)

## Compatible media formats

The following file formats must be used for media playback.

### Audio files

Format	File extension	Codec
MP3	.mp3	MPEG1 Layer III, MPEG2 Layer III, MP3 Pro (mp3 compatible), MP3 HD (mp3 compatible)
AAC	.m4a, .m4b, .aac	AAC LC (MPEG-4 part III Audio), HE-AAC (aacPlus v1/v2)
WMA	.wma	WMA8/9, WMA9/10 Pro
WAV	.wav	LPCM
FLAC	.flac	FLAC

### Video files

Format	File extension
MP4	.mp4, .m4v
MPEG-PS	.mpg, .mp2, .mpeg, .m1v

Format	File extension
AVI	.avi
AVI (DivX)	.avi, .divx
ASF	.asf, .wmv
MKV	.mkv

### Subtitles

Format	File extension
SubViewer	.sub
SubRip	.srt
SSA	.ssa

## « DivX®

DivX certified devices have been tested for high-quality DivX (.divx, .avi) video playback. When you see the DivX logo, you have the freedom to play DivX films.

Profile	DivX Home Theater
Video codec	DivX, MPEG-4
Resolution	720x576
Bit rate	4.8Mbps
Frame rate	30 fps
File extension	.divx, .avi
Max file size	4 GB
Audio codec	MP3, AC3
Subtitles	XSUB
Special functions	Multiple subtitles, multiple audio, resume play
Reference	Meets all requirements of the DivX Home Theater profile. Visit <a href="http://divx.com">divx.com</a> for more information and software tools to convert your files into DivX Home Theater video.

## Related information

- Media player (p. 497)
- Video (p. 502)
- Playing back DivX® (p. 502)

## Apple® CarPlay®\*

CarPlay gives you the option to listen to music, make phone calls, get directions, send/receive messages and use Siri, all while you stay focused on your driving.

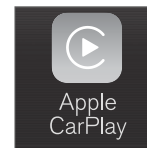



CarPlay works with selected iOS devices. If the car does not already support CarPlay there is the option to install it retroactively. Contact a Volvo dealer to install CarPlay.

Information about which apps are supported and which iOS devices are compatible is available on Apple's website: [www.apple.com/ios/carplay/](http://www.apple.com/ios/carplay/). Using apps that are not compatible with CarPlay may sometimes mean that the connection between the device and the car is broken. Please note that Volvo is not responsible for the content in CarPlay.

When using map navigation via CarPlay, there is no guidance in the driver display or head-up display, but only in the centre display.

When navigation is started through Apple CarPlay, ongoing native turn-by-turn route guidance will be ended.

The CarPlay apps can be controlled via the centre display, the iOS device or using the steering wheel's right-hand keypad (applies to certain functions). The apps can also be voice-controlled using Siri. A long press on the steering wheel

button  starts voice control using Siri and a short press activates the car's own voice control. If Siri breaks off too early, hold the steering wheel button  <sup>5</sup> depressed.

**By using Apple CarPlay you acknowledge the following: Apple CarPlay is a service provided by Apple Inc. under its terms and conditions. Volvo Cars is thus not responsible for Apple CarPlay or its features/applications. When using Apple CarPlay, certain information from your car (including its position) is transferred to your iPhone. In relation to Volvo Cars, you are fully responsible for your and any others person's use of Apple CarPlay.**

#### Related information

- Using Apple® CarPlay®\* (p. 507)
- Settings for Apple® CarPlay®\* (p. 508)
- Voice recognition (p. 138)
- Resetting settings in the centre display (p. 127)

## Using Apple® CarPlay®\*

To use CarPlay, Siri voice control must be activated on your iOS device. The device also needs an Internet connection via Wi-Fi or the mobile network.

### Connect an iOS device and start CarPlay

#### NOTE

CarPlay can only be used if Bluetooth is deactivated. A phone or media player connected to the car via Bluetooth will therefore not be available when CarPlay is active. An alternative Internet source must be used to connect to the Internet for the car's apps. Use Wi-Fi or the car's built-in modem\*.

1. Connect an iOS device to the USB port. In the cases where there are two USB ports, the one with the white frame around the port must be used.
2. Read the information in the pop-up window and then tap on **OK**.
3. Tap on **Apple CarPlay** in the app view.

4. Read the terms and conditions and then tap on **Accept** to connect.
  - > The subview with CarPlay is opened and compatible apps are shown.
5. Tap on the desired app.
  - > The app starts.

<sup>5</sup> Apple and CarPlay are registered trademarks owned by Apple Inc.

## ◀ Starting CarPlay

CarPlay is started according to the following after an iOS device has been connected.

1. Connect an iOS device to the USB port. In the cases where there are two USB ports, the one with the white frame around the port must be used.
  - > **If the setting for automatic start is selected** - the name of the device is shown.
2. Tap on the device name – the tile with CarPlay is opened and compatible apps are shown.
3. If the subview with CarPlay is not opened, tap on **Apple CarPlay** in the app view.
  - > The subview with CarPlay is opened and compatible apps are shown.
4. Tap on the desired app.
  - > The app starts.

CarPlay runs in the background if another app is started in the same subview. To show CarPlay in the subview again - tap on the CarPlay icon in the app view.

## Switch the connection between CarPlay and iPod

### CarPlay to iPod

1. Press **Settings** in the top view.

2. Continue to **Communication** → **Apple CarPlay**.
3. Untick the box for the iOS device that shall no longer start CarPlay automatically when the USB cable is connected.
4. Disconnect and connect the iOS device to the USB port.
5. Open the app **iPod** from the app view.

### iPod to CarPlay

1. Tap on **Apple CarPlay** in the app view.
2. Read the information in the pop-up window and then tap on **OK**.
3. Disconnect and connect the iOS device to the USB port.
  - > The subview with Apple CarPlay is opened and compatible apps are shown<sup>6</sup>.

### Related information

- Connecting a device via USB port (p. 504)
- Apple® CarPlay®\* (p. 506)
- Settings for Apple® CarPlay®\* (p. 508)
- Connect the car to the Internet via a phone (Wi-Fi) (p. 523)
- Connect the car to the Internet via car modem (SIM card) (p. 523)
- Voice recognition (p. 138)

## Settings for Apple® CarPlay®\*

Settings for iOS device connected with CarPlay<sup>7</sup>.

### Automatic start

1. Press **Settings** in the top view.
2. Continue to **Communication** → **Apple CarPlay** and select setting:
  - Tick the box - CarPlay starts automatically when the USB cable is connected.
  - Untick the box - CarPlay does not start automatically when the USB cable is connected.

If the car is shared by a lot of people, such as in a car pool, it is worth noting that a maximum of 20 iOS devices can be stored simultaneously in the list. When the list is full and a new device is connected the oldest one is deleted.

To delete the list, the settings must be reset in the centre display (factory reset).

### System volumes

1. Press **Settings** in the top view.

<sup>6</sup> Apple, CarPlay, iPhone and iPod are registered trademarks owned by Apple Inc.

2. Tap on **Sound** → **System Volumes** and make the settings for the following:

- **Voice Control**
- **Navi Voice Guidance**
- **Phone Ringtone**

### Related information

- Apple® CarPlay®\* (p. 506)
- Using Apple® CarPlay®\* (p. 507)
- Resetting settings in the centre display (p. 127)

## Tips for using Apple® CarPlay®\*

Here are some useful tips for using CarPlay®.

- Update your iOS device with the latest version of the iOS operating system and ensure that the apps have been updated.
- In the event of a problem with CarPlay, disconnect the iOS device from the USB port and reconnect. Otherwise, try to close the app on the device that is not working and then restart the app, or try closing all apps and restart your device.
- If the apps do not appear when CarPlay starts (black screen), try minimising and expanding the tile for CarPlay.
- Using apps that are not compatible with CarPlay may sometimes mean that the connection between the iOS device and the car is broken. Information about supported apps and compatible telephone devices can be found on the Apple website. You can also search for CarPlay in the App Store to find information about apps that are compatible with CarPlay on your market.
- Using Siri it is possible to write/dictate and read out messages. Messages are read out and dictated in the language selected in the settings for Siri. When you write/dictate messages, no text will be shown in the cen-

tre display, but the text is shown in the iOS device.

- If the device is connected to the car via Bluetooth, the connection will be interrupted when CarPlay is used. Resume the Internet connection in the car by sharing the Internet via the Wi-Fi hotspot from the device.
- CarPlay only works with iPhone<sup>8</sup>.

### NOTE

Availability and functionality may vary depending on market.

### Related information

- Apple® CarPlay®\* (p. 506)
- Connect the car to the Internet via a phone (Wi-Fi) (p. 523)

<sup>7</sup> Apple and CarPlay are registered trademarks owned by Apple Inc.

<sup>8</sup> Apple, CarPlay and iPhone are registered trademarks owned by Apple Inc.

## Android Auto\*

Android Auto gives you the option to listen to music, make phone calls, get directions and use car-adapted apps from an Android device. Android Auto works with selected Android devices.

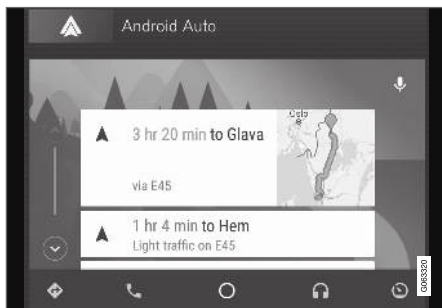

Information about which apps are supported and which Android devices are compatible is available on the website: [www.android.com/auto/](http://www.android.com/auto/). For third-party apps, see Google Play. Please note that Volvo is not responsible for the content in Android Auto.

Android Auto is started from the app view. After Android Auto has been started once, the app will be started automatically the next time the device is connected. Automatic start can be deactivated under settings.

### **i** NOTE

When a device is connected to Android Auto it is possible to stream via Bluetooth to another media player. Bluetooth is active while Android Auto is being used.

When using map navigation via Android Auto there is no guidance in the driver display or head-up display, but only in the centre display.

Android Auto can be controlled via the centre display using the steering wheel's right-hand keypad or voice control. A long press on the steering wheel button  starts Google Assistant and a short press inactivates.

**By using Android Auto, you acknowledge the following: Android Auto is a service provided by Google Inc. under its terms and conditions. Volvo Cars is not responsible for Android Auto or its features or applications. When you use Android Auto, your car transfers certain information (including its location) to your connected Android phone. You are fully responsible for your and any other person's use of Android Auto.**

### Related information

- Using Android Auto\* (p. 510)
- Settings for Android Auto\* (p. 511)

## Using Android Auto\*

To use the **Android Auto** app, the app must be installed on your Android device and the device must be connected to the car's USB input.

### **i** NOTE

For installation of Android Auto to be possible, the car must be equipped with two USB ports (USB hub)\*. If the car only has one USB port then it is not possible to use Android Auto.

### The first time an Android is connected

1. Connect your Android device to the USB input with a white frame.
2. Read the information in the pop-up window and then tap on **OK**.
3. Tap on **Android Auto** in the app view.
4. Read the terms and conditions and then tap on **Accept** to connect.
  - > The subview with Android Auto is opened and compatible apps are shown.
5. Tap on the desired app.
  - > The app starts.



### Previously connected Android

1. Connect your device to the USB input with a white frame.
  - > **If the setting for automatic start is selected** - the name of the device is shown.
2. Tap on the device name – the tile with Android Auto is opened and compatible apps are shown.
3. **If the setting for automatic start is not selected** - open the **Android Auto** app from the app view.
  - > The subview with Android Auto is opened and compatible apps are shown.
4. Tap on the desired app.
  - > The app starts.

Android Auto runs in the background if another app is started in the same subview. To show Android Auto in the subview again - tap on the Android Auto icon in the app view.

### Related information

- Android Auto\* (p. 510)
- Settings for Android Auto\* (p. 511)
- Connecting a device via USB port (p. 504)
- Voice recognition (p. 138)

### Settings for Android Auto\*

Settings for an Android device that has been connected the first time with **Android Auto**.

#### Automatic start

1. Press **Settings** in the top view.
2. Press **Communication** → **Android Auto** and select setting:
  - Tick the box - Android Auto starts automatically when the USB cable is connected.
  - Untick the box - Android Auto does not start automatically when the USB cable is connected.

A maximum of 20 Android devices can be stored in the list. When the list is full and a new device is connected the oldest one is deleted.

A factory reset has to be executed in order to clear the list.

#### System volumes

1. Press **Settings** in the top view.
2. Tap on **Sound** → **System Volumes** and make the settings for the following:
  - **Voice Control**
  - **Navi Voice Guidance**
  - **Phone Ringtone**

### Related information

- Android Auto\* (p. 510)
- Using Android Auto\* (p. 510)
- Resetting settings in the centre display (p. 127)

## Tips for using Android Auto\*

Here are some useful tips for using Android Auto.

- Ensure that your apps are updated.
- When starting the car, wait until the centre display has started, connect the device and then open Android Auto from the app view.
- In the event of problems with Android Auto, disconnect your Android device from the USB port and then reconnect via USB. Otherwise, try closing the app on the device and then restarting the app.
- When a device is connected to Android Auto it is still possible to playback media via Bluetooth to another media player. The Bluetooth function is on when Android Auto is used.
- If the icon for Android Auto is greyed out, this means no device is connected. When you connect your device the icon will be illuminated. If the icon is not visible at all then the car does not have support for connecting a device for this purpose.
- If the device is connected to the car via Bluetooth, the connection will be interrupted when Android Auto is used. Resume the Internet connection in the car by sharing the Internet via the Wi-Fi hotspot from the device.

- If the car is shared by a lot of people, such as in a car pool, it is worth noting that a maximum of 20 Android devices can be stored simultaneously. When the list is full and a new device is connected the oldest one is deleted. A factory reset has to be performed in order to clear the list.

### Related information

- Android Auto\* (p. 510)
- Connect the car to the Internet via a phone (Wi-Fi) (p. 523)

## Phone

A phone with Bluetooth can be connected wirelessly to the car's built-in hands-free system.

The audio and media system acts as hands-free, with the facility to remotely control a selection of the phone's functions. The phone can still be operated with its own keys even if it is connected to the car.

When a phone has been connected online and connected with the car, it can be used make calls, send/receive messages, play back media wirelessly and be used as an Internet connection.

The phone is operated from the centre display, but also via voice recognition and the app menu, which are accessed from the right-hand steering wheel keypad.

## Overview

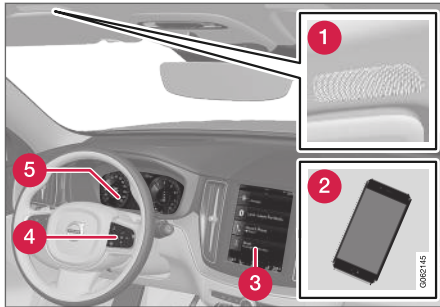

- 1 Microphone.
- 2 Phone.
- 3 Phone operation from centre display.
- 4 Keypad for operating phone functions that are shown in the driver display and voice recognition.
- 5 Driver display.

## Related information

- Managing phone calls (p. 517)
- Managing the phone book (p. 519)
- Managing text messages (p. 518)
- Connecting a phone to the car via Bluetooth for the first time (p. 513)

- Connecting a phone to the car via Bluetooth automatically (p. 515)
- Connecting a phone to the car via Bluetooth manually (p. 516)
- Disconnecting a Bluetooth-connected phone (p. 516)
- Switch between Bluetooth-connected phones (p. 516)
- Removing devices connected to Bluetooth (p. 517)
- Settings for phone (p. 520)
- Voice recognition (p. 138)
- Handling the application menu in the driver display (p. 97)
- Audio settings (p. 486)
- Connect the car to the Internet via a Bluetooth-enabled phone (p. 522)

## Connecting a phone to the car via Bluetooth for the first time

Connect a phone with Bluetooth activated to then be able to make calls from the car, send/receive messages, play back media wirelessly and connect the car to the Internet.

It is possible to have two Bluetooth devices connected at once, in which case one of them can only play back wirelessly. The most recently connected phone will automatically be connected to make calls, send/receive messages, play back media and provide an Internet connection. It is possible to change what the phone is to be used for under **Bluetooth Devices** via the settings menu in the centre display's top view. Your mobile phone needs to be equipped with Bluetooth and support tethering.

After the device has been connected/registered a first time via Bluetooth, it no longer needs to be visible/discoverable, but only have Bluetooth activated. A maximum of 20 connected Bluetooth devices can be stored in the car.

There are two options for connecting. Either search the phone from the car or search the car from the phone.

### Option 1 - search phone from car

1. Make the phone searchable/visible via Bluetooth.



2. Open the phone tile in the centre display.
  - If there is no phone connected to the car, tap on **Add phone**.
  - If there is a phone connected to the car, tap on **Change** . In the pop-up window, tap on **Add phone**.

> Available Bluetooth devices are listed. The list is updated as new devices are detected.
3. Tap on the name of the phone to be connected.
4. Check that the specified number code in the car matches that in the phone. In which case, choose to accept in both places.
5. On the phone, choose to accept or reject any options for phone contacts and messages.

**i NOTE**

- The message function must be activated in certain phones.
- Not all mobile phones are fully compatible and may therefore not show contacts and messages in the car.

**Option 2 - search car from phone**

1. Open the phone tile in the centre display.
  - If there is no phone connected to the car, tap on **Add phone** → **Make car discoverable**.
  - If there is a phone connected to the car, tap on **Change** . In the pop-up window, tap on **Add phone** → **Make car discoverable**.
2. Activate Bluetooth on the phone.
3. Search on the phone for Bluetooth devices.
 

> Available Bluetooth devices are listed.
4. Select the name of the car on the phone.
5. A pop-up window for the connection is shown in the car. Confirm the connection.
6. Check that the specified number code in the car matches the one shown in the external device. In which case, choose to accept in both places.
7. On the phone, choose to accept or reject any options for phone contacts and messages.

**i NOTE**

- The message function must be activated in certain phones.
- Not all mobile phones are fully compatible and may therefore not show contacts and messages in the car.

**i NOTE**

If the phone's operating system is updated then the connection may be broken. In which case, delete the phone from the car and then connect again.

**Compatible phones**

Many phones on the market now have wireless Bluetooth technology, but not all of them are fully compatible with the car.

For compatibility, see [support.volvocars.com](http://support.volvocars.com).

**Related information**

- Phone (p. 512)
- Connecting a phone to the car via Bluetooth automatically (p. 515)
- Connecting a phone to the car via Bluetooth manually (p. 516)
- Disconnecting a Bluetooth-connected phone (p. 516)
- Switch between Bluetooth-connected phones (p. 516)

- Removing devices connected to Bluetooth (p. 517)
- Settings for Bluetooth devices (p. 521)
- Internet-connected car\* (p. 521)
- Connect the car to the Internet via a Bluetooth-enabled phone (p. 522)

### **Connecting a phone to the car via Bluetooth automatically**

It is possible to connect a phone to the car automatically via Bluetooth. The phone has to have been connected to the car for the first time.

It is only the two last connected phones that can be connected automatically.

1. Activate Bluetooth in the phone before setting the car in ignition position **I**.
2. Set the car in ignition position **I** or higher.
  - > The phone will connect.

### **Related information**

- Phone (p. 512)
- Connecting a phone to the car via Bluetooth for the first time (p. 513)
- Connecting a phone to the car via Bluetooth manually (p. 516)
- Disconnecting a Bluetooth-connected phone (p. 516)
- Switch between Bluetooth-connected phones (p. 516)
- Removing devices connected to Bluetooth (p. 517)
- Settings for Bluetooth devices (p. 521)
- Internet-connected car\* (p. 521)
- Connect the car to the Internet via a Bluetooth-enabled phone (p. 522)

- Ignition positions (p. 428)

## Connecting a phone to the car via Bluetooth manually

It is possible to connect a phone to the car manually via Bluetooth. The phone has to have been connected to the car for the first time.

1. Activate Bluetooth on the phone.
2. Open the subview for phone.
  - > Connected phones are listed.
3. Tap on the name of the phone to be connected.
  - > The phone will connect.

### Related information

- Phone (p. 512)
- Connecting a phone to the car via Bluetooth for the first time (p. 513)
- Connecting a phone to the car via Bluetooth automatically (p. 515)
- Disconnecting a Bluetooth-connected phone (p. 516)
- Switch between Bluetooth-connected phones (p. 516)
- Removing devices connected to Bluetooth (p. 517)
- Settings for Bluetooth devices (p. 521)
- Internet-connected car\* (p. 521)
- Connect the car to the Internet via a Bluetooth-enabled phone (p. 522)

## Disconnecting a Bluetooth-connected phone

It is possible to disconnect a phone connected to Bluetooth, and it will then no longer be connected to the car.

- When the phone is out of range of the car it is automatically disconnected. If disconnection occurs during an active call, then the call will be continued on the phone.
- It is also possible to disconnect the phone by manually deactivating Bluetooth.

### Related information

- Phone (p. 512)
- Settings for phone (p. 520)
- Switch between Bluetooth-connected phones (p. 516)
- Removing devices connected to Bluetooth (p. 517)
- Settings for Bluetooth devices (p. 521)

## Switch between Bluetooth-connected phones

It is possible to switch between a number of Bluetooth-connected phones.

1. Open the tile for the phone.
2. Tap on **Change**  or drag down the top view and tap on **Settings** → **Communication** → **Bluetooth Devices** → **Add device**.
  - > Available Bluetooth devices are listed.
3. Tap on the phone to be connected.

### Related information

- Phone (p. 512)
- Connecting a phone to the car via Bluetooth for the first time (p. 513)
- Settings for Bluetooth devices (p. 521)
- Disconnecting a Bluetooth-connected phone (p. 516)
- Removing devices connected to Bluetooth (p. 517)

## Removing devices connected to Bluetooth

It is possible to remove phones from the list of registered Bluetooth devices, for example.

1. Press **Settings** in the top view.
2. Press **Communication** → **Bluetooth Devices**.
  - > Registered Bluetooth devices are listed.
3. Tap on the device to be removed.
4. Tap on **Remove device** and confirm your selection.
  - > The device is no longer registered to the car.

## Related information

- Phone (p. 512)
- Connecting a phone to the car via Bluetooth for the first time (p. 513)
- Disconnecting a Bluetooth-connected phone (p. 516)
- Switch between Bluetooth-connected phones (p. 516)
- Settings for Bluetooth devices (p. 521)

## Managing phone calls

Call handling in the car for a Bluetooth-connected phone.

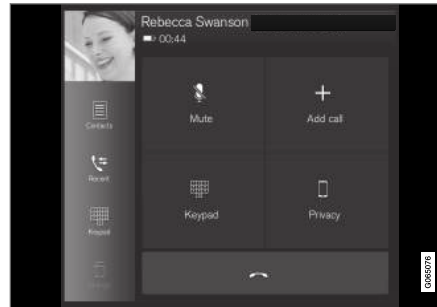

Generic illustration.

## Making phone calls

1. Open the subview for phone.
2. Select call from call history, enter number using the keypad or via the contact list. It is possible to search or browse in the contact list. Tap on ☆ in the contact list in order to add a contact under **Favourites**.
3. Press 📞 to make a call.
4. Tap on 📞 to end the call.

You can also make calls from the call log via the app menu, which is accessed from the right-hand steering wheel keypad 📞.

## Making multi-party calls

During a call:

1. Press **Add call**.
2. Choose to make a call from the call log, favourites or the contact list.
3. Tap on an entry/row in the call log, or tap on 📞 alongside the contact in the contact list.
4. Tap on **Swap call** to switch between the parties.
5. Tap on 📞 to end the active call.

## Conference calls

During an active multi-party call:

1. Tap on **Join calls** to merge the active multi-party call.
2. Tap on 📞 to end the call.

## Incoming phone calls

Incoming phone calls are shown in the driver display and the centre display. Manage the call on the right-hand steering wheel keypad or in the centre display.

1. Tap on **Answer/Reject**.
2. Tap on 📞 to end the call.

## Incoming phone call during an active call

1. Tap on **Answer/Reject**.
2. Tap on 📞 to end the call.

## ◀ Private call

- During the current call, press **Privacy** and select setting:
  - **Switch to mobile phone** - the hands-free function is disconnected and the call continues on your mobile phone.
  - **Driver focused** - the microphone in the roof on the passenger side is switched off and the call continues with the car's handsfree function.

## Related information

- Phone (p. 512)
- Connecting a phone to the car via Bluetooth for the first time (p. 513)
- Controlling a telephone with voice recognition (p. 140)
- Handling the application menu in the driver display (p. 97)
- Enter the characters, letters and words manually in the centre display (p. 122)
- Managing the phone book (p. 519)
- Managing text messages (p. 518)
- Audio settings (p. 486)

## Managing text messages<sup>9</sup>

Message handling in the car for a Bluetooth-connected phone.

In some phones, the message function must be activated. Not all phones are compatible. In such cases, they cannot display contacts and messages in the car. For compatibility, see [support.volvocars.com](http://support.volvocars.com).

### Managing text messages in the centre display

Text messages are only shown in the centre display if the setting is selected.

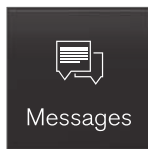

Press **Messages** in the app view to manage text messages in the centre display.

### Reading text messages in the centre display



Press the icon to get the message read aloud.

## Sending text messages in the centre display<sup>10</sup>

1. You can reply to a message or create a new message.
  - Reply to message — tap on the contact whose message you wish to reply to, then tap on **Answer**.
  - Create new message - tap on **Create new**. Select a contact or enter a number.
2. Compose the message.
3. Press **Send**.

## Managing text messages in the driver display

Text messages are only shown in the driver display if the setting is selected.

### Reading a new text message in the driver display

- To have the message read aloud – select **Read out** with the steering wheel keypad.

### Dictating a reply in the driver display

After the text message has been read out, it is possible to reply briefly with dictation if the car is connected to the Internet.

- Press **Answer** with the steering wheel keypad. A dictation dialogue starts.

<sup>9</sup> Valid in certain markets only. Contact a Volvo dealer for more information.

<sup>10</sup> Only certain phones can broadcast messages from the car. For compatibility, see [support.volvocars.com](http://support.volvocars.com).



## Message notification

It is possible to activate and deactivate notifications in the text message settings.

### Related information

- Phone (p. 512)
- Settings for text messages (p. 519)
- Settings for phone (p. 520)
- Internet-connected car\* (p. 521)
- Controlling a telephone with voice recognition (p. 140)
- Enter the characters, letters and words manually in the centre display (p. 122)
- Connecting a phone to the car via Bluetooth for the first time (p. 513)
- User terms and conditions and data sharing (p. 527)

## Settings for text messages

Settings for text messages on connected phone.

1. Press **Settings** in the top view.
2. Press **Communication** → **Text Messages** and select settings:
  - **Notification in centre display** - shows message notifications in the centre display's status bar.
  - **Notification in driver display** - displays notifications in the driver's display and incoming messages can be managed using the steering wheel's right-hand keypad.
  - **Text message tone** - select tone for incoming text messages.

### Related information

- Phone (p. 512)
- Connecting a phone to the car via Bluetooth for the first time (p. 513)
- Managing text messages (p. 518)
- Settings for phone (p. 520)

## Managing the phone book

When a phone is connected to the car with Bluetooth, contacts can be managed directly in the centre display.

Up to 3000 contacts can be shown from the phone selected in the centre display.



- 1 Browse between the letters and # to find a matching contact. Depending on existing contacts in the phone book, only matching letters are shown.
- 2 **Search contacts** - tap on to search for a phone number or name in the contact list.
- 3 **Favourites** - tap on to add/remove a contact to/from the favourites list.



## ◀ **Sorting**

The contact list is sorted in alphabetical order where special characters and numbers are sorted under **#**. It is possible to sort by first name or surname, and this setting is adjusted in the telephone setup.

### **Related information**

- Phone (p. 512)
- Settings for phone (p. 520)
- Controlling a telephone with voice recognition (p. 140)
- Enter the characters, letters and words manually in the centre display (p. 122)
- Connecting a phone to the car via Bluetooth for the first time (p. 513)

## **Settings for phone**

When the telephone is connected to the car, the following settings can be made:

1. Press **Settings** in the top view.
2. Press **Communication → Phone** and select settings:
  - **Ringtones** – selection of ring signal. It is possible to use a ring signal from the phone or the car. Some phones are not fully compatible and their ring signals may therefore not be available for use in the car.<sup>11</sup>
  - **Sort Order** - select sort order of contact list.

### **Call notifications in head up display\***

1. Tap on **Settings** in the centre display's top view.
2. Press **My Car → Displays → Head-Up Display Options**.
3. Select **Show Phone**.

### **Related information**

- Phone (p. 512)
- Settings for text messages (p. 519)
- Settings for Bluetooth devices (p. 521)

- Connecting a phone to the car via Bluetooth for the first time (p. 513)
- Head-up display\* (p. 135)
- Audio settings (p. 486)

<sup>11</sup> For compatibility, see support.volvocars.com.

## Settings for Bluetooth devices

Settings for Bluetooth-connected devices.

1. Press **Settings** in the top view.
2. Press **Communication** → **Bluetooth Devices** and select settings:
  - **Add device** - starts the pairing of a new device.
  - **Previously paired devices** - lists registered/paired devices.
  - **Remove device** - removes the connected device.
  - **Allowed services for this device** - sets device usage options: calling, sending/receiving messages, streaming media and as Internet connection.
  - **Internet connection** - connects the car to the Internet via the device's Bluetooth connection.

## Related information

- Phone (p. 512)
- Settings for phone (p. 520)
- Internet-connected car\* (p. 521)
- Connecting a phone to the car via Bluetooth for the first time (p. 513)

## Internet-connected car\*

When the car is connected to the Internet, it is possible – for example – to use web radio and music services via apps, download software and contact your retailer from the car.

The car is connected via Bluetooth, Wi-Fi or with the car's built-in modem\* (SIM card).

When the car is connected to the Internet, it is possible to share the car's Internet connection (Wi-Fi hotspot) so that other devices such as tablets can access the Internet<sup>12</sup>.

The Internet status is indicated by a symbol in the centre display's status bar.

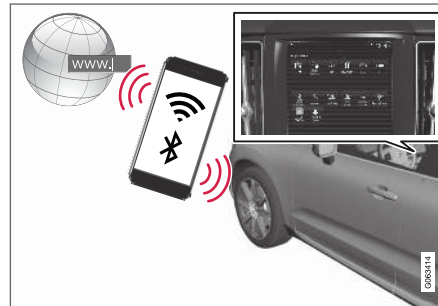

### **i** NOTE

Data is transferred when using the internet (data traffic), which can have a cost.

Activation of data roaming can result in further charges.

Contact your network operator about the cost for data traffic.

### **i** NOTE

When using Apple CarPlay, it is only possible to connect the car to the Internet using Wi-Fi or the car modem\*.

### **i** NOTE

When using Android Auto, it is possible to connect the car to the Internet using Wi-Fi, Bluetooth or the car modem\*.

Read **Terms and Conditions for Services** and **Customer Privacy Policy** at [support.volvocars.com](http://support.volvocars.com) before connecting the car to the Internet.

<sup>12</sup> This does not apply in the case of connection with Wi-Fi.

## ◀ Related information

- Symbols in the centre display's status bar (p. 117)
- Connect the car to the Internet via a Bluetooth-enabled phone (p. 522)
- Connect the car to the Internet via a phone (Wi-Fi) (p. 523)
- Connect the car to the Internet via car modem (SIM card) (p. 523)
- Apps (p. 488)
- No or poor Internet connection (p. 526)
- Sharing Internet access from the car via a Wi-Fi hotspot (p. 525)
- Remove Wi-Fi network (p. 526)
- Wi-Fi technologies and security (p. 527)
- Volvo ID (p. 26)
- User terms and conditions and data sharing (p. 527)

## Connect the car to the Internet via a Bluetooth-enabled phone

Create an Internet connection via Bluetooth by sharing your phone's Internet access and access several online services in the car.

1. To be able to connect the car to the Internet via a Bluetooth-connected phone, the phone has to have already been connected to the car via Bluetooth for a first time.
2. Make sure that your phone supports tethering and that this function is activated. On an iPhone, this function is known as "tethering". On Android phones, this function may have different names but is frequently known as "hotspot". For iPhones, the menu page "tethering" must also be open until the Internet connection has been established.
3. If the phone has been connected via Bluetooth previously, press **Settings** in the centre display top view.
4. Press **Communication** → **Bluetooth Devices**.
5. Tick the box for **Bluetooth Internet connection** under the heading **Internet connection**.
6. If another connection source has been used, confirm the option to change connection.
  - > Your car is now connected to the Internet via the Bluetooth-connected phone.

### NOTE

The telephone and network provider must support tethering (Internet connection sharing), and the subscription must include data.

### NOTE

When using Apple CarPlay, it is only possible to connect the car to the Internet using Wi-Fi or the car modem\*.

## Related information

- Internet-connected car\* (p. 521)
- Connect the car to the Internet via car modem (SIM card) (p. 523)
- Connecting a phone to the car via Bluetooth for the first time (p. 513)
- Connect the car to the Internet via a phone (Wi-Fi) (p. 523)
- Apple® CarPlay®\* (p. 506)
- No or poor Internet connection (p. 526)
- Settings for Bluetooth devices (p. 521)

## Connect the car to the Internet via a phone (Wi-Fi)

Create an Internet connection via Wi-Fi by tethering your phone and access online services in the car.

1. Make sure that your phone supports tethering and that this function is activated. On an iPhone, this function is known as "tethering". On Android phones, this function may have different names but is frequently known as "hotspot". For iPhones, the menu page "tethering" must also be open until the Internet connection has been established.
2. Press **Settings** in the top view.
3. Continue to **Communication** → **Wi-Fi**.
4. Activate/deactivate by ticking/unticking the box for Wi-Fi.
5. If another connection source has been used, confirm the option to change connection.
6. Tap on the network name of the network to be connected.
7. Enter the network password.
  - > The car connects to the network.

Note that certain phones switch off tethering after the contact with the car has been disconnected, e.g. when leaving the car and until the next time it is used. The tethering in the phone

therefore needs to be reactivated the next time it is used.

When a phone is connected to the car, it is saved for future use. To show a list of saved networks or manually delete saved networks, go to

**Settings** → **Communication** → **Wi-Fi** → **Saved networks**.

### **NOTE**

The telephone and network provider must support tethering (Internet connection sharing), and the subscription must include data.



Technical and safety requirements for Wi-Fi connection, are described in a separate section.

### Related information

- Internet-connected car\* (p. 521)
- Remove Wi-Fi network (p. 526)
- No or poor Internet connection (p. 526)
- Wi-Fi technologies and security (p. 527)

## Connect the car to the Internet via car modem (SIM card)

It is possible to establish an Internet connection via the car modem and a personal SIM card (P-SIM)\*.

Cars equipped with Volvo On Call will use the Internet connection with car modem for the services.

- 1.

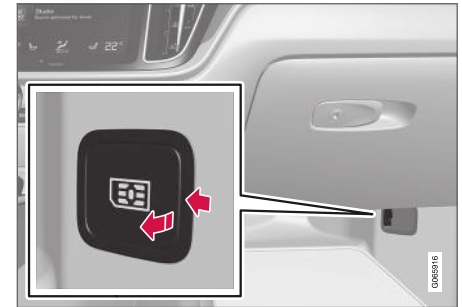

Fit a personal SIM card into the holder by the floor on the passenger side.

Note that a **mini SIM** is required to fit the car's card reader.

2. Press **Settings** in the top view.
3. Press **Communication** → **Car Modem Internet**.



4. Activate/deactivate by ticking/unticking the box for **Car modem Internet**.
5. If another connection source has been used, confirm the option to change connection.
6. Enter the SIM card's PIN code.
  - > The car connects to the network.

#### Related information

- Internet-connected car\* (p. 521)
- No or poor Internet connection (p. 526)
- Settings for car modem\* (p. 524)

#### Settings for car modem\*

The car is equipped with a modem that can be used to connect the car to the Internet. It is also possible to share the Internet connection via Wi-Fi.

1. Press **Settings** in the top view.
2. Press **Communication** → **Car Modem Internet** and select settings:
  - **Car modem Internet** - select whether to use the car modem as Internet connection.
  - **Data usage** - tap on **Reset** resets the counters for received and sent data volume.
  - **Network**
    - Select network operator** - automatic or manual selection of network operator.
    - Data roaming** - if the box is ticked, the car modem will attempt to connect to the Internet when the car is abroad and outside its home network. Note that this may result in heavy costs. Check your roaming agreement for data traffic abroad with your network provider in your home country.
  - **SIM card PIN**
    - Change PIN** - a maximum of 4 digits can be entered.
    - Disable PIN** - select whether the PIN code shall be required for access to the SIM card.

- **Send request code** — used e.g. to top up or check the balance on a prepaid card. Functionality depends on the provider.

#### Related information

- Connect the car to the Internet via car modem (SIM card) (p. 523)
- No or poor Internet connection (p. 526)

## Sharing Internet access from the car via a Wi-Fi hotspot

When the car is online, its Internet connection can be shared to allow other devices to use the Internet connection<sup>13</sup>.

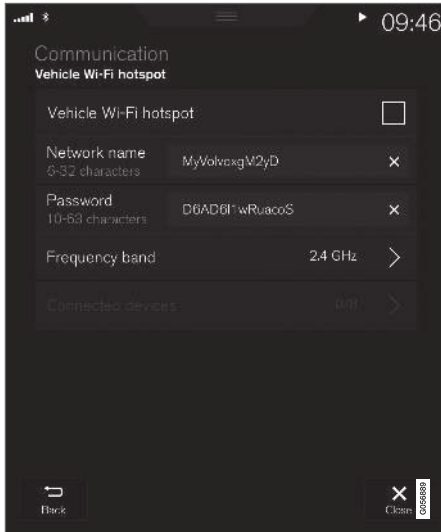

The network operator (SIM card) must support tethering (sharing of the Internet connection).

1. Press **Settings** in the top view.
2. Press **Communication** → **Car Wi-Fi Hotspot**.
3. Tap on **Network name** and name the shared connection.
4. Tap on **Password** and select a password to be entered on connecting devices.
5. Tap on **Frequency band** and select the frequency on which the hotspot is to transmit data. Note that selection of frequency band is not available in all markets.
6. Activate/deactivate by ticking/unticking the box for **Car Wi-Fi Hotspot**.
7. If Wi-Fi has been used as a connection source, confirm the option to change connection.
  - > It is now possible for external devices to connect to the car's tethering (Wi-Fi hotspot).

### **i** NOTE

Activation of Wi-Fi-hotspot can result in further charges from your network operator.

Contact your network operator about the cost for data traffic.

Connection status is indicated by the symbol in the centre display's status bar.

Press **Connected devices** to see a list of the currently connected devices.

### Related information

- Symbols in the centre display's status bar (p. 117)
- Internet-connected car\* (p. 521)
- No or poor Internet connection (p. 526)

<sup>13</sup> Does not apply when the car is online via Wi-Fi.

## No or poor Internet connection

Factors that affect the Internet connection.

The amount of data transferred is dependent on the services or apps in use in the car. For example, streaming audio can require large amounts of data which requires a good connection and good signal strength.

### Phone to car

The speed of the Internet connection may vary depending on the location of the phone in the car. Move the phone closer to the centre display in order to increase the signal strength. Ensure that there is no source of interference in between.

### Phone to network operator

The speed of the mobile network varies depending on the coverage in the present location. Poor network coverage may occur, for example in tunnels, in mountainous country, in deep valleys or indoors. The speed also depends on the agreement you have with your network.

#### NOTE

In the event of problems with data traffic, contact your network operator.

## Restarting the phone

If there are problems with the Internet connection then it may help to restart the phone.

## Related information

- Internet-connected car\* (p. 521)
- Wi-Fi technologies and security (p. 527)

## Remove Wi-Fi network

Removing a network that is not to be used.

1. Press **Settings** in the top view.
2. Continue to **Communication** → **Wi-Fi** → **Saved networks**.
3. Tap on **Forget** alongside the network to be removed.
4. Confirm the selection.
  - > The car will no longer connect to the network in future.

## Remove all networks

All networks can be removed simultaneously by restoring factory settings. Please note that all user data and system settings are reset to original factory settings.

## Related information

- Internet-connected car\* (p. 521)
- No or poor Internet connection (p. 526)
- Resetting settings in the centre display (p. 127)
- Connect the car to the Internet via a phone (Wi-Fi) (p. 523)



## Wi-Fi technologies and security

Possible network types to connect to.

It is only possible to connect to the following types of network:

- Frequency — 2.4 or 5 GHz<sup>14</sup>.
- Standards — 802.11 a/b/g/n.
- Security type - WPA2-AES-CCMP.

The car's Wi-Fi system is designed to handle Wi-Fi devices inside the car.

If several devices operate on the frequency at the same time then it may result in reduced performance.

### Related information

- Internet-connected car\* (p. 521)

## User terms and conditions and data sharing

The first time certain services and apps are started, a pop-up window with the headings **Terms and conditions** and **Data sharing** may be shown.

The purpose is to inform about Volvo's user terms and conditions and policy for data sharing. By accepting data sharing, the user accepts that certain information is sent from the car. This is required so that certain services and apps can have full functionality.

The data sharing function for online services and apps is deactivated by default. Data sharing needs to be activated so that certain online services and apps in the car can be used. Data sharing can be set from the centre display's settings menu.

### NOTE

Privacy and data sharing settings are unique for every driver profile.

### Related information

- Activating and deactivating data sharing (p. 527)

## Activating and deactivating data sharing

Data sharing for services and apps required can be set in the centre display's settings menu.

1. Press **Settings** in the top view in the centre display.
2. Press **System** → **Privacy and data**.
3. Select activation or deactivation of data sharing for individual services and all apps.

If data sharing has not been activated for an online service or downloaded apps, this can be done when they are started in the centre display. If this is the first time a service is started, or e.g. after a factory reset or certain software updates, Volvo's terms and conditions for online services need to be approved. Note that data sharing will then also be activated for other services or apps for which sharing has already been approved.

### NOTE

After a visit to a Volvo workshop, you may need to reactivate data sharing so that the online services and apps shall work again.

### Related information

- User terms and conditions and data sharing (p. 527)

<sup>14</sup> Selection of frequency is not available on all markets.

## **Storage space on hard disk**

It is possible to view how much free space there is on the car's hard disk.

Storage information for the car's hard disk, including total capacity, available capacity and how much space is used for installed apps can be shown. The information is available under

**Settings → System → System Information → Storage.**

### **Related information**

- Apps (p. 488)

## License agreement for audio and media

A license is an agreement for the right to operate a certain activity or the right to use someone else's entitlement according to the terms and conditions in the agreement. The following texts are Volvo's agreements with manufacturers/developers.

### Bowers & Wilkins

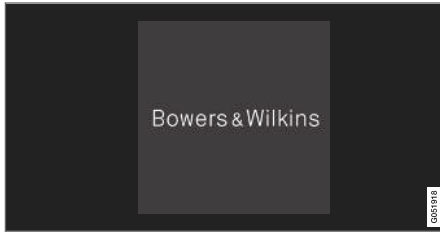

Bowers & Wilkins and B&W are trademarks of the B&W Group Ltd. Nautilus is a trademark of B&W Group Ltd. Kevlar is a registered trademark of DuPont.

### Dirac Unison®



Dirac Unison co-optimises the loudspeakers in frequency, time and space for the best possible bass integration and clarity. It enables a faithful reproduction of the acoustic characteristics of specific performance venues. Using advanced algorithms, Dirac Unison controls all loudspeakers digitally based on acoustic high-precision measurements. Like a conductor of an orchestra, it guarantees that the loudspeakers perform in perfect unison.

### DivX®



DivX®, DivX Certified® and associated logotypes are trademarks belonging to DivX, LLC and are used under licence.

This DivX Certified® device can play back DivX® Home Theater video files up to 576p (including .avi, .divx). Download free software on [www.divx.com](http://www.divx.com) to create, play back and stream digital video.

**ABOUT DIVX VIDEO-ON-DEMAND:** This DivX Certified® device must be registered in order to play back purchased DivX Video-on-Demand (VOD) films. Get the registration code by locating the DivX VOD section in the device's settings menu. Go to [vod.divx.com](http://vod.divx.com) for more information on how to complete the registration.

### Patent numbers

Protected by one or more of the following US patents. 7,295,673; 7,460,668; 7,515,710; 8,656,183; 8,731,369; RE45,052.

### Gracenote®



- ◀◀ Parts of the content are copyright © of Gracenote or its suppliers.

Gracenote, Gracenote logo and logotype, "Powered by Gracenote" and Gracenote MusicID are either registered trademarks or trademarks of Gracenote, Inc. in the USA and/or other countries.

### **Gracenote® End User License Agreement**

This program or device contains software from Gracenote, Inc. of Emeryville, California, USA ("Gracenote"). The software from Gracenote ("Gracenote software") activates this program to perform disc and/or file identification and obtain music-related information, including name, artist, track and title ("Gracenote data") from online servers or embedded databases (together called "Gracenote servers") and in order to perform other actions. You may only use Gracenote data in accordance with the intended end-user functions for this program or this device.

You agree to only use Gracenote data, Gracenote software and Gracenote servers for your own personal non-commercial use. You agree not to assign, copy, transfer or transmit this Gracenote software or any Gracenote data to any third party. YOU AGREE NOT TO USE OR EXPLOIT GRACENOTE DATA, GRACENOTE SOFTWARE OR GRACENOTE SERVERS, EXCEPT AS EXPRESSLY PERMITTED IN THIS AGREEMENT.

You agree that your non-exclusive right to use Gracenote data, Gracenote software and Grace-

note servers will be terminated if you violate these restrictions. If your license is terminated you agree to cease all use of Gracenote data, Gracenote software and Gracenote servers. Gracenote holds exclusive rights to all Gracenote data, all Gracenote software and all Gracenote servers, including all ownership rights. Gracenote will under no circumstances have any obligation to pay you for any information you provide. You agree that Gracenote, Inc. may enforce the company's rights under this agreement against you directly in its own name.

The Gracenote service uses a unique identifier to track enquiries for statistical purposes. The purpose of a randomly assigned numeric identifier is to enable the Gracenote service to count enquiries without knowing anything about who you are. Additional information is available on the web page for Gracenote's privacy policy for the Gracenote service.

The Gracenote software and everything included in Gracenote data are licensed to you "as is". Gracenote provides no undertakings or warranties, express or implied, as to the accuracy of the Gracenote data contained in the Gracenote servers. Gracenote reserves the right to delete data from the Gracenote servers or to change data categories for any reason that Gracenote deems sufficient. No warranty is provided that the Gracenote software or Gracenote servers are fault-free or that the Gracenote software or Gracenote servers will operate without interruption. Grace-

note has no obligation to provide you with new, improved or additional data types or categories that Gracenote may provide in the future, and the company reserves the right to discontinue its services at any time.

GRACENOTE DISCLAIMS ALL WARRANTIES, EITHER EXPRESS OR IMPLIED, INCLUDING, BUT NOT LIMITED TO, THE IMPLIED WARRANTIES OF MERCHANTABILITY, FITNESS FOR A PARTICULAR PURPOSE, TITLE AND NON-INFRINGEMENT OF INTELLECTUAL PROPERTY RIGHTS. GRACENOTE DOES NOT GUARANTEE THE RESULTS OBTAINED THROUGH YOUR USE OF THE GRACENOTE SOFTWARE OR A GRACENOTE SERVER. GRACENOTE WILL IN NO EVENT BE LIABLE FOR ANY CONSEQUENTIAL DAMAGE OR FOR ANY LOST PROFITS OR REVENUES.

© Gracenote, Inc. 2009

### **Sensus software**

This software uses parts of sources from clib2 and Prex Embedded Real-time OS - Source (Copyright (c) 1982, 1986, 1991, 1993, 1994), and Quercus Robusta (Copyright (c) 1990, 1993), The Regents of the University of California. All or some portions are derived from material licensed to the University of California by American Telephone and Telegraph Co. or Unix System Laboratories, Inc. and are reproduced herein with the permission of UNIX System Laboratories, Inc. Redistribution and use in

source and binary forms, with or without modification, are permitted provided that the following conditions are met: Redistributions of source code must retain the above copyright notice, this list of conditions and the following disclaimer. Redistributions in binary form must reproduce the above copyright notice, this list of conditions and the following disclaimer in the documentation and/or other materials provided with the distribution. Neither the name of the <ORGANIZATION> nor the names of its contributors may be used to endorse or promote products derived from this software without specific prior written permission. THIS SOFTWARE IS PROVIDED BY THE COPYRIGHT HOLDERS AND CONTRIBUTORS "AS IS" AND ANY EXPRESS OR IMPLIED WARRANTIES, INCLUDING, BUT NOT LIMITED TO, THE IMPLIED WARRANTIES OF MERCHANTABILITY AND FITNESS FOR A PARTICULAR PURPOSE ARE DISCLAIMED. IN NO EVENT SHALL THE COPYRIGHT OWNER OR CONTRIBUTORS BE LIABLE FOR ANY DIRECT, INDIRECT, INCIDENTAL, SPECIAL, EXEMPLARY, OR CONSEQUENTIAL DAMAGES (INCLUDING, BUT NOT LIMITED TO, PROCUREMENT OF SUBSTITUTE GOODS OR SERVICES; LOSS OF USE, DATA, OR PROFITS; OR BUSINESS INTERRUPTION) HOWEVER CAUSED AND ON ANY THEORY OF LIABILITY, WHETHER IN CONTRACT, STRICT LIABILITY, OR TORT (INCLUDING NEGLIGENCE OR OTHERWISE) ARISING IN ANY WAY OUT OF THE USE OF

THIS SOFTWARE, EVEN IF ADVISED OF THE POSSIBILITY OF SUCH DAMAGE.

This software is based in part on the work of the Independent JPEG Group.

This software uses parts of sources from "libtess". The Original Code is: OpenGL Sample Implementation, Version 1.2.1, released January 26, 2000, developed by Silicon Graphics, Inc. The Original Code is Copyright (c) 1991-2000 Silicon Graphics, Inc. Copyright in any portions created by third parties is as indicated elsewhere herein. All Rights Reserved. Copyright (C) [1991-2000] Silicon Graphics, Inc. All Rights Reserved. Permission is hereby granted, free of charge, to any person obtaining a copy of this software and associated documentation files (the "Software"), to deal in the Software without restriction, including without limitation the rights to use, copy, modify, merge, publish, distribute, sublicense, and/or sell copies of the Software, and to permit persons to whom the Software is furnished to do so, subject to the following conditions: The above copyright notice including the dates of first publication and either this permission notice or a reference to <http://oss.sgi.com/projects/FreeB/> shall be included in all copies or substantial portions of the Software. THE SOFTWARE IS PROVIDED "AS IS", WITHOUT WARRANTY OF ANY KIND, EXPRESS OR IMPLIED, INCLUDING BUT NOT LIMITED TO THE WARRANTIES OF MERCHANTABILITY, FITNESS FOR A

PARTICULAR PURPOSE AND NONINFRINGEMENT. IN NO EVENT SHALL SILICON GRAPHICS, INC. BE LIABLE FOR ANY CLAIM, DAMAGES OR OTHER LIABILITY, WHETHER IN AN ACTION OF CONTRACT, TORT OR OTHERWISE, ARISING FROM, OUT OF OR IN CONNECTION WITH THE SOFTWARE OR THE USE OR OTHER DEALINGS IN THE SOFTWARE. Except as contained in this notice, the name of Silicon Graphics, Inc. shall not be used in advertising or otherwise to promote the sale, use or other dealings in this Software without prior written authorization from Silicon Graphics, Inc.

This software is based in parts on the work of the FreeType Team.

This software uses parts of SSLeay Library: Copyright (C) 1995-1998 Eric Young (eay@cryptsoft.com). All rights reserved

### Linux software

This product contains software licensed under GNU General Public License (GPL) or GNU Lesser General Public License (LGPL), etc.

You have the right of acquisition, modification, and distribution of the source code of the GPL/LGPL software.

You may download Source Code from the following website at no charge: [http://www.embedded-carmultimedia.jp/linux/oss/download/TVM\\_8351\\_013](http://www.embedded-carmultimedia.jp/linux/oss/download/TVM_8351_013)



- ◀◀ The website provides the Source Code "As Is" and without warranty of any kind.

By downloading Source Code, you expressly assume all risk and liability associated with downloading and using the Source Code and complying with the user agreements that accompany each Source Code.

Please note that we cannot respond to any inquiries regarding the source code.

### **camellia:1.2.0**

Copyright (c) 2006, 2007

NTT (Nippon Telegraph and Telephone Corporation). All rights reserved.

Redistribution and use in source and binary forms, with or without modification, are permitted provided that the following conditions are met:

1. Redistributions of source code must retain the above copyright notice, this list of conditions and the following disclaimer as the first lines of this file unmodified.
2. Redistributions in binary form must reproduce the above copyright notice, this list of conditions and the following disclaimer in the documentation and/or other materials provided with the distribution.

THIS SOFTWARE IS PROVIDED BY NTT "AS IS" AND ANY EXPRESS OR IMPLIED WARRANTIES, INCLUDING, BUT NOT LIMITED TO, THE IMPLIED WARRANTIES OF MERCHANTABILITY AND FITNESS FOR A

PARTICULAR PURPOSE ARE DISCLAIMED. IN NO EVENT SHALL NTT BE LIABLE FOR ANY DIRECT, INDIRECT, INCIDENTAL, SPECIAL, EXEMPLARY, OR CONSEQUENTIAL DAMAGES (INCLUDING, BUT NOT LIMITED TO, PROCUREMENT OF SUBSTITUTE GOODS OR SERVICES; LOSS OF USE, DATA, OR PROFITS; OR BUSINESS INTERRUPTION) HOWEVER CAUSED AND ON ANY THEORY OF LIABILITY, WHETHER IN CONTRACT, STRICT LIABILITY, OR TORT (INCLUDING NEGLIGENCE OR OTHERWISE) ARISING IN ANY WAY OUT OF THE USE OF THIS SOFTWARE, EVEN IF ADVISED OF THE POSSIBILITY OF SUCH DAMAGE.

### **Unicode: 5.1.0**

COPYRIGHT AND PERMISSION NOTICE

Copyright c 1991-2013 Unicode, Inc. All rights reserved. Distributed under the Terms of Use in <http://www.unicode.org/copyright.html>.

Permission is hereby granted, free of charge, to any person obtaining a copy of the Unicode data files and any associated documentation (the "Data Files") or Unicode software and any associated documentation (the "Software") to deal in the Data Files or Software without restriction, including without limitation the rights to use, copy, modify, merge, publish, distribute, and/or sell copies of the Data Files or Software, and to permit persons to whom the Data Files or Software are furnished to do so, provided that (a)



the above copyright notice(s) and this permission notice appear with all copies of the Data Files or Software, (b) both the above copyright notice(s) and this permission notice appear in associated documentation, and (c) there is clear notice in each modified Data File or in the Software as well as in the documentation associated with the Data File(s) or Software that the data or software has been modified.

THE DATA FILES AND SOFTWARE ARE PROVIDED "AS IS", WITHOUT WARRANTY OF ANY KIND, EXPRESS OR IMPLIED, INCLUDING BUT NOT LIMITED TO THE WARRANTIES OF MERCHANTABILITY, FITNESS FOR A PARTICULAR PURPOSE AND NONINFRINGEMENT OF THIRD PARTY RIGHTS. IN NO EVENT SHALL THE COPYRIGHT HOLDER OR HOLDERS INCLUDED IN THIS NOTICE BE LIABLE FOR ANY CLAIM, OR ANY SPECIAL INDIRECT OR CONSEQUENTIAL DAMAGES, OR ANY DAMAGES WHATSOEVER RESULTING FROM LOSS OF USE, DATA OR PROFITS, WHETHER IN AN ACTION OF CONTRACT, NEGLIGENCE OR OTHER TORTIOUS ACTION, ARISING OUT OF OR IN CONNECTION WITH THE USE OR PERFORMANCE OF THE DATA FILES OR SOFTWARE.

Except as contained in this notice, the name of a copyright holder shall not be used in advertising or otherwise to promote the sale, use or other

dealings in these Data Files or Software without prior written authorization of the copyright holder.

## Declaration of Conformity

 <p><b>MITSUBISHI ELECTRIC</b> C/O: 10-3-1, 1st Fl., Eki-cho</p>	<p><b>MITSUBISHI ELECTRIC CORPORATION</b> SANDA WORKS 2-3-33, Miva, Sanda-city, Hyogo, 669-1513, Japan www.mitsubishielectric.com</p>
<p><b>DECLARATION OF CONFORMITY</b> For</p>	
	<p>Product: Audio Navigation Unit Model: NR-0V</p>
<p>Supplied by Mitsubishi Electric Corporation Sanda Works 2-3-33, Miva, Sanda-city, Hyogo, 669-1513, Japan</p>	<p>Technical File-hold by Mitsubishi Electric Corporation Sanda Works 2-3-33, Miva, Sanda-city, Hyogo, 669-1513, Japan</p>
<p><b>RATTE Directive</b> (Safety)</p>	<p><b>Standard used for comply</b> EN 60950-1:2006 + Amd.1: 2009 + Amd.1: 2010 + Amd.2: 2011 + Amd.2: 2013 EN 62479:2011</p>
<p><b>RF Directive</b> (EMC)</p>	<p>EN 301 488-1 V2.1.1:2017-03 EN 301 488-17 V3.3.1:2017-02</p>
<p><b>RF Directive</b> (Spectrum)</p>	<p>EN 300 328 V2.2.1:2016-11 EN 303 345 V1.1.7:2017-03(Final Draft)</p>
<p><b>Means of Conformity</b> We declare under our sole responsibility that the Product(s) is conformity with the essential requirements and other relevant requirements of the Radio Equipment (RE) Directive (2014/53/EU).</p>	
<p>Date of issue: May 30, 2017</p>	
<p>Signature of Responsible Person:</p>	 <hr/> <p>Hirotsugu Mizuno Senior Manager Design B Car Multimedia Manufacturing A Dept. MITSUBISHI ELECTRIC CORPORATION SANDA WORKS Mimato,hirotsugu@mitsubishielectric.co.jp</p>



Country/ Area	
Brazil:	<div data-bbox="220 208 363 353" data-label="Image"> </div> <p data-bbox="220 374 1437 421">Este equipamento opera em caráter secundário isto e, não tem direito a proteção contra interferência prejudicial, mesmo tipo, e não pode causar interferência a sistemas operando em caráter primário.</p> <p data-bbox="220 437 571 460">Para consultas, visite: <a href="http://www.anatel.gov.br">www.anatel.gov.br</a></p>
EU:	<div data-bbox="220 482 296 555" data-label="Image"> </div> <p data-bbox="220 577 1209 600">Manufacturer: Mitsubishi Electric Corporation Sanda Works 2-3-33, Miwa, Sanda-city. Hyogo, 669-1513, Japan</p> <p data-bbox="220 611 1485 633">Mitsubishi Electric Corporation hereby declares that this type of radio equipment [Audio Navigation Unit] conforms with directive 2014/53/EU.</p> <p data-bbox="220 645 651 667">For more information, see <a href="http://support.volvocars.com">support.volvocars.com</a>.</p>
The United Arab Emirates:	<div data-bbox="220 695 363 835" data-label="Image"> </div>



Country/ Area	
Kazakh- stan:	 <p data-bbox="220 374 619 471">Model name: NR 0V Manufacturer: Mitsubishi Electric Corporation Exporting country: Japan</p>



Country/ Area	
China:	<p>1.</p> <ul style="list-style-type: none"> <li>■ 使用频率：2.4 - 2.4835 GHz</li> <li>■ 等效全向辐射功率 (EIRP)： 天线增益 &lt; 10dBi 时：≤100 mW 或 ≤20 dBm ①</li> <li>■ 最大功率谱密度： 天线增益 &lt; 10dBi 时：≤20 dBm / MHz (EIRP) ①</li> <li>■ 载频容限：20 ppm</li> <li>■ 带外发射功率 (在 2.4-2.4835GHz 频段以外) ≤-80 dBm / Hz (EIRP)</li> <li>■ 杂散发射 (辐射) 功率 (对应载波 ±2.5 倍信道带宽以外)： <ul style="list-style-type: none"> <li>• ≤-36 dBm / 100 kHz (30 - 1000 MHz)</li> <li>• ≤-33 dBm / 100 kHz (2.4 - 2.4835 GHz)</li> <li>• ≤-40 dBm / 1 MHz (3.4 - 3.53 GHz)</li> <li>• ≤-40 dBm / 1 MHz (5.725 - 5.85 GHz)</li> <li>• ≤-30 dBm / 1 MHz (其它 1 - 12.75 GHz)</li> </ul> </li> </ul> <p>2. 不得擅自更改发射频率、加大发射功率 (包括额外加装射频功率放大器)，不得擅自外接天线或改用其它发射天线；</p> <p>3. 使用时不得对各种合法的无线电电信业务产生有害干扰；一旦发现有害干扰现象时，应立即停止使用，并采取措施消除干扰后方可继续使用；</p> <p>4. 使用微功率无线电设备，必须忍受各种无线电业务的干扰或工业、科学及医疗应用设备的辐射干扰；</p> <p>5. 不得在飞机和机场附近使用。</p>

Country/ Area	
Korea:	<p>B 급 기기 (가정용 방송통신기자재)</p> <p>이 기기는 가정용(B 급) 전자파적합기기로서 주로 가정에서 사용하는 것을 목적으로 하며, 모든 지역에서 사용할 수 있습니다.</p> <p>해당 무선설비는 전파혼신 가능성이 있으므로 인명안전과 관련된 서비스는 할 수 없습니다.</p>
Malaysia	<div data-bbox="220 404 363 549" data-label="Image"> </div> <p>This device has been certified under the Communications &amp; Multimedia Act of 1998, Communications and Multimedia (Technical Standards) Regulations 2000. To retrieve your device's serial number, please visit (<a href="http://support.volvocars.com">support.volvocars.com</a>) and search for "SIRIM Label Verification".</p> <p>Device category: Navigation equipment for vehicle (Bluetooth)</p> <p>Model: NR-0V</p> <p>Type Approval No.: RBAY/18A/1015S(15-4067)</p>



Country/ Area	
Mexico:	
Taiwan:	<p>低功率電波輻射性電機管理辦法</p> <p>第十二條</p> <p>經型式認證合格之低功率射頻電機，非經許可，公司、商號或使用者均不得擅自變更頻率、加大功率或變更原設計之特性及功能。</p> <p>第十四條</p> <p>低功率射頻電機之使用不得影響飛航安全及干擾合法通信；經發現有干擾現象時，應立即停用，改善至無干擾時方得繼續使用。前項合法通信，指依電信法規定作業之無線電通信。低功率射頻電機須忍受合法通信或工業、科學及醫療用電波輻射性電機設備之干擾。</p>

### Related information

- Sound, media and Internet (p. 486)
- Internet-connected car\* (p. 521)
- Media player (p. 497)
- Gracenote® (p. 501)
- Sensus - online connectivity and entertainment (p. 32)

ECALL

## eCall<sup>1</sup>

The car can detect an accident and contact the nearest emergency call centre itself.

For cars without Volvo On Call\* there is a European legal requirement, Pan-European eCall, that provides access to an automatic collision alarm and urgent assistance in emergency situations.

### Related information

- Automatic collision alarm with eCall (p. 540)
- Emergency assistance with eCall (p. 540)
- Roadside Assistance (p. 541)

## Automatic collision alarm with eCall<sup>2</sup>

If a collision occurs, the car reports this automatically to the closest emergency call centre, which can send out emergency assistance.

When the car's safety system is triggered, e.g. in an accident in which the activation level is reached for the seatbelt tensioner or airbags, a signal will be automatically sent to the closest emergency call centre.

1. A message, containing car position<sup>2</sup>, etc., is sent automatically from the car to the emergency call centre.
2. The emergency call centre establishes verbal contact with the car's driver and tries to find out the extent of the collision and the need for help.
3. The emergency call centre sends the necessary assistance (police, ambulance, towing, etc.).

If verbal contact cannot be established, the emergency call centre knows the car's position and can assist with appropriate action.

### Related information

- eCall (p. 540)
- Emergency assistance with eCall (p. 540)
- Roadside Assistance (p. 541)

## Emergency assistance with eCall<sup>3</sup>

Press the **SOS** button to contact a service centre, or the closest emergency call centre in an emergency situation.

To summon help in case of illness, external threats to the car or passengers, the closest emergency call centre can be alerted manually by depressing the **SOS** button for at least 2 seconds. The emergency call centre is notified and told of the car's position<sup>3</sup>, etc., and attempts to establish verbal contact with the driver in order to agree what assistance is needed.

### NOTE

The **SOS** button is only designed for emergencies and must only be used in the event of an accident, illness or an external threat to the car and its passengers. The **ON CALL** button must be used in the event of problems with the car.

### Related information

- eCall (p. 540)
- Automatic collision alarm with eCall (p. 540)
- Roadside Assistance (p. 541)

<sup>1</sup> Applies to certain markets.

<sup>2</sup> Applies to certain markets.

## Roadside Assistance<sup>4</sup>

Summon assistance if you have problems with the car by pressing the **ON CALL** button in the car's roof.

Press the **ON CALL** button in the car's roof for at least 2 seconds if you have a puncture, run out of fuel or your battery runs out of charge, for example. Verbal contact is established with a roadside assistance company that can send help to the car.

### Related information

- eCall (p. 540)
- Automatic collision alarm with eCall (p. 540)
- Emergency assistance with eCall (p. 540)

---

<sup>3</sup> Applies to certain markets.

<sup>4</sup> Applies to certain markets.





# WHEELS AND TYRES

### Tyres

Amongst other things, the function of the tyres is to carry load, provide grip on the road surface, dampen vibration and protect the wheel from wear.

The tyres greatly affect the car's driving characteristics. The type of tyre, dimensions, tyre pressure and speed rating are important for how the car performs.

The car is fitted with tyres according to the tyre information sticker found on the driver's side door pillar (between the front door and the rear door).

#### **WARNING**

A damaged tyre may lead to loss of control over the car.

### Recommended tyres

On delivery, the car is equipped with Volvo original tyres that have the VOL<sup>1</sup> marking on the side of the tyres. These tyres are carefully adapted to the car. In the event of changing tyres, it is therefore important that the new tyres also have this marking in order for the car's driving characteristics, comfort and fuel consumption to be maintained.

<sup>1</sup> There may be deviations for certain tyre dimensions.

### New tyres

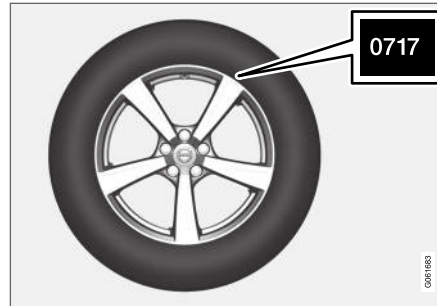

Tyres are perishable. After a few years they begin to harden at the same time as the friction capacity/characteristics gradually deteriorate. For this reason, aim to get as fresh tyres as possible when you replace them. This is especially important with regard to winter tyres. The last four digits in the sequence mean the week and year of manufacture. This is the tyre's DOT marking (Department of Transportation), and this is stated with four digits, for example 0717. The tyre is then manufactured in week 07, year 2017.

### Tyre age

All tyres older than 6 years old should be checked by an expert even if they seem undamaged. Tyres age and decompose, even if they are hardly ever or never used. The function can therefore be affected. This applies to all tyres that

are stored for future use. Examples of external signs which indicate that the tyre is unsuitable for use are cracks or discolouration.

### Tyre economy

- Maintain the correct tyre pressure.
- Avoid fast starts, heavy braking and squealing tyres.
- Tyre wear increases with speed.
- Correct wheel alignment is very important.
- Unbalanced wheels worsen tyre economy and travelling comfort.
- The tyres must have the same direction of rotation during their entire service life.
- When you change tyres, the tyres with the best tread must be fitted on the rear wheels to reduce the risk of oversteer during heavy braking.
- If you drive over kerbstones or deep holes you can damage the tyres and/or wheel rims permanently.

### Tyre rotation

The car has no mandatory tyre rotation. Driving style, tyre pressure, climate and road condition affect how quickly the tyres age and wear. Correct tyre pressure results in more even wear.

To avoid differences in tread depth and to prevent wear patterns forming on the tyres, the front

and rear wheels should be switched with each other. A suitable distance for the first change is approx. 5000 km (approx. 3100 miles) and then at 10000 km (approx. 6200 miles) intervals.

Volvo recommends the an authorised Volvo workshop is contacted for checking if you are uncertain about tread depth. If significant differences in wear (> 1 mm difference in tread depth) between tyres have already occurred, then the least worn tyres must always be fitted on the rear. Understeer is normally easier to correct than oversteer, and leads to the car continuing forwards in a straight line rather than having the rear end skidding to one side, resulting in possible complete loss of control over the car. This is why it is important for the rear wheels never to lose grip before the front wheels.

### Storing wheels and tyres

When you store complete wheels (tyres fitted on wheel rims) they should be hung up or positioned lying on their sides on the floor.

Tyres not fitted on rims must be stored lying on their sides or standing upright, but not hung up.

### ! IMPORTANT

Tyres should be stored in a cool, dry and dark place, and should never be stored close to solvents, petrol, oils, etc.

### ! WARNING

- Wheel rim size and tyre size for your Volvo are specified to meet stringent requirements for stability and driving characteristics. Unapproved combinations of wheel rim size and tyre size may have a negative effect on the car's stability and driving characteristics.
- Any damage caused by the fitting of unapproved combinations of wheel rim size and tyre size is not covered by the new car warranty. Volvo accepts no liability for death, personal injury or any costs caused by such installations.

### Related information

- Checking tyre pressure (p. 548)
- Tyres' rotation direction (p. 547)
- Tread wear indicators on the tyres (p. 547)
- Tyre pressure monitoring system\* (p. 550)
- Emergency puncture repair kit (p. 563)
- Dimension designation for tyre (p. 545)
- Approved wheel and tyre sizes (p. 661)
- Recommendations for loading (p. 578)

### Dimension designation for tyre

Designations for tyre dimension, load index and speed rating.

The car has an approval for the complete vehicle with certain combinations of wheel rims and tyres.

### Designation of dimensions

All tyres have a dimension designation, such as: 235/45 R18 98 W.

235	Tyre width (mm)
45	Ratio between tyre wall height and tyre width (%)
R	Radial ply
18	Rim diameter in inches
98	Codes for the maximum permitted tyre load, tyre load index (LI)
W	Speed rating for maximum permitted speed, speed rating (SS). (In this case 270 km/h (168 mph).)

### Load index

Each tyre has a certain capacity to carry a load, a load index (LI). The car's weight determines the load capacity required of the tyres.



◀ **Speed rating**

Each tyre can withstand a certain maximum speed. Tyre speed rating, SS (Speed Symbol), must at least correspond with the car's top speed. The table below shows the maximum permitted speed for each speed rating (SS). The only exception to these regulations is winter tyres<sup>2</sup>, where a lower speed rating may be used. If such a tyre is selected, the car must not be driven more quickly than the tyre is rated for. For example, cars with Q rating tyres must be driven at speeds not exceeding 160 km/h (100 mph). The road conditions and applicable road traffic rules determine how quickly the car can be driven, not the speed rating of the tyres.

**i NOTE**  
The maximum permitted speed is specified in the table.

Q	160 km/h (100 mph) (used only on winter tyres)
T	190 km/h (118 mph)
H	210 km/h (130 mph)
V	240 km/h (149 mph)

W	270 km/h (168 mph)
Y	300 km/h (186 mph)

**⚠ WARNING**  
The lowest permitted tyre load index (LI) and speed rating (SS) for the tyres for each respective engine variant are shown in the specifications, which can be found in the printed owner's manual. If a tyre with too low a load index or speed rating is used, it may overheat and be damaged.

**Related information**

- Tyres (p. 544)
- Dimension designation for wheel rim (p. 546)
- Approved wheel and tyre sizes (p. 661)
- Minimum permitted tyre load index and speed rating for tyres (p. 662)

**Dimension designation for wheel rim**

Wheel and rim dimensions are designated in accordance with the examples in the table below.

The car has an approval for the complete vehicle with certain combinations of wheel rims and tyres.

All wheel rims have a dimension designation, for example: 8Jx18x42.

8	Rim width in inches
J	Rim flange profile
18	Rim diameter in inches
42	Off-set in mm (distance from wheel centre to wheel contact surface against the hub)

**Related information**

- Tyres (p. 544)
- Dimension designation for tyre (p. 545)
- Approved wheel and tyre sizes (p. 661)

<sup>2</sup> Both those with metal studs and those without.

## Tyres' rotation direction

Tyres with a tread pattern which are designed to only turn in one direction have the direction of rotation marked with an arrow.

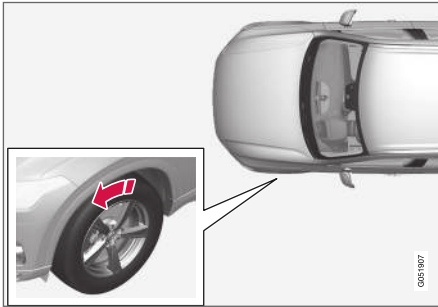

The arrow shows the tyre's direction of rotation.

- The tyre must always rotate in the same direction throughout its lifespan.
- Tyres should only be switched between front and rear positions, never between left and right-hand sides, or vice versa.
- If the tyres are fitted incorrectly, the car's braking characteristics and capacity to force rain and slush out of the way are adversely affected.
- Tyres with the greatest tread depth should always be fitted to the rear of the car (to decrease the risk of skidding).

### NOTE

Make sure that both pairs of wheels have the same type and dimension, and also the same make.

### Related information

- Tyres (p. 544)

## Tread wear indicators on the tyres

Tread wear indicators show the status of the tyre's tread depth.

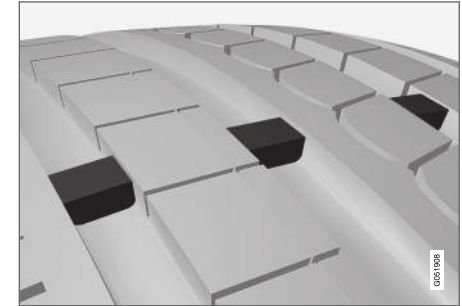

A tread wear indicator is a narrow elevation across the longitudinal grooves of the tyre's tread pattern. On the side of the tyre are the letters TWI (Tread Wear Indicator). When the tyre's tread depth is down to 1.6 mm (1/16 inch), the tread will be level in height with the tread wear indicators. Change to new tyres as soon as possible. Remember that tyres with little tread depth provide very poor grip in rain and snow.

### Related information

- Tyres (p. 544)

## Checking tyre pressure

Correct tyre pressure helps to improve driving stability, saves fuel and extends the service life of the tyres.

Tyre pressure decreases over time, this is a natural phenomenon. Tyre pressure also varies depending on ambient temperature. Driving on tyres with tyre pressure that is too low could result in the tyres overheating and being damaged. Tyre pressure affects travelling comfort, road noise and driving characteristics.

Check the tyre pressures monthly. Use the tyre pressure recommended for cold tyres in order to achieve optimal tyre performance and optimal wear. Tyre pressure that is too low or too high may cause uneven wear on the tyres.

### WARNING

- Tyre pressure that is too low is the most common cause of tyre failure and may result in serious cracks in the tyre, the tread loosening or the tyre exploding, with unexpected loss of control of the car and increased risk of personal injury.
- Tyres with pressure that is too low reduce the load capacity of the car.

## Cold tyres

The tyre pressure must be checked when the tyres are cold. Tyres are considered cold when

they have the same temperature as the surrounding air. This temperature is normally reached when the car has been parked for at least three hours.

After having driven approximately 1.6 km (1 mile) these tyres are considered as warm. If you have to drive further than this to inflate the tyres, first check and record the tyre pressure and inflate to a suitable tyre pressure when you arrive at the pump.

When the outside temperature changes, the tyre pressure also changes. A decrease in temperature of 10 degrees causes the tyre pressure to decrease 1 psi (7 kPa). Check the tyre pressure regularly and adjust to the correct pressure, which is specified on the car's tyre information decal or certification label.

If you check the tyre pressure when the tyres are warm then you must never release any air. The tyres are warm due to driving and it is normal for the pressure to increase above the recommended pressure for cold tyres. A warm tyre with tyre pressure equal to or below the recommendation for cold tyres may have a pressure that is far too low.

## Related information

- Adjusting tyre pressure (p. 548)
- Recommended tyre pressure (p. 549)
- Tyre pressure monitoring system\* (p. 550)
- Tyres (p. 544)

## Adjusting tyre pressure

Tyre pressure decreases over time, this is a natural phenomenon. The tyre pressure must therefore sometimes be adjusted in order to maintain the recommended tyre pressure.

Use the tyre pressure recommended for cold tyres in order to achieve optimal tyre performance and optimal wear.

### NOTE

To avoid incorrect tyre pressure, the pressure should be checked on cold tyres. "Cold tyres" means the tyres are the same temperature as the ambient temperature (approx. 3 hours after the car has been driven). After a few kilometres of driving, the tyres warm up and the pressure increases.

1. Remove the cap from the valve on one tyre and then press the tyre pressure gauge firmly down onto the valve.
2. Inflate the tyres to the correct pressure, see the decal on the door pillar on the driver's side showing the recommended pressure for factory fitted tyres.

- Refit the dust cap.

### **i** NOTE

- After a tyre has been inflated, always refit the dust cap in order to avoid damage to the valve from gravel, dirt, etc.
- Only use plastic dust caps. Metal dust caps can rust and become difficult to unscrew.

- Check the tyres visually for any implanted nails or other objects that could puncture the tyre and cause leakage.
- Check the sidewalls for any cavities, cuts, bumps or other irregularities.
- Repeat this for all tyres, including the spare tyre\*.

### **i** NOTE

If you have over-inflated, release air by pressing in the metal pin in the centre of the valve. Then check the pressure again using the tyre pressure gauge.

Some spare tyres require a higher tyre pressure than other tyres. Check in the tyre pressure table or on the tyre pressure label.

### Related information

- Recommended tyre pressure (p. 549)
- Checking tyre pressure (p. 548)
- Inflating tyres with the compressor from the puncture repair kit (p. 567)
- Approved tyre pressures (p. 663)

### Recommended tyre pressure

The tyre pressure label on the driver's side door pillar (between frame and rear door) shows which pressures the tyres should have at different loads and speed conditions.



The decal displays the designation for the factory-fitted tyres on the car, as well as load limits and tyre pressure.

### Improved fuel economy with ECO pressure

For a light load (max. 3 people) and a speed of up to 160 km/h (100 mph), the ECO pressures can be chosen for optimum fuel economy. However, the lower comfort pressures are recommended instead if optimum noise and travelling comfort are desired.

### Related information

- Checking tyre pressure (p. 548)
- Approved tyre pressures (p. 663)

### Tyre pressure monitoring system\*

The tyre pressure monitoring system<sup>3</sup>, gives a warning with an indicator symbol in the driver display when the pressure in one or more of the car's tyres is too low.

Symbol	Explanation
	<p>The symbol illuminates to indicate low tyre pressure.</p> <p>If there is a fault in the system the tyre pressure warning symbol flashes for approximately one minute and then remains illuminated.</p>

#### System description

The tyre pressure monitoring system measures differences in rotation speed between the different wheels via the ABS system in order to be able to determine whether they have the correct tyre pressure. If the tyre pressure is too low, the tyre's diameter is changed and, as a result, so is its rotation speed. By comparing the tyres with each other the system can determine whether one or more tyres have pressure that is too low.

#### General information on the tyre monitoring system

In the information below, the tyre monitoring system is referred to generically as TPMS.

Each tyre, including the spare tyre\*, should be checked once a month. When checking, the tyre should be cold and have the air pressure recommended by the car manufacturer specified on the tyre pressure label or in the tyre pressure table. If the car has tyres of a different size than that recommended by the manufacturer, find out what the correct air pressure level is for these.

As an extra safety feature, the car is equipped with a tyre pressure monitoring system (TPMS), which shows when the air pressure in one or more tyres is too low. When the indicator symbol for low air pressure is lit, stop and check the tyres as soon as possible and inflate to the correct air pressure.

Driving with tyres that have tyre pressure that is too low may cause the tyre to overheat, which can cause a puncture. Low tyre pressure also reduces fuel efficiency as well as tyre service life, and can affect car handling and stopping ability. Note that TPMS does not replace regular tyre maintenance. It is the driver's responsibility to maintain correct tyre pressure, even if the limit for low tyre pressure has not been reached so that the indicator symbol illuminates.

The car is also equipped with a TPMS system fault indicator, which indicates when the system is not functioning correctly. The TPMS system fault indicator is combined with the indicator symbol for low tyre pressure. When the system

detects a fault, the symbol in the driver display will flash for about one minute and then remain illuminated. This procedure will be repeated when the car is started until the fault has been rectified. When the symbol is illuminated, the system's ability to detect or warn of low tyre pressure may be affected.

A TPMS system fault can occur for several reasons, such as after changing to a spare tyre, or changing tyres or wheels that prevent TPMS from functioning correctly.

Always check the indicator symbol for TPMS after changing one or more tyres in order to ensure the new tyre or wheel is working correctly with TPMS.

#### Messages on the instrument panel

When the tyre pressure is too low, the indicator symbol for low tyre pressure is illuminated in the driver display and a message is shown. Check the tyre pressure in the **Car Status** app in the centre display.

- **Tyre pressure low** Check tyres, calibrate after fill
- **Tyre pressure system** Temporarily unavailable
- **Tyre pressure system** Service required

<sup>3</sup> Indirect Tyre Pressure Monitoring System (ITPMS)



### To bear in mind

- Always save a new tyre pressure in the system after changing a wheel or adjusting tyre pressure.
- If you change to tyres of a different size to the ones fitted at the factory, the system must be reset by storing a new tyre pressure for these tyres to avoid false warnings.
- If a spare wheel\* is used, it is possible that the tyre pressure monitoring system does not work correctly due to the differences between the wheels.
- The system does not replace the need for regular tyre inspection and maintenance.
- It is not possible to switch off the tyre pressure monitoring system.

### WARNING

- Incorrect tyre pressure may lead to tyre failure, which could result in the driver losing control of the car.
- The system cannot indicate sudden tyre damage in advance.

### Related information

- Recommended tyre pressure (p. 549)
- See tyre pressure status in the centre display\* (p. 553)

- Action in the event of warning for low tyre pressure (p. 554)
- Saving a new tyre pressure in the monitoring system\* (p. 551)

### Saving a new tyre pressure in the monitoring system\*

In order for the system for tyre pressure monitoring<sup>4</sup> to work correctly, a reference value for the tyre pressure must be saved. This must take place every time the tyres are changed or the tyre pressure is changed so that the system can warn about low pressure correctly.

For example, when driving with a heavy load or at high speed above 160 km/h (100 mph), the tyre pressure should be adjusted in accordance with Volvo's recommended tyre pressure values. The system is then reset by saving a new tyre pressure.

Perform the following procedure to store a new tyre pressure as a reference value in the system:

1. Switch off the car.
2. Inflate the tyres to the correct pressure, see the decal on the door pillar on the driver's side showing the recommended pressure for factory fitted tyres.
3. Start the car.

<sup>4</sup> Indirect Tyre Pressure Monitoring System (ITPMS)



4. Open the **Car Status** app in the app view.

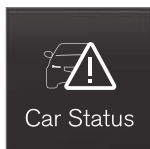

5. Press **TPMS**.



### **i** NOTE

The car must be stationary for the **Store Pressure** button to be selectable.

6. Press **Store Pressure**.
7. Tap on **OK** to confirm that the tyre pressure in all four tyres has been checked and adjusted.

8. Drive the car until the new tyre pressure has been saved.

The new tyre pressure is stored when the car is driven at a speed above 35 km/h (22 mph).

If the car's ignition is switched off before the new tyre pressure has been saved then the procedure needs to be performed again. Allow the storing to finish within the same driving cycle to ensure that the new tyre pressure has been saved correctly.

- > If storing fails, a message is shown:  
**Storing pressure unsuccessful. Try again..**

### **⚠** WARNING

The exhaust gases contain carbon monoxide, which is invisible and odourless, but highly toxic. The procedure to save a new tyre pressure must therefore always be performed outdoors or in a workshop with exhaust extraction.

### Related information

- Recommended tyre pressure (p. 549)
- Adjusting tyre pressure (p. 548)
- See tyre pressure status in the centre display\* (p. 553)
- Action in the event of warning for low tyre pressure (p. 554)

- Tyre pressure monitoring system\* (p. 550)

## See tyre pressure status in the centre display\*

With the system for tyre pressure monitoring<sup>5</sup>, tyre pressure status can be viewed in the centre display.

### Checking status

Several minutes driving above 35 km/h (22 mph) are required for the system to become active.

1. Open the **Car Status** app in the app view.



2. Tap on **TPMS** to show the status of the tyres.



### Status indication



The figure is schematic. Layout may vary depending on car model or updated software.

Below are some examples of the messages that can be shown for tyre pressure status and what they mean.

Centre display: <b>Check front left tyre, store pressure after fill</b>	The tyre's pressure is too low. Stop and check/rectify the tyre pressure by inflating as soon as possible <sup>A</sup> .
Centre display: <b>Check all tyres, store pressure after fill</b>	The pressure is too low in two or more tyres. Stop and check/rectify the tyre pressures by inflating as soon as possible <sup>A</sup> .

Driver display: <b>Tyre pressure system Temporarily unavailable</b>	The indicator symbol flashes and changes to constant glow after approx. 1 minute. The system is currently unavailable, activated shortly.
Driver display: <b>Tyre pressure system Service required</b>	The indicator symbol flashes and changes to constant glow after approx. 1 minute. The system is not working correctly, contact a workshop <sup>B</sup> .

<sup>A</sup> Always save a new tyre pressure in the system after the tyre pressure has been adjusted.

<sup>B</sup> An authorised Volvo workshop is recommended.

### Related information

- Saving a new tyre pressure in the monitoring system\* (p. 551)
- Action in the event of warning for low tyre pressure (p. 554)
- Tyre pressure monitoring system\* (p. 550)
- Car status (p. 592)

<sup>5</sup> Indirect Tyre Pressure Monitoring System (ITPMS)

## Action in the event of warning for low tyre pressure

When the system for tyre pressure<sup>6</sup> warns that tyre pressure is too low, action is required.



Check and rectify the tyre pressure when the indicator symbol for the system is illuminated and the **Tyre pressure low** message is shown.

1. Switch off the car.
2. Check the tyre pressure in all four tyres with a tyre pressure gauge.
3. Inflate the tyres to the correct pressure, see the decal on the door pillar on the driver's side showing the recommended pressure for factory fitted tyres.
4. Always save a new tyre pressure in the system via the centre display after the tyre pressure has been adjusted.

Note that the indicator symbol does not extinguish until the low tyre pressure has been rectified and storing a new tyre pressure has been started.

### NOTE

To avoid incorrect tyre pressure, the pressure should be checked on cold tyres. "Cold tyres" means the tyres are the same temperature as the ambient temperature (approx. 3 hours after the car has been driven). After a few kilometres of driving, the tyres warm up and the pressure increases.

### NOTE

- After a tyre has been inflated, always refit the dust cap in order to avoid damage to the valve from gravel, dirt, etc.
- Only use plastic dust caps. Metal dust caps can rust and become difficult to unscrew.

### WARNING

- Incorrect tyre pressure may lead to tyre failure, which could result in the driver losing control of the car.
- The system cannot indicate sudden tyre damage in advance.

### Related information

- Recommended tyre pressure (p. 549)
- Adjusting tyre pressure (p. 548)

- Saving a new tyre pressure in the monitoring system\* (p. 551)
- See tyre pressure status in the centre display\* (p. 553)
- Tyre pressure monitoring system\* (p. 550)
- Inflating tyres with the compressor from the puncture repair kit (p. 567)

<sup>6</sup> Indirect Tyre Pressure Monitoring System (ITPMS)

## When changing wheels

The car's wheels can be changed, e.g. to winter wheels or a spare wheel. Follow the relevant instructions for removing and fitting wheels.

## When changing to another tyre dimension

Check that the tyre dimension is approved for use on the car.

Contact an authorised Volvo workshop for updating the software at each change of tyre dimension. A software download may be necessary both when changing to larger and smaller dimensions, and also when switching between summer and winter wheels.

## Related information

- Removing a wheel (p. 557)
- Fitting the wheels (p. 559)
- Approved wheel and tyre sizes (p. 661)
- Tool kit (p. 555)
- Winter tyres (p. 561)
- Spare wheel\* (p. 560)
- Wheel bolts (p. 556)

## Tool kit

Tools that can be useful during towing, wheel changes or similar are found in the car's cargo area.



The foam block under the cargo area floor contains the car's towing eye, puncture repair kit, tool for removing the plastic caps from the wheel bolts and a socket for the lockable wheel bolts.

If the car is fitted with a spare wheel\*, there is a jack and a wheel bolt wrench.

## Related information

- When changing wheels (p. 555)
- Jack\* (p. 555)

## Jack\*

The jack can be used to raise the car, for example, to change to the spare wheel.





### **IMPORTANT**

- When the jack\* is not in use it must be stored in its storage space under the cargo area floor.
- The jack included with the car is only designed for occasional, short-term use, such as when changing a wheel after a puncture. Only the jack belonging to the specific model is to be used to jack up the car. If the car is to be jacked up more often, or for a longer time than is required just to change a wheel, use of a garage jack is recommended. In this instance, follow the instructions for use that come with the equipment.

The jack needs to be cranked together to the correct position in order to have space.

Applies to cars with **Leveling Control\***: If the car is equipped with the air suspension option then this function must be deactivated before the car is raised with the jack.

### **Related information**

- Tool kit (p. 555)

### **Wheel bolts**

Wheel bolts are used to attach the wheels to the hubs.

Only use rims that are tested and approved by Volvo and which are Volvo genuine accessories.

Check the tightening torque of the wheel bolts with a torque wrench.

Do **not** use lubricant on the threads of the wheel bolts.

### **WARNING**

The wheel bolts may need to be re-tightened several days after the change. Temperature differences and vibration may mean that they are not attached equally as tightly.

### **IMPORTANT**

The wheel bolts must be tightened to 140 Nm. (103 foot-pound). Overtightening or loose tightening may damage the nuts and the bolts.

### **Locking wheel bolts\***

In the foam block under the cargo area floor there is space for the sleeve for the lockable wheel bolts.

### **Related information**

- Removing a wheel (p. 557)
- Fitting the wheels (p. 559)

## Removing a wheel

Wheel changes must always be performed correctly. Instructions on how a wheel is undone and what is important to remember are provided below.

### ! IMPORTANT

- When the jack\* is not in use it must be stored in its storage space under the cargo area floor.
- The jack included with the car is only designed for occasional, short-term use, such as when changing a wheel after a puncture. Only the jack belonging to the specific model is to be used to jack up the car. If the car is to be jacked up more often, or for a longer time than is required just to change a wheel, use of a garage jack is recommended. In this instance, follow the instructions for use that come with the equipment.

### ! WARNING

- Apply the parking brake and set the gear selector in Park position (P).
- Chock the wheels standing on the ground using solid wood blocks or large stones.
- Check that the jack is not damaged, that the threads are thoroughly lubricated and that it is free from dirt.
- Check that the jack is resting on a firm, level surface that is not slippery and is not slanted.
- The jack must be correctly attached in the jack's bracket.
- Never position anything between the ground and the jack, nor between the jack and the car's jacking point.
- Passengers must leave the car when it is raised on the jack.
- If a wheel must be changed in a trafficked environment, passengers must stand in a safe place.
- Use a jack designed for the car when changing tyres. Use supports to secure the car for all other work.
- Never crawl under the car or reach under with a part of your body when it is raised on a jack.

1. Set up the warning triangle and activate the hazard warning lights if a tyre is being changed in a trafficked location.
2. Apply the parking brake and engage gear position **P**, or engage first gear if the car has a manual gearbox.

Applies to cars with **Leveling Control\***: If the car is equipped with air suspension, this must be disabled before the car is raised with a jack\*.

3. Take out the jack\*, wheel wrench\* and tools for the wheel bolts' plastic caps that are fitted in the foam block.



Tool for removing the plastic caps on the wheel bolts.

4. Chock in front of and behind the wheels that remain on the ground. Use, for example, heavy wooden blocks or large stones.



## WHEELS AND TYRES

5. Screw together the towing eye with the wheel wrench until the stop position as per the instructions.

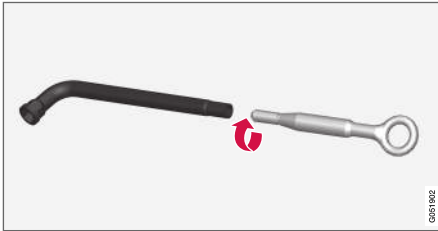

### **!** IMPORTANT

The towing eye must be screwed into the wheel bolt wrench\* as far as possible.

6. Remove the plastic caps from the wheel bolts with the intended tool.
7. With the car still on the ground, use the wheel bolt wrench/towing eye to undo the wheel bolts  $\frac{1}{2}$ -1 turn by pressing downwards (anticlockwise).

8. When raising the car, it is important that the jack or lifting arms are fitted in the intended points on the car's underbody. The triangle markings in the plastic cover indicate the locations of the jacking/lifting points. There are two jacking points on each side of the car. There is a recess for the jack at each point.

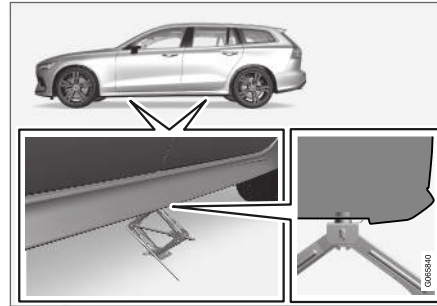

9. Position the jack on level, firm and non-slippery ground under the jacking point that will be used.
10. Crank up until it is correctly aligned and so that it makes contact with the car's jacking point. Check that the head of the jack (or the lift arms at a workshop) is correctly positioned in the jacking point so that the bump in the centre of the head fits into the jacking point hole and the base is positioned vertically below the jacking point.

11. Turn the jack so that the crank is as far away from the side of the car as possible, at which point the jack's arms are perpendicular to the direction of the car.
12. Raise the car high enough to allow the wheel to be removed to move freely. Remove the wheel bolts and lift off the wheel.

### Related information

- Settings for level control\* (p. 455)
- When changing wheels (p. 555)
- Raise the car (p. 596)
- Jack\* (p. 555)
- Tool kit (p. 555)
- Fitting the wheels (p. 559)



## Fitting the wheels

Instructions for fitting a wheel when changing wheels.

### **i** NOTE

The jack included with the car is only designed for occasional, short-term use, such as when changing a wheel after a puncture. Only the jack belonging to the specific model is to be used to jack up the car. If the car is to be jacked up more often, or for a longer time than is required just to change a wheel, use of a garage jack is recommended. In this instance, follow the instructions for use that come with the equipment.

### **⚠** WARNING

- Apply the parking brake and set the gear selector in Park position (P).
- Chock the wheels standing on the ground using solid wood blocks or large stones.
- Check that the jack is not damaged, that the threads are thoroughly lubricated and that it is free from dirt.
- Check that the jack is resting on a firm, level surface that is not slippery and is not slanted.
- The jack must be correctly attached in the jack's bracket.
- Never position anything between the ground and the jack, nor between the jack and the car's jacking point.
- Passengers must leave the car when it is raised on the jack.
- If a wheel must be changed in a trafficked environment, passengers must stand in a safe place.
- Use a jack designed for the car when changing tyres. Use supports to secure the car for all other work.
- Never crawl under the car or reach under with a part of your body when it is raised on a jack.

1. Clean the surfaces between wheel and hub.
2. Put on the wheel. Tighten the wheel bolts thoroughly.  
Do **not** use lubricant on the threads of the wheel bolts.
3. Lower the car so that the wheels cannot rotate.
4. Tighten the wheel bolts crosswise. It is important that the wheel bolts are tightened properly. Tighten to 140 Nm (103 foot-pound). Check the tightening torque with a torque wrench.



5. Refit the plastic caps on the wheel bolts.
6. Check the tyre pressure and calibrate the tyre pressure monitoring system\*.





**⚠ WARNING**

The wheel bolts may need to be re-tightened several days after the change. Temperature differences and vibration may mean that they are not attached equally as tightly.

**ℹ NOTE**

- After a tyre has been inflated, always refit the dust cap in order to avoid damage to the valve from gravel, dirt, etc.
- Only use plastic dust caps. Metal dust caps can rust and become difficult to unscrew.

**Related information**

- When changing wheels (p. 555)
- Raise the car (p. 596)
- Jack\* (p. 555)
- Tool kit (p. 555)
- Removing a wheel (p. 557)
- Saving a new tyre pressure in the monitoring system\* (p. 551)
- Checking tyre pressure (p. 548)

**Spare wheel\***

The spare wheel, the Temporary Spare type, can be used to temporarily replace a punctured normal wheel.

The spare tyre is only designed for temporary use. Replace it with a normal wheel as soon as possible.

The car's driving characteristics can be changed when the spare wheel is used and the ground clearance is reduced. Do not wash the car in an automatic car wash if the Temporary Spare is being used.

Recommended tyre pressure must be maintained regardless of the position of the temporary spare wheel on the car.

If the spare tyre is damaged then a new one can be purchased from a Volvo dealer.

**⚠ WARNING**

- Never drive faster than 80 km/h (50 mph) with a spare wheel fitted on the car.
- The car must never be driven fitted with more than one "Temporary Spare" wheel.
- The car may have different driving characteristics while driving with the spare wheel. The spare wheel must be replaced with a normal wheel as soon as possible.
- The spare wheel is smaller than the normal wheel, which affects the car's ground clearance. Look out for high kerbs and do not machine-wash the car.
- Follow the manufacturer's recommended tyre pressure for the spare wheel.
- On all-wheel drive cars, the drive on the rear axle can be disengaged.
- If the spare wheel is fitted to the front axle then it is not possible to use snow chains at the same time.
- The spare wheel must not be repaired.

**! IMPORTANT**

The car must not be driven with tyres of different sizes or with a spare tyre other than the one supplied with the car. Using different-sized wheels can cause serious damage to the car's transmission.

**Related information**

- When changing wheels (p. 555)
- Recommended tyre pressure (p. 549)

**Handling the spare wheel**

Follow these instructions for handling the spare wheel.

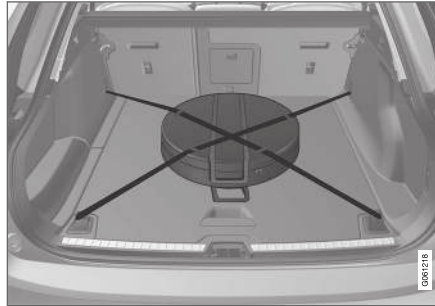

The spare wheel is stored in a bag and must be secured with two straps on the floor of the cargo area while driving. The straps must be tensioned crosswise over the wheel and attached in the car's four load retaining eyelets.

Tools for changing wheels are located under the cargo area floor.

**Related information**

- Spare wheel\* (p. 560)

**Winter tyres**

Winter tyres are adapted for winter road conditions.

Volvo recommends winter tyres with particular dimensions. Tyre dimensions are dependent on engine variant. When driving on winter tyres, the correct type of tyres must be fitted to all four wheels.

**i NOTE**

Contact a Volvo dealer for advice about which wheel rim and type of tyre are most suitable.

**Tips for changing to winter tyres**

When summer and winter wheels are changed, mark which side of the car they were mounted on, for example **L** for left and **R** for right.

**Studded tyres**

Studded winter tyres should be run in gently for 500-1000 km (300-600 miles), so the studs settle properly into the tyres. This gives the tyre, and especially the studs, a longer service life.

**i NOTE**

The legal provisions for the use of studded tyres vary from country to country.



### ◀ Tread depth

Road conditions with ice, slush and low temperatures place considerably higher demands on tyres than summer conditions. Volvo therefore recommends not to drive on winter tyres that have a tread depth of less than 4 mm (0.15 inches).

#### Related information

- When changing wheels (p. 555)
- Winter driving (p. 459)
- Tread wear indicators on the tyres (p. 547)

### Snow chains

Use of snow chains and/or winter tyres can help to improve the traction in winter conditions.

Volvo recommends that snow chains are not used on wheel dimensions other than 7.5x18 ET 45 235/45.

#### WARNING

Use Volvo genuine snow chains or equivalent chains designed for the car model, and tyre and rim dimensions. Only **single-sided** snow chains are permitted.

In the event of uncertainty about the snow chain, Volvo recommends that an authorised Volvo workshop should be contacted. The wrong snow chains may cause serious damage to the car and lead to an accident.

#### IMPORTANT

Snow chains can be used on the car with the following restrictions:

- Always follow the mounting instructions from the manufacturer carefully. Fit the chains as tensioned as possible and tension them at regular intervals.
- Snow chains must only be used on the front wheels (also applies to all-wheel drive cars).
- In some cases, snow chains must NOT be used, such as if accessory, aftermarket or "special" tyres and wheels are fitted that have a different size to the original tyres and wheels. Sufficient distance must be maintained between the chains and brakes, suspension and body components.
- Check local regulations with regard to using snow chains before fitting them.
- Never exceed the chain manufacturer's specified maximum speed. You must never exceed 50 km/h (30 mph) under any circumstances.
- Avoid bumps, holes or sharp turns when driving with snow chains.
- Avoid driving on bare ground as this wears out both the snow chains and tyres.

- Driving with snow chains may have a negative effect on the car's driving characteristics. Avoid fast or sharp turns, as well as braking with locked wheels.
- Some types of chain that are firmly tensioned affect brake components and must therefore NOT be used.

You can obtain more information on snow chains from a Volvo dealer.

### Related information

- Winter driving (p. 459)

## Emergency puncture repair kit

The emergency puncture repair kit<sup>7</sup>, is used to seal a puncture as well as to check and adjust the air pressure in the tyre.

Cars equipped with spare tyre\* do not have the puncture repair kit.

The puncture repair kit consists of a compressor and a bottle with sealing fluid. The sealing works as a temporary repair.

### **i** NOTE

The sealing fluid is effective at sealing tyres with tread punctures but has limited ability to seal tyres with sidewall punctures. Do not use the emergency puncture repair kit on tyres displaying larger slits, cracks or similar damage.

### **i** NOTE

The compressor is intended for temporary emergency puncture repair and is approved by Volvo.

### Location

The puncture repair kit is located in the foam block under the floor in the cargo area.



### Sealing fluid expiry date

The bottle of sealing fluid must be replaced if the bottle's expiry date has passed (see the decal on the bottle). Treat the old bottle as environmentally hazardous waste.

### Related information

- Using a puncture repair kit (p. 564)
- Inflating tyres with the compressor from the puncture repair kit (p. 567)
- Tyres (p. 544)

<sup>7</sup> Temporary Mobility Kit (TMK)

## Using a puncture repair kit

Seal a puncture with the emergency puncture repair kit, Temporary Mobility Kit (TMK).

### Overview

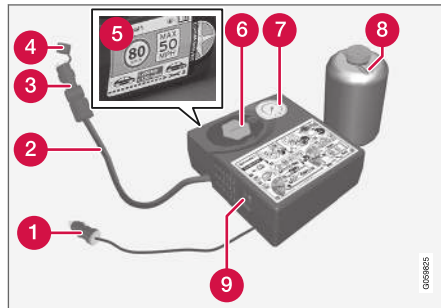

- 1 Electrical cable
- 2 Air hose
- 3 Pressure reducing valve
- 4 Protective cap
- 5 Label, maximum permitted speed
- 6 Bottle holder (orange cap)
- 7 Pressure gauge
- 8 Sealing fluid bottle
- 9 Switch

### Connecting

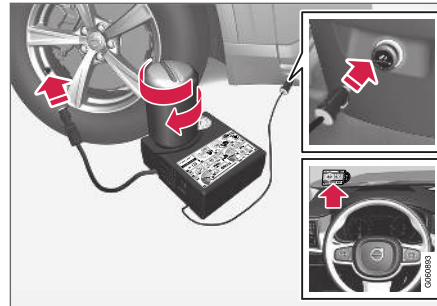

### **i** NOTE

Do not break the bottle's seal before use. The seal is broken automatically when the bottle is screwed in.

### **!** WARNING

Please keep the following points in mind when using the tyre sealing system:

- The sealing fluid bottle contains 1) rubber latex, natural and 2) ethanediol. These substances are harmful if swallowed.
- The contents of this bottle may cause allergic skin reactions or otherwise be potentially harmful to the respiratory tract, the skin, the central nervous system, and the eyes.

Precautions:

- Store out of the reach of children.
- Harmful if ingested.
- Avoid prolonged or repeated contact with the skin. If sealing fluid has come into contact with your clothes, remove them.
- Wash thoroughly after handling.

First aid:

- Skin: Wash affected areas of skin with soap and water. Get medical attention if symptoms occur.
- Eyes: Flush with plenty of water for least 15 minutes, occasionally lifting the upper and lower eyelids. Get medical attention if symptoms occur.

- Inhalation: Move the exposed person to fresh air. If irritation persists, get medical attention.
- Ingestion: Do NOT induce vomiting unless directed to do so by medical personnel. Get medical attention.
- Disposal: Dispose of this material and its container at a hazardous or special waste collection point.

**⚠ WARNING**

- Do not remove the bottle when the puncture repair kit is being used.
- Do not remove the air hose when the puncture repair kit is being used.

1. Set up the warning triangle and activate the hazard warning lights if a tyre is being sealed in a trafficked location.

If the puncture was caused by a nail or similar, allow this to remain in the tyre. It helps to seal the hole.

2. Detach the decal for maximum permitted speed that is affixed on one side of the compressor. Affix it visibly on the windscreen as a reminder to observe the speed limit. You should not drive faster than 80 km/h (50 mph) after the emergency tyre repair kit has been used.
3. Check that the switch is in position **0** (Off), and locate the electrical cable and the air hose.
4. Unscrew the orange-coloured cap from the compressor, and unscrew the cork from the sealing fluid bottle.
5. Screw in the bottle to the bottom of the bottle holder.

The bottle and the bottle holder are equipped with a reverse catch to prevent sealant leakage. When the bottle is screwed in it cannot be unscrewed from the bottle holder again. The bottle must be removed at a workshop<sup>8</sup>.

**⚠ WARNING**

Do not unscrew the bottle, it is equipped with a reverse catch to prevent leakage.

6. Unscrew the tyre's dust cap and screw in the air hose's valve connection to the bottom of the thread on the tyre's air valve.  
Check that the pressure reducing valve on the air hose is fully screwed in.
7. Connect the electrical cable to the closest 12 V socket and start the car.

**i NOTE**

Make sure that none of the other 12 V sockets is in use when the compressor is operating.

**⚠ WARNING**

Do not leave children in the car without supervision when the engine is running.

**⚠ WARNING**

Inhaling car exhaust fumes could result in danger to life. Never leave the engine running in sealed areas or areas that lack sufficient ventilation.

<sup>8</sup> An authorised Volvo workshop is recommended.

## WHEELS AND TYRES

- ◀ 8. Start the compressor by flicking the switch to position I (On).

### WARNING

Never stand next to the tyre when the compressor is running. If cracks or unevenness arise then the compressor must be switched off immediately. The journey should not be continued. Call roadside assistance for recovery to a tyre centre. Volvo recommends an authorised tyre centre.

### NOTE

When the compressor starts, the pressure can increase up to 6 bar (88 psi) but the pressure drops after approximately 30 seconds.

9. Inflate the tyre for 7 minutes.

### IMPORTANT

The compressor must not be operated for longer than 10 minutes - risk of overheating.

10. Switch off the compressor to check the pressure on the pressure gauge. Minimum pressure is 1.8 bar (22 psi) and maximum is 3.5 bar (51 psi). Release air using the pressure reducing valve if the tyre pressure is too high.

### WARNING

If the pressure is below 1.8 bar (22 psi) then the hole in the tyre is too big. The journey should not be continued. Call roadside assistance for recovery to a tyre centre. Volvo recommends an authorised tyre centre.

11. Switch off the compressor and detach the electrical cable.
12. Unscrew the air hose from the tyre valve and refit the dust cap on the tyre.

### NOTE

- After a tyre has been inflated, always refit the dust cap in order to avoid damage to the valve from gravel, dirt, etc.
- Only use plastic dust caps. Metal dust caps can rust and become difficult to unscrew.

13. Fit the protective cap on the air hose in order to avoid leakage of the remaining sealing fluid. Place the equipment in the cargo area.

14. As soon as possible, drive at least 3 km (2 miles) at a maximum speed of 80 km/h (50 mph) so that the sealing fluid can seal the tyre, and then perform a follow-up check.

### WARNING

Sealant will spurt out of the puncture during the first few rotations of the tyre. Make sure that nobody is standing near the car and gets the sealing fluid splashed onto them when the car is driven away. The distance should be at least 2 metres (7 feet).

### 15. Follow-up inspection

Connect the air hose on the tyre valve and screw in the valve connection to the bottom of the tyre valve's thread. The compressor must be switched off.



16. Read the tyre pressure on the pressure gauge.

- If it is below 1.3 bar (19 psi) then the tyre is insufficiently sealed. The journey should not be continued. Call roadside assistance for recovery.
- If the tyre pressure is higher than 1.3 bar (19 psi), the tyre must be inflated to the pressure specified in accordance with the tyre pressure label on the driver's side door pillar (1 bar = 100 kPa = 14.5 psi). Release air using the pressure reducing valve if the tyre pressure is too high.

### WARNING

Check the tyre pressure regularly.

Volvo recommends that the car is driven to the nearest authorised Volvo workshop for the replacement/repair of the damaged tyre. Advise the workshop that the tyre contains sealing fluid.

The sealing fluid bottle and hose must be replaced after use. Volvo recommends that these replacements be performed by an authorised Volvo workshop.

### WARNING

Maximum mileage with tyres containing sealing fluid is 200 km (120 miles).

### NOTE

The compressor is an electrical device. Follow local regulations related to waste management.

### Related information

- Recommended tyre pressure (p. 549)
- Emergency puncture repair kit (p. 563)
- Inflating tyres with the compressor from the puncture repair kit (p. 567)

## Inflating tyres with the compressor from the puncture repair kit

The car's original tyres can be inflated using the compressor in the emergency puncture repair kit.

1. The compressor must be switched off. Make sure that the switch is in position **O** (Off), and take out the electrical cable and the air hose.
2. Unscrew the tyre's dust cap and screw in the air hose's valve connection to the bottom of the thread on the tyre's air valve.  
  
Check that the pressure reducing valve on the air hose is fully screwed in.
3. Connect the electrical cable to the closest 12 V socket and start the car.

### WARNING

Inhaling car exhaust fumes could result in danger to life. Never leave the engine running in sealed areas or areas that lack sufficient ventilation.

### WARNING

Do not leave children in the car without supervision when the engine is running.

4. Start the compressor by flicking the switch to position **I** (On).





### **!** IMPORTANT

Risk of overheating. The compressor must not run for more than 10 minutes.

5. Inflate the tyre to the pressure specified on the tyre pressure label on the driver side door pillar. Release air using the pressure reducing valve if the tyre pressure is too high.
6. Switch off the compressor. Detach the air hose and the electrical cable.
7. Refit the dust cap on the tyre.

### **i** NOTE

- After a tyre has been inflated, always refit the dust cap in order to avoid damage to the valve from gravel, dirt, etc.
- Only use plastic dust caps. Metal dust caps can rust and become difficult to unscrew.

### **i** NOTE

The compressor is an electrical device. Follow local regulations related to waste management.

### Related information

- Recommended tyre pressure (p. 549)
- Using a puncture repair kit (p. 564)
- Emergency puncture repair kit (p. 563)

LOADING, STORAGE AND PASSENGER  
COMPARTMENT

## Passenger compartment interior

Overview of the passenger compartment's interior and storage locations.

### Front seat

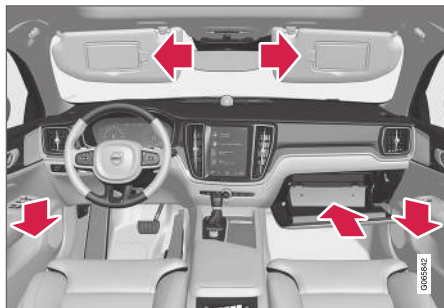

Storage compartment in the door panel, glovebox and sun visor.

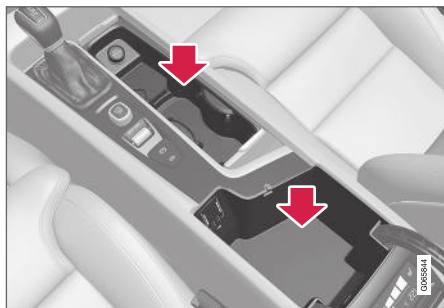

Storage spaces with cup holder, electrical socket and USB port in the tunnel console.

### Rear seat



Storage compartment in the door panel, cup holder\* in the centre seat backrest, storage pocket\* on the front seat backrest and also electrical sockets in the tunnel console.

### WARNING

Keep loose objects such as mobile phones, cameras, remote controls for accessories, etc. in the glove compartment or other compartments. Otherwise they may injure people in the car in the event of sudden braking or a collision.

### IMPORTANT

Keep in mind that high gloss surfaces, for example, are easily scratched by metal objects. Do not place keys, phones and other items on sensitive surfaces.

### Related information

- Using the cigarette lighter\* (p. 571)
- Electrical sockets (p. 573)
- Using the glovebox (p. 576)
- Sun visors (p. 578)
- Tunnel console (p. 571)
- Connecting a device via USB port (p. 504)

## Tunnel console

The tunnel console is located between the front seats.

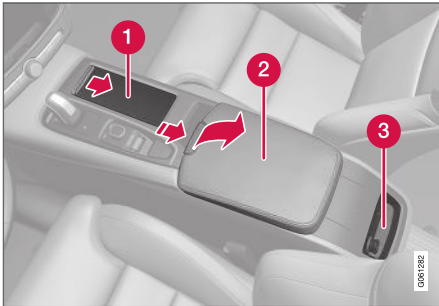

- 1 Storage compartment with cup holder.
- 2 Storage compartment with 12 V socket and USB port under the armrest.
- 3 Climate controls for the rear seat climate functions\* or storage compartment.

### **⚠ WARNING**

Keep loose objects such as mobile phones, cameras, remote controls for accessories, etc. in the glove compartment or other compartments. Otherwise they may injure people in the car in the event of sudden braking or a collision.

### **! IMPORTANT**

Keep in mind that high gloss surfaces, for example, are easily scratched by metal objects. Do not place keys, phones and other items on sensitive surfaces.

### **i NOTE**

One of the detectors for the alarm\* is located under the tunnel console's cup holder. Avoid leaving coins, keys and other metal objects in the cup holder, since this may trigger the alarm.

### Related information

- Using the cigarette lighter\* (p. 571)
- Passenger compartment interior (p. 570)
- Electrical sockets (p. 573)
- Climate controls (p. 207)

## Using the cigarette lighter\*

The cigarette lighter can be a complement to the 12 V socket in the front section of the tunnel console.



Cigarette lighter in tunnel console, front seat.

1. Press the button on the lighter.
  - > The button jumps up when the lighter starts to glow.
2. Pull the lighter out from the socket and use the glow to give a light.
3. Refit the lighter in the socket.

### **⚠ WARNING**

Take care when the lighter is activated so that the glowing part does not, for example, damage the interior or injure passengers.



◀◀ **Related information**

- Passenger compartment interior (p. 570)

## Electrical sockets

There are two 12 V electrical sockets and one 230 V electrical socket\* in the tunnel console, and there is one 12 V electrical socket\* in the cargo area.

If a problem occurs with an electrical socket, contact a workshop - an authorised Volvo workshop is recommended.

### 12 V electrical socket

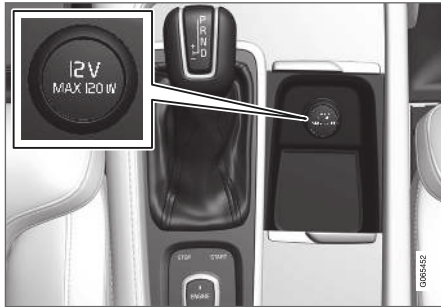

12 V electrical socket in tunnel console, front seat.

The 12 V sockets can be used for various accessories designed for this, such as music players, cooler boxes and mobile phones.

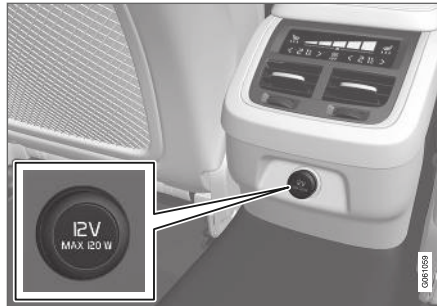

12 V electrical socket in tunnel console, rear seat.

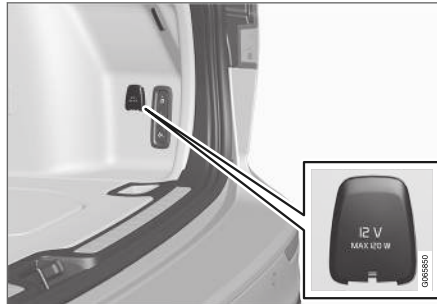

12 V electrical socket in cargo area\*.

### High voltage socket\*



Electrical socket in the tunnel console, rear seat.

The high-voltage socket\* can be used for various accessories designed for this, such as chargers or laptops.

### Status indication, high-voltage socket

An LED<sup>1</sup> lamp on the socket indicates the status of the socket:

<sup>1</sup> LED (Light Emitting Diode)



Status indication	Reason	Action
Steady green light	The socket is delivering current to a connected device.	None.
Blinking orange light	The temperature of the socket's voltage converter is too high (because for example the accessory draws too high a current or the passenger compartment is too warm).	Remove the plug and let the voltage converter cool down before reinserting the plug.
	The connected accessory draws too much current (intermittently or continuously) or is defective.	None. The accessory cannot be connected to the socket.
Extinguished lamp	The socket does not sense that a plug has been inserted.	Check that the plug is properly inserted into the socket.
	The socket is not active.	Switch the car's electrical system to the lowest ignition position <b>I</b> .
	The socket has been active but is now deactivated.	Start the engine and/or charge the starter battery.

### Related information

- Passenger compartment interior (p. 570)
- Using electrical sockets (p. 575)



## Using electrical sockets

12 V sockets can be used for various accessories designed for this, such as music players, cooler boxes and mobile phones.

High-voltage sockets\* can be used for various accessories designed for this, such as chargers and portable computers.

For the sockets to supply current, the car's electrical system must be set in the lowest ignition position **I**. The sockets are then active as long as the starter battery level does not become too low.

If the engine is switched off and the car is locked, the sockets are deactivated. If the engine is switched off and the car is not locked, or is locked with double lock temporarily deactivated, then the sockets continue to be active for a further seven minutes.

### NOTE

Remember that use of the electrical socket with the engine switched off entails a risk of discharging the starter battery, which can limit functionality.

Accessories that are connected to the electrical sockets may be activated even when the car's electrical system is disconnected or if preconditioning is used. For this reason, disconnect the connectors when they are not in use in order to avoid the starter battery being discharged.

### WARNING

- Do not use accessories with large or heavy connectors - they can damage the socket or come loose when driving.
- Do not use accessories that can cause interference to the car's radio receiver or electrical system for example.
- Position the accessory so that it is not at risk of injuring the driver or passengers in the event of heavy braking or collision.
- Keep an eye on connected accessories as they can generate heat that can burn passengers or the interior.

## Using 12 V sockets

1. Remove the blanking plug (tunnel console) or fold down the cover (cargo area) in front of the socket and plug in the accessory's connector.
2. Unplug the accessory's connector and refit the blanking plug (tunnel console) or fold up the cover (cargo area) when the socket is not in use or if the socket is left unattended.

### IMPORTANT

Maximum socket output is 120 W (10 A) per socket.

## Using high-voltage sockets

1. Pull down the socket cover and insert the accessory's plug.
  - > The LED<sup>2</sup> lamp on the socket indicates the status.
2. Check that the lamp is illuminated with a steady green light - only then is current available at the socket.
3. Disconnect the accessory by pulling out the plug - do not pull on the cable.

Pull up the cover when the socket is not being used or the socket is left unattended.

<sup>2</sup> LED (Light Emitting Diode)



**! IMPORTANT**

Maximum socket output is 150 W.

**⚠ WARNING**

Never modify or repair the high-voltage socket yourself. Volvo recommends that an authorised Volvo workshop should be contacted.

**⚠ WARNING**

- Only use accessories that are undamaged and fault-free. The accessories must have a CE marking, UL marking or an equivalent safety marking.
- Accessories must be rated for 230 V and 50 Hz with connectors designed for the socket.
- Never allow sockets, connectors or accessories to come into contact with water or other liquids. Do not touch or use the socket if it appears to be damaged or has come into contact with water or other liquid.
- Do not connect junction sockets, adapters or extension cables to the socket as these can override the socket's safety features.
- The socket is equipped with a protective cover, ensure that nothing protrudes in or damages the socket preventing the cover from doing its job. Do not leave children in the car unsupervised when the socket is active.

Failure to follow the advice given above can lead to severe or fatal electric shocks.

**Related information**

- Electrical sockets (p. 573)
- Passenger compartment interior (p. 570)

**Using the glovebox**

The glovebox is located on the passenger side. The printed owner's manual and maps can be kept in the glovebox, for example. There is also space for a pen and card holder.

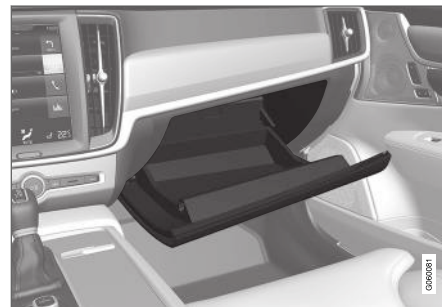

**Locking and unlocking the glovebox\***

The glovebox can be locked, e.g. when the car is taken in for service, left at a hotel or similar. The glovebox can only be locked/unlocked with the accompanying key.

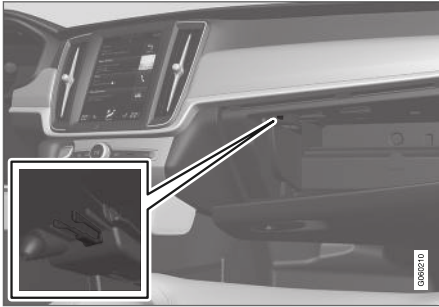

The key's designated storage space. The figure is schematic - the design may vary.

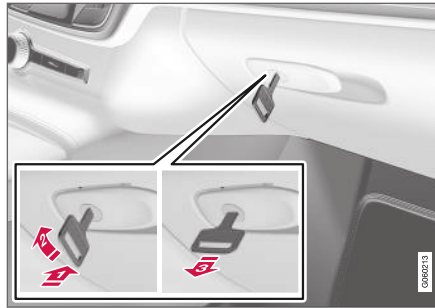

The figure is schematic - the design may vary.

Locking the glovebox:

- 1 Insert the key in the glovebox lock cylinder.
- 2 Turn the key 90 degrees clockwise.
- 3 Pull out the key.

– Unlock by carrying this out in reverse order.

**Using the glovebox as a cooled area\***

The glovebox can be used for cooling of e.g. drinks or food. The cooling works when the climate control system is active (i.e. when the car is set in ignition position II or when the engine is running).

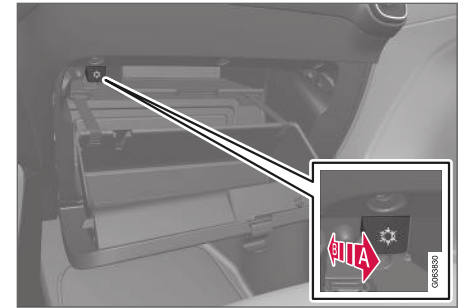

The figure is schematic - the design may vary.

- A Activating cooling
  - B Deactivating cooling
- Activate or deactivate the cooling by moving the control to the end position toward the passenger compartment/glovebox.

**Related information**

- Passenger compartment interior (p. 570)
- Private locking (p. 271)

## Sun visors

There are sun visors in the roof in front of the driver seat and the front seat passenger seat which can be folded down and angled out to the side when necessary.



The figure is schematic - the design may vary.

The mirror lighting\* is switched on automatically when the guard is lifted up.

The mirror frame incorporates a holder for e.g. cards or tickets.

## Related information

- Passenger compartment interior (p. 570)

## Cargo area

The car has a flexible cargo area that makes it possible to transport and secure large objects.

By folding down the backrests in the rear seat, the cargo area can become quite spacious. Use load retaining eyelets or bag holders to secure the load, and the extendable cargo cover\* to conceal the load if desired.

If the car is equipped with a spare wheel then this is attached on the cargo area floor. The car's towing eye and puncture repair kit are stored under the cargo area floor.

## Related information

- Recommendations for loading (p. 578)
- Bag hooks (p. 580)
- Load retaining eyelets (p. 581)
- Fitting and removing cargo cover\* (p. 582)

## Recommendations for loading

There are a number of things that are important to bear in mind when loading the car.

Payload depends on the car's kerb weight. The total of the weight of the passengers and all accessories reduces the car's payload by a corresponding weight.

### **WARNING**

The car's driving properties change depending on the weight and positioning of the load.

## Loading in the cargo area

Good things to remember when loading:

- Position the load firmly against the rear seat's backrest.
- Heavy objects should be placed as low as possible. Avoid placing heavy loads on lower-backed seats.
- Cover sharp edges with something soft to avoid damaging the upholstery.
- Secure all loads to the load retaining eyelets with straps or web lashings.

### **WARNING**

A loose object weighing 20 kg (44 pounds) can, in a frontal collision at a speed of 50 km/h (30 mph) carry the impact of an item weighing 1000 kg (2200 pounds).

**⚠ WARNING**

Leave 10 cm (4 inches) space between the load and the side windows if the car is loaded to above the top edge of the door windows. Otherwise, the intended protection of the inflatable curtain, which is concealed in the headlining, may be compromised.

**⚠ WARNING**

Always secure the load. During heavy braking the load may otherwise shift, causing injury to the car's occupants.

Cover sharp edges and sharp corners with something soft.

Switch off the engine and apply the parking brake when loading/unloading long items. Otherwise you may accidentally knock the gear lever or gear selector with the load into a drive position - and the car could then move off.

**Increasing the space in the cargo area**

To expand the cargo area and simplify loading, the rear seat's backrest can be lowered. Note that objects must not prevent the function of the WHIPS system for the front seats if any of the rear seat's backrests is folded down.

A through-load hatch in the rear seat can be folded down for carrying long and narrow loads.

**Related information**

- Load retaining eyelets (p. 581)
- Lowering the backrests in the rear seat (p. 188)
- Through-load hatch in the rear seat (p. 581)
- Roof load and loading on load carriers (p. 579)
- Level control\* and shock absorption (p. 453)
- Weights (p. 649)

**Roof load and loading on load carriers**

For loading on the car's roof, the load carriers that Volvo have developed are recommended.

This is in order to avoid damage to the car and in order to achieve the maximum possible safety during a journey. Volvo's load carriers are available for purchase at authorised Volvo retailers.

Carefully follow the installation instructions supplied with the carriers.

- Distribute the load evenly over the load carriers. Put the heaviest objects at the bottom.
- Check periodically that the load carriers and load are properly secured. Lash the load securely with retaining straps.
- If the load is longer than the car at the front, e.g. a canoe or kayak, fit the towing eye to its front socket and attach the bungee to this.
- The size of the area exposed to the wind, and therefore fuel consumption, increase with the size of the load.
- Drive gently. Avoid quick acceleration, heavy braking and hard cornering.

**⚠ WARNING**

The car's centre of gravity and driving characteristics are altered by roof loads.

Follow the car's specifications with regard to weights and maximum permitted load.



#### ◀ Related information

- Recommendations for loading (p. 578)
- Weights (p. 649)

### Bag hooks

Bag hooks keep carrier bags in place and prevent them from overturning and spreading their contents across the cargo area.

#### Along the sides

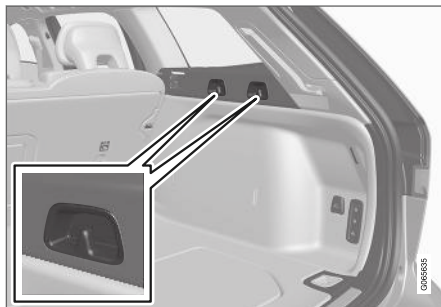

There are two bag hooks in the side panel on each side of the cargo area.

#### **!** IMPORTANT

The bag hooks may be loaded with a maximum of 5 kg (11 lbs).

### Under the floor hatch\*



There are two bag hooks and an elastic strap<sup>3</sup> in the cover, which is part of the floor hatch in the cargo area. The strap can be fitted in four different positions.

Lift up the cover in order to use the bag hooks. Fasten the bags in a suitable position with the enclosed elastic strap. If the bags have handles and are a suitable height - hang them in the hooks.

#### Related information

- Recommendations for loading (p. 578)
- Using the glovebox (p. 576)
- Fitting and removing the safety net\* (p. 585)

<sup>3</sup> It is possible to reorder additional elastic straps at a Volvo dealer.

- Fitting and removing cargo cover\* (p. 582)
- Fitting and removing safety grilles\* (p. 584)

### Load retaining eyelets

Use the load retaining eyelets to attach straps in order to anchor items in the cargo area.



#### **WARNING**

Hard, sharp and/or heavy objects which protrude may cause injury under violent braking.

Always secure large and heavy objects with a seatbelt or cargo retaining straps.

### Related information

- Recommendations for loading (p. 578)
- Weights (p. 649)

### Through-load hatch in the rear seat

The hatch in the rear seat's backrest can be opened to transport long narrow items, e.g. skis.

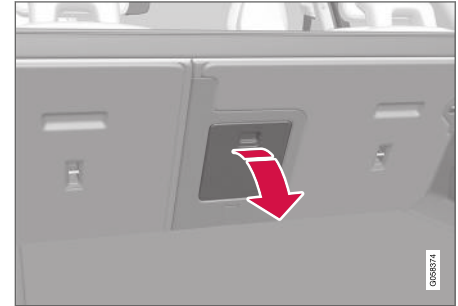

The figure is schematic - parts may vary depending on car model.

1. In the cargo area, grip the hatch's handle and fold down the hatch.
2. Fold forward the armrest in the rear seat.

If the private locking function is used then the through-load hatch must be closed.

### Related information

- Recommendations for loading (p. 578)
- Private locking (p. 271)
- Load retaining eyelets (p. 581)

## Fitting and removing cargo cover\*

In the extended position, the cargo cover prevents visual access to the cargo area.

### Fitting cargo cover



- 1 Insert one of the cargo cover's end pieces in the recess in the side panel in the cargo area.
- 2 Then insert the other end piece in the recess in the side panel on the opposite side.
- 3 Press down the end pieces on both sides - one by one.
  - > When a "click" is heard and the red marking on each end piece has disappeared, the cargo cover is attached - check that it is affixed securely.

## Removing cargo cover

In retracted position:

1. Depress the button on one of the retracted cargo cover's end pieces and lift out that end.
2. Angle the cover up/out carefully.
  - > The other end piece loosens automatically and the cover can be lifted out of the cargo area.

### Related information

- Operating cargo cover\* (p. 582)
- Recommendations for loading (p. 578)

## Operating cargo cover\*

There are two extended positions for the cargo cover - a full-cover position and a loading position, where it is partially extended to make it easier to reach further into the cargo area.



## Full-cover position

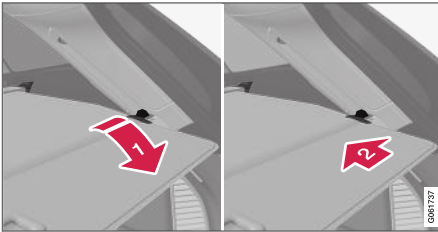

- 1 Grip the handle and pull the cargo cover out to the end position.
- 2 Hook the attachment pins into the recesses at the cargo area's rear pillars.
  - > The cargo cover is locked in the full-cover position.



Cargo cover in full-cover position.

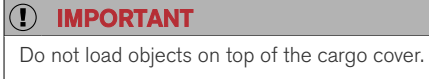

## Loading mode

From the full-cover position:

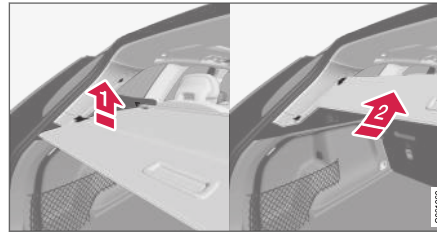

Press the cargo cover's handle section upwards slightly.

- > The cover goes up until it stops in the loading position.

Returning to full-cover position from loading position:

1. Grip the handle and pull the cargo cover down to the end position. To facilitate, angle up the handle slightly so that the attachment pins pass the stops.

2. Release the handle so that the attachment pins engage.
  - > The cover is locked in the full-cover position.

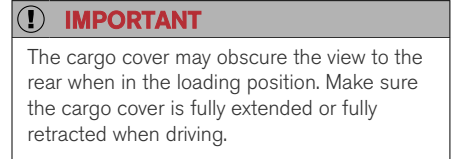

## Retracting

1. From the full-cover position:

Lift up the handle and pull it backward to disengage the cargo cover's attachment pins and then release.

From loading position:

Grip the handle and pull out the cargo cover in the grooves - pull to the full-cover position. Lift up the handle and pull it backward to disengage the attachment pins and then release.

2. Retract the cover with its attachment pins outside of the side panels until it stops in the retracted position.

## Related information

- Fitting and removing cargo cover\* (p. 582)

## Fitting and removing safety grilles\*

The safety grille prevents loads or pets in the cargo area from being thrown forward in the passenger compartment under heavy braking.

The safety grille is crash-tested in accordance with the ECE R17 legal requirement and fulfils Volvo's strength requirements.

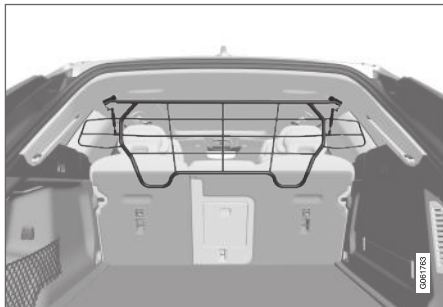

For safety reasons, the safety grille must always be attached and anchored correctly.

### **WARNING**

Under no circumstances may anybody remain in the cargo area while the car is moving. This is to avoid injury in the event of heavy braking or an accident.

## Installation

### **IMPORTANT**

The safety grille must only be used in the rear position (behind the rear seat) described here.

Before first installing the safety grille, the existing plastic roof mountings must be replaced with steel roof mountings. Volvo recommends that replacing roof mountings is performed at an authorised Volvo workshop or retailer.

1. Fold the rear seat's backrest forward.
2. Make sure that the safety grille is turned in the right direction. Lift in the safety grille through one of the rear side doors.

3.

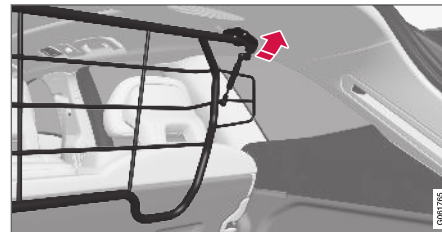

Position the safety grille's brackets on the roof mountings.

The next step is facilitated if two people hold the safety grille in the right position.

4.

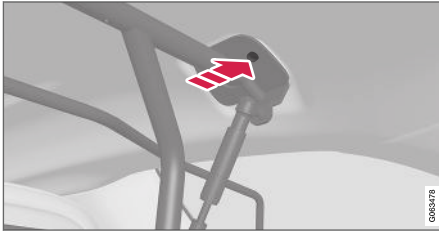

Insert the supplied screw and tighten using the supplied 6 mm Allen key. Repeat on the other side. Recommended tightening torque: 20 Nm (15 foot-pounds).

> Check that the safety grille is properly fitted.

5. Restore the backrest to the upright position.

For more information about the tools required and methods for fitting/removal, see the installation instructions that were included with the initial purchase.

### **!** IMPORTANT

The protective grille cannot be folded up or down when a cargo cover is fitted.

### Related information

- Recommendations for loading (p. 578)
- Load retaining eyelets (p. 581)

## Fitting and removing the safety net\*

The safety net prevents loads from being thrown forward in the passenger compartment in the event of sudden braking.

The safety net is fitted into four mounting points.

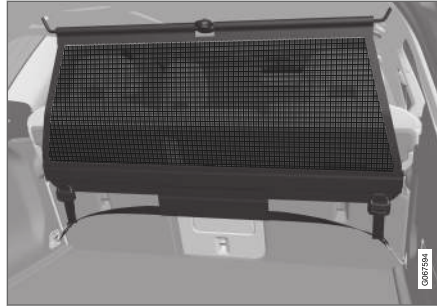

For reasons of safety, the safety net must always be fastened and anchored as described below.

The net is made of a strong nylon fabric and can be secured two different locations in the car:

- Rear fitting - behind the rear seat.
- Front fitting - behind the front seats.

### **!** WARNING

Loads in the luggage compartment must be anchored well, and also using a correctly fitted safety net.

## Fitting the safety net

### **!** WARNING

It is necessary to ensure that the upper securing points of the safety net are fitted correctly and that the puller-straps are hooked in properly.

Damaged safety nets must not be used.

### **i** NOTE

With forward mounting, the safety net is most easily mounted via one of the rear doors.

1. Unfold the safety net and make sure that the split upper rod in the net is locked in its extended position.
2. Hook one retaining hook of the net into the front or rear roof mounting with the anchoring strap locks turned towards you.
3. Hook the net's second attachment hook to the roof bracket on the opposite side.

The telescopically sprung attachment hooks make it easier to fit.

Take care to press forward the net's retaining hooks for each respective roof mounting's front end position.



4.

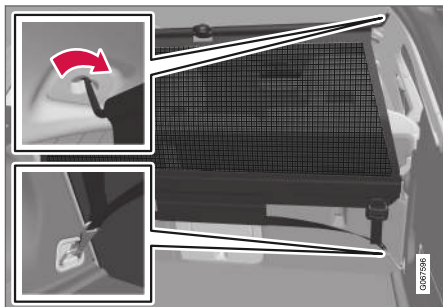

Rear fitting.

For rear fitting:

With the net fitted in the rear roof mountings, hook the safety net's puller-straps into the front load retaining eyelets in the cargo area.

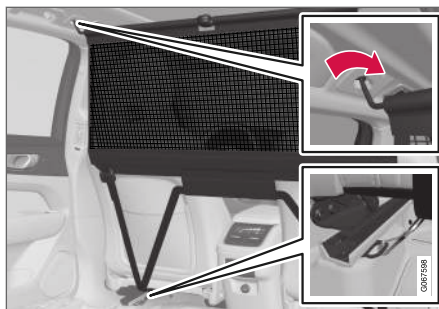

Front fitting.

For front fitting:

With the net fitted in the front roof mountings, hook the anchoring straps into the outer eyes on the rear of the seat slide rails - it is easier if the backrests are straightened and the seats are moved forward slightly.

Pay attention to make sure that you do not press the seat and backrest hard against the net when they are moved back again - only adjust until the seat or backrest makes contact with the net.

**! IMPORTANT**

If a seat or backrest is pushed backwards hard into the safety net, the net and roof mounts may be damaged.

5. Tension the safety net with the anchoring straps.

**Removing the safety net**

The safety net can be easily removed and folded up.

1. Reduce safety net tension by pressing the button in the anchoring strap lock and feeding out a little of the anchoring strap on each side.
2. Press in the catches and detach both of the anchoring strap's hooks.
3. Undo the upper attachments and release the net from the roof mountings.
4. Press the red button on the rod to enable folding and then roll up the net. Store the net in its case.

**Related information**

- Recommendations for loading (p. 578)
- Load retaining eyelets (p. 581)

## First aid kit\*

The first aid kit contains first aid equipment.

Store the first aid kit in an appropriate place in the cargo area, e.g. in the space on the right-hand side. The first aid kit has Velcro straps and can be attached directly to the panel.

## Related information

- Cargo area (p. 578)

## Warning triangle

Use the warning triangle to warn other road users if the car is stationary in traffic.

Also activate the hazard warning flashers.

## Storage spaces

The warning triangle is located in the compartment on the inside of the tailgate.

## Folding up the warning triangle

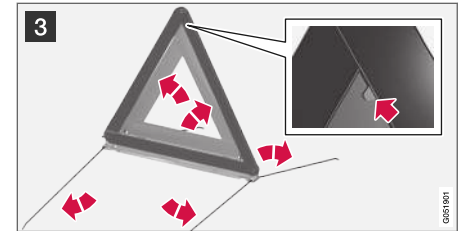
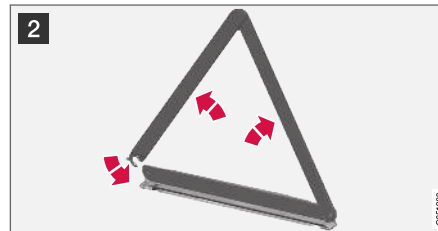
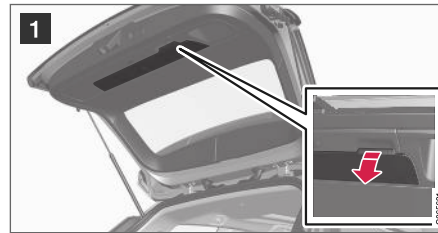

- 1 Grasp the grip on the tailgate's panel to open the hatch for the warning triangle.
- 2 Remove the warning triangle from the case, unfold it and put the ends together.
- 3 Fold out the warning triangle's support legs.

Follow the regulations for the use of a warning triangle. Position the warning triangle in a suitable place with regard to traffic.

Make sure that the warning triangle and case are properly secured in their storage space and that the hatch is fully closed after use.

## Related information

- Cargo area (p. 578)
- Hazard warning flashers (p. 153)



MAINTENANCE AND SERVICE

## Volvo service programme

To keep the car as safe and reliable as possible, follow the Volvo service programme as specified in the Service and Warranty Booklet.

Volvo recommends engaging an authorised Volvo workshop to perform the service and maintenance work. Volvo workshops have the personnel, special tools and service literature to guarantee the highest quality of service.

### IMPORTANT

For the Volvo warranty to apply, check and follow the instructions in the Service and Warranty Booklet.

## Service and repair

Service the car regularly. Follow Volvo's recommended service intervals.

If inspection and repair are required then only an authorised Volvo workshop may carry out the work.

### WARNING

Do not carry out any repairs of your own on this vehicle. Electrical cables and/or components that have detached must only be rectified by an authorised workshop - an authorised Volvo workshop is recommended.

## Charging cable with control unit

### IMPORTANT

Do not modify the control unit in any way.

## Related information

- Car status (p. 592)
- Book service and repair (p. 593)
- Connection of equipment to the car's diagnostic socket (p. 38)
- Servicing the climate control system (p. 598)
- Brake system maintenance (p. 434)
- Engine compartment overview (p. 600)

## Data transfer between car and workshop via Wi-Fi

Volvo's workshops have a specific Wi-Fi network for secure data transfer between your car and the workshop. Your workshop visit will be simpler and more efficient when the transfer of diagnostic information and software can take place via the workshop's network.

During a workshop visit, your service technician may want to connect your car to the workshop's network via Wi-Fi to perform fault-tracing and software download. For this type of communication, the car only connects to a workshop's network. It is not possible to connect the car to another Wi-Fi network, such as at home, in the same way as to a workshop's network.

## Connection with the remote control key

Connection is normally handled by the service technician who then uses the remote control key buttons. That's why it's important to take a key with buttons with you for the workshop visit. Press three times on the lock button on the remote control key to connect the car to the workshop's network via Wi-Fi.

When the car is connected to a Wi-Fi network, the  symbol appears in the centre display.

### WARNING

The car must not be driven when connected to the workshop's networks and systems.



## Related information

- Managing system updates via the Download Centre (p. 591)
- Book service and repair (p. 593)

## Download Center

Several of the car's systems can be updated from the centre display with an online car<sup>1</sup>.

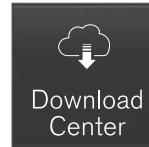

The **Download Centre** app is started from app view in the centre display and enables:

- searching for and updating system software
- updating map data for Sensus Navigation\*
- downloading, updating and uninstalling apps.

## Related information

- Managing system updates via the Download Centre (p. 591)
- Downloading apps (p. 489)
- Updating apps (p. 490)
- Deleting apps (p. 490)
- Internet-connected car\* (p. 521)
- Navigating in the centre display's views (p. 108)

## Managing system updates via the Download Centre

Functions for online car and infotainment can be updated via the Download Centre. Updates can be made one at a time or all at once.

### Searching for update

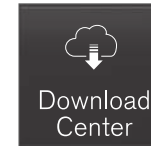

If an update is available, the message **New software updates available** is shown in the centre display's status bar.

For system updates to be possible, the car must be connected to the Internet<sup>2</sup>.

- Go to **Download Centre** in the centre display's app view.
  - > If no search has been performed since the last time the infotainment system was started, a search is performed. No search is performed if a software installation is in progress.

A number on **System updates** shows how many updates are available. One tap shows a list of the updates that can be installed in the car.

<sup>1</sup> Data is transferred (data traffic) when using the Internet, and this may involve a cost.

<sup>2</sup> Data is transferred (data traffic) when using the Internet, and this may involve a cost.



**i NOTE**

Data download may affect other services that transmit data, e.g. Internet radio. If the effect on other services is experienced as disruptive then the download can be interrupted. Alternatively, it may be appropriate to switch off or interrupt other services.

**i NOTE**

An update can be interrupted when the ignition is switched off and the car is left. However, the update does not have to be completed before the car is left, this is because the update is resumed the next time the car is used.

### Update all system software

- Select **Install all** at the bottom of the list.

If no list is desired, then the **Install all** option can be selected at **System updates**.

### Update individual system software programs

- Select **Install** for the software required.

### Cancelling software download

- Tap on X in the activity indicator that has replaced **Install** at the start of the download.

Note that only the download can be cancelled, when the installation phase has started, this cannot be cancelled.

### Deactivating the background search for software update

Automatic search for software updates is activated when the car is delivered from the factory, but this function can be deactivated.

1. Tap on **Settings** in the centre display's top view.
2. Press **System → Download Centre**.
3. Deselect **Auto Software Update**.

### Related information

- Download Center (p. 591)
- Internet-connected car\* (p. 521)
- Navigating in the centre display's views (p. 108)

## Car status

The car's general status can be shown in the centre display along with the opportunity to book service<sup>3</sup>.

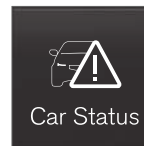

The **Car Status** app is started from app view in the centre display and has four tabs:

<sup>3</sup> Applies to certain markets.

- **Messages** - status messages
- **Status** – checking engine oil level and AdBlue level<sup>4</sup>
- **TPMS** - checking the tyre pressure
- **Appointments** - appointment information and car information<sup>3</sup>.

### Related information

- Handling a message saved from the driver display (p. 100)
- Checking and filling with engine oil (p. 602)
- Tyre pressure monitoring system\* (p. 550)
- Book service and repair (p. 593)
- Sending car information to a workshop (p. 594)
- Navigating in the centre display's views (p. 108)

## Book service and repair<sup>5</sup>

This service provides a convenient way to book a service and workshop visit directly in the car.

When it is time for service, and in some cases when the car is in need of repair, a message will appear in the driver display and at the top of the centre display. The service date is determined by how much time has passed, hours that the engine has been running, or distance driven since the last service.

### Before the service can be used

- Create a Volvo ID and register it to the car.
- Select the Volvo retailer you would like to contact by going to [www.volvocars.com](http://www.volvocars.com) and logging in.
- To send and receive booking information, the car must be connected to the Internet<sup>6</sup>.

### Book a service

Fill in a booking request when so required or when a message indicating that the car needs a service or repair is shown.

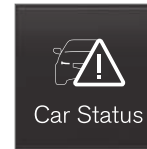

1. Open the **Car Status** app from the app view in the centre display.
2. Press **Appointments**.
3. Press **Request appointment**.
4. Make sure that the correct **Volvo ID** is filled in.
5. Make sure that the desired **Workshop** is filled in.
6. Fill in the field **Tap to write information to the workshop** if there is anything you would like done during the workshop visit or any other important information to your workshop.

<sup>4</sup> AdBlue Applies to cars with diesel engines.

<sup>3</sup> Applies to certain markets.

<sup>5</sup> Applies to certain markets.

<sup>6</sup> Data is transferred (data traffic) when using the Internet, and this may involve a cost.



- ◀ 7. Press **Send appointment request**.
- > You will receive an appointment suggestion via e-mail within a couple of days<sup>7</sup>.  
You will also receive the same communication via e-mail and when you go to [www.volvocars.com](http://www.volvocars.com) and log in.  
In certain markets, once you have sent the appointment request, the message that the car needs service is extinguished in the driver display.
8. Tap on **Cancel request** to cancel your request.

The booking enquiry sent from the car includes car information that facilitates workshop planning.

The retailer comes back with a digital booking proposal. You also have information on your retailer available in the car and can contact your workshop at any time.

### Accept the appointment suggestion

When the car has received an appointment suggestion, a message will be shown at the top of the centre display.

1. Tap the message.
2. If the suggested booking is acceptable, tap on **Accept**. Otherwise, tap on **Send new proposal** or **Decline**.

<sup>7</sup> This time frame may vary depending on market.

<sup>8</sup> Applies to Sensus Navigation\*.

For certain markets, the system reminds you of a scheduled appointment time as it approaches and the navigation system<sup>8</sup> can also guide you to the workshop when the time comes.

### Related information

- Car status (p. 592)
- Sending car information to a workshop (p. 594)
- Navigating in the centre display's views (p. 108)
- Volvo ID (p. 26)
- Internet-connected car\* (p. 521)

## Sending car information to a workshop<sup>9</sup>

It is possible to send information for the car at any time, e.g. if you book a workshop appointment and want to help your workshop by providing them with better data so that your visit can be planned. Sending car information is not the same as booking a service appointment.

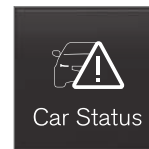

1. Open the **Car Status** app from the app view in the centre display.
2. Press **Appointments**.
3. Press **Send car data**.
  - > A message that vehicle data are being sent is shown at the top of the centre display. You can cancel data transmission by tapping the X in the activity indicator.  
The information is sent via the car's Internet connection<sup>10</sup>.

This car information can be accessed by any retailer if they have the car's identification number (VIN<sup>11</sup>).

## Car information content

The data sent is the last information saved (the last time the car was running) and includes information in the following areas:

- service requirement
- time since last service
- function status
- fluid levels
- meter reading
- the car's vehicle identification number (VIN<sup>11</sup>)
- the car's software version
- the car's diagnostics data.

## Related information

- Book service and repair (p. 593)
- Car status (p. 592)
- Navigating in the centre display's views (p. 108)
- Internet-connected car\* (p. 521)

---

<sup>9</sup> Applies to certain markets.

<sup>10</sup> Data is transferred (data traffic) when using the Internet, and this may involve a cost.

<sup>11</sup> Vehicle Identification Number.

## Raise the car

When raising the car, it is important that the jack is fitted in the intended points on the car's underbody.

Applies to cars with **Leveling Control\***: If the car is equipped with air suspension, this must be disabled before the car is raised.

### **WARNING**

If the car is raised using a workshop jack, this must be placed beneath one of the four jacking points. Take care to position the workshop jack so that the car cannot slip off. Make sure that the jack plate is fitted with a rubber guard so that the car remains stable and is not damaged. Always use axle stands or similar.

### **NOTE**

Volvo recommends only using the jack that belongs to the car model in question. If a jack is selected other than the one recommended by Volvo, follow the instructions supplied with the equipment.

The normal car jack is only designed for occasional, short-term use, such as when changing a wheel after a puncture. If the car is to be jacked up more often, or for a longer time than is required just to change a wheel, use of a garage jack is recommended. In this instance, follow the instructions for use that come with the equipment.

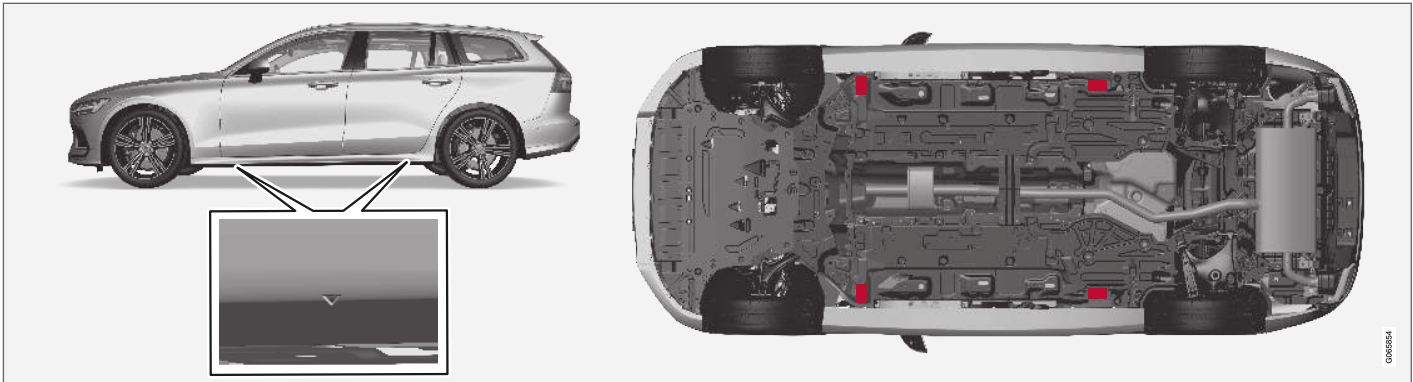

The triangles in the plastic cover indicate the locations of the lifting points (marked in red).

### Related information

- Removing a wheel (p. 557)
- Jack\* (p. 555)
- Settings for level control\* (p. 455)

## Servicing the climate control system

The air conditioning system must only be serviced and repaired by an authorised workshop.

### Troubleshooting and repair

The air conditioning system contains fluorescent tracing agents. Ultraviolet light must be used during leak detection.

Volvo recommends that an authorised Volvo workshop is contacted.

#### Cars with R134a refrigerant

#### WARNING

The air conditioning system contains pressurised refrigerant R134a. This system must only be serviced and repaired by an authorised workshop.

#### Cars with R1234yf refrigerant

#### WARNING

The air conditioning system contains pressurised refrigerant R1234yf. In accordance with SAE J2845 (Technician Training for Safe Service and Containment of Refrigerants Used in Mobile A/C System), service and repair of the refrigerant system must only be performed by trained and certified technicians in order to ensure the safety of the system.

### Related information

- Volvo service programme (p. 590)

## Head up display when replacing the windscreen\*

Cars with head-up display are equipped with a special type of windscreen that meets the requirements for displaying the projected image.

Volvo recommends that you contact an authorised Volvo workshop when replacing the windscreen. The correct version of the windscreen must be fitted in order that the head-up display's graphics shall be displayed correctly.

### Related information

- Head-up display\* (p. 135)
- Cleaning the head up display\* (p. 626)



## Opening and closing the bonnet

The bonnet can be opened using the handle in the passenger compartment and a handle under the bonnet.

### Open the bonnet

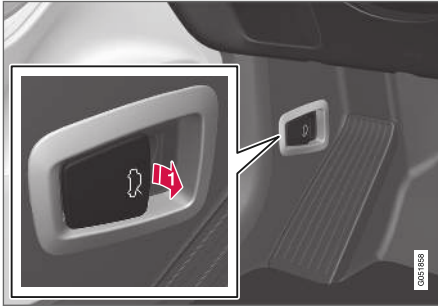

- Pull the handle near the foot pedals to release the bonnet from its fully closed position.



- Sweep from left to right in the opening under the bonnet, move the handle up and to the side to release the bonnet from the bonnet lock's catch and lift the bonnet.

### Warning - bonnet not closed



When the bonnet is released, a warning symbol and graphics in the driver display will light up and an acoustic reminder will sound. If the car starts rolling, an acoustic warning signal will repeat.

### NOTE

If the warning symbol is lit or the warning signal is heard despite the bonnet being closed properly, contact an authorised Volvo workshop.

## Close the bonnet

1. Push the bonnet down until it starts to fall from its own weight.
2. When the bonnet stops against the lock catch, push the bonnet to close it completely.

### WARNING

Risk of crushing! Ensure that the closing path under the bonnet is not obstructed, otherwise there is a risk of personal injury.

### WARNING

Check that the bonnet locks properly when closed. The bonnet must engage at both sides audibly.



Bonnet not completely closed.



Bonnet completely closed.

**⚠ WARNING**

Never drive with an open bonnet!

If there are any signs that the bonnet is not properly closed whilst driving, stop immediately and close it.

**Related information**

- Engine compartment overview (p. 600)
- Door and seatbelt reminder (p. 49)

**Engine compartment overview**

The overview shows some service-related components.

Some of the components included in the car's electric drive system are located under the bonnet. Exercise caution in this area and only touch anything that is related to normal maintenance.

**⚠ WARNING**

Orange-coloured cables must only be handled by qualified personnel.

**⚠ WARNING**

Several components in the car work with high-voltage current that could be dangerous in the event of incorrect intervention.

- Do not touch anything that is not clearly described in the owner's manual.
- Exercise caution when checking/refilling fluids in the engine compartment.

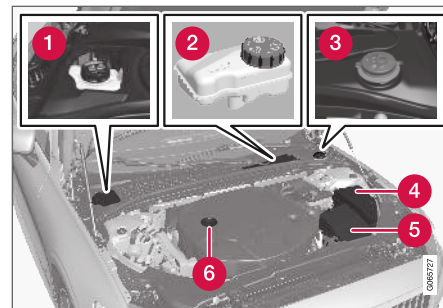

The appearance of the engine compartment may differ depending on model and engine variant.

- 1 Coolant expansion tank
- 2 Reservoir for brake fluid (located on the driver's side)
- 3 Washer fluid filler pipe<sup>12</sup>
- 4 Central electrical unit
- 5 Air filter
- 6 Engine oil filler pipe

<sup>12</sup> Fill the washer fluid at regular intervals, e.g. when refuelling.

**⚠ WARNING**

Remember that the radiator fan (located at the front of the engine compartment, behind the radiator) may start or continue to operate automatically for up to approx. 6 minutes after the engine has been switched off.

Always have the engine cleaned by a workshop - an authorised Volvo workshop is recommended. There is a risk of fire if the engine is hot.

**⚠ WARNING**

The ignition system works at a very high and hazardous voltage. The car's electrical system must always be in ignition position **0** when work is being performed in the engine compartment.

Do not touch the spark plugs or ignition coil when the car's electrical system is in ignition position **II** or when the engine is hot.

**Related information**

- Opening and closing the bonnet (p. 599)
- Filling washer fluid (p. 641)
- Topping up coolant (p. 603)
- Fuses in engine compartment (p. 614)
- Checking and filling with engine oil (p. 602)
- Ignition positions (p. 428)

**Engine oil**

An approved engine oil must be used in order that the recommended service intervals and warranty can be applied.

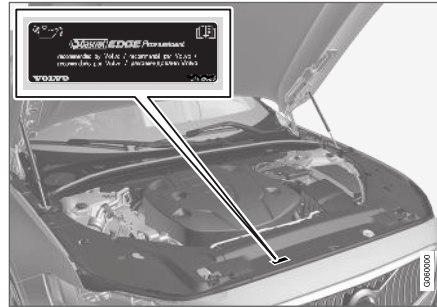

Volvo recommends:



If the engine oil cannot be checked on a regular basis and the level falls too low, there is a risk that this will cause serious damage to the engine.

**! IMPORTANT**

In order to fulfil the requirements for the engine's service intervals all engines are filled with a specially adapted synthetic engine oil at the factory. The choice of oil has been made very carefully with regard to service life, starting characteristics, fuel consumption and environmental impact.



An approved engine oil must be used in order that the recommended service intervals can be applied. Only use a prescribed grade of oil for both filling and oil change, otherwise there is a risk of the service life, starting characteristics, fuel consumption and environmental impact of the car being affected.

If engine oil of the prescribed grade and viscosity is not used, engine related components may become damaged. Volvo Car Corporation disclaims any liability for any such damage.

Volvo recommends that oil changes are carried out at an authorised Volvo workshop.

Volvo uses different systems to warn about the oil level if it is too low/high, or in the event of low oil pressure. Certain engine variants have an oil pressure sensor, and then the driver display's



◀ warning symbol for low oil pressure  is used. Other variants have an oil level sensor, when the driver is informed via the driver display's warning symbol  and display texts. Certain variants have both systems. Contact a Volvo dealer for more information.

Change the engine oil and oil filter in accordance with the intervals specified in the Service and Warranty Booklet. Using oil of a higher than specified grade is permitted. If the car is driven in adverse conditions, Volvo recommends using an oil of a higher grade than the one specified.

### Related information

- Checking and filling with engine oil (p. 602)
- Engine oil — specifications (p. 653)
- Adverse driving conditions for engine oil (p. 654)

## Checking and filling with engine oil

The oil level is detected with the electronic oil level sensor.

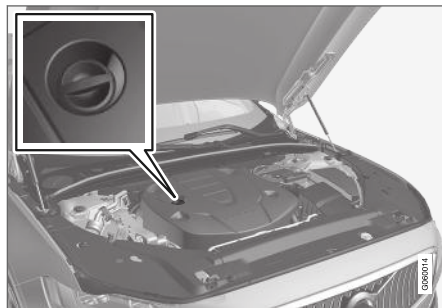

Filler pipe<sup>13</sup>.

In some cases, oil may need to be topped up between service intervals.

No action with regard to engine oil level needs to be taken until a message is shown in the driver display.

### WARNING



If this symbol is shown together with the message **Engine oil level Service required**, visit a workshop - an authorised Volvo workshop is recommended. The oil level may be too high.

### IMPORTANT



If this symbol is shown together with a message about low oil level, such as **Engine oil level low Refill 1 litre** for example, then only fill the volume specified, e.g. 1 litre (1 quart).

### WARNING

Do not spill oil onto the hot exhaust manifold due to the risk of fire.

## See oil level in the centre display

The oil level is visualised using the electronic oil level gauge in the centre display when the car has been started. The oil level should be checked regularly.

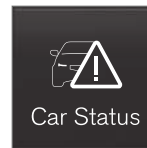

1. Open the **Car Status** app from the app view in the centre display.
2. Press **Status** to show the oil level.

<sup>13</sup> Engines with electronic oil level sensor do not have a dipstick.

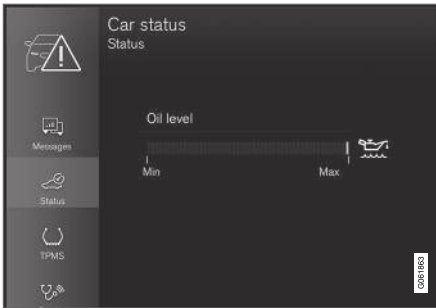

Graphics for oil level in the centre display.

### **i NOTE**

The system cannot directly detect changes when the oil is filled or drained. The car must have been driven approx. 30 km (approx. 20 miles) and have been stationary for 5 minutes with the engine switched off and on level ground before the oil level indication is correct.

### **i NOTE**

If the right conditions for measuring the oil level (time after engine shutdown, the car's inclination, outside temperature, etc.) are not met, then the message **No value available** will be shown in the centre display. This does **not** mean that there is something wrong in the car's systems.

### Related information

- Engine oil (p. 601)
- Adverse driving conditions for engine oil (p. 654)
- Engine oil — specifications (p. 653)
- Ignition positions (p. 428)
- Car status (p. 592)

### Topping up coolant

The coolant cools the internal combustion engine to the correct operating temperature. The heat that is transferred from the engine to the coolant can be used to heat the passenger compartment.

When topping up the coolant, follow the instructions on the packaging. Never top up with water only. The risk of freezing increases with both too little and too much coolant concentrate.

If there is coolant under the car, if there is coolant smoke, or if more than 2 litres (approx. 2 quarts) have been filled, always call for recovery to avoid the risk of engine damage due to a defective cooling system when attempting to start the car.

### **! WARNING**

The coolant may be very hot. Never open the cap when the coolant is hot. If a top-up is required, unscrew the expansion tank cap slowly to allow any overpressure to disappear.

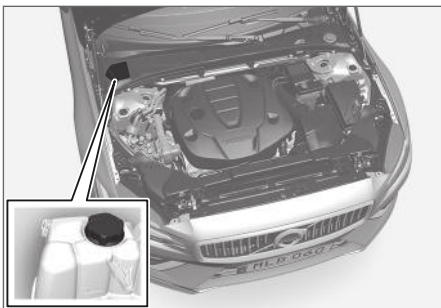

Coolant expansion tank.



- 1 Open the lid on the plastic cover.
- 2 Screw off the cap and top up with coolant if necessary. The coolant level must not exceed the yellow **MAX** mark inside the expansion tank.

Reinstall the parts in reverse order.

**!** **IMPORTANT**

- Harmful if ingested. May cause organ (kidney) damage.
- Use ready-mixed coolant as recommended by Volvo. If concentrated liquid is used, make sure that the ratio is 50 % coolant to 50 % water of an approved quality.
- Do not mix different coolants.
- Only new coolant should be used when replacing major cooling system components to ensure the system has sufficient corrosion protection.
- The engine must only be run with a well-filled cooling system. Otherwise, temperatures that are too high may occur resulting in the risk of damage (cracks) in the cylinder head.
- A high content of chlorine, chlorides and other salts may cause corrosion in the cooling system.

**Related information**

- Engine compartment overview (p. 600)
- Coolant — specifications (p. 655)

## Bulb replacement

Lamp types vary depending on model and equipment level. If a bulb<sup>14</sup> breaks, it can be replaced according to the method described in the Owner's Manual.

Contact a workshop<sup>15</sup> if faults occur in lamps other than bulbs.

If a fault occurs in LED<sup>16</sup> lamps, the entire lamp unit usually must be replaced.

### NOTE

For information about bulbs not covered in this Owner's Manual, contact a Volvo dealer or a certified Volvo service technician.

### NOTE

Outside lighting such as headlamps and rear lamps may temporarily have condensation on the inside of the lens. This is normal, all exterior lighting is designed to withstand this. Condensation is normally vented out of the lamp housing when the lamp has been switched on for a time.

<sup>14</sup> Some cars have no bulbs.

<sup>15</sup> An authorised Volvo workshop is recommended.

<sup>16</sup> LED (Light Emitting Diode)

## Starter battery

The electrical system is single-pole and uses the chassis and engine casing as a conductor.

The starter battery is used to start up the electrical system and drive electrical equipment in the car. The hybrid battery is used when the internal combustion engine is started.

The starter battery should be replaced by a workshop<sup>17</sup>.

The starter battery is a 12 V AGM battery (Absorbed Glass Mat), designed for regenerative charging, and to support the functionality of the car's different systems.

The service life and function of the starter battery is influenced by factors such as the number of starts, discharging, driving style, driving conditions, climatic conditions etc.

- Never disconnect the starter battery when the engine is running.
- Check that the cables to the starter battery are correctly connected and properly tightened.

### WARNING



- The battery can generate oxyhydrogen gas, which is highly explosive. A spark can be formed if a jump lead is connected incorrectly, and this can be enough for the battery to explode.
- Do not connect the jump leads to any fuel system component or any moving part. Be careful of hot engine parts.
- The battery contains sulphuric acid, which can cause serious burns.
- If sulphuric acid comes into contact with eyes, skin or clothing, flush with large quantities of water. If acid splashes into the eyes - seek medical attention immediately.
- Never smoke near the battery.

### Charging points

When connecting an external starter battery or battery charger, use the car's charging points in the engine compartment.

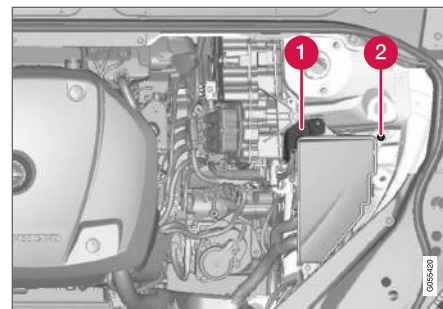
The battery terminals on the car's starter battery in the luggage/cargo area must **not** be used.



-  Positive charging point
-  Negative charging point

### IMPORTANT

It is not possible to charge another car's battery by means of current through the charging points. Using the charging points to charge another car's battery may cause a fuse to blow, which means that the charging points will stop working.

<sup>17</sup> An authorised Volvo workshop is recommended.



**! IMPORTANT**

When charging the starter battery, only use a modern battery charger with controlled charging voltage. Fast charging function must not be used since it may damage the battery.

**i NOTE**

If both the starter battery and the hybrid battery are discharged then **both** batteries must be charged. In such a case, charging only the hybrid battery first is not possible.

In order for the hybrid battery to be charged the starter battery must have a certain state of charge.

**! IMPORTANT**

If the following instruction is not observed then the energy saving function for infotainment may be temporarily disengaged, and/or the message in the driver display about the starter battery's state of charge may be temporarily inapplicable, following the connection of an external starter battery or battery charger:

- The negative battery terminal on the car's starter battery must **never** be used for connecting an external starter battery or battery charger - only the **car's negative charging point** may be used as the grounding point.

**i NOTE**

The life of the battery is shortened if it becomes discharged repeatedly.

The life of the battery is affected by several factors, including driving conditions and climate. Battery starting capacity decreases gradually with time and therefore needs to be recharged if the car is not used for a longer time or when it is only driven short distances. Extreme cold further limits starting capacity.

To maintain the battery in good condition, at least 15 minutes of driving/week is recommended or that the battery is connected to a battery charger with automatic trickle charging.

A battery that is kept fully charged has a maximum service life.

◀ **Location**



The starter battery is located in the cargo area.

**⚠ WARNING**

If the starter battery is disconnected, the automatic opening and closing function must be reset to work properly. A reset must take place for pinch protection to work.

**! IMPORTANT**

On certain models, the battery is attached with a retaining strap. Make sure the retaining strap is properly tightened.

**Specifications for starter battery**

Battery type	H8 AGM
Voltage (V)	12
Cold start capacity <sup>A</sup> - CCA <sup>B</sup> (A)	850
Size, LxBxH	353x175x190 mm (13.9x6.9x7.5 inches)
Capacity (Ah)	95

A According to EN standard.

B Cold Cranking Amperes.

Volvo recommends entrusting battery replacement to an authorised Volvo workshop.

**!** **IMPORTANT**

If the battery is replaced, make sure you replace it with a battery with the same size, cold starting capacity and type as the original battery (see the decal on the battery).

**Related information**

- Symbols on the batteries (p. 611)
- Hybrid battery (p. 610)
- Using jump starting with another battery (p. 467)
- Reset sequence for pinch protection (p. 161)
- Battery recycle (p. 611)

## Hybrid battery

The car is equipped with a hybrid battery for electric motor operation - a maintenance-free rechargeable Lithium-ion type battery.

### **i** NOTE

The car cannot be started if the hybrid battery is discharged.

### **i** NOTE

If both the starter battery and the hybrid battery are discharged then **both** batteries must be charged. In such a case, charging only the hybrid battery first is not possible.

In order for the hybrid battery to be charged the starter battery must have a certain state of charge.

### **⚠** WARNING

The hybrid battery must only be replaced by a workshop - an authorised Volvo workshop is recommended.

## Coolant

The hybrid battery's cooling system has a separate expansion tank.

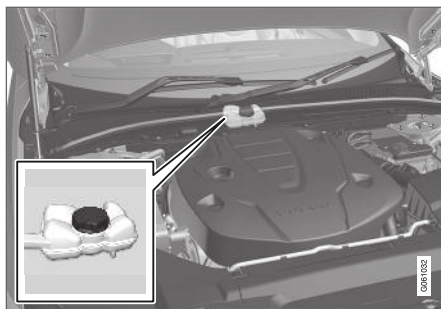

### **!** IMPORTANT

The hybrid battery's coolant must only be topped up by a workshop - an authorised Volvo workshop is recommended.

## Specifications for hybrid battery

**Type:** Lithium-ion

**Total amount of energy:** 10.4 kWh.

### **i** NOTE





The capacity of the hybrid battery diminishes with age and use, which may result in increased use of the internal combustion engine and, as a consequence, reduced fuel economy and reduced range during electric operation.

## Related information

- Symbols on the batteries (p. 611)
- Starter battery (p. 606)
- Charging the hybrid battery (p. 405)
- Battery recycle (p. 611)

## Symbols on the batteries

There are information and warning symbols on the batteries.

	Use protective goggles.
	Further information in the owner's manual for the car.
	Store the battery out of the reach of children.
	The battery contains corrosive acid.

	Avoid sparks and naked flames.
	Risk of explosion.
	Must be taken for recycling.

### Related information

- Starter battery (p. 606)
- Hybrid battery (p. 610)
- Battery recycle (p. 611)

## Battery recycle

A used starter battery should be recycled in an environmentally sound manner – it contains lead.

Consult a workshop in the event of uncertainty about how this type of waste should be discarded – an authorised Volvo workshop is recommended.

### Related information

- Starter battery (p. 606)
- Hybrid battery (p. 610)
- Symbols on the batteries (p. 611)

## Fuses and central electrical units

All electrical functions and components are protected by a number of fuses in order to protect the car's electrical system from damage by short circuiting or overloading.

### WARNING

Never use a foreign object or a fuse with an amperage higher than that specified when replacing a fuse. This could cause significant damage to the electrical system and possibly lead to fire.

### WARNING

Orange-coloured cables must only be handled by qualified personnel.

### WARNING

Several components in the car work with high-voltage current that could be dangerous in the event of incorrect intervention.

Do not touch anything that is not clearly described in the owner's manual for the car.

If an electrical component or function does not work, it may be because the component's fuse was temporarily overloaded and failed. If the same fuse fails repeatedly then there is a fault in the circuit. Volvo recommends contacting an authorised Volvo workshop for checking.

## Location of central electrical units

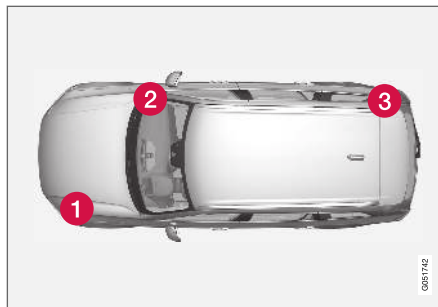

The figure is schematic - appearance may vary depending on car model.

Central electrical unit locations in a left-hand drive car. In a right-hand drive car the central electrical units under the glovebox change sides.

- 1 Engine compartment
- 2 Under the glovebox
- 3 Cargo area

### Related information

- Replacing a fuse (p. 612)
- Fuses in cargo area (p. 621)
- Fuses in engine compartment (p. 614)
- Fuses under glovebox (p. 618)

## Replacing a fuse

All electrical functions and components are protected by a number of fuses in order to protect the car's electrical system from damage by short circuiting or overloading.

1. Look in the fuse diagram to locate the fuse.
2. Pull out the fuse and check from the side to see whether the curved wire has blown.
3. If this is the case, replace it with a new fuse of the same colour and amperage.

### WARNING

Never use a foreign object or a fuse with an amperage higher than that specified when replacing a fuse. This could cause significant damage to the electrical system and possibly lead to fire.

### WARNING

Contact an authorised Volvo workshop about the fuses not mentioned in the owner's manual. If this is not performed correctly, it can cause serious damage to the electrical systems.

### Related information

- Fuses and central electrical units (p. 612)
- Fuses in cargo area (p. 621)

- Fuses in engine compartment (p. 614)
- Fuses under glovebox (p. 618)





On the inside of the cover there are tweezers that facilitate the procedure for the removal and fitting of fuses.

The fuse box also provides space for several spare fuses.

### Positions

On the inside of the cover is a label that shows the location of the fuses.

- Fuses 1-13, 18-30, 35-37 and 46-70 are of the "Micro" type.
- Fuses 14-17, 31-34, 38-45 and 71-78 are of the "MCase" type and should be replaced by a workshop<sup>18</sup>.

	Function	Ampere
1	-	-
2	-	-
3	-	-
4	Control module for actuator for engagement/change of automatic gearbox gear positions	5
5	Control module for the high-voltage heater of the internal combustion engine's coolant	5

	Function	Ampere
6	Control module for air conditioning; Shut-off valve for heat exchanger; Shut-off valve for coolant that passes through the climate control system	5
7	Control module for hybrid battery; High voltage converter for combined high-voltage generator/starter motor with voltage converter 500 V-12 V	5
8	-	-
9	Converter for control of the supply to the rear axle's electric motor	10
10	Control module for hybrid battery; High voltage converter for combined high-voltage generator/starter motor with voltage converter 500 V-12 V	10
11	Charging unit	5
12	Shut-off valve for the hybrid battery's coolant; Coolant pump 1 for hybrid battery	10

	Function	Ampere
13	Coolant pump for electric drive system	10
14	Cooling fan for hybrid components	25
15	-	-
16	-	-
17	-	-
18	-	-
19	-	-
20	-	-
21	-	-
22	-	-
23	-	-
24	12 V socket in tunnel console, front	15
25	12 V socket in tunnel console, by legroom for second seat row	15

<sup>18</sup> An authorised Volvo workshop is recommended.



	Function	Ampere
26	12 V socket in cargo area* USB ports for iPad holder	15
27	-	-
28	-	-
29	-	-
30	-	-
31	Heated windscreen* left-hand side	Shunt
32	Heated windscreen* left-hand side	40
33	Headlamp washers*	25
34	Windscreen washers	25
35	-	-
36	Horn	20
37	Siren*	5
38	Control module for brake system (valves, parking brake)	40
39	Windscreen wipers	30
40	Rear window washer	25

	Function	Ampere
41	Heated windscreen* right-hand side	40
42	Parking heater*	20
43	Control unit for brake system (ABS pump)	40
44	-	-
45	Heated windscreen* right-hand side	Shunt
46	Supplied when the ignition is switched on: Engine control module; Transmission components; Electric steering servo; Central electronic module	5
47	Exterior car noise (certain markets)	5
48	Right-hand headlamp	7,5
	Right-hand headlamp, certain variants of LED <sup>A</sup>	15
49	Alcohol lock*	5
50	-	-
51	-	-
52	Airbags	5

	Function	Ampere
53	Left-hand headlamp	7,5
	Left-hand headlamp, certain variants of LED <sup>A</sup>	15
54	Accelerator pedal sensor	5
55	Transmission control module; Control module for gear selector	15
56	Engine Control Module (ECM)	5
57	-	-
58	-	-
59	-	-
60	-	-
61	Engine control module; Actuator; Throttle unit; Valve for turbocharger	20
62	Solenoids; Valve; Thermostat for engine cooling system	10
63	Vacuum regulators; Valve	7,5
64	Control module, spoiler roller cover; Control module, radiator roller cover	5

	Function	Ampere
65	-	-
66	Lambda-sond, front; Lambda-sond, rear	15
67	Solenoid for engine oil pump; Solenoid clutch A/C; Lambda sond, centre	15
68	-	-
69	Engine Control Module (ECM)	20
70	Ignition coils; Spark plugs	15
71	-	-
72	-	-
73	Control module for transmission fluid pump	30
74	Control module for vacuum pump	40
75	Actuator for transmission	25
76	-	-
77	-	-
78	-	-

A LED (Light Emitting Diode)

### Related information

- Fuses and central electrical units (p. 612)
- Replacing a fuse (p. 612)

## Fuses under glovebox

Fuses under the glovebox protect, amongst other things, electrical sockets, displays and door modules.

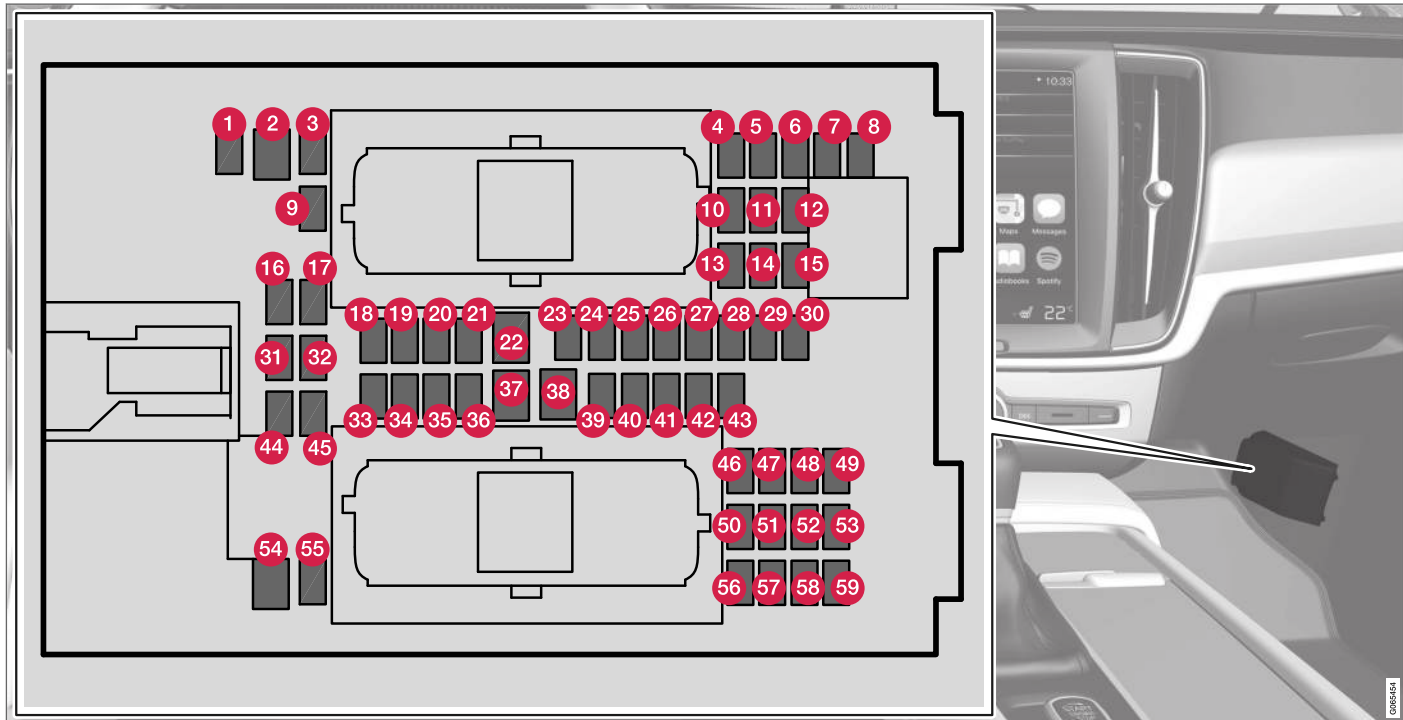

On the inside of the cover there are tweezers that facilitate the procedure for the removal and fitting of fuses.

The **fuse box in the engine compartment** also provides space for several spare fuses.

### Positions

- Fuses 1, 3-21, 23-36, 39-53 and 55-59 are of the "Micro" type.
- Fuses 2, 22, 37-38 and 54 are of the "MCASE" type and should be replaced by a workshop<sup>19</sup>.

	Function	Ampere
1	-	-
2	-	-
3	-	-
4	Movement detector*	5
5	Media player	5
6	Driver display	5
7	Keypad in centre console	5
8	Sun sensor	5
9	-	-

	Function	Ampere
10	-	-
11	Steering wheel module	5
12	Module for start knob and for parking brake control	5
13	Steering wheel module for heated steering wheel*	15
14	-	-
15	-	-
16	-	-
17	-	-
18	Control module for climate control system	10
19	Steering lock	7,5
20	Diagnostic socket OBDII	10
21	Centre display	5
22	Fan module for climate control system, front	40
23	USB HUB	5

	Function	Ampere
24	Controls lighting; Interior lighting; Dimming of interior rear-view mirror*; Rain and light sensor*; Keypad in tunnel console, by legroom for rear seat*; Power front seats*; Control panels in rear doors; Fan module for climate control left/right	7,5
25	Control module for driver support functions	5
26	Panorama roof with sun blind*	20
27	Head-up display*	5
28	Passenger compartment lighting	5
29	-	-
30	Display in roof console (Seat-belt reminder/Indicator for air-bag on the front passenger seat)	5
31	-	-
32		

<sup>19</sup> An authorised Volvo workshop is recommended.



	Function	Ampere
33	-	-
34	Fuses in cargo area	10
35	Control module for online car; Control module for Volvo On Call	5
36	-	20 -
37	Audio control device (amplifier)	40
38	-	-
39	Module for multi-band antenna	5
40	Modules for seat comfort (massage) front*	5
41	Alcohol lock*	5
42	Rear window wiper	15
43	Control module for fuel pump	15
44	Relay coils in central electrical unit in engine compartment; relay coil for transmission fluid pump	5
45	-	-

	Function	Ampere
46	Seat heating, driver's side front	15
47	Seat heating, passenger side front	15
48	Coolant pump	7,5
49	-	-
50	Power driver's seat*	20
51	Control module for suspension (active chassis)*	20
52	-	-
53	Sensus control module	10
54	-	-
55	-	-
56	Electrically operated front passenger seat*	20
57	-	-
58	TV* (certain markets)	5
59	Primary fuse for fuses 52, 53, 57 and 58	15

**Related information**

- Fuses and central electrical units (p. 612)
- Replacing a fuse (p. 612)

## **Fuses in cargo area**

Fuses in the cargo area protect, amongst other things, power seats\*, airbags and seatbelt tensioners.



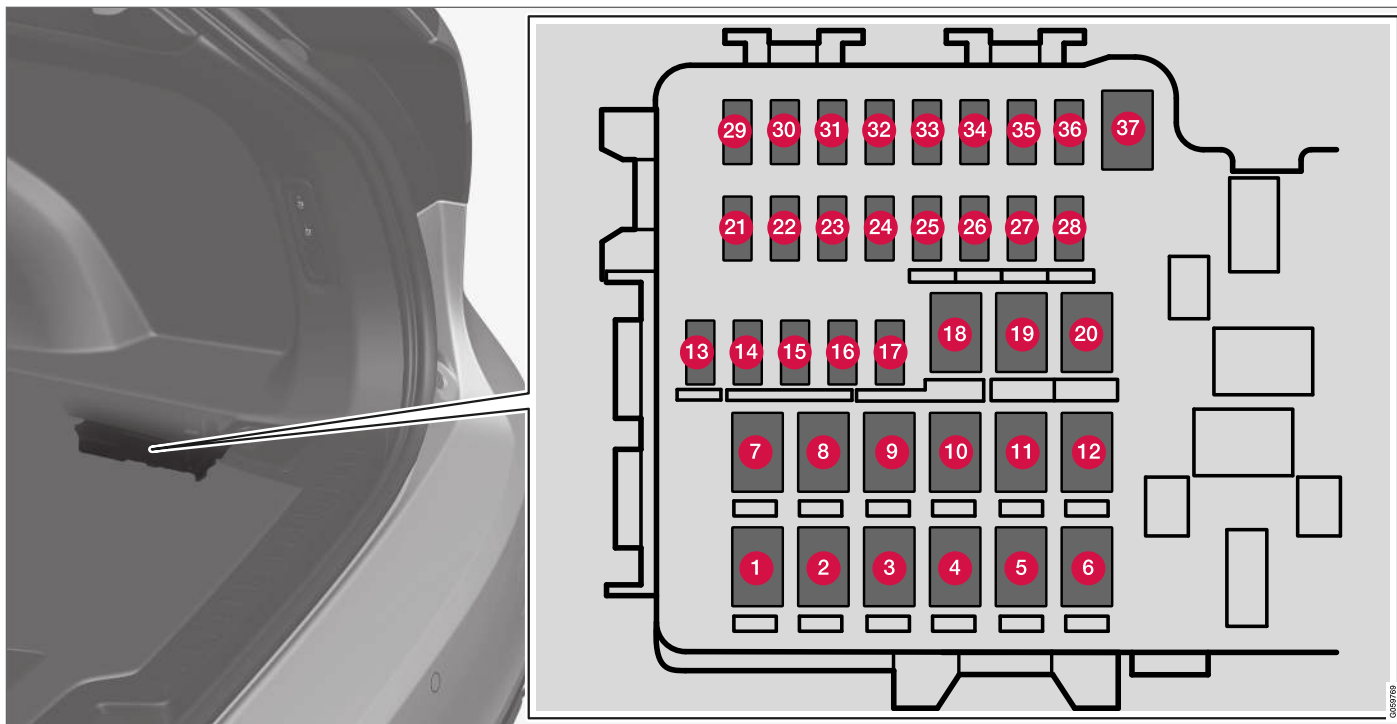

The central electrical unit is located on the right-hand side.

On the inside of the cover there are tweezers that facilitate the procedure for the removal and fitting of fuses.

The **fuse box in the engine compartment** also provides space for several spare fuses.



**Positions**

- Fuses 13-17 and 21-36 are of the "Micro" type.
- Fuses 1-12, 18-20 and 37 are of the "MCCase" type and should be replaced by a workshop<sup>20</sup>.

	Function	Ampere
1	Rear window defroster	30
2	Central electronic module	40
3	Compressor for air suspension*	40
4	Lock motor for backrest on rear right-hand side	15
5	–	–
6	Lock motor for backrest on rear left-hand side	15
7	Electrically operated front passenger seat* Door module right-hand side rear	20
8	Control module for reduction of nitrous oxides (diesel)	30
9	Power operated tailgate*	25

	Function	Ampere
10	Electrically operated front passenger seat* Door module right-hand side front	20
11	Towbar control module*	40
12	Seatbelt pretensioner module, right-hand side	40
13	Internal relay coils	5
14	Door module left-hand side rear	20
15	Module for detecting foot movement* (for opening the power operated tailgate)	5
16	Alcohol lock*, USB hub/ accessory port	5
17	–	–
18	Towbar control module* Accessory module	25 40
19	Door module left-hand side front	20

	Function	Ampere
20	Seatbelt pretensioner module, left-hand side	40
21	Parking camera*	5
22	–	–
23	–	–
24	–	–
25	Supply when the ignition is switched on	10
26	Control module for airbags and seatbelt tensioners	5
27	–	–
28	Seat heating left-hand side rear*	15
29	–	–
30	Blind Spot Information (BLIS)*: control module, exterior reversing sound	5
31	–	–
32	Seatbelt pretensioner modules	5

<sup>20</sup> An authorised Volvo workshop is recommended.





	Function	Ampere
33	Actuator for exhaust gases (petrol, certain engine variants)	5
34	-	-
35	-	-
36	Seat heating right-hand side rear*	15
37	-	-

**Related information**

- Fuses and central electrical units (p. 612)
- Replacing a fuse (p. 612)

## Cleaning the interior

Only use cleaning agents and car care products recommended by Volvo. Clean regularly and treat stains at once for best results. Vacuuming is important prior to using cleaning agents.

### ! IMPORTANT

- Certain items of coloured clothing (e.g. dark jeans and suede garments) may stain the upholstery. If this occurs, it is important to clean and treat these parts of the upholstery as soon as possible.
- Never use strong solvents such as washer fluid, pure petrol or white spirit or concentrated alcohol to clean the interior, since this may damage the upholstery as well as other interior materials.
- Never spray the cleaning agent directly onto components that have electrical buttons and controls. Wipe them instead using a moistened cloth containing the cleaning agent.
- Sharp objects and Velcro may damage the fabric upholstery.
- Only use cleaning agents on the type of material for which they were intended.

## Related information

- Cleaning the centre display (p. 625)
- Cleaning fabric upholstery and headlining (p. 627)
- Cleaning the seatbelts (p. 627)
- Cleaning floor mats and inlay mats (p. 627)
- Cleaning leather upholstery (p. 628)
- Cleaning the leather steering wheel (p. 629)
- Cleaning interior plastic, metal and wood parts (p. 629)

## Cleaning the centre display

Dirt, stains and grease from fingers can affect the centre display's performance and readability. Clean the screen frequently with a microfibre cloth.



To clean the centre display:

1. Turn off the centre display with a long press on the home button.
2. Wipe the screen with the microfibre cloth supplied or use another microfibre cloth of equivalent quality. The screen should be wiped with a clean and dry microfibre cloth with small circular movements. If necessary, lightly moisten the microfibre cloth with clean water.
3. Activate the display with a short press on the home button.





**! IMPORTANT**

The microfibre cloth used to clean the centre display must be free from sand and dirt.

**! IMPORTANT**

When cleaning the centre display, only use gentle pressure on the screen. Heavy pressure can damage the screen.

**! IMPORTANT**

Do not spray any liquid or caustic chemicals directly on the centre display. Do not use window cleaning agent, other cleaning agents, aerosol spray, solvents, alcohol, ammonia or cleaning agent containing abrasive.

Never use abrasive cloths, paper towels or tissue paper, since they may scratch the centre display.

**Related information**

- Cleaning the interior (p. 625)
- Cleaning fabric upholstery and headlining (p. 627)
- Cleaning the seatbelts (p. 627)
- Cleaning floor mats and inlay mats (p. 627)
- Cleaning leather upholstery (p. 628)

- Cleaning the leather steering wheel (p. 629)
- Cleaning interior plastic, metal and wood parts (p. 629)

**Cleaning the head up display\***

Gently wipe the display's cover glass with a clean and dry microfibre cloth. If necessary, lightly moisten the microfibre cloth.

Never use strong stain removers. A special cleaning agent available from Volvo dealers can be used for more difficult cleaning.

**Related information**

- Activating and deactivating the head-up display\* (p. 137)
- Head-up display\* (p. 135)

## Cleaning fabric upholstery and headlining

Only use cleaning agents and car care products recommended by Volvo. Clean regularly and treat stains at once for best results. Vacuuming is important prior to using cleaning agents.

## Fabric upholstery and ceiling upholstery

When you need to clean the textile upholstery or headliner, never scrape or rub a stain as this may destroy the fabric. Nor should you ever use stain removing agents, as this risks discoloration of the fabric.

### Related information

- Cleaning the interior (p. 625)
- Cleaning the centre display (p. 625)
- Cleaning the seatbelts (p. 627)
- Cleaning floor mats and inlay mats (p. 627)
- Cleaning leather upholstery (p. 628)
- Cleaning the leather steering wheel (p. 629)
- Cleaning interior plastic, metal and wood parts (p. 629)

## Cleaning the seatbelts

Only use cleaning agents and car care products recommended by Volvo. Clean regularly and treat stains at once for best results. Vacuuming is important prior to using cleaning agents.

### Seatbelts

Use water and a synthetic detergent. A special textile cleaning agent is available from Volvo retailers. Ensure that the seatbelt is dry before allowing it to retract.

### Related information

- Cleaning the interior (p. 625)
- Cleaning the centre display (p. 625)
- Cleaning fabric upholstery and headlining (p. 627)
- Cleaning floor mats and inlay mats (p. 627)
- Cleaning leather upholstery (p. 628)
- Cleaning the leather steering wheel (p. 629)
- Cleaning interior plastic, metal and wood parts (p. 629)

## Cleaning floor mats and inlay mats

Only use cleaning agents and car care products recommended by Volvo. Clean regularly and treat stains at once for best results. Vacuuming is important prior to using cleaning agents.

### Inlay mats and floor mat

Remove inlaid carpets for separate cleaning of the floor carpet and the inlaid carpets. Use a vacuum cleaner to remove dust and dirt.

#### NOTE

The inlay mats must not be swung around without care or hit against objects to remove dirt since this can crack the inlay mats.

Each inlay mat is secured with pins.

Remove the inlay mat by taking hold of the inlay mat at each pin and lifting the mat straight up.

Fit the inlay mat in place by pressing it in at each pin.

#### WARNING

Only use one inlay mat at each seat, and check before setting off that the mat by the driver's seat is firmly affixed and secured in the pins so that it does not get caught adjacent to and under the pedals.

A special textile cleaner is recommended for stains on the floor mat after vacuuming. Floor



- ◀ mats should be cleaned with agents recommended by Volvo retailers.

### Related information

- Cleaning the interior (p. 625)
- Cleaning the centre display (p. 625)
- Cleaning fabric upholstery and headlining (p. 627)
- Cleaning the seatbelts (p. 627)
- Cleaning leather upholstery (p. 628)
- Cleaning the leather steering wheel (p. 629)
- Cleaning interior plastic, metal and wood parts (p. 629)

### Cleaning leather upholstery

Only use cleaning agents and car care products recommended by Volvo. Clean regularly, and treat stains straight away for best results. Vacuuming is important prior to using cleaning agents.

#### Leather upholstery\*

Volvo's leather upholstery is treated to preserve its original appearance.

Leather upholstery is a natural product that changes and acquires a beautiful patina over time. Regular cleaning and treatment are required in order that the properties and colours of the leather shall be preserved. Volvo offers a comprehensive product, Volvo Leather Care Kit/Wipes, for cleaning and treatment of leather upholstery. The protective outer layer of the leather is preserved when this is used according to the instructions.

To achieve results that are as good as possible, Volvo recommends cleaning and application of the protective cream one to four times per year (or more frequently if required). Volvo Leather Care Kit/Wipes is available from Volvo dealers.

#### Cleaning the leather upholstery

1. Apply the leather cleaner to a damp sponge and squeeze until a foam is created.
2. Use the sponge on the stain in a circular motion.

3. Thoroughly dampen the stain using the sponge, allow the sponge to absorb the stain without scrubbing.
4. Wipe the stain with a soft cloth and allow the leather to dry thoroughly.

#### Protecting the leather upholstery

1. Apply a small amount of leather protective agent to a cloth and then apply it to the leather in light circular motions.
2. Allow to dry for about 20 minutes.

Protecting the leather upholstery makes it more resistant to the stresses from the sun's UV radiation.

#### Related information

- Cleaning the interior (p. 625)
- Cleaning the centre display (p. 625)
- Cleaning fabric upholstery and headlining (p. 627)
- Cleaning the seatbelts (p. 627)
- Cleaning floor mats and inlay mats (p. 627)
- Cleaning the leather steering wheel (p. 629)
- Cleaning interior plastic, metal and wood parts (p. 629)

## Cleaning the leather steering wheel

Only use cleaning agents and car care products recommended by Volvo. Clean regularly, and treat stains straight away for best results. Vacuuming is important prior to using cleaning agents.

### Leather steering wheel

Leather needs to breathe. Never cover the leather steering wheel with protective plastic. We recommend Volvo Leather Care Kit/Wipes for cleaning the leather steering wheel. First remove dirt, dust, etc. with a damp sponge or cloth.

#### IMPORTANT

Sharp objects, e.g. rings, can damage the leather on the steering wheel.

### Related information

- Cleaning the interior (p. 625)
- Cleaning the centre display (p. 625)
- Cleaning fabric upholstery and headlining (p. 627)
- Cleaning the seatbelts (p. 627)
- Cleaning floor mats and inlay mats (p. 627)
- Cleaning leather upholstery (p. 628)
- Cleaning interior plastic, metal and wood parts (p. 629)

## Cleaning interior plastic, metal and wood parts

Only use cleaning agents and car care products recommended by Volvo. Clean regularly, and treat stains straight away for best results.

### Interior plastic, metal and wood parts

A fibrillated fibre or microfibre cloth, lightly moistened with water, available from Volvo dealers, is recommended for cleaning interior parts and surfaces.

Do not scrape or rub stains. Never use strong stain removers, either.

#### IMPORTANT

Do not use solvent that contains alcohol when cleaning the glass for the driver display.

#### IMPORTANT

Keep in mind that high gloss surfaces are easily scratched. Clean these surfaces with a clean, dry microfibre cloth using small, circular motions. If needed, dampen the microfibre cloth with a little clean water.

### Related information

- Cleaning the interior (p. 625)
- Cleaning the centre display (p. 625)

- Cleaning fabric upholstery and headlining (p. 627)
- Cleaning the seatbelts (p. 627)
- Cleaning floor mats and inlay mats (p. 627)
- Cleaning leather upholstery (p. 628)
- Cleaning the leather steering wheel (p. 629)

## Cleaning the exterior

The car should be washed as soon as it becomes dirty. This means that the car is easier to clean since the dirt does not attach as firmly. It also reduces the risk of scratches and keeps the car fresh. Carry out cleaning in a cleaning area with an oil separator, and use car shampoo.

### Related information

- Cleaning the exterior (p. 630)
- Polishing and waxing (p. 630)
- Handwashing (p. 631)
- Automatic car wash (p. 632)
- High-pressure washing (p. 633)
- Cleaning the wiper blades (p. 633)
- Cleaning exterior plastic, rubber and trim components (p. 634)
- Cleaning wheel rims (p. 635)
- Rustproofing (p. 635)

## Polishing and waxing

Polish and wax the car if the paintwork is dull or to give the paintwork extra protection. The car does not need to be polished until it is at least one year old. However, the car can be waxed during this time. Do not polish or wax the car in direct sunlight, the surface being polished should be a maximum of 45 °C (113 °F).

- Wash and dry the car thoroughly before you begin polishing or waxing. Clean off asphalt and tar stains using tar remover or white spirit. More stubborn stains can be removed using fine rubbing paste designed for car paintwork.
- Polish first with a polish and then wax with liquid or solid wax. Follow the instructions on the packaging carefully. Many preparations contain both polish and wax.

### ! IMPORTANT

Avoid waxing and polishing on plastic and rubber.

When using degreasant on plastic and rubber, only rub with light pressure if it is necessary. Use a soft washing sponge.

Polishing glossy trim mouldings could wear away or damage the glossy surface layer.

Polishing agent that contains abrasive must not be used.

### ! IMPORTANT

Only paint treatment recommended by Volvo should be used. Other treatment such as preserving, sealing, protection, lustre sealing or similar could damage the paintwork. Paintwork damage caused by such treatments is not covered by Volvo warranty.

### Related information

- Cleaning the exterior (p. 630)
- Handwashing (p. 631)
- Automatic car wash (p. 632)
- High-pressure washing (p. 633)
- Cleaning the wiper blades (p. 633)
- Cleaning exterior plastic, rubber and trim components (p. 634)
- Cleaning wheel rims (p. 635)
- Rustproofing (p. 635)



## Handwashing

The car should be washed as soon as it becomes dirty. This means that the car is easier to clean since the dirt does not attach as firmly. It also reduces the risk of scratches and keeps the car fresh. Carry out cleaning in a cleaning area with an oil separator, and use car shampoo.

## Handwashing

The following steps are good to remember when washing the car:

- Avoid washing the car in direct sunlight. This can cause the detergent or wax to dry and have an abrasive effect.
- Remove bird droppings from the paintwork as soon as possible. They contain substances that damage and discolour paintwork very quickly. For example, use soft paper or sponge soaked in plenty of water. An authorised Volvo workshop is recommended for the removal of any discolouration.
- Wash the underbody, including wheel housings and bumpers.
- Rinse the entire car until the dissolved dirt has been removed so as to reduce the risk of scratches from washing. Do not spray directly onto the locks.
- If necessary, use cold degreasing agent on very dirty surfaces. Note that in this case, the surfaces must not be hot from the sun.

- Wash using a sponge, car shampoo and plenty of lukewarm water.
- Clean the wiper blades with a lukewarm soap solution or car shampoo.
- Dry the car using a clean, soft chamois or a water scraper. If you avoid allowing drops of water to dry in strong sunlight, you reduce the risk of water drying stains which may need to be polished out.
- After the car has been washed, tar from asphalt may remain. Use tar remover to get rid of the last spots after the car has been washed.

### WARNING

Always have the engine cleaned by a workshop. There is a risk of fire if the engine is hot.

### IMPORTANT

Dirty headlamps have impaired functionality. Clean them regularly, e.g. when refuelling.

Do not use any corrosive cleaning agents but use water and a non-scratching sponge instead.

### NOTE

Outside lighting such as headlamps and rear lamps may temporarily have condensation on the inside of the lens. This is normal, all exterior lighting is designed to withstand this. Condensation is normally vented out of the lamp housing when the lamp has been switched on for a time.

### IMPORTANT

- Make sure that the panoramic roof\* and sun visor are closed before washing the car.
- Never use polishing agent with abrasive properties on the panoramic roof.
- Never use wax on the rubber mouldings around the panoramic roof.

### IMPORTANT

Remember to remove dirt from the drain holes in the doors and in the sills after washing the car.

## Related information

- Cleaning the exterior (p. 630)
- Polishing and waxing (p. 630)
- Automatic car wash (p. 632)
- High-pressure washing (p. 633)



- Cleaning the wiper blades (p. 633)
- Cleaning exterior plastic, rubber and trim components (p. 634)
- Cleaning wheel rims (p. 635)
- Rustproofing (p. 635)
- Automatic parking brake activation setting (p. 436)

### Automatic car wash

The car should be washed as soon as it becomes dirty. This means that the car is easier to clean since the dirt does not attach as firmly. It also reduces the risk of scratches and keeps the car fresh.

An automatic car wash is a simple and quick way of washing the car, but it cannot reach everywhere. Washing the car by hand is recommended to achieve a good result, or to supplement automatic car washes with washing by hand.

#### NOTE

Volvo recommends that the car is not washed in an automatic car wash during the first few months (this is because the paintwork has not fully hardened).

#### IMPORTANT

Before driving the car into an automatic car wash, deactivate the functions for automatic braking when stationary and automatic parking brake application. If these functions are not deactivated, the brake system will jam when the car is stationary and the car will not be able to move.

#### IMPORTANT

For car washes where the car is pulled forward with rolling wheels, the following applies:

1. Before washing the car, make sure that the automatic rain sensor is deactivated, otherwise there is the risk of it starting and damaging the wiper arms.
2. Make sure that the door mirrors are retracted, any auxiliary lamps secured, antennas retracted or removed, otherwise they risk being damaged by the automatic car wash.
3. Drive into the car wash.
4. Switch off the "Automatic braking at standstill" function using the button  on the tunnel console.
5. Switch off the "Automatic parking brake application" function via the top view of the centre display.
6. Switch off the engine by turning the start knob in the tunnel console clockwise. Hold the knob in place for at least 2 seconds.

The car is ready for the car wash.

**! IMPORTANT**

The system will automatically switch to **P** mode unless the above step is followed. The wheels are locked in **P** mode, which they should not be when putting the car through an automatic car wash.

**Related information**

- Cleaning the exterior (p. 630)
- Polishing and waxing (p. 630)
- Handwashing (p. 631)
- High-pressure washing (p. 633)
- Cleaning the wiper blades (p. 633)
- Cleaning exterior plastic, rubber and trim components (p. 634)
- Cleaning wheel rims (p. 635)
- Rustproofing (p. 635)

**High-pressure washing**

The car should be washed as soon as it becomes dirty. This means that the car is easier to clean since the dirt does not attach as firmly. It also reduces the risk of scratches and keeps the car fresh. Wash the car in a car wash with oil separator. Use car shampoo.

**High-pressure washing**

When using high-pressure washing, use sweeping movements and make sure that the nozzle does not come closer than 30 cm (13 in.) to the surface of the car. Do not spray directly onto the locks.

**Related information**

- Cleaning the exterior (p. 630)
- Polishing and waxing (p. 630)
- Handwashing (p. 631)
- Automatic car wash (p. 632)
- Cleaning the wiper blades (p. 633)
- Cleaning exterior plastic, rubber and trim components (p. 634)
- Cleaning wheel rims (p. 635)
- Rustproofing (p. 635)

**Cleaning the wiper blades**

The car should be washed as soon as it becomes dirty. This means that the car is easier to clean since the dirt does not attach as firmly. It also reduces the risk of scratches and keeps the car fresh. Wash the car in a car wash with oil separator. Use car shampoo.

**Wiper blades**

Asphalt, dust and salt residue on wiper blades, as well as insects, ice etc. on the windscreen, impair the service life of wiper blades.

When cleaning, set the wiper blades in service position.

**i NOTE**

Wash the wiper blades and windscreen regularly with a lukewarm soap solution or car shampoo. Do not use any strong solvents.

**Related information**

- Cleaning the exterior (p. 630)
- Polishing and waxing (p. 630)
- Handwashing (p. 631)
- Automatic car wash (p. 632)
- High-pressure washing (p. 633)
- Cleaning exterior plastic, rubber and trim components (p. 634)



- Cleaning wheel rims (p. 635)
- Rustproofing (p. 635)

### **Cleaning exterior plastic, rubber and trim components**

The car should be washed as soon as it becomes dirty. This means that the car is easier to clean since the dirt does not attach as firmly. It also reduces the risk of scratches and keeps the car fresh. Carry out cleaning in a cleaning area with an oil separator, and use car shampoo.

### **Exterior plastic, rubber and trim components**

A special cleaning agent available from Volvo dealers is recommended for the cleaning and care of coloured plastic parts, rubber and trim components, e.g. glossy trim mouldings. When using such a cleaning agent the instructions must be followed carefully.

Avoid washing the car with detergent with a pH value below 3.5 or above 11.5. This can cause discolouration of anodised aluminium components\*, as illustrated. We advise against use of abrasive polishing agents, as illustrated.

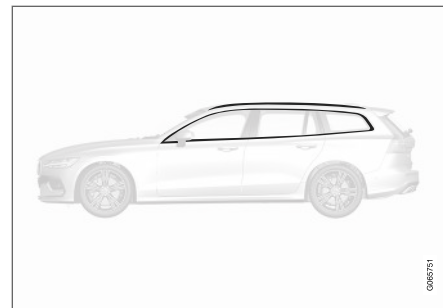

Parts that should be washed using a cleaning agent with a pH value between 3.5 and 11.5.

#### **! IMPORTANT**

Avoid waxing and polishing on plastic and rubber.

When using degreasant on plastic and rubber, only rub with light pressure if it is necessary. Use a soft washing sponge.

Polishing glossy trim mouldings could wear away or damage the glossy surface layer.

Polishing agent that contains abrasive must not be used.

**! IMPORTANT**

Avoid washing the car with cleaning agent with a pH value lower than 3.5 or higher than 11.5. This may result in discolouration of anodised aluminium parts such as roof rack and around the side windows.

Never use metal polishing agent on anodised aluminium parts, this can result in discolouration and destroy the surface treatment.

**Related information**

- Cleaning the exterior (p. 630)
- Polishing and waxing (p. 630)
- Handwashing (p. 631)
- Automatic car wash (p. 632)
- High-pressure washing (p. 633)
- Cleaning the wiper blades (p. 633)
- Cleaning wheel rims (p. 635)
- Rustproofing (p. 635)

**Cleaning wheel rims**

The car should be washed as soon as it becomes dirty. This means that the car is easier to clean since the dirt does not attach as firmly. It also reduces the risk of scratches and keeps the car fresh. Carry out cleaning in a cleaning area with an oil separator, and use car shampoo.

**Rims**

Only use rim cleaning agent recommended by Volvo.

Strong rim cleaning agents can damage the surface and cause stains on chrome-plated aluminium rims.

**Related information**

- Cleaning the exterior (p. 630)
- Polishing and waxing (p. 630)
- Handwashing (p. 631)
- Automatic car wash (p. 632)
- High-pressure washing (p. 633)
- Cleaning exterior plastic, rubber and trim components (p. 634)
- Cleaning wheel rims (p. 635)
- Rustproofing (p. 635)

**Rustproofing**

The car has effective protection against corrosion.

Anti-corrosion protection for the body consists of metallic protective coatings on the sheet metal, a high-quality painting process, corrosion-protected and minimised metal overlap, and shielding plastic components, abrasion protection and supplemental rust inhibitor on exposed areas. In the chassis, exposed components of the wheel suspension are made of corrosion-resistant cast aluminium.

**Inspection and maintenance**

The car's anti-corrosion protection normally requires no maintenance but a good way to further reduce the risk of corrosion is to keep the car clean. Strong alkaline or acidic cleaning solutions must always be avoided on glossy trim components. Any stone chips should be rectified as soon as they are discovered.

**Related information**

- Cleaning the exterior (p. 630)
- Polishing and waxing (p. 630)
- Handwashing (p. 631)
- Automatic car wash (p. 632)
- High-pressure washing (p. 633)
- Cleaning the wiper blades (p. 633)

- Cleaning exterior plastic, rubber and trim components (p. 634)
- Cleaning wheel rims (p. 635)

### Car paintwork

The paintwork consists of several layers and is an important part of the car's rustproofing, and should therefore be checked regularly.

The most common types of paintwork damage are stone chips, scratches, and marks on the edges of wings, doors and bumpers. To avoid the onset of rust, damaged paintwork should be rectified immediately.

### Related information

- Touching up minor paintwork damage (p. 636)
- Colour codes (p. 637)

### Touching up minor paintwork damage

Paint is an important part of the car's rustproofing and should therefore be checked regularly. The most common types of paintwork damage are stone chips, scratches, and marks on e.g. the edges of wings, doors and bumpers.

### Repair paint damage

To avoid the onset of rust, damaged paintwork should be rectified immediately.

#### **i** NOTE

When paint is repaired the surface must be clean and dry. The temperature of the surface should be at least 15 °C (59 °F).

### Materials that may be needed

- Primer<sup>21</sup> – a special adhesive primer in a spray can is available for e.g. plastic-coated bumpers.
- Basecoat and clearcoat - available in spray cans or as touch-up pens/sticks<sup>22</sup>.
- Masking tape.
- Fine sand paper<sup>21</sup>.

If the damage has not reached down to the metal, the touch-up paint can be applied directly after the surface has been cleaned.

<sup>21</sup> If required.

<sup>22</sup> Follow the instructions that are included with the package for the touch-up pen/stick.

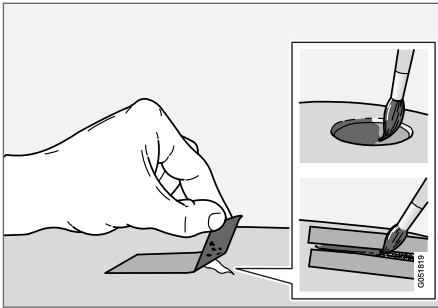

1. Apply a piece of masking tape over the damaged surface. Then remove the tape to remove any loose paint.

If the damage is down to the metal, use of a primer is appropriate. In the event of damage to a plastic surface, an adhesive primer should be used to give better results - spray into the lid of the spray can and brush on thinly.

2. Before painting, gentle polishing using a very fine polishing agent may be carried out locally if required (e.g. if there are any uneven edges). The surface is cleaned thoroughly and left to dry.
3. Stir the primer well and apply using a fine brush, a matchstick or similar. Finish off with a basecoat and clearcoat once the primer has dried.

For scratches, implement the same procedure but mask around the damaged area to protect the undamaged paintwork.

Touch-up pens and spray paints for touching up paintwork are available from Volvo dealers.

**i NOTE**

If the stone chip has not penetrated down to the metal and an undamaged layer of paint remains in place, fill in with base coat and clear coat as soon as the surface has been cleaned.

**Related information**

- Car paintwork (p. 636)
- Colour codes (p. 637)

**Colour codes**

**Colour code**

The colour code label is located on the car's right-hand rear door pillar and becomes visible when the right-hand rear door is opened.

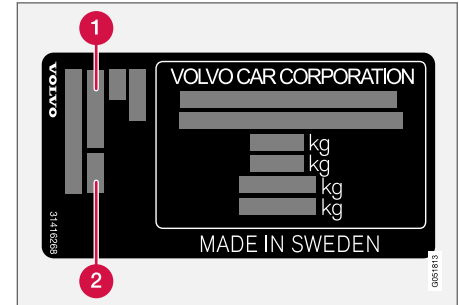

- 1 Exterior colour code
- 2 Any secondary exterior colour code

It is important that the correct colour is used.

**Related information**

- Car paintwork (p. 636)
- Touching up minor paintwork damage (p. 636)

## Replacing the wiper blade, rear window

The wiper blades sweep water away from the windscreen and rear window. Together with the washer fluid they clean the windows and ensure visibility for driving. Windscreen and rear window wiper blades can be replaced.

### Replacing the wiper blade, rear window

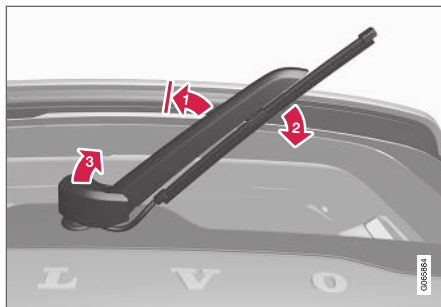

Lift the wiper arm from the windscreen and pull the upper section of the blade diagonally down to the right.

- 1 Grip the centre of the wiper arm and lift it from the windscreen to lock position.

#### **i** NOTE

There is a lock position at half extension angle that may feel like resistance, this lock prevents the arm from falling back against the windscreen. The wiper arm must be pulled past the lock for wiper blade replacement.

- 2 Grip just above the blade's centre bracket and pull diagonally down to the right until the blade loosens from the arm.

- 3 Lift the cover for the wiper arm's bracket. Be careful that the wiper arm does not mistakenly fall down to the windscreen again.

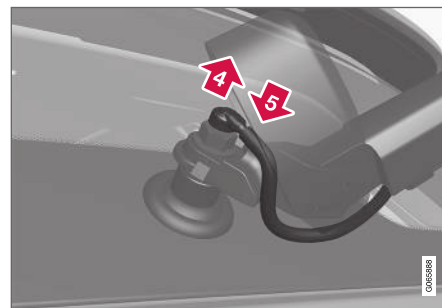

- 4 Loosen the washer hose from the bracket.
- 5 Attach the new washer hose with associated wiper blade into the bracket. Fold down the cover for the wiper arm's bracket.

#### **i** NOTE

Make sure that the hose is routed in the same way as in the illustration. Otherwise it risks being pinched by the casing when it is lowered again.

- 6 Press the new wiper blade into place. You should hear a click. Check that it is firmly installed.



7. Lower the wiper arm.

**! IMPORTANT**

Check the blades regularly. Neglected maintenance shortens the service life of the wiper blades.

**Related information**

- Using the rain sensor (p. 171)
- Using windscreen and headlamp washers (p. 173)
- Using automatic rear windscreen wiping when reversing (p. 175)
- Using the rain sensor's memory function (p. 172)
- Using the rear window wiper and washer (p. 174)
- Filling washer fluid (p. 641)
- Wiper blades in service position (p. 640)
- Replacing windscreen wiper blades (p. 639)
- Using windscreen wipers (p. 170)
- Wiper blades and washer fluid (p. 170)

**Replacing windscreen wiper blades**

The wiper blades sweep water away from the windscreen and rear window. Together with the washer fluid they clean the windows and ensure visibility for driving. Windscreen and rear window wiper blades can be replaced.

**Replacing a windscreen wiper blade**

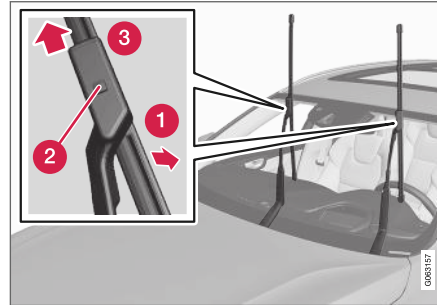

1. Fold up the wiper arm when it is in service position. Service position is activated/deactivated via the function view in the centre display when the car is stationary and the windscreen wipers are not on.
2. **1** Set the wiper blade in removal position by angling it out from the arm until a click sound can be heard.

3. **2** Press and hold the lock button located on the wiper blade mounting and at the same time pull the blade straight out **3** parallel with the wiper arm.
4. Slide in the new wiper blade until the lock button engages.
5. Angle the blade in towards the arm until a click sound is heard. The blade is then no longer in the removal position and can be moved again.
6. Check that the wiper blade is firmly installed.
7. Fold the wiper arm back towards the windscreen.

**The wiper blades are different lengths**

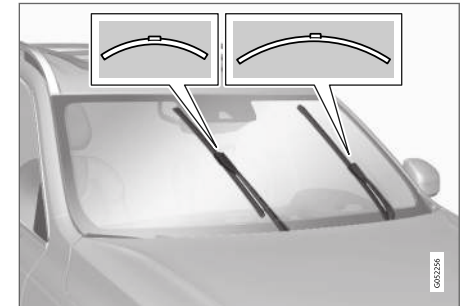



**NOTE**

When replacing the wiper blades, note that they have different lengths. The blade on the driver's side is longer than on the passenger side.

**Related information**

- Using the rain sensor (p. 171)
- Using windscreen and headlamp washers (p. 173)
- Using automatic rear windscreen wiping when reversing (p. 175)
- Using the rain sensor's memory function (p. 172)
- Using the rear window wiper and washer (p. 174)
- Filling washer fluid (p. 641)
- Wiper blades in service position (p. 640)
- Replacing the wiper blade, rear window (p. 638)
- Using windscreen wipers (p. 170)
- Wiper blades and washer fluid (p. 170)

**Wiper blades in service position**

In some situations, the windscreen's wiper blades must be set in service position (vertical position), e.g. when they shall be replaced.



Wiper blades in service position.

In order to change, clean or lift the wiper blades (e.g. for scraping off ice from the windscreen) they must be in service position.

**IMPORTANT**

Before placing the wiper blades in the service position, make sure that they are not frozen down.

**Activating/deactivating service mode**

Service mode can be activated/deactivated when the car is stationary and the windscreen wipers

are not on. Service mode is activated/deactivated via the function view in the centre display:



Press the **Wiper Service Position** button. The light indicator in the button illuminates when service mode is activated. When activated, the wipers move to the service position. To deactivate the service mode,

press **Wiper Service Position** again. The light indicator in the button extinguishes when service mode is deactivated.

The wiper blades also exit the service position if:

- Windscreen wiping is activated.
- Windscreen washing is activated.
- The rain sensor is activated.
- The car is driven away.

**IMPORTANT**

If the wiper arms in service position have been folded up from the windscreen, they must be folded back down onto the windscreen before the activation of wiping, washing or the rain sensor, as well as before driving. This is to avoid scraping the paint on the bonnet.

### Related information

- Using the rain sensor (p. 171)
- Using windscreen and headlamp washers (p. 173)
- Using automatic rear windscreen wiping when reversing (p. 175)
- Using the rain sensor's memory function (p. 172)
- Using the rear window wiper and washer (p. 174)
- Filling washer fluid (p. 641)
- Replacing windscreen wiper blades (p. 639)
- Replacing the wiper blade, rear window (p. 638)
- Using windscreen wipers (p. 170)
- Wiper blades and washer fluid (p. 170)

### Filling washer fluid

Washer fluid is used for cleaning the headlamps as well as the windscreen and rear window. Washer fluid with antifreeze must be used when the temperature is under the freezing point.

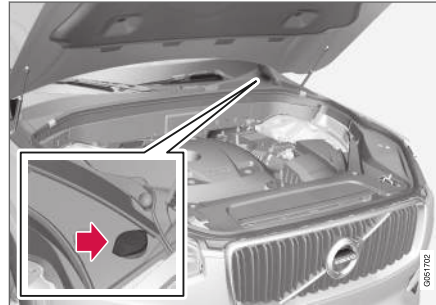

Washer fluid is filled into the reservoir with the blue cap. The reservoir is used for windscreen washer, rear window washer and headlamp washers\*

#### **i** NOTE

When approx. 1 litre (1 qt) of washer fluid remains in the reservoir, the message **Washer fluid Level low, refill** is shown in the driver display, together with the  symbol.

**Prescribed grade:** Washer fluid recommended by Volvo – with frost protection during cold weather and for temperatures below freezing point.

#### **!** IMPORTANT

Use Volvo genuine washer fluid or equivalent with a recommended pH of between 6 and 8, in working dilution (e.g. 1:1 with neutral water).

#### **!** IMPORTANT

Use washer fluid with antifreeze when the temperature is below freezing to avoid the fluid freezing inside the pump, reservoir and hoses.

#### Volume:

- Cars **with** headlamp washing: 5.5 litres (5.8 qts).
- Cars **without** headlamp washing: 3.5 litres (3.7 qts).

#### Related information

- Using the rain sensor (p. 171)
- Using windscreen and headlamp washers (p. 173)
- Using automatic rear windscreen wiping when reversing (p. 175)



## MAINTENANCE AND SERVICE

- ◀◀ ● Using the rain sensor's memory function (p. 172)
- Using the rear window wiper and washer (p. 174)
- Wiper blades in service position (p. 640)
- Replacing windscreen wiper blades (p. 639)
- Replacing the wiper blade, rear window (p. 638)
- Using windscreen wipers (p. 170)
- Wiper blades and washer fluid (p. 170)

SPECIFICATIONS

## Type designations

The decals in the car contain information such as chassis number, type designation, colour code, etc.

### Label location

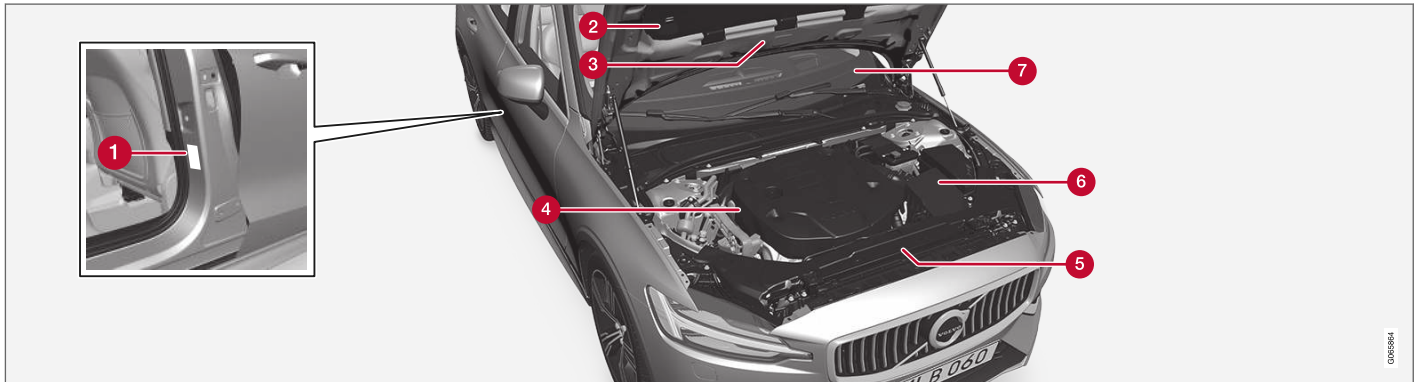

The illustration is schematic - details may vary depending on market and model.

Knowing the car's type designation, vehicle identification and engine numbers can facilitate all contact with an authorised Volvo dealer regarding the car and when ordering spare parts and accessories.

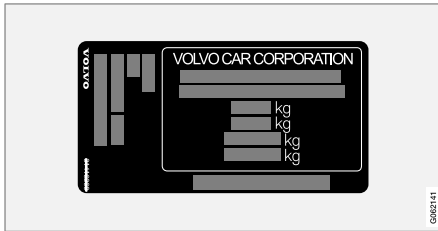

1 Decal for type designation, vehicle identification number, permissible maximum weights and code designation for exterior colour and type approval number. The decal is positioned on the door pillar, and will be visible when the right-hand rear door is opened.



2 Decal A/C system for cars with refrigerant R1234yf.

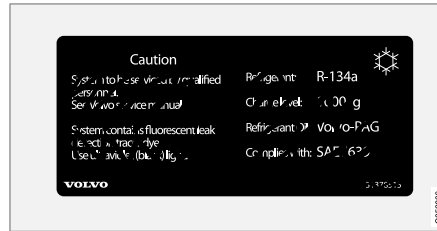

3 Decal A/C system for cars with refrigerant R134a.

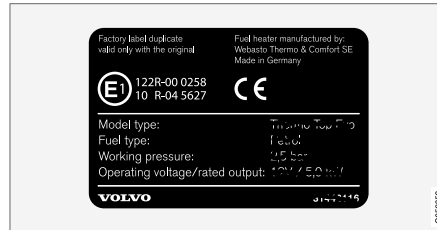

4 Label for parking heater.

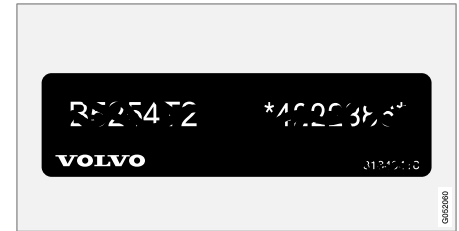

5 Decal for engine code and the engine's serial number.

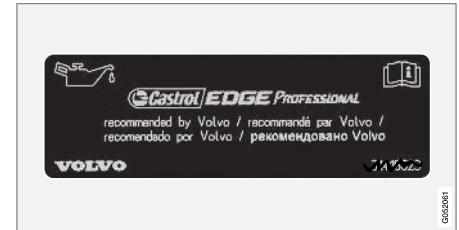

6 Label for engine oil.

## SPECIFICATIONS

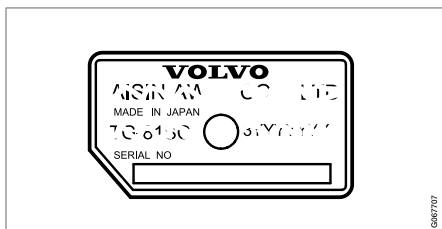

- 6 Decal for gearbox type designation and serial number.

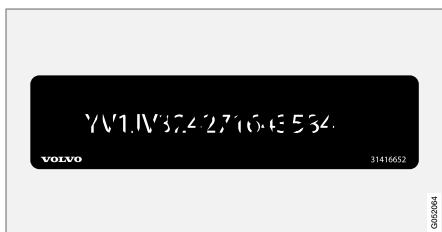

- 7 Decal for the car's identification number - VIN (Vehicle Identification Number).

Further information on the car is presented in the registration document.



### NOTE

It is not intended that the decals illustrated in the owner's manual should be exact replicas of those in the car. They are included to show their approximate appearance and locations in the car. The information that applies to your particular car can be found on the decal on the car.

### Related information

- Air conditioning — specifications (p. 656)



## Dimensions

Measurement of car length, height, etc. can be read in the table.

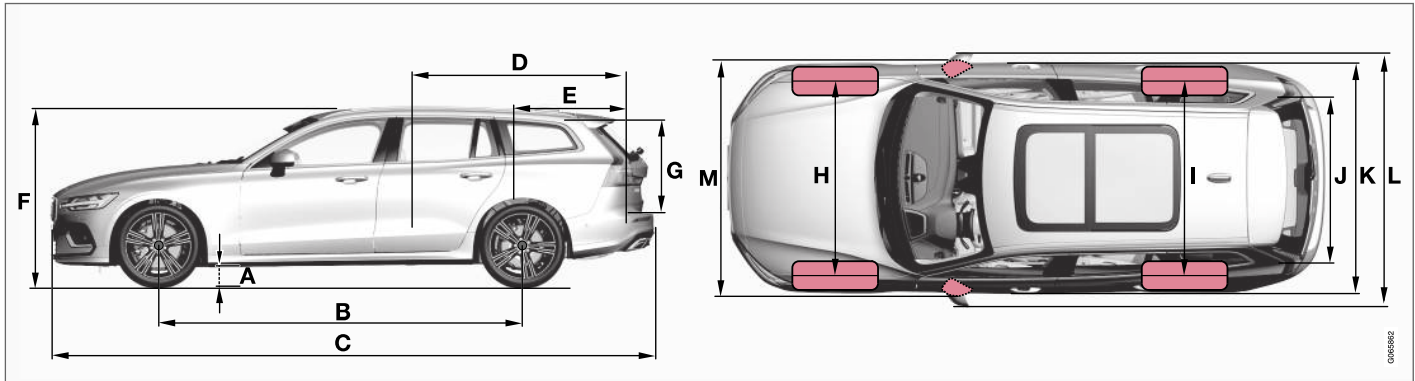

	Dimensions	mm	inches
A	Ground clearance <sup>A</sup>	128	5.0
B	Wheelbase	2872	113.1
C	Length	4761	187.4
D	Load length, floor, folded seat	1821	71.7
E	Load length, floor	1033	40.7
F	Height <sup>B</sup>	1433	56.4

	Dimensions	mm	inches
G	Load height	644	25.4
H	Front track	1610 <sup>C</sup>	63.4 <sup>C</sup>
		1603 <sup>D</sup>	63.1 <sup>D</sup>
		1600 <sup>E</sup>	63.0 <sup>E</sup>
		1593 <sup>F</sup>	62.7 <sup>F</sup>

	Dimensions	mm	inches
I	Rear track	1610 <sup>C</sup>	63.4 <sup>C</sup>
		1603 <sup>D</sup>	63.1 <sup>D</sup>
		1600 <sup>E</sup>	63.0 <sup>E</sup>
		1593 <sup>F</sup>	62.7 <sup>F</sup>
J	Load width, floor	1064	41.9
K	Width	1850	72.8



## SPECIFICATIONS



	<b>Dimensions</b>	<b>mm</b>	<b>inches</b>
L	Width including door mirrors	2040	80.3
M	Width including folded-in door mirrors	1916	75.4

A At kerb weight + 2 people. (Varies slightly depending on tyre dimension, chassis option, etc.)

B Including roof antenna, for kerb weight.

C Applies to cars with 16 inch wheels.

D Applies to cars with 17 inch wheels.

E Applies to cars with 18/19 inch wheels.

F Applies to cars with 20 inch wheels.

### **Related information**

- Weights (p. 649)

## Weights

Max. gross vehicle weight, etc. can be read on a label in the car.

Kerb weight includes the driver, the fuel tank 90% full, plus and all oils and fluids.

The weight of passengers and accessories, and towball load (when a trailer is hitched) influence the load capacity and are not included in the kerb weight.

Permitted max. load = Gross vehicle weight - Kerb weight.

### **i** NOTE

The documented kerb weight applies to cars in the standard version - i.e. a car without extra equipment or accessories. This means that for every accessory added the loading capacity of the car is reduced correspondingly by the weight of the accessory.

Examples of accessories that reduce load capacity are the different equipment levels (e.g. Kinetic, Momentum, Summum), as well as other accessories such as towbar, load carrier, space box, audio system, auxiliary lamps, GPS, fuel-driven heater, safety grille, carpets, cargo cover, power seats, etc.

Weighing the car is a certain way of ascertaining the kerb weight of your own particular car.

### **!** WARNING

The car's driving characteristics change depending on how heavily it is loaded and how the load is distributed.

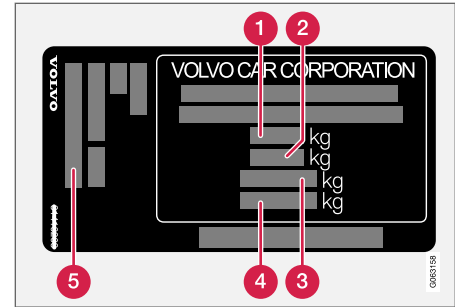

The decal is positioned on the door pillar, and will be visible when the right-hand rear door is opened.

- 1** Max. gross vehicle weight
- 2** Max. train weight (car+trailer)
- 3** Max. front axle load
- 4** Max. rear axle load
- 5** Equipment level

Max. load: See registration document.

Max. roof load: 75 kg.

### Related information

- Type designations (p. 644)
- Towing capacity and towball load (p. 650)

### Towing capacity and towball load

Towing capacity and towball load for driving with a trailer can be read in the tables.

### Max. weight braked trailer

**NOTE**  
 Use of vibration dampers on the towbar is recommended for trailers heavier than 1800 kg.

Engine	Engine code <sup>A</sup>	Gearbox	Max. weight braked trailer (kg)	Max. towball load (kg)
T6 Twin Engine	B4204T46	Automatic	2000	100
T6 Twin Engine	B4204T45	Automatic	2000	100
T8 Twin Engine	B4204T34	Automatic	2000	100
T8 Twin Engine	B4204T28	Automatic	2000	100

<sup>A</sup> The engine code, component number and serial number can be found on the engine.

**IMPORTANT**  
 When driving with a trailer, it is permitted to exceed the vehicle's gross vehicle weight (including towball load) by a maximum of 100 kg (220 lbs), provided that speed is limited to 100 km/h (62 mph). National legal requirements for the vehicle combination, such as speed, etc. must be observed.

**Max. weight unbraked trailer**

Max. weight unbraked trailer (kg)	Max. towball load (kg)
750	50

**Related information**

- Type designations (p. 644)
- Weights (p. 649)
- Driving with a trailer (p. 472)
- Trailer stability assist\* (p. 474)

## SPECIFICATIONS

### Engine specifications

Engine specifications (power, etc.) for each respective engine alternative can be found in the table below.

The Twin Engine variant is driven both by a petrol engine and an electric drive motor (ERAD – Electric Rear Axle Drive).

<b> NOTE</b>
Not all engines are available in all markets.

Engine	Engine code <sup>A</sup>	Output (kW/rpm)	Output (hp/rpm)	Torque (Nm/rpm)	No. of cylinders
T6 Twin Engine	B4204T46	186/5500	253/5500	350/1700–5000	4
T6 Twin Engine	B4204T45	186/5500	253/5500	350/1700–5000	4
T8 Twin Engine	B4204T28	233/6000	318/6000	400/2200–5400	4
T8 Twin Engine	B4204T34	223/6000	303/6000	400/2200–4800	4

<sup>A</sup> The engine code, component number and serial number can be found on the engine.

### Electric drive motor

**Max. power output:** 65 kW (87 hp).

**Torque:** 240 Nm.

### Related information

- Type designations (p. 644)
- Engine oil — specifications (p. 653)
- Coolant — specifications (p. 655)

## Engine oil — specifications

Engine oil grade and volume for each respective engine alternative can be read in the table.

Volvo recommends:



Engine	Engine code <sup>A</sup>	Oil grade	Volume, incl. oil filter (litres, approx.)
T6 Twin Engine	B4204T46	Castrol Edge Professional V 0W-20 or VCC RBS0-2AE 0W-20	5,6
T6 Twin Engine	B4204T45		5,6
T8 Twin Engine	B4204T34		5,6
T8 Twin Engine	B4204T28		5,6

<sup>A</sup> The engine code, component number and serial number can be found on the engine.

## Related information

- Type designations (p. 644)
- Adverse driving conditions for engine oil (p. 654)
- Checking and filling with engine oil (p. 602)
- Engine oil (p. 601)

## Adverse driving conditions for engine oil

Adverse driving conditions can lead to abnormally high oil temperature or oil consumption. Below are some examples of adverse driving conditions.

Check the oil level more frequently for long journeys:

- towing a caravan or trailer
- in mountainous regions
- at high speeds
- in temperatures colder than  $-30\text{ }^{\circ}\text{C}$  ( $-22\text{ }^{\circ}\text{F}$ ) or hotter than  $+40\text{ }^{\circ}\text{C}$  ( $+104\text{ }^{\circ}\text{F}$ ).

The above also apply to shorter driving distances at low temperatures.

Choose a fully synthetic engine oil for adverse driving conditions. It provides extra protection for the engine.

Volvo recommends:



**! IMPORTANT**

In order to fulfil the requirements for the engine's service intervals all engines are filled with a specially adapted synthetic engine oil at the factory. The choice of oil has been made very carefully with regard to service life, starting characteristics, fuel consumption and environmental impact.

An approved engine oil must be used in order that the recommended service intervals can be applied. Only use a prescribed grade of oil for both filling and oil change, otherwise there is a risk of the service life, starting characteristics, fuel consumption and environmental impact of the car being affected.

If engine oil of the prescribed grade and viscosity is not used, engine related components may become damaged. Volvo Car Corporation disclaims any liability for any such damage.

Volvo recommends that oil changes are carried out at an authorised Volvo workshop.

### Related information

- Engine oil — specifications (p. 653)
- Engine oil (p. 601)



## Coolant — specifications

**Prescribed grade:** Ready-mixed coolant approved by Volvo. If concentrated coolant is used, mix with 50% water (of approved water quality, not salt water, etc.). Consult a Volvo dealer if unsure.

Only coolant approved by Volvo should be used in order to prevent impairment of the cooling system, engine problems, etc.

### WARNING

Swallowing coolant is hazardous, it may cause damage to organs (kidneys). The product contains ethylene glycol, inhibitor, emetic, water, etc.

### Related information

- Topping up coolant (p. 603)

## Transmission fluid — specifications

Under normal driving conditions, the transmission fluid does not need to be changed during the service life of the gearbox. However, it may be necessary in adverse driving conditions.

### Automatic gearbox

<b>Prescribed transmission fluid:</b>	AW1
---------------------------------------	-----

### Related information

- Type designations (p. 644)

## Brake fluid — specifications

The medium in a hydraulic brake system is called brake fluid, and it is used to transfer pressure from e.g. a brake pedal via a master brake cylinder to one or more slave cylinders, which in turn act on a mechanical brake.

**Prescribed grade:** Volvo Original or equivalent fluid compliant with a combination of Dot 4, 5.1 and ISO 4925 class 6.

### NOTE

It is recommended that brake fluid is changed or filled by an authorised Volvo workshop.

### Related information

- Engine compartment overview (p. 600)

## SPECIFICATIONS

### Fuel tank - volume

The fuel tank's filling capacity can be read in the table below.

	All models
Litres (approx)	60
US gallons (approx)	15.9

### Related information

- Filling fuel (p. 462)

### Air conditioning — specifications

The car's climate control system uses a freon-free refrigerant either R1234yf or R134a depending on the market. Information about which refrigerant the car's climate control system uses is printed on a decal located on the inside of the bonnet.

Prescribed grades and volumes of fluids and lubricants in the air conditioning system can be read in the tables below.

### A/C decal



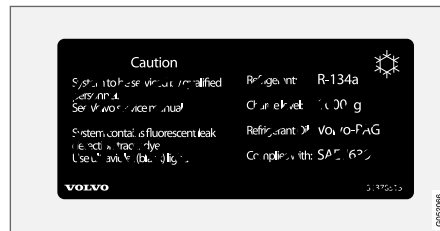

#### Decal for R134a

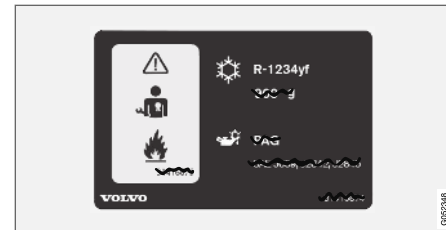

#### Decal for R1234yf



**Symbol explanation R1234yf**

Symbol	Meaning
	Caution
	Mobile air conditioning system (MAC)
	Lubricant type
	A trained and certified technician is required in order to service the mobile air conditioning system (MAC)
	Flammable refrigerants

**Refrigerant**

**Cars with R134a refrigerant**

Weight	Prescribed grade
725 g (1.60 lbs)	R134a

**⚠ WARNING**

The air conditioning system contains pressurised refrigerant R134a. This system must only be serviced and repaired by an authorised workshop.

**Cars with R1234yf refrigerant**

Weight	Prescribed grade
675 g	R1234yf

**⚠ WARNING**

The air conditioning system contains pressurised refrigerant R1234yf. In accordance with SAE J2845 (Technician Training for Safe Service and Containment of Refrigerants Used in Mobile A/C System), service and repair of the refrigerant system must only be performed by trained and certified technicians in order to ensure the safety of the system.

**Compressor oil**

Volume	Prescribed grade
100 ml (3.38 fl. oz.)	PAG SP-A2

**Evaporator**

**⚠ IMPORTANT**

The A/C system's evaporator must never be repaired or replaced with a previously used evaporator. A new evaporator must be certified and labelled in accordance with SAE J2842.



**Related information**



- Servicing the climate control system (p. 598)

### Fuel consumption and CO<sub>2</sub> emissions

The fuel consumption for a vehicle is measured in litres per 100 km and CO<sub>2</sub> emissions are measured in gram CO<sub>2</sub> per km.





#### Explanation





<b>CO<sub>2</sub></b>	gram CO <sub>2</sub> /km
	litres/100 km
	Certified value for the car's potential range ("up to") in km in electric mode. The value should not be interpreted as an expected range, and the range is difficult to achieve during normal driving.

	Mixed driving
	Tyre rating for rolling resistance according to EU directive no. 1222/2009
<b>aut</b>	Automatic gearbox

 <b>NOTE</b>
If there is no consumption and emissions data in the table, this is available in an enclosed supplement.

 <b>NOTE</b>
The capacity of the hybrid battery diminishes with age and use, which may result in increased use of the internal combustion engine and, as a consequence, reduced fuel economy and reduced range during electric operation.

				
		CO <sub>2</sub>		
T6 Twin Engine (B4204T46)	<b>aut</b>	A	-	-
		B	-	-
		C	-	-

					
			CO <sub>2</sub>		Range
T8 Twin Engine (B4204T34)	aut	A	-	-	-A
		B	-	-	-A
		C	-	-	-A

A Drive mode PURE

The values in the above table for fuel consumption, emissions and range in electric mode are based on special EU driving cycles (see below), which apply for cars with kerb weight in basic version and without extra equipment. The car's weight may increase depending on its equipment level. This, along with how heavily the car is loaded, affects fuel consumption and CO<sub>2</sub> emissions and reduces its range in electric mode.

The certified values for the car should not be interpreted as the expected values. The certification values are the comparative values obtained during special "EU driving cycles" (see below).

There are several reasons for fuel consumption that is higher and an electric range that is shorter than the values in the table. Examples of these include:

- If the car is not regularly charged from the mains.
- If the car is equipped with extra equipment that affects its weight.
- Driving style.
- If the customer chooses wheels other than those mounted as standard on the basic version of the model, this could increase rolling resistance.
- High speed causes increased air resistance.
- Fuel quality, road and traffic conditions, weather and the condition of the car.

A combination of the examples above could increase consumption considerably.

There may be huge deviations in fuel consumption if comparing to the EU driving cycles (see below), which are used in the certification of the car and on which consumption figures in the

table are based. For further information, please refer to the referenced regulations.

 <b>NOTE</b>	
Extreme weather conditions, driving with a trailer or driving at high altitudes, in combination with poorer fuel quality than recommended, are factors that considerably increase the car's fuel consumption.	



### ◀◀ **EU driving cycles**

The official fuel consumption figures and range during electric operation are based on two standardised driving cycles in a laboratory environment ("EU driving cycles"), all in accordance with EU Regulation no 692/2008 and 715/2007 (Euro 5 / Euro 6), 2017/1151 and 2017/1153. Since the driving cycles are also used for quality control, there are stringent requirements for test repeatability. Testing is therefore conducted in a controlled manner and only with the car's basic functions (e.g. air conditioning, radio, etc. switched off). The results of the official figures are therefore not naturally representative of what the customer sees in actual use.

The regulations cover the driving cycles "Urban driving" and "Motorway driving":

- **Urban driving** – the measurement starts with a cold start of the engine. The driving is simulated.
- **Motorway driving** – the car is accelerated and braked at speed of 0-120 km/h (0-75 mph). The driving is simulated.

The official value for mixed driving, which is shown in the table, is a combination of the results from the "Urban driving" and "Motorway driving" driving cycles in accordance with legal requirements.

To determine the carbon dioxide emissions (CO<sub>2</sub> emissions) during the two driving cycles, the exhaust gases were collected. These were then

analysed to determine the value for CO<sub>2</sub> emissions.

### **Related information**

- Type designations (p. 644)
- Weights (p. 649)
- Economical driving (p. 455)
- Factors that affect range when running on electricity (p. 456)

## Approved wheel and tyre sizes

In certain countries not all approved sizes are indicated by the registration document or other

documents. The following table shows all approved combinations of wheel rims and tyres.

✓ = Approved

Engine	man/ aut	235/45 R18 7.5x18x45 <sup>A</sup>	235/45 R18 8x18x42	235/40 R19 8x19x42
All engines	aut	✓	✓	✓

A The 7.5x18x45 wheel rim is only permitted in combination with snow chains.

## Related information

- Minimum permitted tyre load index and speed rating for tyres (p. 662)
- Type designations (p. 644)
- Dimension designation for tyre (p. 545)
- Dimension designation for wheel rim (p. 546)
- Snow chains (p. 562)

## Minimum permitted tyre load index and speed rating for tyres

The table below shows the minimum permitted load index (LI) and speed rating (SS).

Engine	man/ aut	Minimum permitted load index (LI) <sup>A</sup>	Minimum permitted speed rating (SS) <sup>B</sup>
All engines	aut	96	W

<sup>A</sup> The tyre's load index must be at least equal to or greater than indicated in the table.

<sup>B</sup> The tyre's speed rating must be at least equal to or greater than indicated in the table.

### Related information

- Approved wheel and tyre sizes (p. 661)
- Approved tyre pressures (p. 663)
- Type designations (p. 644)
- Dimension designation for tyre (p. 545)
- Dimension designation for wheel rim (p. 546)



## Approved tyre pressures

Approved tyre pressures for each engine alternative can be found in the table.

<b>i</b> <b>NOTE</b>
All engines, tyres or combinations of these are not always available in all markets.

Engine	Tyre size	Speed	Load, 1-3 persons		Max. load		ECO pressure <sup>A</sup>
			Front (kPa) <sup>B</sup>	Rear (kPa)	Front (kPa)	Rear (kPa)	Front/rear (kPa)
All engines	235/45 R18	0-160 km/h (0-100 mph)	250	250	250	260	250 / 260
		160+ km/h (100+ mph)	300	260	310	320	-
	235/40 R19	0-160 km/h (0-100 mph)	260	260	270	280	270 / 280
		160+ km/h (100+ mph)	320	320	330	340	-
Temporary Spare Tyre		max 80 km/h (max 50 mph)	420	420	420	420	-

<sup>A</sup> Economical driving.

<sup>B</sup> In certain countries the "bar" unit is used alongside the SI unit "Pascal": 1 bar = 100 kPa.

## Related information

- Type designations (p. 644)
- Checking tyre pressure (p. 548)
- Approved wheel and tyre sizes (p. 661)
- Recommended tyre pressure (p. 549)



# ALPHABETICAL INDEX

## 1, 2, 3 ...

---

4WD 445

## A

---

A/C (Air conditioning) 218

ABS

anti-lock brakes 432

Accessories and extra equipment 37

installation 37

Active bending lights 151

Active main beam 148

Active Park Assist 394

Limitations 399

Symbols and messages 402

Active Yaw Control 279

Adapting driving characteristics 447

Adaptive Cruise Control 298

activate 300

Auto brake 320

change cruise control functionality 303

change of target 317

deactivate 301

fault tracing 303

Limitations 303

managing speed 319

overtaking 321

setting the time interval 318

Symbols and messages 305

WARNING 316

Additional heater (Auxiliary heater) 230

Adjusting headlamp pattern/headlamp

beam 145

Adjusting the steering wheel 193

Aerial

location 261

Airbag 50

Activating/deactivating 53

driver's side 51

passenger side 52, 53

Airbag, see Airbag 50

Air conditioning 218

Air conditioning, fluid

volume and grade 656

Air conditioning system 196, 207

repair 598

Air distribution 201

Air vents 201, 203

change 202

defrosting 213

Recirculation 212

table of options 204

Air quality 198, 200

allergies and asthma 200

passenger compartment filter 201

Air recirculation 212

Alarm 272

deactivation 274

motion and tilt sensors 273

reduced alarm level 275

Alcohol lock 430, 431

Allergy and asthma inducing substances. 200

All Wheel Drive (AWD) 445

Ambience lights

adapt 157

Android Auto 510, 512

Apple CarPlay 506, 507, 509

Approach lighting 154

Apps 488

Assistance at risk of collision 375

activate/deactivate 376

level of assistance 376

Limitations 379

Symbols and messages 380

upon risk of head-on collision 378

upon risk of run-off 377

Audio and media 486

Audio settings 486, 519

phone 520

ALPHABETICAL INDEX

play media	498, 499
Text message	519
Auto climate control	211
Auto hold	438
Automatic brake	438
activate/deactivate	438
after collision	439
Driver support	278
Automatic car wash	632
Automatic car washes	632
Automatic gearbox	441
kickdown	444
oil	655
trailer	472
Automatic locking	265
Automatic relocking	237, 259
Automatic speed limiter	288
activate/deactivate	289
Limitations	291
tolerance	290
Auxiliary heater	230
AWD, All Wheel Drive	445

**B**

Backrest	
front seat, adjusting	178, 179, 182,
183,	184,
185	
rear seat, lowering	188
Bag holder	580
Battery	467, 606
HYBRID	610
jump starting	467
maintenance	606
overload	467
recycling	611
start	606
symbols on the battery	611
Bicycle rack	
towbar mounted	476
BLIS	351
activate/deactivate	352
Limitations	353
Symbols and messages	354
Bluetooth	
connect	503
connect car to Internet	522
phone	512
settings	521
Bonnet, opening	599
Book service and repair	593

Brake assist	
after collision	439
Brake energy	432, 445
Brake fluid	
grade	655
Brake functions	431
Brake mode	441
Brakes	432
Anti-lock braking system, ABS	432
automatic when stationary	438
brake assist system, BAS	433
brake light	153
brake system	431
emergency brake lights	153
maintenance	434
on gritted roads	434
on wet roads	433
Parking brake	434
Brake system	
fluid	655
Bulbs	
change	605
bypass alcohol lock	430

<b>C</b>					
Camera sensor					
see Camera unit	329				
Camera unit	329				
Limitations	330				
maintenance and cleaning	334				
Car care	630, 631, 632, 633, 634, 635				
Leather upholstery	628				
Car functions					
in centre display	115				
Cargo area	578				
electrical socket	573, 575				
lighting	156				
mounting points	581				
protective net	585				
Cargo cover	582				
Cargo grille	584				
carriage net	585				
Car holiday	459				
Car key battery low	240				
Car modem					
connect car to Internet	523				
settings	524				
Car status	592				
Tyre pressure	553				
Car upholstery	625, 627, 628, 629				
Car washing	630, 631, 632, 633, 634, 635				
Catalytic converter					
Recovery	477				
CD player	501				
central locking	262				
Centre display					
change appearance	124				
cleaning	625				
climate control	207				
function view	115				
Keyboard	119				
messages	133, 134				
operation	105, 108, 112, 117				
overview	102				
settings	125, 126				
switch off and change volume	124				
symbols in status bar	117				
views	108				
Change of owner	127				
Change of target					
with adaptive cruise control	317				
with Pilot Assist	317				
Charge					
car function	458				
Charge current	406				
Charging					
finish charging	419				
Hybrid battery	405				
open and close charging flap	410				
start charging	410				
Status	413, 414, 417				
Charging cable	407				
Checking the engine oil level	602				
Child safety	58				
Child safety locks	264				
Child seat	58, 59, 62, 63				
i-Size/ISOFIX mounting points	61				
lower mounting points	60				
overview table	65				
positioning/fitting	62, 63				
table for location	66				
table of i-Size	68				
table of ISOFIX	69				
Upper mounting points	60				
Cigarette lighter	571				
City Safety	335				
brakes for oncoming vehicles	345				
cross traffic	341				
evasive manoeuvre prevented	344				
evasive manoeuvres	343				
Limitations	346				
limitations in the case of cross traffic	342				
limitations in the case of evasive manoeuvres	344				
obstacle detection	339				
set warning distance	338				

## ALPHABETICAL INDEX

subfunctions	336	CO2 emissions	658	Cooling system	
Symbols and messages	349	Collision	42, 45, 50, 57	overheating	466
Cleaning	627, 629	Collision warning		Cornering lights	152
automatic car wash	632	from behind	350	Corner Traction Control	279
car washing	630, 631, 632, 633, 634, 635	Collision warning system		Cover	
centre display	625	cross traffic rear	355	cargo area	582
Fabric upholstery	625, 627, 628	see City Safety	335	Crash, see Collision	42
rims	635	Colour code, paint	637	Cross Traffic Alert	355
Seatbelts	627	Colour codes	637	activate/deactivate	356
upholstery	625, 627, 628, 629	Combined instrument panel	77	Limitations	356
Cleaning wheel rims	635	settings	79	messages	358
Cleaning wiper blades	633	Compass	483	Cruise control	291
Clean Zone	199	calibration	483	activate	293
Clean Zone Interior Package	200	Condensation in headlamps	631, 632, 633, 634	deactivate	295
Climate control	196, 207	Connect car to Internet		managing speed	319
auto-regulation	211	no or poor connection	526	reactivate	294
centre display	207	via a mobile device (WiFi)	523	temporary deactivation	293
experienced temperature	197	via car modem	523	Customer privacy policy	36
fan control	216	via telephone (Bluetooth)	522	CZIP (Clean Zone Interior Package)	200
Parking	219	Connect phone	513		
rear seat	207	Controls lighting	157		
sensors	196	Control unit			
temperature control	217, 218	charging status	414		
voice control	197	Coolant	655		
zones	196	filling	603		
Climate control system					
Refrigerant	656				
Clock, adjustment	86				

## D

---

Data	
recording	35
transfer between car and workshop	590
Data link connector	38
Data sharing	527

Daytime running lights	146	Drive-E		Driving mode	447
Deadlock	275	Environmental philosophy	28	change	451
deactivation	276	Driver Alert Control	366	Driver support	319
Defrosting	213	activate/deactivate	367	Driving with a trailer	
Digital radio (DAB)	496	guide to rest stops	368	towball load	650
Dimensions	647	Limitations	368	towing capacity	650
Towbar	470	Driver display	77		
dipped beam	147	application menu	96, 97		
Dipstick, electronic	602	hybrid-related symbols and messages	421	<b>E</b>	
Direction indicator	150	messages	98	<hr/>	
Direction indicators	150	settings	79	eCall	540
direction of rotation	547	Driver performance	85	Economical driving	455
Display		settings	86	ECO pressure	549, 663
driver information	77	Driver profile	129	Electrically operated parking brake	434
Display lighting	157	edit	130, 131, 133	Electrical socket	573
Distance Warning	296	select	130	using	575
activate/deactivate	297	driver support system	278	Electrical system	606
Limitations	297	Driving mode	319	Electric drive motor	
Set time interval	318	Drive systems	445	specifications	652
DivX®	502	Drivetrain		Electric motor	445
Door mirrors	163	Gearbox	440	Electric operation	
Dipping	164	Driving		range	456
resetting	165	cooling system	466	emergency brake lights	153
store position	180, 181	with a trailer	472	Emergency equipment	
Download Centre	591	Driving economy	455	first aid kit	587
using	591	Driving in water	460	warning triangle	587

## ALPHABETICAL INDEX

Emergency puncture repair kit	563	Ethanol content	464	Front seat	
implementation, follow-up inspection	564	External dimensions	647	Climate control	207
Pump up tyre	567			Fan	216
using	564			heating	208, 209
Emissions of carbon dioxide	658			Temperature	217
Energy distribution		<b>F</b>		Ventilation	210
assisted by map data	451			Front seat, manual	178
Engine		Fan		Front seat, power	179
automatic start and stop of internal		Air distribution	202	adjusting seat	179
combustion engine	446	Air vents	203	adjusting the passenger seat from the	
deactivate	428	Control	216	driver's seat	187
overheating	466	Fault tracing		Lumbar support	185
start	426	Adaptive Cruise Control	303	massage	182, 183, 184
Engine braking	432, 441	Camera unit	330	multi-function control	182, 183, 184, 185
Engine compartment		City Safety	346	Side supports	185
coolant	603	Radar unit	330	store position	180, 181
Engine oil	601	Ferry transport	453	FSC, ecolabelling	23
overview	600	First aid	587	Fuel	463, 464
Engine drag control	279	First aid kit	587	fuel consumption	658
Engine oil	601, 654	Flooded road	460	identifier	464
adverse driving conditions	654	Fluids, capacities	641, 656	fuel gauge	80
filling	602	Fluids and oils	655, 656	Fuelling	
filter	601	Fog lamp		filling	462
grade and volume	653	front	151	fuel filler flap	461
Engine specifications	652	rear	152	Fuel tank	
Engine temperature		Foot brake	432	volume	656
high	466	Four-C	453	Fuel vapour	463
Environment	28			Fuse box	612



Fuses	612	Hard disk		Hill start assist	
changing	612	space	528	Hill Start Assist (HSA)	439
in cargo area	621	Hazard warning flashers	153	Hill Start Assist	439
in engine compartment	614	Headlamp beam		Hold	
under glovebox	618	adaptation	145	car function	458
<b>G</b>		Headlamp control	144, 157	HomeLink®	479
<hr/>		Headlamp pattern, adjusting	145	program	480
Gearbox	440	head restraint	190	Type approval	482
automatic	441	Head up display		using	482
Gear positions		activate/deactivate	137	Home safe light duration	154
automatic gearbox	441	cleaning	626	Horn	192
Gear selector inhibitor	444	Distance Warning	296	Hybrid battery	610
Gear shift indicator	444	settings	137	charging	405
Glass, laminated/reinforced	160	store position	137, 180, 181	Hybrid battery meter	81
Glovebox	576	windscreen replacement	598	Hybrid meter	80
Gracernote®	501	Head-up display	135	Hybrid operation	447, 451
Gross vehicle weight	649	Heated wiper blades	170		
Ground fault breaker	408	Heater	228	<b>I</b>	
GSI - Gear selector assistance	444	auxiliary heater	230	<hr/>	
		parking heater	229	IAQS (Interior Air Quality System)	200
		Heating		IC (Inflatable Curtain)	56
		seats	208, 209	ID, Volvo	26
		steering wheel	211	Identification number	39
		Windows	214, 215	Ignition position	428, 429
		High engine temperature	466	Immobiliser	248
		High-pressure washing	633		
Handbrake	434				
Handwash	631				





## ALPHABETICAL INDEX

**O**

Obstacle detection	
City Safety	339
octane rating	464
Oil, see also Engine oil	653, 654
Oil level low	602
Online car	521
no or poor connection	526
Option/accessory	21
Output	652
electric motor	652
outside temperature gauge	87
Overheating	466, 472
Overtaking Assistance	
Adaptive Cruise Control	321
Pilot Assist	321
start with adaptive cruise control	322
start with Pilot Assist	322
Owner's information	16
Owner's manual	21
ecolabelling	23
in centre display	17, 18
in mobile	20

**P**

PACOS (Passenger Airbag Cut Off Switch)	53
Paddle on the steering wheel	192
Paintwork	
colour code	637
damage and touch-up	636, 637
Panorama roof	166
opening and closing	167
pinch protection	160
sun blind	169
ventilation position	168
Parallel parking	394
Park Assist	381
activate/deactivate	383
forward, backward and along the sides	382
Limitations	384
Symbols and messages	385
Park assist camera	386
activate	392
Limitations	330
park assist lines	389
sensor fields	391
Symbols and messages	393
views	387
Park Assist Pilot	394
leave parking	398
parallel parking	395

Parking	396
perpendicular parking	395
Parking	
on hill	437
Parking brake	434
activate/deactivate	435
automatic activation	436
low battery voltage	437
Parking climate	219
Symbols and messages	226
Parking heater	229
Passenger Airbag Cut Off Switch	53
Passenger compartment filter	201
Passenger compartment heater (Parking heater)	229
Passenger compartment interior	570
cigarette lighter	571
electrical socket	573
glovebox	576
Sun visor	578
tunnel console	571
Passenger compartment lighting	
automatic	155
Pedestrian Protection System	44
Personal information (Customer privacy policy)	36
petrol	464



## ALPHABETICAL INDEX

heating	215	Resetting, trip meter	85	<b>S</b>	
interior	163	Resetting the door mirrors	165		
rear window		Restore settings	127		
heating	215	change of owner	127		
Washers	174, 175	Driver profile	133		
Wiper	174, 175	Retractable power door mirrors	165		
Recommendations during driving	459	Reversing camera	386		
Recommendations for loading	578	Rims			
Recovery	479	dimensions	546		
Red Key		Road run-off protection	377		
restricted remote control key	244	Road sign information	359		
settings	244	Limitations	365		
Refrigerant	598	Road Sign Information			
climate control system	656	activate/deactivate	360		
Refuelling	462	display	361		
Regeneration	465	Sensus Navigation	363		
Remote control, HomeLink®		settings	363		
programmable	479	speed camera information	365		
Remote control immobiliser	248	Speed warning	364		
Remote control key	235	Roof load, max. weight	649		
battery replacement	240	Rustproofing	635		
connect to driver profile	131				
detachable key blade	245				
loss	243				
range	239				
Remote control key system, type approval	249				
Remote updates	591				
					Safety
				pregnancy	42
				Safety mode	57
				start/movement	57
				Sealing fluid	563
				Seat, see Seats	178
				Seatbelt	45
				buckle/unbuckle	46
				pregnancy	42
				seatbelt reminder	49
				seatbelt tensioner	47
				Seatbelt, see Seatbelts	45
				Seatbelt reminder	49
				seatbelt tensioner	
				Resetting	48
				Seatbelt tensioner	47
				Seats	
				heating	208, 209
				manual front seat	178
				power front seat	179
				store position	180, 181
				Ventilation	210
				whiplash protection	43
				Security code	271

sensors		spare wheel	560	Steering lock	192
Air quality	201	manage	561	Steering wheel	192, 193
Camera unit	329	Speed camera information	365	heating	211
Climate control	196	Speed limiter	284	keypad	192
Radar unit	323	activate	285	paddle	192
Sensus		automatic	288	steering wheel adjustment	193
connection and entertainment	32	change speed	319	Steering wheel paddles	443
Sensus Navigation		deactivation	287	Stickers	
Road Sign Information	363	Limitations	287	location	644
Service position	640	reactivate	286	Stone chips and scratches	636, 637
Service programme	590	temporary deactivation	285	Storage spaces	570
Set time interval for Distance Warning	318	Speed ratings, tyres	545	glovebox	576
Settings		Spin control	279	Sun visor	578
Categories	128	Stabiliser		tunnel console	571
contextual	126	trailer	474	Sun blind	
Resetting	127	Stability and traction control system	279	panorama roof	166, 169
Side airbag	55	sport mode	280, 281	pinch protection	160
Side Impact Protection System	55, 56	Symbols and messages	282	Sunroof	
SIM card	524	Stains	625, 627, 628, 629	pinch protection	160
SIPS (Side Impact Protection System)	55, 56	Starting the engine	426	Sun visor	578
Skidding	459, 460	after collision	57	mirror lighting	156
Ski hatch	581	Start the car	426	Switching off the engine	428
slippery driving conditions	460	State of charge		Switch off engine	428
Snow chains	562	car function	458	Symbols	
Software updates	35	Steering assistance at risk of collision	375	dynamic	77
Sound experience	487	Steering force, speed related	278	indicator symbols	87
		Steering force level, see Steering force	278	warning symbols	89

## ALPHABETICAL INDEX

Symbols and messages		Towbar	469	Trip statistics	
centre display status field	117	foldable	470	settings	86
hybrid related	421	specifications	470	TSA - trailer stability assist	474
parking climate	226	Towing	477, 479	Tunnel console	571
system updates	591	Towing capacity and towball load	650	Tunnel detection	147
		Towing eye	478	Twin Engine	
		Traction control	279	General	404
		Traffic information	494	Type approval	
		Trailer		HomeLink®	482
<b>T</b>		cable	473	radar system	324
<hr/>		driving with a trailer	472	radio equipment	328
Tailgate		Lamps	475	remote control key system	249
Locking/unlocking	239, 261	snaking	474	Type designations	644
opening/closing with foot movement	269	Trailer stability assist	280, 474	Tyre dimension	545
power	266	Trailer Stability Assist	280	Tyre dimensions	
unlock from inside	263	Transmission	440	when changing wheels	555
Temperature		Transmission oil		Tyre load index	545
Control	217, 218	grade	655	Tyre pressure	
experienced	197	Tread	547	Adjust	548
Temperature monitoring	409	Tread depth	547	Check	548
Temporary Spare	560	winter tyres	561	label showing recommended pressure	549
Terms and conditions		Tread wear indicators	547	Tyre pressure monitoring	550
services	36	Trip computer	82	action	554
user	527	show in driver display	84	save a new tyre pressure	551
Through-load hatch	581	Trip meter	82	Status	553
Tilt detector	273	Trip meter, resetting	85	Tyre pressure table	663
Tools	555				
Top view	125				
Total airing function	235				



Tyres	544
dimensions	661
direction of rotation	547
installation	559
pressure	663
removal	557
rotation during replacement	544
specifications	661, 662, 663
storage	544
tread wear indicators	547
tyre pressure table	663
winter tyres	561

## U

---

Units	125
Unlocking	
settings	238
with key blade	247
USB	
jack for connecting media	504

## V

---

Ventilation	201, 202, 203
seats	210
Vibration damper	469

Video	502, 504
settings	503
Voice control	
Climate control	197
phone	140
radio and media	141
settings	142
Voice recognition	138
VOL marking	544
Volvo ID	26
create and register	26

## W

---

Warning lamps	
Adaptive Cruise Control	316
Airbags – SRS	89
alternator not charging	89
Fault in brake system	89
Low oil pressure	89
Parking brake applied	89
Pilot Assist	316
seatbelt reminder	89
stability and traction control system	279
starter battery not charging	89
Warning	89
Warning sound	
Parking brake	437
Warning symbols	89
Safety	42
Warning triangle	587
Washer fluid	170, 641
Washers	
Headlamps	173
rear window	174, 175
washer fluid, filling	641
windscreen	173
Waxing	630
Weights	
kerb weight	649
Wheel bolts	556
Wheel change	555
Wheel rims	
cleaning	635
Wheels	
installation	559
removal	557
snow chains	562
Wheels and tyres	
approved dimensions	661
tyre load index and speed rating	662
whiplash protection	43
Whiplash Protection System	43
WHIPS (Whiplash Protection System)	43

## ALPHABETICAL INDEX

Wi-Fi	
connect car to Internet	523
delete network	526
share internet connection, hotspot	525
technology and security	527
Windows and glass	160
Windscreen	
heating	214
projected image	135, 137
Windscreen washing	173
Windscreen wiper	170
rain sensor	171, 172
Winter driving	459
snow chains	562
winter tyres	561
Wiper blades	170
changing	638, 639
Service position	640
Wiper blades, heated	170
Wiper blades and washer fluid	170



**V O L V O**