



V70

XC70

WEB EDITION
OWNER'S MANUAL

DEAR VOLVO OWNER

THANK YOU FOR CHOOSING VOLVO

We hope you will enjoy many years of driving pleasure in your Volvo. The car has been designed for the safety and comfort of you and your passengers. Volvo is one of the safest cars in the world. Your Volvo has also been designed to satisfy all current safety and environmental requirements.

In order to increase your enjoyment of the car, we recommend that you familiarise yourself with the equipment, instructions and maintenance information contained in this owner's manual.





01 Introduction

Owner's Manual in the car's screen.....	13
Reading the owner's manual.....	13
Digital owner's manual in the car.....	16
Recording data.....	18
Accessories and extra equipment.....	19
Support and information about the car on the Internet.....	20
Volvo ID.....	21
Environmental philosophy.....	22
The owner's manual and the environment.....	24
Laminated glass.....	24
Bi-Fuel* - introduction to vehicle gas.....	24



02 Safety

General information on seatbelts.....	27
Seatbelt - putting on.....	28
Seatbelt - loosening.....	28
Seatbelt - pregnancy.....	29
Seatbelt reminder.....	29
Seatbelt tensioner.....	30
Safety - warning symbol.....	30
Airbag system.....	31
Driver airbag.....	32
Passenger airbag.....	33
Passenger airbag - activating/deactivating*.....	34
Side airbag (SIPS).....	36
Side airbag (SIPS) - child seat/booster cushion.....	37
Inflatable Curtain (IC).....	37
General information on WHIPS (whiplash protection).....	38
WHIPS - child seats.....	39
WHIPS - seating position.....	39
When the systems deploy.....	40
General information on safety mode.....	41
Safety mode - attempting to start the car.....	42
Safety mode - moving the car.....	43



General information on child safety.....	43
Child seats.....	44
Child seats - location.....	49
Child seat - two-stage booster seat*.....	50
Two-stage booster seat* - raising.....	51
Two-stage booster seat* - lowering.....	52
Child seat - ISOFIX.....	53
ISOFIX - size classes.....	53
ISOFIX - types of child seat.....	55
Child seats - upper mounting points.....	57



03 Instruments and controls

Instruments and controls, left-hand drive car - overview.....	59
Instruments and controls, right-hand drive car - overview.....	62
Combined instrument panel.....	65
Analogue combined instrument panel - overview.....	65
Digital combined instrument panel - overview.....	66
Eco guide & Power guide*.....	69
Combined instrument panel - meaning of indicator symbols.....	70
Combined instrument cluster - meaning of warning symbols.....	72
Outside temperature gauge.....	74
Trip meter.....	74
Clock.....	75
Fuel gauge for vehicle gas*.....	75
Combined instrument panel - license agreement.....	76
Symbols in the display.....	76
Volvo Sensus.....	79
Key positions.....	80
Key positions - functions at different levels.....	81
Seats, front.....	82



Seats, front - electrically operated*.....	83
Seats, rear.....	84
Steering wheel.....	86
Heating* of the steering wheel.....	88
Light switches.....	88
Position/parking lamps.....	91
Daytime running lights.....	91
Tunnel detection*.....	92
Main/dipped beam.....	92
Active main beam*.....	93
Active Xenon headlamps*.....	95
Rear fog lamp.....	95
Brake lights.....	96
Hazard warning flashers.....	96
direction indicators.....	97
Interior lighting.....	98
Home safe light duration.....	99
Approach lighting.....	99
Headlamps - adjusting headlamp pattern.....	100
Wipers and washers.....	104
Power windows.....	106
Door mirrors.....	108



Windows and rearview and door mirrors - heating.....	109
Rearview mirror - interior.....	110
Compass*.....	110
Sunroof*.....	112
Menu navigation - combined instrument panel.....	113
Menu overview - combined instrument panel.....	114
Messages.....	115
Messages - handling.....	116
MY CAR.....	116
Trip computer.....	117
Trip computer - analogue combined instrument panel.....	119
Trip computer - digital combined instrument panel.....	123
Trip computer - supplementary information.....	127
Trip computer - trip statistics*.....	128



04 Climate control

General information on climate control...	130
Actual temperature.....	131
Sensors - climate control.....	131
Air quality.....	131
Air quality - passenger compartment filter.....	132
Air quality - Clean Zone Interior Package (CZIP)*.....	132
Air quality - IAQS*.....	133
Air quality - material.....	133
Menu settings - climate control.....	133
Air distribution in the passenger compartment.....	134
Electronic climate control - ECC.....	136
Heated front seats*.....	137
Heated rear seat*.....	137
Ventilated front seats*.....	138
Fan.....	139
Auto-regulation.....	139
Temperature control in the passenger compartment.....	139
Air conditioning.....	140
Demisting and defrosting the wind-screen.....	140
Air distribution - recirculation.....	141



Air distribution - table.....	143
Engine block heater and passenger compartment heater*.....	145
Engine block heater and passenger compartment heater* - direct start.....	146
Engine block heater and passenger compartment heater* - immediate stop.....	147
Engine block heater and passenger compartment heater* - timer.....	147
Engine block heater and passenger compartment heater* - messages.....	149
Additional heater*.....	151
Fuel-driven additional heater*.....	151
Electric additional heater*.....	152



05 Loading and storage

Storage spaces.....	154
Tunnel console.....	156
Tunnel console - cigarette lighter and ashtray*.....	156
Glovebox.....	156
Inlay mats*.....	157
Vanity mirror.....	157
Tunnel console - 12 V-sockets.....	157
Loading.....	158
Loading - long load.....	159
Roof load.....	160
Securing loads.....	160
Loading - bag holder*.....	161
12 V electrical socket - cargo area*.....	161
Safety net*.....	162
Safety net* combined with cargo cover..	163
Safety grille.....	163
Cargo cover.....	165

**06 Locks and alarm**

Remote control key.....	167
Remote control key - losing	167
Remote control key - personalisation*....	168
Locking/unlocking - indicator.....	169
Immobiliser.....	169
Remote-controlled immobiliser with tracking system*.....	170
Remote control key - functions.....	170
Remote control key - range.....	172
Remote control key with PCC* - unique functions.....	172
Remote control key with PCC* - range...	173
Detachable key blade.....	174
Detachable key blade - detaching/ attaching.....	174
Detachable key blade - unlocking doors	175
Privacy locking*.....	175
Remote control key - replacing the battery.....	177
Keyless drive*.....	178
Keyless Drive* - remote control key range.....	178
Keyless drive* - secure handling of the remote control key.....	179



Keyless drive* - interference to remote control key function.....	180
Keyless drive* - locking.....	180
Keyless drive* - unlocking.....	181
Keyless drive* - unlocking with the key blade	181
Keyless Drive* - lock settings.....	182
Keyless Drive* - antenna location.....	182
Locking/unlocking - from the outside.....	183
Locking/unlocking - from the inside.....	183
Global opening.....	184
Locking/unlocking - glovebox.....	184
Locking/unlocking - tailgate.....	185
Power operated tailgate*.....	186
Deadlocks*.....	187
Child safety locks - manual activation....	188
Child safety locks - electrical activation*	189
Alarm.....	190
Alarm indicator.....	191
Alarm - automatic re-arming.....	191
Alarm - remote control key not working.	191
Alarm signals.....	192
Reduced alarm level.....	192



Type approval - remote control key system.....	192
--	-----

06



07 Driver support

Active chassis - Four C*.....	195
Adjustable steering force*.....	195
Electronic stability control (ESC) - general.....	196
Electronic stability control (ESC) - operation.....	196
Electronic stability control (ESC) - symbols and messages.....	198
Road Sign Information (RSI)*.....	200
Road sign information (RSI)* - operation	200
Road sign information (RSI)* - limitations	202
Cruise control*.....	203
Cruise control* - managing speed.....	203
Cruise control* temporary deactivation and standby mode.....	204
Cruise control* - resume set speed.....	205
Cruise control* - deactivate.....	205
Adaptive cruise control - ACC*.....	205
Adaptive cruise control* - function.....	206
Adaptive cruise control* - overview.....	208
Adaptive cruise control* - managing speed.....	209
Adaptive cruise control* - set time interval.....	210



Adaptive cruise control* - temporary deactivation, and standby mode.....	211
Adaptive cruise control* - overtaking another vehicle.....	212
Adaptive cruise control* - deactivate.....	212
Adaptive Cruise Control* - queue assistance.....	212
Adaptive cruise control* - switch cruise control functionality.....	214
Radar sensor.....	215
Radar sensor - limitations.....	215
Adaptive cruise control* - fault tracing and action.....	217
Adaptive cruise control* - symbols and messages.....	218
Distance Warning*.....	220
Distance Warning* - limitations.....	221
Distance Warning* - symbols and messages.....	222
City Safety™.....	223
City Safety™ - function.....	223
City Safety™ - operation.....	224
City Safety™ - limitations.....	225
City Safety™ - laser sensor.....	227
City Safety™ - symbols and messages..	229



Collision warning system*.....	230
Collision warning system* - function.....	231
Collision warning system* - detection of cyclists.....	232
Collision warning system* - detection of pedestrians.....	233
Collision warning system* - operation....	234
Collision warning system* - limitations...	235
Collision warning system* - camera sensor limitations.....	236
Collision warning system* - symbols and messages.....	238
Driver Alert System*.....	240
Driver Alert Control (DAC)*.....	240
Driver Alert Control (DAC)* - operation...	241
Driver Alert Control (DAC)* - symbols and messages.....	242
Lane Departure Warning (LDW)*.....	243
Lane Departure Warning (LDW) - function.....	243
Lane Departure Warning (LDW) - operation.....	244
Lane Departure Warning (LDW) - limitations.....	245
Lane Departure Warning (LDW) - symbols and messages.....	246



Park Assist*.....	247
Park assist syst* - function.....	247
Park assist syst* - backward.....	248
Park assist syst* - forward.....	249
Park assist syst* - fault indication.....	250
Park assist syst* - cleaning the sensors.....	250
Park assist camera*.....	251
Park assist camera - settings.....	253
Park assist camera - limitations.....	254
BLIS*.....	254
BLIS* - operation.....	255
BLIS - symbols and messages.....	257
Type approval - radar system.....	258



08 Starting and driving

Alcohol lock*.....	260
Alcohol lock* - functions and operation..	260
Alcohol lock* - storage.....	261
Alcohol lock* - before starting the engine	261
Alcohol lock* - to bear in mind.....	263
Alcohol lock* - symbols and text mes- sages.....	264
Starting the engine.....	265
Switching off the engine.....	266
Steering lock.....	266
Remote start (ERS)*.....	267
Remote start (ERS) - operation.....	267
Remote start (ERS) - symbols and mes- sages.....	269
Jump starting with battery.....	270
Gearboxes.....	271
Manual gearbox.....	271
Gear shift indicator*.....	272
Automatic gearbox -- Geartronic*.....	273
Automatic gearbox -- Powershift*.....	276
Gear selector inhibitor.....	278
Hill start assist (HSA)*.....	279
All-wheel drive - (AWD)*.....	279
Hill Descent Control (HDC)*.....	280



Start/Stop*.....	281
Start/Stop* - function and operation.....	282
Start/Stop* - the engine does not stop...	283
Start/Stop* - the engine auto-starts.....	284
Start/Stop* - the engine does not auto- start.....	285
Start/Stop* - involuntary stop manual gearbox.....	286
Start/Stop* - settings.....	286
Start/Stop* - symbols and messages....	288
ECO*.....	290
Foot brake.....	292
Foot brake - anti-lock braking system....	293
Foot brake - emergency brake lights and automatic hazard warning flashers.....	294
Foot brake - emergency brake assis- tance.....	294
Parking brake.....	295
Driving in water.....	299
Overheating.....	299
Driving with open tailgate/boot lid.....	300
Overload - starter battery.....	300
Before a long journey.....	301
Winter driving.....	301
Fuel filler flap - Opening/closing.....	302



Fuel filler flap - manual opening.....	302
Filling up with fuel.....	302
Fuel - handling.....	303
Fuel - petrol.....	304
Fuel - diesel.....	304
Diesel particle filter (DPF).....	306
Filling vehicle gas*.....	306
Switch for gas operation*.....	307
Catalytic converters.....	308
Economical driving.....	308
Driving with a trailer*.....	309
Driving with a trailer* - manual gearbox..	311
Driving with a trailer* - automatic gear- box.....	311
Towing bracket/Towbar*.....	312
Detachable towbar* - storage.....	312
Detachable towbar* - specifications.....	313
Detachable towbar* - attachment/ removal.....	314
Towing.....	316
Towing eye.....	317
Recovery.....	318



09 Wheels and tyres

Tyres - maintenance.....	321
Tyres - direction of rotation.....	322
Tyres - tread wear indicators.....	323
Tyres - air pressure.....	323
Wheel and wheel rim dimensions.....	325
Tyres - dimensions.....	325
Tyres - load index.....	326
Tyres - speed ratings.....	326
Wheel bolts.....	327
Winter tyres.....	327
Changing wheels - removing wheels.....	328
Changing wheels - fitting.....	330
Warning triangle.....	331
Tools.....	332
Jack*.....	333
First aid kit*.....	333
Tyre pressure monitoring*.....	334
Tyre pressure monitoring system (TPMS)* - general.....	335
Tyre pressure monitoring (TPMS)* - adjust (recalibration).....	336
Tyre pressure monitoring system (TPMS)* - status.....	336
Tyre pressure monitoring (TPMS)* - acti- vate/deactivate.....	337



Tyre pressure monitoring (TPMS)* - rec- ommendations.....	338
Tyre pressure monitoring (TPMS)* - driv- eable punctured tyres*.....	338
Tyre pressure monitoring (TPMS)* - recti- fying low tyre pressure.....	339
Tyre pressure monitoring (TM)*.....	339
Emergency puncture repair*.....	341
Emergency puncture repair kit* - loca- tion.....	342
Emergency puncture repair kit* - over- view.....	343
Emergency puncture repair* - operation.	343
Emergency puncture repair* - recheck- ing.....	345
Emergency puncture repair kit* - inflating the tyres.....	346
Emergency puncture repair kit* - sealant	347
Type approval - tyre pressure monitoring (TPMS).....	348



10 Maintenance and service

Volvo service programme.....	355
Book service and repair*.....	355
Inspection and service of the system for vehicle gas*.....	357
Raising the car.....	358
Bonnet - opening and closing.....	360
Engine compartment - overview.....	360
Engine compartment - checking.....	361
Engine oil - general.....	362
Engine oil - checking and filling.....	363
Coolant - level.....	366
Brake and clutch fluid - level.....	367
Power steering fluid - level.....	368
Climate control system - fault tracing and repair.....	369
Lamp replacement - general.....	369
Lamp replacement - headlamps.....	370
Lamp replacement - cover for main/dipped beam bulbs.....	371
Lamp replacement - dipped beam.....	371
Lamp replacement - main beam.....	372
Lamp replacement - extra main beam....	372
Lamp replacement - direction indicators front.....	372
Lamp replacement - rear lamp.....	373



Lamp replacement - location of rear lamps.....	373
Lamp replacement - number plate lighting.....	373
Lamp replacement - lighting in cargo area.....	374
Lamp replacement - vanity mirror lighting.....	374
Lamps - specifications	375
Wiper blades.....	375
Washer fluid - filling.....	377
Starter battery - general.....	378
Battery - symbols.....	380
Starter battery - replacement.....	380
Battery - Start/Stop.....	382
Electrical system.....	384
Fuses - general.....	384
Fuses - in engine compartment.....	386
Fuses - under glovebox.....	390
Fuses - in the control module under the glovebox.....	392
Fuses - in cargo area.....	394
Fuses - in the engine compartment's cold zone.....	396
Car wash.....	398



Polishing and waxing.....	399
Water and dirt-repellent coating.....	400
Rustproofing.....	401
Cleaning the interior.....	401
Paint damage.....	402



11 Specifications

Type designations.....	405
Dimensions.....	408
Weights.....	410
Towing capacity and towball load.....	411
Engine specifications.....	414
Engine oil - adverse driving conditions...	416
Engine oil - grade and volume.....	417
Coolant - grade and volume.....	419
Transmission fluid - grade and volume...	420
Brake fluid - grade and volume.....	422
Power steering fluid - grade.....	422
Fuel tank - volume.....	423
Specifications for air conditioning.....	424
Fuel consumption and CO2 emissions...	425
Tyres - approved tyre pressures.....	430



12 Alphabetical Index

Alphabetical Index.....	432
-------------------------	-----





01



INTRODUCTION





Owner's Manual in the car's screen

A digital version of the owner's manual is available¹ on the car's screen. The owner's manual provides information about how the car works.

For cars with owner information in the screen, the printed owner's manual is a supplement and contains important text, the latest updates, as well as instructions that can be useful when, for practical reasons, it is not possible to read the information on the screen.

The owner's manual is also available on Volvo's support page and can be downloaded as a mobile app.

Changing the screen's language may mean that certain information is no longer in accordance with national or local laws and regulations.

IMPORTANT

The driver is always responsible that the vehicle is driven safely in traffic and that applicable laws and regulations are followed. It is also important that the car is maintained and handled in accordance with Volvo's recommendations in the owner's information.

If there should be a difference between the information on the screen and in the printed manual then it is always the printed information that applies.

Reading the owner's manual

A good way of getting to know your new car is to read the owner's manual, ideally before your first journey.

Reading the owner's manual is a good way to become familiar with new functions, get advice on how best to handle the car in different situations and learn how to make the best use of all the car's features. Please pay attention to the safety instructions contained in the owner's manual.

The specifications, design features and illustrations in the owner's manual are not binding. We reserve the right to make modifications without prior notice.

© Volvo Car Corporation

IMPORTANT

Do not remove this manual from the car - should a problem arise then the information required about where and how to seek professional help would be missing.

¹ Applies to certain car models.



Owner's Manual in mobile devices



NOTE

The Owner's manual is available for download as a mobile application (applies for certain car models and mobile devices), see www.volvocars.com.

The mobile application also includes video and searchable content and easy navigation between different sections.

Options/accessories

All types of option/accessory are marked with an asterisk*.

In addition to standard equipment, the owner's manual also describes options (factory fitted equipment) and certain accessories (retrofitted extra equipment).

The equipment described in the owner's manual is not available in all cars - they have

different equipment depending on adaptations for the needs of different markets and national or local laws and regulations.

In the event of uncertainty over what is standard or an option/accessory, contact a Volvo dealer.

Special texts

WARNING

Warning texts appear if there is a risk of injury.

IMPORTANT

"Important" texts appear if there is a risk of damage.

NOTE

NOTE texts give advice or tips that facilitate the use of e.g. features and functions.

Footnote

There is footnote information in the owner's manual that is located at the bottom of the page. This information is an addition to the text that it refers to via a number. If the footnote refers to text in a table then letters are used instead of numbers for referral.

Message texts

In the car there are displays that show menu texts and message texts. In the owner's man-

ual the appearance of these texts differs from the normal text. Examples of menu texts and message texts: **Media**, **Sending location**.

Decals

The car contains different types of decal which are designed to convey important information in a simple and clear manner. The decals in the car have the following descending degree of importance for the warning/information.

Warning for personal injury

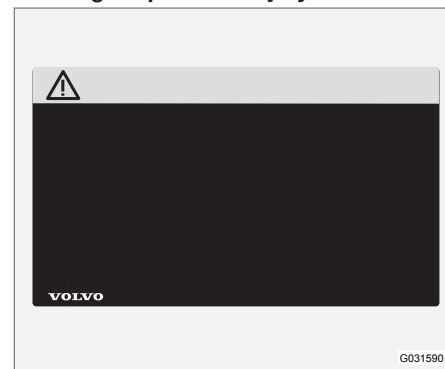

Black ISO symbols on yellow warning field, white text/image on black message field. Used to indicate the presence of danger which, if the warning is ignored, may result in serious personal injury or fatality.

Risk of property damage



White ISO symbols and white text/image on black or blue warning field and message field. Used to indicate the presence of danger which, if the warning is ignored, may result in damage to property.

Information



White ISO symbols and white text/image on black message field.

i NOTE

It is not intended that the decals illustrated in the owner's manual should be exact replicas of those in the car. They are included to show their approximate appearance and location in the car. The information that applies to your particular car can be found on the decal on the car.

Procedure lists

Procedures where action must be taken in a certain sequence are numbered in the owner's manual.

- 1 When there is a series of illustrations for step-by-step instructions each step is numbered in the same way as the corresponding illustration.
- A Lists of letters appear adjacent to the series of illustrations where the order of the instructions is not significant.
- 1 Arrows appear numbered and unnumbered and are used to illustrate a movement.
- A Arrows with letters are used to clarify a movement when the reciprocal order is of no relevance.

If there is no series of illustrations for step-by-step instructions then the different steps are numbered with normal numbers.

Position lists

- 1 Red circles containing a number are used in overview images where different components are pointed out. The number recurs in the position list featured in connection with the illustration that describes the item.

Bulleted lists

A bulleted list is used when there is a list of points in the owner's manual.

Example:

- Coolant
- Engine oil



Related information

Related information refers to other articles containing closely-associated information.

Images

The manual's images are sometimes schematic and may deviate from the car's appearance depending on equipment level and market.

To be continued

▶▶ This symbol is located furthest down to the right when an article continues on the following page.

Continued from previous page

◀◀ This symbol is located furthest up to the left when an article continues from the previous page.

Related information

- The owner's manual and the environment (p. 24)
- Support and information about the car on the Internet (p. 20)

Digital owner's manual in the car

The owner's manual can be read on the screen in the car². The content is searchable and it is easy to navigate between different sections.

Open the digital owner's manual - press the **MY CAR** button in the centre console, press **OK/MENU** and select **Owner's manual**.

For basic navigation, see Operating the system. See below for a more detailed description.

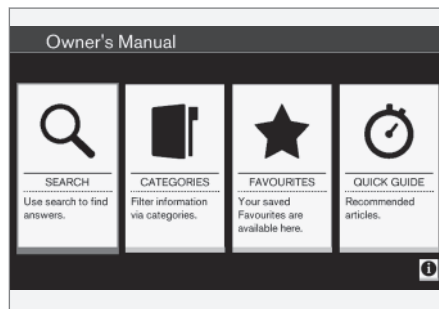

Owner's manual, start page.

There are four options for finding information in the digital owner's manual:

- **Search** - Search function for finding an article.
- **Categories** - All articles sorted into categories.
- **Favourites** - Quick access to favourite-bookmarked articles.
- **Quick Guide** - A selection of articles for common functions.

Select the information symbol in the lower right-hand corner in order to obtain information about the digital owner's manual.



NOTE

The digital owner's manual is not available while driving.

² Applies to certain car models.



Search

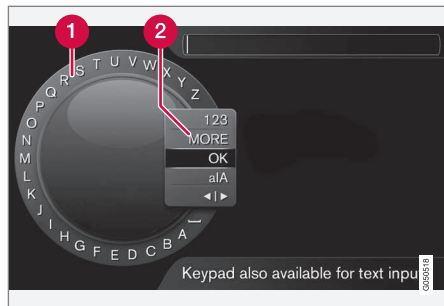

Searching using the character wheel.

- 1 Character list.
- 2 Changing the input mode (see following table).

Use the character wheel to enter a search term, e.g. "seatbelt".

1. Turn **TUNE** to the desired letter, press **OK/MENU** to confirm. The number and letter buttons on the control panel in the centre console can also be used.
2. Continue with the next letter and so on.

3. To change the input mode to numbers or special characters, or to perform a search, turn **TUNE** to one of the options (see explanation in the following table) in the list for changing the input mode (2), press **OK/MENU**.

123/ABC	Change between letters and numbers with OK/MENU .
MORE	Change to special characters with OK/MENU .
OK	Perform the search. Turn TUNE to select a search result article, press OK/MENU to go to the article.
a A	Changes between lowercase and uppercase letters with OK/MENU .
< >	Changes from the character wheel to the search field. Move the cursor with TUNE . Delete any misspelling with EXIT . To return to the character wheel, press OK/MENU . Note that the digit and letter buttons on the control panel can be used for editing in the search field.

Enter with the numerical keyboard



Numerical keyboard.

Another way of entering characters is to use the centre console's buttons **0-9**, * and #.

When e.g. **9** is pressed, a bar appears with all characters³ under the button, e.g. **W, x, y, z** and **9**. Quick presses on the button move the cursor through these characters.

- Stop with the cursor on the desired character in order to select it - the character is shown on the enter line.
- Delete/undo using **EXIT**.

To enter a number, hold in the corresponding number key.

Categories

The articles in the owner's manual are structured into main categories and subcategories.

³ The character for each button may vary depending on market/country/language.



The same article can be in several appropriate categories in order to be found more easily.

Turn **TUNE** to navigate in the category tree and press **OK/MENU** to open a category - selected **■** - or article - selected **□**. Press **EXIT** to go back to the previous view.

Favourites

Located here are the articles that are saved as favourites. To select an article as a favourite, see the heading "Navigating in an article" below.

Turn **TUNE** to navigate in the favourite list and press **OK/MENU** to open an article. Press **EXIT** to go back to the previous view.

Quick Guide

Located here is a selection of articles for getting to know the car's most common functions. The articles can also be accessed via categories, but are collected here for quick access.

Turn **TUNE** to navigate in the Quick Guide and press **OK/MENU** to open an article. Press **EXIT** to go back to the previous view.

Navigating in an article

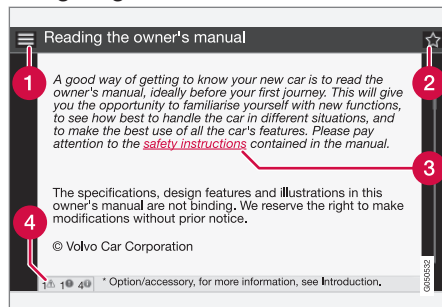

- 1 Home** - leads to the start page for the owner's manual.
- 2 Favourite** - adds/removes an article as a favourite. You can also press the **FAV** button in the centre console to add/remove an article as a favourite.
- 3 Highlighted link** - leads to linked article.
- 4 Special texts** - if the article contains warnings, important or note texts then an associated symbol is shown here as well as the number of such texts in the article.

Turn **TUNE** to navigate between the links or scroll in an article. When the screen has scrolled to the start/end of an article the home and favourite options are accessed by scrolling a further step up/down. Press **OK/MENU** to activate the selection/highlighted link. Press **EXIT** to go back to the previous view.

Recording data

Certain information about the vehicle's operation and functionality, and any incidents, are recorded in the car.

Your vehicle contains a number of computers whose function is to continuously check and monitor the vehicle's operation and functionality. Some of the computers can record information during normal driving if they detect an error. In addition, information is recorded in the event of a collision or incident. Parts of the recorded information are required so that technicians can diagnose and rectify faults in the vehicle during servicing and maintenance and so that Volvo can fulfil legal requirements and other regulations.

In addition to this, the information is used for research purposes by Volvo in order to continually develop quality and safety, as the information can contribute to a better understanding of the factors that cause accidents and injuries.

The information includes details of the status and functionality of various systems and modules in the vehicle with regard to engine, throttle, steering and brake systems, amongst other things. This information may include details regarding the way the driver drives the vehicle, such as vehicle speed, brake and accelerator pedal use, steering wheel movement and whether or not the driver and passengers have used their seatbelts. For the

reasons given this information may be stored in the vehicle's computers for a certain length of time, but also as a result of a collision or incident. This information may be stored by Volvo as long as it can help to further develop and further enhance safety and quality and as long as there are legal requirements and other regulations that Volvo needs to consider.

Volvo will not contribute to the above-described information being disclosed to third parties without the vehicle owner's consent. However, due to national legislation and regulations Volvo may be required to disclose such information to authorities such as police authorities, or others who may assert a legal right to have access to it.

To be able to read and interpret the information recorded by the computers in the vehicle requires special technical equipment that Volvo, and workshops that have entered into agreements with Volvo, have access to. Volvo is responsible that the information, which is transferred to Volvo during servicing and maintenance, is stored and handled in a secure manner and that the handling complies with applicable legal requirements. For further information - contact a Volvo dealer.

Accessories and extra equipment

The incorrect connection and installation of accessories and extra equipment can negatively affect the car's electronic system.

Certain accessories only function when associated software is installed in the car's computer system. Volvo therefore recommends that you always contact an authorised Volvo workshop before installing accessories or extra equipment which are connected to or affect the electrical system.

Heat-reflecting windscreen*

The windscreen is equipped with a heat-reflecting film (IR) that reduces the solar heat radiation into the passenger compartment.

The positioning of electronic equipment, such as a transponder, behind a glass surface with heat-reflecting film may affect its function and performance.

For the optimal function of electronic equipment, it should be positioned on the part of the windscreen with no heat-reflecting film (see the highlighted area in the illustration).

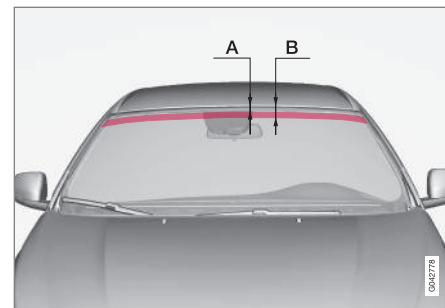

Areas where IR film is not applied.

A is the distance from the top edge of the windscreen down to the start of the field. B is the distance from the top edge of the windscreen down to the end of the field.

	Dimensions
A	47 mm
B	87 mm



Support and information about the car on the Internet

There is additional information regarding your car on the Volvo Cars website and support page. From the website, it is also possible to navigate through to My Volvo, a personal web page for you and your car.

Support on the Internet

Go to support.volvocars.com or use the QR code below to visit the page. The support page is available for most markets.



QR code that leads to the support page.

The information on the support page is searchable and can also be subdivided into different categories. Available here is support for options related to e.g. Internet connected services and functions, Volvo On Call (VOC)*, the navigation system* and apps. Video and step-by-step instructions explain different procedures, e.g. how the car is connected to the Internet via a mobile phone.

⁴ Applies to certain markets.

Downloadable information from the support page

Maps

For cars equipped with Sensus Navigation*, there is the facility to download maps from the support page.

Mobile apps

For selected Volvo models from model year 2014 and 2015, the owner's manual is available in the form of an app. The VOC* app can also be accessed from here.

Owner's manuals from previous model years

Owner's manuals from previous model years are available here in PDF format. The Quick Guide and supplement can also be accessed from the support page. Select car model and model year in order to download the publication required.

Contact

On the support page there is contact information for customer support and the nearest Volvo dealer.

My Volvo on the Internet⁴

From www.volvocars.com it is possible to navigate through to My Volvo Web which is a personal Web page for you and your car.

Create a personal Volvo ID, log in to My Volvo Web and get an overview of service, agree-

ments and warranties, amongst other things. At My Volvo Web there is also information about accessories and software adapted for your car model.

Related information

- Volvo ID (p. 21)



Volvo ID

Volvo ID is your personal ID that provides access to various services⁵.

Examples of services:

- My Volvo - Your personal web page for you and your car.
- In an Internet-connected car* - Certain functions and services require that you have registered your car to a personal Volvo ID, for example to be able to send a new address from a map service on the Internet directly to the car.
- Volvo On Call, VOC* - Volvo ID is used when logging in to the Volvo On Call mobile app.

Advantages of Volvo ID

- One user name and one password to access online services, i.e. only one user-name and one password to remember.
- When changing the username/password for a service (e.g. VOC) it will also be changed automatically for other services (e.g. My Volvo)

Create a Volvo ID

To create a Volvo ID you need to enter a personal e-mail address. Then follow the instructions in the e-mail message that is automatically sent to the specified address in order to complete the registration. It is possible to cre-

ate a Volvo ID via one of the following services:

- My Volvo - Enter your e-mail address and follow the instructions.
- For an Internet-connected car* - Enter your e-mail address in the app that requires Volvo ID and follow the instructions. Alternatively, press the Connect button  in the centre console twice and select **Apps** → **Settings** and follow the instructions.
- Volvo On Call, VOC* - Download the latest version of the VOC app. Choose to create a Volvo ID from the start page, enter e-mail address and follow the instructions.

Related information

- Support and information about the car on the Internet (p. 20)

⁵ The services available may vary over time and vary depending on equipment level and market.



Environmental philosophy

Your Volvo complies with strict international environmental standards and is also manufac-

tured in one of the cleanest and most resource-efficient plants in the world. Volvo Car Corporation is constantly working on the

development of safer and more efficient products and solutions in order to reduce the negative impact on the environment.



Environmental care is one of Volvo Cars' core values, which influence all operations. We also believe that our customers share our consideration for the environment.

Volvo Cars has global ISO certification, which includes the environmental standard ISO 14001 covering all factories and several of our other units. We also set requirements for our partners so that they work systematically with environmental issues.

Fuel consumption

Volvo cars have competitive fuel consumption in each of their respective classes. Lower

fuel consumption generally results in lower emission of the greenhouse gas, carbon dioxide.

It is possible for the driver to influence fuel consumption. For more information, read under the heading "Contributing to a better environment".

Efficient emission control

Your Volvo is manufactured following the concept "Clean inside and out" – a concept that encompasses a clean interior environment as well as highly efficient emission control. In many cases the exhaust emissions are well below the applicable standards.

Clean air in the passenger compartment

A passenger compartment filter prevents dust and pollen from entering the passenger compartment via the air intake.

A sophisticated air quality system Interior Air Quality System* (IAQS) ensures that the incoming air is cleaner than the air in the traffic outside.

The system consists of an electronic sensor and a carbon filter. The incoming air is monitored continuously and if there is an increase in the level of certain unhealthy gases, such

as carbon monoxide, then the air intake is closed. Such a situation may arise in heavy traffic, queues and tunnels for example.

The entry of nitrous oxides, ground-level ozone and hydrocarbons is prevented by the carbon filter.

Interior

The interior of a Volvo is designed to be pleasant and comfortable, even for people with contact allergies and for asthma sufferers. Extreme attention has been given to choosing environmentally-compatible materials.

Volvo workshops and the environment

Regular maintenance creates the conditions for a long service life and low fuel consumption for your car. In this way you contribute to a cleaner environment. When Volvo's workshops are entrusted with the service and maintenance of your car it becomes part of our system. Volvo makes clear demands regarding the way in which our workshops are designed in order to prevent spills and discharges into the environment. Our workshop staff have the knowledge and the tools required to guarantee good environmental care.

Contributing to a better environment

It is easy to contribute to a better environment - here are a few tips:

- Avoid letting the engine idle - switch off the engine when stationary for longer

periods. Pay attention to local regulations.

- Drive economically - think ahead.
- Perform service and maintenance in accordance with the instructions in the owner's manual - follow the Service and Warranty Booklet's recommended intervals.
- If the car is equipped with an engine block heater*, use it before starting from cold - it improves starting capacity and reduces wear in cold weather and the engine reaches normal operating temperature more quickly, which lowers consumption and reduces emissions.
- High speed increases consumption considerably due to increased wind resistance - a doubling of speed increases wind resistance 4 times.
- Always dispose of environmentally hazardous waste, such as batteries and oils, in an environmentally safe manner. Consult a workshop in the event of uncertainty about how this type of waste should be discarded - an authorised Volvo workshop is recommended.

Following this advice can save money, the planet's resources are saved, and the car's durability is extended. For more information and further advice see Eco guide (p. 69), Economical driving (p. 308) and Fuel consumption (p. 425).

Recycling

As a part of Volvo's environmental work, it is important that the car is recycled in an environmentally sound manner. Almost all of the car can be recycled. The last owner of the car is therefore requested to contact a dealer for referral to a certified/approved recycling facility.

Related information

- The owner's manual and the environment (p. 24)

* Option/accessory, for more information, see Introduction.

The owner's manual and the environment

The paper pulp in a printed owner's manual comes from Forest Stewardship Council® certified forests or other controlled sources.

The FSC® symbol shows that the paper pulp in a printed owner's manual comes from FSC® certified forests or other controlled sources.

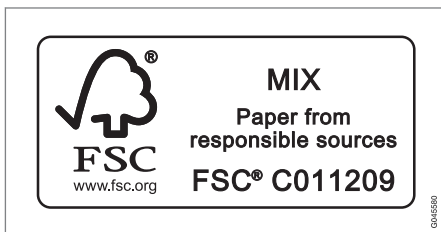

Related information

- Environmental philosophy (p. 22)

Laminated glass



The glass is reinforced which provides better protection against break-ins and improved sound insulation in the passenger compartment. The windscreen and other windows* have laminated glass.

Bi-Fuel* - introduction to vehicle gas

Cars with Bi-Fuel engines can be driven on either vehicle gas or petrol. Vehicle gas can be biogas or natural gas. Vehicle gas is also called CNG (Compressed Natural Gas).

Methane is the main component in vehicle gas. In natural gas, the methane content varies between 85% and 98%. In biogas, the content is almost 100%.

The tanks for vehicle gas are mounted under the floor in the cargo area and do not affect the normal petrol tank.

The system is tested in the same way as for petrol cars. The system is closed which means that leaks are avoided during filling, for example. The gas tanks are protected and are made to withstand a collision. The gas is lighter than air, non-toxic and has a higher ignition temperature than petrol and diesel. The risk of fire or explosions in the event of traffic accidents is therefore lower than with petrol and diesel.

The tank is equipped with a safety valve that allows the gas to evacuate from the tank in the event of abnormally high pressures. This valve ensures that the tank cannot explode.

**! WARNING**

In the event of an accident, the vehicle must be inspected and approved by an authorised Volvo workshop before it may be used again. Always notify the emergency services on site that the vehicle is equipped with a CNG-system.

! WARNING

Smoking and naked flames are prohibited during refuelling, service and repair work. In the event of a possible fire, leave the vehicle immediately and stand a safe distance away.

Do not under any circumstances disassemble or adjust the system or its component parts yourself. Carrying out such acts entails risk of serious personal injury. All service and repair work must therefore, for safety reasons, only be carried out by a trained mechanic - an authorized Volvo workshop is recommended.

! WARNING

If you smell gas in or around the vehicle, switch over to petrol immediately and have the vehicle checked by the nearest trained mechanics.

If the car is placed in a spray/paint curing booth with a drying temperature higher than 60 °C the system pressure must not exceed 50 bar, check that the CNG tank is almost empty for this.

Related information

- Filling vehicle gas* (p. 306)
- Switch for gas operation* (p. 307)
- Inspection and service of the system for vehicle gas* (p. 357)

* Option/accessory, for more information, see Introduction.

02

SAFETY

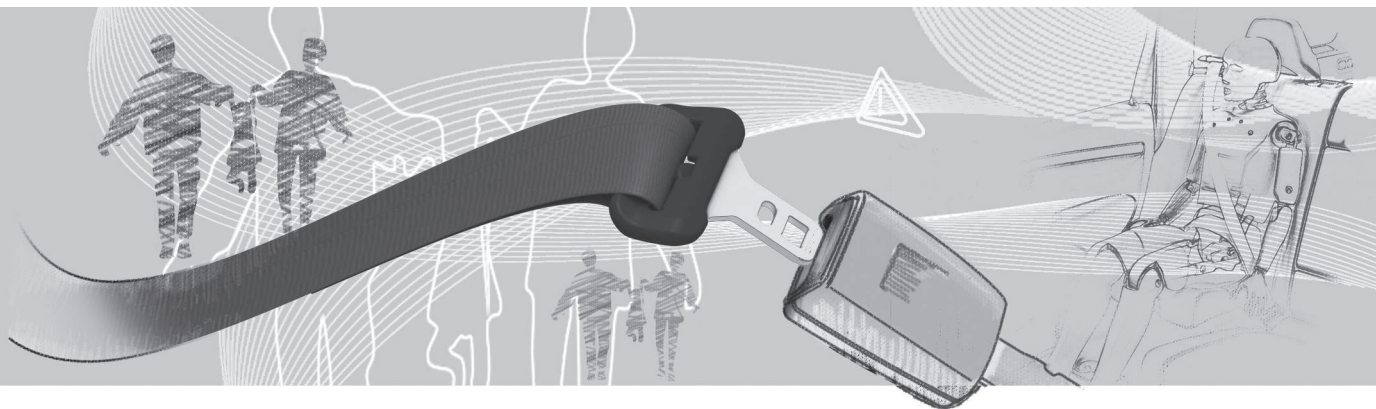



General information on seatbelts

Heavy braking can have serious consequences if the seatbelts are not used. Ensure that all passengers are using their seatbelts during the journey.

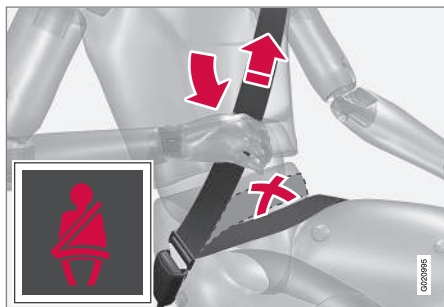

Tension the hip strap over the lap by pulling the diagonal shoulder belt up towards the shoulder. The hip strap must be positioned low down (not over the abdomen).

It is important that the seatbelt lies against the body so it can provide maximum protection. Do not lean the backrest too far back. The seatbelt is designed to protect in a normal seating position.

Unbelted occupants will be reminded to fasten their (p. 28) seatbelt by means of an audio and visual reminder (p. 29).

Remember

- Do not use clips or anything else that can prevent the seatbelt from fitting properly.
- The seatbelt must not be twisted or caught on anything.

WARNING

The seatbelts and airbags interact. If a seatbelt is not used or is used incorrectly, this may diminish the protection provided by the airbag in the event of a collision.

WARNING

Each seatbelt is designed for only one person.

WARNING

Never modify or repair the seatbelts yourself. Volvo recommends that you contact an authorised Volvo workshop.

If a seatbelt has been subjected to a major load, such as in conjunction with a collision, the entire seatbelt must be replaced. Some of the protective characteristics of the seatbelt may have been lost, even if it appears to be undamaged. In addition, replace the seatbelt if the belt is worn or damaged. The new seatbelt must be type-approved and intended for installation in the same position as the replaced seatbelt.

Related information

- Seatbelt - pregnancy (p. 29)
- Seatbelt - loosening (p. 28)
- Seatbelt tensioner (p. 30)



Seatbelt - putting on

Put on the seatbelt (p. 27) before driving starts.

Pull the belt out slowly and secure it by pressing its locking tab into the seatbelt buckle. A loud "click" indicates that the belt has locked.

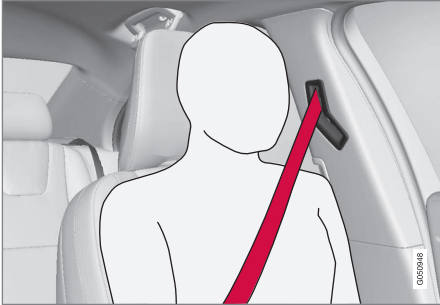

Correctly fitted seatbelt.



Incorrectly fitted seatbelt. The belt must rest on the shoulder.

The buckles only fit the intended lock in the rear seat¹.

Remember

The seatbelt locks and cannot be withdrawn:

- if it is pulled out too quickly
- during braking and acceleration
- if the car leans heavily.

Related information

- Seatbelt - pregnancy (p. 29)
- Seatbelt - loosening (p. 28)
- Seatbelt tensioner (p. 30)
- Seatbelt reminder (p. 29)

Seatbelt - loosening

Loosen the seatbelt (p. 27) when the car is stationary.

Press the red button on the seatbelt buckle and then let the belt retract. If the seatbelt does not retract fully, feed it in by hand so that it does not hang loose.

Related information

- Seatbelt - putting on (p. 28)
- Seatbelt reminder (p. 29)

¹ Certain markets.



Seatbelt - pregnancy

Seatbelt (p. 27) must always be worn during pregnancy. But it is crucial that it be worn in the correct way.



The diagonal section should wrap over the shoulder then be routed between the breasts and to the side of the abdomen.

The lap section should lay flat over the thighs and as low as possible under the abdomen. – It must never be allowed to ride upward. Remove the slack from the seatbelt and ensure that it fits as close to the body as possible. In addition, check that there are no twists in the seatbelt.

As the pregnancy progresses, pregnant drivers must adjust the seat (p. 82) and steering wheel (p. 86) such that they can easily maintain control of the vehicle as they drive (which means that they must be able to easily operate the foot pedals and steering wheel).

The aim should be to position the seat with as large a distance as possible between abdomen and steering wheel.

Related information

- Seatbelt - putting on (p. 28)
- Seatbelt - loosening (p. 28)

Seatbelt reminder

Unbelted occupants will be reminded to fasten their (p. 28) seatbelt by means of an audio and visual reminder.



The audio reminder is speed dependent, and in some cases time dependent. The visual reminder is located in the roof console and in the combined instrument panel (p. 65).

Child seats are not covered by the seatbelt reminder system.

Rear seat

The seatbelt reminder in the rear seat has two subfunctions:

- Provides information on which seatbelts (p. 27) are being used in the rear seat. A message appears in the combined instrument panel when the seatbelts are in use, or if one of the rear doors has been opened. The message is cleared auto-



matically after driving for approximately 30 seconds or after pressing the indicator stalk **OK** button (p. 113).

- Provides a warning if one of the rear seatbelts is unfastened during travel. This warning takes the form of a message in the combined instrument panel along with the audio/visual signal. The warning stops when the seatbelt is re-fastened, or it can also be acknowledged manually by pressing the **OK** button.

The message in the combined instrument panel showing which seatbelts are in use is always shown. Press the **OK** button to see stored messages.

Certain markets

An acoustic signal and indicator lamp remind the driver and front seat passenger to use a seatbelt if either of them is not wearing one. At low speed, the audio reminder will sound for the first 6 seconds.

Seatbelt tensioner

All the seatbelts (p. 27) are equipped with belt tensioners. A mechanism in the seatbelt tensioner tightens the seatbelt in the event of a sufficiently violent collision. The seatbelt then provides more effective restraint for the occupants.

WARNING

Never insert the tongue of the passenger's seatbelt into the buckle on the driver's side. Always insert the tongue of the seatbelt into the buckle on the correct side. Do not make any damages on seatbelts nor insert any foreign objects into a buckle. The seatbelts and buckles would then possibly not function as intended in the event of a collision. There is a risk of serious injury.

Safety - warning symbol

The warning symbol is shown if a fault is detected during fault tracing or if a system has been activated. Where required, the warning symbol is shown together with a message in the combined instrument panel (p. 65) information display.

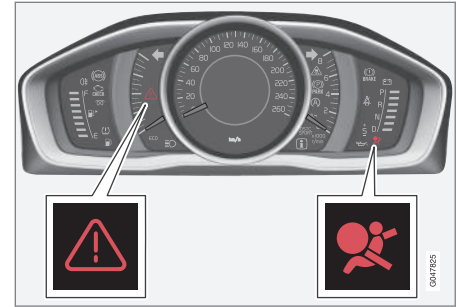

Warning triangle and warning symbol for the air-bag system (p. 31) in the analogue combined instrument panel.

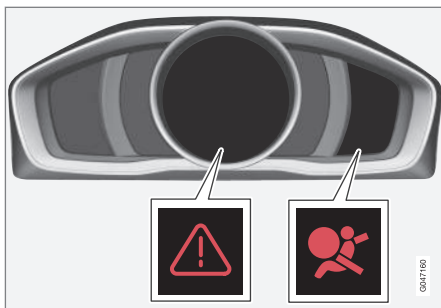

Warning triangle and warning symbol for the airbag system in the digital combined instrument panel.

The warning symbol in the combined instrument panel illuminates when the remote control key is in key position II (p. 81). The symbol clears after approx. 6 seconds provided the airbag system is fault-free.

WARNING

If the warning symbol for the airbag system remains illuminated or illuminates while driving, it means that the airbag system does not have full functionality. The symbol indicates a fault in the seatbelt tensioner system, SIPS, the IC system or some other fault in the system. Volvo recommends that you contact an authorised Volvo workshop immediately.

If the warning symbol malfunctions, the warning triangle illuminates and **SRS airbag**

Service required or SRS airbag Service urgent appears in the display. Volvo recommends that you contact an authorised Volvo workshop immediately.

Related information

- General information on safety mode (p. 41)

Airbag system

In the event of a frontal collision the airbag system helps to protect the head, face and chest of the driver and passenger.

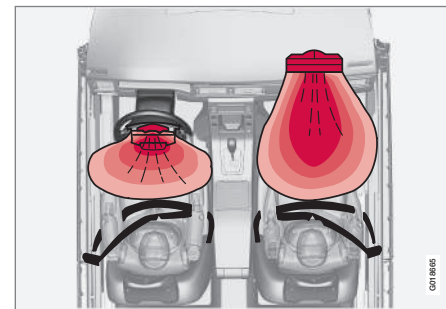

Airbag system viewed from above, left-hand drive car.

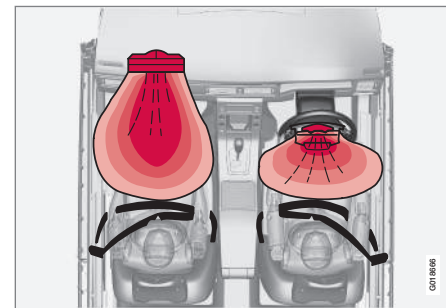

Airbag system viewed from above, right-hand drive car.



The system consists of airbags and sensors. A sufficiently violent collision trips the sensors and the airbag(s) are inflated and become hot. The airbag cushions the initial collision impact for the occupant. The airbag deflates when compressed by the collision. When this occurs, smoke escapes into the car. This is completely normal. The entire process, including inflation and deflation of the airbag, occurs within tenths of a second.

WARNING

Volvo recommends that you contact an authorised Volvo workshop for repair. Defective work in the airbag system could cause malfunction and result in serious personal injury.

NOTE

The detectors react differently depending on the nature of the collision and whether or not the seatbelts are fastened. Applies to all belt positions.

It is therefore possible that only one (or none) of the airbags may inflate in a collision. The detectors sense the force of the collision on the vehicle and the action is adapted accordingly so that one or more airbags are deployed.

Related information

- Driver airbag (p. 32)
- Passenger airbag (p. 33)

- Safety - warning symbol (p. 30)

Driver airbag

To supplement the protection afforded by the seatbelt (p. 27) the car is equipped on the driver's side with an airbag (p. 31).

This airbag is fitted into the centre of the steering wheel. The steering wheel is marked **AIRBAG**.

WARNING

The seatbelts and airbags interact. If the belt is not used or is used incorrectly, this may diminish the protection provided by the airbag in the event of a collision.

Related information

- Passenger airbag (p. 33)



Passenger airbag

To supplement the protection afforded by the seatbelt (p. 27) on the passenger side, the car is equipped with an airbag (p. 31).

The airbag is folded up into a compartment above the glovebox. Its cover panel is marked **AIRBAG**.



Location of the front passenger airbag in a left-hand drive car.



Location of the front passenger airbag in a right-hand drive car.

The warning label for the passenger airbag is fitted in one of the following two locations in the car:



Alternative 1: Position of airbag label on passenger side sun visor.

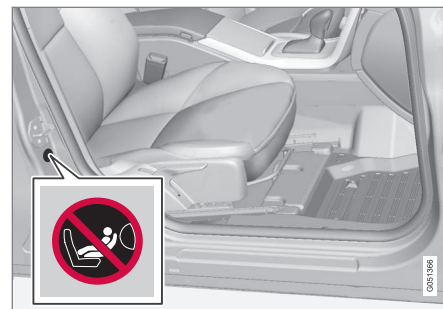

Alternative 2: Position of airbag label on passenger side door pillar. The label becomes visible when the passenger door is opened.

WARNING

Never use a rear-facing child seat on a seat protected by an activated airbag. Failure to follow this advice can lead to death or serious injury to the child.

WARNING

The seatbelts and airbags interact. If the belt is not used or is used incorrectly, this may diminish the protection provided by the airbag in the event of a collision.

To minimise the risk of injury if the airbag deploys, passengers must sit as upright as possible with their feet on the floor and backs against the backrest. Seatbelts must be secured.



! WARNING

Do not put objects in front of or above the dashboard where the passenger airbag is located.

! WARNING

Never place a child in a child seat or on a booster cushion in the front seat if the airbag is activated.

Never allow anybody to stand or sit in front of the front passenger seat.

No one shorter than 140 cm should ever sit in the front passenger seat if the airbag is activated.

Failure to follow the advice given above can endanger life.

Switch - PACOS*

The front passenger airbag can be deactivated (p. 34) if the car is equipped with a switch, PACOS (Passenger Airbag Cut Off Switch).

! WARNING

If the car is equipped with a front passenger airbag, but does not have a PACOS switch (Passenger Airbag Cut Off Switch), then the airbag will always be activated.

Related information

- Driver airbag (p. 32)
- Child seats (p. 44)

Passenger airbag - activating/deactivating*

Front passenger airbag (p. 33) can be deactivated if the car is equipped with a switch, PACOS (Passenger Airbag Cut Off Switch).

Switch - PACOS

The switch for the passenger airbag (PACOS) is located on the passenger end of the instrument panel and is accessible when the passenger door is open.

Check that the switch is in the required position. The remote control key's key blade (p. 174) should be used to change position.

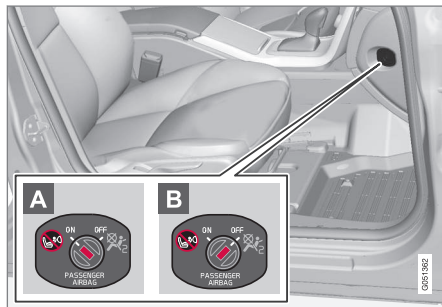

Location of airbag switch.

- A** The airbag is activated. With the switch in this position, persons taller than 140 cm can sit in the front passenger seat, but

never children in a child seat or on a booster cushion.

- B** The airbag is deactivated. With the switch in this position, children in a child seat or on a booster cushion can sit in the front passenger seat, but never persons taller than 140 cm.

! WARNING

Activated airbag (passenger seat):

Never place a child in a child seat or on a booster cushion on the front passenger seat when the airbag is activated. This applies to everyone shorter than 140 cm.

Deactivated airbag (passenger seat):

No one taller than 140 cm should ever sit in the front passenger seat when the airbag is deactivated.

Failure to follow the advice given above can endanger life.

i NOTE

When the remote control key is in key position **II** (p. 81) the warning symbol (p. 30) for the airbag is shown in the combined instrument panel for approx. 6 seconds.

Following which, the indicator in the roof console is illuminated showing the correct status for the front passenger seat airbag.



Indicator showing that the passenger airbag is activated.

A warning symbol in the roof console indicates that the airbag for the front passenger seat is activated (see preceding illustration).

WARNING

Never place a child in a child seat or on a booster cushion in the front seat if the airbag is activated and the symbol  in the roof console is illuminated. Failure to follow this advice could endanger the life of the child.



Indicator showing that the passenger airbag is deactivated.

A text message and a symbol in the roof console indicate that the airbag for the front passenger seat is deactivated (see preceding illustration).

WARNING

Do not allow anyone to sit in the front passenger seat if the message in the roof console indicates that the airbag is deactivated, and if the warning symbol (p. 30) for the airbag system is also displayed on the combined instrument panel. This indicates that there has been a severe malfunction. Visit a workshop as soon as possible. Volvo recommends that you contact an authorised Volvo workshop.

WARNING

Failure to follow the advice given above can endanger the lives of passengers in the car.

Related information

- Child seats (p. 44)



Side airbag (SIPS)

In a side impact collision a large proportion of the collision force is transferred by the SIPS (Side Impact Protection System) to beams, pillars, the floor, the roof and other structural parts of the body. The side airbags at the driver's and front passenger seats protect the chest area and the hip and are an important part of the SIPS.



The SIPS bag system consists of two main components, side airbag and sensors. The side airbags are located in the front seat's backrests.

A sufficiently violent collision trips the sensors and the side airbags are inflated. The airbag inflates between the occupant and the door panel and thereby cushions the initial impact. The airbag deflates when compressed by the collision. The side airbag is normally only deployed on the side of the collision.

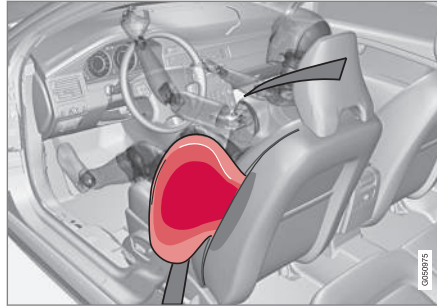

Driver's seat, left-hand drive.

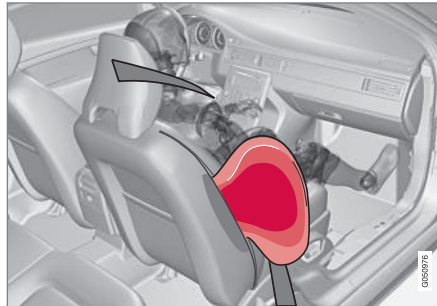

Front passenger seat, left-hand drive.

WARNING

- Volvo recommends that repairs are only carried out by an authorised Volvo workshop. Defective work in the SIPS-bag system could cause malfunction and result in serious personal injury.
- Do not put objects in the area between the outside of the seat and the door panel, since this area is required by the side airbag.
- Volvo recommends the use only of car seat covers approved by Volvo. Other seat covers may impede the operation of the side airbags.
- Side airbags are a supplement the seatbelts. Always use a seatbelt.

Related information

- Driver airbag (p. 32)
- Passenger airbag (p. 33)
- Side airbag (SIPS) - child seat/booster cushion (p. 37)
- Inflatable Curtain (IC) (p. 37)



Side airbag (SIPS) - child seat/booster cushion

The protection provided by the car to children seated in a child seat or on a booster cushion is not diminished by the side airbag (p. 36).

Child seat/booster cushion (p. 44) can be placed on the front passenger seat provided that the car does not have an activated airbag (p. 34) on the front passenger side.

Related information

- Passenger airbag (p. 33)
- General information on child safety (p. 43)

Inflatable Curtain (IC)

The inflatable curtain helps to prevent the driver and passengers from striking their heads on the inside of the car during a collision.

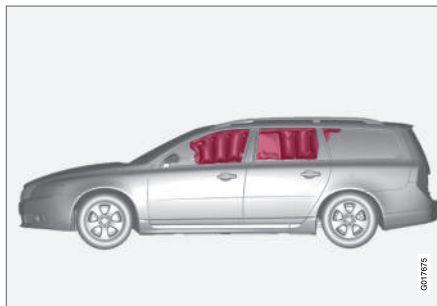

Inflatable curtain IC (Inflatable Curtain) is part of the SIPS system (p. 36) and the airbag system (p. 31). It is fitted along both sides of the headlining and helps protect the driver and passengers in the car's outer seats. A sufficiently violent collision trips the sensors and the inflatable curtain is inflated.

WARNING

Never hang or attach heavy items onto the handles in the roof. The hook is only designed for light clothing (not for solid objects such as umbrellas for example).

Do not screw or install anything onto the car's headlining, door pillars or side panels. This could compromise the intended protection. Volvo recommends that you only ever use Volvo genuine parts that are approved for placement in these areas.

WARNING

Do not load the car higher than 50 mm under the top edge of the windows in the doors. Otherwise, the intended protection of the inflatable curtain, which is concealed in the headlining, may be compromised.

WARNING

The inflatable curtain is a supplement to the seatbelts. Always use a seatbelt.

Related information

- General information on seatbelts (p. 27)



General information on WHIPS (whiplash protection)

WHIPS (Whiplash Protection System) is a protection against whiplash injuries. The system consists of energy absorbing backrests and specially designed head restraints in the front seats.

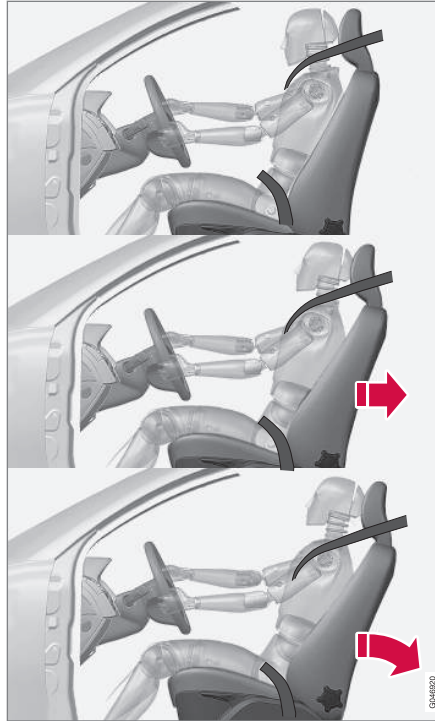

The WHIPS system is actuated by a rear-end collision, where the angle and speed of the collision, and the nature of the colliding vehicle all have an influence.

WARNING

The WHIPS system is a supplement to the seatbelts. Always use a seatbelt.

Seat properties

When the WHIPS system is deployed, the front seat backrests are lowered backward to change the seating position of the driver and front seat passenger. This reduces the risk of whiplash injury.

WARNING

Never modify or repair the seat or WHIPS system yourself. Volvo recommends that you contact an authorised Volvo workshop.

Related information

- WHIPS - child seats (p. 39)
- WHIPS - seating position (p. 39)
- General information on seatbelts (p. 27)



WHIPS - child seats

The protection provided by the car to children seated in a child seat or on a booster cushion is not diminished by the WHIPS system (p. 38).

Child seat/booster cushion (p. 44) can be placed on the front passenger seat provided that the car does not have an activated airbag (p. 34) on the front passenger side.

Related information

- General information on child safety (p. 43)

WHIPS - seating position

For optimum protection from the WHIPS system (p. 38) the driver and passenger must have the correct seating position and make sure that the system's function is not obstructed.

Seating position

Set the correct seating position in the front seat (p. 82) before driving starts.

Driver and front seat passenger should sit in the centre of the seat with as little space as possible between the head and the head restraint.

Function

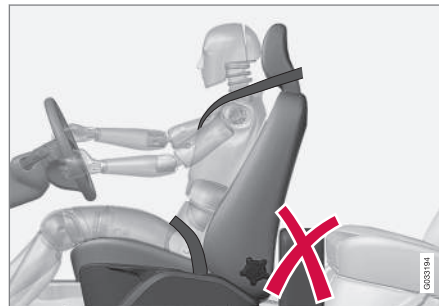

Do not leave any objects on the floor behind the driver's seat/passenger seat that may prevent the WHIPS system from functioning.

WARNING

Do not squeeze rigid objects between the rear seat cushion and the front seat's backrest. Make sure you do not to obstruct the function of the WHIPS system.



Do not place objects on the rear seat that may prevent the WHIPS system from functioning.

WARNING

If a rear seat backrest is folded down, the corresponding front seat must be moved forward so that it does not make contact with the folded backrest.



WARNING

If a seat has been subjected to extreme forces, such as due to a rear-end collision, the WHIPS system must be checked. Volvo recommends that it is checked by an authorised Volvo workshop.

Part of the WHIPS system's protective capacity may have been lost even if the seat appears to be undamaged.

Volvo recommends that you contact an authorised Volvo workshop to have the system checked even after a minor rear-end collision.

When the systems deploy

In the event of a collision Volvo's different personal safety systems work together in order to minimise injury.

System	Triggered
Seatbelt tensioner (p. 30) front seat	In the event of a frontal collision, and/or side-impact collision, and/or rear-end collision and/or overturning
Seatbelt tensioner, rear seat	In a frontal collision and/or side-impact accident and/or overturning
Airbags (Steering wheel (p. 32) and passenger airbag (p. 33))	In a frontal collision ^A
Side airbags (SIPS) (p. 36)	In a side-impact accident ^A

System	Triggered
Inflatable Curtain IC (p. 37)	In the event of a side-impact collision and/or certain frontal collisions ^A
Whiplash protection WHIPS (p. 38)	In a rear-end collision

^A The bodywork of the car could be greatly deformed in a collision without airbag deployment. A number of factors such as the rigidity and weight of the object hit, the speed of the car, the angle of the collision etc. affects how the different safety systems of the car are activated.

If the airbags (p. 31) have deployed, the following is recommended:

- Recovering the car. Volvo recommends that you have it conveyed to an authorised Volvo workshop. Do not drive with deployed airbags.
- Volvo recommends that you engage an authorised Volvo workshop to handle the replacement of components in the car's safety systems.
- Always contact a doctor.

NOTE

The airbags and belt tensioner system are deployed only once during a collision.



! WARNING

The airbag system's control module is located in the centre console. If the centre console is drenched with water or other liquid, disconnect the battery cables. Do not attempt to start the car since the airbags may deploy. Recovering the car. Volvo recommends that you have it conveyed to an authorised Volvo workshop.

! WARNING

Never drive with deployed airbags. They can make steering difficult. Other safety systems may also be damaged. The smoke and dust created when the airbags are deployed can cause skin and eye irritation/injury after intensive exposure. In case of irritation, wash with cold water. The rapid deployment sequence and airbag fabric may cause friction and skin burns.

General information on safety mode

Safety mode is a protective state that is enforced when the collision may have damaged any of the car's vital functions, such as the fuel lines, sensors for one of the safety systems, or the brake system.

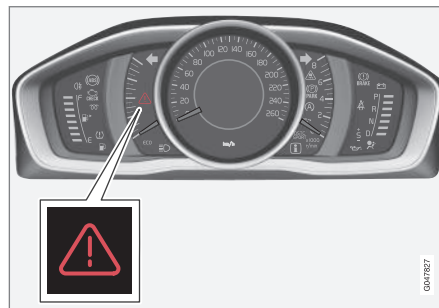

Warning triangle in the analogue combined instrument panel.

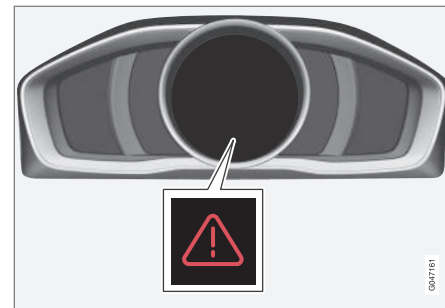

Warning triangle in the digital combined instrument panel.

If the car is involved in a collision, the text **Safety mode See manual** may appear in the combined instrument panel (p. 65) information display. This means that the car has reduced functionality.

! WARNING

Never attempt to repair your car or reset the electronics yourself if the car has been in safety mode. This could result in personal injury or the car not functioning as normal. Volvo recommends that you engage an authorised Volvo workshop to check and restore the car to normal status after **Safety mode See manual** has been displayed.



Related information

- Safety mode - attempting to start the car (p. 42)
- Safety mode - moving the car (p. 43)

Safety mode - attempting to start the car

If the car is set in safety mode (p. 41) then an attempt to start the car can be made if everything seems normal and the absence of fuel leakage has been checked.

First, check that no fuel is leaking from the car. There must be no smell of fuel either.

If everything seems normal and you have checked for indications of fuel leakage, you may attempt to start the car.

Remove the remote control key and open the driver's door. If a message is now shown to the effect that the ignition is on, press the start button. Then close the door and reinsert the remote control key. The car's electronics will now try to reset themselves to normal mode. Then try to start the car.

If the message **Safety mode See manual** is still shown on the display then the car must not be driven or towed but a vehicle recovery service (p. 318) used instead. Even if the car appears to be driveable, hidden damage may make the car impossible to control once moving.



WARNING

Never, under any circumstances, attempt to restart the car if it smells of fuel when the **Safety mode See manual** message is displayed. Leave the car at once.



WARNING

If the car is in safety mode it must not be towed. It must be transported from its location. Volvo recommends that it is transported to an authorised Volvo workshop.

Related information

- Safety mode - moving the car (p. 43)



Safety mode - moving the car

If **Normal mode** is shown after **Safety mode** **See manual** has been reset after attempting to start the car (p. 42), the car can be moved carefully out of a dangerous position.

Do not move the car further than necessary.

Related information

- General information on safety mode (p. 41)

General information on child safety

Children of all ages and sizes must always sit correctly secured in the car. Never allow a child to sit on the knee of a passenger.

Volvo recommends that children travel in rear-facing child seats until as late an age as possible, at least until 3-4 years of age, and then front-facing booster cushions/child seats until up to 10 years of age.

The position of a child in the car and the choice of equipment are dictated by the child's weight and size; see Child seats (p. 44).

NOTE

Regulations regarding the placement of children in cars vary from country to country. Check what does apply.

Volvo has child safety equipment (child seats, booster cushions & attachment devices) which is designed for your particular car. Using Volvo's child safety equipment provides you with optimum conditions for your child to travel safely in the car. Furthermore, the child safety equipment fits and is easy to use.

NOTE

In the event of questions when fitting child safety products, contact the manufacturer for clearer instructions.

Child safety locks

The rear doors and rear door windows* can be blocked manually (p. 188) or electronically (p. 189)* from opening from the inside.

Related information

- Child seats - location (p. 49)
- Child seat - ISOFIX (p. 53)
- Child seats - upper mounting points (p. 57)



Child seats

Children should sit comfortably and safely. Make sure that the child seat is being used correctly.



Child seats and airbags are not compatible.



NOTE

When using child safety products it is important to read the installation instructions included.



WARNING

Do not secure the straps of the child seat to the seat's horizontal adjustment bar, springs or the rails and beams under the seat. Sharp edges may damage the straps.

Look in the installation instructions for the child seat for the correct fitting.



Recommended child seats²

Weight	Front seat (with deactivated air-bag)	Outer rear seat	Centre rear seat
Group 0 max 10 kg Group 0+ max 13 kg		Volvo infant seat (Volvo Infant Seat) - rear-facing child seat, secured with the ISOFIX fixture system. Type approval: E1 04301146 (L)	
Group 0 max 10 kg Group 0+ max 13 kg	Volvo infant seat (Volvo Infant Seat) - rear-facing child seat, secured with the car's seatbelt. Type approval: E1 04301146 (U)	Volvo infant seat (Volvo Infant Seat) - rear-facing child seat, secured with the car's seatbelt. Type approval: E1 04301146 (U)	Volvo infant seat (Volvo Infant Seat) - rear-facing child seat, secured with the car's seatbelt. Type approval: E1 04301146 (U)
Group 0 max 10 kg Group 0+ max 13 kg	Rear-facing child seat (Child Seat) - rear-facing child seat, secured with the car's seatbelt and straps. Type approval: E5 03135 (L)	Rear-facing child seat (Child Seat) - rear-facing child seat, secured with the car's seatbelt and straps. Type approval: E5 03135 (L)	Rear-facing child seat (Child Seat) - rear-facing child seat, secured with the car's seatbelt and straps. Type approval: E5 03135 (L)
Group 0 max 10 kg Group 0+ max 13 kg	Child seats which are universally approved. (U)	Child seats which are universally approved. (U)	Child seats which are universally approved. (U)

² With regard to other child seats your car should be included in the manufacturer's enclosed list of vehicles or be universally approved in accordance with the ECE R44 legal requirement.



02 Safety

◀◀

02

Weight	Front seat (with deactivated air-bag)	Outer rear seat	Centre rear seat
Group 1 9-18 kg	Volvo rear-facing/turnable child seat (Volvo Convertible Child Seat) - rear-facing child seat, secured with the car's seatbelt and straps. Type approval: E5 04192 (L)	Volvo rear-facing/turnable child seat (Volvo Convertible Child Seat) - rear-facing child seat, secured with the car's seatbelt and straps. Type approval: E5 04192 (L)	
Group 1 9-18 kg	Rear-facing child seat (Child Seat) - rear-facing child seat, secured with the car's seatbelt and straps. Type approval: E5 03135 (L)	Rear-facing child seat (Child Seat) - rear-facing child seat, secured with the car's seatbelt and straps. Type approval: E5 03135 (L)	Rear-facing child seat (Child Seat) - rear-facing child seat, secured with the car's seatbelt and straps. Type approval: E5 03135 (L)
Group 1 9-18 kg		Britax Fixway – rear-facing child seat, secured with the ISOFIX fixture system and straps. Type approval: E5 03171 (L)	
Group 1 9-18 kg	Child seats which are universally approved. (U)	Child seats which are universally approved. (U)	Child seats which are universally approved. (U)



Weight	Front seat (with deactivated air-bag)	Outer rear seat	Centre rear seat
Group 2 15-25 kg	Volvo rear-facing/turnable child seat (Volvo Convertible Child Seat) - rear-facing child seat, secured with the car's seatbelt and straps. Type approval: E5 04192 (L)	Volvo rear-facing/turnable child seat (Volvo Convertible Child Seat) - rear-facing child seat, secured with the car's seatbelt and straps. Type approval: E5 04192 (L)	Volvo rear-facing/turnable child seat (Volvo Convertible Child Seat) - rear-facing child seat, secured with the car's seatbelt and straps. Type approval: E5 04192 (L)
Group 2 15-25 kg	Volvo rear-facing/turnable child seat (Volvo Convertible Child Seat) - front-facing child seat, secured with the car's seatbelt. Type approval: E5 04191 (U)	Volvo rear-facing/turnable child seat (Volvo Convertible Child Seat) - front-facing child seat, secured with the car's seatbelt. Type approval: E5 04191 (U)	
Group 2/3 15-36 kg	Volvo booster seat with backrest (Volvo Booster Seat with backrest). Type approval: E1 04301169 (UF)	Volvo booster seat with backrest (Volvo Booster Seat with backrest). Type approval: E1 04301169 (UF)	Volvo booster seat with backrest (Volvo Booster Seat with backrest). Type approval: E1 04301169 (UF)
Group 2/3 15-36 kg	Booster cushion with and without backrest (Booster Cushion with and without backrest). Type approval: E5 04216 (UF)	Booster cushion with and without backrest (Booster Cushion with and without backrest). Type approval: E5 04216 (UF)	Booster cushion with and without backrest (Booster Cushion with and without backrest). Type approval: E5 04216 (UF)



Weight	Front seat (with deactivated air-bag)	Outer rear seat	Centre rear seat
Group 2/3 15-36 kg		Integrated booster cushion (Integrated Booster Cushion) - available as a factory fitted option. Type approval: E5 04189 (B)	

L: Suitable for specific child seats. These child seats may be intended for use in a special car model, limited or semi-universal categories.

U: Suitable for universally approved child seats in this weight class.

UF: Suitable for front-facing universally approved child seats in this weight class.

B: Built-in child seats approved for this weight class.

Related information

- Child seats - location (p. 49)
- Child seats - upper mounting points (p. 57)
- Child seat - ISOFIX (p. 53)
- General information on child safety (p. 43)



Child seats - location

Always fit child seats/booster cushions (p. 44) in the rear seat if the passenger airbag is activated (p. 34). If a child is sitting on the front passenger seat then he/she could suffer serious injury if the airbag deploys.

The warning label for the passenger airbag is fitted in one of the following two locations in the car:



Alternative 1: Position of airbag label on passenger side sun visor.

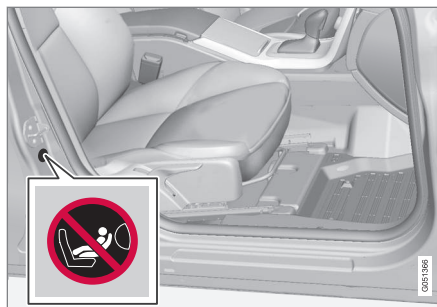

Alternative 2: Position of airbag label on passenger side door pillar. The label becomes visible when the passenger door is opened.

You may place:

- a child seat/booster cushion on the front passenger seat provided there is no activated airbag on the front passenger side.
- one or more child seats/booster cushions in the rear seat.

WARNING

Never use a rear-facing child seat on a seat protected by an activated airbag. Failure to follow this advice can lead to death or serious injury to the child.

WARNING

Never place a child in a child seat or on a booster cushion in the front seat if the airbag is activated.

Never allow anybody to stand or sit in front of the front passenger seat.

No one shorter than 140 cm should ever sit in the front passenger seat if the airbag is activated.

Failure to follow the advice given above can endanger life.

WARNING

Booster cushions/child seats with steel braces or some other design that could rest on the seatbelt buckle's opening button must not be used, as they could cause the seatbelt buckle to open accidentally.

Do not allow the upper section of the child seat to rest against the windscreen.

Related information

- General information on child safety (p. 43)
- Child seats - upper mounting points (p. 57)
- Child seat - ISOFIX (p. 53)



Child seat - two-stage booster seat*

The integrated booster seats in the rear seat allow children to sit comfortably and safely.

The booster cushions are specially designed to provide optimum safety. In combination with the seatbelt (p. 27) they are approved for children who weigh between 15 and 36 kg and who are at least 95 cm in height.



Correct position, the seatbelt is positioned above the shoulder.



Incorrect position, the head must not be positioned above the head restraint and the seatbelt must not be below the shoulder.

Check before driving that:

- the integrated two-stage booster seat is correctly set in accordance with the table (p. 51) and in locked position
- the seatbelt is in contact with the child's body and is not slack or twisted
- the seatbelt does not lie across the child's throat or below the shoulder (see preceding illustrations)
- the lap section of the seatbelt is positioned low over the pelvis to provide optimal protection.

Adjusting the booster seat's two levels is performed by raising (p. 51) and lowering (p. 52).

WARNING

Volvo recommends that repair or replacement is only carried out by an authorised Volvo workshop. Do not make any modifications or additions to the booster cushion. If an integrated booster cushion has been subjected to a major load, such as in conjunction with a collision, the entire booster cushion must be replaced. Even if the booster cushion appears to be undamaged, it may not afford the same level of protection. The booster cushion must also be replaced if it is heavily worn.

WARNING

If the instructions for the two-stage booster seat are not followed then the child could sustain serious injury in the event of an accident.



Two-stage booster seat* - raising

The integrated booster seat (p. 50) in the rear seat can be folded up into two stages. How many stages the cushion should be folded up depends on the child's weight.

	Stage 1	Stage 2
Weight	22-36 kg	15-25 kg

Stage 1³



- 1 Pull the handle forward and up in order to release the booster cushion.

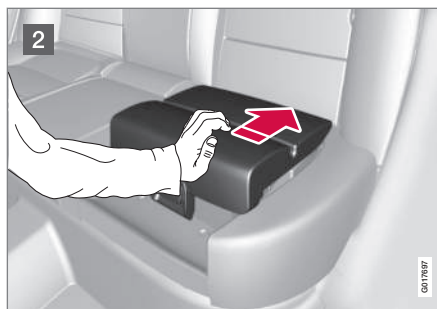

- 2 Press the booster cushion backwards to lock.

Stage 2⁴



- 1 Start from the lower stage. Press the button.

³ Lower stage.

⁴ Upper stage.

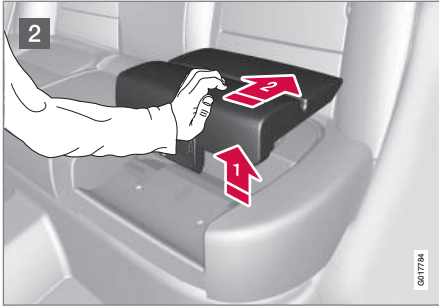

- 2 Lift the booster cushion up at the front edge and press it back against the backrest to lock.

NOTE

It is not possible to adjust the booster seat from stage 2 to stage 1. It must first be reset by being fully folded down (p. 52) into the seat cushion.

Related information

- Two-stage booster seat* - lowering (p. 52)

Two-stage booster seat* - lowering

The integrated booster seat (p. 50) in the rear seat can be folded down from the upper or lower stage to fully lowered position in the seat cushion. However, it is not possible to adjust the booster cushion from the upper stage to the lower stage.

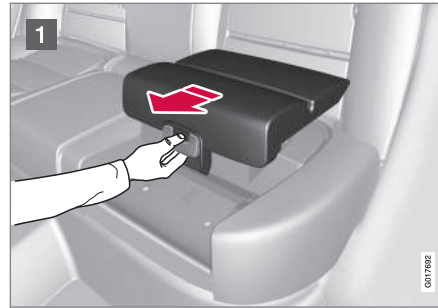

- 1 Pull the handle forwards to release the cushion.



- 2 Press down with your hand in the centre of the cushion in order to lock it.

IMPORTANT

Check that there are no loose objects (e.g. toys) left behind in the space under the cushion before lowering.

NOTE

Before the rear backrest is lowered, the booster cushion must be lowered first.

Related information

- Two-stage booster seat* - raising (p. 51)



Child seat - ISOFIX

ISOFIX is a fixture system for car child seats (p. 44) that is based on an international standard.

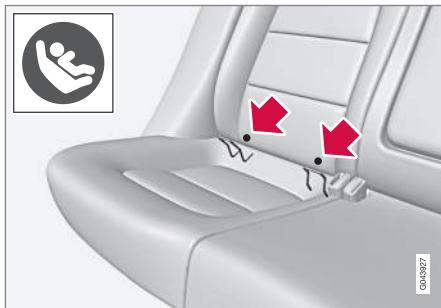

Mounting points for the ISOFIX fixture system are concealed behind the lower section of the rear seat backrest, in the outer seats.

The location of the mounting points is indicated by symbols in the backrest upholstery (see preceding illustration).

Press the seat cushion down to access the mounting points.

Always follow the manufacturer's installation instructions when connecting a child seat to the ISOFIX mounting points.

Related information

- ISOFIX - size classes (p. 53)
- ISOFIX - types of child seat (p. 55)

- General information on child safety (p. 43)

ISOFIX - size classes

There is a size classification for child seats using the ISOFIX (p. 53) fixture system in order to assist users in choosing the correct type of child seat (p. 55).

Size class	Description
A	Full size, front-facing child seat
B	Reduced size (alt. 1), front-facing child seat
B1	Reduced size (alt.2), front-facing child seat
C	Full size, rear-facing child seat
D	Reduced size, rear-facing child seat
E	Rear-facing infant seat
F	Transverse infant seat, left-hand
G	Transverse infant seat, right-hand



WARNING

Never place the child in the passenger seat if the car is fitted with an activated air-bag.

NOTE

If an ISOFIX child seat has no size classification, the car model must be included on the vehicle list for the child seat.

NOTE

Volvo recommends that you contact an authorised Volvo dealer for recommendations about which ISOFIX child seats Volvo recommends.



ISOFIX - types of child seat

Child seats are in different sizes – cars are in different sizes. This means that not all child

seats are suitable for all seats in all car models.

Type of child seat	Weight	Size class	Passenger seats for ISOFIX installation of child seats	
			Front seat	Outer rear seat
Infant seat transverse	max 10 kg	F	X	X
		G	X	X
Infant seat, rear-facing	max 10 kg	E	X	OK (IL)
Infant seat, rear-facing	max 13 kg	E	X	OK (IL)
		D	X	OK (IL)
		C	X	OK (IL)
Child seat, rear-facing	9-18 kg	D	X	OK (IL)
		C	X	OK (IL)



Type of child seat	Weight	Size class	Passenger seats for ISOFIX installation of child seats	
			Front seat	Outer rear seat
Front-facing child seat	9-18 kg	B	X	OK ^A (IUL)
		B1	X	OK ^A (IUL)
		A	X	OK ^A (IUL)

X: The ISOFIX position is not suitable for ISOFIX child seats in this weight class and/or size class.

IL: Suitable for specific ISOFIX child seats. These child seats may be intended for a particular car model, limited or semi-universal categories.

IUF: Suitable for front-facing ISOFIX child seats that are universally approved in this weight class.

^A Volvo recommends rear-facing child seats for this group.

Make sure you select the right size class (p. 53) of child seat with ISOFIX (p. 53) fixture system.



Child seats - upper mounting points

The car is equipped with upper mounting points for certain front-facing child seats (p. 44). These mounting points are located on the rear of the seat.

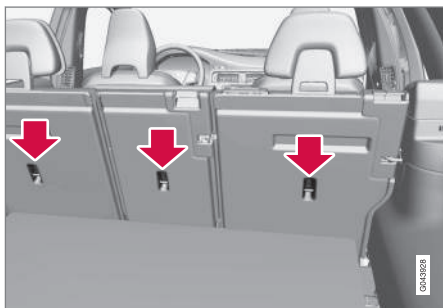

The upper mounting points are primarily intended for use with front-facing child seats. Volvo recommends that small children should sit in rear-facing child seats to as late an age as possible.

i NOTE

Fold the head restraints in order to facilitate fitting this type of child seat in cars with folding head restraints on the outer seats.

i NOTE

In cars with a cargo cover over the luggage compartment, this must be removed before child seats can be attached to the securing points.

For detailed information on how the child seat should be tensioned in the upper mounting points, see the seat manufacturer's instructions.

! WARNING

The child seat's straps must always be drawn through the hole in the head restraint leg before they are tensioned at the attachment point.

Related information

- General information on child safety (p. 43)
- Child seats - location (p. 49)
- Child seat - ISOFIX (p. 53)

03



INSTRUMENTS AND CONTROLS

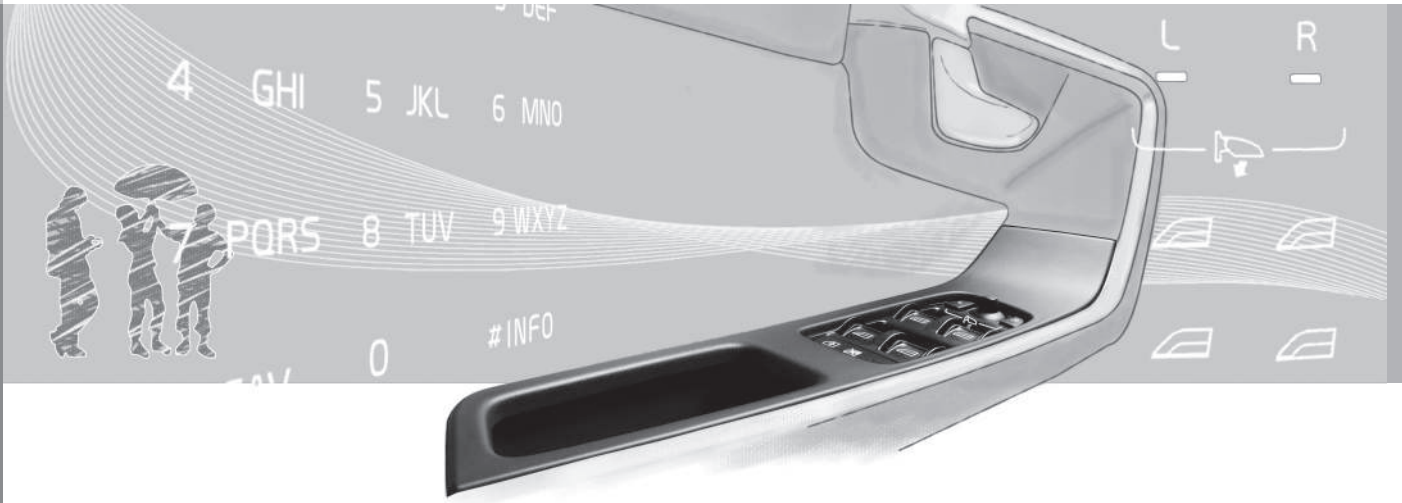



Instruments and controls, left-hand drive car - overview

The overview shows where the car's displays and controls are located.

03



03 Instruments and controls



Overview, left-hand drive cars

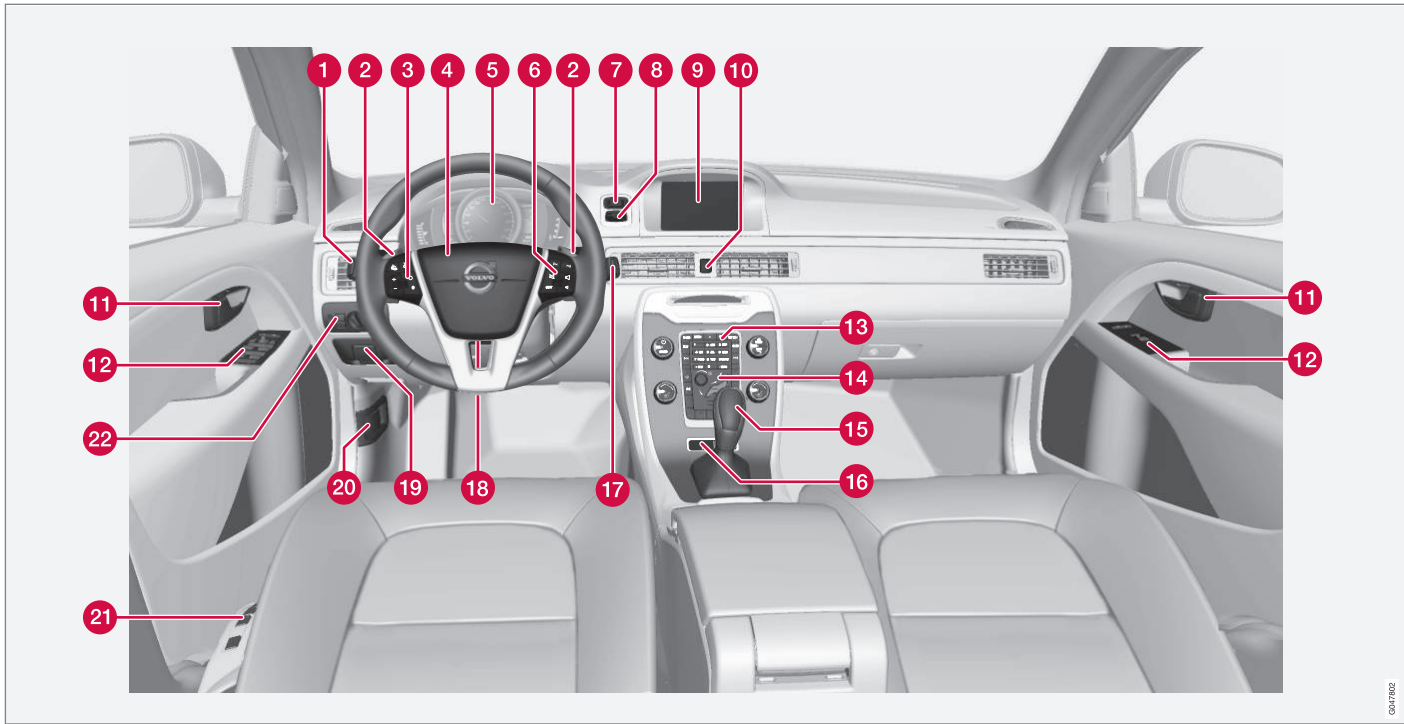

0411102

03



	Function	See
1	Menus and messages, direction indicators, main/dipped beam, trip computer	(p. 113), (p. 116), (p. 97), (p. 92) and (p. 127).
2	Manual gear changing in an automatic gearbox*	(p. 273).
3	Cruise control*	(p. 203) and (p. 205).
4	Horn, airbags	(p. 86) and (p. 31).
5	Combined instrument panel	(p. 65).
6	Menu navigation, audio control, phone control*	(p. 116) and the Sensus Infotainment supplement.
7	START/STOP ENGINE button	(p. 265).
8	Ignition switch	(p. 80).
9	Screen for infotainment system and display of menus	(p. 116) and the Sensus Infotainment supplement.

	Function	See
10	Hazard warning flashers	(p. 96).
11	Door handle	-
12	Control panel	(p. 183), (p. 189), (p. 106) and (p. 108).
13	Control panel for infotainment system and menu navigation	(p. 116) and the Sensus Infotainment supplement.
14	Control panel for climate control	(p. 136).
15	Gear selector	(p. 271), (p. 273) or (p. 276).
16	Controls for active chassis (Four-C)*	(p. 195).
17	Wipers and washing	(p. 104).
18	Steering wheel adjustment	(p. 86).
19	Parking brake	(p. 295).
20	Bonnet opener	(p. 360).

	Function	See
21	Seat adjustment*	(p. 83).
22	Headlamp control, opener for fuel filler flap and tailgate	(p. 88), (p. 302) and (p. 185).

Related information

- Outside temperature gauge (p. 74)
- Trip meter (p. 74)
- Clock (p. 75)



03 Instruments and controls

Instruments and controls, right-hand drive car - overview

The overview shows where the car's displays and controls are located.

03



Overview, right-hand drive cars

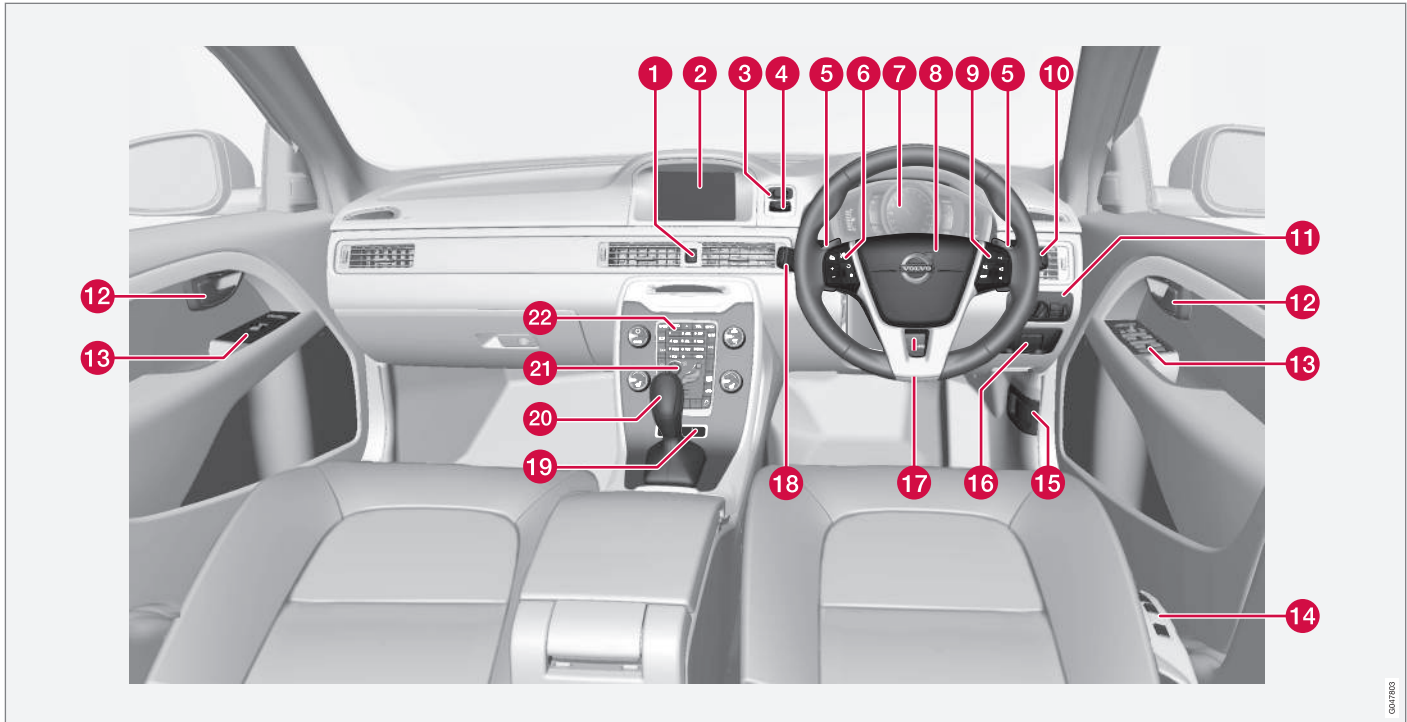



03 Instruments and controls



	Function	See
1	Hazard warning flashers	(p. 96).
2	Screen for infotainment system and display of menus	(p. 116) and the Sensus Infotainment supplement.
3	START/STOP ENGINE button	(p. 265).
4	Ignition switch	(p. 80).
5	Manual gear changing in an automatic gearbox*	(p. 273).
6	Cruise control*	(p. 203) and (p. 205).
7	Combined instrument panel	(p. 65).
8	Horn, airbags	(p. 86) and (p. 31).
9	Menu navigation, audio control, phone control*	(p. 116) and the Sensus Infotainment supplement.
10	Wipers and washing	(p. 104).

	Function	See
11	Headlamp control, opener for fuel filler flap and tailgate	(p. 88), (p. 302) and (p. 185).
12	Door handle	-
13	Control panel	(p. 183), (p. 189), (p. 106) and (p. 108).
14	Seat adjustment*	(p. 83).
15	Bonnet opener	(p. 360).
16	Parking brake	(p. 295).
17	Steering wheel adjustment	(p. 86).
18	Menus and messages, direction indicators, main/dipped beam, trip computer	(p. 113), (p. 116), (p. 97), (p. 92) and (p. 127).
19	Controls for active chassis (Four-C)*	(p. 195).
20	Gear selector	(p. 271), (p. 273) or (p. 276).

	Function	See
21	Control panel for climate control	(p. 136).
22	Control panel for infotainment system and menu navigation	(p. 116) and the Sensus Infotainment supplement.

Related information

- Outside temperature gauge (p. 74)
- Trip meter (p. 74)
- Clock (p. 75)



Combined instrument panel

The combined instrument panel's information display shows information on some of the car's functions, as well as messages.

- Analogue combined instrument panel - overview (p. 65)
- Digital combined instrument panel - overview (p. 66)
- Combined instrument panel - meaning of indicator symbols (p. 70)
- Combined instrument cluster - meaning of warning symbols (p. 72)

Analogue combined instrument panel - overview

The combined instrument panel's information display shows information on some of the car's functions, as well as messages.

Information display

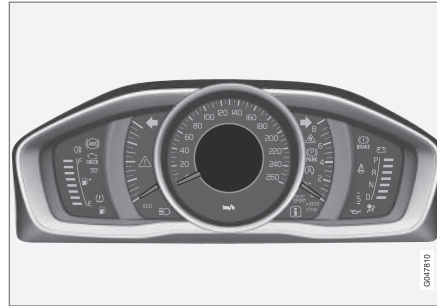

Information display, analogue instrument panel.

The combined instrument panel's information display shows information on some of the car's functions, e.g. cruise control and trip computer, as well as messages. The information is shown with symbols and text. There are further descriptions under the functions that use the display.

Gauges and indicators

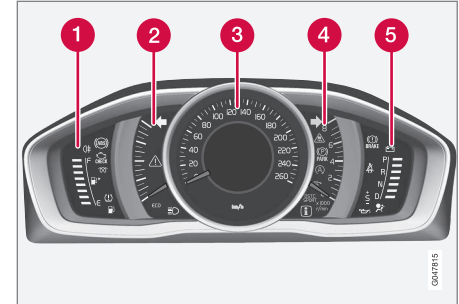

- 1 Fuel gauge. When the indicator lowers to only one white marking¹, the yellow indicator symbol for low level in the fuel tank is illuminated. See also Trip computer - supplementary information (p. 127) and Filling up with fuel (p. 302).
- 2 Eco meter The meter provides an indication of how economically the car is being driven. The higher the reading on the scale, the more economical it is.
- 3 Speedometer

¹ When the display's message "Distance to empty fuel tank:" starts to show "----", the marking becomes red.



- 4 Tachometer. The meter indicates engine speed in thousands of revolutions per minute (rpm).
- 5 Gear shift indicator²/Gear position indicator³ See also Gear shift indicator* (p. 272), Automatic gearbox -- Geartronic* (p. 273) or Automatic gearbox -- Powershift* (p. 276).

Indicator and warning symbols

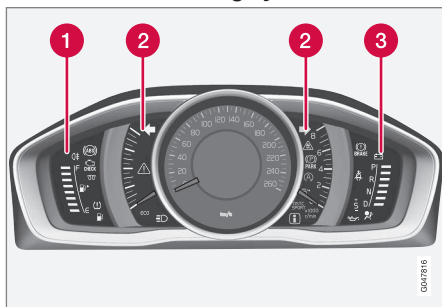

Indicator and warning symbols, analogue instrument panel.

- 1 Indicator symbols
- 2 Indicator and warning symbols
- 3 Warning symbols⁴

² Manual gearbox.

³ Automatic gearbox.

⁴ Certain engine variants do not have systems to warn of oil pressure loss. In cars with these variants the symbol for low oil pressure is not used. Warning for low oil level is via display text. For more information, see Engine oil - general (p. 362).

Functionality check

All indicator and warning symbols, apart from symbols in the centre of the information display, illuminate in key position II or when the engine is started. When the engine has started, all the symbols should go out except the parking brake symbol, which only goes out when the brake is disengaged.

If the engine does not start or if the functionality check is carried out in key position II then all symbols go out within a few seconds except the symbol for faults in the car's emissions system and the symbol for low oil pressure.

Related information

- Combined instrument panel (p. 65)
- Combined instrument panel - meaning of indicator symbols (p. 70)
- Combined instrument cluster - meaning of warning symbols (p. 72)

Digital combined instrument panel - overview

The combined instrument panel's information display shows information on some of the car's functions, as well as messages.

Information display

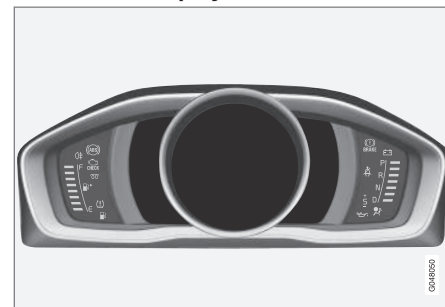

Information display, digital instrument panel*.

The combined instrument panel's information display shows information on some of the car's functions, e.g. cruise control and trip computer, as well as messages. The information is shown with symbols and text. There are further descriptions under the functions that use the display.



Gauges and indicators

Alternative themes can be selected for the digital combined instrument panel. Possible themes are "Elegance", "Eco" and "Performance".

A theme can only be selected when the engine is running.

To select the theme, press the left-hand stalk switch's **OK** button and select the **Themes** menu option by turning the thumbwheel on the lever. Press the **OK** button. Turn the thumbwheel to select the theme and confirm the selection by pressing the **OK** button.

On certain model variants, the appearance of the centre console's screen follows the theme selected for the combined instrument panel.

The contrast mode and colour mode for the instrument can also be set using the left-hand stalk switch.

For more information on menu navigation, see Menu navigation - combined instrument panel (p. 113).

The choice of theme and setting of contrast mode and colour mode can be stored for each remote control key in the car key memory*, see Remote control key - personalisation* (p. 168).

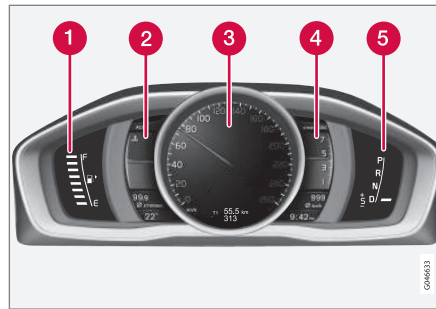

Gauges and indicators, theme "Elegance".

- 1 Fuel gauge. When the indicator lowers to only one white marking⁵, the yellow indicator symbol for low level in the fuel tank is illuminated. See also Trip computer - supplementary information (p. 127) and Filling up with fuel (p. 302).
- 2 Temperature gauge for engine coolant
- 3 Speedometer
- 4 Tachometer. The meter indicates engine speed in thousands of revolutions per minute (rpm).
- 5 Gear shift indicator⁶/Gear position indicator⁷ See also Gear shift indicator* (p. 272), Automatic gearbox --

Geartronic* (p. 273) or Automatic gearbox -- Powershift* (p. 276).

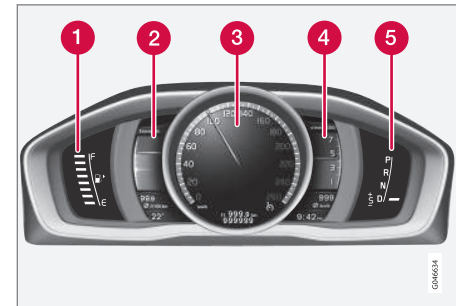

Gauges and indicators, theme "Eco".

- 1 Fuel gauge. When the indicator lowers to only one white marking⁵, the yellow indicator symbol for low level in the fuel tank is illuminated. See also Trip computer - supplementary information (p. 127) and Filling up with fuel (p. 302).
- 2 Eco guide. See also Eco guide & Power guide* (p. 69).
- 3 Speedometer

⁵ When the display's message "Distance to empty fuel tank:" starts to show "----", the marking becomes red.

⁶ Manual gearbox.

⁷ Automatic gearbox.



03 Instruments and controls



- 4 Tachometer. The meter indicates engine speed in thousands of revolutions per minute (rpm).
- 5 Gear shift indicator⁶/Gear position indicator⁷. See also Gear shift indicator* (p. 272), Automatic gearbox -- Geartronic* (p. 273) or Automatic gearbox -- Powershift* (p. 276).

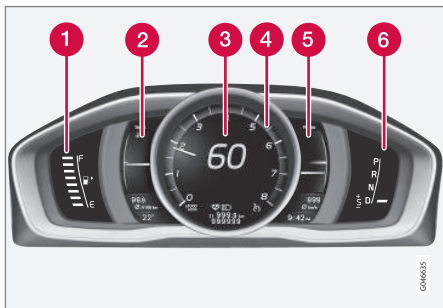

Gauges and indicators, theme "Performance".

- 1 Fuel gauge. When the indicator lowers to only one white marking⁵, the yellow indicator symbol for low level in the fuel tank is illuminated. See also Trip computer - supplementary information (p. 127) and Filling up with fuel (p. 302).
- 2 Temperature gauge for engine coolant

- 3 Speedometer
- 4 Tachometer. The meter indicates engine speed in thousands of revolutions per minute (rpm).
- 5 Power guide. See also Eco guide & Power guide* (p. 69).
- 6 Gear shift indicator⁶/Gear position indicator⁷. See also Gear shift indicator* (p. 272), Automatic gearbox -- Geartronic* (p. 273) or Automatic gearbox -- Powershift* (p. 276).

Indicator and warning symbols

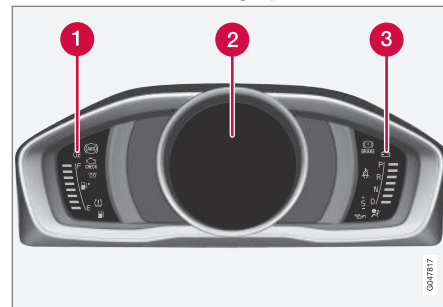

Indicator and warning symbols, digital instrument panel.

- 1 Indicator symbols
- 2 Indicator and warning symbols
- 3 Warning symbols⁸

⁶ Manual gearbox.

⁷ Automatic gearbox.

⁵ When the display's message "Distance to empty fuel tank:" starts to show "----", the marking becomes red.

⁸ Certain engine variants do not have systems to warn of oil pressure loss. In cars with these variants the symbol for low oil pressure is not used. Warning for low oil level is via display text. For more information, see Engine oil - general (p. 362).



Functionality check

All indicator and warning symbols, apart from symbols in the centre of the information display, illuminate in key position II or when the engine is started. When the engine has started, all the symbols should go out except the parking brake symbol, which only goes out when the brake is disengaged.

If the engine does not start or if the functionality check is carried out in key position II then all symbols go out within a few seconds except the symbol for faults in the car's emissions system and the symbol for low oil pressure.

Related information

- Combined instrument panel (p. 65)
- Combined instrument panel - meaning of indicator symbols (p. 70)
- Combined instrument cluster - meaning of warning symbols (p. 72)

Eco guide & Power guide*

Eco guide and Power guide are two combined instrument panel (p. 65) instruments which help the driver to drive the car with optimum driving economy.

The car also stores statistics of journeys made, which can be viewed in the form of a block diagram; see Trip computer - trip statistics (p. 128).*

Eco guide

This instrument provides an indication of how economically the car is being driven.

To view this function, select the theme "Eco"; see Digital combined instrument panel - overview (p. 66).

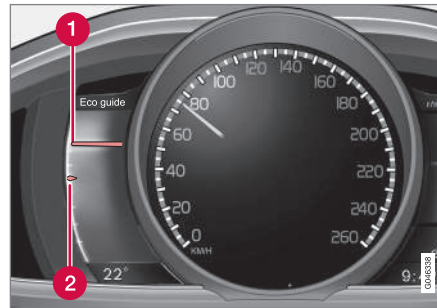

- 1 Instantaneous value
- 2 Average value

Instantaneous value

The instantaneous value is shown here - the higher the reading on the scale, the better.

The instantaneous value is calculated based on speed, engine speed, engine power utilised plus use of the foot brake.

Optimum speed (50-80 km/h) and low engine speeds are encouraged. The pointers fall during acceleration and braking.

Very low instantaneous values illuminate the red zone on the meter (with a short delay), which means poor driving economy and hence should be avoided.

Average value

The average value slowly follows the instantaneous value and describes how the car has been driven most recently. The higher the pointers on the scale, the better the economy achieved by the driver.

Power guide

This instrument shows the relationship between how much power (Power) is being taken from the engine and how much power is available.

To view this function, select the theme "Performance"; see Digital combined instrument panel - overview (p. 66).

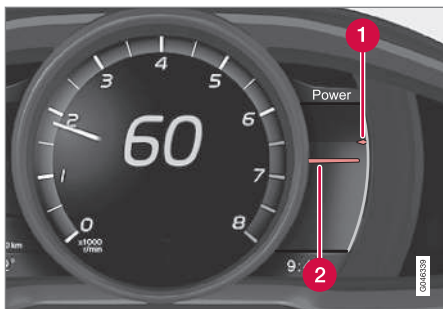

- 1 Available engine power
- 2 Engine power utilised

Available engine power

The smaller, upper pointer shows the available engine power⁹. The higher the reading on the scale, the more power is available in the current gear.

Engine power utilised

The larger, lower pointer shows the engine power utilised⁹. The higher the reading on the scale, the more power is being taken from the engine.

A large gap between the two pointers indicates a large power reserve.

Combined instrument panel - meaning of indicator symbols

The indicator symbols alert the driver that a function is activated, that the system is operating, or that an error or failure has occurred.

Indicator symbols

Symbol	Specification
	ABL fault
	Emissions system
	ABS fault
	Rear fog lamp on
	Stability system, see Electronic stability control (ESC) - general (p. 196)
	Stability system, sport mode, see Electronic stability control (ESC) - operation (p. 196)
	Engine preheater (diesel)
	Low level in fuel tank

Symbol	Specification
	Information, read display text
	Main beam On
	Left-hand direction indicator
	Right-hand direction indicator
	Eco- function on, see ECO* (p. 290)
	Start/Stop, the engine auto-stopped; see Start/Stop* - function and operation (p. 282)
	Tyre pressure system , see Tyre pressure monitoring* (p. 334)

ABL fault

The symbol illuminates if a fault has arisen in the ABL function (Active Bending Lights).

Emissions system

If the symbol illuminates after the engine has been started then it may be due to a fault in the car's emissions system. Drive to a workshop for checking. Volvo recommends that you seek assistance from an authorised Volvo workshop.

⁹ Power is dependent on engine speed.

* Option/accessory, for more information, see Introduction.



ABS fault

If this symbol illuminates then the system is not working. The car's regular brake system continues to work, but without the ABS function.

1. Stop the car in a safe place and turn off the engine.
2. Restart the engine.
3. If the symbol remains illuminated, drive to a workshop to have the ABS system checked. Volvo recommends that you seek assistance from an authorised Volvo workshop.

Rear fog lamp on

This symbol illuminates when the rear fog lamp is switched on.

Stability system

A flashing symbol indicates that the stability system is operating. If the symbol illuminates with constant glow then there is a fault in the system.

Stability system, sport mode

Sport mode allows for a more active driving experience. The system then detects whether the accelerator pedal, steering wheel movements and cornering are more active than in normal driving and then allows controlled skidding of the rear section up to a certain level before it intervenes and stabilises the

car. The symbol illuminates when the sport mode is activated.

Engine preheater (diesel)

This symbol illuminates during engine preheating. Preheating takes place mostly due to low temperature.

Low level in fuel tank

When the symbol illuminates the level in the fuel tank is low, refuel as soon as possible.

Information, read display text

When one of the car's systems does not behave as intended, this information symbol illuminates and a text appears on the information display. The message text is cleared with the **OK** button, see Menu navigation - combined instrument panel (p. 113), or it disappears automatically after a time (time depending on which function is indicated). The information symbol can also illuminate in conjunction with other symbols.



NOTE

When a service message is shown, the symbol and message are cleared using the **OK** button, or disappear automatically after a time.

Main beam On

The symbol illuminates when main beam is on and with main beam flash.

Left/right-hand direction indicator

Both direction indicator symbols flash when the hazard warning flashers are used.

Eco function on

This symbol illuminates when the Eco function is activated.

Start/Stop

The symbol shines when the engine is auto-stopped.

Tyre pressure system

The symbol illuminates in the event of low tyre pressure, or if a fault arises in the tyre pressure system.





03 Instruments and controls



Reminder – doors not closed

If one of the doors is not closed properly then the information or warning symbol illuminates together with an explanatory image in the information display. Stop the car in a safe place as soon as possible and close the door that is open.

 If the car is driven at a speed lower than approx. 7 km/h then the information symbol illuminates.

 If the car is driven at a speed higher than approx. 7 km/h then the warning symbol illuminates.

If the bonnet¹⁰ is not closed properly then the warning symbol illuminates together with an explanatory image in the information display. Stop the car in a safe place as soon as possible and close the bonnet.

If the tailgate is not closed properly then the information symbol illuminates together with an explanatory image in the information display. Stop the car in a safe place as soon as possible and close the tailgate.









Related information

- Combined instrument panel (p. 65)
- Combined instrument cluster - meaning of warning symbols (p. 72)
- Digital combined instrument panel - overview (p. 66)

Combined instrument cluster - meaning of warning symbols

The warning symbols alert the driver that an important function is activated, or that a serious error or a serious failure has occurred.

Warning symbols

Symbol	Specification
	Low oil pressure ^A
	Parking brake applied, digital instrument panel
	Parking brake applied, analogue instrument panel
	Airbags – SRS
	Seatbelt reminder
	Alternator not charging
	Fault in brake system
	Warning

^A Certain engine variants do not have systems to warn of oil pressure loss. In cars with these variants the symbol for low oil pressure is not used. Warning for low oil level is via display text. For more information, see Engine oil - general (p. 362).

Low oil pressure

If this symbol illuminates during driving then the engine's oil pressure is too low. Stop the engine immediately and check the engine oil level, top up if necessary. If the symbol illuminates and the oil level is normal, contact a workshop. Volvo recommends that you seek assistance from an authorised Volvo workshop.

Parking brake applied

This symbol illuminates with a constant glow when the parking brake is applied. The symbol flashes during application, and then changes over to a constant glow.

A flashing symbol in any other situation means that a fault has arisen. Read the message on the information display.

For more information, see Parking brake (p. 295).

Airbags – SRS

If this symbol remains illuminated or illuminates while driving, it means a fault has been detected in the seatbelt buckle, SRS, SIPS, or IC systems. Drive immediately to a workshop to have the system checked. Volvo recommends that you seek assistance from an authorised Volvo workshop.

Seatbelt reminder

This symbol flashes if someone in a front seat has not put on their seatbelt or if someone in a rear seat has taken off their seatbelt.

¹⁰ Only cars with alarm*.

* Option/accessory, for more information, see Introduction.



Alternator not charging

This symbol illuminates during driving if a fault has occurred in the electrical system. Visit a workshop. Volvo recommends that you seek assistance from an authorised Volvo workshop.

Fault in brake system

If this symbol illuminates, the brake fluid level may be too low. Stop the car in a safe place and check the level in the brake fluid reservoir; see Brake and clutch fluid - level (p. 367).

If the brake and ABS symbols illuminate at the same time, there may be a fault in the brake force distribution system.

1. Stop the car in a safe place and turn off the engine.
2. Restart the engine.
 - If both symbols extinguish, continue driving.
 - If the symbols remain illuminated, check the level in the brake fluid reservoir; see Brake and clutch fluid - level (p. 367). If the brake fluid level is normal but the symbols are still illuminated, the car can be driven, with great care, to a workshop to have the brake system checked. Volvo recommends that you seek assistance from an authorised Volvo workshop.

WARNING

If the brake fluid is under the **MIN** level in the brake fluid reservoir, do not drive further before topping up the brake fluid.

The loss of brake fluid must be investigated by a workshop. Volvo recommends that you contact an authorised Volvo workshop.

WARNING

If the BRAKE and ABS symbols are lit at the same time, there is a risk that the rear end will skid during heavy braking.

Warning

The red warning symbol illuminates when a fault has been indicated which could affect the safety and/or driveability of the car. An explanatory text is shown on the information display at the same time. The symbol remains visible until the fault has been rectified but the text message can be cleared with the **OK** button; see Menu navigation - combined instrument panel (p. 113). The warning symbol can also illuminate in conjunction with other symbols.

Action:

1. Stop in a safe place. Do not drive the car further.

2. Read the information on the information display. Implement the action in accordance with the message in the display. Clear the message using the **OK** button.

Reminder – doors not closed

If one of the doors is not closed properly then the information or warning symbol illuminates together with an explanatory image in the information display. Stop the car in a safe place as soon as possible and close the door that is open.

 If the car is driven at a speed lower than approx. 7 km/h then the information symbol illuminates.

 If the car is driven at a speed higher than approx. 7 km/h then the warning symbol illuminates.

If the bonnet¹¹ is not closed properly then the warning symbol illuminates together with an explanatory image in the information display. Stop the car in a safe place as soon as possible and close the bonnet.

If the tailgate is not closed properly then the information symbol illuminates together with an explanatory image in the information display. Stop the car in a safe place as soon as possible and close the tailgate.

¹¹ Only cars with alarm*.



Related information

- Combined instrument panel (p. 65)
- Combined instrument panel - meaning of indicator symbols (p. 70)
- Digital combined instrument panel - overview (p. 66)

Outside temperature gauge

The display for the outside temperature gauge appears in the combined instrument panel.

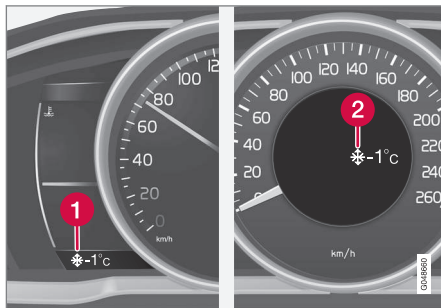

- 1 Display for outside temperature gauge, digital instrument panel
- 2 Display for outside temperature gauge, analogue instrument panel

When the temperature lies between +2 °C to -5 °C a snowflake symbol illuminates in the display. This warns of icy roads. If the car has been stationary, the gauge may display a reading that is too high.

Related information

- Combined instrument panel (p. 65)

Trip meter

The trip meter display appears in the combined instrument panel.



Trip meter, digital instrument panel.

- 1 Display for trip meter¹²

Both trip meters **T1** and **T2** are used to measure short distances. The distance is shown in the display.

Turn the left-hand stalk switch's thumbwheel to show the required meter.

A long press (until the change occurs) on the left-hand stalk switch **RESET** button resets the trip meter shown. For more information, see Trip computer - supplementary information (p. 127).

Related information

- Combined instrument panel (p. 65)

¹² Display appearance may differ depending on instrument variant.



Clock

The clock display appears in the combined instrument panel.



Clock, digital instrument panel.

- 1 Display for showing the time¹³

Setting the clock

The clock can be adjusted in the menu system MY CAR, see MY CAR (p. 116).

Related information

- Combined instrument panel (p. 65)

Fuel gauge for vehicle gas*¹⁴

The Bi-Fuel model variant has a separate fuel gauge for vehicle gas.



Markings above the switch show the current fuel level.

Number of LEDs	Colour of LEDs	Fuel level (%)
5	Green	100
4	Green	80
3	Green	60
2	Green	40

Number of LEDs	Colour of LEDs	Fuel level (%)
1	Green	20
1	Orange	10

When the vehicle gas tank is empty the switch sounds 3 times. The level gauge extinguishes and the system automatically changes over to petrol.

i NOTE

Ensure that the petrol tank never runs dry because the car always starts on petrol.

03

¹³ The time is shown in the centre of an analogue instrument panel.

¹⁴ Applies to Bi-Fuel model variant.



Combined instrument panel - license agreement

A license is an agreement for the right to operate a certain activity or the right to use someone else's entitlement according to the terms and conditions in the agreement. The following text is Volvo's agreement with the manufacturer/developer.

Combined Instrument Panel Software Open Source Software Notice

This product uses certain free / open source and other software originating from third parties, that is subject to the GNU Lesser General Public License version 2 (LGPLv2), The FreeType Project License ("FreeType License") and other different and/or additional copy right licenses, disclaimers and notices. The links to access the exact terms of LGPLv2, and the other open source software licenses, disclaimers, acknowledgements and notices are provided to you below. Please refer to the exact terms of the relevant License, regarding your rights under said licenses. Volvo Car Corporation (VCC) offers to provide the source code of said free/open source software to you for a charge covering the cost of performing such distribution, such as the cost of media, shipping and handling, upon written request. Please contact your nearest Volvo Dealer.

The offer is valid for a period of at least three (3) years from the date of the distribution of

this product by VCC / or for as long as VCC offers spare parts or customer support.

Portions of this product uses software copyrighted © 2007 The FreeType Project (www.freetype.org). All rights reserved.

Portions of this product uses software with Copyright © 1994–2013 Lua.org, PUC-Rio (<http://www.lua.org/>)



This product includes software under following licenses:

LGPL v2.1: <http://www.gnu.org/licenses/old-licenses/lgpl-2.1.html>

- GNU FriBidi
- DevIL

The FreeType Project License: <http://git.savannah.gnu.org/cgit/freetype/freetype2.git/tree/docs/FTL.TXT>

- FreeType 2
- MIT License: <http://opensource.org/licenses/mit-license.html>
- Lua

Symbols in the display

There are a variety of different symbols in the display in the car. The symbols are divided into warning, indicator and information symbols.

Shown below are the most common symbols with their meanings and a reference to where in the manual further information can be found.

- Red warning symbol, illuminates when a fault has been indicated which could affect the safety and/or driveability of the car. An explanatory text is shown in the information display in the combined instrument panel at the same time.

- Information symbol, illuminates in combination with text in the information display in the combined instrument panel, when a deviation in any of the car's systems has occurred. The information symbol can also illuminate in conjunction with other symbols.

Warning symbols in the combined instrument panel

Symbol	Specification	See
	Low oil pressure	(p. 72)
	Parking brake applied	(p. 72), (p. 295)



Symbol	Specification	See
	Parking brake applied, alternative symbol	(p. 72)
	Airbags – SRS	(p. 30), (p. 72)
	Seatbelt reminder	(p. 27), (p. 72)
	Alternator not charging	(p. 72)
	Fault in brake system	(p. 72), (p. 292)
	Warning, safety mode	(p. 30), (p. 41), (p. 72), (p. 276)

Control symbols in the combined instrument panel

Symbol	Specification	See
	ABL fault*	(p. 70), (p. 95)
	Emissions system	(p. 70)
	ABS fault	(p. 70), (p. 292)

Symbol	Specification	See
	Rear fog lamp on	(p. 70), (p. 95)
	Stability system, ESC (Electronic Stability Control), Hill descent control	(p. 70), (p. 280), (p. 198),
	Stability system, sport mode	(p. 70), (p. 198)
	Engine preheater (diesel)	(p. 70)
	Low level in fuel tank	(p. 70), (p. 149)
	Information, read display text	(p. 70)
	Main beam On	(p. 70), (p. 92)
	Left-hand direction indicators	(p. 70)
	Right-hand direction indicators	(p. 70)
	Start/Stop*, engine auto-stopped	(p. 70), (p. 288)

Symbol	Specification	See
	ECO function* on	(p. 70), (p. 290)
	Tyre pressure system*	(p. 70), (p. 334)

Information symbols in the combined instrument panel

Symbol	Specification	See
	Cruise control*	(p. 203)
	Adaptive cruise control*	(p. 218)
	Adaptive cruise control*, time interval	(p. 205), (p. 208)
	Adaptive cruise control*, Distance Warning* (Distance Alert)	(p. 210), (p. 220)
	Radar sensor*	(p. 218), (p. 222), (p. 238)
-	-	-



03 Instruments and controls



Symbol	Specification	See
	Windscreen sensor*, Camera sensor*, Laser sensor*	(p. 93), (p. 229), (p. 238), (p. 242), (p. 246)
	Auto Brake*, Distance Warning* (Distance Alert), City Safety™, Collision warning system*	(p. 222), (p. 229), (p. 238)
	ABL system*	(p. 95)
	Driver Alert System*, Time for a break	(p. 241)
	Driver Alert System*, Time for a break	(p. 242)
	Parking brake	(p. 295)
	Rain sensor*	(p. 104)
	Active high beam, AHB (Active High Beam)*	(p. 93)



Symbol	Specification	See
	Start/Stop*	(p. 288)
	Start/Stop*	(p. 288)
	Driver Alert System*, Lane Departure Warning (LDW)	(p. 242), (p. 246)
	Driver Alert System*, Lane Departure Warning*	(p. 244)
	Driver Alert System*, Lane Departure Warning*	(p. 246)
	Recorded speed information*	(p. 200)
	Engine block and passenger compartment heater*	(p. 149)

Symbol	Specification	See
	Engine block heater and passenger compartment heater* Service required	(p. 149)
	Activated timer*	(p. 149)
	Activated timer*	(p. 149)
	Low battery	(p. 149)
	Fuel filler flap, right-hand side	(p. 302)
	Gear shift indicator	(p. 272)
	Gear positions	(p. 273)
	Measuring the oil level	(p. 363)
-	-	-

03



Information symbols in the roof console display

Symbol	Specification	See
	Seatbelt reminder	(p. 29)
	Airbag, passenger seat, activated	(p. 34)
	Airbag, passenger seat, deactivated	(p. 34)

Related information

- Combined instrument panel - meaning of indicator symbols (p. 70)
- Combined instrument cluster - meaning of warning symbols (p. 72)
- Messages - handling (p. 116)

Volvo Sensus

Volvo Sensus is the heart of the personal Volvo experience and connects you with the car and outside world. Sensus provides information, entertainment and assistance when it is needed. Sensus consists of intuitive functions that both enhance the car journey and simplifies ownership of the car.



An intuitive navigation structure makes it possible to receive relevant support, information and entertainment when it is necessary, without distracting the driver.

Sensus covers all the car's solutions that enable connection* to the outside world and provides you with intuitive control over all the car's capabilities.

Volvo Sensus combines and presents many functions in several of the car's systems on the centre console's display screen. With Volvo Sensus the car can be personalised by means of an intuitive user interface. Settings

can be made in Car settings, Audio and media, Climate control, etc.

With the centre console buttons and controls or the steering wheel's right-hand keypad* functions can be activated or deactivated and many different settings can be made.

With a press on **MY CAR** all settings related to the driving and control of the car are presented, such as City Safety, locks and alarm, automatic fan speed, setting the clock, etc.

With a press on the respective function **RADIO**, **MEDIA**, **TEL**, , **NAV*** and **CAM*** other sources, systems and functions can be activated, e.g. AM, FM, CD, DVD*, TV*, Bluetooth®, navigation* and park assist camera*.

For more information about all functions/systems, see the relevant section in the owner's manual or its supplement.



Overview

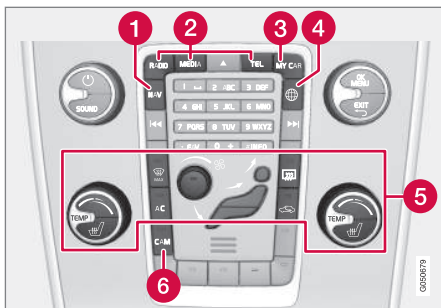

Control panel in centre console. The figure is schematic - the number of functions and layout of the buttons both vary, depending on the equipment selected and the market.

- 1 Navigation* - **NAV**, see separate supplement (Sensus Navigation).
- 2 Audio and media - **RADIO, MEDIA, TEL***, see separate supplement (Sensus Infotainment).
- 3 Function settings - **MY CAR**, see MY CAR (p. 116).
- 4 Internet-connected car - *, see separate supplement (Sensus Infotainment).
- 5 Climate control system (p. 130).
- 6 Park assist camera* (p. 251) – **CAM***.

Key positions

The remote control key can be used to set the vehicle's electrical system in different modes/levels so that different functions are available; see *Key positions - functions at different levels* (p. 81).



Ignition switch with remote control key extracted/inserted.

NOTE

For cars with the Keyless* function the remote control key does not need to be inserted into the ignition switch but can be stored in e.g. a pocket. For more information on Keyless functions, see *Keyless drive** (p. 178).

Insert the remote control key

1. Hold the end of the remote control key with the detachable key blade and insert

the remote control key in the ignition switch.

2. Then press the remote control key in the lock up to its end position.

IMPORTANT

Foreign objects in the ignition switch can impair the function or destroy the lock.

Do not press in the remote control key incorrectly turned - hold the end with the detachable key blade - see *Detachables key blade - detaching/attaching* (p. 174).

Remove the remote control key

Push the remote control key, allow it to eject, then pull it out from the ignition switch.



Key positions - functions at different levels

To enable the use of a limited number of functions with the engine switched off, the car's electrical system can be set in 3 different levels - **0**, **I** and **II** - with the remote control key. This owner's manual describes these levels throughout using the denomination "key positions".

The following table shows the functions available in each key position/level.

Level	Functions
0	<ul style="list-style-type: none"> • Odometer, clock and temperature gauge are illuminated. • Electrically operated seats can be adjusted. • The audio system can be used for a limited time - see the Sensus Infotainment supplement.
I	<ul style="list-style-type: none"> • Sunroof, power windows, 12 V socket in the passenger compartment, navigation, phone, ventilation fan and windshield wipers can be used.

Level	Functions
II	<ul style="list-style-type: none"> • The headlamps come on. • Warning/indicator lamps illuminate for 5 seconds. • Several other systems are activated. However, electric heating in seat cushions and the rear window can only be activated after starting the engine. <p>This key position consumes a lot of current from the starter battery and should therefore be avoided!</p>

Selecting key position/level

- **Key position 0** - Unlock the car - This means that the car's electrical system is at level **0**.

NOTE

To reach level **I** or **II** **without** starting the engine - do **not** depress the brake/clutch pedal when these key positions are due to be selected.



03 Instruments and controls



- **Key position I** - With the remote control key fully inserted into the ignition switch¹⁵ - Briefly press **START/STOP ENGINE**.
- **Key position II** - With the remote control key fully inserted into the ignition switch¹⁵ - Give a long¹⁶ press on **START/STOP ENGINE**.
- **Back to key position 0** - To return to key position **0** from position **II** and **I** - Briefly press on **START/STOP ENGINE**.

Audio system

For information on audio system functions with remote control key removed, see the Sensus Infotainment supplement.

Starting and stopping the engine

For information about starting/stopping the engine, see Starting the engine (p. 265).

Towing

For important information about the remote control key during towing, see Towing (p. 316).

Related information

- Key positions (p. 80)

Seats, front

The car's front seats have different setting options for optimum seating comfort.

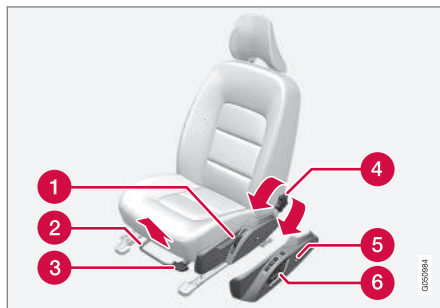

- 1 Raise/lower the seat, pump up/down.
- 2 Forward/backward: lift the handle to adjust the distance to the steering wheel and pedals. Check that the seat is locked after changing position.
- 3 Raise/lower* front edge of seat cushion, pump up/down.
- 4 Adjust backrest rake, turn the wheel.
- 5 Change the lumbar support*, press the button.
- 6 Control panel for power seat*, see Seats, front - electrically operated* (p. 83).



WARNING

Adjust the position of the driver's seat before setting off, never while driving. Make sure that the seat is in locked position in order to avoid personal injury in the event of heavy braking or an accident.

Lowering the passenger seat backrest*

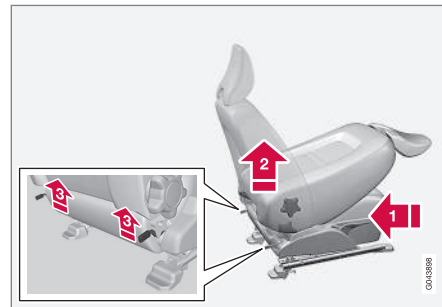

The passenger seat's backrest can be folded forward to make room for long loads.

- 1 Move the seat as far back/down as possible.
- 2 Adjust the backrest to an upright position.
- 3 Lift the catches on the rear of the backrest and fold it forward.

¹⁵ Not required for cars with the Keyless* function.

¹⁶ Approx. 2 seconds.



- Push the seat forward so that the head restraint "locks" in under the glovebox.

Raising takes place in reverse order.

WARNING

Grasp the backrest and make sure that it is properly locked after being folded up in order to avoid personal injury in the event of sudden braking or an accident.

Related information

- Seats, front - electrically operated* (p. 83)
- Seats, rear (p. 84)

Seats, front - electrically operated*

The car's front seats have different setting options for optimum seating comfort. The power seat can be moved forward/backward and up/down. The front edge of the seat cushion can be raised/lowered. The backrest angle and lumbar support* can be changed.

Power seat

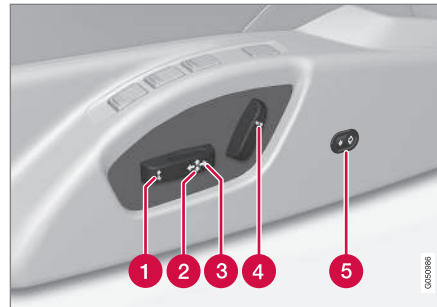

- Front edge of seat cushion up/down
- Raise/lower seat
- Seat, forward/backward
- Backrest rake
- Lumbar support* is adjusted inward and outward

The power seats have overload protection which is tripped if a seat is blocked by an object. If this should happen, set the car's

electrical system in key position **I** or **0** and wait a short time before adjusting the seat again.

Only one movement (forward/back/up/down/inward/outward) can be made at a time.

Preparations

The seat can be adjusted for a certain time after unlocking the door with the remote control key without the key in the ignition switch. Seat adjustment is normally made in key position **I** and can always be made when the engine is running.

Seat with memory function*

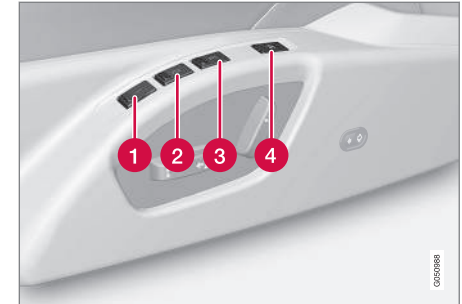

The memory function stores settings for the seat and the door mirrors.



Store setting

- 1 Memory button
- 2 Memory button
- 3 Memory button
- 4 Button for storing settings

1. Adjust the seat and the door mirrors.
2. Press and hold button **M** while pressing button **1**, **2** or **3** simultaneously. Hold the buttons depressed until the acoustic signal is heard and text is shown in the combined instrument panel.

The seat must be adjusted again before a new memory can be set.

The setting for lumbar support is not stored.

Using a stored setting

Press one of the memory buttons **1-3** until the seat and the door mirrors stop. If the button is released, the movement of the seat and door mirrors will be interrupted.

Key memory* in remote control key

All remote control keys can be used by different drivers to store the settings for the driver's seat and door mirrors¹⁷, see Remote control key - personalisation* (p. 168).

Emergency stop

If the seat accidentally begins to move, press one of the setting buttons for the seat or memory buttons in order to stop the seat.

Restarting to reach the seat position stored in the key memory is performed by pressing the unlock button on the remote control key. The driver's door must then be open.



WARNING

Risk of crushing! Make sure that children do not play with the controls. Check that there are no objects in front of, behind or under the seat during adjustment. Make sure that none of the passengers in the rear seat is in danger of becoming trapped.

Heated/ventilated seats*

For heated seats/ventilated, see Heated front seats* (p. 137) and Heated rear seat* (p. 137).

Related information

- Seats, front (p. 82)
- Seats, rear (p. 84)

Seats, rear

The rear seat backrest and the outer seat head restraints can be folded. The centre seat head restraint can be adjusted to suit the height of the passenger.

Head restraint, centre seat, rear

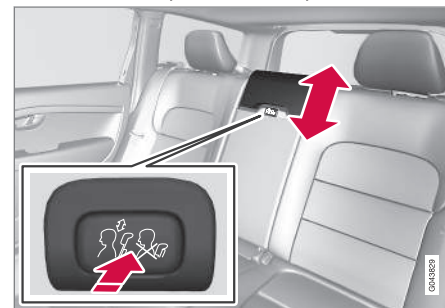

Adjust the head restraint according to passenger height so that the whole of the back of the head is covered if possible. Slide it up as required.

To lower the head restraint again, the button (located in the centre between the backrest and head restraint, see illustration) must be pressed in while the head restraint is pressed down carefully.

¹⁷ Only if the car is equipped with power seat with memory and retractable power rearview and door mirrors. The setting for lumbar support is not stored.



⚠ WARNING

The centre seat head restraint must be in its lowest position when the centre seat is not used. When the centre seat is used, the head restraint must be correctly adjusted to the height of the passenger so that it covers the whole of the back of the head if possible.

Manual lowering of the outer head restraints, rear seat

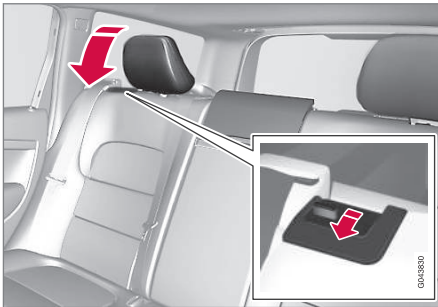

Pull the locking handle closest to the head restraint to fold the head restraint forward.

The head restraint is moved back manually until a "click" can be heard.

⚠ WARNING

The head restraints must be in locked position after being raised.

Lowering the rear seat backrest

! IMPORTANT

There must be no objects on the rear seat when the backrest is to be folded down. The seat belts must not be connected either. Otherwise there is a risk of damaging the rear seat upholstery.

The triple-section backrest can be folded in different ways.

i NOTE

The front seats may need to be pushed forwards, and/or the backrests adjusted upwards, in order that the rear backrests can be fully folded forward.

- The left-hand section can be folded separately.
- The centre section can be folded separately.
- The right-hand section can only be folded together with the centre section.
- If the entire backrest is to be folded then the different sections should be folded separately.

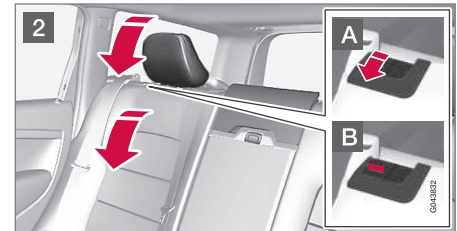
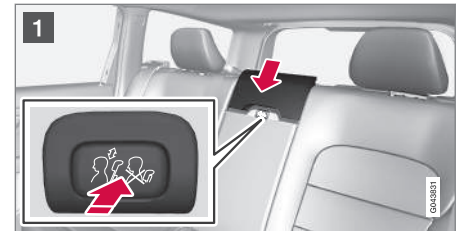

- 1** If the centre backrest is being lowered - release and adjust the head restraint for the centre backrest, see the earlier section "Head restraint, centre seat, rear".
- 2** The outer head restraints are lowered automatically when the outer backrests are lowered. Pull up the backrest's locking handle **A** while folding the backrest forward at the same time. A red indicator on the lock catch **B** shows that the backrest is no longer locked in place.

Raising takes place in reverse order.



NOTE

When the backrest has been raised, the red indicator should no longer be showing. If it is still showing then the backrest is not locked in place.

WARNING

Check that the backrests and head restraints in the rear seat are locked properly after being folded up.

Electrical lowering of the rear seat's outer head restraints*



1. The remote control key must be in key position **II**.
2. Press the button to lower the rear outer head restraints to improve rearward visibility.

WARNING

Do not lower the outer head restraints if there are passengers in any of the outer seats.

Move the head restraint back manually until a click is heard.

WARNING

The head restraints must be in locked position after being raised.

Related information

- Seats, front (p. 82)
- Seats, front - electrically operated* (p. 83)

Steering wheel

The steering wheel can be adjusted in different positions and has controls for horn and cruise control, as well as menu, audio and phone control.

Adjusting

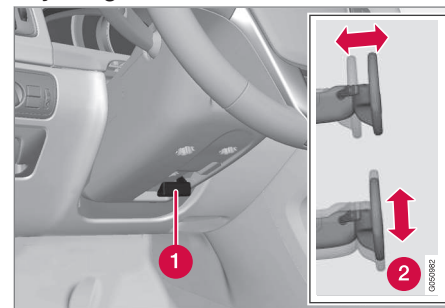

Adjusting the steering wheel.

- 1** Lever - releasing the steering wheel
- 2** Possible steering wheel positions

The steering wheel can be adjusted for both height and depth:

1. The lever is pulled towards the driver to release the steering wheel.
2. Adjust the steering wheel to the position that suits you.



- Push back the lever to fix the steering wheel in place. If the lever is stiff, press the steering wheel lightly at the same time as you push the lever back.

WARNING

Adjust the steering wheel and fix it before driving away.

With speed related power steering* the level of steering force can be adjusted, see Adjustable steering force* (p. 195).

Keypads* and paddles*

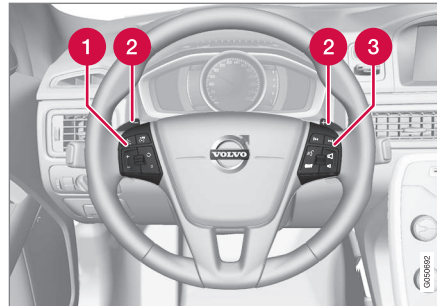

Keypads and paddles in the steering wheel.

- 1 Cruise control* (p. 203)* and Adaptive cruise control - ACC* (p. 205)*.
- 2 Paddle for manual gear changing in an automatic gearbox, see Automatic gearbox -- Geartronic* (p. 273).
- 3 Audio and phone control, see supplement, Sensus Infotainment.

Horn



Horn.

Press the centre of the steering wheel to signal.

Related information

- Heating* of the steering wheel (p. 88)



Heating* of the steering wheel

The steering wheel can be heated with electric heating.

Function

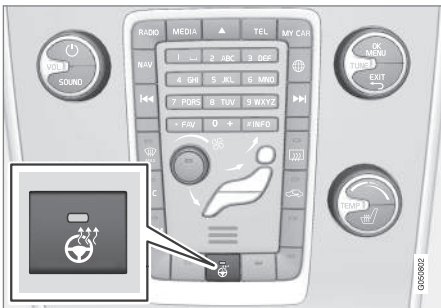

Button position may vary depending on equipment selected and market.

Repeatedly **press the button to switch** between the following functions:

Function	Indicator
Switched off	Button lamp extinguished
Heating	Button lamp illuminated

Automatic steering wheel heating

With activated automatic start of steering wheel heating, the heating of the steering wheel starts when the engine is started. Automatic start takes place when the car is cold and the ambient temperature is below

approx. 10 °C. Activate/deactivate the function in the menu system **MY CAR** (p. 116).

Light switches

The headlamp control activates and adjusts the external lighting. It is also used to adjust display and instrument lighting and ambience lights (p. 98).



Overview, light switches



Overview, light switches.

- 1 Thumbwheel for adjusting display and instrument lighting as well as ambience lights*
- 2 Button for rear fog lamp
- 3 Knob for daytime running lights and parking lamps
- 4 Thumbwheel¹⁸ for headlamp levelling

Knob positions

Position	Specification
0	Daytime running lights ^A when the car's electrical system is in key position II or the engine is running. Main beam flash can be used.
	Daytime running lights, side marker lamps rear and position/parking lamps when the car's electrical system is in key position II or the engine is running. Side marker lamps rear and position/parking lamps when the car is parked. Main beam flash can be used.

Position	Specification
AUTO	Daytime running lights, side marker lamps rear and position/parking lamps in daylight when the car's electrical system is in key position II or the engine is running. Dipped beam, side marker lamps rear and position/parking lamps in weak daylight or darkness, or when the rear fog lamp or windscreen wipers with continuous wiping are activated. The tunnel detection (p. 92)* function is activated. The Active main beam (p. 93)* function can be used. Main beam can be activated when dipped beam is switched on. Main beam flash can be used.
	Dipped beam, side marker lamps rear and position/parking lamps. Main beam can be activated.

¹⁸ Not available for cars equipped with active Xenon headlamps*.



03 Instruments and controls



Position	Specification
	Main beam flash can be used.

A Fitted in or under the front bumper.

Volvo recommends that **AUTO** mode is used when the car is driven.

WARNING

The car's audio system is not able to determine when daylight is too weak or sufficiently strong, e.g. in fog and rain, in all situations.

The driver is always responsible for ensuring that the car is driven with a beam pattern suitable for the traffic situation and in accordance with applicable traffic regulations.

Instrument lighting

Different display and instrument lighting is switched on depending on key position; see Key positions - functions at different levels (p. 81).

The display lighting is automatically subdued in darkness - the sensitivity is set with the thumbwheel.

The intensity of the instrument lighting is adjusted with the thumbwheel.

Headlamp levelling

The load in the car changes the vertical alignment of the headlamp beam, which could dazzle oncoming motorists. Avoid this by adjusting the height of the beam. Lower the beam if the car is heavily laden.

1. Leave the engine running, or have the car's electrical system in key position I.
2. Roll the thumbwheel up/down to raise/lower beam alignment.

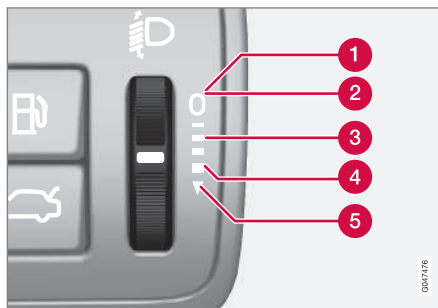

Thumbwheel positions for different load cases.

- 1 Only driver
- 2 Driver and passenger in the front passenger seat
- 3 Occupants in all seats
- 4 Occupants in all seats and maximum load in the cargo area
- 5 The driver and maximum load in the cargo area

Cars with active Xenon headlamps* have automatic headlamp levelling and are therefore not equipped with the thumbwheel.

Related information

- Position/parking lamps (p. 91)
- Daytime running lights (p. 91)
- Main/dipped beam (p. 92)



Position/parking lamps

Position/parking lamps are switched on with the headlamp control's knob.



Knob for headlamp control in the position for position/parking lamps.

Turn the knob to the position for  (number plate lighting is switched on at the same time).

If the car's electrical system is in key position **II** or the engine is running then the daytime running lights also switch on.

When it is dark outside and the tailgate is opened the rear position/parking lamps are switched on in order to alert traffic behind. This takes place irrespective of what position the knob is in or what key position the car's electrical system is in.

Related information

- Light switches (p. 88)

Daytime running lights

With the knob for headlamp control in **AUTO** position, and the car's electrical system in key position **II** or the engine running, the daytime running lights are activated automatically in daylight.

Daytime running lights during the day. DRL



Knob for headlamp control in **AUTO** position.

With the knob for headlamp control in **AUTO** position the daytime running lights (Daytime Running Lights - DRL) are activated automatically when the car is driven in daylight. A light sensor on the top of the instrument panel changes from daytime running lights to dipped beam at twilight or when daylight becomes too weak. Switching to dipped beam also takes place when the windscreen wipers or rear fog lamps are activated.

WARNING

This system help to save energy - it cannot determine in all situations when daylight is too weak or sufficiently strong, e.g. in mist and rain.

The driver is always responsible for ensuring that the car is driven with the correct beam pattern for the traffic situation and in accordance with applicable traffic regulations.



Tunnel detection*

Tunnel detection changes the lighting from daytime running lights to dipped beam when the car is driven into a tunnel. Approx. 20 seconds after the car has left the tunnel, the lighting returns to daytime running lights.

The tunnel detection function is available in cars with rain sensor*. The sensor detects the entrance to a tunnel and resets the lighting from daytime running lights to dipped beam. Approx. 20 seconds after the car has left the tunnel, the lighting returns to daytime running lights. If the car is driven into another tunnel within this time period then dipped beam is kept switched on. This avoids repeated changes to the car's lighting.

Note that the headlamp control's knob must remain in **AUTO** position for tunnel detection to work.

Related information

- Main/dipped beam (p. 92)
- Light switches (p. 88)



Main/dipped beam

With the knob for headlamp control in position **AUTO** and the car's electrical system in key position **II** or the engine running, the dipped beam is activated automatically in poor light conditions.

With the knob for headlamp control in position  dipped beam is always switched on when the engine is running or when key position **II** is active.



Stalk switch and knob for headlamp control.

-  Position for main beam flash
-  Position for main beam

Dipped beam

With the knob in **AUTO** position, dipped beam is activated automatically at twilight or when daylight becomes too weak. Dipped beam is also activated automatically if the windscreen wipers or rear fog lamps are activated.

With the knob in position  dipped beam is always switched on when the engine is running or when key position **II** is active.

Main beam flash

Move the stalk switch gently towards the steering wheel to the position for main beam flash. Main beam comes on until the stalk switch is released.

Main beam

Main beam can be activated when the knob is in position **AUTO**¹⁹ or . Activate/deactivate main beam by moving the stalk switch towards the steering wheel to the end position and then releasing.

When main beam has been activated the  symbol illuminates in the combined instrument panel.

Auxiliary lamps*

If the car has auxiliary lamps, the driver can use the MY CAR menu system to choose whether they should be deactivated or

¹⁹ When dipped beam is switched on.

* Option/accessory, for more information, see Introduction.



switched on/off simultaneously with the main beam²⁰, see MY CAR (p. 116).

Related information

- Active Xenon headlamps* (p. 95)
- Active main beam* (p. 93)
- Light switches (p. 88)
- Headlamps - adjusting headlamp pattern (p. 100)
- Tunnel detection* (p. 92)

Active main beam*

Active main beam function detects the headlamp beams from oncoming traffic or the rear lights of vehicles in front, and switches the lighting from main beam to dipped beam. The lighting returns to main beam when the incoming light has stopped.

Active main beam - AHB

Active main beam (Active High Beam - AHB) is a function which uses a camera sensor at the top edge of the windscreen to detect the headlamp beams from oncoming traffic or the rear lights of vehicles in front, and then switches from main beam to dipped beam. The function can also take streetlights into account.

The lighting returns to main beam about a second after the camera sensor no longer detects the headlamp beams from oncoming traffic or the rear lights from vehicles in front.

Activating/deactivating

AHB can be activated when the headlamp control's knob is in position **AUTO** (provided that the function has not been deactivated in the menu system MY CAR, see MY CAR (p. 116)).





Stalk switch and knob for headlamp control in **AUTO** position.

The function can start while driving in the dark when the car's speed is 20 km/h or higher.

Activate/deactivate AHB by moving the left-hand stalk switch towards the steering wheel to the end position and then releasing. Deactivation when main beam is on means that the lights are reset directly to dipped beam.

Car with analogue combined instrument panel

When AHB is activated the  symbol illuminates in the instrument's information display.

When main beam is switched on the  symbol also illuminates in the combined instrument panel.

²⁰ Auxiliary lamps must be connected to the electrical system by a workshop. Volvo recommends that you contact an authorised Volvo workshop.



Car with digital combined instrument panel

When AHB is activated the  symbol turns white in the instrument's information display.

When main beam is activated, the symbol turns blue.



Manual operation



NOTE

Keep the windscreen surface in front of the camera sensor free from ice, snow, mist and dirt.

Do not stick or attach anything to the windscreen in front of the camera sensor as this may reduce effectiveness or cause one or more of the systems dependent on the camera to stop working.

If the message **Active main beam Temporary unavailable** Switch manually is shown in the combined instrument panel's information display then you have to switch manually between main and dipped beam. However, the knob for headlamp control can still remain in position **AUTO**. The same applies if the message **Windscreen sensors blocked** See manual and the  symbol are shown. The  symbol goes out when these messages are shown.

AHB may be temporarily unavailable e.g. in situations with dense fog or heavy rain. When AHB becomes available again, or the windscreen sensors are no longer blocked, the message extinguishes and the  symbol illuminates.



WARNING

AHB is an aid for using the optimum beam pattern when conditions are favourable.

The driver always bears responsibility for manually switching between main and dipped beam when traffic situations or weather conditions so require.



IMPORTANT

Examples of when manual switching between main and dipped beam may be required:

- In heavy rain or dense fog
- In freezing rain
- In snow flurries or slush
- In moonlight
- When driving in poorly lit built-up areas
- When the traffic ahead has weak lighting
- If there are pedestrians on or beside the road
- If there are highly reflective objects such as signs in the vicinity of the road
- When the lighting from oncoming traffic is obscured by e.g. a crash barrier
- When there is traffic on connecting roads
- On the brow of a hill or in a hollow
- In sharp bends.

For more information on the limitations of the camera sensor, see Collision warning system* - camera sensor limitations (p. 236).

Related information

- Main/dipped beam (p. 92)
- Light switches (p. 88)



Active Xenon headlamps*

Active Xenon headlamps are designed to provide maximum illumination in bends and junctions and so provide increased safety.

Active Xenon headlamps ABL

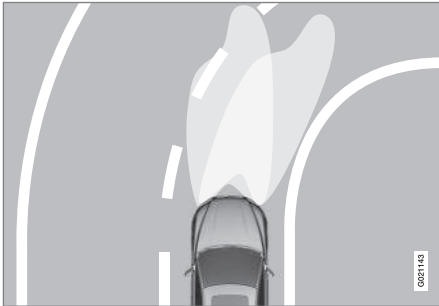

Headlamp pattern with function deactivated (left) and activated (right) respectively.

If the car is equipped with active Xenon headlamps (Active Bending Lights – ABL) the light from the headlamps follows the steering wheel movement in order to provide maximum lighting in bends and junctions and so provide increased safety.

The function is activated automatically when the car is started (provided that it has not been deactivated in the menu system MY CAR, see MY CAR (p. 116)). In the event of a fault in the function the  symbol illu-

minates in the combined instrument panel at the same time as the information display shows an explanatory text and a further illuminated symbol.

Symbol	Message	Specification
	Headlamp system malfunction Service required	The system is disengaged. Visit a workshop if the message remains. Volvo recommends that you contact an authorised Volvo workshop.

The function is only active in twilight or darkness and only when the car is moving.

The function²¹ can be deactivated/activated in the menu system MY CAR, see MY CAR (p. 116).

For headlamp pattern adjustment, see Headlamps - adjusting headlamp pattern (p. 100).

Related information

- Main/dipped beam (p. 92)
- Active main beam* (p. 93)
- Light switches (p. 88)

Rear fog lamp

When visibility is reduced by fog the rear fog lamp can be used so that other road users shall notice vehicles in front at an early stage.

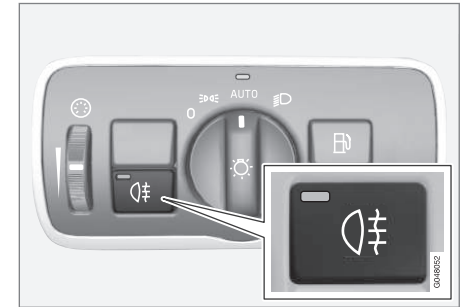

Button for rear fog lamp.

The rear fog lamp can only be switched on when key position II is active or the engine is running and the headlamp control's knob is in position **AUTO** or .

Press the button for On/Off. The rear fog lamp's indicator symbol  in the combined instrument panel and the light in the button both illuminate when the rear fog lamp is switched on.

The rear fog lamp is switched off automatically when the engine is switched off or when

²¹ Activated on delivery from the factory.



the headlamp control's knob is turned to position **0** or **⏏**.



NOTE

Regulations on the use of rear fog lamps vary from country to country.

Related information

- Light switches (p. 88)

Brake lights

The brake light automatically comes on during braking.

The brake light is switched on when the brake pedal is depressed. In addition, it is switched on when one of driving support systems Adaptive cruise control (p. 205), City Safety (p. 223) or Collision warning system (p. 230) brakes the car.

Related information

- Foot brake - emergency brake lights and automatic hazard warning flashers (p. 294)

Hazard warning flashers

The hazard warning flashers warn other road users by means of all of the car's direction indicator lamps flashing simultaneously when this function is activated.

When the hazard warning flashers are activated both direction indicator symbols flash in the combined instrument panel.



Button for hazard warning flashers.

Press the button to activate the hazard warning flashers. Both direction indicator symbols in the combined instrument panel flash when the hazard warning flashers are used.

The hazard warning flashers are activated automatically when the car has been braked so suddenly that the emergency brake lights have been activated at a speed below 10 km/h. The hazard warning flashers remain on when the car has stopped and are deacti-



vated automatically when the car is driven off again or the button is depressed.

Related information

- direction indicators (p. 97)
- Foot brake - emergency brake lights and automatic hazard warning flashers (p. 294)

direction indicators

The car's direction indicators are operated with the left-hand stalk switch. The direction indicator lamps flash three times or continuously, depending on how far up or down the stalk switch is moved.

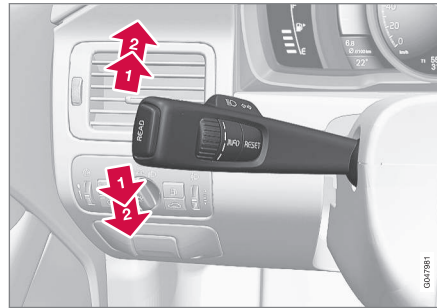

Direction indicators.

Short flash sequence

- 1 Move the stalk switch up or down to the first position and release. The direction indicator lamps flash three times. The function can be activated/deactivated in the menu system MY CAR, see MY CAR (p. 116).

Continuous flash sequence

- 2 Move the stalk switch up or down to the outer position.

The stalk switch remains in its position and is moved back manually, or automatically by the steering wheel movement.

Direction indicator symbols

For direction indicator symbols, see Combined instrument panel - meaning of indicator symbols (p. 70).

Related information

- Hazard warning flashers (p. 96)

Interior lighting

The passenger compartment lighting is activated/deactivated with the buttons in the controls above the front seats and the rear seat.

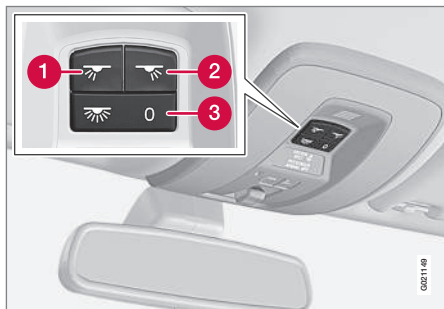

Controls in roof console for the front reading lamps and passenger compartment lighting.

- 1 Reading lamp, left-hand side
- 2 Reading lamp, right-hand side
- 3 Interior lighting

All lighting in the passenger compartment can be switched on and off manually within 30 minutes from when:

- the engine has been switched off and the car's electrical system is in key position **0**
- the car has been unlocked but the engine has not been started.

Front roof lighting

The front reading lamps are switched on or off by pressing the relevant button in the roof console.

Rear roof lighting



Rear roof lighting.

The lamps are switched on or off by pressing each respective button.

Courtesy lighting

Courtesy lighting (and passenger compartment lighting) is switched on and off respectively when a side door is opened or closed.

Glovebox lighting

Glovebox lighting is switched on and off respectively when the lid is opened or closed.

Vanity mirror lighting

The lighting for the vanity mirror (p. 157) is switched on and off respectively when the cover is opened or closed.

Lighting in the cargo area

The lighting in the cargo area is switched on and off respectively when the tailgate is opened or closed.

Automatic lighting

The switch for passenger compartment lighting has three positions for the lighting in the passenger compartment:

- **Off** – right-hand side pressed in, automatic lighting deactivated.
- **Neutral position** – automatic lighting activated.
- **On** – left-hand side pressed in, passenger compartment lighting switched on.

Neutral position

When the button is in neutral position the passenger compartment lighting is switched on and off automatically in accordance with the following.

The passenger compartment lighting is switched on and remains on for 30 seconds if:

- the car is unlocked with the remote control key or key blade, see Remote control key - functions (p. 170) or Detachable key blade - unlocking doors (p. 175)
- the engine has been switched off and the car's electrical system is in key position **0**.



Passenger compartment lighting is switched off when:

- the engine is started
- the car is locked.

The passenger compartment lighting comes on and remains on for two minutes if one of the doors is open.

If any lighting is switched on manually and the car is locked then it will be switched off automatically after two minutes.

Ambience lights*

When the normal passenger compartment lighting is switched off and the engine is running, a number of LEDs illuminate, including one in the ceiling lighting, in order to provide a low-light and enhance the mood while driving. The light also makes it easier to see objects in storage compartments etc. during the darker hours of the day. This lighting goes out for a little while after the normal passenger compartment lighting when the car is locked. The brightness is controlled using the thumbwheel on the headlamp control (p. 88).

Home safe light duration

Home safe lighting consists of dipped beam, parking lamps, lamps in the door mirrors, number plate lighting, interior roof lighting as well as courtesy lighting.

Some of the exterior lighting can be kept switched on to work as home safe lighting after the car has been locked.

1. Remove the remote control key from the ignition switch.
2. Move the left-hand stalk switch toward the steering wheel to the end position and release it. The function can be activated in the same way as with main beam flash; see Main/dipped beam (p. 92).
3. Get out of the car and lock the door.

When the function is activated, dipped beam, parking lamps, door mirror lamps, number plate lighting, interior roof lamps and courtesy lighting are switched on.

The length of time for which the home safe lighting should be kept on can be set in the menu system MY CAR, see MY CAR (p. 116).

Related information

- Approach lighting (p. 99)

Approach lighting

Approach lighting consists of parking lamps, lamps in the door mirrors, number plate lighting, interior roof lighting as well as courtesy lighting.

Approach lighting is switched on with the remote control key, see Remote control key - functions (p. 170), and is used to switch on the car's lighting at a distance.

When the function is activated with the remote control, the parking lamps, door mirror lamps, number plate lighting, interior roof lamps and courtesy lighting are switched on.

The length of time for which the approach lighting should be kept on can be set in the menu system MY CAR, see MY CAR (p. 116).

Related information

- Home safe light duration (p. 99)

Headlamps - adjusting headlamp pattern

The headlamp pattern must be adjusted to avoid dazzling oncoming motorists and can be set for right or left-hand traffic.

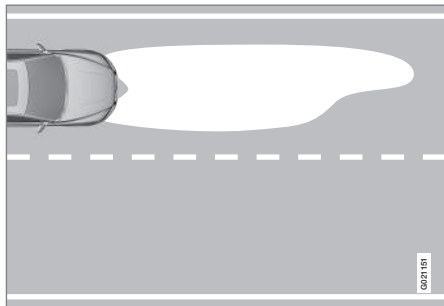

Headlamp pattern, left-hand traffic.

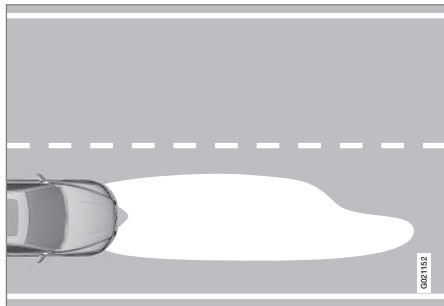

Headlamp pattern, right-hand traffic.

Active Xenon headlamps*

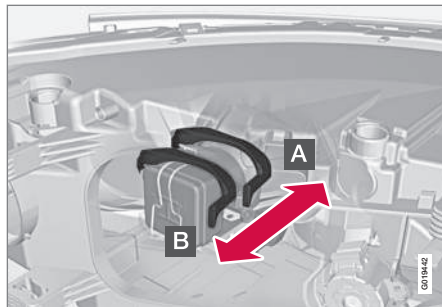

Headlamp control for adjusting headlamp pattern.

- A** Normal position – the headlamp pattern is correct for the country in which the car was delivered.
- B** Adapted position – designed for opposite headlamp pattern.

WARNING

The headlamps must be handled with extreme caution due to the Xenon lamp being supplied by a high-voltage unit.

The country in which the car is delivered determines whether normal position is designed for right or left-hand traffic.

Example 1

If a car that is delivered in Sweden shall be driven in the UK then the headlamps must be

set to the adjusted position, see preceding illustration.

Example 2

A car that is delivered in the UK is designed for left-hand traffic and is driven there with the headlamps in normal position, see preceding illustration.

Halogen headlamps

The headlamp pattern for halogen headlamps is readjusted by masking the headlamp lens. The headlamp pattern may not be as good.



Masking the headlamps

1. Copy the A and B templates for left-hand drive cars or the C and D templates for right-hand drive cars, see later section "Templates for halogen headlamps". The templates have a scale of 1:2. Use a photocopier with a zoom function for example, and copy the templates at 200 %:
 - A = LHD Right (left-hand drive, right lens)
 - B = LHD Left (left-hand drive, left lens)
 - C = RHD Right (right-hand drive, right lens)
 - D = RHD Left (right-hand drive, left lens)
2. Transfer the template to a self-adhesive waterproof material and cut it out.
3. Start from the design line on the headlamp lenses; see the dotted line in the following figure. Position the self-adhesive templates at the right distance from each design line using the illustration and the dimensions in the following list:
 - A = LHD Right - approx. 86 mm
 - B = LHD Left - approx. 40 mm
 - C = RHD Right - 0 mm
 - D = RHD Left - approx. 96 mm



03



Upper row: left-hand drive cars, templates A and B. Lower row: right-hand drive cars, templates C and D.



Templates for halogen headlamps

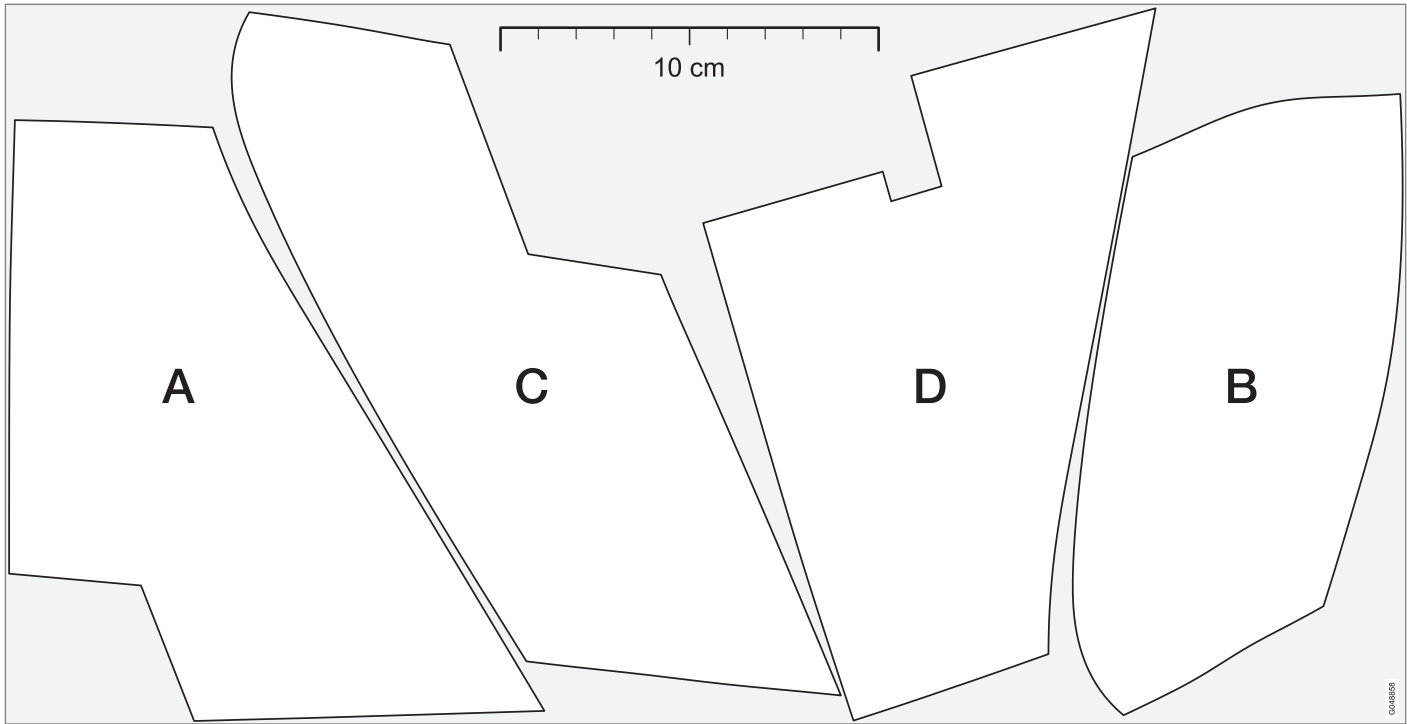

03

Wipers and washers

Wipers and washers clean the windscreen and rear window. The headlamps are cleaned with high-pressure washing.

Windscreen wipers²²



Windscreen wipers and windscreen washers.

- 1** Rain sensor, On/Off
- 2** Thumbwheel sensitivity/frequency

Windscreen wipers off

-  Move the stalk switch to position **0** to switch off the windscreen wipers.



Single sweep

-  Raise the stalk switch and release to make one sweep.

Intermittent wiping

-  Set the number of sweeps per time unit with the thumbwheel when intermittent wiping is selected.

Continuous wiping

-  The wipers sweep at normal speed.
-  The wipers sweep at high speed.

! IMPORTANT

Before activating the wipers during winter ensure that the wiper blades are not frozen in, and that any snow or ice on the windscreen is scraped away.

! IMPORTANT

Use plenty of washer fluid when the wipers are cleaning the windscreen. The windscreen must be wet when the windscreen wipers are operating.

Service position wiper blade

For cleaning the windscreen/wiper blades and replacement of wiper blades, see Car wash (p. 398) and Wiper blades (p. 375).

Rain sensor*

The rain sensor automatically starts the windscreen wipers based on how much water it

detects on the windscreen. The sensitivity of the rain sensor can be adjusted using the thumbwheel.

When the rain sensor is activated a lamp in the button is illuminated and the rain sensor symbol  is shown in the combined instrument panel.

Activating and setting the sensitivity

When activating the rain sensor, the car must be running or the remote control key in position **I** or **II** while the windscreen wiper stalk switch must be in position **0** or in the position for a single sweep.

Activate the rain sensor by pressing the rain sensor button . The windscreen wipers make one sweep.

Press the stalk switch up for the wipers to make an extra sweep.

Turn the thumbwheel upward for higher sensitivity and downward for lower sensitivity. (An extra sweep is made when the thumbwheel is turned upward.)

Deactivate

Deactivate the rain sensor by pressing the rain sensor button  or move the stalk switch down to another wiper program.

²² For replacing the wiper blades and service position wiper blades, see Wiper blades (p. 375). For filling washer fluid, see Washer fluid - filling (p. 377).



The rain sensor is automatically deactivated when the remote control key is removed from the ignition switch or five minutes after the engine has been switched off.

! IMPORTANT

The windscreen wipers could start and be damaged in an automatic car wash. Switch off the rain sensor while the car is in motion or when the remote control key is in position **I** or **II**. The symbol in the combined instrument panel and the lamp in the button go out.

Washing the headlamps and windows



Washing function.

Washing the windscreen

Move the stalk switch toward the steering wheel to start the windscreen and headlamp washers.

The windscreen wipers will make several more sweeps and the headlamps are washed once the stalk switch has been released.

Heated washer nozzles*

The washer nozzles are heated automatically in cold weather to prevent the washer fluid freezing solid.

High-pressure headlamp washing*

High-pressure headlamp washing consumes a large quantity of washer fluid. To save fluid, the headlamps are washed automatically at every fifth windscreen wash cycle.

Reduced washing

If only approx. 1 litre of washer fluid remains in the reservoir and the message that you should fill the washer fluid is shown in the combined instrument panel, then the supply of washer fluid to the headlamps is switched off. This is in order to prioritise cleaning the windscreen and the visibility through it.

Wiping and washing the rear window



- 1** Rear window wiper – intermittent wiping
- 2** Rear window wiper – continuous speed

Press the stalk switch forward (see the arrow in the illustration above) to initiate rear window washing and wiping.

i NOTE

The rear window wiper is equipped with overheating protection which means that the motor is switched off if it overheats. The rear window wiper works again after a cooling period (30 seconds or longer, depending on the heat in the motor and the outside temperature).



Wiper – reversing

Engaging reverse gear while the windscreen wipers are on initiates intermittent rear window wiping²³. The function stops when reverse gear is disengaged.

If the rear window wiper is already on at continuous speed, no change is made.

NOTE

On cars with rain sensors, the rear wiper is activated during reversing if the sensor is activated and it is raining.

Related information

- Washer fluid - filling (p. 377)

Power windows

All power windows can be operated using the control panel for the driver's door - the control panels for the other doors operate their respective power window.



Driver's door control panel.

- 1 Switch for electric child safety locks* and disengaging rear power window buttons; see Child safety locks - electrical activation* (p. 189).
- 2 Rear window controls
- 3 Front window controls

WARNING

Check that children or other passengers are not trapped when the windows are closed from the driver's door.

WARNING

Check that no children or other passengers are trapped if/when the windows are closed using the remote control key.

WARNING

If there are children in the car - remember to always switch off the power supply to the power windows by selecting key position **0** and then take the remote control key with you when leaving the car. For information on key positions - see Key positions - functions at different levels (p. 81).

²³ This function (intermittent wiping when reversing) can be deactivated. Visit a workshop. Volvo recommends an authorised Volvo workshop.



Operating



Operating the power windows.

1 Operating without auto

2 Operating with auto

All power windows can be operated using the control panel for the driver's door - the control panels for the other doors can only each operate their respective power window. Only one control panel can be operated at a time.

In order for the power windows to be used, the key position must be at least I - see Key positions - functions at different levels (p. 81). The power windows can be operated for a few minutes after the engine has been switched off and after the remote control key has been removed - although not after a door has been opened.

Closing of the windows is stopped and the window is opened if anything prevents its

movement. It is possible to force the pinch protection when closing has been interrupted, e.g. with ice, by continuously holding the button up until the window is closed. The pinch protection is reactivated after a brief pause.

i NOTE

One way to reduce the pulsating wind noise when the rear windows are open is to also open the front windows slightly.

Operating without auto

Move one of the controls up/down gently. The power windows move up/down as long as the control is held in position.

Operating with auto

Move one of the controls up/down to the end position and release it. The window runs automatically to its end position.

Operating with the remote control key and central locking

To remotely operate the power windows from the outside with the remote control key or from inside with central locking, see Remote control key (p. 167) and Locking/unlocking - from the inside (p. 183).

Resetting

If the battery is disconnected then the function for automatic opening must be reset so that it can work correctly.

1. Gently raise the front section of the button to raise the window to its end position and hold it there for one second.
2. Release the button briefly.
3. Raise the front section of the button again for one second.

! WARNING

A reset must take place for pinch protection to work.

Door mirrors

The door mirror positions are adjusted with the joystick in the driver's door controls.



Door mirror controls.

Adjusting

1. Press the **L** button for the left-hand door mirror or the **R** button for the right-hand door mirror. The light in the button illuminates.
2. Adjust the position with the joystick in the centre.
3. Press the **L** or **R** button again. The light should no longer be illuminated.

WARNING

Both mirrors are the wide-angle type to provide optimal vision. Objects may appear further away than they actually are.

Storing settings²⁴

The settings for the rearview and door mirrors and the positions of the driver's seat can be stored for each remote control key in the car key memory*, see Remote control key - personalisation* (p. 168).

Angling the door mirror when parking²⁴

The door mirror can be angled down for the driver to view the side of the road when parking for example.

- Engage reverse gear and press the **L** or **R** button.

When reverse gear is disengaged the mirror automatically returns to its original position after approx. 10 seconds, or earlier by pressing the button labelled **L** or **R** respectively.

Automatic angling of the door mirror when parking²⁴

When reverse gear is engaged the door mirror is automatically angled down so that the driver can see the side of the road when parking for example. When reverse gear is disengaged the mirror automatically returns to its original position after a short time.

The function can be activated/deactivated in the menu system MY CAR, see MY CAR (p. 116).

Automatic retraction when locking²⁴

When the car is locked/unlocked with the remote control key the door mirrors are automatically retracted/extended.

The function can be activated/deactivated in the menu system MY CAR, see MY CAR (p. 116).

Resetting to neutral

Mirrors that have been moved out of position by an external force must be reset electrically to the neutral position for electric retracting/extending to work correctly:

1. Retract the mirrors with the **L** and **R** buttons.
2. Fold them out again with the **L** and **R** buttons.
3. Repeat the above procedure as necessary.

The mirrors are now reset in neutral position.

Retractable power door mirrors*

The mirrors can be retracted for parking/driving in narrow spaces:

1. Depress the **L** and **R** buttons simultaneously (key position must be at least I).

²⁴ Only in combination with power seat with memory, see Seats, front - electrically operated* (p. 83).



2. Release them after approximately 1 second. The mirrors automatically stop in the fully retracted position.

Fold out the mirrors by pressing down the **L** and **R** buttons simultaneously. The mirrors automatically stop in the fully extended position.

Home safe and approach lighting

The lamp on the door mirrors illuminates when approach lighting (p. 99) or home safe lighting (p. 99) is selected.

Related information

- Rearview mirror - interior (p. 110)
- Windows and rearview and door mirrors - heating (p. 109)

Windows and rearview and door mirrors - heating

The defroster is used to quickly remove misting and ice from the windscreen, rear window and door mirrors.

Heated windscreen*, rear window and door mirrors

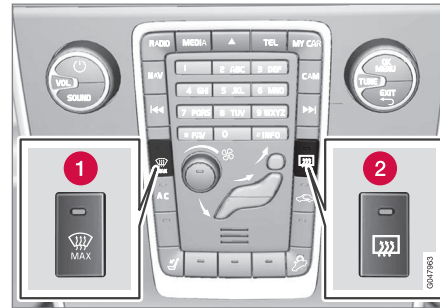

- 1 Heating, windscreen
- 2 Heating, rear window and door mirrors

The function is used to remove ice and misting from the windscreen, rear window and door mirrors.

One press of the respective button starts the heating. The light in the button indicates that the function is active. Switch off the heating as soon as the ice/misting is cleared in order not to load the battery unnecessarily. However, the function is switched off automatically after a certain time.

See also Demisting and defrosting the windscreen (p. 140).

The door mirrors and rear window are demisted/defrosted automatically if the car is started in an outside temperature lower than +7 °C. Automatic defrosting can be selected in the menu system MY CAR, see MY CAR (p. 116).



Rearview mirror - interior

The interior rearview mirror can be dimmed with a control in the mirror's lower edge. Alternatively, the rearview mirror dims automatically.



1 Control for dimming

Manual dimming

Bright light from behind could be reflected in the rearview mirror and dazzle the driver. Use dimming with the dimming control when lights from behind are distracting:

1. Use dimming by moving the control in towards the passenger compartment.
2. Return to normal position by moving the control towards the windscreen.

Automatic dimming*

Bright light from behind is automatically dimmed by the rearview mirror. The control

for manual dimming is not available on mirrors with automatic dimming.

The rearview mirror contains two sensors - one forward facing and one rearward facing - that work together to identify and eliminate dazzling light. The forward facing sensor detects ambient light, while the rearward facing sensor detects the light from vehicle headlights behind.

NOTE

If the sensors are obscured by e.g. parking permits, transponders, sun visors or objects in the seats or in the cargo area in such a way that light is prevented from reaching the sensors, then the dimming function of the rearview mirror is reduced.

Only rearview mirror with automatic dimming can be equipped with compass (p. 110).

Related information

- Door mirrors (p. 108)

Compass*

The upper right-hand corner of the rearview mirror contains a display that shows the compass direction in which the front of the car is pointing.

Operation



Rearview mirror with compass.

Eight different directions are shown with English abbreviations: **N** (north), **NE** (north east), **E** (east), **SE** (south east), **S** (south), **SW** (south west), **W** (west) and **NW** (north west).

The compass is activated automatically when the car is started or when key position II is active, see Key positions - functions at different levels (p. 81). To deactivate/activate the compass - press in the button on the underside of the mirror using a paper clip for example.



Calibration

The compass may need calibrating to show the correct compass direction.

The earth is divided into 15 magnetic zones. The compass should be calibrated if the car is moved across several magnetic zones.

Proceed as follows to perform calibration:

1. Stop the car in a large open area free from steel structures and high-voltage power lines.
2. Start the car and switch off all electrical equipment (air conditioning, wipers, etc.) and ensure that all doors are closed.

i NOTE

Calibration may fail or not start at all if electrical equipment is not switched off.

3. Hold the button on the underside of the rearview mirror depressed (use a paper clip or similar) for approx. 3 seconds. The number of the current magnetic zone is shown.

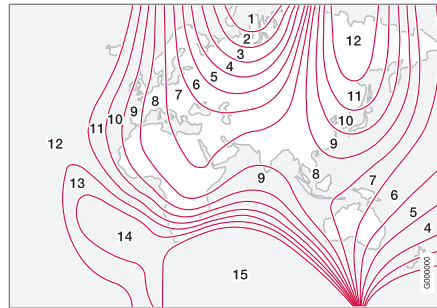

Magnetic zones.

4. Press the button repeatedly until the required magnetic zone (1–15) is shown. See the map of magnetic zones for the compass.
5. Wait until the display returns to showing the character **C**, or hold the button on the underside of the rearview mirror depressed for approx. 6 seconds until the character **C** is shown.
6. Drive slowly in a circle at a speed of no more than 10 km/h until a compass direction is shown in the display, indicating that calibration is complete. Then drive a further 2 circles to fine-tune calibration.

7. **Cars with heated windscreen***: If the character **C** is shown in the display when the heated windscreen is activated, perform the calibration in accordance with point 6 above with the heated windscreen activated, see Demisting and defrosting the windscreen (p. 140).
8. Repeat the above procedure as necessary.

Sunroof*

The sunroof can be operated with a control in the roof panel.

The sunroof's inner sunshade is closed manually.

The sunroof has a wind deflector.

The sunroof controls are located in the roof panel. The sunroof can be opened vertically at the rear edge and horizontally. Key position **I** or **II** is required for the sunroof to be opened.

Horizontal opening

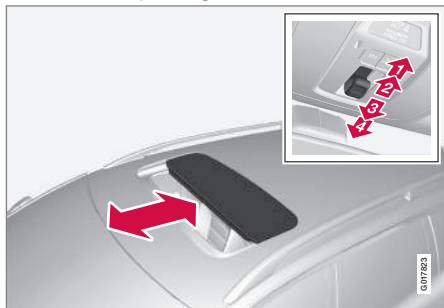

Horizontal opening, backward/forward.

- 1** Opening, automatic
- 2** Opening, manual
- 3** Closing, manual
- 4** Closing, automatic

Opening

For maximum sunroof opening, move the control back to the position for automatic opening and release.

Open manually by pulling the control backwards to the point of resistance for manual opening. The sunroof moves to maximum open position as long as the button is kept depressed.

Closing

Close manually by pushing the control forwards to the point of resistance for manual closing. The sunroof moves to closed position as long as the button is kept depressed.

WARNING

Risk of crushing when the sunroof is closed. The sunroof's pinch-protection function only operates during automatic closing, not manual.

Close automatically by pressing the control to the position for automatic closing and then release it.

The power supply to the sunroof is switched off by selecting key position **0** and removing the remote control key from the ignition switch.

WARNING

If there are children in the car:

Remember to always switch off the power supply to the sunroof by selecting key position **0** and then take the remote control key with you when leaving the car. For information on key positions - see Key positions - functions at different levels (p. 81).

Vertical opening

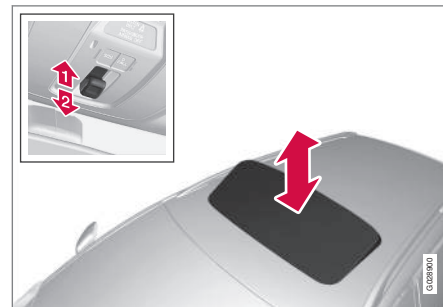

Vertical opening, raised at the rear edge.

- 1** Open by pressing the rear edge of the control upward.
- 2** Close by pulling the rear edge of the control down.



Closing using the remote control key or central locking button

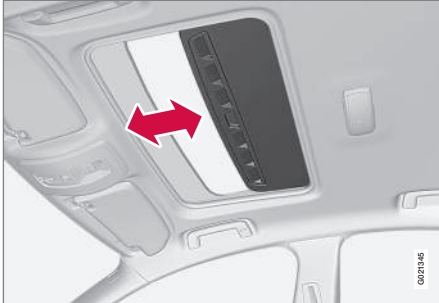

One long press on the lock button closes the sunroof and all the windows, see Remote control key - functions (p. 170) and Locking/unlocking - from the inside (p. 183). The doors and the tailgate are locked. To interrupt closing, press the lock button again.

WARNING

If the sunroof is closed with the remote control key, check that no one risks being trapped.

Sunscreen

The sunroof features a manual, sliding interior sunscreen. The sunscreen slides back automatically when the sunroof is opened. Grip the handle and slide the screen forward to close it.

Pinch protection

The sunroof's pinch protection function is triggered if it is blocked by an object during automatic closing. If blocked, the sunroof will stop and automatically open to the previous position.

Wind deflector



The sunroof has a wind deflector that is folded up when the sunroof is in the open position.

Menu navigation - combined instrument panel

The left-hand stalk controls the menus (p. 114) shown on the information display in the combined instrument panel (p. 65). Which menus are shown depends on the key position (p. 81).

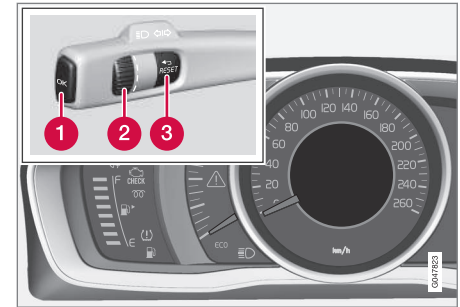

Display (analogue combined instrument panel) and controls for menu navigation.

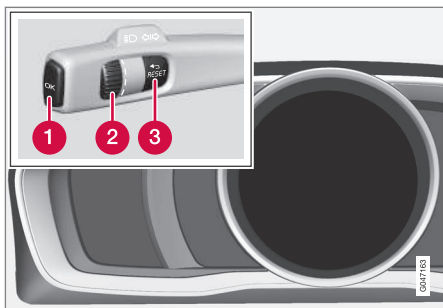

Display (digital combined instrument panel) and controls for menu navigation.

- 1 **OK** – access to message list and message confirmation.
- 2 **Thumbwheel** – browse between menu options.
- 3 **RESET** – reset the active function. Used in certain cases to select/activate a function, see the explanation under each respective function.

If there is a message (p. 115) then it must be acknowledged with **OK** in order that the menus shall be shown.

Related information

- Messages - handling (p. 116)

Menu overview - combined instrument panel

Which menus are shown in the combined instrument panel's information display depends on the key position (p. 81).

Some of the following menu options require the function and hardware to be installed in the car.

Analogue combined instrument panel Digital speed

Parking heater*

Additional heater*

TC options

Service status

Oil level²⁵

Messages (##)²⁶

Digital combined instrument panel Settings*

Themes

Contrast mode/Colour mode

Service status

Messages²⁶

Oil level²⁵

Parking heater*

Trip computer reset

Related information

- Analogue combined instrument panel - overview (p. 65)
- Digital combined instrument panel - overview (p. 66)
- Menu navigation - combined instrument panel (p. 113)

²⁵ Certain engines.

²⁶ The number of messages is indicated in brackets.



Messages

When a warning, information or indicator symbol illuminates, a corresponding message appears on the information display.

Message	Specification
Stop safely^A	Stop and switch off the engine. Serious risk of damage - consult a workshop ^B .
Stop engine^A	Stop and switch off the engine. Serious risk of damage - consult a workshop ^B .
Service urgent^A	Contact a workshop ^B to check the car immediately.
Service required^A	Contact a workshop ^B to check the car as soon as possible.
See manual^A	Read the owner's manual.
Book time for maintenance	Time to book regular service - contact a workshop ^B .

Message	Specification
Time for regular maintenance	Time for regular service - contact a workshop ^B . The timing is determined by the number of kilometres driven, number of months since the last service, engine running time and oil grade.
Maintenance overdue	If the service intervals are not followed then the warranty does not cover any damaged parts - contact a workshop ^B .
Transmission Oil change needed	Contact a workshop ^B to check the car as soon as possible.
Transmission Reduced performance	The gearbox cannot handle full capacity. Drive carefully until the message clears ^C . If shown repeatedly - contact a workshop ^B .
Transmission hot Reduce speed	Drive more smoothly or stop the car in a safe manner. Disengage the gear and run the engine at idling speed until the message clears ^C .

Message	Specification
Transmission hot Stop safely Wait for cooling	Critical fault. Stop the car immediately in a safe manner and contact a workshop ^B .
Temporarily off^A	A function has been temporarily switched off and is reset automatically while driving or after starting again.
Low battery charge Power save mode	The audio system is switched off to save energy. Charge the battery.

^A Part of message, shown together with information on where the problem has arisen.

^B An authorised Volvo workshop is recommended.

^C For more information regarding the automatic gearbox, see Automatic gearbox -- Geartronic* (p. 273).

Related information

- Messages - handling (p. 116)
- Menu navigation - combined instrument panel (p. 113)



Messages - handling

Use the left-hand stalk switch to acknowledge and browse among messages (p. 115) that are shown in the information display of the combined instrument panel.

When a warning, information or indicator symbol illuminates, a corresponding message appears in the display at the same time. An error message is stored in a memory list until the fault has been rectified.

Press **OK** on the left-hand stalk switch to acknowledge a message. Scroll through messages with the thumbwheel (p. 113).

i NOTE

If a warning message appears while you are using the trip computer, the message must be read (press **OK**) before the previous activity can be resumed.

Related information

- Menu overview - combined instrument panel (p. 114)

MY CAR

MY CAR is a menu source that handles many of the car's functions, e.g. City Safety™, locks and alarm, automatic fan speed, setting the clock, etc.

Certain functions are standard, others are optional - the range also varies depending on the market.

Operation

Navigation in the menus is carried out using buttons in the centre console or with the steering wheel's right-hand keypad*.

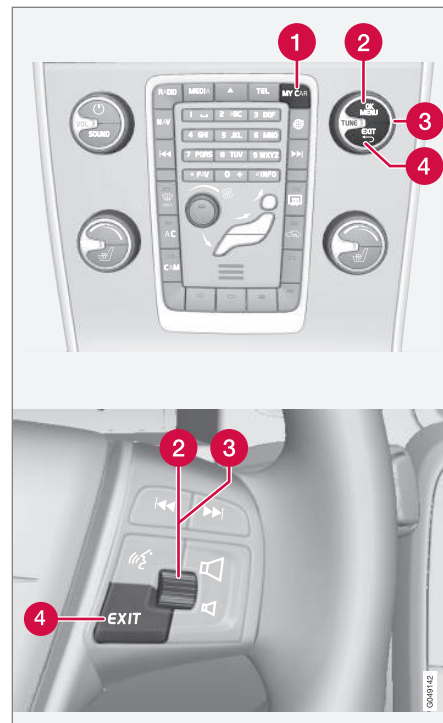

Control panel in centre console and steering wheel keypad. The figure is schematic - the number of functions and layout of the buttons both



vary, depending on the equipment selected and the market.

- 1 **MY CAR** - opens the menu system MY CAR.
- 2 **OK/MENU** - press the button in the centre console or the thumbwheel on the steering wheel to select/tick in the highlighted menu option or store the selected function in the memory.
- 3 **TUNE** - turn the knob in the centre console or the thumbwheel on the steering wheel to scroll up/down through the menu options.
- 4 **EXIT**

EXIT functions

Depending on the function the cursor is on when **EXIT** is depressed briefly, and on which menu level, one of the following may occur:

- phone call is rejected
- current function is interrupted
- input characters are deleted
- most recent selections are undone
- leads up in the menu system.

A long press on **EXIT** leads to the normal view for MY CAR or if you are in the normal view, to the highest menu level (main source menu).

Menu options and search paths

For a description of the menu options and search paths in MY CAR, see the Sensus Infotainment supplement.

Trip computer

The car's trip computer can record, calculate and show information while driving.

Trip computer content and appearance varies depending on whether the combined instrument panel is analogue or digital:

- Trip computer - analogue combined instrument panel (p. 119)
- Trip computer - digital combined instrument panel (p. 123)

Checking and settings of the trip computer can be made immediately after the combined instrument panel is automatically illuminated in connection with unlocking. If none of the trip computer's controls are actuated within approx. 30 seconds after the driver's door has been opened then the instrument extinguishes, after which either key position II (p. 81) or starting the engine is required in order to operate the trip computer.

NOTE

If a warning message appears when the trip computer is used then the message must first be acknowledged before the trip computer can be reactivated.

- Acknowledge the message by briefly pressing the indicator stalk **OK** button.



Group menus

The trip computer has two different group menus:

- Functions
- Heading in combined instrument panel

The trip computer's **functions** or **headings** are each listed in an infinite loop.

Related information

- Trip computer - trip statistics* (p. 128)
- Trip computer - supplementary information (p. 127)



Trip computer - analogue combined instrument panel

The trip computer's menu is in a variable loop. One of the alternatives is that the trip computer's display extinguishes - this also marks the start/end of the loop.

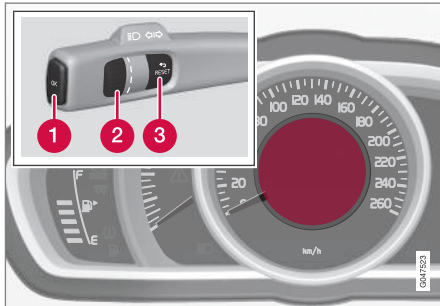

Information display and controls.

- 1 **OK** - Opens the loop with the trip computer's functions + Activates the selected option.
- 2 **Thumbwheel** - Opens the loop with the trip computer's headings + Scrolls through the options.
- 3 **RESET** - Undoes, zeroes or backs out of a function after making a selection.

Functions

Proceed as follows to open and check/adjust functions:

1. To ensure that no control is in the middle of a sequence - "Reset" them first with two presses on **RESET**.
2. Press **OK** - the loop with all functions opens.
3. Browse through the functions with the **thumbwheel** and select/confirm with **OK**.
4. Finish by pressing twice on **RESET** after completed checking/adjustment.

The different functions of the trip computer are listed in the following table:



03 Instruments and controls



Functions	Information
Digital speed <ul style="list-style-type: none"> • km/h • mph • No display 	<p>Shows the car's speed digitally in the centre of the combined instrument panel:</p> <ul style="list-style-type: none"> • Open with OK, select with the thumbwheel, confirm with OK and back out with RESET.
Parking heater* <ul style="list-style-type: none"> • DIRECT START • - Timer 1 - leads to the menu for selecting time. • - Timer 2 - leads to the menu for selecting time. 	<p>For a description of programming the timer, see Engine block heater and passenger compartment heater* - timer (p. 147).</p>
Additional heater* <ul style="list-style-type: none"> • Auto On • Off 	<p>For more information, see Additional heater* (p. 151).</p>
TC options <ul style="list-style-type: none"> • Distance to empty tank • Fuel consumption • Average speed • Trip meter T1 and total dist. • Trip meter T2 and total dist. 	<p>Here you can select/activate the options that you want to be available as selectable headings in the trip computer. The symbols for the items already selected are WHITE with a "tick" - others are GREY and have no "tick":</p> <ol style="list-style-type: none"> 1. Open the function with OK, scroll through the symbols for the options with the thumbwheel and select/stop on the desired symbol. 2. Confirm with OK - the symbol changes colour from GREY to WHITE and is marked with a "tick". 3. Continue to select the function symbols with the thumbwheel or finish with RESET.
Service status	<p>Shows the number of months and mileage to next service.</p>

03



Functions	Information
Oil level ^A	For more information, see Engine oil - checking and filling (p. 363).
Messages (##)	For more information, see Messages - handling (p. 116).

^A Certain engines.

Headings

One of the headings in the following table can be selected for constant display in the combined instrument panel. Proceed as follows to determine which:

1. To ensure that no control is in the middle of a sequence - "Reset" them first with two presses on **RESET**.
2. Turn the **thumbwheel** - selectable headings for the trip computer are shown in a loop.
3. Stop on desired heading.

Trip computer heading in combined instrument panel	Information
Trip meter T1 and total dist.	<ul style="list-style-type: none"> • Long press on RESET resets trip meter T1.
Trip meter T2 and total dist.	<ul style="list-style-type: none"> • Long press on RESET resets trip meter T2.
Distance to empty	For more information - see the section "Range - distance to empty tank" (p. 127).
Fuel consumption	Current consumption.
Average speed	<ul style="list-style-type: none"> • Long press on RESET resets Average speed.
No trip computer information.	This option shows a blank display - it also marks the beginning/end of the loop.

The combined instrument panel's trip computer can be changed to another option at any time during the journey. Proceed as follows:

- Turn the **thumbwheel** - stop on the desired heading.

Resetting - Trip meter and Average speed

With the current trip computer heading - **T1 and total dist., T2 and total dist.** or



03 Instruments and controls



Average speed - shown in the combined instrument panel:

- Give a long press on **RESET** - selected heading is zeroed.

Each heading must be zeroed individually.

Related information

- Trip computer (p. 117)
- Trip computer - supplementary information (p. 127)
- Trip computer - trip statistics* (p. 128)



Trip computer - digital combined instrument panel

The trip computer's menu is in a variable loop. One of the alternatives is that the trip computer's three displays extinguish - this also marks the start/end of the loop.

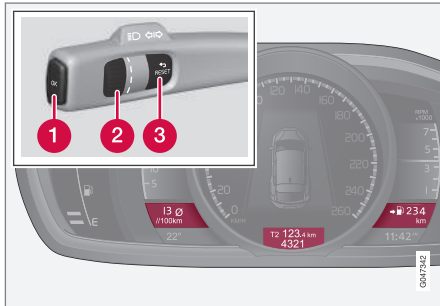

Information displays and stalk switch controls.

- 1 **OK** - Opens the loop with the trip computer's functions + Activates the selected option.
- 2 **Thumbwheel** - Opens the loop with the trip computer's headings + Scrolls through the options.
- 3 **RESET** - Undoes, zeroes or backs out of a function after making a selection.

Functions

Proceed as follows to open and check/adjust functions:

1. To ensure that no control is in the middle of a sequence - "Reset" them first with two presses on **RESET**.
2. Press **OK** - loop with all functions opens.
3. Browse through the functions with the **thumbwheel** and select/confirm with **OK**.
4. Finish by pressing twice on **RESET** after completed checking/adjustment.

The different functions of the trip computer are listed in the following table:



03 Instruments and controls



Functions	Information
Trip computer reset <ul style="list-style-type: none"> • Average • Average speed 	Note that this function does not reset both trip meters T1 and T2 - see table under next section "Headings" and section "Resetting - Average speed/consumption" for information on the process.
Messages	For more information, see Messages - handling (p. 116).
Themes	The appearance of the combined instrument panel (p. 65) is selected here.
Settings*	Select Auto On or Off . For more information, see Additional heater* (p. 151).
Contrast mode/Colour mode	Adjusting the combined instrument panel's brightness and colour intensity.
Parking heater* <ul style="list-style-type: none"> • Direct start • - Symbol Timer 1 - leads to the menu for selecting time. • - Symbol Timer 2 - leads to the menu for selecting time. 	For a description of programming the timer, see Engine block heater and passenger compartment heater* - timer (p. 147).
Service status	Shows the number of months and mileage to next service.
Oil level^A	For more information, see Engine oil - checking and filling (p. 363).

^A Certain engines.

03



Headings

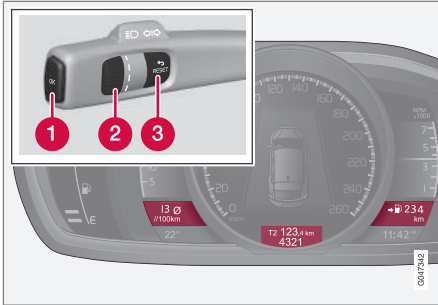

Three trip computer headings can be displayed simultaneously - one in each "window".

One of the heading combinations in the following table can be selected for constant display in the combined instrument panel. Proceed as follows to determine which:

1. To ensure that no control is in the middle of a sequence - "Reset" them first with two presses on **RESET**.
2. Turn the **thumbwheel** - selectable heading combinations are shown in a loop.
3. Stop on desired heading combination.

03

Heading combinations			Information
Average	Trip meter T1 + Meter reading	Average speed	<ul style="list-style-type: none"> Long press on RESET resets trip meter T1.
Instantaneous	Trip meter T2 + Meter reading	Distance to empty tank	<ul style="list-style-type: none"> Long press on RESET resets trip meter T2.
Instantaneous	Meter reading	kmh<>mph	kmh<>mph - see section "Digital speed display" (p. 127).
	No trip computer information.		This option extinguishes all three trip computer displays - it also marks the beginning/end of the loop.

The combined instrument panel's heading combination for the trip computer can be changed to another option at any time during the journey. Proceed as follows:

- Turn the **thumbwheel** - stop on the desired heading.

Resetting - Trip meter

Turn with the **thumbwheel** to the heading combination containing the trip meter to be reset:

- Give a long press on **RESET** - selected trip meter is zeroed.



Resetting - Average speed/ consumption

1. Select function **Trip computer reset** and activate with **OK**.
2. Select one of the following options with the **thumbwheel** and activate with **OK**:
 - l/100 km
 - km/h
 - Reset both
3. Finish with **RESET**.

Related information

- Trip computer - supplementary information (p. 127)
- Trip computer - trip statistics* (p. 128)



Trip computer - supplementary information

Supplementary information covering several functions follows below.

Average

Average fuel consumption is calculated from the last resetting.

NOTE

There may be a slight deviation if a fuel-driven heater* has been used.

Applies to Bi-Fuel* cars

During gas operation the trip computer shows the equivalent average consumption of gas.

Average speed

The average speed is calculated for the driving distance driven since the last reset to zero.

Instantaneous

The information for current fuel consumption is updated continuously - approximately once per second. When the car is driven at low speed the consumption is shown per time unit - at a higher speed it is shown related to mileage.

Different units (km/miles) can be selected for the display - see section "Change unit" (p. 127).

Applies to Bi-Fuel* cars

During gas operation the trip computer shows the equivalent consumption of gas.

Range - distance to empty tank

The trip computer shows the approximate distance that can be driven with the fuel quantity remaining in the tank.

No guaranteed range remains when the heading **Distance to empty** shows "----".

- In which case, refuel as soon as possible.

The calculation is based on the average fuel consumption over the last 30 km and the remaining driveable fuel quantity.

NOTE

There may be a slight deviation if the driving style has been changed.

An economic driving style generally results in a longer driving distance. For more information on how fuel consumption can be influenced, see Volvo Car Corporation 's Environmental Philosophy (p. 22).

Applies to Bi-Fuel* cars

NOTE

Display of distance to empty only applies to the petrol tank.

Digital speed display²⁷

The speed is shown in the opposite unit (kmh/mph) in relation to the main instrument. If it is calibrated in mph then the trip computer shows the corresponding speed in km/h and vice versa.

Change unit

You can change unit (km/miles) for distance and speed in the menu system MY CAR, see MY CAR (p. 116).

NOTE

In addition to in the trip computer, these units are also changed in Volvo's navigation system*.

Related information

- Trip computer - trip statistics* (p. 128)

²⁷ Only with combined instrument panel "Digital".

Trip computer - trip statistics*

Information is stored about completed trips containing average fuel consumption and average speed, which can be viewed in the centre console's screen as a bar chart.

Function

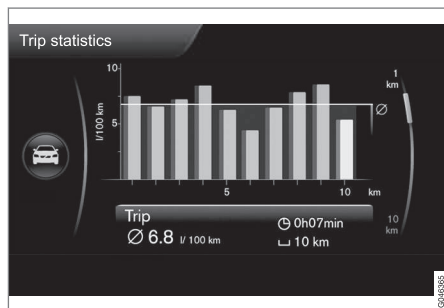

Trip statistics²⁸

Each bar symbolises 1 km or 10 km driven distance, depending on the scale selected - the bar at the far right shows the value for the current kilometre or 10 km.

Using the **TUNE** control, the scale for the bars can be changed between 1 km and 10 km - the cursor on the far right changes position between up and down in relation to the scale selected.

Operation

Different settings can be made in the menu system **MY CAR**, see MY CAR (p. 116) - there, find **Trip statistics**.

With the "**Reset when vehicle has been off for minimum 4h**" option highlighted, all statistics are deleted automatically once driving is complete and the car has been stopped for 4 hours. Trip statistics start again from zero the next time the engine is started.

- **Reset when vehicle has been off for minimum 4h** - highlight the box by selecting **ENTER** and go back out of the menu by selecting **EXIT**.

If a new driving cycle is started before 4 hours have elapsed then the current period must first be deleted manually using the "**Start new trip**" option.

- **Start new trip - ENTER** is used to delete all previous statistics, go back out of the menu by selecting **EXIT**.

See also information on Eco guide (p. 69).

Related information

- Trip computer - supplementary information (p. 127)

²⁸ The figure is schematic - layout may vary depending on car model or updated software.

04

CLIMATE CONTROL





04 Climate control

General information on climate control

The car is equipped with electronic climate control (p. 136). The climate control system cools or heats as well as dehumidifies the air in the passenger compartment.

NOTE

Air conditioning (AC) (p. 140) can be switched off, but to ensure the best possible climate comfort in the passenger compartment, and to prevent the windows from misting, it should always be switched on.

To bear in mind

- To ensure that the air conditioning works optimally, the side windows, and sunroof should be closed.
- Global opening (p. 184) opens/closes all side windows simultaneously and can be used for example to quickly air the car during hot weather.
- Remove ice and snow from the climate control system air intake (the grille between the bonnet and the windscreen).
- In warm weather, condensation from the air conditioning may drip under the car. This is normal.
- When the engine requires full power, e.g. for full acceleration, the air conditioning can be temporarily switched off. There

may then be a temporary increase in temperature in the passenger compartment.

- Remove misting on the insides of the windows primarily by using the defroster function (p. 140). To reduce the risk of misting, keep the windows clean and use window cleaner.

Cars with Start/Stop*

With an auto-stopped (p. 281) engine certain equipment may have its function temporarily reduced, e.g. climate control fan speed (p. 139).

Cars with ECO*

Certain equipment may have its function temporarily reduced or deactivated when the ECO (p. 290) function is activated, e.g. the air conditioning (p. 140).

NOTE

When the ECO function is activated, several parameters in the climate control system's settings are changed, and several electricity consumer functions are reduced. Certain settings can be reset manually, but full functionality is only restored by deactivating the ECO function.

Related information

- Actual temperature (p. 131)
- Menu settings - climate control (p. 133)
- Electronic climate control - ECC (p. 136)

- Air distribution in the passenger compartment (p. 134)
- Air quality (p. 131)



Actual temperature

The temperature you select in the passenger compartment corresponds to the physical experience with reference to factors such as ambient temperature, air speed, humidity and solar radiation etc. in and around the car at the time.

The system includes a sun sensor (p. 131) which detects on which side the sun is shining into the passenger compartment. This means that the temperature can differ between the right and left-hand air vents despite the controls being set for the same temperature on both sides.

Related information

- General information on climate control (p. 130)
- Temperature control in the passenger compartment (p. 139)

Sensors - climate control

The climate control system has a number of sensors to help control the temperature (p. 131) in the car.

- The sun sensor is located on the top side of the dashboard.
- The temperature sensor for the passenger compartment is located below the climate control panel.
- The outside temperature sensor is located in the door mirror.
- The humidity sensor* is located by the interior rearview mirror.



NOTE

Do not cover or block the sensors with clothing or other objects.

Related information

- General information on climate control (p. 130)

Air quality

The interior in a passenger compartment is designed to be pleasant and comfortable, even for people with contact allergies and for asthma sufferers.

- Passenger compartment filter (p. 132)
- Material in the passenger compartment (p. 133)
- Clean Zone Interior Package (CZIP) (p. 132)*
- Interior Air Quality System (IAQS) (p. 133)*

Related information

- General information on climate control (p. 130)



Air quality - passenger compartment filter

All air entering the car's passenger compartment is cleaned with a filter.

The filter must be replaced at regular intervals. Follow the Volvo Service Programme for the recommended replacement intervals. If the car is used in a severely contaminated environment, it may be necessary to replace the filter more often.

NOTE

There are different types of passenger compartment filter. Make sure that the correct filter is fitted.

Related information

- Air quality (p. 131)

Air quality - Clean Zone Interior Package (CZIP)*

CZIP comprises a series of modifications that keep the passenger compartment even clearer from allergy and asthma-inducing substances.

The following is included:

- An enhanced fan function that means that the fan starts when the car is opened with the remote control key. The fan fills the passenger compartment with fresh air. The function starts when required and is disengaged automatically after a time or when one of the passenger compartment doors is opened. The amount of time the fan runs is reduced gradually due to reduced need up until the car is 4 years old.
- The air quality system IAQS (p. 133) is a fully automatic system that cleans the air in the passenger compartment from contaminants such as particles, hydrocarbons, nitrous oxides and ground-level ozone.

NOTE

To keep the CZIP standard in cars with CZIP the IAQS filter must be changed after 15 000 km or once per year depending on whichever occurs first. However, up to 75 000 km over 5 years. In cars without CZIP and where the customer does not want to keep the CZIP standard the IAQS filter must be changed at a regular service.

For more information on CZIP, see the brochure included with the purchase of the car.

Related information

- General information on climate control (p. 130)
- Air quality (p. 131)



Air quality - IAQS*

The air quality system IAQS separates gases and particles to reduce the levels of odours and pollution in the passenger compartment.

If the outside air is contaminated then the air intake is closed and the air is recirculated.

It is possible to activate/deactivate the function in the menu system MY CAR. For a description of the menu system, see MY CAR (p. 116).

NOTE

The air quality sensor must always be enabled to ensure the best air in the passenger compartment.

In a cold climate recirculation is limited so as to prevent misting.

In the event of misting, the air quality sensor should be disengaged, and the defroster functions for the windscreen and side windows, as well as the rear window, should be used.

Related information

- General information on climate control (p. 130)
- Air quality (p. 131)
- Air quality - Clean Zone Interior Package (CZIP)* (p. 132)

Air quality - material

Tested materials have been developed in order to minimise the quantity of dust in the passenger compartment and to contribute to making the passenger compartment easier to keep clean.

The carpets in both the passenger compartment and the cargo area are removable and easy to remove and clean. Use cleaning agents and car care products recommended by Volvo to clean the interior (p. 401).

Related information

- Air quality (p. 131)

Menu settings - climate control

It is possible to activate/deactivate or change the default settings for six of the climate control system's functions via the centre console.

- Fan level during automatic climate control (p. 139).
- Recirculation timer (p. 141).
- Automatic start of rear window defroster (p. 109).
- Interior air quality system* (p. 133).
- Automatic start of seat heating driver (p. 137).
- Automatic start of steering wheel heating (p. 88).

More information is available in the description of the menu system (p. 116).

The climate control system's functions can be reset in the menu system MY CAR to the default settings. For a description of the menu system, see MY CAR (p. 116).

Related information

- General information on climate control (p. 130)



04 Climate control

Air distribution in the passenger compartment

The incoming air is divided between a number of different vents in the passenger compartment.

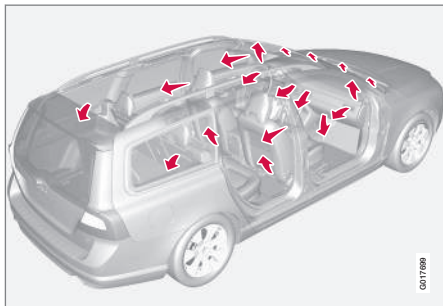

Air distribution is fully automatic in **AUTO** mode.

If necessary it can be controlled manually; see the air distribution table (p. 143).

Air vents in the dashboard

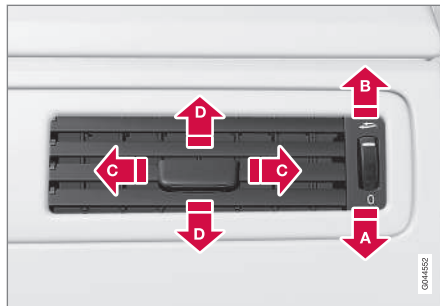

- A** Closed
- B** Open
- C** Lateral airflow
- D** Vertical airflow

Aim the outer vents at the side windows to remove misting.

Air vents in the door pillars

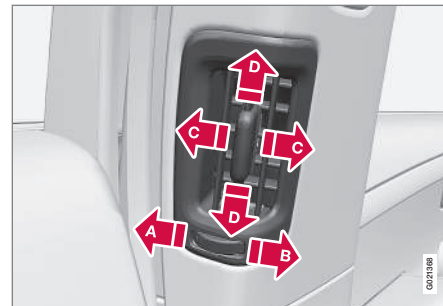

- A** Closed
- B** Open
- C** Lateral airflow
- D** Vertical airflow

Aim the vents at the windows to remove misting in cold weather.

Aim the vents into the passenger compartment to maintain a comfortable climate in the rear seat in hot weather.

i NOTE

Remember that small children may be sensitive to air flows and draughts.



Air distribution

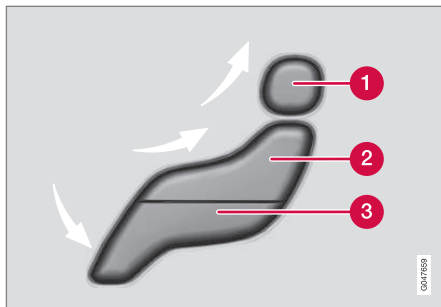

- ❶ Air distribution - defroster/windscreen
- ❷ Air distribution - air vent instrument panel
- ❸ Air distribution - ventilation floor

The figure consists of three buttons. When pressing the buttons the corresponding figure is illuminated in the screen (see following figure) and an arrow in front of each part of the figure shows the air distribution that is selected. For more information, see the air distribution table (p. 143).



The selected air distribution is shown in the centre console display screen.

Related information

- General information on climate control (p. 130)
- Auto-regulation (p. 139)
- Air distribution - recirculation (p. 141)



04 Climate control

Electronic climate control - ECC

ECC (Electronic Climate Control) maintains the temperature selected in the passenger

compartment and can be set separately for the driver's side and passenger side.

The auto function is used to automatically control temperature, air conditioning, fan speed, recirculation and air distribution.

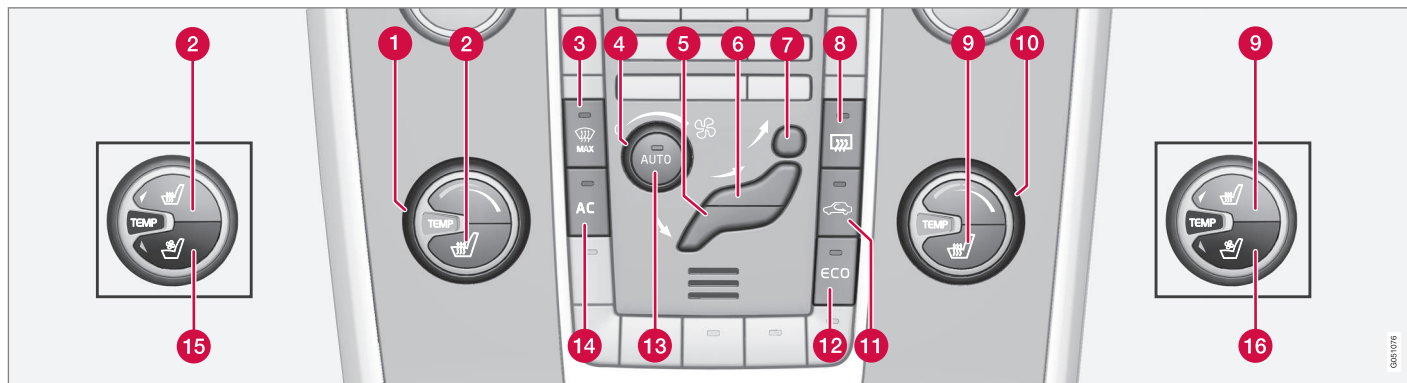

- 1 Temperature control (p. 139), left-hand side
- 2 Electrically heated front seat (p. 137) , left side¹
- 3 Heated windscreen* and max. defroster (p. 140)
- 4 Fan (p. 139)
- 5 Air distribution (p. 134) - ventilation floor
- 6 Air distribution - air vent instrument panel
- 7 Air distribution - defroster windscreen

- 8 Rear window and door mirror defrosters (p. 109)
- 9 Electrically heated front seat (p. 137), right-hand side¹
- 10 Temperature control (p. 139), right-hand side
- 11 Recirculation (p. 141)
- 12 ECO* (p. 290)
- 13 **AUTO** - Automatic climate control (p. 139)

- 14 **AC** - Air conditioning on/off (p. 140)
- 15 Ventilated front seat (p. 138)*, left-hand side
- 16 Ventilated front seat*, right-hand side

Related information

- General information on climate control (p. 130)

¹ The button has a different location depending on whether or not the car is equipped with ventilated front seat*.



Heated front seats*

The front seat heating has three positions for increasing the comfort for driver and passenger when it is cold.

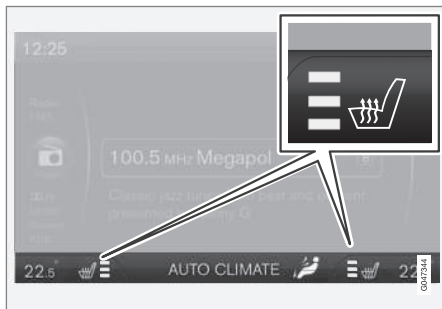

Current heat level is shown in the centre console display screen.



The button has a different location depending on whether or not the car is equipped with ventilated front seat*, see illustration (p. 136).

Press the button repeatedly in order to activate the function:

- Highest heat level - three orange fields illuminate in the centre console's screen (see figure above).
- Lower heat level - two orange fields illuminate in the screen.

- Lowest heat level - one orange field illuminates in the screen.
- Switch off the heat - no field illuminates.

WARNING

Heated seats must not be used by people who find it difficult to perceive an increase in temperature due to a lack of sensation or who otherwise have problems operating the controls for the heated seats. Otherwise they may suffer burn injuries.

Automatic start of driver's seat heating

With the automatic start of the driver's seat heating activated, the driver's seat will have the highest heat level when the engine is started.

Automatic start takes place when the car is cold and the ambient temperature is lower than approx. +10 °C.

It is possible to activate/deactivate the function in the menu system MY CAR. For a description of the menu system, see MY CAR (p. 116).

Related information

- General information on climate control (p. 130)
- Heated rear seat* (p. 137)

Heated rear seat*

The heating for the rear seat's² outer positions has three positions for increasing the comfort for passengers when it is cold.



Current heat level is shown in the pushbutton's lamps.

Press the button repeatedly in order to activate the function:

- Highest heat level - three lamps illuminate.
- Lower heat level - two lamps illuminate.
- Lowest heat level - one lamp illuminates.
- Switch off the heat - no lamp illuminates.



WARNING

Heated seats must not be used by people who find it difficult to perceive an increase in temperature due to a lack of sensation or who otherwise have problems operating the controls for the heated seats. Otherwise they may suffer burn injuries.

Related information

- General information on climate control (p. 130)
- Heated front seats* (p. 137)

Ventilated front seats*

The ventilation can be used at the same time as seat heating. For example, the function can be used to dry damp from clothing.

The ventilation system consists of fans in the seats and backrests that draw air through the seat upholstery. The cooling effect increases the cooler the passenger compartment air becomes. The system can be activated when the engine is running.

The ventilation is regulated from the climate control and takes seat temperature, solar radiation and outside temperature into consideration.



Current comfort level is shown in the centre console display screen.



For button location, see the illustration (p. 136).

Press the button repeatedly in order to activate the function.

There are three comfort levels that produce different cooling and dehumidification outputs:

- Comfort level **III**: Highest output - three blue fields illuminate in the centre console's screen (see figure above).
- Comfort level **II**: Lower output - two blue fields illuminate in the screen.
- Comfort level **I**: Lowest output - one blue field illuminates in the screen.
- Switch off the function - no field illuminates.

NOTE

The seat ventilation should be used carefully by people sensitive to draughts. Comfort level **I** is recommended for long-term use.

IMPORTANT

The seat ventilation cannot be started when the passenger compartment temperature is below 5 °C. This is in order to avoid cooling down the seat occupant.

² Heated rear seat is not specified with the option for integrated two-stage booster seat (p. 50).



Fan

The fan should always be activated in order to avoid misting on the windows.

i NOTE

If the fan is fully switched off then the air conditioning is not engaged - which can cause a risk of misting on the windows.

Fan knob



Turn the knob to increase or decrease fan speed. If **AUTO** is selected, then the fan speed is regulated automatically (p. 139) - the fan speed previously set is disengaged.

Related information

- General information on climate control (p. 130)
- Electronic climate control - ECC (p. 136)

Auto-regulation

The auto function automatically regulates temperature (p. 139), air conditioning (p. 140), fan speed (p. 139), recirculation (p. 141) and air distribution (p. 134).



If you select one or more manual functions, the other functions continue to be controlled automatically. All manual settings are disengaged when **AUTO** is pressed. The display screen

shows **AUTO CLIMATE**.

Fan speed in automatic mode can be set in the menu system MY CAR. For a description of the menu system, see MY CAR (p. 116).

Related information

- General information on climate control (p. 130)

Temperature control in the passenger compartment

When the car is started, the most recent temperature setting is resumed.

i NOTE

Heating or cooling cannot be hastened by selecting a higher or lower temperature than the actual desired temperature.

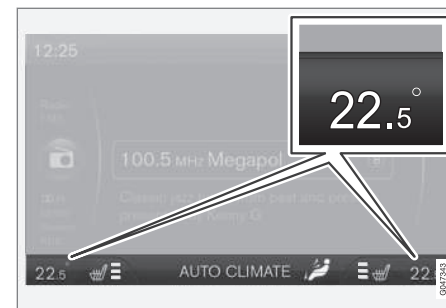

Current temperature for each side is shown in the centre console's display screen.



The temperature can be adjusted with the knob - separately for the driver's side and the passenger side.



04 Climate control



Related information

- General information on climate control (p. 130)
- Actual temperature (p. 131)
- Electronic climate control - ECC (p. 136)

Air conditioning

The air conditioning cools and dehumidifies incoming air as required.



When the lamp in the **AC** button illuminates, the air conditioning is controlled by the system's automatic function.

When the lamp in the **AC** button is switched off the air conditioning is disconnected. Other functions are still controlled automatically. When the max. defroster function (p. 140) is activated, the air conditioning is switched on automatically so that the air is dehumidified at the maximum setting.

Demisting and defrosting the windscreen

Heated windscreen and max. defroster are used to quickly remove misting and ice from the windscreen and side windows.*

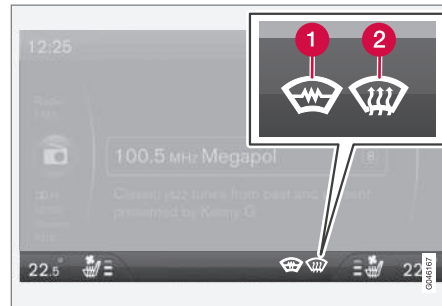

The selected setting is shown in the centre console's screen.

- 1 Heated windscreen*
- 2 Max. defroster



The light in the defroster button illuminates when the function is active.

Press the button repeatedly in order to activate the function.



For cars without heated windscreen:

- Air flows to the windows - symbol (2) illuminates in the screen.
- Switch off the function - no symbol illuminates.

For cars with heated windscreen:

- Start the heating for the windscreen³ - symbol (1) illuminates in the screen.
- Start the heating for the windscreen³ and air flow to the windows - symbols (1) and (2) illuminate in the screen.
- Switch off the function - no symbol illuminates.

i NOTE

Heated windscreen and IR window (p. 19) may have an impact on the performance of transponders and other communication equipment.

i NOTE

A triangular area at the end of each side of the windscreen is not electrically heated, where de-icing may take longer.

i NOTE

Electrically heated windscreen is not available when the engine is auto-stopped (p. 281).

The following also takes place in order to provide maximum dehumidification in the passenger compartment:

- the air conditioning is automatically engaged
- recirculation and the air quality system are automatically disengaged.

i NOTE

The noise level increases as the fan is operating at max.

When the defroster is switched off the climate control returns to the previous settings.

Related information

- General information on climate control (p. 130)

Air distribution - recirculation

Select recirculation to shut out bad air, exhaust gases etc. from the passenger compartment, i.e. no outside air is taken into the car when this function is activated.



When recirculation is engaged the orange lamp in the button illuminates.

i IMPORTANT

If the air in the car is recirculated for too long then there is a risk of misting on the insides of the windows.

Timer

With the timer function activated the system will exit manually activated recirculation mode according to a time that depends on the outside temperature. This reduces the risk of ice, misting and bad air.

It is possible to activate/deactivate the function in the menu system MY CAR. For a description of the menu system, see MY CAR (p. 116).

³ If the character **C** is shown in the rearview mirror when the heated windscreen is activated then the compass (p. 110)* must be recalibrated.



04 Climate control



NOTE

When max. defroster is selected, recirculation is always deactivated.





Related information

- General information on climate control (p. 130)
- Air distribution in the passenger compartment (p. 134)
- Air distribution - table (p. 143)



Air distribution - table





Three buttons are used to select the distribution (p. 134) of the air.

	Air distribution	Use
	Air to windows. Some air flows from the air vents. The air is not recirculated. Air conditioning is always engaged.	to remove ice and misting quickly.
	Air to windscreen, via defroster vent, and side windows. Some air flows from the air vents.	to avoid misting and icing in a cold and humid climate (to achieve this the fan level must not be too low).
	Airflow to windows and from dashboard air vents.	to ensure good comfort in warm, dry weather.
	Airflow to the head and chest from dashboard air vents.	to ensure efficient cooling in warm weather.



04 Climate control



	Air distribution	Use
	Air to the floor and windows. Some air flows from the dashboard air vents.	to ensure comfortable conditions and good demisting in cold or humid weather.
	Air to floor and from dashboard air vents.	in sunny weather with cool outside temperatures.
	Air to floor. Some air flows to the dashboard air vents and windows.	to direct heat or cold to the floor.
	Airflow to windows, from dashboard air vents and to the floor.	to provide cooling along the floor in hot, dry weather or warming upwards in cold weather.

Related information

- General information on climate control (p. 130)
- Air distribution - recirculation (p. 141)



Engine block heater and passenger compartment heater*

Preconditioning prepares the heater, engine and passenger compartment before departure so that both wear and energy needs during the journey are reduced.

The heater can be started directly (p. 146) or with a timer (p. 147).

The heater cannot start if the outside temperature exceeds 15 °C. At -5 °C or lower the maximum running time of the heater is 50 minutes.

WARNING

Do not use the fuel-driven heater indoors. Exhaust gases are secreted.

NOTE

When the fuel-driven auxiliary heater is active there may be smoke from the right-hand wheel housing, which is perfectly normal.

Refuelling

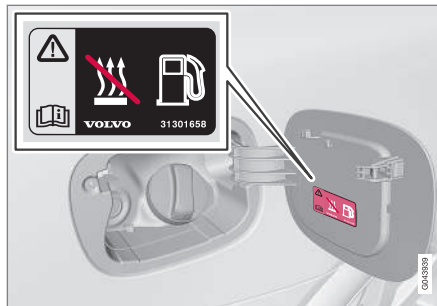

Warning label on fuel filler flap.

WARNING

Fuel which spills out could be ignited. Switch off the fuel-driven auxiliary heater before starting to refuel.

Check in the combined instrument panel that the heater is switched off. The heat symbol is shown when it is operating.

Parking on a hill

If the car is parked on a steep hill, the front of the car should point downhill to ensure that there is a supply of fuel to the fuel-driven heater.

Battery and fuel

If the battery has insufficient charge or the fuel level is too low, the heater will be switched off automatically and a message

appears on the information display. Acknowledge the message by pressing the indicator stalk (p. 113) **OK** button once.

IMPORTANT

Repeated use of the heater combined with short journeys leads to the battery discharging and consequential starting problems.

The car should be driven for the same time as the heater is used to ensure that the car's battery is recharged adequately to replace the energy consumed by the heater when it is used on a regular basis. The heater is used for a maximum of 50 minutes each time.

Related information

- Engine block heater and passenger compartment heater* - messages (p. 149)
- Additional heater* (p. 151)



04 Climate control

Engine block heater and passenger compartment heater* - direct start

The engine block heater and passenger compartment heater can be started directly.

Direct start can be performed via:

- information display
- remote control key*
- mobile*.

Upon direct start of the engine block and passenger compartment heater (p. 145), it will run for 50 minutes.

Heating of the passenger compartment will begin as soon as the engine coolant has reached the correct temperature.

NOTE

The car can be started and driven while the heater is running.

Direct start via the information display

1. Press **OK** to access the menu.
2. Scroll with the thumbwheel to **Parking heater** and select with **OK**.
3. Scroll forward in the next menu to **Direct start** in order to activate the heater and select with **OK**.
4. Exit the menu with **RESET**.

Direct start via the remote control key*

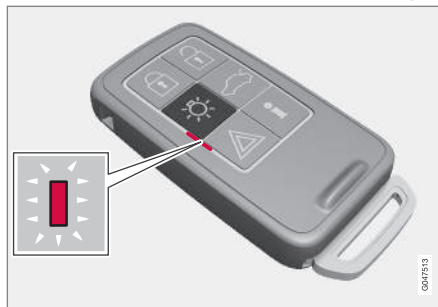

Indicator lamp on remote control key with PCC*.

The engine block heater and passenger compartment heater can be activated via the remote control key:

- Hold the button for approach lighting  depressed for 2 seconds.
 - Hazard warning flashers provide information in accordance with the following:
 - 5 short flashes followed by a constant glow for approx. 3 seconds - the signal has reached the car and the heater has been activated.
 - 5 short flashes - the signal has reached the car but the heater has not been activated.
 - Hazard warning flashers remain switched off - the signal has not reached the car.

If the button for information  is depressed when the heater is active then the indicator lamp will show the status for this - at the same time the car's lock status (p. 172) is shown. While the status is being investigated the indicator lamp emits a pair of short flashes followed by a constant glow if the heater is active.

Status is also shown in the trip computer during heating.

Direct start via a mobile*

Activation and information about the selected settings that can be managed from a mobile phone will be available via the Volvo On Call* mobile app.

Related information

- Engine block heater and passenger compartment heater* - timer (p. 147)
- Engine block heater and passenger compartment heater* - immediate stop (p. 147)
- Engine block heater and passenger compartment heater* - messages (p. 149)



Engine block heater and passenger compartment heater* - immediate stop

The engine block heater and passenger compartment heater can be deactivated directly via the information display.

1. Press **OK** to access the menu.
2. Scroll with the thumbwheel to **Parking heater** and select with **OK**.
3. Scroll forward in the next menu to **Stop** in order to deactivate the heater and select with **OK**.
4. Exit the menu with **RESET**.

Related information

- Engine block heater and passenger compartment heater* - direct start (p. 146)
- Engine block heater and passenger compartment heater* - timer (p. 147)
- Engine block heater and passenger compartment heater* - messages (p. 149)

Engine block heater and passenger compartment heater* - timer

The timer of the engine block and passenger compartment heater (p. 145) is connected to the car's clock.

Two different times can be selected using the timer. Here, time refers to the time when the car is heated and ready. The car's electronic system calculates when heating should be started based on the outside temperature.

NOTE

All timer programming will be cleared if the car's clock is reset.

Adjusting⁴

1. Press **OK** to access the menu.
2. Use the thumbwheel (p. 113) to scroll to one of the timers **Parking heater** and select with **OK**.
3. Select one of the two timers using the thumbwheel and confirm with **OK**.
4. Briefly press **OK** to move to the lit hours setting.
5. Select the required hour using the thumbwheel.

6. Briefly press **OK** to move to the flashing minutes setting.
7. Select the required minute using the thumbwheel.
8. Press **OK**⁵ to confirm the setting.
9. Go back in the menu structure using **RESET**.
10. Select the other time (continue from step 2) or exit the menu with **RESET**.

Starting

1. Press **OK** to access the menu.
2. Scroll with the thumbwheel to **Parking heater** and select with **OK**.
3. Select one of the two timers using the thumbwheel and activate with **OK**.
4. Exit the menu with **RESET**.

Switching off

A timer-started heater can be switched off manually before the set time has elapsed. Proceed as follows:

1. Press **OK** to access the menu.

⁴ Setting the timer is only possible with the engine switched off.

⁵ Press **OK** again to activate the timer.



04 Climate control



2. Scroll with the thumbwheel to **Parking heater** and select with **OK**.
 - > If a timer is set but not activated then a clock icon is shown beside the set time.
3. Select one of the two timers using the thumbwheel and confirm with **OK**.
4. Deactivate the timer as follows:
 - long press on **OK** or
 - short press on **OK** to continue in the menu. Then select to stop the timer and confirm with **OK**.
5. Exit the menu with **RESET**.

A timer-started heater can be switched off directly (p. 147).

Related information

- Engine block heater and passenger compartment heater* - messages (p. 149)



Engine block heater and passenger compartment heater* - messages

Symbols and display messages regarding the engine block and passenger compartment heater (p. 145) differ depending on whether the combined instrument panel (p. 65) is analogue or digital.



When the heater has been activated the heat symbol illuminates in the information display.

When one of the timers has been activated, the symbol for activated timer illuminates in the display at the same time as the set time is shown next to the symbol.





Symbol for activated timer in analogue combined instrument panel.



Symbol for activated timer in digital combined instrument panel.



The table shows symbols and display texts that appear.

Symbol	Message	Specification
		The heater is switched on and running.
 	Fuel operated heater stopped Battery saving mode	The heater has been stopped by the car's electronics in order to facilitate starting the engine.



04 Climate control



Symbol	Message	Specification
	Fuel operated heater stopped Low fuel level	Starting the heater is not possible due to fuel level being too low - this is in order to facilitate starting the engine as well as approx. 50 km driving.
	Fuel operated heater Service required	Heater not working. Contact a workshop for repair. Volvo recommends that you contact an authorised Volvo workshop.

A display text clears automatically after a time or after one press on the indicator stalk (p. 113) **OK** button.

04



Additional heater*

In cold climate zones⁶ an additional heater may be required to obtain the correct operating temperature in the engine and to obtain sufficient heating in the passenger compartment.

A fuel-driven additional heater (p. 151) is fitted in cars with diesel engines.

In a semi-cold⁶ climate zone diesel-driven cars have an electric additional heater (p. 152) instead of a fuel-driven version.

Cars with certain petrol engines⁷ have an electric additional heater integrated into the car's climate control system.

Related information

- Engine block heater and passenger compartment heater* (p. 145)

Fuel-driven additional heater*

The car is equipped with either an electric (p. 152) or a fuel-driven additional heater (p. 151).

The heater starts automatically when extra heat is required when the engine is running.

The heater is switched off automatically when the correct temperature is reached or when the engine is switched off.

NOTE

When the additional heater is active there may be smoke from the right-hand wheel housing, which is perfectly normal.

Auto mode or shutdown

The additional heater's automatic start sequence can be switched off if required.

NOTE

Volvo recommends that the fuel-driven additional heater should be switched off for short distances.

1. Before starting the engine: Select key position **I** (p. 81).

2. Press **OK** to access the menu.
3. Scroll with the thumbwheel to **Additional heater**⁸ or **Settings**⁹ and select with **OK**.
4. Select one of the options **ON** or **OFF** using the thumbwheel and confirm with **OK**.
5. Exit the menu with **RESET**.

NOTE

The menu options are only visible in key position **I** - any adjustments must therefore be made before starting the engine.

Passenger compartment heater*

If the additional heater is supplemented with a timer function then it can be used as a passenger compartment heater (p. 145).

⁶ An authorised Volvo dealer has information regarding the geographical areas concerned.

⁷ An authorised Volvo dealer has information regarding the engines concerned.

⁸ Analogue combined instrument panel.

⁹ Digital combined instrument panel.



Electric additional heater*

The car is equipped with either a fuel-driven (p. 151) or an electric additional heater (p. 151).

The heater cannot be controlled manually, but is instead activated automatically after the engine has been started in outside temperatures below 14 °C and is switched off after the set passenger compartment temperature has been reached.

Related information

- Engine block heater and passenger compartment heater* (p. 145)

05

LOADING AND STORAGE

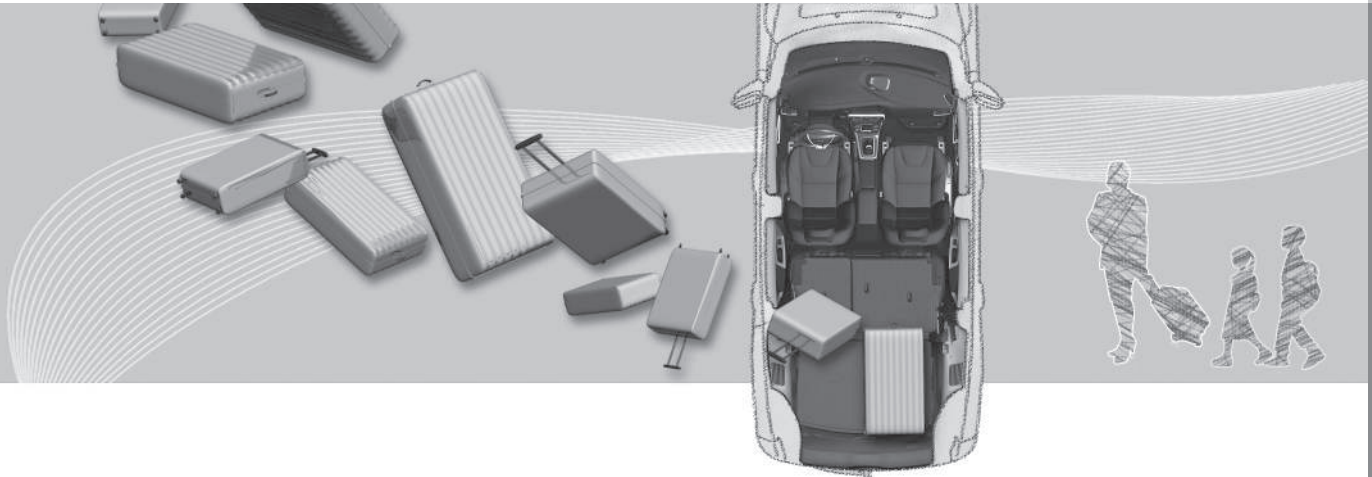



05 Loading and storage

Storage spaces

Overview of storage spaces in the passenger compartment.

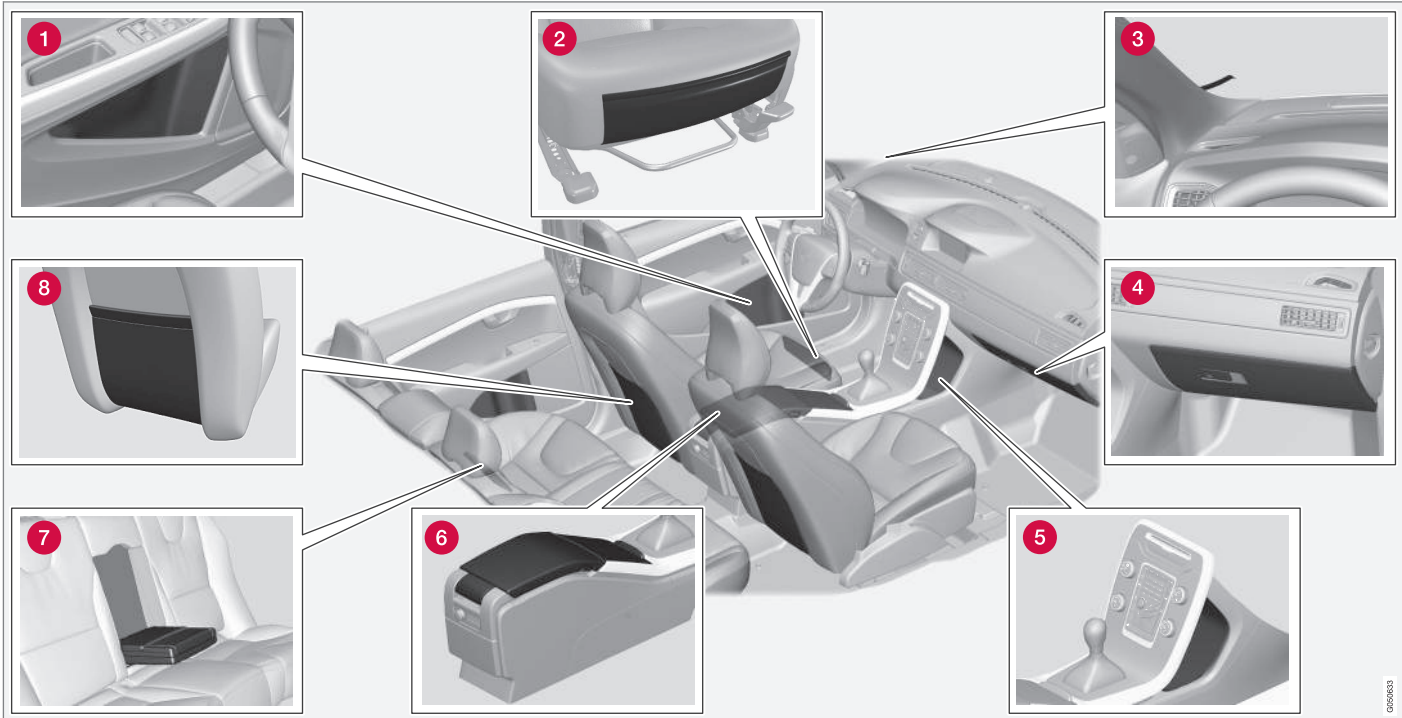

00000001



- 1 Storage compartment in door panel
- 2 Storage pocket* on front edge of front seat cushions
- 3 Ticket clip
- 4 Glovebox (p. 156)
- 5 Storage compartment
- 6 Storage compartment, cup holder (p. 156)
- 7 Cup holder* in armrest, rear seat
- 8 Storage pocket



WARNING

Keep loose objects such as mobile phones, cameras, remote controls for accessories, etc. in the glove compartment or other compartments. Otherwise they may injure people in the car in the event of sudden braking or a collision.



Tunnel console

The tunnel console is located between the front seats.

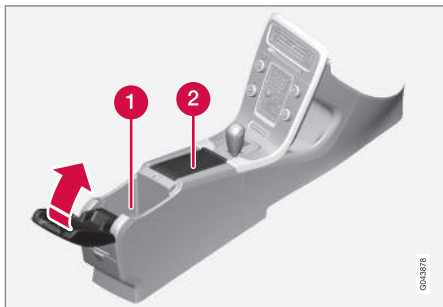

- 1 Storage compartment (e.g. for CDs) and USB*/AUX input under the armrest.
- 2 Includes cup holder for driver and passenger. If ashtray and cigarette lighter (p. 156) are specified, then there is a cigarette lighter in the 12 V socket (p. 157) for the front seat, and a detachable ashtray in the cup holder.

Related information

- Storage spaces (p. 154)
- Tunnel console - cigarette lighter and ashtray* (p. 156)

Tunnel console - cigarette lighter and ashtray*

A detachable ashtray is fitted in the cup holder under the armrest. The cigarette lighter is fitted in the 12 V socket (p. 157) for the front seat.

The ashtray in the tunnel console (p. 156) is detached by lifting the tray straight up.

Activate the lighter by pushing in the button. The button pops out when the lighter is hot. Pull out the lighter and light a cigarette on the heated coils.

Related information

- Storage spaces (p. 154)

Glovebox

The glovebox is located on the passenger side.

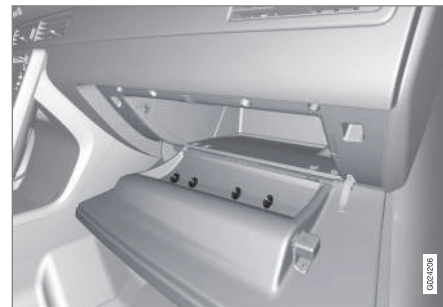

The owner's manual and maps can be kept in here for example. There are also holders for pens on the inside of the lid. The glovebox can be locked* (p. 184) using the key blade (p. 174).

Related information

- Storage spaces (p. 154)



Inlay mats*

Inlay mats collect e.g. rubbish and slush. Volvo supplies specially manufactured inlay mats.

! WARNING

Only use one inlaid mat at each seat, and check before setting off that the mat by the driver's seat is firmly affixed and secured in the pins so that it does not get caught adjacent to and under the pedals.

Related information

- Cleaning the interior (p. 401)

Vanity mirror

The vanity mirror is located on the rear of the sun visor.



Vanity mirror with lighting.

The lamp for the vanity mirror, on the driver's side* and passenger side respectively, is switched on automatically when the cover is raised.

Related information

- Lamp replacement - vanity mirror lighting (p. 374)

Tunnel console - 12 V-sockets

The electrical sockets (12 V) are located next to the cup holder¹ and rear of the tunnel console.



12 V socket in tunnel console, front seat.



12 V socket in tunnel console, rear seat.

¹ If ashtray and cigarette lighter are specified then there is no cup holder and adjacent 12 V socket.



05 Loading and storage



The electrical socket can be used for various accessories designed for 12 V, e.g. TV screens, music players and mobile phones. For the socket to supply current, the remote control key must be in at least key position I (p. 81).

WARNING

Always leave the plug in the socket when the socket is not in use.

NOTE

Optional equipment and accessories - e.g. display screens, music players and mobile phones - which are connected to one of the passenger compartment's 12V electrical sockets, could be activated by the climate control system, even when the remote control key has been removed or when the car is locked, for example, when the parking heater is activated at a preset time.

For this reason remove the plugs from the electrical sockets for optional equipment or accessories when not in use because the battery could be drained in the event of such an occurrence!

IMPORTANT

Max. socket is 10 A (120 W) if one socket is used at a time. If both sockets in the tunnel console are used simultaneously, 7.5 A (90 W) per socket is applicable.

If the compressor for emergency puncture repair is connected to one of the two sockets, no other current consumer must be connected to the other one.

NOTE

The compressor for emergency puncture repair (p. 341) has been tested and approved by Volvo.

Related information

- Tunnel console - cigarette lighter and ashtray* (p. 156)
- 12 V electrical socket - cargo area* (p. 161)

Loading

Payload depends on the car's kerb weight.

Payload depends on the car's kerb weight. The total of the weight of the passengers and all accessories reduces the car's payload by a corresponding weight.

For more detailed information on weights, see Weights (p. 410).



The tailgate is opened via a button on the lighting panel or the remote control key, see Locking/unlocking - tailgate (p. 185).

WARNING

The car's driving properties change depending on the weight and positioning of the load.

To bear in mind when loading

- Position the load firmly against the rear seat's backrest.

Note that objects must not prevent the function of the WHIPS system for the front seats if any of the rear seat's backrests is folded down, see WHIPS - seating position (p. 39).

- Centre the load.
- Heavy objects should be placed as low as possible. Avoid placing heavy loads on lowered backrests.



- Cover sharp edges with something soft to avoid damaging the upholstery.
- Secure all loads to the load retaining eye-lets with straps or web lashings.

WARNING

A loose object weighing 20 kg can, in a frontal collision at a speed of 50 km/h, carry the impact of an item weighing 1000 kg.

WARNING

The protection provided by the inflatable curtain in the headlining may be compromised or eliminated by high loads.

- Never load cargo above the backrest.

WARNING

Always secure the load. During heavy braking the load may otherwise shift, causing injury to the car's occupants.

Cover sharp edges and sharp corners with something soft.

Switch off the engine and apply the parking brake when loading/unloading long items. Otherwise you may accidentally knock the gear lever or gear selector with the load into a drive position - and the car could then move off.

Related information

- Safety net* (p. 162)
- Loading - long load (p. 159)
- Roof load (p. 160)

Loading - long load

To simplify loading (p. 158) in the cargo area, the rear seat backrest can be folded down.

The passenger seat² backrest can also be folded for an extra long load.*

Lowering the rear seat backrest

If the rear seat backrest needs to be lowered, see Seats, rear (p. 84).

² Only applies to comfort seats.



Roof load

The load carriers recommended for roof loads are the ones developed by Volvo. This is in order to avoid damage to the car and in order to achieve the maximum possible safety during a journey.

Carefully follow the installation instructions supplied with the carriers.

- Check periodically that the load carriers and load are properly secured. Lash the load securely with retaining straps.
- Distribute the load evenly over the load carriers. Put the heaviest objects at the bottom.
- The size of the area exposed to the wind, and therefore fuel consumption, increase with the size of the load.
- Drive gently. Avoid quick acceleration, heavy braking and hard cornering.

WARNING

The car's centre of gravity and driving characteristics are altered by roof loads.

For information about the maximum permitted load on the roof, including load carriers and any space box, see Weights (p. 410).

Related information

- Loading (p. 158)
- Securing loads (p. 160)

Securing loads

On both sides of the car's cargo area there are fixed mounting points designed for securing loads.

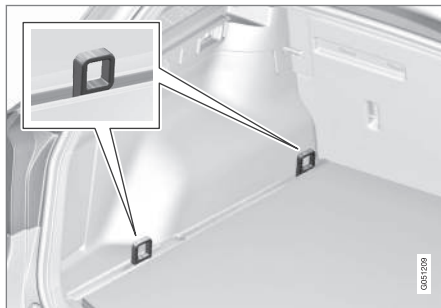

Mounting point locations in the cargo area.

The fixed mounting points are positioned in the cargo rails in the cargo area floor. In the illustration above, two of the mounting points in the floor are shown in raised position. Their basic position is lowered.

WARNING

Hard, sharp and/or heavy objects which protrude may cause injury under violent braking.

Always secure large and heavy objects with a seatbelt or cargo retaining straps.

IMPORTANT

Do not use straps with exchange as these may pull the mounting points apart.

NOTE

A suitable width for a cargo retaining strap is approx. 25 mm.

Related information

- Loading (p. 158)



Loading - bag holder*

The bag holder keeps carrier bags in place and prevents them from overturning and spreading their contents across the cargo area.



Bag holder under folding hatch in the floor.

1. Fold up the holder, which is part of the floor hatch.
2. Fasten the bags with strap and secure the carrying handle in the hooks.

Related information

- Loading (p. 158)

12 V electrical socket - cargo area*

The electrical socket can be used for various accessories designed for 12 V, e.g. screens, music players and mobile phones.



Lower the cover to access the electrical socket.

- The socket also provides voltage when the remote control key is not in the ignition switch.

! IMPORTANT

Max. power takeoff is 10 A (120 W).

i NOTE

Remember that using the electrical socket with the engine switched off involves the risk of discharging the car's starter battery.

i NOTE

The compressor for temporary emergency puncture repair has been tested and approved by Volvo. For information on the use of Volvo's recommended temporary emergency puncture repair (TMK), see Emergency puncture repair* (p. 341).

Related information

- Tunnel console - 12 V-sockets (p. 157)



Safety net*

A safety net prevents loads from being thrown forward in the passenger compartment in the event of sudden braking.

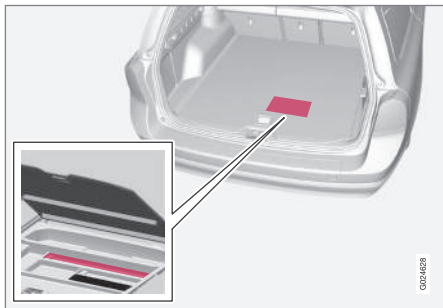

Storage space, safety net cassettes.

A rollable safety net comprising two cassettes has a storage space under the cargo area floor hatch.

Securing the net cassettes

A rollable safety net comprising two cassettes has a storage space under the cargo area floor hatch.

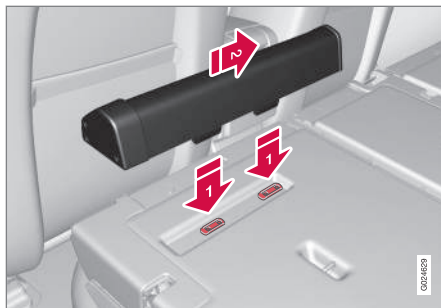

The two-part safety net cassette is secured on the rear of the backrest. The narrowest cassette is secured on the left-hand side (seen from the tailgate).

1. Fold the rear seat's backrest forward, see Seats, rear (p. 84).
2. Align the cassette's anchor rails in front of the backrest attachment lugs
3. Slide the cassette into the attachment lugs .
4. Fold back and lock the backrests.
 - Removing the cassette takes place in reverse order.

Using the safety net

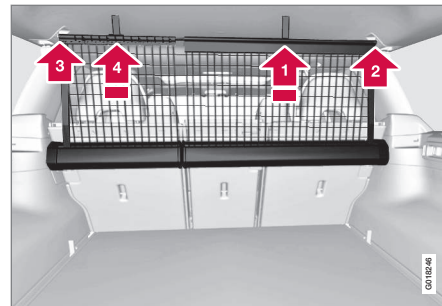

Pull the net up from the cassettes. The net is self-locking after approx. one minute if the rear seat's backrests are raised.

- 1 Pull up the right-hand section of the net using its strap.
- 2 Insert the rod in the mounting on the right-hand side and then press it forward – the rod locks in with a click.
- 3 Pull out the rod's telescope section and click it in on the other side.
- 4 Pull up the left-hand safety net and hook it into the rod.
 - Folding up takes place in reverse order.

The net can also be used when the rear seat's backrests are folded forward.



Removing the net cassettes

1. Roll the safety nets into the cassettes in accordance with the procedure in the section entitled "Using the safety net", but in reverse.
2. Fold the whole backrest forward.
3. Slide the cassettes out until they loosen from the anchor rails.

Store the cassettes in their compartment under the cargo area floor hatch.

WARNING

Loads in the luggage compartment must be anchored well, and also using a correctly fitted safety net.

Related information

- Loading (p. 158)
- Safety grille (p. 163)

Safety net* combined with cargo cover

A safety net prevents loads from being thrown forward in the passenger compartment in the event of sudden braking.

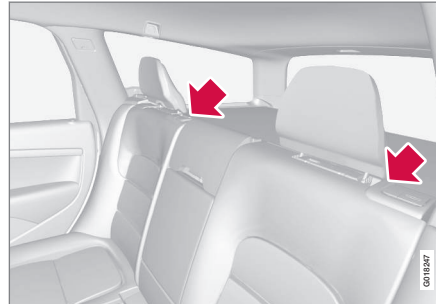

Puller-straps for raising the net.

The safety net can also be raised from the rear seat when the cargo cover is extended.

Follow the procedure described in the section "Using the safety net" (p. 162). The straps for folding up are located by the arrows.

Related information

- Safety net* (p. 162)
- Loading (p. 158)

Safety grille

A safety grille prevents loads or pets from being thrown forward in the passenger compartment in the event of sudden braking.

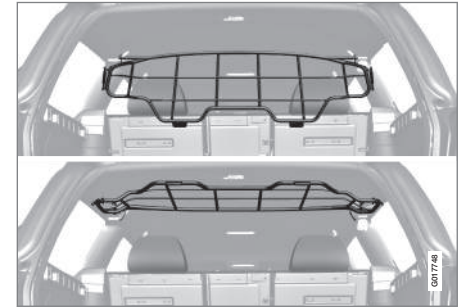

Folding up

Take hold of the bottom of the safety grille and pull back/up.

IMPORTANT

The protective grille cannot be folded up or down when a cargo cover is fitted.

Fitting/removal

The safety grille is normally permanently installed in the car because it can easily be folded up in the roof and so be out of the way if a longer cargo area is required. However, if desired, the safety grille can be dismantled and removed from the car.



05 Loading and storage



For safety reasons, the safety grille must always be correctly fastened and secured when being refitted.

The backrests must first be lowered to allow the safety grille to be fitted, see Seats, rear (p. 84).

i NOTE

The safety grille is most easily fitted/ removed by two people via the rear doors.

During fitting the handle should be on the front of the grille, see the illustrations 1 3.

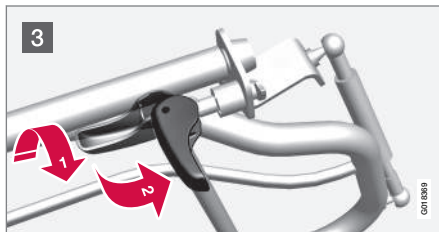
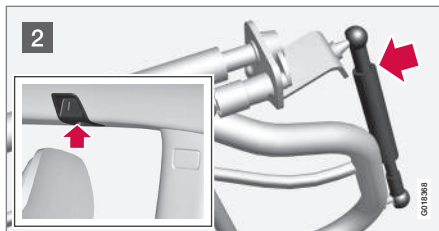

- 1** Position the handle in fitting position in accordance with the illustration. Press gently on the handle to enable it to be turned into position.
 - 2** Press the strut in towards the grille and align the grille in the roof mounting.
 - 3** Turn the handle 90°. Press gently as in the illustration (1) if necessary. Secure the grille by angling the handle 90°.
- Removal of the grille takes place in reverse order.

Related information

- Safety net* (p. 162)
- Loading (p. 158)



Cargo cover

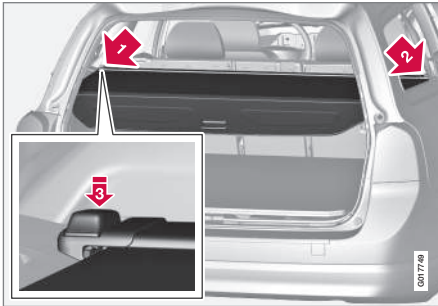

Pull the cargo cover over the load and hook it into the recesses at the cargo area's rear posts.

! IMPORTANT

The protective grille cannot be folded up or down when the cargo cover is fitted.

Attaching the cargo cover

- 1 Move one end piece of the cover into the recess on the side panel.
- 2 Move the other end piece into the corresponding recess.
- 3 Press both sides in. A "click" should be audible and the red marking should disappear.
 - > Check that both end pieces are locked.

Removing the cargo cover

1. Press in one end piece button and lift it out.
2. Carefully angle the cover up/out and the other end piece loosens automatically.

Lowering the cargo cover's rear sealing disc

In its rolled-in position, the cargo cover's rear sealing disc protrudes horizontally into the cargo area when it is fitted.

- Pull the sealing disc back gently, free from its support shelves, and lower.

Related information

- Loading (p. 158)
- Loading - long load (p. 159)

06



LOCKS AND ALARM





Remote control key

Amongst other things, the remote control key is used for locking/unlocking and starting the engine.

There are two variants of remote control key - Remote control key in basic version and Remote control key with PCC (Personal Car Communicator)*.

Functionality	Basic ^A	with PCC ^B
Locking/unlocking and detachable key blade	x	x
Keyless locking/unlocking		x
Keyless engine starting		x
Information button and indicator lamps		x

^A 5-button key

^B 6-button key

Remote control key with PCC has extended functionality compared with the remote control key in the basic version - e.g. support for Keyless Drive (p. 178) and certain unique functions (p. 172).

All remote control keys have a detachable key blade (p. 174) made of metal. The visible section is available in two versions so that it is possible to distinguish between the remote control keys.

More remote control keys can be ordered - but not variants other than the one supplied with the car. Up to six keys can be programmed and used for one single car.

The car is supplied with two remote control keys



WARNING

If there are children in the car:

Remember to switch off the supply to the power windows and sunroof by removing the remote control key if the driver leaves the car.

Related information

- Remote control key - functions (p. 170)

Remote control key - losing

If you lose a remote control key then a new one can be ordered at a workshop - an authorised Volvo workshop is recommended.

The remaining remote control keys must be taken to the Volvo workshop. The code of the missing remote control key must be erased from the system as a theft prevention measure.

The current number of keys registered to the car can be checked in the menu system MY CAR. For a description of the menu system, see MY CAR (p. 116).

Related information

- Remote control key - functions (p. 170)



Remote control key - personalisation*

The key memory in the remote control key (p. 167) means that certain settings in the car can be individually adapted for different people.

The key memory function is available in combination with power* driver's seat.

Settings for door mirrors (p. 108), driver's seat, steering force (p. 195) and the combined instrument panel's theme, contrast and colour mode (p. 66) can be stored in the memory, depending on the car's equipment level.

The function¹ can be activated/deactivated in the menu system MY CAR. For a description of the menu system, see MY CAR (p. 116).

When the function is activated, the settings are automatically linked to the key memory. This means that a change in a setting will automatically be saved to the specific remote control key's memory.

Storing settings

Make sure that the key memory function is activated in the menu system MY CAR.

Proceed as follows in order to store the settings and use the key memory in the remote control key:

1. Unlock the car with the remote control key in whose memory the setting² shall be stored.
2. Make the desired settings for e.g. the seat and the door mirrors.
3. The settings are stored in the current remote control key's memory.

The next time the car is unlocked with the same remote control key, the positions that are stored in the key memory will be set automatically - providing that they have been changed since the last time the current remote control key was used.

Emergency stop

If the seat accidentally begins to move, press one of the setting buttons for the seat or memory buttons in order to stop the seat.

Restarting to reach the seat position stored in the key memory is performed by pressing the unlock button on the remote control key. The driver's door must then be open.



WARNING

Risk of crushing! Make sure that children do not play with the controls. Check that there are no objects in front of, behind or under the seat during adjustment. Make sure that none of the passengers in the rear seat is in danger of becoming trapped.

Changing settings

If several people each with a remote control key approach the car, then the settings for e.g. seat and door mirrors are implemented for the person whose remote control key unlocks the driver's door.

If the driver's door has been opened by person A with remote control key A, but person B with remote control key B shall drive, then the settings can be changed as follows:

- Standing by the driver's door, or sitting behind the steering wheel, person B presses the button for unlocking on his/her remote control key, see Remote control key - functions (p. 170).
- Select one of three possible memories for seat adjustment with seat button 1-3, see

¹ Called Car key memory in MY CAR.

² This setting does not affect settings that have been stored in the power seat's memory function.



Seats, front - electrically operated* (p. 83).

- Adjust seat and door mirrors manually, see Seats, front - electrically operated* (p. 83) and Door mirrors (p. 108).

Reactivation of settings

When the car is locked or after 30 minutes if the car is left unlocked, the key memory will be deactivated and a standard driver profile will be set. To reactivate the key memory for the current remote control key, the following is required.

For cars without Keyless Drive

The settings that are stored in the key memory are activated if the car is unlocked by pressing the remote control key's unlock button.

For cars with Keyless Drive

The key memory is activated if:

1. The car is unlocked either by pressing the remote control key's unlock button or via keyless unlocking.
2. If the car is unlocked, a key scan is made when the driver's door is opened. If a unique remote control key is found, its stored settings will be activated. If the car is locked, see the previous point.

Related information

- Remote control key with PCC* - unique functions (p. 172)

³ Only for cars with retractable power door mirrors.

Locking/unlocking - indicator

When the car is locked or unlocked using the remote control key (p. 167) the direction indicators confirm that locking/unlocking was correctly performed.

- Locking - one flash and the door mirrors are folded³ in.
- Unlocking - two flashes and the door mirrors are folded³ out.

After locking the indication is only given if all locks are activated once the doors have been closed.

Selecting the function

Different options for indicating locking/unlocking with light can be set in the car's menu system MY CAR. For a description of the menu system, see MY CAR (p. 116).

Related information

- Keyless drive* (p. 178)
- Alarm indicator (p. 191)

Immobiliser

The electronic immobiliser is a theft protection system that prevents an unauthorised person from starting the car.

Each remote control key (p. 167) has a unique code. The car can only be started with the correct remote control key with the correct code.

The following error messages in the combined instrument panel's information display are related to the electronic immobiliser:



Message	Specification
Insert car key	Error when reading the remote control key during starting - Remove the key from the ignition switch, press it in again and make a new start attempt.
Car key not found	Error reading the remote control key during starting - Try to start again. If the error persists: Insert the remote control key into the ignition switch and try to start again.
Immobiliser Try to start again	Error in immobiliser system during starting. If the error persists: Contact a workshop - an authorised Volvo workshop is recommended.

For starting the car, see Starting the engine (p. 265).

Related information

- Remote-controlled immobiliser with tracking system* (p. 170)

Remote-controlled immobiliser with tracking system*

Remote-controlled immobiliser with tracking system⁴ makes it possible to track and locate the car, and to remotely activate the immobiliser to switch off the engine.

Contact your nearest Volvo dealer for more information and assistance with activating the system.

Related information

- Remote control key (p. 167)
- Immobiliser (p. 169)

Remote control key - functions

The remote control key in basic version has functions such as locking and unlocking the doors.

Functions



Remote control key in basic version.

- Locking
- Unlocking
- Approach light duration
- Tailgate
- Panic function

⁴ Only certain markets and in combination with Volvo On Call*.



Remote control key with PCC* (Personal Car Communicator).

Information

Function buttons

Locking – Locks the doors and tailgate while the alarm is activated.

Press and hold to close all the windows and sunroof* simultaneously. For more information, see Global opening (p. 184).

WARNING

If the sunroof and windows are closed using the remote control key, check that nobody's hands are trapped.

Unlocking – Unlocks the doors and tailgate while the alarm is deactivated.

Press and hold to open all windows simultaneously. For more information, see Global opening (p. 184).

The function can be changed from unlocking all doors simultaneously, to unlocking the driver's door only with one press of the button and, after a further press of the button - within ten seconds - unlocking the remaining doors.

The function can be changed in the menu system MY CAR. For a description of the menu system, see MY CAR (p. 116).

Approach light duration – Used to switch on the car's lighting at a distance. For more information, see Approach lighting (p. 99).

Tailgate - Unlocks and disarms the alarm for the tailgate only. For more information, see Locking/unlocking - tailgate (p. 185). On cars with Power operated tailgate (p. 186)* the tailgate is opened after the button is kept depressed.

Panic function – Used to attract attention in an emergency.

Press and hold the button for at least 3 seconds or press it twice within 3 seconds to activate the direction indicators and the horn.

The function can be turned off with the same button once it has been active for at least 5 seconds. Otherwise the function switches off automatically after approx. 3 minutes.

Related information

- Remote control key (p. 167)
- Remote control key with PCC* - unique functions (p. 172)
- Locking/unlocking - from the outside (p. 183)



Remote control key - range

Remote control key functions (in its basic version) have a range of approx. 20 metres from the car.

If the car does not verify a button being pressed - move closer and try again.

NOTE

The remote control key functions may be disrupted by surrounding radio waves, buildings, topographical conditions, etc. The car can always be locked/unlocked with the key blade (p. 175).

If the remote control key is removed from the car when the engine is running or key position I or II (p. 80) is active, and if all doors are closed, then a warning message is shown in the information display in the combined instrument panel and an audio reminder signal sounds at the same time.

The message is extinguished and the audible reminder signal stops when the remote control key is brought back to the car after either/or:

- The remote control key has been inserted in the ignition switch.
- Speed exceeds 30 km/h.
- The **OK** button has been pressed.

Related information

- Remote control key (p. 167)
- Remote control key - functions (p. 170)

Remote control key with PCC* - unique functions

A remote control key with PCC has enhanced functionality compared with a remote control key in basic version (p. 167) in the form of an information button and indicator lamps.

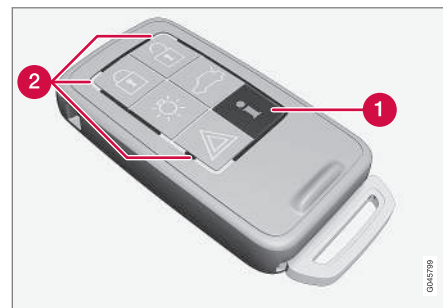

Remote control key with PCC.

- 1 Information button
- 2 Indicator lamps

Using the information button enables access to certain information from the car via the indicator lamps.



Using the information button

- Press the information button .
 - > All indicator lamps flash for approximately 7 seconds and the light travels around on the remote control key. This indicates that information from the car is being scanned.

If any of the other buttons are pressed during this time then the reading is interrupted.

NOTE

 If none of the indicator lamps illuminates with repeated use of the information button and in different locations (as well as after 7 seconds and after the light has travelled around on the PCC), contact a workshop - an authorised Volvo workshop is recommended.

Indicator lamps display information in accordance with the following illustration:

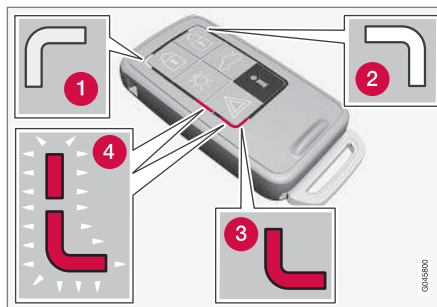

- 1 Green continuous light – the car is locked.
- 2 Yellow continuous light – the car is unlocked.
- 3 Red continuous light – the alarm has been triggered since the car was locked.
- 4 Red light flashing alternately in both indicator lamps – The alarm was triggered less than 5 minutes ago.

Related information

- Remote control key with PCC* - range (p. 173)

Remote control key with PCC* - range

The range of a remote control key with PCC (Personal Car Communicator) for locking, unlocking the doors and tailgate is approx. 20 metres from the car - the other functions are up to approx. 100 metres.

If the car does not verify a button being pressed - move closer and try again.

NOTE

The information button function may be disrupted by surrounding radio waves, buildings, topographical conditions, etc.

Outside the remote control key's range

If the remote control key is too far away from the car for the information to be read then the status the car was last left in is shown, without the light in the indicator lamps travelling around on the remote control key.

If several remote control keys are used for the car then it is only the one last used for locking/unlocking that shows the correct status.

NOTE

 If no indicator lamps illuminate when the information button is used within range then this may be because the last communication between the remote control key and the car was disrupted by surrounding radio waves, buildings, topographical conditions, etc.



Related information

- Keyless Drive* - remote control key range (p. 178)
- Remote control key - range (p. 172)

Detachable key blade

A remote control key contains a detachable key blade of metal with which some functions can be activated and some operations carried out.

The key blade's unique code is provided by authorised Volvo workshops, which are recommended when ordering new key blades.

Key blade functions

Using the remote control key's detachable key blade:

- the driver's door can be opened manually if central locking cannot be activated with the remote control key, see Detachable key blade - unlocking doors (p. 175).
- the rear doors' mechanical child safety locks can be activated/deactivated (p. 188).
- access to the glovebox and cargo area (privacy locking (p. 175)*) can be blocked.
- the airbag for front passenger seat (PACOS*) can be activated/deactivated (p. 34).

Related information

- Remote control key - functions (p. 170)
- Remote control key (p. 167)

Detachable key blade - detaching/attaching

Detaching/attaching the detachable key blade (p. 174) is carried out as follows:

Removing the key blade



- 1 Slide the spring-loaded catch to the side.
- 2 At the same time pull the key blade straight out backwards.

Attaching the key blade

Carefully refit the key blade into its location in the remote control key (p. 167).

1. Hold the remote control key with the slot pointed up and lower the key blade into its slot.
2. Lightly press the key blade. You should hear a "click" when the key blade is locked in.



Related information

- Detachable key blade - unlocking doors (p. 175)
- Child safety locks - manual activation (p. 188)
- Passenger airbag - activating/deactivating* (p. 34)

Detachable key blade - unlocking doors

The detachable key blade (p. 174) can be used if central locking cannot be activated with the remote control key (p. 167), e.g. if the key's battery has run out.

If central locking cannot be activated with the remote control key - e.g. if the batteries are discharged - then the driver's door can be opened as follows:

1. Unlock the driver's door with the key blade in the door handle's lock cylinder. For illustration and more information, see Keyless drive* - unlocking with the key blade (p. 181).

NOTE

When the door has been unlocked using the key blade and is opened, the alarm is triggered.

2. Deactivate the alarm by inserting the remote control key in the ignition switch.

For cars with the Keyless system, see Keyless drive* - unlocking with the key blade (p. 181).

Related information

- Remote control key (p. 167)
- Remote control key - replacing the battery (p. 177)

Privacy locking*

Privacy locking is intended for when the car is left for service, with a hotel parking valet or similar. The glovebox is then locked and the tailgate lock is disconnected from the central locking - the tailgate cannot be opened with either the central locking button in the front doors or the remote control key (p. 167).

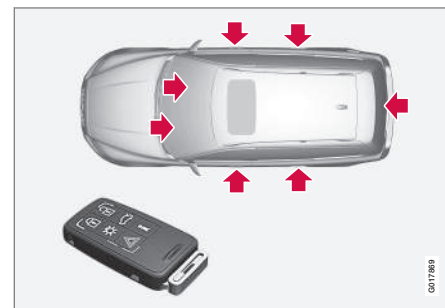

Active locks for remote control key **with** key blade.



06 Locks and alarm



Active locks for remote control key, **without** key blade and privacy locking **activated**.

This means that the remote control key without key blade can only be used to activate/deactivate the alarm (p. 190), to open the doors and to drive the car.

The remote control key without key blade can then be handed over to the service or hotel staff - the loose key blade is retained by the car owner.

NOTE

Do not forget to pull out the cargo cover (p. 165) over the cargo area before closing the tailgate.

Activate/deactivate

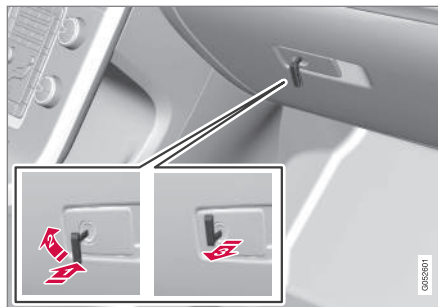

Activating privacy locking.

To activate privacy locking:

- 1 Insert the key blade in the glovebox lock cylinder.
- 2 Turn the key blade 180 degrees clockwise.
- 3 Pull out the key blade. The combined instrument panel's information display shows a message at the same time.

The glovebox is then locked and the tailgate can no longer be unlocked with the remote control key or the central locking button.

NOTE

Do not reinsert the key blade into the remote control key, but keep it in a safe place instead.

- Deactivation takes place in reverse order. For information on locking the glovebox only, see Locking/unlocking - glovebox (p. 184).



Remote control key - replacing the battery

The battery⁵ for the remote control key may need to be replaced.

The battery for the remote control key should be replaced if:

- the information symbol in the combined instrument panel illuminates and the display shows **Car key battery low** See manual

and/or

- the locks repeatedly do not react to signals from the remote control key within 20 metres from the car.

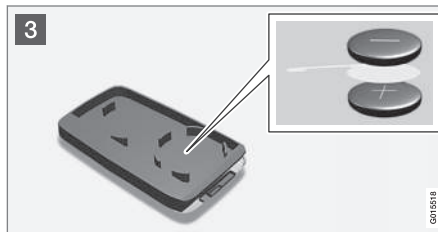

Opening

- 1 Slide the spring-loaded catch to the side.
- 2 At the same time pull the key blade straight out backwards.
- 2 Insert a 3 mm slot screwdriver in the hole behind the spring-loaded catch and gently prize the remote control key open.

NOTE

Turn the remote control key over with the buttons facing up, this is to avoid the batteries falling out when it is opened.

IMPORTANT

Avoid touching new batteries and their contact surfaces with your fingers as this may impair their function.

Battery replacement

- 3 Closely study how the battery/batteries are secured on the inside of the cover, with regard to their (+) and (-) sides.

Remote control key (one battery)

- 1 Carefully prize out the battery.
- 2 Install a new one with the (+) side down.

Remote control key with PCC* (two batteries)

- 1 Carefully prize out the batteries.
- 2 First install one new one with the (+) side up.
- 3 Position the white plastic tab in between and finally install a second new battery with the (+) side down.

⁵ Remote control key with PCC has two batteries.



Battery type

Use batteries with the designation CR2430, 3V - one in the remote control key, two in the remote control key with PCC.

NOTE

Volvo recommends that the batteries to be used in the remote control key/PCC fulfil UN Manual of Test and Criteria, Part III, sub-section 38.3. Batteries fitted in the factory or replaced by an authorised Volvo workshop fulfil the above criteria.

Assembly

1. Press the remote control key together.
2. Hold the remote control key with the slot pointed up and lower the key blade into its slot.
3. Lightly press the key blade. You should hear a "click" when the key blade is locked in.

IMPORTANT

Make sure that exhausted batteries are disposed of in a manner which is kind to the environment.

Related information

- Remote control key (p. 167)
- Remote control key - functions (p. 170)

⁶ Only applies to Remote Control Key with PCC.

Keyless drive*

Cars equipped with Keyless Drive have a starting and locking system that can be operated keylessly.

With the keyless starting and locking system the car can be started, locked and unlocked without the remote control key (p. 167)⁶ inserted in the ignition switch. It is enough to have the remote control key with you in a pocket. The system makes it easier and more convenient to e.g. open the car when your hands are full.

Both of the remote control keys included with the car have Keyless functionality. It is possible to order more remote control keys.

The car's electrical system can be set to three different levels - key position **0**, **I** and **II** (p. 81) - with the remote control key.

Related information

- Keyless Drive* - remote control key range (p. 178)
- Keyless drive* - secure handling of the remote control key (p. 179)
- Keyless drive* - interference to remote control key function (p. 180)

Keyless Drive* - remote control key range

In order to unlock the doors or tailgate automatically without pressing a button on the



remote control key⁷, a remote control key must be within approx. 1.5 metres from the car's door handle or tailgate.

The person who wishes to lock or unlock a door must have the remote control key with him or her. It is not possible to lock or unlock a door if the remote control key is on the opposite side of the car.

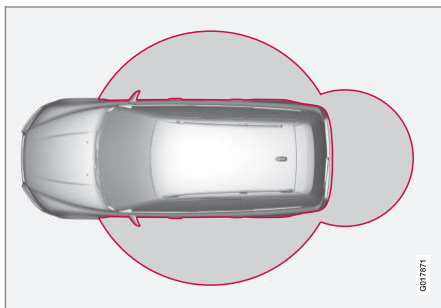

The red rings in the above figure indicate the range covered by the system's antennas.

If all remote control keys are removed from the car when the engine is running or key position I or II (p. 81) is active, and if all doors are closed, then a warning message is shown in the information display in the combined instrument panel and an audio reminder signal sounds at the same time.

When the remote control key has been returned to the car, the warning message goes off and the audible reminder ceases once either/or:

- a door has been opened and closed
- the remote control key has been inserted in the ignition switch
- The **OK** button has been pressed.

Related information

- Keyless drive* (p. 178)
- Keyless Drive* - antenna location (p. 182)

Keyless drive* - secure handling of the remote control key

It is important to handle the car's remote control keys with great care.

If one of the remote control keys⁸ has been left in the car then the Keyless functionality is deactivated in case the car is e.g. locked with the other remote control key that belongs to the car. This prevents unauthorised entry.

The next time the car is unlocked with the other remote control key the forgotten remote control key is reactivated again.



IMPORTANT

Avoid leaving the remote control key with PCC behind in the car. If someone breaks into your car and takes the remote control key, it will e.g. be possible to start the car by pressing the remote control key in the ignition switch and then pressing the **START/STOP ENGINE** button.

Related information

- Keyless drive* (p. 178)

⁷ Applies to remote control key with PCC (Personal Car Communicator).

⁸ Applies to remote control key with PCC (Personal Car Communicator).



Keyless drive* - interference to remote control key function

Electromagnetic fields and screening can interfere with the remote control key's Keyless functions (p. 178).

NOTE

Do not place/store the PCC near a mobile phone or metal object - no closer than 10-15 cm.

If interference is experienced nonetheless, use the remote control key and the key blade like a remote control key in basic version, see Remote control key - functions (p. 170).

Related information

- Remote control key - replacing the battery (p. 177)
- Keyless drive* - secure handling of the remote control key (p. 179)
- Keyless Drive* - remote control key range (p. 178)

Keyless drive* - locking

Cars equipped with Keyless drive have a button on the outer door handles for locking/unlocking.



Cars with the keyless system have a button on the outside door handles.

Lock the doors and the tailgate by pressing the lock button on one of the door handles on the outside.

All doors and the tailgate must be closed before the car can be locked - otherwise the car is not locked.

NOTE

In cars with automatic gearbox selectors, the gear selector must be set to the **P** position; otherwise the car can be neither locked nor alarmed.

Related information

- Keyless drive* (p. 178)
- Alarm indicator (p. 191)



Keyless drive* - unlocking

Unlocking takes place when a hand grasps a door handle or the tailgate's rubberised pressure plate is actuated - open the door or tailgate as normal.

Related information

- Keyless drive* (p. 178)
- Keyless drive* - locking (p. 180)

Keyless drive* - unlocking with the key blade

If central locking cannot be unlocked with the remote control key, e.g. if the batteries are discharged, then the left-hand driver's door can be opened using the detachable key blade.

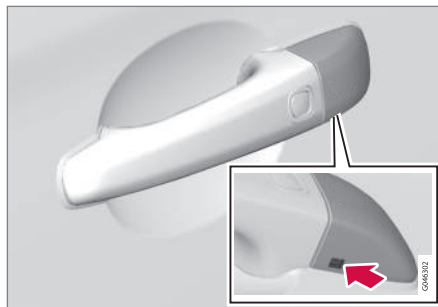

Hole for key blade - to loosen the cover.

To access the lock cylinder, the door handle's plastic cover must be removed - this is also done with the key blade:

1. Press the key blade approx. 1 cm straight up into the hole on the underside of the door handle/cover - do not prize.
 - > The plastic cover loosens automatically by means of the torque when the blade is pushed straight up and into the opening.

2. Then insert the key blade in the lock cylinder and unlock the door.
3. Refit the plastic cover after unlocking.



NOTE

When the driver's door is unlocked using the key blade and is opened, the alarm is triggered. It is switched off by inserting the PCC in the ignition switch, see Alarm - remote control key not working (p. 191).

Related information

- Keyless drive* (p. 178)
- Detachable key blade - detaching/attaching (p. 174)
- Alarm (p. 190)



Keyless Drive* - lock settings

Lock settings for cars equipped with Keyless Drive can be adapted by indicating in the menu system MY CAR which doors are to be unlocked.

For a description of the menu system, see MY CAR (p. 116).

Related information

- Keyless drive* (p. 178)

Keyless Drive* - antenna location

Cars equipped with Keyless Drive have a number of built-in antennae positioned at different locations in the car.

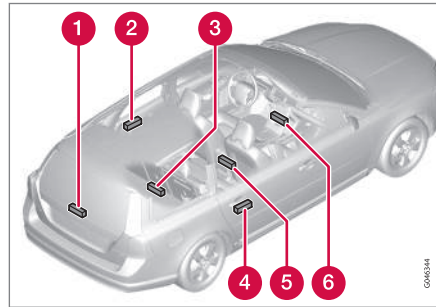

- 1 Tailgate, by wiper motor
- 2 Door handle, left rear
- 3 Cargo area, central and furthest in under the floor
- 4 Door handle, right rear
- 5 Centre console, under the rear section
- 6 Centre console, under the front section.



WARNING

People with pacemaker operations should not come closer than 22 cm to the keyless system's antennae with their pacemaker. This is to prevent interference between the pacemaker and the keyless system.

Related information

- Keyless drive* (p. 178)



Locking/unlocking - from the outside

Locking/unlocking from the outside is carried out using the remote control key (p. 167). The remote control key can lock/unlock all doors and the tailgate simultaneously. Different sequences for unlocking can be selected, see Remote control key - functions (p. 170).

In order that the lock sequence can be activated, the driver's door must be closed - if any of the other doors or the tailgate is open, then it/they is/are locked and the alarm is activated only when it/they are closed. For cars equipped with keyless locking system* all doors and the tailgate must be closed.

i NOTE

Be aware of the risk of locking the remote control key in the car.

If it is not possible to lock/unlock with the remote control key, the battery may be discharged - lock or unlock the driver's door with the detachable key blade, see Detachable key blade - detaching/attaching (p. 174).

i NOTE

Remember that the alarm is triggered when the door is opened after being unlocked with the key blade - the alarm is switched off when the remote control key is inserted into the ignition switch.

! WARNING

Be aware of the risk of being locked in the car when it is locked from the outside using the remote control key - it is then not possible to open any of the doors from the inside with the door controls.

For more information, see Deadlocks* (p. 187).

Automatic reloading

If none of the doors or the tailgate is opened within two minutes of unlocking, all are locked again automatically. This function reduces the risk that the car is left unlocked unintentionally. (For cars with alarm, see Alarm (p. 190).)

Related information

- Locking/unlocking - from the inside (p. 183)
- Keyless drive* (p. 178)

Locking/unlocking - from the inside

All of the doors and the tailgate can be locked or unlocked simultaneously using the central locking button on the driver's door and passenger door*.

Central locking

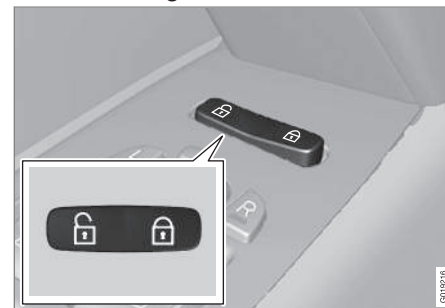

Central locking.

- Press one side  of the button to lock - the other side  to unlock.

Press and hold to also open all side windows* simultaneously.

Unlocking

A door can be unlocked from the inside in two different ways:

- Press the central locking button .

A long press also opens all the side windows* simultaneously (see also Global opening (p. 184)).



06 Locks and alarm



- Pull the door handle once and release - the door is unlocked. Pull the door handle again to open the door.

Locking

- Press the central locking button  after the front doors have been closed.

A long press also closes all side windows and sunroof simultaneously (see also Global opening (p. 184)).

All doors can also be individually locked manually with their lock buttons - the door in question must then be closed.

Automatic locking

The doors and tailgate are locked automatically when the car starts to move.

The function can be activated/deactivated in the menu system **MY CAR**. For a description of the menu system, see MY CAR (p. 116).

Related information



- Locking/unlocking - from the outside (p. 183)
- Alarm (p. 190)
- Remote control key - functions (p. 170)

Global opening

The global opening function opens or closes all side windows simultaneously and can be used for example to quickly air the car during hot weather.



Central locking button

A long press on the  symbol in the central locking button **opens** all side windows simultaneously. The same procedure on the  symbol **closes** all side windows simultaneously.

Related information

- Locking/unlocking - from the inside (p. 183)
- Power windows (p. 106)

Locking/unlocking - glovebox

The glovebox (p. 156) can only be locked/unlocked using the remote control key's detachable key blade.

For information on the key blade, see Detachable key blade - detaching/attaching (p. 174).

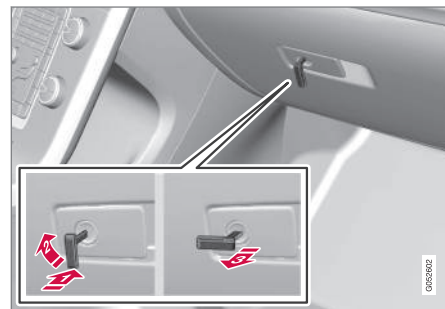

Locking the glovebox:

- Insert the key blade in the glovebox lock cylinder in accordance with the illustration above.
 - Turn the key blade 90 degrees clockwise.
 - Pull out the key blade.
- Unlock by carrying this out in reverse order.

For information on privacy locking, see Privacy locking* (p. 175).



Related information

- Remote control key (p. 167)

Locking/unlocking - tailgate

The tailgate can be opened, locked and unlocked in several ways.

Unlocking with the remote control key

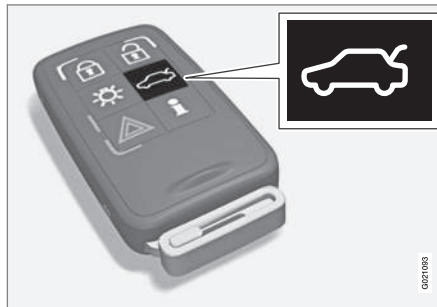

The alarm for the tailgate can be disarmed* and the tailgate unlocked on its own by using the remote control key's  button.

If the car is equipped with an alarm (p. 190)* then the alarm indicator (p. 191) on the instrument panel is extinguished to show that the alarm is not armed for the whole of the car. The alarm's level and movement sensors and the sensors for opening the tailgate are disconnected.

The doors remain locked and armed.

- The tailgate is unlocked, but remains closed - press lightly on the rubberised pressure plate under the outer handle and lift the tailgate.

If the tailgate is not opened within 2 minutes then it is relocked and the alarm is re-armed.

Unlocking the car from inside

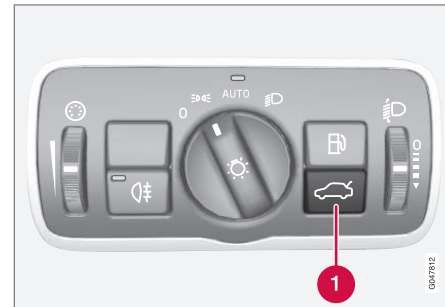

1 Unlocking, tailgate

To unlock the tailgate:

- Press the lighting panel button (1).
 - > The tailgate is unlocked and can be opened within 2 minutes (if the car is locked from the inside).

Locking with the remote control key

- Press the remote control key's button for locking , see Remote control key - functions (p. 170).
 - > If the car is equipped with an alarm* the alarm indicator on the instrument panel starts to flash, which means that the alarm is armed.



Related information

- Locking/unlocking - from the inside (p. 183)
- Locking/unlocking - from the outside (p. 183)

Power operated tailgate*

The car's tailgate can be opened using a button on the lighting panel, with the rubberised pressure plate under the outside handle or with the remote control key. Closing takes place using the close button at the bottom of the tailgate.



Close button

NOTE

Consider the roof height when using electrical operation. Do not use electrical operation of the tailgate under a low roof height, see under the heading "Interrupt opening/closing of tailgate".

NOTE

- If the system has been operating continuously for a long time, it is switched off to avoid overload. It can be used again after about 2 minutes.
- If the battery has been discharged or disconnected then the tailgate must be opened and closed again to reset the system.

Programmable max. opening

Tailgate maximum opening position can be programmed. Can be used for e.g. low roof height in a garage. Proceed as follows:

- Open the tailgate manually, hold it in the desired position and give the button on the tailgate one long press (at least 3 seconds) and then release the tailgate - the programming is complete.
- To delete the programming - move the tailgate manually to a higher position and give the button on the tailgate one long press (at least 3 seconds) and then release the tailgate - the programming is complete.

Pinch protection

If something with sufficient resistance prevents the tailgate from opening/closing then the pinch protection is activated.



- During opening - power tailgate operation is deactivated and the tailgate stops.
- When closing - the tailgate stops and backs off from the obstacle a couple of centimetres.

WARNING

Observe the risk of trapping when opening/closing. Before starting opening/closing, check that there is nobody near to the tailgate as trapping may have serious consequences.

Always operate the tailgate with caution.

Opening the tailgate

The tailgate can be opened three ways (two of which involve this button):

- Long press on the button in the lighting panel - hold the button depressed until the tailgate starts to open.
- Long press on the button on the remote control key - hold the button depressed until the tailgate starts to open.
- Push down gently on the rubberised pressure plate under the outer handle.

Closing the tailgate

Close using this button on the tailgate or manually.

- Press the button - the tailgate closes automatically.

Stop the opening/closing of the tailgate

This can be done four ways (of which three involve this button):

- Press the lighting panel button
 - Press the remote control key button
 - Press the tailgate's button
 - Press the rubberised pressure plate beneath the outside handle.
- The tailgate's movement is interrupted and it stops.

Manual tailgate operation**IMPORTANT**

During manual tailgate operation, open or close it slowly. Do not use force to open/close it if there is resistance. It may be damaged and stop working correctly.

The system is disengaged if the opening/closing sequence is interrupted in accordance with the preceding section.

- The tailgate can then be operated manually.

Related information

- Locking/unlocking - tailgate (p. 185)

Deadlocks*

Deadlocks means that all lock buttons and door handles are mechanically disengaged, which prevents doors being opened from both inside and outside.

The deadlocks are activated with the remote control key (p. 167) and are set after an approx. ten seconds delay after the doors have been locked.

NOTE

If a door is opened within the delay time then the sequence is interrupted and the alarm is deactivated.

The car can only be unlocked with the remote control key when the deadlocks function is activated. The front left door can also be unlocked with the detachable key blade (p. 174). In addition, it is possible to unlock and open the doors and tailgate on cars equipped with the Keyless Drive* by touching door handles or the handle on the tailgate.

WARNING

Do not allow anyone to remain in the car without first deactivating the deadlocks in order to avoid the risk of anyone being locked in.



Temporary deactivation

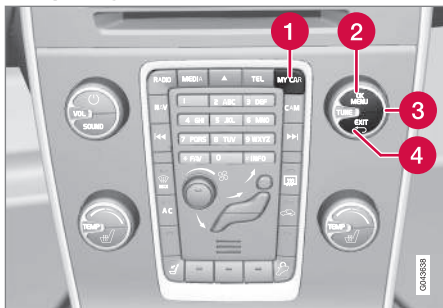

Active menu options are indicated with a cross.

- 1 **MY CAR**
- 2 **OK MENU**
- 3 **TUNE** knob control
- 4 **EXIT**

If someone is going to stay in the car but the doors must be locked from the outside, then the deadlocks function can be temporarily switched off. This takes place the menu system **MY CAR**. For a description of the menu system, see MY CAR (p. 116).

NOTE

- Remember that the alarm is activated when the car is locked.
- If any of the doors are opened from the inside then the alarm is triggered.

The above applies if the deadlocks have not been deactivated temporarily.

Related information

- Keyless drive* - unlocking with the key blade (p. 181)
- Remote control key (p. 167)

Child safety locks - manual activation

The child safety locks prevent children from being able to open a rear door from the inside.

Activate/deactivate child safety locks

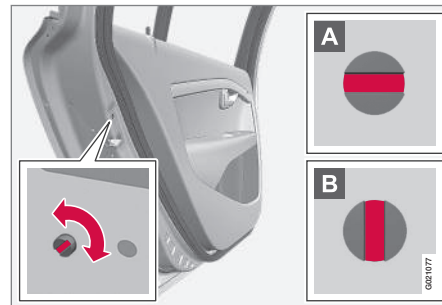

The child safety locks are located on the trailing edge of the rear doors and are only accessible when the doors are open.

To activate/deactivate the child safety locks:

- Use the remote control key's detachable key blade (p. 174) to turn the knob.
- A** The door is blocked against opening from the inside.
- B** The door can be opened from both the outside and the inside.



NOTE

- A door's knob control only blocks that particular door - not both rear doors simultaneously.
- Cars with an electric child safety lock do not have a manual child lock.

Related information

- Child safety locks - electrical activation* (p. 189)
- Locking/unlocking - from the inside (p. 183)
- Locking/unlocking - from the outside (p. 183)

Child safety locks - electrical activation*

Child safety locks with electrical activation prevent children from opening the rear doors or windows from the inside.

Activation

The child safety locks can be activated/deactivated in all key positions (p. 80) higher than 0. Activation/deactivation can be performed up to 2 minutes after switching off the engine, provided that no door is opened.

To activate the child safety locks:



Control panel driver's door.

1. Start the engine or choose a key position higher than 0.

2. Press the button in the driver's door control panel.
 - > The combined instrument panel's information display shows the message **Rear child lock activated** and the button's lamp illuminates - the locks are active.

When the child safety lock is active then the rear:

- windows can only be opened with the driver's door control panel
- doors cannot be opened from inside.

The current setting is stored when the engine is switched off - if the child safety locks are activated at engine shutdown, the function will remain activated the next time the engine is started.

Related information

- Child safety locks - manual activation (p. 188)
- Locking/unlocking - from the inside (p. 183)



Alarm

The alarm is a device that warns in the event of e.g. a break-in in the car.

Activated alarm is triggered if:

- a door, the bonnet or the tailgate is opened
- a movement is detected in the passenger compartment (if fitted with a movement detector*)
- the car is raised or towed away (if fitted with a tilt detector*)
- the starter battery's cable is disconnected
- the siren is disconnected.

If there is a fault in the alarm system then the information display in the combined instrument panel shows a message. In which case, contact a workshop - an authorised Volvo workshop is recommended.

NOTE

The movement sensors trigger an alarm in the event of movement in the passenger compartment - air currents are also registered. For this reason the alarm is triggered if the car is left with a window or the sunroof open or if the passenger compartment heater is used.

To avoid this: Close the window/sunroof when leaving the car. If the car's integrated passenger compartment heater (or a portable electric heater) shall be used - direct the airflow from the air vents so that they are not pointing upwards in the passenger compartment. Alternatively, reduced alarm level can be used, see Reduced alarm level (p. 192).

NOTE

Do not attempt to repair or alter components in the alarm system yourself. Any such attempts may affect the terms of the insurance.

Arming the alarm

- Press the remote control key lock button.

Deactivate the alarm

- Press the remote control key unlock button.

Deactivating a triggered alarm

- Press the remote control key unlock button or insert the remote control key in the ignition switch.

Related information

- Alarm indicator (p. 191)
- Alarm - automatic re-arming (p. 191)
- Alarm - remote control key not working (p. 191)



Alarm indicator

The alarm indicator shows alarm system (p. 190) status.

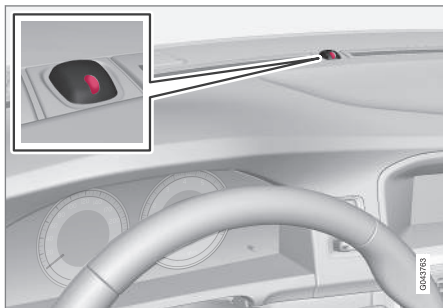

A red LED on the instrument panel indicates the alarm system's status:

- LED not lit – Alarm not armed
- The LED flashes once every other second – Alarm is armed
- The LED flashes rapidly after disarming the alarm (and until the remote control key is inserted in the ignition switch and key position I is selected) – Alarm has been triggered.

Alarm - automatic re-arming

Automatic re-arming of the alarm (p. 190) prevents the car being left with the alarm disarmed unintentionally.

If the car is unlocked with the remote control key (and the alarm is disarmed) but none of the doors or the tailgate is opened within 2 minutes, then the alarm is automatically re-armed. The car is relocked at the same time.

Related information

- Reduced alarm level (p. 192)

Alarm - remote control key not working

If the alarm (p. 190) cannot be deactivated with the remote control key, e.g. if the key's battery (p. 177) is discharged - the car can be unlocked, disarmed and the engine started as follows:

1. Open the driver's door with the detachable key blade (p. 181).
 - > The alarm is triggered, the alarm indicator (p. 191) flashes rapidly and the siren sounds.



2. Insert the remote control key in the ignition switch.
 - > The alarm is deactivated and the alarm indicator goes out.
3. Start the engine.



06 Locks and alarm

Alarm signals

When the alarm (p. 190) is triggered a siren sounds and all direction indicators flash.

- A siren sounds for 30 seconds or until the alarm is switched off. The siren has its own battery and works independently of the car battery.
- The direction indicators flash for 5 minutes or until the alarm is switched off.

Reduced alarm level

Reduced guard means that the movement and tilt detectors can be temporarily deactivated.

To avoid accidental triggering of the alarm (p. 190) - e.g. if a dog is left in a locked car or during transport on a car train or car ferry - temporarily deactivate the movement and tilt detectors.

The procedure is the same as with the temporary disengaging of deadlocks (p. 187)⁹.

Related information

- Alarm indicator (p. 191)

Type approval - remote control key system

Type approval for the remote control key system can be read in the table.

Lock system, standard

Country/Area	
EU, China	





Keyless lock system (Keyless drive)

Country/Area	
EU	
Korea	

⁹ Only in combination with alarm.

06



Country/Area	
China	 <p>Continental SWK4 9209 CETS/831D/0806/R TR/CULPD/SB/2006/06 CMIH ID:200802-11121 Complies with IDA  Standaard DB01782 TA-2001480  Made in Cz </p>
Hong Kong	 <p>Continental SWK4 9209</p>

Related information

- Remote control key (p. 167)

07



DRIVER SUPPORT

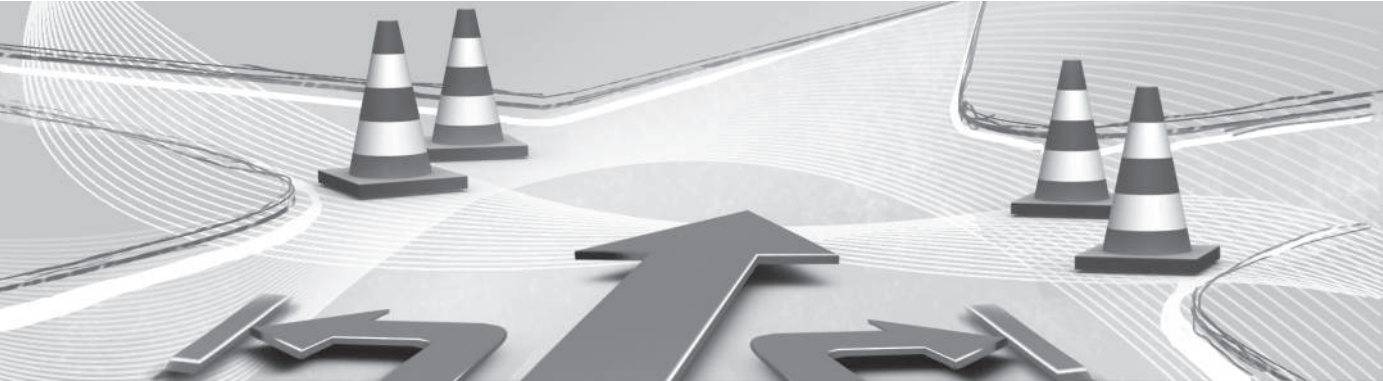



Active chassis - Four C*

Active chassis "Four-C" (Continuously Controlled Chassis Concept), regulates the characteristics of the shock absorbers so that the car's driving characteristics can be adjusted. There are three settings: **Comfort**, **Sport** and **Advanced**.

Comfort

This setting means that the car is perceived as being more comfortable on rough and uneven road surfaces. Shock absorption is soft and the movement of the body is smooth and gentle.

Sport

This setting means that the car is perceived as being more sporty and is recommended for more active driving. Steering response is faster than in the Comfort mode. Shock absorption is harder and the body follows the road in order to reduce rolling during cornering.

Advanced

This setting is only recommended on very even and smooth road surfaces.

The shock absorbers are optimised for maximum roadholding and rolling in bends is further minimised.

Operation



Control buttons.

The required chassis setting is selected using the centre console buttons. The setting used when the engine was switched off is re-activated when the engine is next started. The exception is Advanced - it is restarted as Sport.

Adjustable steering force*

Speed related power steering causes the steering wheel force to increase with the speed of the car in order to give the driver enhanced sensitivity.

On motorways the steering feels firmer. Steering is light and requires no extra effort when parking and at low speed.

The driver can choose between three different levels of steering force for road responsiveness or steering sensitivity in the menu system **MY CAR**, MY CAR (p. 116):

- Once there, search for **Steering force level** and select **Low**, **Medium** or **High**.

This setting is not accessible when the car is moving.

i NOTE

In certain situations the power steering may become too hot and then needs to be temporarily cooled - during this time the power steering operates with reduced power and turning the steering wheel may then be perceived to be slightly heavier.

In parallel with the temporarily reduced steering assistance the combined instrument panel shows a message.

Related information

- MY CAR (p. 116)

* Option/accessory, for more information, see Introduction.



Electronic stability control (ESC) - general

Stability system ESC (Electronic Stability Control) helps the driver to avoid skidding and improves the car's traction.



The activation of the ESC system during braking may be noticed as a throbbing sound. The car may accelerate slower than expected when the accelerator pedal is depressed.

WARNING

The stability system ESC is supplementary assistance - it cannot handle all situations in all road conditions.

The driver always bears responsibility that the vehicle is driven safely and that applicable road traffic rules and regulations are followed.

The ESC system consists of the following functions:

- Active Yaw Control
- Spin Control
- Traction control system

Active Yaw Control

The function checks the driving and brake force of the wheels individually in order to stabilise the car.

Spin Control

The function prevents the driving wheels from spinning against the road surface during acceleration.

Traction control system

The function is active at low speed and transfers power from the driving wheel that is spinning to the one that is not.

Related information

- Electronic stability control (ESC) - operation (p. 196)
- Electronic stability control (ESC) - symbols and messages (p. 198)

Electronic stability control (ESC) - operation

Selection of level - Sport mode

The ESC system is always activated - it cannot be deactivated.



However, the driver can select the **Sport** mode, which allows for a more active driving experience.

Sport mode is selected in the menu system MY CAR.

For a description of the menu system, see MY CAR (p. 116).

In **Sport** mode the system detects whether the accelerator pedal, steering wheel movements and cornering are more active than in normal driving and then allows controlled skidding with the rear section up to a certain level before it intervenes and stabilises the car.

If, for example, the driver stops a controlled skid by releasing the accelerator pedal, then the ESC system intervenes and stabilises the car.

With **Sport** mode, maximum traction is also obtained if the car has become stuck, or when driving on a loose surface - e.g. sand or deep snow.



Sport mode is indicated in the combined instrument panel by means of this symbol illuminating with a constant glow until the driver deselects the function or until the engine is switched off - after the next time the engine is started the ESC system is back in its normal mode again.

Related information

- Electronic stability control (ESC) - general (p. 196)
- Electronic stability control (ESC) - symbols and messages (p. 198)



Electronic stability control (ESC) - symbols and messages

Table

Symbol	Message	Specification
	ESC Temporarily OFF	ESC system has been temporarily reduced due to excessive brake disc temperature - the function is reactivated automatically when the brakes have cooled.
	ESC Service required	ESC system disengaged. <ul style="list-style-type: none"> • Stop the car in a safe place, switch off the engine and start it again. • Visit a workshop if the message remains - an authorised Volvo workshop is recommended.
	"Message"	There is a text message in the combined instrument panel (p. 65) - Read it!
and 		
	Constant glow for 2 seconds.	System check when the engine is started.
	Flashing light.	ESC system is being activated.
	Constant glow.	Sport mode is activated. NOTE: The ESC system is not deactivated in this mode - it is partially reduced.

07

**Related information**

- Electronic stability control (ESC) - general (p. 196)
- Electronic stability control (ESC) - operation (p. 196)



Road Sign Information (RSI)*

The road sign information function (RSI – Road Sign Information) helps the driver to remember which speed-related road signs the car has passed.

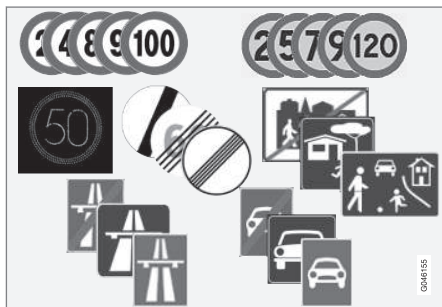

Examples of readable speed related signs¹.

The RSI function gives information on current speed, e.g. that a motorway or road is starting/ending and when overtaking is prohibited.

If both a sign for motorway/road for motorised traffic and a sign showing the maximum permitted speed are passed, RSI decides to show the sign symbol for maximum permitted speed.

WARNING

RSI does not work in all situations but is designed merely as a supplementary aid.

The driver always bears ultimate responsibility for ensuring that the vehicle is driven safely and that applicable road traffic rules and regulations are followed.

Related information

- Road sign information (RSI)* - operation (p. 200)
- Road sign information (RSI)* - limitations (p. 202)

Road sign information (RSI)* - operation

The road sign information function (RSI – Road Sign Information) helps the driver to remember which speed-related road signs the car has passed.

The function is operated as follows:

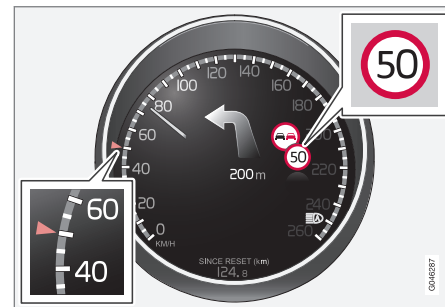

Recorded speed information².

When RSI has recorded a road sign with an imposed speed, the combined instrument panel displays the sign as a symbol.

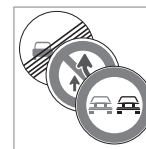

Together with the symbol for the current speed limit, a sign showing that overtaking is prohibited may also be displayed where appropriate.

¹ Road signs shown in the combined instrument panel are market-dependent - the illustrations in these instructions only show a few examples.

² Road signs shown in the combined instrument panel are market-dependent - the illustrations in these instructions only show a few examples.



End of restriction or motorway

A corresponding road sign is shown in the combined instrument panel for approx. 10 seconds in situations where RSI detects a sign that involves the end of a speed limit - or other speed-related information, e.g. end of a motorway.

Examples of such signs are:

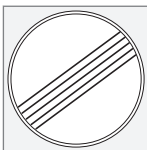

End of all restrictions.



End of motorway.

Following which, the sign information is hidden until the next speed-related sign is detected.

Additional signs

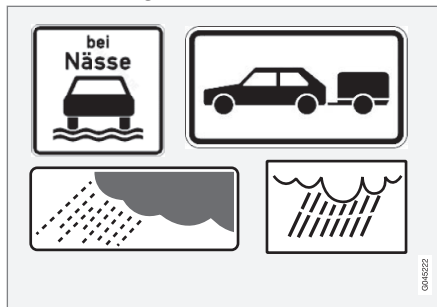

Examples of additional signs².

Sometimes different speed limits are signposted for the same road - an additional sign then indicates the circumstances under which the different speeds apply. The road section may be particularly susceptible to accidents in rain and/or fog, for example.

An additional sign relating to rain is displayed only if the windscreen wipers are in use.

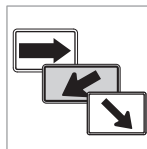

The speed applicable on an exit is indicated in certain markets by means of an additional sign containing an arrow.

Speed signs linked to this type of additional sign are displayed only if the driver is using the direction indicator.

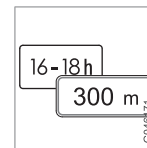

Some speeds are applicable only after e.g. a specific distance or at a certain time of day. The driver's attention is drawn to the situation by means of a symbol for an additional sign under the symbol showing speed.

Display of additional information



A symbol for additional sign in the form of an empty frame under the combined instrument panel's speed symbol means that the RSI has detected an additional sign with supplementary information for the current speed limit.

Setting in MY CAR

There are options for RSI in the **MY CAR** menu system; see MY CAR (p. 116).

² Road signs shown in the combined instrument panel are market-dependent - the illustrations in these instructions only show a few examples.



Road sign information On/Off



The combined instrument panel's speed symbol display can be disabled. The function can be activated/deactivated in the menu system **MY CAR**. For a description of the menu system, see MY CAR (p. 116).

Speed warning



The driver can opt to receive a warning when the applicable speed limit is exceeded by 5 km/h or more. This warning is given by the symbol showing the applicable maximum speed temporarily flashing when this speed is

exceeded. The function can be activated/deactivated in the menu system **MY CAR**. For a description of the menu system, see MY CAR (p. 116).

Related information

- Road Sign Information (RSI)* (p. 200)
- Road sign information (RSI)* - limitations (p. 202)
- MY CAR (p. 116)

Road sign information (RSI)* - limitations

The road sign information function (RSI – Road Sign Information) helps the driver to remember which speed-related road signs the car has passed. The function has the following limitations.

The RSI function's camera sensor has limitations just like the human eye - read more about camera sensor limitations (p. 236)).

Signs which indirectly provide information on a prevailing speed limit, e.g. name signs for towns/districts, are not recorded by the RSI function.

Here are several examples of what can disrupt the function:

- Faded signs
- Signs positioned on bends
- Rotated or damaged signs
- Concealed or poorly positioned signs
- Signs completely or partly covered with frost, snow and/or dirt.

Related information

- Road Sign Information (RSI)* (p. 200)
- Road sign information (RSI)* - operation (p. 200)



Cruise control*

The cruise control (CC – Cruise Control) helps the driver maintain an even speed, resulting in a more relaxed driving on motorways and long, straight roads in regular traffic flows.

Overview

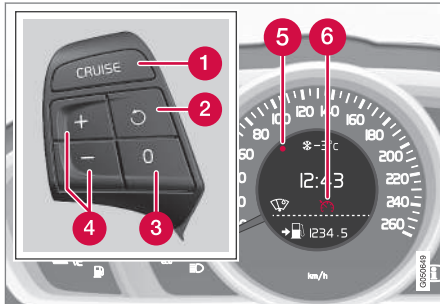

Steering wheel keypad and combined instrument panel.

- 1 Cruise control - On/Off.
- 2 Standby mode ceases and the stored speed is resumed.
- 3 Standby mode
- 4 Activate and adjust the speed.
- 5 Selected speed (GREY = Standby mode).
- 6 Cruise control active - WHITE symbol (GREY = Standby mode).

WARNING

The driver must always be observant with regard to the traffic conditions and intervene when the cruise control is not maintaining a suitable speed and/or suitable distance.

The driver always bears ultimate responsibility for ensuring that the vehicle is driven safely.

Related information



- Cruise control* - managing speed (p. 203)
- Cruise control* temporary deactivation and standby mode (p. 204)
- Cruise control* - resume set speed (p. 205)
- Cruise control* - deactivate (p. 205)
- Adaptive cruise control - ACC* (p. 205)

Cruise control* - managing speed

It is possible to activate, set and change the stored speed.

Activating and setting the speed



To start the cruise control:

- Press the steering wheel button for **CRUISE (without speed limiter)** or  (**with speed limiter**).
 - > The cruise control symbol (6) in the combined instrument panel illuminates - cruise control is in standby mode.
- #### To activate cruise control:
- At the required speed - press the steering wheel button  or .
 - > The current speed is stored in memory and the combined instrument panel's marking (5) illuminates at the selected speed and the symbol (6) changes from GREY to WHITE - the car then follows the stored speed.

NOTE

Cruise Control cannot be enabled at speeds below 30 km/h.

Changing the stored speed

Stored speed is changed with short or long presses on the  or  steering wheel button.



07 Driver support



To adjust +/- 5 km/h:

- Use short presses - each press gives +/- 5 km/h.

To adjust +/- 1 km/h:

- Hold down the button and release it at the required speed.

Last press made is stored in the memory.

If speed is increased using the accelerator pedal prior to pressing the  button, then it is the car's current speed when the button is pressed that is stored.

A temporary increase in speed with the accelerator pedal, e.g. during overtaking, does not affect the cruise control setting - the car returns to the last stored speed when the accelerator pedal is released.



NOTE

If any of the Cruise Control buttons are held depressed for several minutes then it is blocked and deactivated. To be able to reactivate Cruise Control, the car must be stopped and the engine restarted.

Related information

- Cruise control* (p. 203)

Cruise control* temporary deactivation and standby mode

The function can be temporarily deactivated and set in standby mode.

Temporary deactivation - standby mode

To temporarily disengage cruise control and set it in standby mode:

- Press the steering wheel button .
- > The combined instrument panel's marking (5) and symbol (6) change colour from WHITE to GREY - cruise control is temporarily disengaged.

Standby mode due to driver intervention

Cruise control is temporarily disengaged and automatically set in standby mode if:

- the foot brake is used
- the clutch pedal is depressed for longer than 1 minute³
- the gear lever-selector is moved to **N** position
- the driver maintains speed higher than the stored speed for longer than 1 minute.

The driver must then regulate the speed.

A temporary increase in speed with the accelerator pedal, e.g. during overtaking, does not affect the setting - the car returns to the last

stored speed when the accelerator pedal is released.

Automatic standby mode

Cruise control is temporarily disengaged and set in standby mode if:

- wheels lose traction
- engine speed is too low/high
- speed falls below approx. 30 km/h.

The driver must then regulate the speed.

Related information

- Cruise control* (p. 203)
- Cruise control* - managing speed (p. 203)
- Cruise control* - resume set speed (p. 205)
- Cruise control* - deactivate (p. 205)

³ Disengaging and selecting a higher or lower gear does not involve standby mode.

* Option/accessory, for more information, see Introduction.



Cruise control* - resume set speed

The cruise control (CC – Cruise Control) helps the driver to maintain an even speed.

After temporary deactivation and standby mode (p. 204) it is possible to resume the set speed.

To reactivate the cruise control from standby mode:

- Press the steering wheel button .
- > The combined instrument panel's marking (5) and symbol (6) change colour from GREY to WHITE - the car then follows the last stored speed.

NOTE

A marked speed increase may occur once the speed has been resumed by selecting the  button.

Related information

- Cruise control* (p. 203)
- Cruise control* - managing speed (p. 203)
- Cruise control* temporary deactivation and standby mode (p. 204)
- Cruise control* - deactivate (p. 205)

Cruise control* - deactivate

How it is deactivated is described here.

Cruise control is switched off with the steering wheel button (1) or by switching off the engine - the set/stored speed is thus cleared and cannot then be resumed with the  button.

Related information

- Cruise control* (p. 203)
- Cruise control* - managing speed (p. 203)
- Cruise control* temporary deactivation and standby mode (p. 204)
- Cruise control* - resume set speed (p. 205)

Adaptive cruise control - ACC*

The adaptive cruise control (ACC – Adaptive Cruise Control) helps the driver to maintain an even speed combined with a pre-selected time interval to the vehicle ahead.

The adaptive cruise control provides a more relaxing driving experience on long journeys on motorways and long straight main roads in smooth traffic flows.

The driver sets the desired speed (p. 209) and time interval (p. 210) to the car in front. When the radar detector detects a slower vehicle in front of the car, the speed is automatically adapted to that. When the road is clear again the car returns to the selected speed.

If the adaptive cruise control is switched off or set to standby mode (p. 211) and the car comes too close to a vehicle in front, then the driver is warned instead by the Distance Warning (p. 220) function about the short distance.



WARNING

The driver must always be observant with regard to the traffic conditions and intervene when the adaptive cruise control is not maintaining a suitable speed or suitable distance.

The adaptive cruise control cannot handle all traffic, weather and road conditions.

Read all the sections about the adaptive cruise control in the owner's manual in order to learn about its limitations, of which the driver should be aware before it is used.

The driver always bears responsibility for maintaining the correct distance and speed, even when the adaptive cruise control is being used.

IMPORTANT

Maintenance of adaptive cruise control components must only be performed at a workshop - an authorised Volvo workshop is recommended.

For a limited time after the service, the ACC function can have a somewhat limited range. The system is calibrated whilst driving and full function returns automatically.

Automatic gearbox

Cars with automatic gearbox have enhanced functionality with the adaptive cruise control's Queue assistance (p. 212) function.

Related information

- Adaptive cruise control* - function (p. 206)
- Adaptive cruise control* - overview (p. 208)
- Adaptive cruise control* - managing speed (p. 209)
- Adaptive cruise control* - set time interval (p. 210)
- Adaptive cruise control* - temporary deactivation, and standby mode (p. 211)
- Adaptive cruise control* - overtaking another vehicle (p. 212)
- Adaptive cruise control* - deactivate (p. 212)
- Adaptive Cruise Control* - queue assistance (p. 212)
- Adaptive cruise control* - switch cruise control functionality (p. 214)
- Radar sensor (p. 215)
- Radar sensor - limitations (p. 215)
- Adaptive cruise control* - fault tracing and action (p. 217)
- Adaptive cruise control* - symbols and messages (p. 218)

Adaptive cruise control* - function

It consists of a cruise control system and a coordinated spacing system.



Function overview

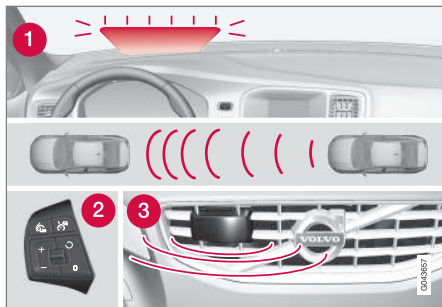

Function overview⁴.

- 1 Warning lamp - braking by driver required
- 2 Steering wheel keypad (p. 208)
- 3 Radar sensor (p. 215)

WARNING

Adaptive cruise control is not a collision avoidance system. The driver must intervene if the system does not detect a vehicle in front.

The adaptive cruise control does not brake for humans or animals, and not for small vehicles such as bicycles and motorcycles. Nor for low trailers, oncoming, slow or stationary vehicles and objects.

Do not use the adaptive cruise control, for example, in city traffic, in dense traffic, at junctions, on slippery surfaces, with a lot of water or slush on the road, in heavy rain/snow, in poor visibility, on winding roads or on slip roads.

Distance to the vehicle ahead (p. 210) is measured primarily by a radar sensor (p. 215). The cruise control function regulates the speed with acceleration and braking. It is normal for the brakes to emit a low sound when they are being used by the adaptive cruise control.

WARNING

The brake pedal moves when the adaptive cruise control brakes. Do not rest your foot beneath the brake pedal - it may then become trapped.

The adaptive cruise control aims to follow the vehicle ahead in the same lane according to what the driver set for time interval (p. 210). If the radar sensor cannot see any vehicle in front then the car will instead maintain the speed set and stored by the driver. This also takes place if the speed of the vehicle in front exceeds the stored speed.

The adaptive cruise control aims to control the speed in a smooth way. In situations that demand sudden braking the driver must brake himself/herself. This applies with large differences in speed, or if the vehicle in front brakes heavily. Due to limitations in the radar sensor (p. 215) braking may come unexpectedly or not at all.

The adaptive cruise control can be activated to follow another vehicle at speeds from 30 km/h⁵ up to 200 km/h. If the speed falls below 30 km/h or if the engine speed becomes too low, the cruise control is set in standby mode (p. 211) at which automatic braking ceases - the driver must then take over himself/herself to maintain a safe distance to the vehicle ahead.

⁴ NOTE: The illustration is schematic - details may differ depending on car model.

⁵ Queue Assist (p. 212) (in cars with automatic gearbox) can operate in the range 0-200 km/h.



07 Driver support



Warning lamp - braking by driver required

Adaptive cruise control has a braking capacity that is equivalent to approx. 40% of the car's braking capacity.

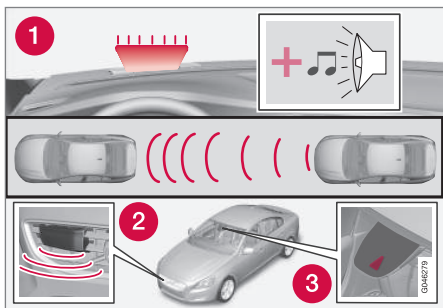

1. Collision warning system warning lamp and warning sound⁶.

If the car needs to be braked more heavily than the adaptive cruise control capacity and the driver does not brake, then the warning lamp and warning sound from the Collision warning system (p. 230) are used in order to alert the driver that immediate intervention is required.

NOTE

The warning lamp may be difficult to see in strong sunlight or when wearing sun-glasses.

WARNING

The adaptive cruise control only warns of vehicles which its radar unit has detected - hence a warning may not be given, or it may be given with a certain delay. Do not wait for a warning without braking when so required.

Steep roads and/or heavy load

Bear in mind that the adaptive cruise control is primarily intended for use when driving on level road surfaces. It may have difficulty in keeping the correct distance from the vehicle ahead when driving on steep downhill slopes, with a heavy load or with a trailer - in which case, be extra attentive and ready to slow down.

Related information

- Adaptive cruise control - ACC* (p. 205)
- Adaptive cruise control* - deactivate (p. 212)
- Adaptive cruise control* - overtaking another vehicle (p. 212)

Adaptive cruise control* - overview

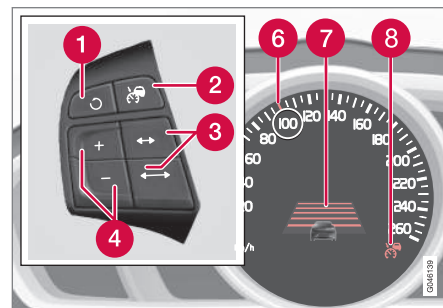

- 1 Standby mode ceases and the stored speed is resumed.
- 2 Cruise control - On/Off or Standby mode.
- 3 Time interval - Increase/decrease.
- 4 Activate and adjust the speed.
- 5 (Not used)
- 6 Green marking at stored speed (WHITE = standby mode).
- 7 Time distance
- 8 ACC is active at the GREEN symbol (WHITE = standby mode).

⁶ NOTE: The illustration is schematic - details may vary depending on car model.

* Option/accessory, for more information, see Introduction.



Related information



- Adaptive cruise control - ACC* (p. 205)
- Adaptive cruise control* - function (p. 206)
- Adaptive cruise control* - symbols and messages (p. 218)

Adaptive cruise control* - managing speed

To start the ACC:

- Press the steering wheel button  - a similar WHITE symbol illuminates in the combined instrument panel (8) which shows that the adaptive cruise control is in standby mode (p. 211).

To activate ACC:

- At the required speed - press the steering wheel button  or .
- > The current speed is stored in the memory, the combined instrument panel shows a "magnifying glass" (6) around the stored speed for a second or so and its marking changes from WHITE to GREEN.



When this symbol changes colour from WHITE to GREEN, the ACC is active and the car maintains the stored speed.

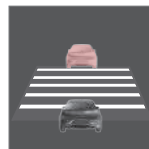



Only when the symbol shows an image of another vehicle is the **distance** to the vehicle in front controlled by the ACC.



At the same time a speed range is marked:

- the higher speed with GREEN marking is the pre-programmed speed
- the lower speed is the speed of the vehicle in front.

Changing the stored speed

Stored speed is changed with short or long presses on the  or  steering wheel button.

To adjust +/- 5 km/h:

- Use short presses - each press gives +/- 5 km/h.

To adjust +/- 1 km/h:

- Hold down the button and release it at the required speed.

Last press made is stored in the memory.

If speed is increased using the accelerator pedal prior to pressing the  button, then it is the car's current speed when the button is pressed that is stored.

A temporary increase in speed with the accelerator pedal, e.g. during overtaking, does not affect the setting - the car returns to the last



07 Driver support



stored speed when the accelerator pedal is released.

NOTE

If any of the adaptive cruise control buttons are held depressed for several minutes then the function is blocked and deactivated. To be able to reactivate it, the car must be stopped and the engine restarted.

In certain situations it cannot be reactivated - in which case, the combined instrument panel (p. 218) shows **Adaptive cruise control unavailable**.

Related information

- Adaptive cruise control - ACC* (p. 205)
- Adaptive cruise control* - overview (p. 208)
- Adaptive cruise control* - function (p. 206)

Adaptive cruise control* - set time interval



Different time intervals to the vehicle in front can be selected and shown in the combined instrument panel as 1-5 horizontal lines - the more lines the longer the time interval. One line corre-

sponds to approximately 1 second to the vehicle in front, 5 lines approximately 3 seconds.

To set/change the time distance:

- Increase or decrease with the steering wheel buttons .

At low speed, when the distances are short, the adaptive cruise control increases the time interval slightly.

The adaptive cruise control allows the time interval to vary noticeably in certain situations in order to allow the car to follow the vehicle in front smoothly and comfortably.

Note that a short time interval only allows the driver a short time to react and take action if any unforeseen traffic problem should arise.

The same symbol is also shown when Distance Warning (p. 220) function is activated.

NOTE

Only use the time intervals permitted by local traffic regulations.

If the adaptive cruise control does not appear to react when activated, this may be because the time distance to the vehicle in front is preventing an increase in speed.

The higher the speed the longer the calculated distance in metres for a given time interval.

Read more how speed is handled (p. 209).

Related information

- Adaptive cruise control - ACC* (p. 205)
- Adaptive cruise control* - overview (p. 208)
- Adaptive cruise control* - function (p. 206)
- Adaptive cruise control* - deactivate (p. 212)



Adaptive cruise control* - temporary deactivation, and standby mode

The adaptive cruise control can be temporarily deactivated and set in standby mode.

Temporary deactivation/standby mode

To temporarily disengage the adaptive cruise control and set it in standby mode:

- Press the steering wheel button 



This symbol and the stored speed's marking then change colour from GREEN to WHITE.

Standby mode due to driver intervention

The adaptive cruise control is temporarily disengaged and set automatically in standby mode if:

- the foot brake is used
- the clutch pedal is depressed for longer than 1 minute⁷
- the gear selector is moved to **N** position (automatic gearbox)
- the driver maintains speed higher than the stored speed for longer than 1 minute.

The driver must then regulate the speed.

A temporary increase in speed with the accelerator pedal, e.g. during overtaking, does not affect the setting - the car returns to the last

stored speed when the accelerator pedal is released.

Automatic standby mode

The adaptive cruise control is dependent on other systems, e.g. Stability system ESC (p. 196). If any of these systems stops working, the adaptive cruise control is deactivated automatically.

In the event of automatic deactivation a signal will sound and the message **Adaptive cruise control cancelled** is shown in the combined instrument panel. The driver must then intervene and adapt the speed and distance to the vehicle ahead.

An automatic deactivation can be due to:

- the driver opens the door
- the driver takes off his seatbelt
- engine speed is too low/high
- speed has fallen below 30 km/h⁸
- wheels lose traction
- brake temperature is high
- the radar sensor is covered e.g. by wet snow or heavy rain (radar waves blocked).

Resume set speed

Adaptive cruise control in standby mode is reactivated with one press on the steering

wheel button  - the speed is then set to the last stored speed.



NOTE

A pronounced increase in speed may occur after the cruise control has been reactivated with the  button.

Related information

- Adaptive cruise control - ACC* (p. 205)
- Adaptive cruise control* - overview (p. 208)
- Cruise control* (p. 203)

⁷ Disengaging and selecting a higher or lower gear does not involve standby mode.

⁸ Does not apply to a car with Queue assistance - it can go all the way down to 0 km/h.



Adaptive cruise control* - overtaking another vehicle

When the car is following another vehicle and the driver indicates an impending overtaking manoeuvre with the direction indicator⁹, the adaptive cruise control helps to briefly accelerate the car towards the vehicle in front.

This function is active at speeds above 70 km/h.



WARNING

Be aware that this function can be activated in more situations other than during overtaking, e.g. when a direction indicator is used to indicate a change of lane or exit to another road - the car will then accelerate briefly.

Related information

- Adaptive cruise control - ACC* (p. 205)
- Adaptive cruise control* - overview (p. 208)
- Adaptive cruise control* - function (p. 206)

Adaptive cruise control* - deactivate

With a short press on the steering wheel button  the adaptive cruise control is set in standby mode (p. 211). It is switched off with an additional short press - the set/stored speed is thus cleared and cannot then be resumed with the  button.

Related information

- Adaptive cruise control - ACC* (p. 205)
- Adaptive cruise control* - function (p. 206)
- Adaptive cruise control* - symbols and messages (p. 218)

Adaptive Cruise Control* - queue assistance

Queue assistance also provides the adaptive cruise control with enhanced functionality at speeds below 30 km/h.

In cars with automatic gearbox the adaptive cruise control is supplemented with the queue assistance function (also referred to as "Queue Assist").

Queue assistance has the following functions:

- Extended speed range - also below 30 km/h and when stationary
- Change of target
- Automatic braking ceases when stationary
- Automatic activation parking brake.

Note that the lowest programmable speed for the adaptive cruise control is 30 km/h - even though it is capable of following another vehicle down to a standstill, a speed lower than 30 km/h **cannot** be selected/stored.

⁹ On left flash only in left-hand-drive car, or right flash in right-hand-drive car.



Extended speed range

i NOTE

In order to activate the adaptive cruise control, the driver's door must be closed and the driver must be wearing the seat-belt.

With an automatic gearbox, the adaptive cruise control can follow another vehicle within the range 0-200 km/h.

i NOTE

A vehicle in front must be within a reasonable distance in order to enable activation of the adaptive cruise control at a speed lower than 30 km/h.

For shorter stops in connection with inching in slow traffic or at traffic lights driving is automatically resumed if the stops do not exceed about 3 seconds - if it takes longer before the car in front starts moving again then the Adaptive cruise control is set in standby mode with automatic braking. The driver must then reactivate it in one of the following ways:

- Press the steering wheel button .
- or
- Depress the accelerator pedal.

- > The adaptive cruise control will then resume following the vehicle in front.

i NOTE

The Queue Assist function can hold the car stationary for a maximum of 4 minutes - then the parking brake is applied and the adaptive cruise control is disengaged.

- The parking brake must be released before the adaptive cruise control can be reactivated.

Change of target

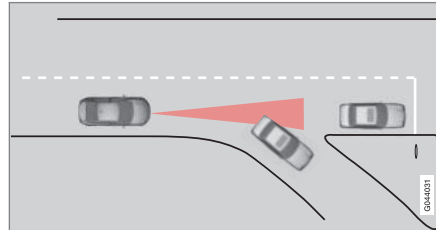

If the target vehicle in front suddenly turns then there may be stationary traffic in front.

When the adaptive cruise control is following another vehicle at speeds **below** 30 km/h and changes target from a moving to a stationary vehicle, the adaptive cruise control will slow down for the stationary vehicle.

! WARNING

When the adaptive cruise control is following another vehicle at speeds **in excess of** 30 km/h and the target is changed from a moving vehicle to a stationary vehicle, the adaptive cruise control will ignore the stationary vehicle and instead select the stored speed.

- The driver must intervene him/herself and brake.

Automatic standby mode with change of target

The adaptive cruise control is disengaged and set in standby mode:

- when the speed is below 5 km/h and the adaptive cruise control is uncertain whether the target object is a stationary vehicle or some other object, e.g. a speed bump.
- when the speed is below 5 km/h and the vehicle in front turns off so the adaptive cruise control no longer has a vehicle to follow.

Termination of automatic braking at a standstill

In certain situations, queue assistance stops automatic braking at a standstill. This means that the brakes are released and the car may start to roll - the driver must therefore intervene and brake the car himself/herself in order to maintain its position.



Queue assistance releases the foot brake and sets the adaptive cruise control in standby mode in the following situations:

- the driver puts his/her foot on the brake pedal
- the parking brake is applied
- the gear selector is moved to **P**, **N** or **R** position
- the driver sets the adaptive cruise control in standby mode.

Automatic activation parking brake

In certain situations queue assistance applies the parking brake in order to keep the car remaining stationary.

This takes place if:

- the driver opens the door or takes off his/her seatbelt
- ESC is changed from **Normal** to **Sport** mode
- Queue assistance has held the car stationary for more than 4 minutes
- the engine is switched off
- the brakes have overheated.

Related information

- Adaptive cruise control - ACC* (p. 205)
- Adaptive cruise control* - overview (p. 208)
- Adaptive cruise control* - function (p. 206)



Adaptive cruise control* - switch cruise control functionality

Changing from ACC to CC

A symbol for active cruise control is shown in the combined instrument panel:

CC Cruise Control	ACC Adaptive Cruise Control
Cruise control	Adaptive cruise control

With one press of the button the adaptive part (spacing system) in the cruise control is deactivated, at which point the car just follows the set/stored speed.

- Give a **long** press on the steering wheel button - the combined instrument panel's symbol changes from  to .
- > By these means the standard cruise control (p. 203) CC (Cruise Control) is activated.



WARNING

The car no longer brakes automatically after switching from ACC to CC - it merely follows the set speed.

Changing back from CC to ACC

Switch off cruise control with 1-2 presses on the  button in accordance with the deactivation instructions (p. 212). The next time the system is switched on it is the Adaptive cruise control that is activated.

Related information

- Adaptive cruise control - ACC* (p. 205)
- Adaptive cruise control* - overview (p. 208)
- Adaptive cruise control* - function (p. 206)



Radar sensor

The function of the radar sensor is to detect cars or larger vehicles in the same direction, in the same lane.

The radar sensor is used by the following functions:

- Distance Warning*
- Adaptive cruise control*
- Collision Warning System with Auto Brake and Cyclist and Pedestrian Detection*

IMPORTANT

In the event of visible damage to the car's grille, or if you suspect that the radar sensor may be damaged:

- Contact a workshop - an authorised Volvo workshop is recommended.

The function may completely or partially disappear - or malfunction - if the grille, the radar sensor or its bracket is damaged or has loosened.

Modification of the radar sensor could result in it being illegal to use.

Related information

- Radar sensor - limitations (p. 215)
- Adaptive cruise control - ACC* (p. 205)
- Collision warning system* (p. 230)
- Distance Warning* (p. 220)

Radar sensor - limitations

A radar sensor (p. 215) has certain limitations - due to its limited field of vision for example.

The capacity of the adaptive cruise control to detect a vehicle in front is significantly reduced if:

- the speed of vehicles in front is significantly different from your own speed
- its radar sensor becomes blocked - e.g. in heavy rain or slush, or if other objects have collected in front of the radar sensor.

NOTE

Keep the area in front of the radar sensor clean - see subheading "Maintenance" (p. 234).

Field of vision

The radar sensor has a limited field of vision. In some situations another vehicle is not detected, or the detection is made later than expected.

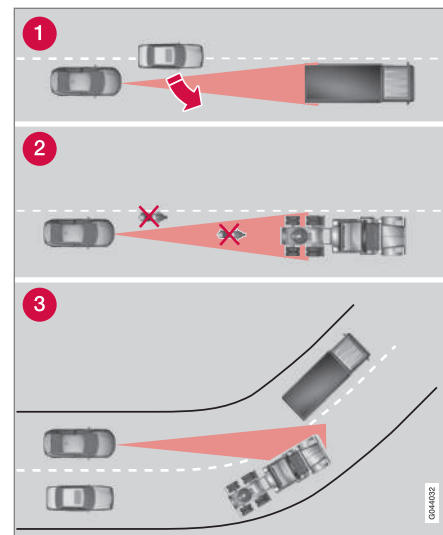

ACC field of vision.

- 1 Sometimes the radar sensor is late at detecting vehicles at close distances - e.g. a vehicle that drives in between the car and vehicles in front.
- 2 Small vehicles, such as motorcycles, or vehicles not driving in the centre of the lane can remain undetected.
- 3 In bends the radar sensor may detect the wrong vehicle or lose a detected vehicle from view.



07 Driver support



WARNING

The driver must always be observant with regard to the traffic conditions and intervene when the adaptive cruise control is not maintaining a suitable speed or suitable distance.

The adaptive cruise control cannot handle all traffic, weather and road conditions.

Read all the sections about the adaptive cruise control in the owner's manual in order to learn about its limitations, of which the driver should be aware before it is used.

The driver always bears responsibility for maintaining the correct distance and speed, even when the adaptive cruise control is being used.

WARNING

Accessories or other objects such as auxiliary lamps must not be fitted in front of the grille.

WARNING

Adaptive cruise control is not a collision avoidance system. The driver must intervene if the system does not detect a vehicle in front.

The adaptive cruise control does not brake for humans or animals, and not for small vehicles such as bicycles and motorcycles. Nor for oncoming, slow or stationary vehicles and objects.

Do not use the adaptive cruise control, for example, in city traffic, in dense traffic, at junctions, on slippery surfaces, with a lot of water or slush on the road, in heavy rain/snow, in poor visibility, on winding roads or on slip roads.

Related information

- Adaptive cruise control - ACC* (p. 205)
- Collision warning system* (p. 230)
- Distance Warning* (p. 220)



Adaptive cruise control* - fault tracing and action

If the combined instrument panel shows the message **Radar blocked** See manual then it means that the adaptive cruise control's radar

sensor (p. 215) cannot detect other vehicles in front of the car.

This message indicates that neither of the functions for Distance Alert (p. 220) or Colli-

sion Warning with Auto Brake (p. 230) are working.

The following table presents examples of possible causes for a message being shown along with the appropriate action:

Cause	Action
The radar surface in the grille is dirty or covered with ice or snow.	Clean the radar surface in the grille from dirt, ice and snow.
Heavy rain or snow blocking the radar signals.	No action. Sometimes the radar does not work during heavy rain or snowfall.
Water or snow from the road surface swirls up and blocks the radar signals.	No action. Sometimes the radar does not work on a very wet or snowy road surface.
The radar surface has been cleaned but the message remains.	Wait. It could take several minutes for the radar to sense that it is no longer blocked.

Related information

- Adaptive cruise control* - overview (p. 208)
- Adaptive cruise control* - function (p. 206)
- Adaptive cruise control* - symbols and messages (p. 218)







07 Driver support

Adaptive cruise control* - symbols and messages

Sometimes the adaptive cruise control may display a symbol and/or text message. Here

are some examples - follow the recommendation given if appropriate:

Symbol	Message	Specification
	The symbol is GREEN	The car maintains the stored speed.
	The symbol is WHITE	Adaptive cruise control is set to standby mode.
		Standard cruise control is selected manually.
	Set ESC to Normal to enable Cruise	The adaptive cruise control cannot be activated until the Stability system (ESC) (p. 196) has been set in Normal mode.
	Adaptive cruise control cancelled	The adaptive cruise control has been deactivated - the driver has to regulate the speed himself.
	Adaptive cruise control unavailable	The adaptive cruise control cannot be activated. This could be due to: <ul style="list-style-type: none"> • brake temperature is high • the radar sensor is blocked by e.g. wet snow or rain.
	Radar blocked See manual	The adaptive cruise control is temporarily disengaged. <ul style="list-style-type: none"> • The radar sensor is blocked and cannot detect other vehicles. For example, in the event of heavy rain or if slush has collected in front of the radar sensor. The driver can then choose to switch to (p. 214) normal Cruise control (CC) - a text message provides information on appropriate alternatives. Read about radar sensor limitations (p. 215).



Symbol	Message	Specification
	Adaptive cruise control Service required	The adaptive cruise control is disengaged. <ul style="list-style-type: none"> Contact a workshop - an authorised Volvo workshop is recommended.
	Press brake to hold vehicle + acoustic alarm^A	The car is stationary and the cruise control will release the foot brake to allow the parking brake to take over and hold the car, but a fault in the parking brake means the car will shortly begin to roll. <ul style="list-style-type: none"> The driver must brake himself/herself. The message remains and the alarm sounds until the driver depresses the brake pedal or uses the accelerator pedal.
	Below 30 km/h Lead vehicle required^A	Shown in the event of attempts to activate the adaptive cruise control at speeds below 30 km/h without a vehicle in front within the activation distance.

^A Only with Queue Assist.

Related information

- Adaptive cruise control - ACC* (p. 205)
- Adaptive cruise control* - overview (p. 208)
- Adaptive cruise control* - function (p. 206)



07 Driver support

Distance Warning*

The Distance Warning function (Distance Alert) warns the driver if the time interval to the vehicle ahead becomes too short.

Distance Warning is active at speeds above 30 km/h and only reacts to vehicles driving in front of the car, in the same direction. No distance information is provided for oncoming, slow or stationary vehicles.

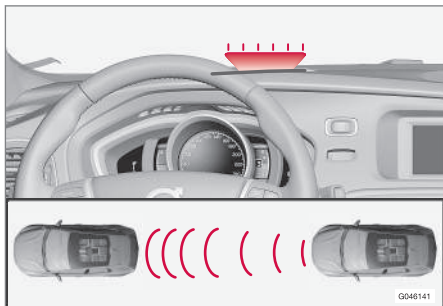

Orange-coloured warning lamp¹².

An orange-coloured warning lamp in the windscreen illuminates with a constant glow if the distance to the vehicle in front is shorter than the set time interval.

NOTE
Distance warning is deactivated during the time the adaptive cruise control is active.

WARNING
Distance warning only reacts if the distance to the vehicle ahead is shorter than the preset value - the speed of the driver's vehicle is not affected.

Operation

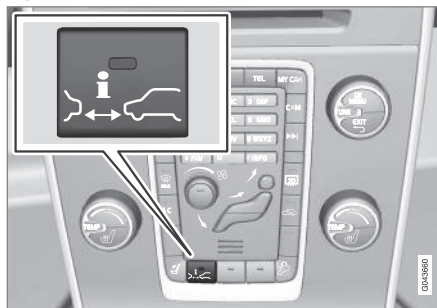

Press the button in the centre console to switch the function on or off. The function is switched on if one lamp is illuminated in the button.

Some combinations of the selected equipment leave no vacant space for a button in the centre console - in which case the func-

tion is operated in the car's menu system **MY CAR** (p. 116) - there, search for and locate the function **Distance Alert**.

Set time interval

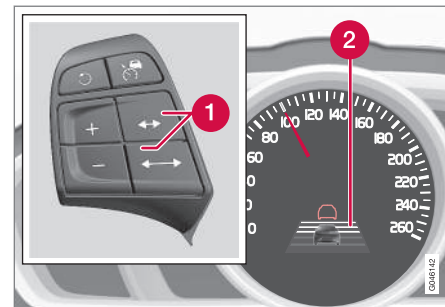

Controls and symbol for time interval.

- 1 Time interval - Increase/decrease.
- 2 Time interval - On.

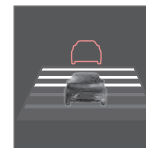

Different time intervals to the vehicle in front can be selected and shown in the combined instrument panel as 1-5 horizontal lines - the more lines the longer the time interval. One line corresponds to approximately 1 second to the vehicle in front, 5 lines approximately 3 seconds.

¹² NOTE: The illustration is schematic - details may vary depending on car model.

* Option/accessory, for more information, see Introduction.



The same symbol is also shown when Adaptive cruise control (p. 206) is activated.

i NOTE

The higher the speed the longer the calculated distance in metres for a given time interval.

The set time interval is also used by the function adaptive cruise control (p. 206).

Only use the time intervals permitted by local traffic regulations.

Related information

- Distance Warning* - limitations (p. 221)
- Distance Warning* - symbols and messages (p. 222)

Distance Warning* - limitations

This function, which uses the same radar sensor as Adaptive cruise control (p. 205) and Collision warning with auto brake (p. 230), has certain limitations.

i NOTE

Strong sunlight, reflections or strong variations in light intensity, as well as wearing sunglasses, could mean that the warning light in the windscreen cannot be seen.

Poor weather or winding roads could affect the radar sensor's capacity to detect vehicles in front.

The size of other vehicles could also affect detection capacity, e.g. motorcycles. This could mean that the warning lamp illuminates at a shorter distance than the setting or that the warning is temporarily absent.

Extremely high speeds can also cause the lamp to illuminate at a shorter distance than that set due to limitations in sensor range.

For further information on radar sensor limitations, see Radar sensor - limitations (p. 215) and (p. 235).

Related information

- Distance Warning* (p. 220)
- Distance Warning* - symbols and messages (p. 222)





07 Driver support

Distance Warning* - symbols and messages

instrument panel if the function is reduced due to its limitations.

The function has certain symbols and messages that can be shown in the combined

Symbol ^A	Message	Specification
	Radar blocked See manual	Distance Warning temporarily disengaged. The radar sensor is blocked and cannot detect other vehicles, e.g. in the event of heavy rain or if slush has collected in front of the radar sensor. Read about radar sensor limitations (p. 215).
	Collision warning Service required	Distance Warning and Collision Warning with Auto Brake fully or partially disengaged. Visit a workshop if the message remains - an authorised Volvo workshop is recommended.

^A Symbols are schematic - may vary by market and car model.

Related information

- Distance Warning* (p. 220)
- Distance Warning* - limitations (p. 221)



City Safety™

City Safety™ is a function for helping the driver to avoid a collision when driving in queues, amongst other things, when changes in the traffic ahead, combined with a lapse in attention, could lead to an incident.

The City Safety™ function is active at speeds under 50 km/h and it helps the driver by automatically braking the car in the event of imminent risk of collision with vehicles in front, should the driver not react in time by braking and/or steering away.

City Safety™ is activated in situations where the driver should have started braking earlier, which is why it cannot help the driver in every situation.

City Safety™ is designed to be activated as late as possible in order to avoid unnecessary intervention.

City Safety™ must not be used as an excuse for the driver to change his/her driving style. If the driver solely relies on City Safety™ to do the braking, there will be a collision sooner or later.

The driver or passengers normally only notice City Safety™ if a situation arises where the car is extremely close to being in a collision.

If the car is also equipped with Collision Warning with Auto Brake (p. 230)* these two systems complement each other.

IMPORTANT

Maintenance and replacement of City Safety™ components must only be performed by a workshop - an authorised Volvo workshop is recommended.

WARNING

City Safety™ does not engage in all driving situations or traffic, weather or road conditions.

City Safety™ does not react to vehicles driving in a different direction from the car, to small vehicles and motorcycles or to humans and animals.

City Safety™ can prevent collision at a speed difference of less than 15 km/h - at a higher speed difference, it is only possible to reduce collision speed. In order to obtain full brake function, the driver must depress the brake pedal.

Never wait for City Safety™ to engage. The driver always bears responsibility for maintaining the proper distance and speed.

Related information

- City Safety™ - limitations (p. 225)
- City Safety™ - function (p. 223)
- City Safety™ - operation (p. 224)
- City Safety™ - laser sensor (p. 227)
- City Safety™ - symbols and messages (p. 229)

City Safety™ - function

City Safety detects the traffic in front of the car with a laser sensor fitted in the top edge of the windscreen. If there is an imminent risk of collision, City Safety will automatically brake the car, which may be experienced as heavy braking.



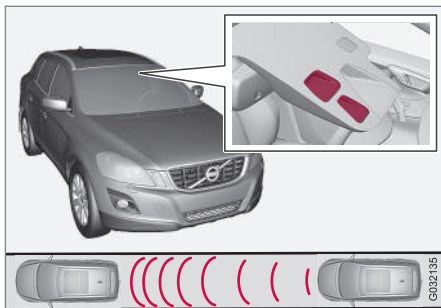

Laser sensor transmitter and receiver window¹³.

If the speed difference is 4-15 km/h in relation to the vehicle in front then City Safety can completely avoid a collision.

City Safety activates a short, sharp braking procedure and stops the car in normal circumstances, just behind the vehicle in front. For most drivers this is well outside normal driving style and may be experienced as being uncomfortable.

If the difference in speed between the vehicles is greater than 15 km/h then City Safety may not avoid the collision on its own - to obtain full brake force, the driver must depress the brake pedal and this could then make it possible to avoid a collision, even at speed differences above 15 km/h.

When the function is activated and brakes, the combined instrument panel shows a text message to the effect that the function is/has been active.

NOTE

When City Safety™ brakes, the brake lights come on.

Related information

- City Safety™ - limitations (p. 225)
- City Safety™ (p. 223)
- City Safety™ - operation (p. 224)
- City Safety™ - laser sensor (p. 227)
- City Safety™ - symbols and messages (p. 229)

City Safety™ - operation

City Safety™ is a function for helping the driver to avoid a collision when driving in queues, amongst other things, when changes in the traffic ahead, combined with a lapse in attention, could lead to an incident.

On and Off

NOTE

The City Safety™ function is activated automatically when the engine is started.

In certain situations, it may be advisable to disable City Safety™, e.g. where leafy branches could sweep over the bonnet and/or windscreen.

City Safety™ handled in the menu system **MY CAR** (p. 116) and after starting the engine the function can be deactivated as follows:

- Search in **MY CAR** for **Driver support system** and select the **Off** option at **City Safety**.

However, the function will be enabled the next time the engine is started, regardless of whether the system was enabled or disabled when the engine was switched off.

¹³ NOTE: The illustration is schematic - details may vary depending on car model.

**WARNING**

The laser sensor also transmits laser light when City Safety™ is disabled manually.

Related information

- City Safety™ (p. 223)
- City Safety™ - limitations (p. 225)
- City Safety™ - function (p. 223)
- City Safety™ - laser sensor (p. 227)
- City Safety™ - symbols and messages (p. 229)
- MY CAR (p. 116)

City Safety™ - limitations

The sensor in City Safety is designed to detect cars and other large vehicles in front of the car irrespective of whether it is day or night.

However, the function does have some limitations.

The sensor's limitations mean that City Safety has poorer functionality - or none at all - in e.g. heavy snowfall or rain, dense fog, dust storms or white-out situations. Misting, dirt, ice or snow on the windscreen may also disrupt the function.

Low-hanging objects, e.g. a flag/pennant for projecting load, or accessories such as auxiliary lamps and bull bars that are higher than the bonnet limit the function.

The laser beam from the sensor in City Safety measures how the light is reflected. The sensor cannot detect objects with low reflection capacity. The rear sections of the vehicle generally reflect the light sufficiently thanks to the number plate and rear light reflectors.

On slippery road surfaces the braking distance is extended, which may reduce the capacity of City Safety to avoid a collision. In such situations the ABS¹⁴ and ESC¹⁵ systems will provide best possible braking force with maintained stability.

When your own car is reversing, City Safety is temporarily deactivated.

City Safety is not activated at low speeds - under 4 km/h, which is why the system does not intervene in situations where a vehicle in front is being approached very slowly, e.g. when parking.

Driver commands are always prioritised, which is why City Safety does not intervene in situations where the driver is steering or accelerating in a clear manner, even if a collision is unavoidable.

When City Safety has prevented a collision with a stationary object the car remains stationary for a maximum of 1.5 seconds. If the car is braked for a vehicle in front that is moving, then speed is reduced to the same speed as that maintained by the vehicle in front.

On a car with manual gearbox the engine stops when City Safety has stopped the car, unless the driver manages to depress the clutch pedal beforehand.

¹⁴ (Anti-lock Braking System) - Anti-lock braking system.

¹⁵ (Electronic Stability Control) - Stability system.



NOTE

- Keep the windscreen surface in front of the laser sensor free from ice, snow and dirt (see the illustration for sensor location (p. 223)).
- Do not affix or mount anything on the windscreen in front of the laser sensor.
- Remove ice and snow from the bonnet - snow and ice must not exceed a height of 5 cm.

Fault tracing and action

If the message **Windscreen sensors blocked** See manual is shown in the combined instrument panel it indicates that the laser sensor is blocked and cannot detect vehicles in front of the car. This means in turn that City Safety is not operational.

The **Windscreen sensors blocked** See manual message is not shown for all situations in which the laser sensor is blocked. The driver must therefore be diligent about keeping the windscreen and area in front of the laser sensor clean.

The following table presents possible causes for the message being shown, along with suggestions for appropriate action.

Cause	Action
The windscreen surface in front of the laser sensor is dirty or covered with ice or snow.	Clean the windscreen surface in front of the sensor from dirt, ice and snow.
The laser sensor field of vision is blocked.	Remove the blocking object.

IMPORTANT

If there are cracks, scratches or stone chips in the windscreen in front of either of the laser sensor's "windows" and they cover a surface of approx. 0.5 x 3.0 mm (or larger), then a workshop must be contacted for replacement of the windscreen (see the illustration for sensor location (p. 223)) - an authorised Volvo workshop is recommended.

Failure to take action may result in reduced performance for City Safety™.

To avoid the risk of failed, deficient or reduced operation for City Safety™, the following also applies:

- Volvo recommends that you do **not** repair cracks, scratches or stone chips in the area in front of the laser sensor - instead, the whole windscreen should be replaced.
- Before replacing a windscreen, contact an authorised Volvo workshop to verify that the correct windscreen is ordered and fitted.
- The same type or Volvo-approved windscreen wipers must be fitted during replacement.

Related information

- City Safety™ (p. 223)
- City Safety™ - function (p. 223)
- City Safety™ - operation (p. 224)



City Safety™ - laser sensor

The City Safety™ function includes a sensor which transmits laser light (see illustration (p. 223) for sensor location). Contact a qualified workshop in the event of a fault or if the laser sensor needs servicing - an authorised Volvo workshop is recommended. It is absolutely essential to follow the prescribed instructions when handling the laser sensor.

The following two labels relate to the laser sensor:

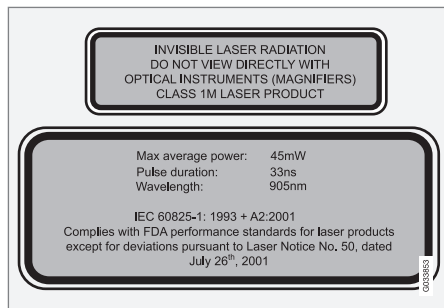

The upper label in the figure describes the laser beam's classification:

- Laser radiation - Do not look into the laser beam with optical instruments - Class 1M laser product.

The lower label in the figure describes the laser beam's physical data:

- IEC 60825-1:1993 + A2:2001. Complies with FDA (U.S. Food Administration) standards for laser product design with the exception of deviations in accordance with "Laser Notice No. 50" from 26 July 2001.

Radiation data for the laser sensor

The following table specifies the laser sensor's physical data.

Maximum pulse energy	2.64 μ J
Maximum average output	45 mW
Pulse duration	33 ns
Divergence (horizontal x vertical)	28° x 12°

WARNING

If any of these instructions are not followed then there is a risk of eye injury!

- Never look into the laser sensor (which emits spreading invisible laser radiation) at a distance of 100 mm or closer with magnifying optics such as a magnifying glass, microscope, lens or similar optical instruments.
- Testing, repair, removal, adjustment and/or replacement of the laser sensor's spare parts must only be carried out by a qualified workshop - we recommend an authorised Volvo workshop.
- To avoid exposure to harmful radiation, do not carry out any readjustments or maintenance other than those specified here.
- The repairer must follow specially drawn up workshop information for the laser sensor.
- Do not remove the laser sensor (this includes removing the lenses). A removed laser sensor does not fulfil laser class 3B as per standard IEC 60825-1. Laser class 3B is not eye-safe and therefore entails a risk of injury.
- The laser sensor's connector must be unplugged before removal from the windscreen.



- The laser sensor must be fitted onto the windscreen before the sensor's connector is plugged in.
- The laser sensor transmits a laser light when the remote control key is in key position **II** (p. 81) even if the engine is switched off.

Related information

- City Safety™ (p. 223)
- City Safety™ - limitations (p. 225)
- City Safety™ - function (p. 223)
- City Safety™ - operation (p. 224)
- City Safety™ - symbols and messages (p. 229)





City Safety™ - symbols and messages

In conjunction with automatic braking by the City Safety™ (p. 223) system, one or more

symbols may illuminate in the combined instrument panel and a text message may be shown. A text message can be acknowledged

by briefly pressing the **OK** button on the direction indicator stalk.

Symbol	Message	Meaning/Action
	Auto braking by City Safety	City Safety™ is braking or has automatically braked.
	Windscreen sensors blocked See manual	The laser sensor is temporarily non-operational because something is blocking it. <ul style="list-style-type: none"> Remove the object blocking the sensor and/or clean the windscreen in front of the sensor. Read about laser sensor limitations (p. 225).
	City Safety Service required	City Safety™ is not operational. <ul style="list-style-type: none"> Visit a workshop if the message remains - an authorised Volvo workshop is recommended.

Related information

- City Safety™ (p. 223)
- City Safety™ - limitations (p. 225)
- City Safety™ - function (p. 223)
- City Safety™ - operation (p. 224)
- City Safety™ - laser sensor (p. 227)



Collision warning system*¹⁶

"Collision Warning with Auto Brake and Cyclist and Pedestrian Detection" is an aid to assist the driver when there is a risk of colliding with a pedestrian, cyclist or vehicle in front that are stationary or moving in the same direction.

"Collision Warning with Auto Brake and Cyclist and Pedestrian Detection" is activated in situations where the driver should have started braking earlier, which is why it cannot help the driver in every situation.

"Collision Warning with Auto Brake and Cyclist and Pedestrian Detection" is designed to be activated as late as possible in order to avoid unnecessary intervention.

"Collision Warning with Auto Brake and Cyclist and Pedestrian Detection" can prevent a collision or reduce collision speed.

"Collision Warning with Auto Brake and Cyclist and Pedestrian Detection" must not be used as an excuse for the driver to change his/her driving style. If the driver solely relies on Collision Warning with Auto Brake to do the braking, there might be a risk of a collision sooner or later.

Two system levels

Depending on how the car is equipped, the "Collision Warning with Auto Brake and Cyclist and Pedestrian Detection" function may appear in two variants:

Level 1

The driver is merely warned¹⁷ of occurring obstacles by means of visual and acoustic signals - no automatic braking intervenes, the driver must himself brake.

Level 2

The driver is warned of occurring obstacles by means of visual and acoustic signals - the car is braked automatically if the driver himself does not act within a reasonable time.



IMPORTANT

Maintenance of the internal components of the "Collision Warning with Auto Brake and Cyclist and Pedestrian Detection" must only be performed at a workshop - an authorised Volvo workshop is recommended.

Related information

- Collision warning system* - function (p. 231)
- Collision warning system* - detection of pedestrians (p. 233)

- Collision warning system* - detection of cyclists (p. 232)
- Collision warning system* - operation (p. 234)
- Collision warning system* - limitations (p. 235)
- Collision warning system* - camera sensor limitations (p. 236)
- Collision warning system* - symbols and messages (p. 238)

¹⁶ Not available as an option for certain engines.

¹⁷ No warning for cyclists with "Level 1".



Collision warning system* - function

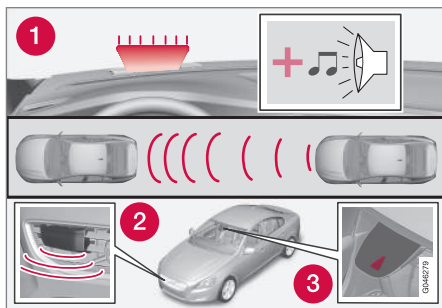

Function overview¹⁸.

- 1 Audio-visual warning signal in the event of a collision risk.
- 2 Radar sensor¹⁹
- 3 Camera sensor

Collision Warning with Auto Brake executes three steps in the following order:

1. **Collision warning**
2. **Brake support**¹⁹
3. **Auto Brake**¹⁹

The collision warning system and City Safety™ (p. 223) complement each other.

1 - Collision warning

The driver is first warned of a potentially imminent collision.

The collision warning system can detect pedestrians, cyclists or vehicles that are stationary or moving in the same direction in front of the driver's vehicle.

If there is a risk of collision with a pedestrian, cyclist or a vehicle then the driver's attention is attracted with a flashing red warning signal (1) and an acoustic signal.

2 - Brake support¹⁹

If the risk of collision has increased further after the collision warning then the brake support is activated.

This means that the brake system is prepared for rapid braking by applying the brakes lightly, which may feel like a slight jolt.

If the brake pedal is depressed sufficiently quickly then full brake function is implemented.

Brake support also reinforces the driver's braking if the system considers that the braking is not sufficient to avoid a collision.

3 - Auto Brake¹⁹

The automatic brake function is activated last.

If in this situation the driver has not yet started to take evasive action and the risk of collision is imminent then the automatic braking function is deployed - this takes place irrespective of whether or not the driver brakes. Braking then takes place with full brake force in order to reduce collision speed, or with limited brake force if it is sufficient to avoid a collision. For cyclists, the warning and full brake intervention may come very late or simultaneously.

¹⁸ NOTE: The illustration is schematic - details may vary depending on car model.

¹⁹ With system Level 2 only.



07 Driver support



! WARNING

The collision warning system does not engage in all driving situations or traffic, weather or road conditions. The collision warning system does not react to vehicles or cyclists driving in another direction to the car or to animals.

Warning only activated in the event of a high risk for collision. This section "Function" and the section "Limitations" inform about limitations that the driver must be aware of before using the Collision Warning system with Auto Brake.

Warnings and brake interventions for pedestrians and cyclists are deactivated at a vehicle speed exceeding 80 km/h.

Warnings and brake interventions for pedestrians and cyclists do not work in darkness and tunnels - not even when streetlights are lit.

The auto-brake function can prevent a collision or reduce collision speed. To ensure full brake performance, the driver should always depress the brake pedal - even when the car auto-brakes.

Never wait for a collision warning. The driver is always responsible that the correct distance and speed are maintained - even when the collision warning system with auto-brake is used.

Related information

- Collision warning system* (p. 230)

²¹ The reflector must fulfil the recommendations and conditions of the traffic authority in the market in question.

Collision warning system* - detection of cyclists

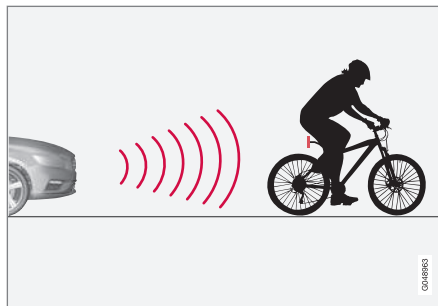

The function only "sees" cyclists from behind, who are travelling in the same direction.

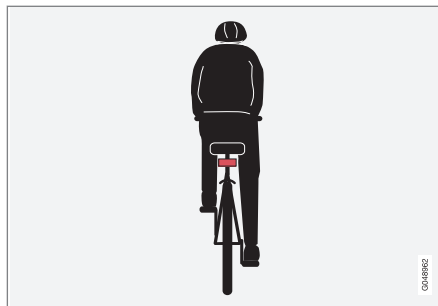

Optimum examples of what the system interprets as a cyclist - with clear body and bicycle con-

tours, directly from behind and in the car's centre line.

Optimal performance of the system requires that the system function that detects a cyclist receives as unambiguous information as possible about the body and bicycle contours - this implies the opportunity to identify the bicycle, head, arms, shoulders, legs, upper and lower body combined with a normal human pattern of movement.

If large parts of the cyclist's body or bicycle are not visible to the function's camera then the system cannot detect a cyclist.

- For the function to be able to detect a cyclist, he/she must be an adult and riding an "adult bicycle".
- The bicycle must be equipped with a highly visible and approved²¹ rearward-facing red reflector, fitted at least 70 cm above the roadway.
- The function can only detect cyclists directly from behind and who are travelling in the same direction - not at an angle from behind, not from the side.
- Cyclists travelling on the left or right-hand edge of the car's imagined/extended side lines may be detected late or not at all.
- The function's capacity to detect cyclists at dusk and dawn is limited - just like the human eye.



- The function's capacity to detect cyclists is deactivated when driving in darkness and tunnels - even when streetlights are lit.
- For optimum bicycle detection, the City Safety™ function must be activated, see City Safety™ (p. 223).

WARNING

Collision Warning with Auto Brake & Cyclist Detection is a means of assistance.

The function cannot detect:

- all cyclists in all situations and does not see partially obscured cyclists, for example.
- cyclists in clothing that obscures the contours of the body or who are approaching from the side.
- bicycles that have no rearward-facing red reflector.
- bicycles loaded with large objects.

The driver is always responsible that the vehicle is driven properly and with a safety distance adapted to the speed.

Related information

- Collision warning system* (p. 230)

Collision warning system* - detection of pedestrians

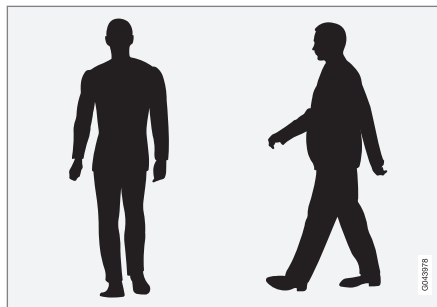

Optimal examples of what the system regards as pedestrians with clear body contours.

Optimal performance of the system requires that the system function that detects pedestrians receives as unambiguous information as possible about the contours of the body - this implies the opportunity to identify the head, arms, shoulders, legs, upper and lower body combined with a normal human pattern of movement.

If large parts of the body are not visible to the function's camera then the system cannot detect a pedestrian.

- In order for a pedestrian to be detected he/she must appear full-length and have a height of at least 80 cm.
- The camera sensor's ability to see pedestrians at dusk and dawn is limited - just like the human eye.
- The camera sensor's capacity to detect pedestrians is deactivated when driving in darkness and tunnels - even when streetlights are lit.

WARNING

"Collision Warning with Auto Brake and Cyclist and Pedestrian Detection" is a means of assistance. The function cannot detect all pedestrians in all situations and does not see, for example:

- partially obscured pedestrians, people in clothing that hides their body contour or pedestrians shorter than 80 cm.
- pedestrians who are carrying larger objects.

The driver is always responsible that the vehicle is driven properly and with a safety distance adapted to the speed.

Related information

- Collision warning system* (p. 230)



Collision warning system* - operation

Warning signals On and Off

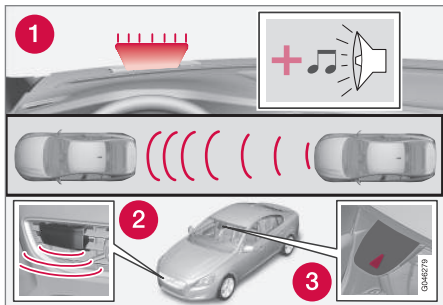

1. Acoustic and visual warning signal in the event of a collision risk.²⁴

You can select whether the collision warning system's acoustic and visual warning signals should be switched on or off.

When starting the engine, the setting that was selected when the engine was switched off is obtained automatically.

NOTE

The Brake Support and Auto Brake functions are always enabled - they cannot be deactivated.

Settings for the collision warning system are made via the centre console's screen and the menu system **MY CAR**, see (p. 116).

Light and acoustic signals

When the collision warning system's light and acoustic warnings are activated, the warning lamp (no. [1] in previous illustration) is tested each time the engine is started by briefly illuminating the warning lamp's separate points of light.

After starting the engine, both the light and acoustic signals can be switched off:

- Search for **Collision warning** in **Driver support system** in the menu system **MY CAR** (p. 116) - and there select to uncheck the function.

Acoustic signal

After starting the engine the warning sound can be activated/deactivated separately:

- Search for **Warning sound** in **Collision warning** in the menu system **MY CAR** (p. 116) - and there select On or Off.

Following which, the collision warning system is only indicated with a light signal.

Set warning distance

The warning distance regulates the distance at which the visual and acoustic warnings are deployed.

- Search for **Warning distance** in **Collision warning** in the menu system **MY CAR** (p. 116) - and there select **Long**, **Normal** or **Short**.

The warning distance determines the system's sensitivity. Warning distance **Long** provides an earlier warning. First test with **Long** and if this setting produces too many warnings, which could be perceived as irritating in certain situations, then change to warning distance **Normal**.

Only use warning distance **Short** in exceptional cases, e.g. for dynamic driving.

NOTE

When the adaptive cruise control is in use the warning lamp and warning sound will be used by the cruise control even if the collision warning system is switched off.

The collision warning system warns the driver in the event of a risk of a collision, but the function cannot shorten driver reaction time.

In order for the collision warning system to be effective, always drive with Distance Warning (p. 220) set at time interval 4–5.

²⁴ The illustration is schematic - car model and details may differ.

**i NOTE**

Even if the warning distance has been set to **Long** warnings could be perceived as being late in certain situations, e.g. when there are large differences in speed or if vehicles in front brake heavily.

! WARNING

No automatic system can guarantee 100 % correct function in all situations. Therefore, never test Collision Warning with Auto Brake by driving at people or vehicles - this may cause severe damage and injury and risk lives.

Checking settings

The current settings can be controlled via the centre console's screen and the menu system (p. 116) **MY CAR**.

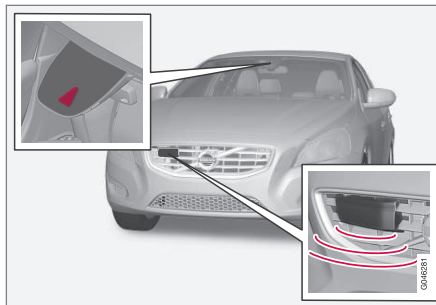
Maintenance

Camera and radar sensor²⁵.

For the sensors to work correctly, they must be kept clear of dirt, ice and snow, and be cleaned regularly with water and car shampoo.

i NOTE

Dirt, ice and snow covering the sensors will reduce their function and may prevent measurement.

Related information

- Collision warning system* (p. 230)

Collision warning system* - limitations

The function has certain limitations - for example, it is not active until approx. 4 km/h.

The collision warning system's visual warning signal (see (1) in the illustration (p. 231)) may be difficult to notice in the event of strong sunlight, reflections, when sunglasses are being worn or if the driver is not looking straight ahead. The warning sound should therefore always be activated.

On slippery road surfaces the braking distance is extended, which may reduce the capacity to avoid a collision. In such situations the ABS and ESC (p. 196) systems will provide best possible braking force with maintained stability.

i NOTE

The visual warning signal can be temporarily disengaged in the event of high passenger compartment temperature caused by strong sunlight for example. If this occurs then the warning sound is activated even if it is deactivated in the menu system.

- Warnings may not appear if the distance to the vehicle in front is small or if steering wheel and pedal movements are large, e.g. a very active driving style.

²⁵ NOTE: The illustration is schematic - details may vary depending on car model.



WARNING

Warnings and brake interventions could be implemented late or not at all if the traffic situation or external influences mean that the radar or camera sensor cannot detect a pedestrian, a vehicle or a cyclist in front correctly.

The sensor system has a limited range for pedestrians and cyclists²⁷ - the system can provide effective warnings and brake interventions for them at vehicle speeds up to 50 km/h. For stationary or slow-moving vehicles, warnings and brake interventions are effective at vehicle speeds up to 70 km/h.

Warnings for stationary or slow-moving vehicles could be disengaged due to darkness or poor visibility.

Warnings and brake interventions for pedestrians and cyclists are deactivated at vehicle speeds exceeding 80 km/h.

The collision warning system uses the same radar sensors as the Adaptive cruise control (p. 205). Read more about radar sensor limitations (p. 215).

If warnings are perceived as being too frequent or disturbing then the warning distance can be reduced (p. 234). This would lead to the system warning at a later stage, which reduces the total number of warnings.

Collision Warning with Auto Brake is temporarily deactivated with reverse gear engaged.

Collision Warning with Auto Brake is not activated at low speeds - under 4 km/h, which is why the system does not intervene in situations where the car is approaching a vehicle in front very slowly, e.g. when parking.

In situations where the driver demonstrates active, aware driving behaviour, a collision warning may be postponed slightly in order to keep unnecessary warnings to a minimum.

When Auto Brake has prevented a collision with a stationary object the car remains stationary for a maximum of 1.5 seconds. If the car is braked for a vehicle in front that is moving, then speed is reduced to the same speed as that maintained by the vehicle in front.

On a car with manual gearbox the engine stops when Auto Brake has stopped the car, unless the driver manages to depress the clutch pedal beforehand.

Related information

- Collision warning system* (p. 230)

Collision warning system* - camera sensor limitations

"Collision Warning with Auto Brake and Cyclist and Pedestrian Detection" is an aid to assist the driver when there is a risk of colliding with a pedestrian, bicycle or vehicle in front that are stationary or moving in the same direction.

The function uses the car's camera sensor, which has certain limitations.

The car's camera sensor is also used - as well as by Collision Warning with Auto Brake - by the functions:

- Active main beam (p. 93)
- Road sign information (p. 200)
- Driver Alert Control - DAC (p. 240)
- Lane assistance (p. 243)



NOTE

Keep the windscreen surface in front of the camera sensor free from ice, snow, mist and dirt.

Do not stick or attach anything to the windscreen in front of the camera sensor as this may reduce effectiveness or cause one or more of the systems dependent on the camera to stop working.

²⁷ For cyclists, the warning and full brake intervention may come very late or simultaneously.



The camera sensors have limitations similar to the human eye, i.e. they "see" worse in darkness, heavy snowfall or rain and in thick fog for example. Under such conditions the functions of camera-dependent systems could be significantly reduced or temporarily disengaged.

Strong oncoming light, reflections in the carriageway, snow or ice on the road surface, dirty road surfaces or unclear lane markings could also significantly reduce camera sensor function when it is used to scan the carriage-way and detect pedestrians and other vehicles.

The field of vision of the camera sensor is limited, which is why pedestrians, cyclists and vehicles cannot be detected in some situations, or they are detected later than anticipated.

During very high temperatures the camera is temporarily switched off for about 15 minutes after the engine is started in order to protect camera functionality.

Fault tracing and action

If the display shows the message **Windscreen sensors blocked** See manual then this means that the camera sensor is blocked and cannot detect pedestrians, cyclists, vehicles or road markings in front of the car.

At the same time, this means that - besides Collision Warning with Auto Brake - the following functions will not have full functionality either:

- Active main beam
- Driver Alert Control
- Road sign information

The following table presents possible causes for a message being shown along with the appropriate action.

Cause	Action
The windscreen surface in front of the camera is dirty or covered with ice or snow.	Clean the windscreen surface in front of the camera from dirt, ice and snow.
Thick fog, heavy rain or snow means that the camera does not work sufficiently well.	No action. At times the camera does not work during heavy rain or snowfall.

Cause	Action
The windscreen surface in front of the camera has been cleaned but the message remains.	Wait. It may take several minutes for the camera to measure the visibility.
Dirt has appeared between the inside of the windscreen and the camera.	Visit a workshop to have the windscreen inside the camera cover cleaned - an authorised Volvo workshop is recommended.

Related information

- Collision warning system* (p. 230)







07 Driver support



Collision warning system* - symbols and messages

"Collision Warning with Auto Brake and Cyclist and Pedestrian Detection" is an aid to

assist the driver when there is a risk of colliding with a pedestrian, bicycle or vehicle in front that are stationary or moving in the same direction.

Symbol ^A	Message	Specification
	Collision warning system OFF	Collision warning system switched off. Shown when the engine is started. The message clears after about 5 seconds or after one press of the OK button.
	Collision warning system Unavailable	The collision warning system cannot be activated. Shown when the driver attempts to activate the function. The message clears after about 5 seconds or after one press of the OK button.
	Auto Braking was activated	Auto Brake has been active. The message clears after one press of the OK button.
	Windscreen sensors blocked See manual	The camera sensor is temporarily disengaged. Shown in the event of snow, ice or dirt on the windscreen for example. <ul style="list-style-type: none"> Clean the windscreen surface in front of the camera sensor. Read about camera sensor limitations (p. 236).



Symbol ^A	Message	Specification
	Radar blocked See manual	<p>Collision Warning with Auto Brake is temporarily disengaged.</p> <p>The radar sensor is blocked and cannot detect other vehicles. For example, in the event of heavy rain or if slush has collected in front of the radar sensor.</p> <p>Read about radar sensor limitations (p. 215).</p>
	Collision warning Service required	<p>Collision Warning with Auto Brake is fully or partially disengaged.</p> <ul style="list-style-type: none"> Visit a workshop if the message remains - an authorised Volvo workshop is recommended.

^A Symbols are schematic - may vary by market and car model.

Related information

- Collision warning system* (p. 230)
- Collision warning system* - function (p. 231)
- Collision warning system* - detection of pedestrians (p. 233)
- Collision warning system* - detection of cyclists (p. 232)
- Collision warning system* - operation (p. 234)
- Collision warning system* - limitations (p. 235)
- Collision warning system* - camera sensor limitations (p. 236)



Driver Alert System*³¹

The Driver Alert System is intended to assist drivers whose driving ability is deteriorating or who are inadvertently leaving the lane they are driving on.

The Driver Alert System consists of different functions which can either be switched on at the same time or individually:

- Driver Alert Control - DAC (p. 241).
- Lane Departure Warning - LDW (p. 243).

A switched-on function is set in standby mode and is not activated automatically until speed exceeds 65 km/h.

The function is deactivated again when speed decreases to below 60 km/h.

Both functions use a camera which is dependent on the lane having side markings painted on each side.



WARNING

Driver Alert System does not work in all situations but is designed merely as a supplementary aid.

The driver always bears ultimate responsibility for ensuring that the vehicle is driven safely.

Related information

- Driver Alert Control (DAC)* (p. 240)
- Lane Departure Warning (LDW)* (p. 243)

Driver Alert Control (DAC)*

The DAC function is intended to attract the driver's attention when he/she starts to drive less consistently, e.g. if he/she becomes distracted or starts to fall asleep.

The objective for DAC is to detect slowly deteriorating driving ability and it is primarily intended for major roads. The function is not intended for city traffic.

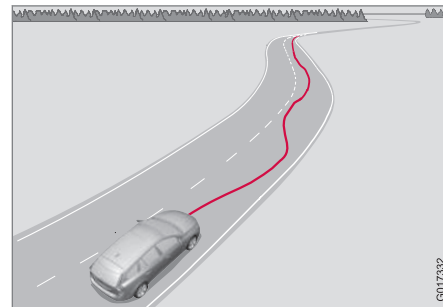

A camera detects the side markings painted on the carriageway and compares the section of the road with the driver's steering wheel movements. The driver is alerted if the vehicle does not follow the carriageway evenly.

In some cases driving ability is not affected despite driver fatigue. In which case there may not be any warning issued for the driver.

³¹ Not available as an option for certain engines.



For this reason it is always important to stop and take a break in the event of any signs of driver fatigue, irrespective of whether or not DAC issues a warning.

NOTE

The function must not be used to extend a period of driving. Always plan breaks at regular intervals, and make sure you are well rested.

Limitation

In some cases the system may issue a warning despite driving ability not deteriorating, for example:

- in strong side winds
- on rutted road surfaces.

NOTE

The camera sensor has certain limitations (p. 236).

Related information

- Driver Alert System* (p. 240)
- Driver Alert Control (DAC)* - operation (p. 241)
- Driver Alert Control (DAC)* - symbols and messages (p. 242)

Driver Alert Control (DAC)* - operation

Settings are made from the centre console display screen and its menu system.

On/Off

The Driver Alert function can be set in standby mode via the menu system **MY CAR** (p. 116):

- Checked box - function activated.
- Unchecked box - the function is deactivated.

Function

Driver Alert is activated when speed exceeds 65 km/h and remains active as long as the speed is over 60 km/h.



If the vehicle is being driven erratically, the driver is notified by an acoustic signal plus the text message **Driver Alert Time for a break**

- the linked symbol is illuminated in the combined instrument panel at the same time. The warning is repeated after a time if driving ability does not improve.

The warning symbol can go off:

- Press the left stalk switch **OK** button.

WARNING

An alarm should be taken very seriously, as a sleepy driver is often not aware of his/her own condition.

In the event of an alarm or a feeling of tiredness; stop the car in a safe manner as soon as possible and rest.

Studies have shown that it is equally as dangerous to drive while tired as it is under the influence of alcohol.

Related information

- Driver Alert System* (p. 240)
- Driver Alert Control (DAC)* (p. 240)





07 Driver support

Driver Alert Control (DAC)* - symbols and messages

DAC (p. 240) can show symbols and text messages on the combined instrument panel

or in the centre console's display screen in different situations.

Here are some examples:

Symbol ^A	Message	Specification
	Driver Alert Time for a break	The vehicle has been driven inconsistently - the driver is alerted by an acoustic warning signal + text.
	Windscreen sensors blocked See manual	The camera sensor is temporarily disengaged. Shown in the event of snow, ice or dirt on the windscreen for example. <ul style="list-style-type: none"> Clean the windscreen surface in front of the camera sensor. Read about camera sensor limitations (p. 236).
	Driver Alert system Service required	The system is disengaged. <ul style="list-style-type: none"> Visit a workshop if the message remains - an authorised Volvo workshop is recommended.

^A Symbols are schematic - may vary by market and car model.

Related information

- Driver Alert System* (p. 240)
- Driver Alert Control (DAC)* (p. 240)
- Driver Alert Control (DAC)* - operation (p. 241)

* Option/accessory, for more information, see Introduction.



Lane Departure Warning (LDW)*

The purpose of Lane Departure Warning (Lane Departure Warning) is to help the driver to reduce the risk of the vehicle accidentally leaving its own lane in certain situations on motorways and similar major routes.

Principle for LDW

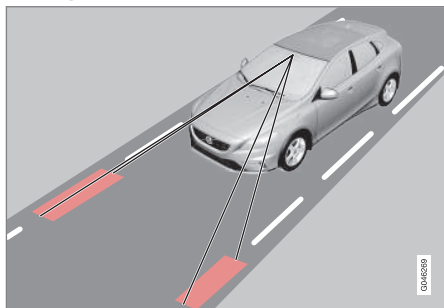

(The figure is schematic - not model specific.)

A camera reads the side lines of the road/ lane.

If the car crosses one of the side lines the driver is alerted with an acoustic signal.

NOTE

The driver is only warned once each time the wheels cross a line. So there is no acoustic alarm when there is a line between the car's wheels.

WARNING

Lane assistance is merely a driver aid and does not engage in all driving situations or traffic, weather or road conditions.

The driver always bears ultimate responsibility for ensuring that the vehicle is driven safely and that applicable laws and road traffic regulations are followed.

Related information

- Lane Departure Warning (LDW) - function (p. 243)
- Lane Departure Warning (LDW) - operation (p. 244)
- Lane Departure Warning (LDW) - limitations (p. 245)
- Lane Departure Warning (LDW) - symbols and messages (p. 246)
- Driver Alert System* (p. 240)

Lane Departure Warning (LDW) - function

Certain settings can be made for the Lane Departure Warning (Lane Departure Warning) function.

Off & On



Press the centre console's button to activate or deactivate the function. The button's lamp illuminates when the function is switched on.

This function is complemented in the combined instrument panel with intuitive graphics in different situations.

Personal preferences

Settings are made from the centre console's screen via the menu system in **MY CAR**. For a description of the menu system, see **MY CAR** (p. 116).

Select from the options:



07 Driver support



- **On at startup** - The function is set in standby mode each time the engine is started. Otherwise the same value as when the engine was switched off is obtained.
- **Increased sensitivity** - The sensitivity increases, an alarm is triggered earlier and fewer limitations apply.

Related information

- Lane Departure Warning (LDW)* (p. 243)

Lane Departure Warning (LDW) - operation

Lane Departure Warning (Lane Departure Warning) is complemented in the combined instrument panel with intuitive graphics in different situations. Here are some examples:



LDW function side lines.

- The LDW symbol has WHITE side lines - the function is active and detects/"sees" one side line, or both.
- The LDW symbol has GREY side lines - the function is active but detects neither left nor right side line.

or

- The LDW symbol has GREY side lines - the function is in standby mode because the speed is below 65 km/h.
- The LDW symbol has no side lines - the function is deactivated.

Related information

- Lane Departure Warning (LDW)* (p. 243)



Lane Departure Warning (LDW) - limitations

Lane Departure Warning (Lane Departure Warning) camera sensor has limitations in a similar way to the human eye.

For more information, read about camera sensor limitations (p. 236).

NOTE

There are some situations where LDW does not give any warning, such as:

- Direction indicators are switched on
- The driver has his/her foot on the brake pedal³⁶
- In the event of rapid depression of the accelerator pedal³⁶
- In the event of rapid steering wheel movements³⁶
- If turning is so sharp that the car rolls.

Related information

- Lane Departure Warning (LDW)* (p. 243)

³⁶ When "Increased sensitivity" is selected a warning is still given, see Lane Departure Warning (LDW) - function (p. 243).





07 Driver support

Lane Departure Warning (LDW) - symbols and messages

In situations where there is no Lane assistance function, a symbol may be shown in the

combined instrument panel in combination with an explanatory message - follow the recommendation given if appropriate.

Message examples:

Symbol	Message	Specification
	Lane Departure Warning ON/ Lane Departure Warning OFF	The function is switched on/off. Shown at switch-on/off. The text disappears after approx. 5 seconds.
	Windscreen sensors blocked See manual	The camera sensor is temporarily disengaged. Shown in the event of snow, ice or dirt on the windscreen for example. <ul style="list-style-type: none"> Clean the windscreen in front of the camera sensor. Read about camera sensor limitations (p. 236).
	Driver Alert system Service required	The system is disengaged. <ul style="list-style-type: none"> Visit a workshop if the message remains - an authorised Volvo workshop is recommended.

Related information

- Lane Departure Warning (LDW)* (p. 243)



Park Assist*

Parking assistance is used as an aid to parking. An acoustic signal as well as symbols on the centre console's screen indicate the distance to the detected obstacle.

Parking assistance sound level can be adjusted during the ongoing acoustic signal using the centre console's **VOL** knob or in the car's menu system (p. 116) **MY CAR**.

Parking assistance is available in two variants:

- Rear only
- Both front and rear.

NOTE

When a towbar is configured with the car's electrical system, the protrusion of the towbar is included when the function measures the parking space.

WARNING

- Parking assistance does not relinquish the driver's own responsibility during parking.
- The sensors have blind spots where obstacles cannot be detected.
- Be aware of e.g. people or animals near the car.

Related information

- Park assist syst* - function (p. 247)
- Park assist syst* - forward (p. 249)
- Park assist syst* - backward (p. 248)
- Park assist syst* - cleaning the sensors (p. 250)
- Park assist syst* - fault indication (p. 250)
- Park assist camera* (p. 251)

Park assist syst* - function

The parking assistance system is automatically activated when the engine is started - the switch's On/Off lamp is illuminated. If parking assistance is switched off with the button, the lamp goes out.



On/Off for parking assistance.

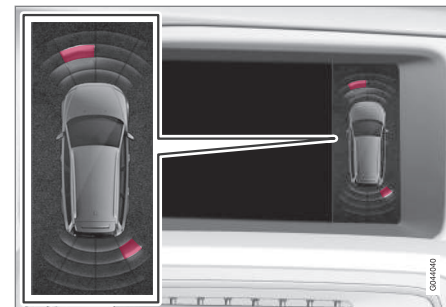

Display screen view - showing an obstacle left front and right rear.



07 Driver support



The centre console's display screen shows an overview of the relationship between the car and detected obstacle.

Marked sectors show which of the four sensor(s) detected an obstacle. The closer to the car symbol a selected sector box is, the shorter the distance between the car and a detected obstacle.

The frequency of the signal increases the shorter the distance to an obstacle, in front of or behind the car. Other sound from the audio system is muted automatically.

When the distance is within 30 cm the tone is constant and the active sensor's field nearest the car is filled in. If the detected obstacle is within the distance for the constant tone both behind and in front of the car, then the tone sounds alternately from the loudspeakers.



IMPORTANT

Objects e.g. chains, thin glossy poles or low barriers may be in the "signal shadow" and are then temporarily not detected by the sensors - the pulsating tone may then unexpectedly stop instead of changing over to the expected constant tone.

The sensors cannot detect high objects, such as projecting loading docks.

- In such situations, pay extra attention and manoeuvre/reposition the car particularly slowly or stop the current parking manoeuvre - there may be a high risk of damage to vehicles or other objects since the sensors are temporarily unable to function optimally.

Related information

- Park Assist* (p. 247)
- Park assist syst* - forward (p. 249)
- Park assist syst* - backward (p. 248)
- Park assist syst* - cleaning the sensors (p. 250)
- Park assist syst* - fault indication (p. 250)
- Park assist camera* (p. 251)

Park assist syst* - backward

Parking assistance is used as an aid to parking. An acoustic signal as well as symbols on the centre console's screen indicate the distance to the detected obstacle.

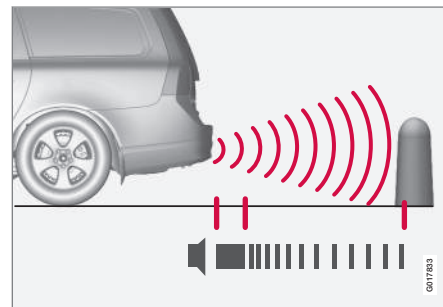

The distance covered to the rear of the car is about 1.5 metres. The acoustic signal for obstacles behind comes from one of the rear loudspeakers.

Rear parking assistance is activated when reverse gear is engaged.

When reversing with e.g. a trailer on the towbar, rear parking assistance is switched off automatically - otherwise the sensors would react to the trailer.

**NOTE**

When reversing with e.g. a trailer or bike carrier on the towbar - without Volvo genuine trailer wiring - parking assistance may need to be switched off manually in order that the sensors do not react to them.

Related information

- Park Assist* (p. 247)
- Park assist syst* - function (p. 247)
- Park assist syst* - forward (p. 249)
- Park assist syst* - cleaning the sensors (p. 250)
- Park assist syst* - fault indication (p. 250)
- Park assist camera* (p. 251)

Park assist syst* - forward

Parking assistance is used as an aid to parking. An acoustic signal as well as symbols on the centre console's screen indicate the distance to the detected obstacle.

The parking assistance system is automatically activated when the engine is started - the switch's On/Off lamp is illuminated. If parking assistance is switched off with the button, the lamp goes out.

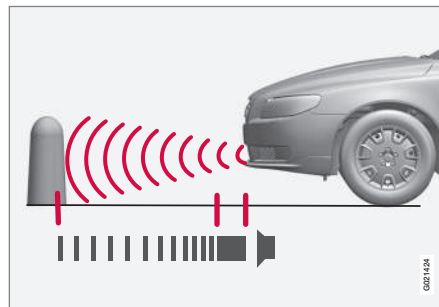

The distance covered in front of the car is about 0.8 metres. The acoustic signal for obstacles in front comes from one of the front loudspeakers.

Front park assist is active up to approx. 10 km/h. The lamp in the button is illuminated in order to indicate that the system is activated. When the speed is below 10 km/h the system is reactivated.

NOTE

Front parking assistance is deactivated when the parking brake is applied or **P** mode is selected in a car with an automatic gearbox.

IMPORTANT

When auxiliary lamps are fitted: Remember that these must not obscure the sensors - the auxiliary lamps may then be perceived as an obstacle.

Related information

- Park Assist* (p. 247)
- Park assist syst* - function (p. 247)
- Park assist syst* - backward (p. 248)
- Park assist syst* - cleaning the sensors (p. 250)
- Park assist syst* - fault indication (p. 250)
- Park assist camera* (p. 251)



Park assist syst* - fault indication

Parking assistance is used as an aid to parking. An acoustic signal as well as symbols on the centre console's display screen indicate the distance to the detected obstacle.

 If the combined instrument panel's information symbol illuminates with constant glow and the text message

Park Assist System Service required is shown then parking assistance is disengaged.

IMPORTANT

In certain conditions the parking assistance system may produce incorrect warning signals that are caused by external sound sources that emit the same ultrasonic frequencies that the system works with.

Examples of such sources include horns, wet tyres on asphalt, pneumatic brakes and exhaust noises from motorcycles etc.

Related information

- Park Assist* (p. 247)
- Park assist syst* - cleaning the sensors (p. 250)
- Park assist syst* - function (p. 247)
- Park assist syst* - forward (p. 249)
- Park assist syst* - backward (p. 248)
- Park assist camera* (p. 251)

Park assist syst* - cleaning the sensors

Parking assistance is used as an aid to parking. An acoustic signal as well as symbols on the centre console's screen indicate the distance to the detected obstacle.

The sensors must be cleaned regularly to ensure that they work properly. Clean them with water and car shampoo.

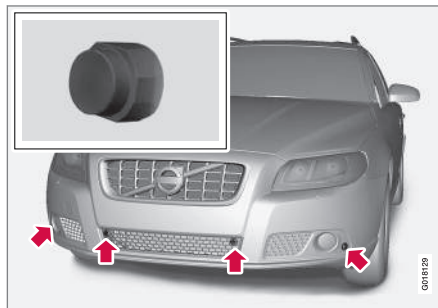

Sensor location, front.

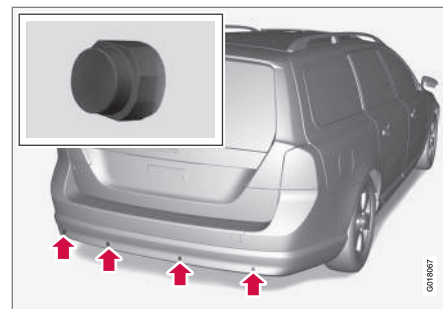

Sensor location, rear.

NOTE

Dirt, ice and snow covering the sensors may cause incorrect warning signals.

Related information

- Park Assist* (p. 247)
- Park assist syst* - function (p. 247)
- Park assist syst* - forward (p. 249)
- Park assist syst* - backward (p. 248)
- Park assist syst* - fault indication (p. 250)
- Park assist camera* (p. 251)



Park assist camera*

Parking camera is an auxiliary system, which is activated when the reverse gear is selected.

The camera image is shown on the centre console's screen.

NOTE

When a towbar is configured with the car's electrical system, the protrusion of the towbar is included when the function measures the parking space.

WARNING

- The parking camera serves as an aid. It does not relieve the driver of responsibility when reversing.
- The camera has blind spots, where obstacles cannot be detected.
- Be aware of people and animals in the vicinity of the car.

Function and operation



Camera location next to the opening handle.

The camera shows what is behind the car and if something appears from the sides.

The camera shows a wide area behind the car and part of the bumper and any towbar.

Objects on the screen may appear to tilt slightly - this is normal.

NOTE

Objects on the display screen may be closer to the car than they appear to be on the screen.

If another view is active then the parking camera system takes over automatically and its camera image is displayed on the screen.

When reverse gear is selected, unbroken lines are shown graphically which illustrate where

the car's approximate external dimensions will be positioned with the current steering wheel angle - this facilitates parallel parking, reversing into tight spaces and for hitching a trailer. The park assist lines can be deactivated - see section Settings (p. 253).

If the car is also equipped with Parking assistance sensors (p. 247)* then their information is shown graphically as coloured areas in order to illustrate distances to detected obstacles, see heading "Cars with reversing sensors" later in the text.

The camera is active approx. 5 seconds after reverse gear has been disengaged or until the car's speed exceeds 10 km/h forward or 35 km/h backward.

Light conditions

The camera image is adjusted automatically according to prevailing light conditions. Because of this, the image may vary slightly in brightness and quality. Poor light conditions can result in a slightly reduced image quality.

NOTE

Keep the camera lens clear of dirt, snow and ice to ensure optimum function. This is particularly important in poor light.



07 Driver support



Park assist lines

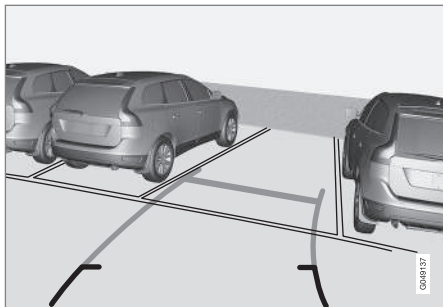

Examples of how the park assist lines can be displayed for the driver.

The lines on the screen are projected as if they were at ground level behind the car and are directly related to steering wheel movement, which shows the driver the path the car will then take - also when the car is turning.

i NOTE

- When reversing with a trailer which is not connected electrically to the car, the lines on the display show the route the **car** will take - not the trailer.
- The screen shows no lines when a trailer is connected electrically to the car's electrical system.
- The parking camera is deactivated automatically when towing a trailer if a Volvo genuine trailer cable is used.

! IMPORTANT

Remember, that with the rear camera view selected, the monitor only displays the area behind the car. Be aware of the sides and front of the car when manoeuvring in reverse.

Boundary lines

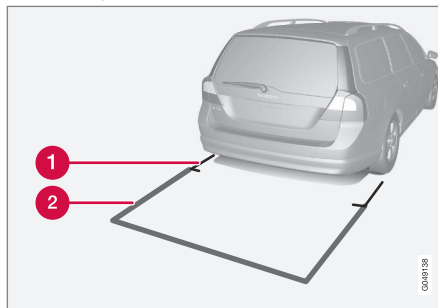

The system's lines.

- 1 Boundary line, 30 cm zone backwards from the car
- 2 Boundary line, free reversing zone

The red line (1) frames in a zone approx. 30 cm back from the bumper.

The yellow horizontal line (2) frames in a zone up to approx. 1.5 m behind the bumper.

The yellow side lines end approx. 2.0 m behind the bumper.

The boundary lines include the car's most protruding parts, e.g. door mirrors and corners - also when the car is turning.

Cars with reversing sensors*

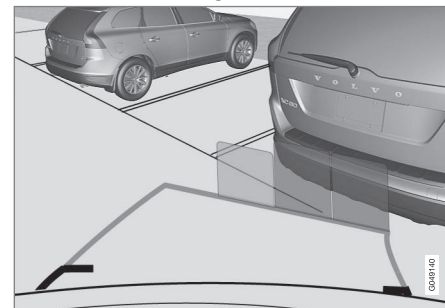

Coloured fields (one per sensor) show distance.

If the car is also equipped with Parking assistance (p. 247) the distance is shown with coloured fields for each sensor that registers an obstacle.

The colour of the areas changes with decreasing distance to the obstacle - from green to yellow to red.

Colour / paint	Distance (metres)
Green	0,8-1,5
Yellow	0,4-0,8
Red	0-0,4



Related information

- Park assist camera - settings (p. 253)
- Park assist camera - limitations (p. 254)
- Park Assist* (p. 247)

Park assist camera - settings

Activate switched-off camera

If the camera function is switched off when reverse gear is selected, it is activated in the following way:

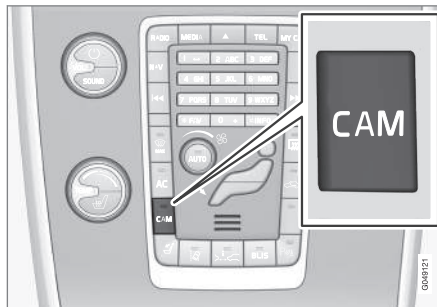

- Press **CAM** - the screen shows the current camera view.

Change setting

The default setting is that the camera is activated when reverse gear is selected.

The settings for the parking camera can be changed when the screen shows a camera view:

1. Press **OK/MENU** when a camera view is shown - the screen changes to a menu with various options.
2. Turn to reach the desired option with **TUNE**.

3. Highlight the option by pressing **OK/MENU** once and go back out with **EXIT**.

Miscellaneous

If the car has several cameras* installed, the active camera view on the screen can be changed:

- Press **CAM** or turn **TUNE**.

Related information

- Park assist camera* (p. 251)
- Park Assist* (p. 247)



Park assist camera - limitations

NOTE

A bike carrier or other accessory mounted on the rear of the car could obscure the camera's view.

To bear in mind

Pay attention to the possibility that, even if it only looks like a relatively small part of the image is obscured, it could be a relatively large sector that is hidden from view. Obstacles could thereby go undetected until they are very close to the car.

- Keep the camera lens free from dirt, ice and snow.
- Clean the camera lens regularly with luke-warm water and car shampoo - take care not to scratch the lens.

Related information

- Park assist camera* (p. 251)
- Park assist camera - settings (p. 253)
- Park Assist* (p. 247)

BLIS*

BLIS (Blind Spot Information) is a camera-based information system that under certain conditions can help the driver to notice vehicles moving in the same direction as the host vehicle in the so-called "blind spot".

The system is designed to work most effectively when driving in dense traffic on multi-lane highways.

WARNING

The system is a supplement to, not a replacement for, a safe driving style and use of the rearview mirrors. It can never replace the driver's attention and responsibility. The responsibility for changing lanes safely always rests with the driver.

Overview

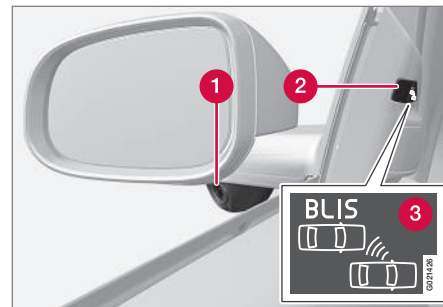

Rearview mirror with BLIS function³⁷.

- 1 BLIS camera
- 2 Indicator lamp
- 3 BLIS symbol

NOTE

The lamp illuminates on the side of the car where the system has detected the vehicle. If the car is overtaken on both sides at the same time then both lamps illuminate.

Maintenance

In order to work most effectively the BLIS camera lenses³⁸ must be clean. The lenses can be cleaned with a soft cloth or damp

³⁷ NOTE: The illustration is schematic - details may vary depending on car model.

³⁸ See (1) in the preceding illustration.



sponge. Clean the lenses carefully so that they are not scratched.

! IMPORTANT

The lenses are electrically heated to melt ice or snow. If necessary, brush snow away from the lenses.

Related information

- BLIS* - operation (p. 255)
- BLIS - symbols and messages (p. 257)

BLIS* - operation

BLIS (Blind Spot Information) is a function designed for providing support for the driver when driving in dense traffic on roads with several lanes in the same direction.

Activate/deactivate BLIS

BLIS is activated when the engine is started. The indicator lamps in the door panels flash three times when BLIS is activated.

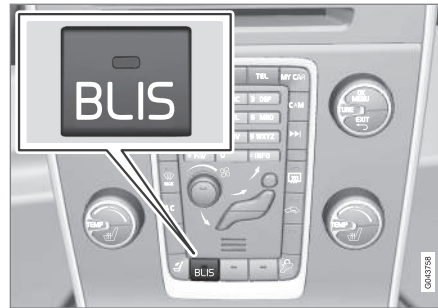

Button for activating/deactivating.

The system can be deactivated/activated after starting the engine with one press on the **BLIS** button.

Some combinations of the selected equipment leave no vacant space for a button in the centre console - in which case the function is operated in the car's menu system (p. 116) **MY CAR**.

When BLIS is deactivated, the lamp in the button extinguishes and a message is shown in the combined instrument panel.

When BLIS is activated the lamp in the button illuminates, the combined instrument panel shows a new text message and the indicator lamps in the door panels flash 3 times. Press the left-hand stalk switch **OK** button in order to switch off the text message.

When BLIS operates

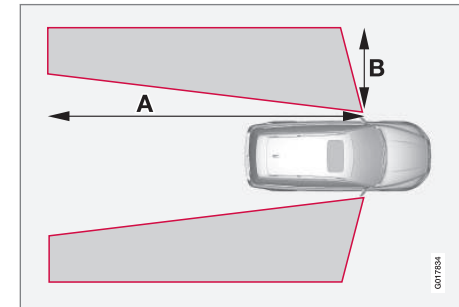

$A = \text{approx. } 9.5 \text{ m}$ and $B = \text{approx. } 3.0 \text{ m}$.

The system operates when the car is driven at a speed above 10 km/h.

When a camera (1) has detected a vehicle inside the blind spot zone the indicator lamp (2) illuminates with a constant glow, see overview illustration (p. 254).

BLIS advises the driver with a message if a fault arises in the system. If, for example, the



07 Driver support



system's cameras are obscured then the BLIS indicator lamp flashes and a message is shown in the combined instrument panel. In such cases, check and clean the lenses.

If necessary, the system can be switched off temporarily, see "Activate/deactivate BLIS" above.

Overtaking

The system is designed to react if:

- you overtake another vehicle at a speed of up to 10 km/h faster than the other vehicle
- you are overtaken by a vehicle travelling up to 70 km/h faster than you are travelling.

WARNING

BLIS does not work in sharp bends.

BLIS does not work when the car is reversing.

A wide trailer coupled to the car can conceal other vehicles in adjacent lanes. It can prevent the vehicle in the screened area from being detected by BLIS.

Daylight and darkness

In daylight the system reacts to the shape of the surrounding vehicles. The system is designed to detect motor vehicles such as cars, trucks, buses and motorcycles.

In darkness the system reacts to the headlamps of surrounding vehicles. If the headlamps of surrounding vehicles are not switched on then the system does not detect the vehicles. This means for example that the system does not react to a trailer without headlamps which is towed behind a car or truck.

WARNING

The system does not react to cyclists or moped riders.

The BLIS cameras have limitations similar to those of the human eye, i.e. they do not "see" as well e.g. in heavy snowfall, against strong light or in thick fog.

Limitations

In some situations the BLIS indicator lamp may illuminate despite there being no other vehicle within the blind spot.

NOTE

If the BLIS indicator lamp illuminates on isolated occasions despite there being no other vehicle within the blind spot then this does not mean that a fault has arisen in the system.

In the event of a fault in the BLIS system the display shows the text **BLIS Service required**.

The following illustrations show examples of situations where the BLIS indicator lamp may illuminate even if there is no other vehicle within the blind spot.

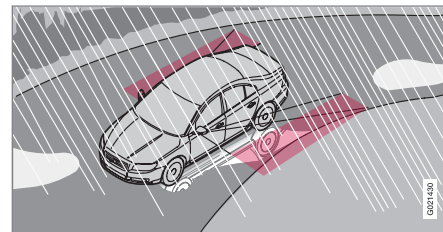

Reflection from shiny wet road surface.

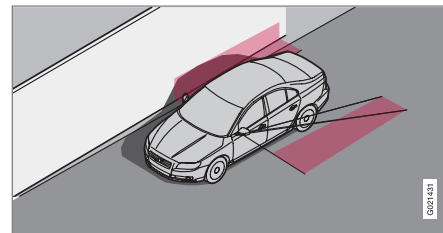

Own shadow on large light smooth surface, e.g. noise barrier or concrete road surface.

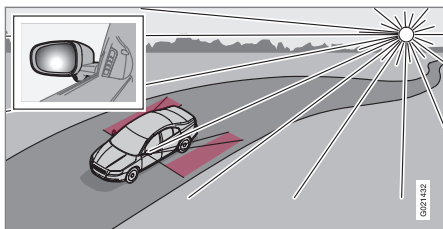

Low stationary sunlight shining into the camera.

! IMPORTANT

Repair of the BLIS system components must only be performed by a workshop - an authorised Volvo workshop is recommended.

Related information

- BLIS* (p. 254)
- BLIS - symbols and messages (p. 257)

BLIS - symbols and messages

In situations where the BLIS (Blind Spot Information) (p. 254) function fails or is interrupted, the combined instrument panel may show a symbol, supplemented by an explanatory message. Follow any recommendation given.

Message examples:

Message	Specification
BLIS ON	The BLIS system is activated.
BLIS Service required	Blind spot syst. disengaged - contact a workshop.
BLIS Camera blocked	The BLIS camera is blocked by dirt, snow or ice - clean the lenses.

Message	Specification
BLIS Reduced function	<p>Reduced function in the data transmission between the BLIS system's camera and the car's electrical system.</p> <p>The camera resets itself when the data transmission between the BLIS system's camera and the car's electrical system returns to normal.</p>
BLIS OFF	The BLIS system is deactivated.

A text message can be acknowledged by briefly pressing the **OK** button on the direction indicator stalk.

Related information

- BLIS* (p. 254)



07 Driver support

Type approval - radar system

Type approval for the radar system can be read in the table.

Country/ Area	
Singapore	<div data-bbox="703 239 842 311" style="border: 1px solid black; padding: 5px; width: fit-content; margin: 0 auto;">Complies with IDA standards DA105753</div> <p data-bbox="699 329 979 376">IDA: Infocomm Development Authority of Singapore.</p>
Brazil	
Europe	 Delphi Electronics & Safety hereby declares that L2C0038TR and L2C0049TR are in compliance with the essential requirements and other relevant provisions of Directive 1999/5/EC. This declaration of conformity may, if necessary, be consulted with Delphi Electronics & Safety / One Corporate Center / Kokomo, Indiana 46904-9005 USA.

Related information

- Radar sensor (p. 215)

07

08

STARTING AND DRIVING

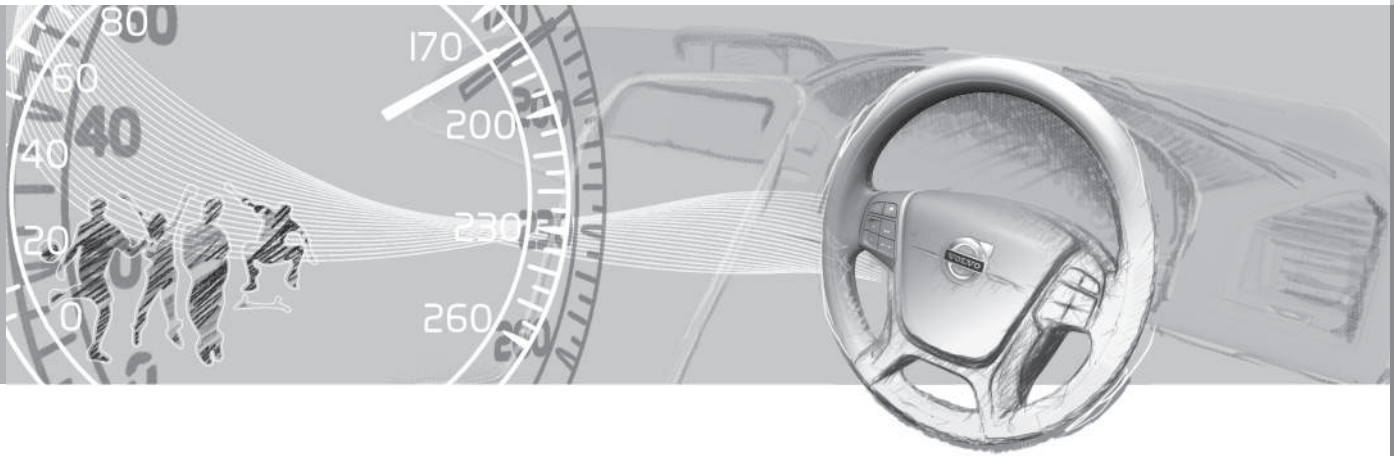



Alcohol lock*

The function of the alcohol lock is to prevent the car from being driven by individuals under the influence of alcohol. Before the engine can be started the driver must take a breath test that verifies that he/she is not under the influence of alcohol. Alcohol lock calibration takes place in accordance with each market's limit value in force for driving legally.

WARNING

The alcohol lock is an aid and does not exempt the driver from responsibility. It is always the responsibility of the driver to be sober and to drive the car safely.

Related information

- Alcohol lock* - functions and operation (p. 260)
- Alcohol lock* - storage (p. 261)
- Alcohol lock* - before starting the engine (p. 261)
- Alcohol lock* - to bear in mind (p. 263)
- Alcohol lock* - symbols and text messages (p. 264)

Alcohol lock* - functions and operation

Functions

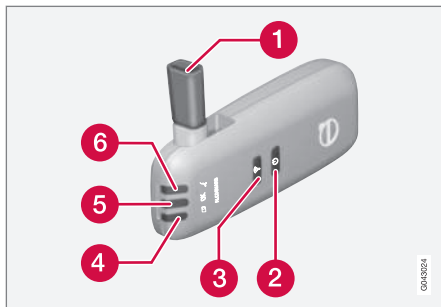

- 1 Nozzle for breath test.
- 2 Switch.
- 3 Transmission button.
- 4 Lamp for battery status.
- 5 Lamp for result of breath test.
- 6 Lamp indicates ready for breath test.

Operation - battery

Alcohol lock indicator lamp (4) shows battery status:

Indicator lamp (4)	Battery status
Flashing green	Charging in progress
Green	Fully charged
Yellow	Semi-charged
Red	Discharged - fit the charger in the holder or connect the power supply cable from the glovebox.

NOTE

Store the alcohol lock in its holder. This will keep the built-in battery fully charged and the alcohol lock is activated automatically when the car is opened.

Related information

- Alcohol lock* (p. 260)
- Alcohol lock* - storage (p. 261)
- Alcohol lock* - before starting the engine (p. 261)
- Alcohol lock* - to bear in mind (p. 263)
- Alcohol lock* - symbols and text messages (p. 264)



Alcohol lock* - storage

Store the alcohol lock in its holder. Release the handheld unit by depressing it slightly in its holder and releasing it - it then springs out and can be removed from the holder.

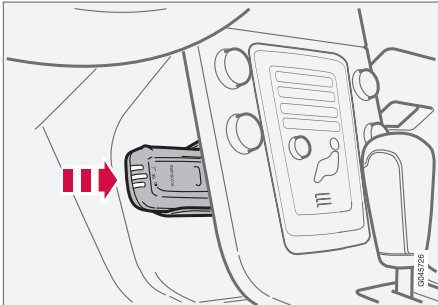

Handheld unit storage and charging station.

- Replace the handheld unit in the holder by pushing it in until it engages.
- Store the handheld unit in the holder - this provides it with the best protection and keeps its batteries fully charged.

Related information

- Alcohol lock* (p. 260)
- Alcohol lock* - functions and operation (p. 260)
- Alcohol lock* - before starting the engine (p. 261)
- Alcohol lock* - to bear in mind (p. 263)

- Alcohol lock* - symbols and text messages (p. 264)

Alcohol lock* - before starting the engine

The alcohol lock is activated automatically and is then ready for use when the car is opened.

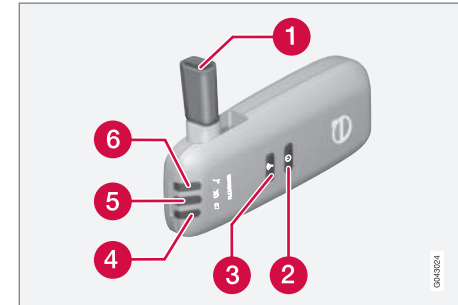

- 1 Nozzle for breath test.
- 2 Switch.
- 3 Transmission button.
- 4 Lamp for battery status.
- 5 Lamp for result of breath test.
- 6 Lamp indicates ready for breath test.

1. When the indicator lamp (6) is green the alcohol lock is ready for use.
2. Withdraw the alcohol lock from its holder. If the alcohol lock is outside the car when



it is unlocked then it must first be activated with the switch (2).

3. Lift up the nozzle (1), take a deep breath and blow with an even pressure until a "click" is heard after approx. 5 seconds. The result will be one of the alternatives in the following table **Result after breath test**.
4. If no message is shown then the transmission to the car may have failed - in which case, press the button (3) to transmit the result to the car manually.
5. Fold down the nozzle and refit the alcohol lock in its holder.
6. Start the engine following an approved breath test within 5 minutes - otherwise it must be repeated.

Result after breath test

Indicator lamp (5) + Display text	Specification
Green lamp + Alcoguard Approved test	Start the engine - no alcohol content measured.
Yellow lamp + Alcoguard Approved test	Engine starting possible - measured alcohol content is above 0.1 mg/ml but below the limit value in force ^A .
Red lamp + Disapproved test Wait 1 minute to try again	Engine starting not possible - measured alcohol content is above the limit value in force ^A .

- Alcohol lock* - storage (p. 261)
- Alcohol lock* - to bear in mind (p. 263)
- Alcohol lock* - symbols and text messages (p. 264)

^A Limit values vary from country to country. Find out what applies in your country. See also Alcohol lock* (p. 260).



NOTE

After a completed period of driving, the engine can be restarted within 30 minutes without a new breath test.

Related information

- Alcohol lock* (p. 260)
- Alcohol lock* - functions and operation (p. 260)



Alcohol lock* - to bear in mind

In order to obtain correct function and as accurate a measurement result as possible:

- Avoid eating or drinking approx. 5 minutes before the breath test.
- Avoid excess windscreen washing - the alcohol in the washer fluid may result in an incorrect measurement result.

Change of driver

In order to ensure that a new breath test is carried out in the event of a change of driver - depress the switch (2) and the send button (3) simultaneously for approx. 3 seconds. At which point the car returns to start inhibition mode and a new approved breath test is required before starting the engine.

Calibration and service

The alcohol lock must be checked and calibrated at a workshop¹ every 12 months.

30 days before recalibration is necessary the combined instrument panel shows the message **Alcoguard Calibration required See manual**. If calibration is not carried out within these 30 days then normal engine starting will be blocked - only starting with the Bypass function will then be possible, see the following heading "Emergency situation".

The message can be cleared by pressing the send button (3) once. Otherwise it extinguishes on its own after approx. 2 minutes but then reappears each time the engine is started - only recalibration at a workshop¹ can clear the message permanently.

Cold or hot weather

The colder the weather the longer it takes before the alcohol lock is ready for use:

Temperature (°C)	Maximum heating time (seconds)
+10 to +85	10
-5 to +10	60
-40 to -5	180

At temperatures below -20 °C or above +60 °C the alcohol lock requires additional power supply. The combined instrument panel shows **Alcoguard Please insert power cable**. In which case, connect the power supply cable from the glovebox and wait until indicator lamp (6) is green.

In extremely cold weather the heating time can be reduced by taking the alcohol lock indoors.

Emergency situation

In the event of an emergency situation or the alcohol lock is out of order, it is possible to bypass the alcohol lock in order to drive the car.

NOTE

All Bypass activation is logged and saved in memory, see Recording data (p. 18).

After the Bypass function has been activated the combined instrument panel shows **Alcoguard Bypass enabled** the whole time while driving and can only be reset by a workshop¹.

The Bypass function can be tested without the error message being logged - in which case, carry out all the steps without starting the car. The error message is cleared when the car is locked.

When the alcohol lock is installed, either the Bypass or Emergency function is selected as the bypassing option. This setting can be changed afterwards at a workshop¹.

Activating the Bypass function

- Depress and hold the left-hand stalk switch **OK** button and the button for hazard warning flashers simultaneously for approx. 5 seconds - the combined instrument panel first shows **Bypass activated**

¹ An authorised Volvo workshop is recommended.





Please wait for 1 minute and then **Alcoguard Bypass** enabled - after which the engine can be started.

This function can be activated more than once. The error message shown during driving can only be cleared at a workshop¹.

Activating the Emergency function

- Depress and hold the left-hand stalk switch **OK** button and the button for hazard warning flashers simultaneously for approx. 5 seconds - the combined instrument panel shows **Alcoguard Bypass enabled** and the engine can be started.

This function can be used once, after which a reset must be made at a workshop¹.

Related information

- Alcohol lock* - functions and operation (p. 260)
- Alcohol lock* - storage (p. 261)
- Alcohol lock* - before starting the engine (p. 261)
- Alcohol lock* (p. 260)
- Alcohol lock* - symbols and text messages (p. 264)

Alcohol lock* - symbols and text messages

In addition to the previously described messages related to how the alcohol lock works before starting the engine (p. 261) the combined instrument panel's display can also show the following:

Display text	Meaning/Action
Alcoguard Restart possible	The engine has been switched off for less than 30 minutes - engine starting possible without new test.
Alcoguard Service required	Contact a workshop ^A .
Alcoguard No signal received	Transmission failed - send manually with button (3) or take a new breath test.
Alcoguard Please try again	Test failed - take a new breath test.
Alcoguard Please blow longer	Blowing too short - blow for longer.

Display text	Meaning/Action
Alcoguard Please blow softer	Blowing too hard - blow more gently.
Alcoguard Please blow harder	Blowing too weak - blow harder.
Alcoguard preheating Please wait	Heating not finished - wait for text Alcoguard Please blow for 5 seconds .

^A An authorised Volvo workshop is recommended.

Related information

- Alcohol lock* (p. 260)
- Alcohol lock* - functions and operation (p. 260)
- Alcohol lock* - storage (p. 261)
- Alcohol lock* - before starting the engine (p. 261)
- Alcohol lock* - to bear in mind (p. 263)

¹ An authorised Volvo workshop is recommended.



Starting the engine

The engine is started and switched off using the remote control key and the **START/STOP ENGINE** button.



Ignition switch with remote control key extracted/inserted and **START/STOP ENGINE** button.

! IMPORTANT

Do not press in the remote control key incorrectly turned - hold the end with the detachable key blade, see Detachable key blade - detaching/attaching (p. 174).

1. Insert the remote control key in the ignition switch and press it in to its end position. Note that if the car is equipped with alcohol lock* then a breath test must first be approved before the engine can be started. For more information on the Alcohol lock, see Alcohol lock* (p. 260).
2. Hold the clutch pedal fully depressed². (For cars with automatic gearbox - Depress the brake pedal.)
3. Press the **START/STOP ENGINE** button and then release it.

i NOTE

For diesel-engined cars, there may be a slight delay before the engine can be started - **Engine preheating** is displayed in the meantime.

When the engine is started the starter motor works until the engine is started or until its overheating protection triggers.

! IMPORTANT

If the engine fails to start after 3 attempts - wait for 3 minutes before making a further attempt. Starting capacity increases if the battery is allowed to recover.

! WARNING

Never remove the remote control key from the ignition switch after starting the engine or when the car is being towed.

! WARNING

Always remove the remote control key from the ignition switch when leaving the car, and make sure that the key position is **0** - in particular if there are children in the car. For information on how this works - see Key positions (p. 80).

i NOTE

The idling speed can be noticeably higher than normal for certain engine types during cold starting. This is done in order that the emissions system can reach normal operating temperature as quickly as possible, which minimises exhaust emissions and protects the environment.

Keyless drive*

Follow steps 2-3 for keyless (p. 178) starting of the engine.

² If the car is moving then it is enough to press the **START/STOP ENGINE** button to start the engine.





NOTE

A prerequisite for the engine to start is that one of the car's remote control keys with the Keyless drive function is in the passenger compartment or cargo area.

WARNING

Never remove the remote control key from the car while driving or during towing.

Related information

- Switching off the engine (p. 266)

Switching off the engine

*The engine is switched off using the **START/STOP ENGINE** button.*

To stop the engine:

- Press **START/STOP ENGINE** - the engine stops.

If the gear selector is not in **P** position or if the car is moving:

- Press twice on **START/STOP ENGINE** or hold the button depressed until the engine stops.

Related information

- Key positions (p. 80)

Steering lock

The steering lock makes steering difficult if the car is e.g. taken unlawfully. A mechanical noise may be noticed when the steering lock unlocks or locks.

Function

- The steering lock is activated when the driver's door is opened after the engine has been switched off.
- The steering lock is deactivated when the remote control key is in the ignition switch³ and the **START/STOP ENGINE** button is depressed.

Related information

- Starting the engine (p. 265)
- Key positions (p. 80)
- Steering wheel (p. 86)

³ Cars with Keyless drive only need to have a remote control key inside the passenger compartment.



Remote start (ERS)*

Remote start (ERS – Engine Remote Start) means that the car's engine can be started remotely in order to warm up/cool down the passenger compartment before departure. ERS is activated via key and/or via Volvo On Call*.

The climate control starts with the same settings that were being used when the car was parked.

An ERS-started engine is activated for a maximum of 15 minutes, then it is switched off. After two ERS-activations the engine must be started in the normal way before ERS can be re-used.

ERS is only available in cars with automatic gearbox and cars that have a bonnet switch⁴ installed.

i NOTE

The service life of the remote control key's battery is affected by the ERS function. In the event of frequent use of ERS the battery should therefore be changed once per year, see Remote control key - replacing the battery (p. 177).

i NOTE

Follow local/national rules/regulations on idling. Also take into account the local/national rules/regulations regarding the noise level when the engine is running.

! WARNING

To remote-start the engine, the following criteria must be met:

- The car must be supervised.
- There must be no people or animals inside or around the car.
- The car must not be parked in a closed, unventilated area - the exhaust gases may seriously injure humans and animals.

Related information

- Remote start (ERS) - operation (p. 267)
- Remote start (ERS) - symbols and messages (p. 269)

Remote start (ERS) - operation

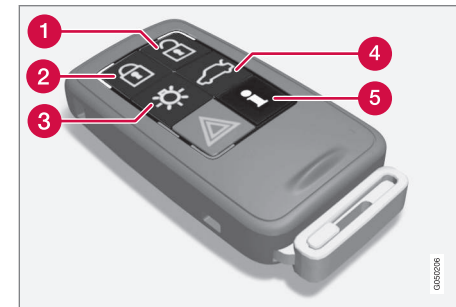

The key's buttons for remote start.

- 1 Unlocking
- 2 Locking
- 3 Approach lighting
- 4 Unlocking, tailgate
- 5 Information⁵

Remote starting the engine

To be able to remotely start the engine the car must be locked and the bonnet closed.

Proceed as follows:

⁴ Available in the XC60, cars with alarm, most cars with 4-cylinder engines or if ERS is selected for new construction.

⁵ Only on PCC key, see Remote control key with PCC* - unique functions (p. 172).





08 Starting and driving



1. Briefly press on the key's button (2).
2. Follow this immediately afterwards with a long press - at least 2 seconds - on button (3).

If the conditions for ERS are fulfilled then the following takes place:

1. The direction indicators flash quickly several times.
2. The engine starts.
3. The direction indicators illuminate with a constant glow for 3 seconds to verify that the engine has started.



NOTE

After remote starting, the car continues to be locked but with deactivated movement detector*.

With PCC⁶ key



The light indication for Approach lighting⁷ flashes several times when the button is pressed and then goes to constant glow if all criteria for ERS have been fulfilled. However, this does not mean that ERS has started the engine.

To check whether ERS has started the engine, the user can press the button (5) - if the engine has started, there is a light indication by the buttons (2) and (3).

Active functions

The following functions are activated with a remote started engine:

- Ventilation system
- Audio/video system
- Approach lighting.

Deactivated functions

The following functions are deactivated with a remote started engine:

- headlamps
- Position lamps
- Number plate lighting
- Windscreen wiper.

ERS is interrupted

The following steps switch off an ERS-started engine:

- The remote control key's button (1), (2) or (4) is depressed
- The car is unlocked
- A door is opened
- Accelerator pedal or brake pedal is depressed
- The gear selector is moved out of **P** position
- Active ERS time exceeds 15 minutes.

When an ERS-started engine is switched off, the direction indicators illuminate with a constant glow for 3 seconds.

Related information

- Remote start (ERS)* (p. 267)
- Remote start (ERS) - symbols and messages (p. 269)

⁶ For more information on the PCC key, see Remote control key with PCC* - unique functions (p. 172).

⁷ For more information on Approach lighting, see Remote control key - functions (p. 170) and Approach lighting (p. 99).



Remote start (ERS) - symbols and messages

In situations where the ERS function fails or is interrupted, a symbol is shown in the combined instrument panel, supplemented by an explanatory text message.

ERS function unavailable

Message	Specification
No remote start Too many tries	ERS unavailable because a maximum of 2 ERS activations in succession are allowed.
No remote start Low fuel level	ERS unavailable because fuel level too low.
No remote start Gear not in P	ERS unavailable because gear selector is not in P position.
No remote start Driver in car	ERS unavailable because someone is in the passenger compartment.
No remote start Low battery	ERS unavailable due to low battery voltage. Charge the battery by starting the engine.

Message	Specification
No remote start Engine warning	ERS unavailable due to warning message from engine. Contact a workshop ^A .
No remote start Engine coolant level low	ERS unavailable due to error message from cooling system, see Coolant - level (p. 366).
No remote start Door open	ERS unavailable because a door/tailgate was not closed.
No remote start Bonnet open	ERS did not activate because the bonnet was not closed.
No remote start Car not locked	ERS unavailable because the car was not locked.
No remote start Key in car	ERS did not activate because the key was in the car.

^A An authorised Volvo workshop is recommended.

Interrupted ERS function

Message	Specification
Remote start off Gear not in P	ERS interrupted because gear selector is not in P position.
Remote start off Driver in car	ERS interrupted because someone is in the passenger compartment.
Remote start off Engine warning	ERS interrupted due to error message from engine. Contact a workshop ^A .
No remote start Engine coolant level low	ERS interrupted due to error message from cooling system.
Remote start off Bonnet open	ERS interrupted because the bonnet is open.
Remote start off Low battery	ERS interrupted since the battery voltage is too low.
Remote start off Low fuel level	ERS interrupted since the fuel level is too low.

^A An authorised Volvo workshop is recommended.





Related information

- Remote start (ERS)* (p. 267)
- Remote start (ERS) - operation (p. 267)

Jump starting with battery

If the starter battery (p. 378) is discharged then the car can be started with current from another battery.

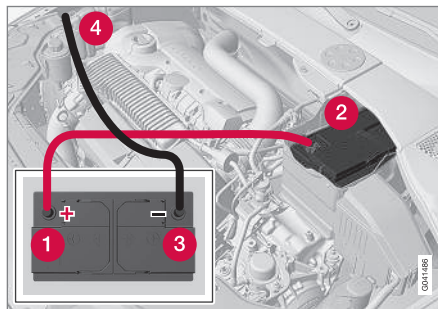

When jump starting the car, the following steps are recommended to avoid short circuits or other damage:

1. Set the car's electrical system in key position **0**, see Key positions - functions at different levels (p. 81).
2. Check that the donor battery has a voltage of 12 V.
3. If the donor battery is installed in another car - switch off the donor car's engine and make sure that the two cars do not touch each other.

4. Connect one of the red jump lead's clamps to the donor battery's positive terminal (1).

IMPORTANT

Connect the start cable carefully to avoid short circuits with other components in the engine compartment.

5. Open the clips on the front cover of the battery in your car and remove the cover, see Starter battery - replacement (p. 380).
6. Connect the red jump lead's other clamp onto the car's positive terminal (2).
7. Connect one of the black jump lead's clamps to the donor battery's negative terminal (3).
8. Connect the other clamp to a grounding point, e.g. right-hand engine mounting at the top, the outer screw head (4).
9. Check that the jump lead clamps are affixed securely so that there are no sparks during the starting attempt.
10. Start the engine of the "donor car" and allow it to run a few minutes at a speed slightly higher than idle approx. 1500 rpm.



11. Start the engine in the car with the discharged battery.

! IMPORTANT

Do not touch the crocodile clips during the start procedure. There is a risk of sparks forming.

12. Remove the jump leads in reverse order - first the black and then the red.
 - > Make sure that none of the black jump lead's clamps comes into contact with the battery's positive terminal or the clamp connected to the red jump lead.

! WARNING

- The battery can generate oxyhydrogen gas, which is highly explosive. A spark can be formed if a jump lead is connected incorrectly, and this can be enough for the battery to explode.
- The battery contains sulphuric acid, which can cause serious burns.
- If sulphuric acid comes into contact with eyes, skin or clothing, flush with large quantities of water. If acid splashes into the eyes - seek medical attention immediately.

Related information

- Starting the engine (p. 265)

Gearboxes

There are two main types of gearbox. Manual gearbox and automatic gearbox.

- Manual gearbox (p. 271)
- Automatic gearbox - Geartronic (p. 273) and Powershift (p. 276)

! IMPORTANT

To prevent damage to any drive system components, the working temperature of the gearbox is checked. If there is a risk of overheating, a warning symbol is illuminated in the combined instrument panel in conjunction with a text message being shown. Follow the recommendation given in the text message.

Related information

- Automatic gearbox -- Geartronic* (p. 273)

Manual gearbox

The function of the gearbox is to change the gear ratio depending on speed and power requirements.

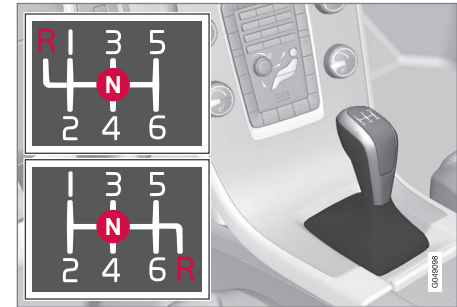

Gearshift pattern 6-speed gearbox.

The 6-speed box is available in two versions - reverse gear position differs between them. Look at the actual gearshift pattern imprinted on the gear lever.

- Depress the clutch pedal fully during each gear change.
- Take your foot off the clutch pedal between gear changes.

! WARNING

Always apply the parking brake when parking on a slope - leaving the car in gear is not sufficient to hold the car in all situations.





Reverse gear inhibitor

The reverse gear inhibitor hinders the possibility of mistakenly attempting to engage reverse gear during normal forward travel.

- Follow the gearing pattern printed on the gear lever and start from neutral position, **N** before moving it to **R** position.
- Engage reverse gear only when the car is stationary.

NOTE

With the upper variant of the shifting pattern for 6-speed gearbox (see previous illustration) - **first press down** the gear lever in the **N** position in order to engage reverse gear.

Related information

- Gearboxes (p. 271)
- Transmission fluid - grade and volume (p. 420)

Gear shift indicator*

The gear shift indicator notifies the driver when it is appropriate to engage the next higher or lower gear.

An essential detail in connection with environmental driving is to drive in the right gear and to change gear in good time.

An indicator is available as an aid on certain variants - GSI (Gear Shift Indicator) - which notifies the driver when it is appropriate to engage the next higher or lower gear in order to obtain the lowest possible fuel consumption.

However, taking into consideration characteristics such as performance and vibration-free running, it may be advantageous to change gear at a higher engine speed. The framed number indicates the current gear.

Manual gearbox

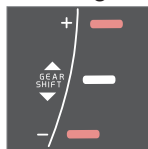

Gear shift indicator for manual gearbox. Only one marker is illuminated at a time - during normal driving it is only illuminated in the centre.

At the recommended upshift the cursor illuminates "+", and at the recommended downshift the cursor illuminates "-" (marked red in the illustration).

Automatic gearbox



Combined instrument panel "Digital" with gear shift indicator.

The framed number indicates the current gear.



With "Analogue" combined instrument panel, the gear positions and indicator arrows are displayed in its centre.

Related information

- Manual gearbox (p. 271)
- Automatic gearbox -- Geartronic* (p. 273)



Automatic gearbox -- Geartronic*

The Geartronic gearbox has two different gear modes - Automatic and Manual.



D: Automatic gear positions. **+/-:** Manual gear positions. **S:** Sport mode*.

Combined instrument panel (p. 65) shows the position of the gear selector using the following indications: **P, R, N, D, S⁺, 1, 2, 3** etc.

Gear positions

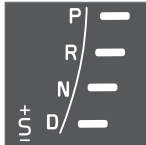

Automatic gear positions are indicated on the right of the combined instrument panel. (Only one marker is illuminated at a time - the one showing the current gear selector position.)

Symbol "**S**" for Sport mode is ORANGE when the mode is active.

Parking position - P

Select **P** position when starting the engine or when the car is parked.

In order to be able to move the gear selector from the **P** position, the brake pedal must be depressed and key position must be **II**, see Key positions - functions at different levels (p. 81).

The gearbox is mechanically blocked when the **P** position is engaged. Also apply the parking brake (p. 295) when the car is parked.

i NOTE

The gear selector must be in **P** position to allow the car to be locked and alarmed.

! IMPORTANT

The car must be stationary when position **P** is selected.

! WARNING

Always apply the parking brake when parking on a slope - the automatic transmission's **P** position is not sufficient to hold the car in all situation.

Reverse position - R

The car must be stationary when **R** position is selected.

Neutral position - N

No gear is engaged and the engine can be started. Apply the parking brake if the car is stationary with the gear selector in **N** position.

In order to be able to move the gear selector from **N** to another gear position, the brake pedal must be depressed and key position must be **II**, see Key positions - functions at different levels (p. 81).

Drive position - D

D is the normal driving position. Shifting up and down takes place automatically based on the level of acceleration and speed. The car must be stationary when the gear selector is moved to **D** position from **R** position.

Geartronic – Manual gear positions (+S-)

The driver can also change gear manually using the Geartronic automatic gearbox. The car engine-brakes when the accelerator pedal is released.



The manual gear position is reached by moving the lever to the side from position **D** to the end position at "**+S-**". The combined instrument panel's symbol "**+S-**" changes colour from WHITE to ORANGE and the digits **1, 2, 3** etc. are displayed in a box, corresponding to the gear that has just been selected.

- Move the lever forwards towards "**+**" (plus) to change up a gear and release the





08 Starting and driving



lever, which returns to its rest position between + and -.

or

- Pull the lever back towards "-" (minus) to change down a gear and release it.

The manual gearshift mode "+S-" can be selected at any time while driving.

Geartronic automatically shifts down if the driver allows the speed to decrease lower than a level suitable for the selected gear, in order to avoid jerking and stalling.

To return to automatic driving mode:

- Move the lever to the side to the end position at **D**.

i NOTE

If the gearbox has a Sport programme then the gearbox will only become manual after the gear selector has been moved forwards or backwards in its "+S-" position. The combined instrument panel then changes indication from **S** to show which of the gears 1, 2, 3 etc. is engaged.

Paddles*

As a supplement to manual gear changing with the gear selector there are also controls located on the steering wheel, so-called "paddles".

To be able to change gear with the steering wheel paddles they must first be activated. This is by means of pulling one of the paddles toward the steering wheel - the combined instrument panel then changes indication from "**D**" to a figure, which indicates the current gear.

To then change gear one step:

- Pull one of the paddles backwards - towards the steering wheel - and release.



Both steering wheel "paddles".

- 1** "-": Selects the next lower gear.
- 2** "+": Selects the next higher gear.

A gear change occurs at each pull of the paddle provided that the engine speed does not leave the permitted range.

After each gear change the combined instrument panel changes figure to show the current gear.

i NOTE

Automatic deactivation

If the steering wheel paddles are not used then they are deactivated after a short time - this is indicated when the combined instrument panel switches indication, from the figure for the current gear back to "**D**".

The exception is during engine braking - then the paddles are activated as long as engine braking is in progress.

Manual deactivation

The steering wheel paddle shifters can also be deactivated manually:

- Pull both paddles toward the steering wheel and hold until the combined instrument panel changes character from the figure for the current gear to "**D**".

The paddles can also be used with the gear selector in Sport mode* - then the paddles are constantly activated without being deactivated.



Geartronic - Sport mode* (S)⁸



The Sport programme provides sportier characteristics and allows higher engine speed for the gears.

At the same time it responds more quickly to acceleration. During active driving, the use of a lower gear is prioritised, leading to a delayed upshift.

To activate Sport mode:

- Move the gear selector to the side from **D** position to the end position at "+**S**-" - the combined instrument panel changes indication from **D** to **S**.

Sport mode can be selected at any time while driving.

Geartronic - Winter mode

It can be easier to pull away on slippery roads if 3rd gear is engaged manually.

1. Depress the brake pedal and move the gear selector from **D** position to the end position at "+**S**-" - the combined instrument panel changes indication from **D** to the figure 1⁹.
2. Scroll up to gear 3 by pushing the lever forward towards "+" (plus) twice - the display shifts the indication from **1** to **3**.
3. Release the brake and accelerate carefully.

⁸ With certain engines only.

⁹ If the car has Sport mode* then "**S**" is shown first.

The gearbox "winter mode" means that the car moves off with a lower engine speed and reduced engine power on the drive wheels.

Kick-down

When the accelerator pedal is pressed all the way to the floor (beyond the position normally regarded as full acceleration) a lower gear is immediately engaged. This is known as kick-down.

If the accelerator is released from the kick-down position, the gearbox automatically changes up.

Kick-down is used when maximum acceleration is needed, such as for overtaking.

Safety function

To prevent overrevving the engine, the gearbox control program has a protective downshift inhibitor which prevents the kick-down function.

Geartronic does not permit downshifting/kick-down which would result in an engine speed high enough to damage the engine. Nothing happens if the driver still tries to shift down in this way at high engine speed - the original gear remains engaged.

When kick-down is activated the car can change one or more gears at a time depending on engine speed. The car changes up

when the engine reaches its maximum speed in order to prevent damage to the engine.

Towing

If the car has to be towed - see important information in the section Towing (p. 316).

Related information

- Transmission fluid - grade and volume (p. 420)
- Automatic gearbox -- Powershift* (p. 276)
- Gearboxes (p. 271)



Automatic gearbox -- Powershift*

The Powershift automatic gearbox transmits the motive force from the engine to the drive wheels with double mechanical clutch discs, as opposed to Geartronic which instead uses a hydraulic torque converter.



D: Automatic gear positions. +S-: Manual gear positions. S: Sport mode*.

Powershift transmission operates in the same way and has similar controls and functions as the Geartronic automatic transmission.

One exception is the function "Geartronic - Winter mode" (p. 273):

- Powershift enables driving away on a slippery road surface if **2nd** gear is engaged manually - instead of 3rd gear with Geartronic.

Towing

The model with Powershift transmission should not be towed as it is dependent on the engine running in order to receive sufficient lubrication. If towing (p. 316) still has to take place, the route must be as short as possible and then at very low speed.

In the event of uncertainty as to whether the car is equipped with Powershift or Geartronic transmission, this can be verified by checking the designation on the gearbox label under the bonnet, Type designations (p. 405). The designation "MPS6" means that it is Powershift transmission - otherwise it is Geartronic automatic transmission.

See also important information in section Towing (p. 316).

To bear in mind

The transmission's double clutch has overload protection that is activated if it becomes too hot, e.g. if the car is held stationary with the accelerator pedal on an uphill gradient for a long time.

Overheated transmission causes the car to shake and vibrate, and the warning symbol illuminates and the combined instrument panel shows a message. The transmission

can also overheat during slow driving in queues (10 km/h or slower) on an uphill gradient, or with a trailer hitched. The gearbox cools down when the car is stationary, with foot brake depressed and the engine running at idling speed.

Overheating during slow driving in queues can be avoided by driving in stages:

- Stop the car and wait with your foot on the brake pedal until there is a moderate distance to the traffic ahead, drive forward a short distance, and then wait another moment with your foot on the brake pedal.



IMPORTANT

Use the foot brake to hold the car stationary on an uphill gradient - do not hold the car with the accelerator pedal. The gearbox could then overheat.

Text message and action

In some situations the combined instrument panel may show a text message at the same time as a symbol is illuminated.



Symbol	Message	Driving characteristics	Action
	Transmission hot Brake to hold	Difficulty in maintaining even speed at constant engine speed.	Transmission overheated. Keep the car stationary using the foot brake ^A .
	Transmission hot Park safely Let engine run	Significant pulling in the car's traction.	Transmission overheated. Park the car immediately in a safe manner ^A .
	Transmission cooling Let engine run	No drive due to overheated gearbox.	Transmission overheated. For fastest cooling: Run the engine at idling speed with the gear lever in the N or P position until the message clears.

^A For fastest cooling: run the engine at idling speed with the gear lever in the **N** or **P** position, until the message clears.

The table shows three steps with an increased degree of seriousness should the transmission become too hot. In parallel with the text message, the driver is also advised that the car's electronics are temporarily changing the driving characteristics. Follow the instructions in the text message where appropriate.

NOTE

The examples in the table are no indication of the car being defective, but show that a safety function has been activated with a view to preventing damage to any of the car's components.

WARNING

If a warning symbol combined with the text **Transmission hot Park safely Let engine run** is ignored then the heat in the gearbox may become so high that the power transmission between engine and gearbox is temporarily halted in order to prevent the clutch from malfunctioning - the car then loses drive and is stationary until gearbox temperature has cooled to an acceptable level.

For more possible text messages with their respective proposals for solutions concerning automatic gearbox, see Messages (p. 115).

A text message extinguishes automatically after the action has been carried out or after one press on the indicator stalk **OK** button.

Related information

- Automatic gearbox -- Geartronic* (p. 273)
- Transmission fluid - grade and volume (p. 420)



Gear selector inhibitor

There are two different types of gear selector inhibitor - mechanical and automatic.

Mechanical gear selector inhibitor

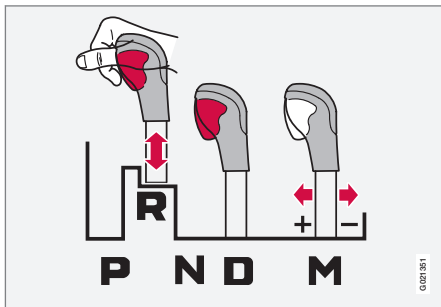

M: Manual shifting¹⁰ - "+/-" - or "-Sport mode.

The gear selector can be moved forward and back freely between **N** and **D**. Other positions are locked with a latch that is released with the inhibitor button on the gear selector.

With the inhibitor button depressed the lever can be moved forwards or backwards between **P**, **R**, **N** and **D**.

Automatic gear selector inhibitor

The automatic gearbox has special safety systems:

Parking position (P)

Stationary car with engine running:

- Keep your foot on the brake pedal when moving the gear selector to another position.

Electric gear inhibitor – Shiftlock Parking position (P)

In order to be able to move the gear selector from **P** to other gear positions, the brake pedal must be depressed and the key position (p. 81) must be **II**.

Shiftlock – Neutral (N)

If the gear selector is in **N** position and the car has been stationary for at least 3 seconds (irrespective of whether the engine is running) then the gear selector is locked.

In order to be able to move the gear selector from the **N** position to another gear position, the brake pedal must be depressed and the key position (p. 81) must be **II**.

Deactivate automatic gear selector inhibitor



If the car cannot be driven, e.g. due to a flat starter battery, the gear selector must be moved from the **P** position so that the car can be moved.

- 1 Lift the rubber mat in the compartment behind the centre console and locate a hole¹¹ for the key blade (p. 174) in the bottom of the compartment.
- 2 Search for a spring-loaded button down in the hole with the key blade; depress the button with the blade and hold.
- 3 Move the gear selector from the **P** position and pull up the key blade.
- 4 Set the rubber mat back in place.

¹⁰ The illustration is schematic.

¹¹ There may be 2 holes - one for the key blade and one that fixes the rubber mat.



Related information

- Automatic gearbox -- Geartronic* (p. 273)
- Automatic gearbox -- Powershift* (p. 276)

Hill start assist (HSA)*¹²

The foot brake can be released before setting off or reversing uphill - the HSA (Hill Start Assist) function means that the car does not roll backwards.

The function means that the pedal pressure in the brake system remains for several seconds while the driver's foot is moved from brake pedal to accelerator pedal.

The temporary braking effect releases after several seconds or when the driver accelerates.

Related information

- Starting the engine (p. 265)

All-wheel drive - (AWD)*

Optimal traction is achieved with all-wheel drive.

All-wheel drive is always available

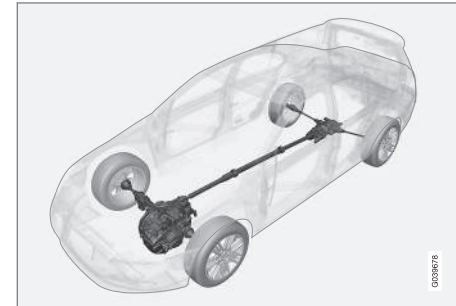

All-wheel drive (All Wheel Drive) means that the car is driving all four wheels at the same time.

The power is automatically distributed between the front and rear wheels. An electronically controlled clutch system distributes the power to the wheels that have the best grip on the current road surface. This provides the best traction and prevents wheel spin. Under normal driving conditions, the majority of power is transmitted to the front wheels.

All-wheel drive improves driving safety in rain, snow and icy conditions.

¹² Depends on engine and gearbox combination. HSA not possible with some combinations.



Hill Descent Control (HDC)*¹³

HDC can be compared to an automatic engine brake. When you release the accelerator on downhill gradients the car is normally braked by means of the engine striving for low engine idling speeds, so-called engine braking. But the steeper the roadway and the more load in the car, the faster the car coasts despite engine braking - the HDC function compensates for this with automatic brake intervention.

General information on HDC

HDC makes it possible to increase/reduce speed on steep downhill gradients, with a foot only on the accelerator pedal, without using the foot brake. The sensitivity of the accelerator pedal decreases and becomes more precise by means of the full actuation of the pedal being restricted to adjusting engine speed within a limited range. The brake system brakes itself and provides the car with a low and even speed, so allowing the driver to fully focus on steering.

HDC is particularly helpful on steep gradients with an uneven road surface and slippery sections. E.g. when launching a boat on a trailer from a ramp.

WARNING

HDC does not work in all situations but is designed merely as a supplementary aid.

The driver always bears ultimate responsibility for ensuring that the vehicle is driven safely.

Function

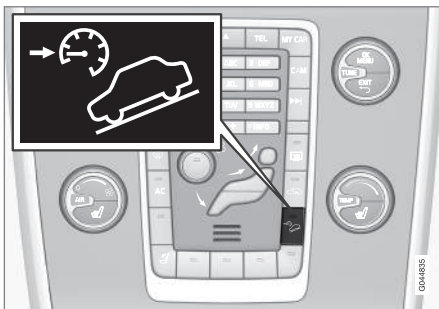

HDC On/Off.

HDC is activated or deactivated with one of the centre console's switches. The lamp within it illuminates when the function is activated.

! When HDC is operating, the combined instrument panel's symbol illuminates combined with the text message **Hill descent control ON**.

The function only operates in first gear position and in reverse gear. For an automatic gearbox, gear position **1** must be selected, which is shown with the figure **1** in the combined instrument panel, see Automatic gearbox -- Geartronic* (p. 273).

NOTE

HDC cannot be activated on an automatic gearbox when the gear selector is in position **D**.

Operation

HDC allows the car to roll at a maximum of 10 km/h forwards with engine braking and 7 km/h backwards. However, any speed within the gear's speed register can be selected using the accelerator pedal. When the accelerator pedal is released, the car is braked quickly to 10 or 7 km/h respectively, irrespective of the hill's gradient and without the need for the foot brake.

The brake lights come on automatically when the function is operating. The driver can brake or stop the car at any time by using the foot brake.

HDC is deactivated:

¹³ Only possible on the XC70 AWD.

* Option/accessory, for more information, see Introduction.



- with the centre console's On/Off button
- if a gear higher than **1** is selected on a manual gearbox
- if a gear higher than **1** is selected on an automatic gearbox, or if the gear selector is moved to position **D**.

The function can be disengaged at any time. If it takes place on a steep downhill gradient then the braking effect will not release directly, but slowly instead.

i NOTE

With HDC activated you may experience a delay between acceleration pedal activation and engine response.

Related information

- All-wheel drive - (AWD)* (p. 279)

Start/Stop*

Some engine and gearbox combinations come fitted with a Start/Stop function which engages in the event of e.g. stationary traffic or waiting at traffic lights - the engine is then switched off temporarily and restarts automatically when the journey is due to continue.

Environmental care is one of Volvo Car Corporation's core values and it influences all of our operations. This target orientation has resulted in several separate energy-saving functions of which Start/Stop is one, all with the collective task of reducing fuel consumption, which in turn helps to reduce exhaust emissions.

General information on Start/Stop



The engine is switched off - it becomes quieter and cleaner.

The Start/Stop function gives the driver the opportunity for a more active environmentally

conscious way of driving the car by means of being able to allow the engine to stop automatically, whenever appropriate.

Manual or Automatic

Note that there are differences in the Start/Stop function depending on whether the gearbox is manual or automatic.

Related information

- Start/Stop* - function and operation (p. 282)
- Starting the engine (p. 265)
- Start/Stop* - settings (p. 286)
- Start/Stop* - the engine does not auto-start (p. 285)
- Start/Stop* - the engine auto-starts (p. 284)
- Start/Stop* - the engine does not stop (p. 283)
- Start/Stop* - involuntary stop manual gearbox (p. 286)
- Start/Stop* - symbols and messages (p. 288)
- Battery - Start/Stop (p. 382)



Start/Stop* - function and operation

The Start/Stop function is activated automatically when the engine is started with the key.



The Start/Stop function is activated automatically when the engine is started with the key. The driver is made aware of this by the function's symbol illuminating in the combined instrument panel and the On/Off button lamp illuminating.



All of the car's normal systems such as lighting, radio, etc. work as normal even with an engine that has stopped automatically, except that some equipment may have the function temporarily reduced, e.g. the climate control system's fan speed or extremely high volume on the audio system.

Auto-stopping the engine

The following is required for the engine to auto-stop:

Conditions	M/A A
Dec clutch, set the gear lever in neutral position and release the clutch pedal - the engine stops automatically.	M
Stop the car with the foot brake and then keep your foot on the pedal - the engine stops automatically.	A

A M = Manual gearbox, A = Automatic gearbox.



If the ECO function is activated then the engine may auto-stop before the car is completely stationary.

For certain engine variants the engine may auto-stop before the car is stationary regardless of whether the ECO function is activated.



When the engine is auto-stopped, the combined instrument panel's symbol for the Start/Stop function illuminates.

Auto-starting the engine

Conditions	M/ A ^A
With the gear lever in neutral position:	M
1. Depress the clutch pedal or press the accelerator pedal - the engine starts. 2. Engage a suitable gear and drive.	
Release the foot pressure on the foot brake - the engine starts automatically and the journey can continue.	A
Maintain foot pressure on the foot brake and depress the accelerator pedal - the engine auto-starts.	A
The following option is also available on a downhill gradient:	M + A
Release the foot brake and let the car move off - the engine starts automatically when the speed exceeds normal walking pace.	

A M = Manual gearbox, A = Automatic gearbox.



Deactivating the Start/Stop function



In certain situations, it may be advisable to temporarily switch off the automatic Start/Stop function - this is carried out with a push of this button.



Disengaged function is indicated by the combined instrument panel's Start/Stop symbol and the On/Off button's lamp extinguishing.

The Start/Stop function is disengaged until it is reactivated with the button or until the next time the engine is started with the key.

Related information

- Start/Stop* (p. 281)
- Starting the engine (p. 265)
- Start/Stop* - settings (p. 286)
- Start/Stop* - the engine does not auto-start (p. 285)
- Start/Stop* - the engine auto-starts (p. 284)
- Start/Stop* - the engine does not stop (p. 283)
- Start/Stop* - involuntary stop manual gearbox (p. 286)
- Start/Stop* - symbols and messages (p. 288)
- Battery - Start/Stop (p. 382)

Start/Stop* - the engine does not stop

Although the Start/Stop function is activated, the engine does not always stop automatically.

The engine does not auto-stop if:

Conditions	M/A A
the car has not first achieved approx. 8 km/h after a key start or the last auto-stop.	M + A
the driver has opened the seat-belt's buckle.	M + A
the capacity of the starter battery is below the minimum permissible level.	M + A
the engine does not have normal operating temperature.	M + A
ambient temperature is around freezing point or above approx. 30 °C.	M + A
the windscreen's electric heating is activated.	M + A
the environment in the passenger compartment differs from the preset values - indicated by the ventilation fan running at a high speed.	M + A

Conditions	M/A A
the car is reversed.	M + A
the starter battery temperature is below the freezing point or is too high.	M + A
the driver makes greater steering wheel movements.	M + A
the exhaust system's particulate filter is full - the temporarily disengaged Start/Stop function is reactivated as soon as an automatic cleaning cycle has been performed (see Diesel particle filter (DPF) (p. 306)).	M + A
the road is very steep.	M + A
a trailer is connected electrically to the car's electrical system.	M + A
the bonnet has been opened ^B .	M + A
the gearbox does not have normal operating temperature.	A



08 Starting and driving



Conditions	M/A A
the atmospheric air pressure is less than equivalent to 1500-2500 metres above sea level - the current air pressure varies with the prevailing weather conditions.	A
adaptive cruise control Queue Assist is activated.	A
the gear selector is in S position ^C or "+/-".	A

A M = Manual gearbox, A = Automatic gearbox.

B With certain engines only.

C Sport mode.

Related information

- Start/Stop* (p. 281)
- Start/Stop* - function and operation (p. 282)
- Starting the engine (p. 265)
- Start/Stop* - settings (p. 286)
- Start/Stop* - the engine does not auto-start (p. 285)
- Start/Stop* - the engine auto-starts (p. 284)
- Start/Stop* - involuntary stop manual gearbox (p. 286)
- Start/Stop* - symbols and messages (p. 288)

- Battery - Start/Stop (p. 382)

Start/Stop* - the engine auto-starts

An auto-stopped engine may restart in certain cases without the driver having decided that the journey should continue.

In the following cases the engine also starts automatically if the driver has not depressed the clutch pedal (manual gearbox) or takes his/her foot off the brake pedal (automatic gearbox):

Conditions	M/A ^A
Misting forms on the windows.	M + A
The environment in the passenger compartment deviates from the preset values.	M + A
There is a temporarily high current take-off or starter battery capacity drops below the lowest permissible level.	M + A
Repeated pumping of the brake pedal.	M + A
The bonnet is opened ^B .	M + A
The car starts to roll, or there is a small increase in speed if the car auto-stopped without being completely stationary.	M + A



Conditions	M/A ^A
The driver's seatbelt buckle is opened with the gear selector in D or N position.	A
Steering wheel movements ^B .	A
The gear selector is moved out of the D position to S position ^C , R or "+/-".	A
The driver's door is opened with the gear selector in D position - a "ping" sound and text message inform that the Start/Stop function is active.	A

A M = Manual gearbox, A = Automatic gearbox.

B With certain engines only.

C Sport mode.

WARNING

Do not open the bonnet when the engine has stopped automatically - the engine may suddenly start automatically. First switch off the engine as normal using the **START/STOP ENGINE** button before opening the bonnet.

Related information

- Start/Stop* (p. 281)
- Start/Stop* - function and operation (p. 282)
- Starting the engine (p. 265)

- Start/Stop* - settings (p. 286)
- Start/Stop* - the engine does not auto-start (p. 285)
- Start/Stop* - the engine does not stop (p. 283)
- Start/Stop* - involuntary stop manual gearbox (p. 286)
- Start/Stop* - symbols and messages (p. 288)
- Battery - Start/Stop (p. 382)

Start/Stop* - the engine does not auto-start

The engine does not always auto-start after having auto-stopped.

In the following cases the engine does not auto-start after having auto-stopped:

Conditions	M/A ^A
A gear is engaged without declutching - a display text prompts the driver to set the gear lever in neutral position in order to enable auto-start.	M
The driver is unrestrained.	M
The driver is unrestrained, the gear selector is in P position and the driver's door is open - a normal engine start must take place.	A

A M = Manual gearbox, A = Automatic gearbox.

Related information

- Start/Stop* (p. 281)
- Start/Stop* - function and operation (p. 282)
- Starting the engine (p. 265)
- Start/Stop* - settings (p. 286)
- Start/Stop* - the engine auto-starts (p. 284)



- Start/Stop* - the engine does not stop (p. 283)
- Start/Stop* - involuntary stop manual gearbox (p. 286)
- Start/Stop* - symbols and messages (p. 288)
- Battery - Start/Stop (p. 382)

Start/Stop* - involuntary stop manual gearbox

If a start-up fails and the engine stops, proceed in accordance with the below:

1. Check that the driver side's seatbelt is locked in the seatbelt buckle.
2. Depress the clutch pedal again - the engine starts automatically.
3. In certain cases the gear lever must be set in neutral position. The combined instrument panel then shows the text **Put gear in neutral**.

Related information

- Start/Stop* (p. 281)
- Start/Stop* - function and operation (p. 282)
- Starting the engine (p. 265)
- Start/Stop* - settings (p. 286)
- Start/Stop* - the engine does not auto-start (p. 285)
- Start/Stop* - the engine auto-starts (p. 284)
- Start/Stop* - the engine does not stop (p. 283)
- Start/Stop* - symbols and messages (p. 288)
- Battery - Start/Stop (p. 382)

Start/Stop* - settings

The car's MY CAR menu system, under the **DRIVE** heading, contains information about Volvo's Start/Stop system, as well as recommendations for energy-saving driving techniques.

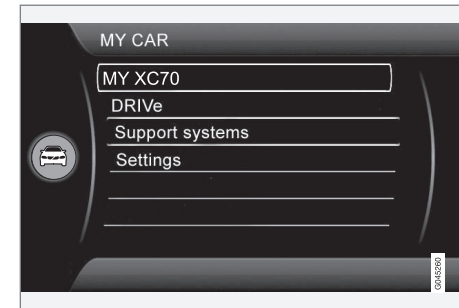

Related information

- Start/Stop* (p. 281)
- Start/Stop* - function and operation (p. 282)
- Starting the engine (p. 265)
- Start/Stop* - the engine does not auto-start (p. 285)
- Start/Stop* - the engine auto-starts (p. 284)
- Start/Stop* - the engine does not stop (p. 283)
- Start/Stop* - involuntary stop manual gearbox (p. 286)



- Start/Stop* - symbols and messages (p. 288)
- Battery - Start/Stop (p. 382)



08 Starting and driving







Start/Stop* - symbols and messages

The Start/Stop function can show text messages in the combined instrument panel.

Text message

 In combination with this indicator lamp the Start/Stop function may show text messages in the combined instrument panel for certain situations.

For some of them there is a recommended action that should be performed. The following table shows some examples.

Symbol	Message	Info/Action	M/A ^A
	Auto Start/Stop Service required	Start/Stop is not operational. Contact a workshop - an authorised Volvo workshop is recommended.	M + A
	Autostart Engine running + acoustic signal	Activated if the driver's door is opened with auto-stopped engine and the gear selector in D position.	A
	Press start button	The engine will not start automatically - start the engine as normal with the START/STOP ENGINE button.	M + A
	Depress clutch pedal to start	The engine is ready to auto-start - waiting for the clutch pedal to be depressed.	M
	Depress brake and clutch pedals to start	The engine is ready to auto-start - waiting for the brake or clutch pedal to be depressed.	M
	Put gear in neutral to start	Gear is engaged without declutching - disengage and set the gear lever in neutral position.	M



Symbol	Message	Info/Action	M/A ^A
	Select P or N to start	Start/Stop has been deactivated - move the gear selector to N or P position and start the engine as normal with the START/STOP ENGINE button.	A
	Press start button	The engine will not start automatically - start the engine as normal with the START/STOP ENGINE button and the gear selector in P or N .	A

^A M = Manual gearbox, A = Automatic gearbox.

If a message does not go out following completion of the action then a workshop should be contacted - an authorised Volvo workshop is recommended.

Related information

- Start/Stop* (p. 281)
- Start/Stop* - function and operation (p. 282)
- Starting the engine (p. 265)
- Start/Stop* - settings (p. 286)
- Start/Stop* - the engine does not auto-start (p. 285)
- Start/Stop* - the engine auto-starts (p. 284)
- Start/Stop* - the engine does not stop (p. 283)
- Start/Stop* - involuntary stop manual gearbox (p. 286)
- Battery - Start/Stop (p. 382)



ECO*

ECO¹⁴ is an innovative Volvo function for automatic-gearbox cars, capable of reducing fuel consumption by up to 5%, depending on the driver's driving style. The function gives the driver the option of a more active environmentally conscious way of driving.

General



The following are changed upon activation of the ECO function:

- Gearbox gearshift points.
- Engine management and response from the accelerator pedal.
- Start/Stop function - the engine can also auto-stop before the car has stopped down to being completely stationary.
- The Eco Coast function is activated - engine braking ceases.
- Climate control system settings - some electricity consumers are deactivated or operate at reduced power.

NOTE

When the ECO function is activated, several parameters in the climate control system's settings are changed, and several electricity consumer functions are reduced. Certain settings can be reset manually, but full functionality is only restored by deactivating the ECO function.

ECO - Operation



1 ECO On/Off

2 ECO symbol

The ECO function is deactivated when the engine is switched off, and must therefore be activated after each time the engine is started. There are exceptions for certain engines. However, it is easily verified by means of both the combined instrument

panel ECO symbol and the ECO button lamp illuminating when the function is activated.

ECO function On or Off



Disengaged ECO function is indicated by the combined instrument panel ECO symbol and the ECO button lamp extinguishing. The function is then switched off until it is reactivated with the ECO button.

Eco Coast - Function

The Eco Coast subfunction means in practice that engine braking is deactivated, meaning in turn that the car's kinetic energy is used to coast for longer distances. When the driver releases the accelerator pedal the gearbox is automatically disengaged from the engine whose speed is reduced to idling speed with minimum consumption.

This function is intended for use in the event of an anticipated reduction in speed, e.g. to coast forward to an intersection or a red light.

Eco Coast enables proactive driving where the driver can use the so-called "Pulse & Glide" technique and a minimum of braking.

A combination of Eco Coast and temporarily deactivated ECO function can also collec-

¹⁴ Not possible on the XC60 and XC70 with AWD.

* Option/accessory, for more information, see Introduction.



tively contribute to reduced consumption. Accordingly:

- Active Eco Coast: Long coasting **without** engine braking = Low consumption and
- Deactivated ECO function: Short coasting **with** engine braking = Minimum consumption.

NOTE

However, to achieve optimal low fuel consumption, Eco Coast in combination with short coasting distances should generally be avoided.

Activating Eco Coast

The function is activated when the accelerator pedal is fully released, in combination with the following parameters:

- **ECO** button activated
- Gear selector in **D** position
- Speed within the range of approx. 65-140 km/h
- The road's downhill gradient is not steeper than approx. 6%.

Deactivate Eco Coast

In certain situations it may be desirable to deactivate the Eco Coast function. Examples of such situations include:

- on steep downhill gradients - to be able to use engine braking.
- before an imminent overtaking manoeuvre - in order to be able to complete it in the safest possible way.

Deactivating Eco Coast and returning to engine braking can be performed as follows:

- Press the **ECO** button.
- Move the gear lever to manual "**S+/-**" position.
- Change gear with the steering wheel paddle shifters.
- Actuate the accelerator or brake pedal.

Eco Coast - Limitations

The function is not available if:

- cruise control is activated
- the road's downhill gradient is steeper than approx. 6%
- manual gear changing is performed with the steering wheel paddle shifters*
- engine and/or gearbox are not at normal operating temperature.
- the gear selector is moved from **D-** to "**S +/-**" position
- speed is outside the range of approx. 65-140 km/h

More information and settings

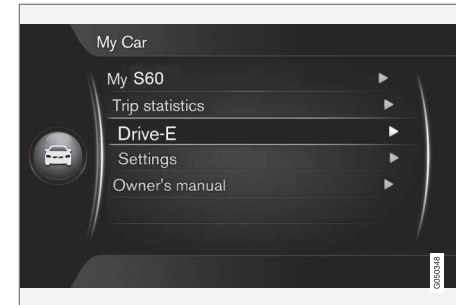

The car's menu system **MY CAR** contains further information on the ECO concept - see the section MY CAR (p. 116).

Related information

- General information on climate control (p. 130)



Foot brake

The foot brake is used to reduce the car's speed while driving.

The car is equipped with two brake circuits. If a brake circuit is damaged then the brake pedal will engage deeper and a higher pressure on the pedal is needed to produce the normal braking effect.

The driver's brake pedal pressure is assisted by a brake servo.

WARNING

The brake servo only works when the engine is running.

If the foot brake is used when the engine is switched off then the pedal will feel stiff and a higher pedal pressure must be used to brake the car.

For cars with the Hill start assist (HSA)* (p. 279)* function, the pedal returns more slowly than usual to normal position if the car is parked on a gradient or on an uneven surface.

In very hilly terrain or when driving with a heavy load the brakes can be relieved by using engine braking. Engine braking is most efficiently used if the same gear is used downhill as up.

For more general information on heavy loads on the car, see Engine oil - adverse driving conditions (p. 416).

Braking on wet roads

When driving for a long time in heavy rain without braking, the braking effect may be delayed slightly when next using the brakes. This may also be the case after a car wash. It is then necessary to depress the brake harder. For this reason, maintain a greater distance to the traffic ahead.

Brake the car firmly after driving on wet roads and after a car wash. The brake discs are then warmed up, dry more quickly and are protected against corrosion. Take the prevailing traffic situation into account when braking.

Braking on salted roads

When driving on salted roads a layer of salt may form on the brake discs and brake linings. This may extend braking distance. For this reason, keep an extra large safety distance to the vehicle ahead. Also make sure of the following:

- Brake occasionally to remove any layer of salt. Make sure that other road users are not put at risk by the braking.
- Gently depress the brake pedal when driving is finished and before the next journey starts.

Maintenance

To keep the car as safe and reliable as possible, follow the Volvo service intervals as specified in the Service and Warranty Booklet.

New and replacement brake linings and brake discs only provide optimal brake performance after a few hundred kilometres after "wearing-in". Compensate for the reduced brake performance by depressing the brake pedal harder. Volvo recommends only fitting brake linings that are approved for your Volvo.



IMPORTANT

The wear on the brake system's components must be checked regularly.



Contact a workshop for information about the procedure or engage a workshop to carry out the inspection - an authorised Volvo workshop is recommended.



Symbols and messages

Symbol	Specification
	Constant glow – Check the brake fluid level. If the level is low, fill with brake fluid and check for the cause of the brake fluid loss.
	Constant glow for 2 seconds when the engine is started - automatic function check.

WARNING

If  and  illuminate at the same time, there may be a fault in the brake system.

If the level in the brake fluid reservoir is normal at this stage, drive carefully to the nearest workshop and have the brake system checked - an authorised Volvo workshop is recommended.

If the brake fluid is below the **MIN** level in the brake fluid reservoir, do not drive further before topping up the brake fluid.

The reason for the loss of brake fluid must be investigated.

Related information

- Parking brake (p. 295)
- Foot brake - emergency brake lights and automatic hazard warning flashers (p. 294)
- Foot brake - emergency brake assistance (p. 294)
- Foot brake - anti-lock braking system (p. 293)

Foot brake - anti-lock braking system

The anti-lock braking system, ABS (Anti-lock Braking System), prevents the wheels from locking up during braking.

The function allows the steering ability to be maintained, and it is easier to swerve to avoid a hazard for example. Vibration may be felt in the brake pedal when this is engaged and this is normal.

A short test of the ABS system is made automatically after the engine has been started when the driver releases the brake pedal. A further automatic test of the ABS system may be made when the car reaches 10 km/h. The test may be experienced as pulses in the brake pedal.

Related information

- Foot brake (p. 292)
- Parking brake (p. 295)
- Foot brake - emergency brake lights and automatic hazard warning flashers (p. 294)
- Foot brake - emergency brake assistance (p. 294)



Foot brake - emergency brake lights and automatic hazard warning flashers

Emergency brake lights are activated in order to alert vehicles behind about heavy braking. The function means that the brake light flashes instead of - as in normal braking - shining with a constant glow.

Emergency brake lights are activated at speeds above 50 km/h in the event of heavy braking. After the car's speed has been slowed down to below 10 km/h the brake light returns from flashing to the normal constant glow - while at the same time the car's hazard warning lights (p. 96) are activated. These flash until the driver accelerates the car up to a higher speed again or switches off the hazard warning lights.

Related information

- Foot brake (p. 292)
- Parking brake (p. 295)
- Foot brake - emergency brake assistance (p. 294)
- Foot brake - anti-lock braking system (p. 293)

Foot brake - emergency brake assistance

Emergency brake assistance EBA (Emergency Brake Assist) helps to increase the braking force and so reduce the braking distance.

EBA detects the driver's braking style and increases the braking force when necessary. The brake force can be reinforced up to the level when the ABS system is engaged. The EBA function is interrupted when the pressure on the brake pedal is reduced.

NOTE

When EBA is activated the brake pedal lowers slightly more than usual, depress (hold) the brake pedal as long as necessary. If the brake pedal is released then all braking ceases.

Related information

- Foot brake (p. 292)
- Parking brake (p. 295)
- Foot brake - emergency brake lights and automatic hazard warning flashers (p. 294)
- Foot brake - anti-lock braking system (p. 293)



Parking brake

The parking brake holds the car stationary, when the driver's seat is empty, by mechanically locking/blocking two wheels.

Function

A faint electric motor noise can be heard when the electrically-controlled parking brake is being applied. The noise can also be heard during the automatic function checking of the parking brake.

If the car is stationary when the parking brake is applied then it only acts on the rear wheels. If it is applied when the car is moving then the normal foot brake is used, i.e. the brake acts on all four wheels. Brake function changes over to the rear wheels when the car is almost stationary.

Low battery voltage

If the battery voltage is too low then the parking brake can neither be released nor applied. Connect a donor battery if the battery voltage is too low, see Jump starting with battery (p. 270).

Applying the parking brake



Parking brake control - apply.

1. Depress the foot brake pedal firmly.
2. Press the parking brake control.
 - >  The combined instrument panel's symbol starts flashing - once there is a constant glow the parking brake is applied.
3. Release the foot brake pedal and make sure that the car is at a standstill position.

When parking the vehicle, always engage 1st gear (for manual gearbox) or put the gear selector in position **P** (for automatic gearbox).

Emergency brake

In an emergency the parking brake can be applied when the vehicle is in motion by pressing and holding the parking brake con-

trol. The braking procedure is stopped when the control is released.

NOTE

An acoustic signal sounds while emergency braking is active at high speeds.

Parking on a hill

If the car is parked facing uphill:

- Turn the wheels **away from** the kerb.

If the car is parked facing downhill:

- Turn the wheels **towards** the kerb.

WARNING

Always apply the parking brake when parking on a slope - leaving the car in gear, or in **P** if it has automatic transmission, is not sufficient to hold the car in all situation.



Disengaging the parking brake



Parking brake control - release.

Cars with manual gearbox

Releasing manually

1. Insert the remote control key in the ignition switch¹⁵.
2. Depress the foot brake pedal firmly.
3. Apply the parking brake control.
 - > The parking brake releases and the combined instrument panel's symbol extinguishes.

NOTE

The parking brake can also be released manually by depressing the clutch pedal instead of the brake pedal. Volvo recommends that the brake pedal is used.

Releasing automatically

1. Start the engine.
2. Engage 1st gear or reverse gear.
3. Ease up the clutch and depress the accelerator.
 - > The parking brake releases and the combined instrument panel's symbol extinguishes.

Cars with automatic gearbox

Releasing manually

1. Insert the remote control key in the ignition switch¹⁵.
2. Depress the foot brake pedal firmly.
3. Pull the control.
 - > The parking brake releases and the combined instrument panel's symbol extinguishes.

Releasing automatically

1. Put the seatbelt on.
2. Start the engine.
3. Depress the foot brake pedal firmly.

4. Move the gear selector to position **D** or **R** and depress the accelerator.
 - > The parking brake releases and the combined instrument panel's symbol extinguishes.

NOTE

For safety reasons, the parking brake is only released automatically if the engine is running and the driver is wearing a seatbelt. The parking brake is released immediately on cars with automatic gearbox when the accelerator pedal is depressed and the gear selector is in position **D** or **R**.

Heavy load uphill

A heavy load, such as a trailer, can cause the car to roll backward when the parking brake is released automatically on a steep incline. Avoid this by depressing the control while driving off. Release the control when the engine achieves traction.

Replacing the brake linings

The rear brake linings must be replaced at a workshop due to the design of the electric parking brake - an authorised Volvo workshop is recommended.

¹⁵ For a car with the Keyless system: Press **START/STOP ENGINE**.



Symbols and messages

For information on how the combined instrument panel's text messages can be shown

and deleted, see Messages - handling (p. 116).

Symbol	Message	Meaning/Action
	"Message"	<ul style="list-style-type: none"> Read the combined instrument panel's message.
		<p>A flashing symbol indicates that the parking brake is applied.</p> <p>If the symbol flashes in any other situation then this means that a fault has arisen.</p> <ul style="list-style-type: none"> Read the combined instrument panel's message.
	Handbrake not fully released	<p>A fault is preventing the parking brake from being released:</p> <ul style="list-style-type: none"> Try to apply and release the brake. <p>If the fault persists after a few attempts:</p> <ul style="list-style-type: none"> Visit a workshop - an authorised Volvo workshop is recommended. <p>Note: A warning signal sounds if the journey is continued with this error message.</p>



Symbol	Message	Meaning/Action
	Handbrake not applied	<p>A fault is preventing the parking brake from being applied:</p> <ul style="list-style-type: none">• Try to release and apply the brake. <p>If the fault persists after a few attempts:</p> <ul style="list-style-type: none">• Visit a workshop - an authorised Volvo workshop is recommended. <p>The message is also illuminated on cars with manual gearbox when the car is driven at low speed with the door open in order to alert the driver that the parking brake may have been unintentionally disengaged.</p>
	Handbrake Service required	<p>A fault has arisen:</p> <ul style="list-style-type: none">• Try to apply and release the brake. <p>If the fault persists after a few attempts:</p> <ul style="list-style-type: none">• Visit a workshop - an authorised Volvo workshop is recommended.

If the car has to be parked before a possible fault has been rectified, then the wheels must be turned as if parking on a hill and 1st gear engaged (manual gearbox) or the gear selector must be in position **P** (automatic gearbox).

A text message can be acknowledged by briefly pressing the **OK** button on the direction indicator stalk.

Related information

- Foot brake (p. 292)



Driving in water

Driving in water means that the car is driven through a water-covered roadway. Driving in water must be carried out with great caution.

The car can be driven through water at a maximum depth of 25 cm (30 cm with XC70) at a maximum speed of walking pace. Extra caution must be exercised when passing through flowing water.

During driving in water, maintain a low speed and do not stop the car. When the water has been passed, depress the brake pedal lightly and check that full brake function is achieved. Water and mud for example can make the brake linings wet resulting in delayed brake function.

- Clean the electric contacts of the electric engine block heater* and trailer coupling after driving in water and mud.
- Do not let the car stand with water over the sills for any long period of time - this could cause electrical malfunctions.

! IMPORTANT

Engine damage can occur if water enters the air filter.

In depths greater than 25 cm (30 cm with XC70), water could enter the transmission. This reduces the lubricating ability of the oils and shortens the service life of these systems.

Damage to any component, engine, transmission, turbocharger, differential or its internal components caused by flooding, hydrostatic locking or oil shortage, is not covered by the warranty.

In the event of the engine stalling in water, do not try restart - tow the car from the water to a workshop - an authorised Volvo workshop is recommended. Risk of engine breakdown.

Related information

- Recovery (p. 318)
- Towing (p. 316)

Overheating

Under special conditions, for example hard driving in hilly terrain and hot climate, there is a risk that the engine and drive system may overheat - in particular with a heavy load.

For information about overheating when driving with a trailer, see Driving with a trailer* (p. 309).

- Remove any auxiliary lamps from in front of the grille when driving in hot climates.
- If the temperature in the engine's cooling system is too high then a warning symbol is illuminated in the combined instrument panel's information display and a text message **High engine temperature Stop safely** is shown there - stop the car in a safe way and allow the engine to run at idling speed for several minutes in order to cool down.
- If the text message **High engine temperature Turn off engine** or **Engine coolant level low Stop safely** is shown then the engine must be switched off after stopping the car.
- In the event of overheating in the gearbox a built-in protection function is activated which, amongst other things, illuminates a warning symbol in the combined instrument panel, and its display shows the text message **Transmission hot Reduce speed** or **Transmission hot Stop safely Wait for cooling** - follow the recommendation given and lower the speed and

* Option/accessory, for more information, see Introduction.





stop the car in a safe way and allow the engine to run at idling speed for a few minutes in order to allow the gearbox to cool down.

- If the car overheats, the air conditioning may be switched off temporarily.
- Do not turn the engine off immediately you stop after a hard drive.



NOTE

It is normal for the engine's cooling fan to operate for a time after the engine has been switched off.

Driving with open tailgate/boot lid

When driving with the tailgate open, toxic exhaust fumes can be sucked into the car through the cargo area.



WARNING

Do not drive with an open tailgate! Toxic exhaust fumes could be drawn into the car through the cargo area.

Related information

- Loading (p. 158)

Overload - starter battery

The electrical functions in the car load the starter battery (p. 378) to varying degrees. Avoid using the key position II (p. 81) when the engine is switched off. Instead use position I - which uses less power.

Also, be aware of different accessories that load the electrical system. Do not use functions which use a lot of power when the engine is switched off. Examples of such functions are:

- ventilation fan
- headlamps
- windscreen wiper
- audio system (high volume).

If the starter battery voltage is low then the combined instrument panel's information display shows the text **Low battery charge Power save mode**. The energy-saving function then shuts down certain functions or reduces certain functions such as the ventilation fan and/or audio system.

- In which case, charge the starter battery by starting the engine and then running it for at least 15 minutes - starter battery charging is more effective during driving than running the engine at idling speed while stationary.



Before a long journey

Before a long journey, it makes good sense to go through the following points:

- Check that the engine is working normally and that fuel consumption (p. 425) is normal.
- Make sure that there are no leaks (fuel, oil or other fluid).
- Check all bulbs and tyre tread depths.
- Carrying a warning triangle (p. 331) is a legal requirement in certain countries.

Related information

- Engine oil - checking and filling (p. 363)
- Changing wheels - removing wheels (p. 328)
- Lamp replacement - general (p. 369)

Winter driving

For winter driving it is important to perform certain checks in order to ensure that the car can be driven safely.

Check the following in particular before the cold season:

- The engine coolant (p. 366) must contain 50% glycol. This mixture protects the engine against frost erosion down to approximately -35°C . To avoid health risks, different types of glycol must not be mixed.
- The fuel tank must be kept filled to prevent condensation.
- Engine oil viscosity is important. Oils with lower viscosity (thinner oils) facilitate starting in cold weather and also reduce fuel consumption while the engine is cold. For more information on suitable oils, see Engine oil - adverse driving conditions (p. 416).



IMPORTANT

Low viscosity oil must not be used for hard driving or in hot weather.

- The condition of the starter battery and charge level must be inspected. Cold weather places great demands on the

starter battery and its capacity is reduced by the cold.

- Use washer fluid (p. 377) to avoid ice forming in the washer fluid reservoir.

To achieve optimum roadholding Volvo recommends using winter tyres on all wheels if there is a risk of snow or ice.



NOTE

The use of winter tyres is a legal requirement in certain countries. Studded tyres are not permitted in all countries.

Slippery driving conditions

Practise driving on slippery surfaces under controlled conditions to learn how the car reacts.

Related information

- Winter driving (p. 301)



Fuel filler flap - Opening/closing

The fuel filler flap can be opened/closed as follows:

Opening/closing the fuel filler flap



Open the fuel filler flap using the button on the lighting panel - the flap opens when the button is released.

 In the combined instrument panel's display the arrow on the symbol indicates which side of the car the fuel cap is located.

- Close the fuel filler flap by pressing it in until a click confirms that it is closed.

Related information

- Filling up with fuel (p. 302)

Fuel filler flap - manual opening

The fuel filler flap can be opened manually when electric opening from the passenger compartment is not possible.

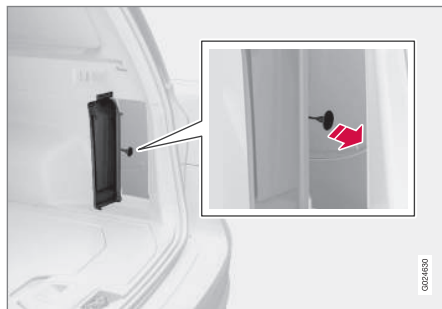

1. Open/remove the side hatch in the cargo area (same side as fuel filler flap) and locate the green cord with handle.
2. Pull the cord gently straight back until the fuel filler flap folds out with a "click".

IMPORTANT

Pull the wire gently - minimal force is required to disengage the hatch lock.

Related information

- Filling up with fuel (p. 302)

Filling up with fuel

Important things to consider when refuelling.

Opening/closing the fuel cap

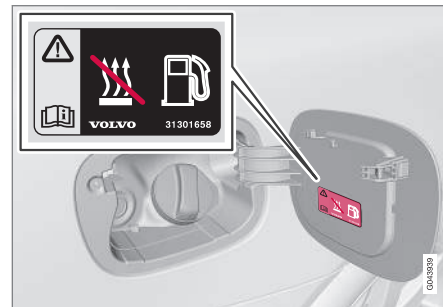

A certain overpressure may arise in the tank in the event of high outside temperatures. Open the cap slowly.

- After refuelling - refit the cap and turn it until one or more clicking sounds are heard.

Filling up with fuel

- Do not overfill the tank but fill until the pump nozzle cuts out.

NOTE

Excess fuel in the tank can overflow in hot weather.



Filling with a fuel can¹⁶

When filling with a fuel can, use the funnel located under the floor hatch in the cargo area.

Make sure you insert the funnel's pipe firmly into the filler pipe. The filler pipe has an openable cover and the funnel's pipe must be slid past the cover before filling can begin.

Related information

- Fuel filler flap - manual opening (p. 302)
- Fuel - handling (p. 303)

Fuel - handling

Fuel of a lower quality than that recommended by Volvo must not be used as engine power and fuel consumption is negatively affected.

WARNING

Always avoid inhaling fuel vapour and getting fuel splashes in the eyes.

In the event of fuel in the eyes, remove any contact lenses and rinse the eyes in plenty of water for at least 15 minutes and seek medical attention.

Never swallow fuel. Fuels such as petrol, bioethanol and mixtures of them and diesel are highly toxic and could cause permanent injury or be fatal if swallowed. Seek medical attention immediately if fuel has been swallowed.

WARNING

Fuel which spills onto the ground can be ignited.

Switch off the fuel-driven heater before starting to refuel.

Never carry an activated mobile phone when refuelling. The ring signal could cause spark build-up and ignite petrol fumes, leading to fire and injury.

IMPORTANT

Mixtures of various fuel types or use of fuels which are not recommended will invalidate Volvo's guarantees and any supplementary service agreements; this is applicable to all engines.

NOTE

Extreme weather conditions, driving with a trailer or driving at high altitudes in combination with fuel grade are factors that could affect the car's performance.

Related information

- Economical driving (p. 308)
- Fuel - diesel (p. 304)
- Diesel particle filter (DPF) (p. 306)
- Fuel consumption and CO2 emissions (p. 425)
- Fuel tank - volume (p. 423)

¹⁶ Only applies to cars with diesel engine.



Fuel - petrol

Petrol is used as fuel.

Only use petrol from well-known producers. Never use fuel of dubious quality. Petrol must fulfil the EN 228 standard if this is available.

- 95 RON can be used for normal driving.
- 98 RON is recommended for optimum performance and minimum fuel consumption.

When driving in temperatures above +38 °C, fuel with the highest possible octane rating is recommended for optimum performance and fuel economy.

IMPORTANT

- Use only unleaded petrol to avoid damaging the catalytic converter.
- Fuel containing metallic additives must not be used.
- Do not use any additives which have not been recommended by Volvo.

Alcohols-ethanol

IMPORTANT

- Fuel that contains up to 10 percent by volume ethanol is permitted.
- EN 228 E10 petrol (max 10 percent by volume ethanol) is approved for use.
- Ethanol higher than E10 (max 10 percent by volume ethanol) is not permitted. T.ex. E85 is not permitted.

Related information

- Fuel - handling (p. 303)
- Economical driving (p. 308)
- Fuel consumption and CO2 emissions (p. 425)
- Fuel tank - volume (p. 423)

Fuel - diesel

Diesel is used as fuel.

Only use diesel fuel from well-known producers. Never use fuel of dubious quality. Diesel fuel must fulfil the EN 590 and/or SS 155435 standards. Diesel engines are sensitive to contaminants in the fuel, such as metals and a high volume of sulphur for example.

At low temperatures (-6 °C to -40 °C), a paraffin precipitate may form in the diesel fuel, which may lead to ignition problems. Special diesel fuel designed for low temperatures around freezing point is available from the major oil companies. This fuel is less viscous at low temperatures and reduces the risk of paraffin precipitate.

The risk of condensation in the fuel tank is reduced if the tank is kept well filled. When refuelling, check that the area around the fuel filler pipe is clean. Avoid spilling fuel onto the paintwork. Wash off any spillage with detergent and water.

**! IMPORTANT**

Diesel fuel must:

- fulfil the EN 590 and/or SS 155435 standards
- have a sulphur content not exceeding 10 mg/kg
- have a maximum of 7 vol % FAME (Fatty Acid Methyl Ester).

! IMPORTANT

Diesel type fuels that must not be used:

- Special additives
- Marine diesel fuel
- Heating oil
- FAME¹⁷ (Fatty Acid Methyl Ester) and vegetable oil.

These fuels do not fulfil the requirements in accordance with Volvo recommendations and generate increased wear and engine damage that is not covered by the Volvo warranty.

Empty tank

The design of the fuel system in a diesel engine means that if the vehicle runs out of fuel, the tank may need to be vented in the workshop in order to restart the engine after fuelling.

Once the engine has stopped due to fuel starvation, the fuel system needs a few moments to carry out a check. Do this before starting the engine, once the fuel tank has been filled with diesel:

1. Insert the remote control key in the ignition switch and push it in to the end position. For more information, see Key positions (p. 80).
2. Press the **START** button **without** depressing the brake and/or clutch pedal.
3. Wait approx. one minute.
4. To start the engine: Depress the brake and/or clutch pedal and then press the **START** button again.

i NOTE

Before filling with fuel in the event of fuel shortage:

- Stop the car on as flat/level ground as possible - if the car is tilting there is a risk of air pockets in the fuel supply.

Draining condensation from the fuel filter

The fuel filter separates condensation from the fuel. Condensation can disrupt engine operation.

The fuel filter must be drained at the intervals specified in the Service and Warranty Booklet or if you suspect that the car has been filled with contaminated fuel. For more information, see Volvo service programme (p. 355).

! IMPORTANT

Certain special additives remove the water separation in the fuel filter.

Related information

- Fuel - handling (p. 303)
- Diesel particle filter (DPF) (p. 306)
- Fuel consumption and CO2 emissions (p. 425)

¹⁷ Diesel fuel may contain a certain amount of FAME, but further amounts must not be added.



Diesel particle filter (DPF)

Diesel cars are equipped with a particle filter, which results in more efficient emission control.

The particles in the exhaust gases are collected in the filter during normal driving. So-called "regeneration" is started in order to burn away the particles and empty the filter. This requires the engine to have reached normal operating temperature.

Regeneration of the particle filter is automatic and normally takes 10-20 minutes. It may take a little longer at a low average speed. Fuel consumption may increase slightly during regeneration.

Regeneration in cold weather

If the car is frequently driven short distances in cold weather then the engine does not reach normal operating temperature. This means that regeneration of the diesel particle filter does not take place and the filter is not emptied.

When the filter has become approx. 80% full of particles, a yellow warning triangle is shown in the combined instrument panel, and the message **Soot filter full** See manual is shown in its information display.

Start regeneration of the filter by driving the car until the engine reaches normal operating temperature, preferably on a main road or

motorway. The car should then be driven for approximately 20 minutes more.

NOTE

The following may arise during regeneration:

- a smaller reduction of engine power may be noticed temporarily
- fuel consumption may increase temporarily
- a smell of burning may arise.

When regeneration is complete the warning text is cleared automatically.

Use the parking heater* in cold weather - the engine then reaches normal operating temperature more quickly.

IMPORTANT

If the filter is completely filled with particles, it may be difficult to start the engine and the filter is non-functional. Then there is a risk that the filter will need to be replaced.

Related information

- Fuel - handling (p. 303)
- Fuel - diesel (p. 304)
- Fuel consumption and CO2 emissions (p. 425)
- Fuel tank - volume (p. 423)

Filling vehicle gas*

Points to remember when filling vehicle gas (CNG - Compressed Natural Gas) for cars with the Bi-Fuel engine alternative.

Filling

Vehicle gas is filled via the gas nipple that is located next to the fuel cap inside the fuel filler flap.

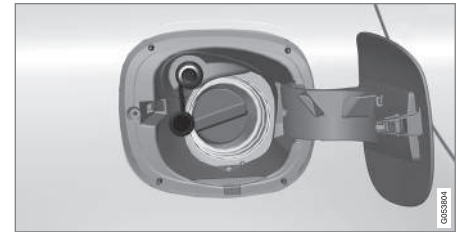

1. Open the fuel filler flap and remove the nipple's protective cover.
2. Push the nozzle towards the nipple and make sure that the hose nozzle is attached by turning the handle on the nozzle to the left.
3. Then hold the start button on the gas pump depressed for approx. 5 seconds.
 - > The tank is filled in a couple of minutes.
4. Remove the nozzle by turning its handle to the right.



- Refit the nipple's protective cover and close the fuel filler flap.

Filling stations for vehicle gas



Road sign for filling stations that offer vehicle gas.

Related information

- Bi-Fuel* - introduction to vehicle gas (p. 24)
- Inspection and service of the system for vehicle gas* (p. 357)
- Fuel filler flap - manual opening (p. 302)

Switch for gas operation*

For cars with the Bi-Fuel engine alternative there is a switch to change between gas operation (CNG - Compressed Natural Gas) and petrol operation. This is located by the centre console.

Operation



Press the switch to change between gas operation and petrol operation.

When the switchover takes place a clicking noise can be heard in the cargo area. This is normal - the noise is created when the tank valves open.

The switch has two positions:

- **BI-FUEL** illuminates in green - the car is being driven on vehicle gas
- **BI-FUEL** illuminates in orange - the car is being driven on petrol (fuel gauge for vehicle gas is extinguished).

The car always starts with petrol even if gas operation is selected. When the engine has started the system automatically changes to gas operation - normally within a few seconds of a warm start.

When starting with a cold engine it will take longer before the car changes to gas operation in order to ensure the lowest possible emissions.

warning lamp

If the warning lamp in the switch illuminates, and/or repetitive acoustic signals can be heard, then the car needs servicing. Acknowledge the warning by pressing the switch and visit the nearest workshop - an authorised Volvo workshop is recommended.

Related information

- Bi-Fuel* - introduction to vehicle gas (p. 24)
- Filling vehicle gas* (p. 306)
- Inspection and service of the system for vehicle gas* (p. 357)
- Fuel filler flap - manual opening (p. 302)



Catalytic converters

The purpose of the catalytic converters is to purify exhaust gases. They are located close to the engine so that operating temperature is reached quickly.

The catalytic converters consist of a monolith (ceramic or metal) with channels. The channel walls are lined with a thin layer of platinum/rhodium/palladium. These metals act as catalysts, i.e. they participate in and accelerate a chemical reaction without being used up themselves.

Lambda-sond™ oxygen sensor

The Lambda-sond is part of a control system intended to reduce emissions and improve fuel economy. For more information, see Fuel consumption and CO₂ emissions (p. 425).

An oxygen sensor monitors the oxygen content of the exhaust gases leaving the engine. This value is fed into an electronic system that continuously controls the injectors. The ratio of fuel to air directed to the engine is continuously adjusted. These adjustments create optimal conditions for efficient combustion, and together with the three-way catalytic converter reduce harmful emissions (hydrocarbons, carbon monoxide and nitrous oxides).

Related information

- Economical driving (p. 308)
- Fuel - petrol (p. 304)

- Fuel - diesel (p. 304)

Economical driving

Driving economically means driving smoothly while thinking ahead and adjusting your driving style and speed to the prevailing conditions.



- For lowest fuel consumption, activate ECO* (p. 290)²⁰.
- Use the ECO Guide which indicates how fuel-efficiently the car is being driven, see Eco guide & Power guide* (p. 69).
- Drive in the highest gear possible, adapted to the current traffic situation and road - lower engine speeds result in lower fuel consumption. Use the gear indicator (p. 272).
- Avoid sudden unnecessary acceleration and heavy braking.
- High speed results in increased fuel consumption - the wind resistance increases with speed.
- Do not run the engine to operating temperature at idling speed, but rather drive with a light load as soon as possible - a cold engine consumes more fuel than a warm one.
- Drive with the correct air pressure in the tyres and check this regularly - select ECO tyre pressure for best results, see Tyres - approved tyre pressures (p. 430).
- Choice of tyres can affect fuel consumption - seek advice on suitable tyres from a dealer.
- Remove unnecessary items from the car - the greater the load the higher the consumption.

- Use engine braking to slow down, when it can take place without risk to other road users.
- A roof load and ski box increase air resistance, leading to higher consumption - remove the load carriers when not in use.
- Avoid driving with open windows.

For information about Volvo Car Corporation's environmental philosophy, see Environmental philosophy (p. 22).

For more information about fuel consumption, see Fuel consumption and CO2 emissions (p. 425).



WARNING

Never switch off the engine while moving, such as downhill, this deactivates important systems such as the power steering and brake servo.

Related information

- Fuel - handling (p. 303)
- Fuel consumption and CO2 emissions (p. 425)
- Fuel tank - volume (p. 423)

Driving with a trailer*

When driving with a trailer there are a number of important points to think about regarding e.g. the towing bracket, the trailer and how the load is positioned in the trailer.

Payload depends on the car's kerb weight. The total of the weight of the passengers and all accessories, e.g. towbar, reduces the car's payload by a corresponding weight. For more detailed information, see Weights (p. 410).

If the towing bracket is mounted by Volvo, then the car is delivered with the necessary equipment for driving with a trailer.

- The car's towing bracket must be of an approved type.
- If the towbar is retrofitted, check with your Volvo dealer that the car is fully equipped for driving with a trailer.
- Distribute the load on the trailer so that the weight on the towing bracket complies with the specified maximum towball load.
- Increase the tyre pressure to the recommended pressure for a full load. For information on the tyre pressure, see Tyres - approved tyre pressures (p. 430).
- The engine is loaded more heavily than usual when driving with a trailer.

²⁰ Only applies to cars with automatic gearbox.





08 Starting and driving



- Do not tow a heavy trailer when the car is brand new. Wait until it has been driven at least 1000 km.
- The brakes are loaded much more than usual on long and steep downhill slopes. Downshift to a lower gear and adjust your speed.
- For safety reasons, the maximum permitted speed for the car when coupled with a trailer should not be exceeded. Follow the regulations in force for the permitted speeds and weights.
- Maintain a low speed when driving with a trailer up long, steep ascents.
- Avoid driving with a trailer on inclines of more than 12%.

Trailer cable

An adapter is required if the car's towing bracket has 13 pin electrics and the trailer has 7 pin electrics. Use an adapter cable approved by Volvo. Make sure the cable does not drag on the ground.

Direction indicators and brake lights on the trailer

If any of the trailer's lamps for direction indicators are broken, then the combined instrument panel's symbol for direction indicators flashes faster than normal and the information display shows the text **Trailer indicator malfunction**.

If any of the trailer's lamps for the brake light are broken then the **Trailer brake light malfunction** text is shown.

Level control*

The rear shock absorbers maintain a constant height irrespective of the car's load (up to the maximum permissible weight). When the car is stationary the rear of the car lowers slightly, which is normal

Trailer weights

For information on Volvo's permitted trailer weights, see Towing capacity and towball load (p. 411).



NOTE

The stated maximum permitted trailer weights are those permitted by Volvo. National vehicle regulations can further limit trailer weights and speeds. Towbars may be certified for higher or lower towing weights than the car can actually tow.



WARNING

Follow the stated recommendations for trailer weights. Otherwise, the car and trailer may be difficult to control in the event of sudden movement and braking.

Related information

- Driving with a trailer* - manual gearbox (p. 311)
- Driving with a trailer* - automatic gearbox (p. 311)
- Towing bracket/Towbar* (p. 312)
- Lamp replacement - general (p. 369)



Driving with a trailer* - manual gearbox

When driving with a trailer in hilly terrain in a hot climate there may be a risk of overheating.

Overheating

When driving with a trailer in hilly terrain in a hot climate there may be a risk of overheating.

- Do not run the engine at higher revolutions than 4500 rpm (diesel engines: 3500 rpm) - otherwise the oil temperature may become too high.

Diesel engine 5-cyl

- In the event of a risk of overheating the optimal speed for the engine is 2300-3000 rpm for optimal circulation of the coolant.

Related information

- Driving with a trailer* (p. 309)

Driving with a trailer* - automatic gearbox

When driving with a trailer in hilly terrain in a hot climate there may be a risk of overheating.

- An automatic gearbox selects the optimum gear related to load and engine speed.
- In the event of overheating a warning symbol is illuminated in the combined instrument panel with a message that is shown in the information display - follow the recommendation given.

Steep inclines

- Do not lock the automatic transmission in a higher gear than the engine "can cope with" - it is not always a good idea to drive at a high gear with low engine revolutions.

Parking on a hill

- Depress the foot brake.
 - Activate the parking brake.
 - Move the gear selector to position **P**.
 - Release the foot brake.
- Move the gear selector to park position **P** when parking an automatic car with a hitched trailer. Always use the parking brake.
 - Block the wheels with chocks when parking a car with hitched trailer on a hill.



IMPORTANT

See also the specific information on slow driving with a trailer for cars with the Powershift automatic transmission, see Automatic gearbox -- Powershift* (p. 276).

Starting on a hill

- Depress the foot brake.
- Move the gear selector to driving position **D**.
- Release the parking brake.
- Release the foot brake and start driving off.

Related information

- Automatic gearbox -- Geartronic* (p. 273)



Towing bracket/Towbar*

A towing bracket means that it is possible to e.g. tow a trailer behind the car.

If the car is equipped with a detachable/removable towbar, the installation instructions for the loose section must be followed carefully, see Detachable towbar* - attachment/removal (p. 314).

WARNING

If the car is fitted with a Volvo detachable towbar:

- Follow the installation instructions carefully.
- The detachable section must be locked with the key before setting off.
- Check that the indicator window shows green.

Important checks

- The towbar's towball must be cleaned and greased regularly.

NOTE

When a hitch with a vibration damper is used, the towball must not be lubricated.

Related information

- Driving with a trailer* (p. 309)

Detachable towbar* - storage

Store the detachable towbar in the cargo area.

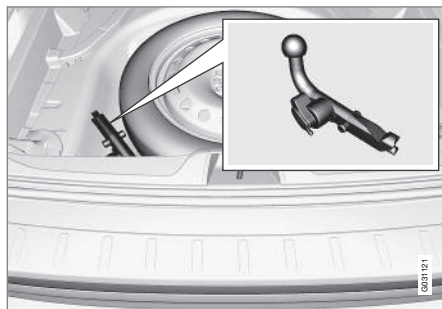

Towbar storage space.

IMPORTANT

Always remove the towbar after use and store it in the appointed location in the car, firmly fastened with its strap.

Applies to Bi-Fuel* cars

The towbar is stored together with the tools in the storage compartment in the front part of the cargo area.

Related information

- Detachable towbar* - specifications (p. 313)
- Detachable towbar* - attachment/removal (p. 314)

- Driving with a trailer* (p. 309)



Detachable towbar* - specifications

Specifications for detachable towbar.

Specifications

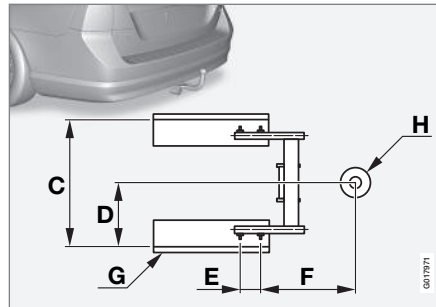
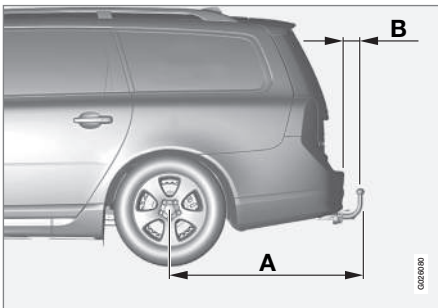

Dimensions, mounting points (mm)

A (V70)	1129
A (XC70)	1113
B (V70)	93
B (XC70)	80
C	855
D	428
E	112
F	346
G	Side member
H	Ball centre

Related information

- Detachable towbar* - attachment/removal (p. 314)
- Detachable towbar* - storage (p. 312)
- Driving with a trailer* (p. 309)





Detachable towbar* - attachment/ removal

The attachment/removal of the detachable towbar is performed in the following way:

Attaching



- 1 Remove the protective cover by first pressing in the catch  and then pulling the cover straight back .

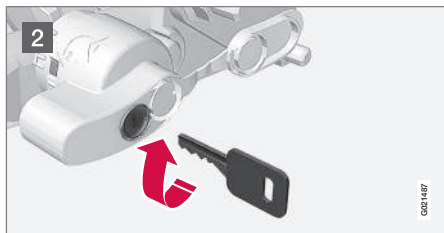

- 2 Ensure that the mechanism is in the unlocked position by turning the key clockwise.

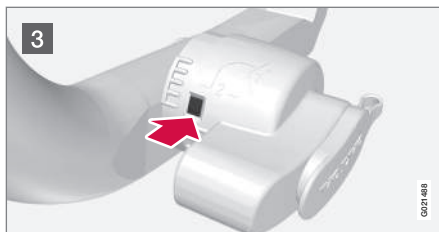

- 3 The indicator window must show red.

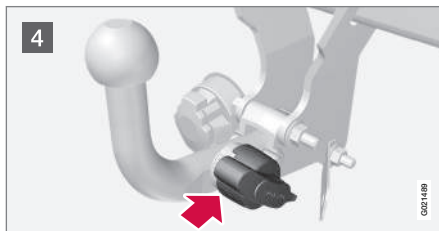

- 4 Insert the towbar until you hear a click.

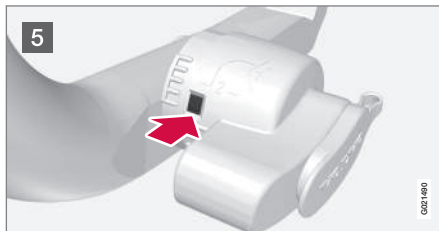

- 5 The indicator window must show green.



- 6 Turn the key anticlockwise to locked position. Remove the key from the lock.

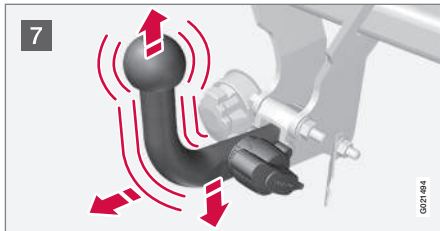

7 Check that the towbar is secure by pulling it up, down and back.

⚠ WARNING

If the towbar is not fitted correctly then it must be detached and reattached in accordance with the previous instructions.

! IMPORTANT

Only grease in the ball for the towing hitch, the remainder of the towbar should be clean and dry.



8 Safety cable.

⚠ WARNING

Take care to secure the trailer's safety cable in the intended bracket.

Removing the towbar

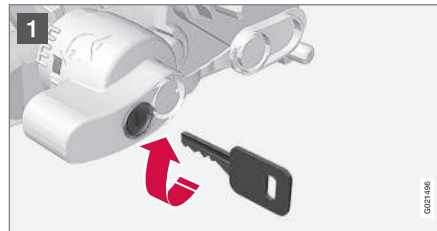

1 Insert the key and turn it clockwise to the unlocked position.

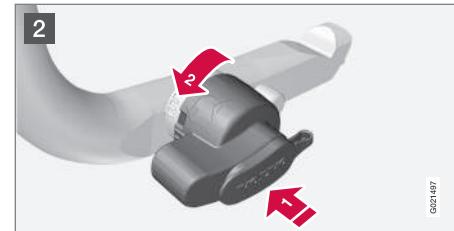

2 Push in the locking wheel **1** and turn it anticlockwise **2** until you hear a click.

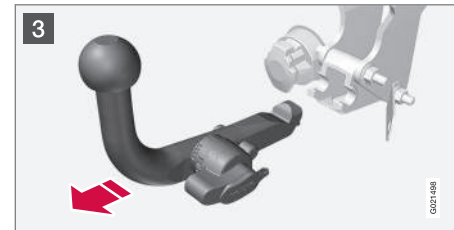

3 Turn the locking wheel down fully, until it comes to a stop. Hold it in this position while pulling the towbar rearward and upward.

⚠ WARNING

Secure the towbar safely if it is stored in the car, see Detachable towbar* - storage (p. 312).





- 4 Push the protective cover until it snaps tight.

Related information

- Detachable towbar* - storage (p. 312)
- Detachable towbar* - specifications (p. 313)
- Driving with a trailer* (p. 309)

Towing

During towing, one vehicle is towed by another vehicle using a tow rope.

Find out the statutory maximum speed limit for towing before towing begins.

1. Unlock the steering lock by inserting the remote control key in the ignition switch and giving a long press on the **START/STOP ENGINE** button - key position **II** is activated, see Key positions (p. 80) for more information about key positions.
2. The remote control key must remain in the ignition switch while the car is being towed.
3. Keep the towline taut when the towing vehicle reduces speed by holding your foot gently pressed on the brake pedal - thereby avoiding unnecessary jerking.
4. Be prepared to brake to stop.



WARNING

- Check that the steering lock is unlocked before towing.
- The remote control key must be in key position **II** - in position **I** all airbags are deactivated.
- Never remove the remote control key from the ignition switch when the car is being towed.



WARNING

The brake servo and power steering do not work when the engine is switched off - the brake pedal needs to be depressed about 5 times more heavily and the steering is considerably heavier than normal.

Manual gearbox

Prior to towing:

- Move gear lever into neutral and release the parking brake.

Automatic gearbox Geartronic

Prior to towing:

- Move the gear selector to position **N** and release the parking brake.



IMPORTANT

- Do not tow the vehicle at speeds higher than 80 km/h or for distances in excess of 80 km.
- Note that the car must always be towed with the wheels rolling forward.

Automatic gearbox Powershift

Models with the Powershift gearbox should not be towed. If towing still has to take place, the route must be as short as possible and then with very low speed.



In the event of uncertainty as to whether or not the car is equipped with Powershift transmission, this can be verified by checking the designation on the gearbox label under the bonnet, see Type designations (p. 405). The designation "MPS6" means that it is Powershift transmission - otherwise it is Geartronic automatic transmission.

! IMPORTANT

Avoid towing.

- However, the car can be towed for a short distance at low speed to move it from a dangerous position - not further than 10 km and not faster than 10 km/h. Note that the car must always be towed with the wheels rolling forward.
- In the event of moving a longer distance than 10 km, the car must be transported with the drive wheels raised from the road - professional recovery is recommended.

Prior to towing:

- Move the gear selector to position **N** and release the parking brake.

Jump starting

Do not tow the car to bump start the engine. Use a donor battery if the starter battery is

discharged and the engine does not start, see Jump starting with battery (p. 270).

! IMPORTANT

The catalytic converter may be damaged during attempts to tow-start the engine.

Related information

- Towing eye (p. 317)
- Recovery (p. 318)

Towing eye

The towing eye is screwed into a threaded socket behind a cover on the right-hand side of the bumper, front or rear.

Attaching the towing eye

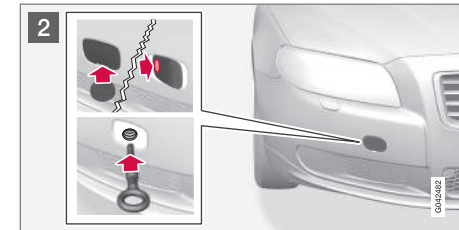
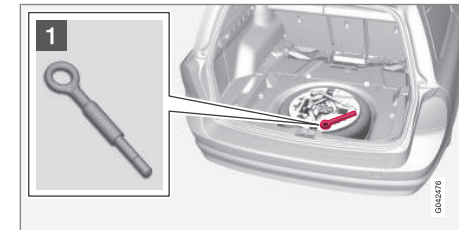

- 1 Take out the towing eye that is located under the floor hatch in the cargo area.

Applies to Bi-Fuel* cars: the towing eye is stored together with the tools in the storage compartment in the front part of the cargo area.

* Option/accessory, for more information, see Introduction.





08 Starting and driving



2 The cover for the towing eye's attachment point is available in two variants which must be opened in different ways:

- Open the variant with a recess using a coin or similar inserted in the recess, turning it outwards. Then turn out the cover completely and remove it.
- The second variant has a marking along one side or in a corner: Press the marking with a finger and fold out the opposite side/corner at the same time using a coin or similar - the cover turns around its axis and can then be removed.

Screw the towing eye right in up to its flange. Turn in the towing eye firmly e.g. using the wheel wrench.

After use, unscrew the towing eye and return it to its place.

Finish by refitting the cover onto the bumper.

The towing eye may be used to pull the car up onto a recovery vehicle with a flatbed platform. The car's position and ground clearance determine whether it is possible. If the slope of the recovery vehicle's ramp is too steep, or if the ground clearance under the car is inadequate, then the car may be damaged if you try to pull it up using the towing eye. Raise the car using the recovery vehicle's lifting device if necessary.



WARNING

No one/nothing is allowed to remain behind the recovery vehicle while the car pulled up onto the flatbed platform.



IMPORTANT

The towing eye is only designed for towing on roads - **not** for pulling the car unstuck or out of a ditch. Call a recovery service for recovery assistance.

Related information

- Towing (p. 316)
- Recovery (p. 318)

Recovery

Recovery means that the vehicle is transported away by means of another vehicle.

Call a recovery service for recovery assistance.

The towing eye may be used to pull the car up onto a recovery vehicle with a flatbed platform. The car's position and ground clearance determine whether it is possible. If the slope of the recovery vehicle's ramp is too steep, or if the ground clearance under the car is inadequate, then the car may be damaged if you try to pull it up using the towing eye. Raise the car using the recovery vehicle's lifting device if necessary.



WARNING

No one/nothing is allowed to remain behind the recovery vehicle while the car pulled up onto the flatbed platform.



IMPORTANT

The towing eye is only designed for towing on roads - **not** for pulling the car unstuck or out of a ditch. Call a recovery service for recovery assistance.

**!** **IMPORTANT**

Note that the car must always be transported with the wheels rolling forward.

- An All Wheel Drive car (AWD) with raised front suspension must not be towed at speeds above 70 km/h. It should not be towed further than 50 km.

Related information

- Towing (p. 316)

09



WHEELS AND TYRES

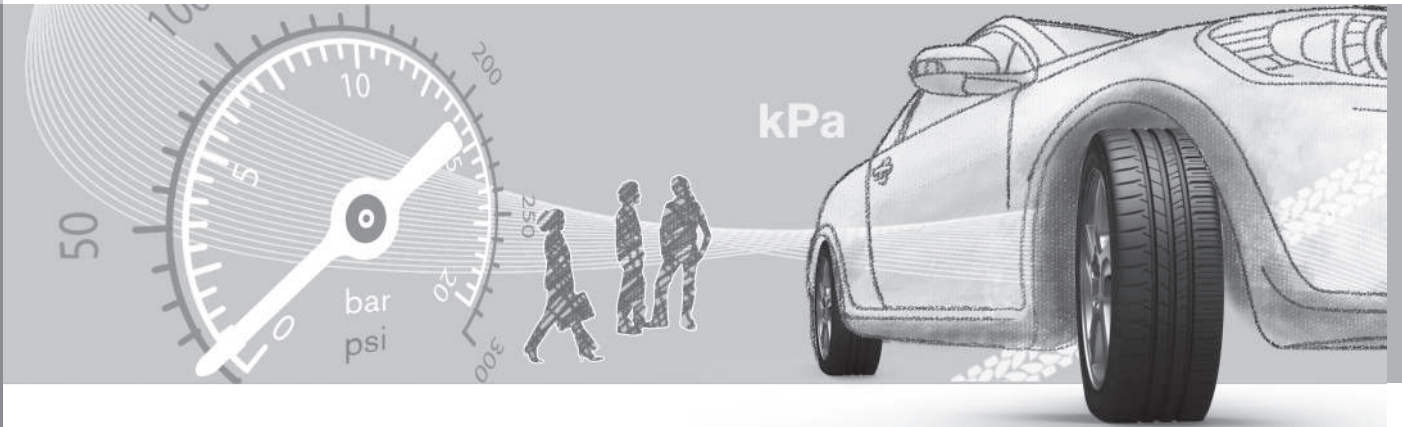



Tyres - maintenance

Amongst other things, the function of the tyres is to carry load, provide grip on the road surface, dampen vibration and protect the wheel from wear.

Driving characteristics

Tyres greatly affect the car's driving characteristics. The type of tyre, dimensions, tyre pressure and speed rating are important for how the car performs.

Tyre age

All tyres older than 6 years old should be checked by an expert even if they seem undamaged. Tyres age and decompose, even if they are hardly ever or never used. The function can therefore be affected. This applies to all tyres that are stored for future use. Examples of external signs which indicate that the tyre is unsuitable for use are cracks or discoloration.

New tyres



Tyres are perishable. After a few years they begin to harden at the same time as the friction capacity/characteristics gradually deteriorate. For this reason, aim to get as fresh tyres as possible when you replace them. This is especially important with regard to winter tyres. The last four digits in the sequence mean the week and year of manufacture. This is the tyre's DOT marking (Department of Transportation), and this is stated with four digits, for example 1510. The tyre in the figure was manufactured in week 15 of 2010.

Summer and winter wheels

When summer and winter wheels are changed the wheels should be marked with which side of the car they were mounted on, for example **L** for left and **R** for right.

Wear and maintenance

Correct tyre pressure (p. 323) results in more even wear. Driving style, tyre pressure, climate and road condition affect how quickly your tyres age and wear.

To avoid differences in tread depth and to prevent wear patterns arising, the front and rear wheels can be switched with each other. A suitable distance for the first change is approx. 5000 km and then at 10000 km intervals.

Volvo recommends that an authorised Volvo workshop is contacted for checking if you are uncertain about tread depth. If significant differences in wear (> 1 mm difference in tread depth) between tyres have already occurred, then the least worn tyres must always be fitted on the rear. Understeer is normally easier to correct than oversteer, and leads to the car continuing forwards in a straight line rather than having the rear end skidding to one side, resulting in possible complete loss of control over the car. This is why it is important for the rear wheels never to lose grip before the front wheels.



WARNING

A damaged tyre may lead to loss of control over the car.



Storage

Wheels with tyres fitted must be stored lying down or hanging up - never standing up.

Related information

- Tyres - dimensions (p. 325)
- Tyres - speed ratings (p. 326)
- Tyres - load index (p. 326)
- Tyres - direction of rotation (p. 322)
- Tyres - tread wear indicators (p. 323)

Tyres - direction of rotation

Tyres with a tread pattern which are designed to only turn in one direction have the direction of rotation marked with an arrow.

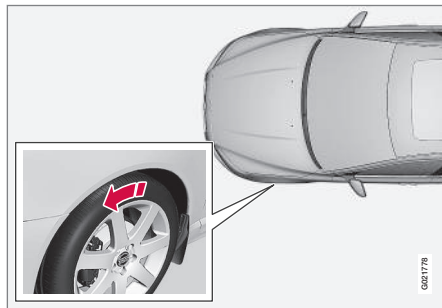

The arrow shows the tyre's direction of rotation.

The tyre must always rotate in the same direction throughout its lifespan. Tyres should only be switched between front and rear positions, never between left and right-hand sides, or vice versa. If the tyres are fitted incorrectly, the car's braking characteristics and capacity to force rain and slush out of the way are adversely affected. Tyres with the greatest tread depth should always be fitted to the rear of the car (to decrease the risk of skidding).



NOTE

Make sure that both pairs of wheels have the same type and dimension, and also the same make.

Follow the recommended tyre pressures specified in the tyre pressure table (p. 430).

Related information

- Tyres - dimensions (p. 325)
- Tyres - speed ratings (p. 326)
- Tyres - load index (p. 326)
- Tyres - maintenance (p. 321)
- Tyres - tread wear indicators (p. 323)



Tyres - tread wear indicators

Tread wear indicators show the status of the tyre's tread depth.

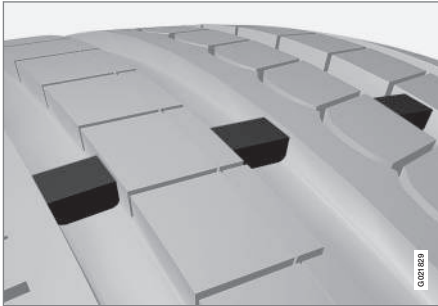

Tread wear indicators.

A tread wear indicator is a narrow elevation across the longitudinal grooves of the tyre's tread pattern. On the side of the tyre are the letters TWI (Tread Wear Indicator). When the tyre's tread depth is down to 1.6 mm, the tread will be level in height with the tread wear indicators. Change to new tyres as soon as possible. Remember that tyres with little tread depth provide very poor grip in rain and snow.

Related information

- Tyres - dimensions (p. 325)
- Tyres - speed ratings (p. 326)
- Tyres - load index (p. 326)
- Tyres - direction of rotation (p. 322)

- Tyres - maintenance (p. 321)

Tyres - air pressure

Tyres can have different air pressures which are measured in bar.

Check the air pressure in the tyres

The tyre pressures must be checked every month.

This also applies to the car's spare wheel.



09 Wheels and tyres

09



- Tyre pressure for the car's recommended tyre dimension.
- ECO pressure¹.
- Spare tyre pressure (Temporary Spare).

Check the tyre pressure on cold tyres. "Cold tyres" means the tyres are the same temperature as the ambient temperature. After several few kilometres of driving, the tyres warm up and the pressure increases.

Inadequate tyre pressure increases fuel consumption, shortens tyre lifespan and impairs the car's driving characteristics. Driving on tyres with tyre pressure that is too low could result in the tyres overheating and being damaged. Tyre pressure affects travelling comfort, road noise and driving characteristics.



NOTE

Tyre pressure decreases over time, this is a natural phenomenon. Tyre pressure also varies depending on ambient temperature.

Tyre pressure label



The tyre pressure label on the driver's side door pillar (between frame and rear door) shows which pressures the tyres should have at different loads and speed conditions. This is also specified in the tyre pressure table, see Tyres - approved tyre pressures (p. 430).

Fuel economy, ECO pressure

In order to obtain optimum fuel economy at speeds below 160 km/h an ECO pressure is recommended (applies to both full and light load), see Tyres - approved tyre pressures (p. 430).

Related information

- Tyres - dimensions (p. 325)
- Tyres - speed ratings (p. 326)
- Tyres - load index (p. 326)

- Tyres - maintenance (p. 321)
- Tyres - tread wear indicators (p. 323)

¹ ECO pressure results in improved fuel economy.



Wheel and wheel rim dimensions

Wheel and rim dimensions are designated in accordance with the examples in the table below.

The car has an approval for the complete vehicle. This means that certain combinations of wheel (wheel rim) and tyre are approved.

Wheels (rims) have a designation of dimensions, for example: 7Jx16x50.

7	Rim width in inches
J	Rim flange profile
16	Rim diameter in inches
50	Off-set in mm (distance from wheel centre to wheel contact surface against the hub)

Related information

- Tyres - dimensions (p. 325)
- Tyres - approved tyre pressures (p. 430)

Tyres - dimensions

The car's tyres have a certain dimension, see the examples in the table below.

The dimensions are stated on all car tyres.

Example of designation: 225/50R17 98W.

225	Tyre width (mm)
50	Ratio between tyre wall height and tyre width (%)
R	Radial ply
17	Rim diameter in inches (")
98	Codes for the maximum permitted tyre load, tyre load index (LI)
W	Speed rating for maximum permitted speed, speed rating (SS). (In this case 270 km/h.)

The car has an approval for the complete vehicle with certain combinations of wheel rims and tyres.



WARNING

19-inch wheels must **never** be used on cars that are **not** equipped with the R-Design or Sport chassis options. The use of 19-inch wheels on cars with **standard chassis** constitutes a safety risk, with a risk of vehicle damage, and it impairs the car's driving characteristics.

Related information

- Tyres - speed ratings (p. 326)
- Tyres - load index (p. 326)
- Tyres - direction of rotation (p. 322)
- Tyres - maintenance (p. 321)
- Tyres - approved tyre pressures (p. 430)
- Wheel and wheel rim dimensions (p. 325)



Tyres - load index

Load index indicates a tyre's ability to carry a certain load.

Each tyre has a certain capacity to carry a load, a load index (LI). The car's weight determines the load capacity required of the tyres. Minimum permissible index is indicated in the load index table.

Related information

- Tyres - dimensions (p. 325)
- Tyres - approved tyre pressures (p. 430)
- Tyres - speed ratings (p. 326)
- Tyres - maintenance (p. 321)

Tyres - speed ratings

Each tyre can withstand a certain maximum speed and therefore belongs to a particular speed rating (SS - Speed Symbol).

Tyre speed class must at least correspond with the car's top speed. The table below indicates the maximum permitted speed that applies for each speed rating (SS). The only exception to these regulations is the winter tyre (p. 327)², where a lower speed rating may be used. If such a tyre is chosen, the car must not be driven faster than the speed rating of the tyre (for example, class Q can be driven at a maximum of 160 km/h). Traffic regulations determine how fast a car can be driven, not the speed rating of the tyres.



NOTE

The maximum permitted speed is specified in the table.

Q	160 km/h (used only on winter tyres)
T	190 km/h
H	210 km/h
V	240 km/h

W	270 km/h
Y	300 km/h



WARNING

The car must be fitted with tyres which have the same or a higher load index (p. 326) (LI) and speed rating (SS) than specified. If a tyre with too low a load index or speed rating is used, it may over-heat.

Related information

- Tyres - dimensions (p. 325)
- Tyres - load index (p. 326)
- Tyres - direction of rotation (p. 322)

² Both those with metal studs and those without.



Wheel bolts

Wheel bolts are used to fasten the wheels at the hubs and are available in different versions.

IMPORTANT

The wheel bolts must be tightened to 140 Nm. Overtightening can damage the nuts and the bolts.

Only use rims that are tested and approved by Volvo and which are Volvo genuine accessories. Check the torque with a torque wrench.

Locking wheel bolts*

Locking wheel bolts* can be used on both aluminium and steel rims. Under the cargo area floor there is space for the sleeve for the lockable wheel bolts.

Related information

- Wheel and wheel rim dimensions (p. 325)

Winter tyres

Winter tyres are tyres that are adapted for winter road conditions.

Winter tyres

Volvo recommends winter tyres with particular dimensions. Tyre dimensions are dependent on engine variant. When driving on winter tyres, the correct type of tyres must be fitted to all four wheels.

NOTE

Volvo recommends that you consult a Volvo dealer about which wheel rim and tyre types are most suitable.

Studded tyres

Studded winter tyres should be run in gently for 500-1000 km so the studs settle properly into the tyres. This gives the tyre, and especially the studs, a longer service life.

NOTE

The legal provisions for the use of studded tyres vary from country to country.

Tread depth

Road conditions with ice, slush and low temperatures place considerably higher demands on tyres than summer conditions. Volvo therefore recommends not to drive on winter tyres that have a tread depth of less than 4 mm.

Using snow chains

Snow chains may only be used on the front wheels (also applies to all-wheel drive cars). Never drive faster than 50 km/h with snow chains. Avoid driving on bare ground as this wears out both the snow chains and tyres.

WARNING

Use Volvo genuine snow chains or equivalent chains designed for the car model, and tyre and rim dimensions. In the event of uncertainty Volvo recommends that you consult an authorised Volvo workshop. The wrong snow chains may cause serious damage to your car and lead to an accident.

Related information

- Changing wheels - removing wheels (p. 328)



Changing wheels - removing wheels

The car's wheels can be changed for e.g. winter wheels/winter tyres.

Spare wheel*

The spare wheel (Temporary spare) is only intended for use temporarily and must be replaced by an ordinary wheel as soon as possible. The car's handling may be altered by the use of the spare wheel. The spare wheel is smaller than the normal wheel. The car's ground clearance is affected accordingly. Pay attention to high kerbs and do not machine wash the car. If the spare wheel is fitted on the front axle, you cannot use snow chains at the same time. On all-wheel drive cars the drive on the rear axle can be disconnected. The spare wheel must not be repaired.

The correct tyre pressure for the spare wheel is stated in the tyre pressure table (p. 430).

! IMPORTANT

- Never drive faster than 80 km/h with a spare wheel on the car.
- The car must never be driven fitted with more than one "Temporary Spare" wheel.

The spare wheel is located in the spare wheel well with the outside down. The same bolt runs through to secure the spare wheel and

the foam block. The foam block contains all the tools needed to change the wheels.

Taking out the spare wheel under the cargo area floor

1. Fold up the cargo area floor, from the rear and forwards.
2. Undo the retaining screw.
3. Lift out the foam block with its tools.
4. Lift out the spare wheel.

Removing

Set up warning triangle (p. 331) if a wheel is replaced in trafficked location. The car and jack* must be on a firm horizontal surface.

1. Apply the parking brake, (p. 295) and engage reverse gear, or position **P** if the car has an automatic gearbox.

! WARNING

Check that the jack is not damaged, that the threads are thoroughly lubricated and that it is free from dirt.

i NOTE

Volvo recommends only using the jack* that belongs to the car model in question, which is indicated on the jack's label.

The label also indicates the jack's maximum lift capacity at a specified minimum lifting height.

2. Take out jack*, wheel wrench*, removal tool for wheel covers* and plastic wheel bolt cap removal tool. They will be found in the foam block. If another jack is selected, see Raising the car (p. 358).



Tool for removing the plastic caps on the wheel bolts.

0051100



- Place chocks in front of and behind the wheels which will remain on the ground to prevent them from rolling. Use heavy wooden blocks or large stones for example.
- Cars with steel rims have removable wheel covers. Use the removal tool to hook in and pull off any full-wheel wheel covers. Alternatively, the wheel covers can be pulled away by hand.

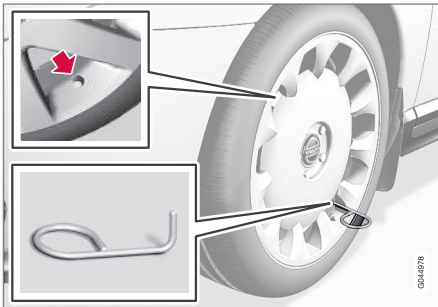

- Screw together the towing eye with the wheel wrench* to the stop position.

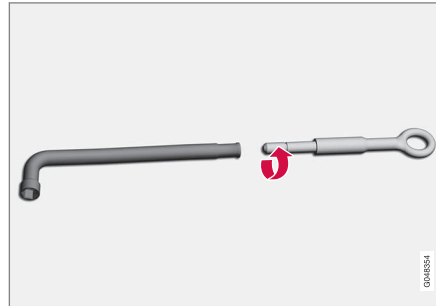

! IMPORTANT

The towing eye must be screwed all the way into the wheel bolt wrench.

- Remove the plastic caps from the wheel bolts with the intended tool.
- Loosen the wheel bolts $\frac{1}{2}$ -1 turn anti-clockwise with the wheel wrench.

! WARNING

Never position anything between the ground and the jack, nor between the jack and the car's jacking point.

- There are two jacking points on each side of the car. Wind up the jack so that the flange in the bodywork ends up in the notch in the head of the jack.

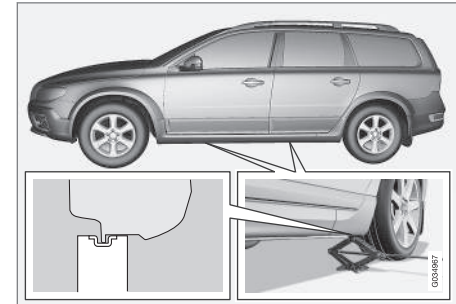

! IMPORTANT

The ground must be firm, smooth and level.

- Lift the car so that the wheel is free. Remove the wheel bolts and lift off the wheel.

* Option/accessory, for more information, see Introduction.



WARNING

Never crawl under the car when it is raised on the jack.

Passengers must leave the car when it is raised on the jack. If a wheel must be changed in a trafficked environment, passengers must stand in a safe place.

NOTE

The normal car jack is only designed for occasional, short-term use, such as when changing a wheel after a puncture, changing to winter/summer wheels, etc. Only the jack for the specific car model may be used to raise the car. If the car is to be jacked up more often, or for a longer time than is required just to change a wheel, use of a garage jack is recommended. In this instance, follow the instructions for use that come with the equipment.

Related information

- Changing wheels - fitting (p. 330)
- Jack* (p. 333)
- Warning triangle (p. 331)
- Wheel bolts (p. 327)

Changing wheels - fitting

It is important that the procedure for fitting the wheel is carried out correctly.

Installation

WARNING

Never crawl under the car when it is raised on the jack.

Passengers must leave the car when it is raised on the jack. If a wheel must be changed in a trafficked environment, passengers must stand in a safe place.

1. Clean the contact surfaces between wheel and hub.
2. Put on the wheel. Tighten the wheel bolts thoroughly.

3. Lower the car so that the wheels cannot rotate.



4. Tighten the wheel bolts crosswise. It is important that the wheel bolts are tightened properly. Tighten to 140 Nm. Check the torque with a torque wrench.
5. Refit the plastic caps on the wheel bolts.
6. Refit any full wheel covers.

NOTE

- After a tyre has been inflated, always refit the dust cap in order to avoid damage to the valve from gravel, dirt, etc.
- Only use plastic dust caps. Metal dust caps can rust and become difficult to unscrew.



NOTE

The wheel cover outlet for the valve must be positioned over the valve on the wheel rim during fitting.

When changing to another tyre dimension

Applies to cars with tyre pressure monitoring³: Contact an authorised Volvo workshop for updating the software at each change of tyre dimension. A software download may be necessary both when changing to larger and smaller dimensions, and also when switching between summer and winter wheels.

Related information

- Changing wheels - removing wheels (p. 328)
- Jack* (p. 333)
- Warning triangle (p. 331)
- Wheel bolts (p. 327)

Warning triangle

The warning triangle is used to warn other road users of a stationary vehicle.

Storage and folding up

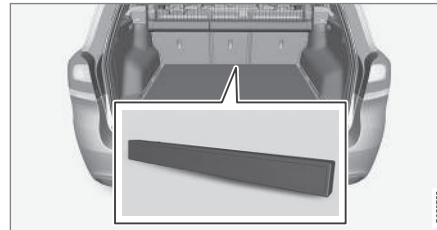
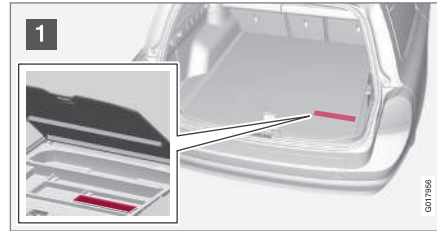

Applies to Bi-Fuel* cars.

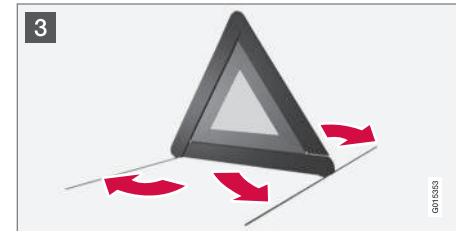
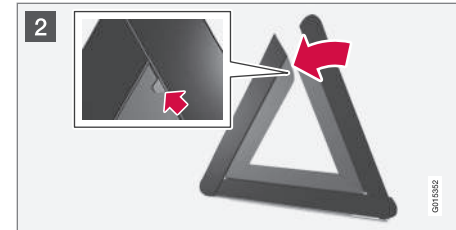

- 1 Lift the floor hatch and take out the warning triangle.
- 2 Take the warning triangle from the case, fold out and assemble the two loose sides.
- 3 Fold out the warning triangle's support legs.

Follow the regulations for the use of a warning triangle. Position the warning triangle in a suitable place with regard to traffic.

³ Standard in certain markets.



09 Wheels and tyres

09

Ensure the warning triangle and its case are properly secured in the cargo area after use.

i NOTE

If the car has been locked with privacy locking then the boot lid/tailgate and floor hatch cannot be opened, see Privacy locking* (p. 175).

Tools

Amongst other things, the car contains towing eye, jack* and wheel wrench*.

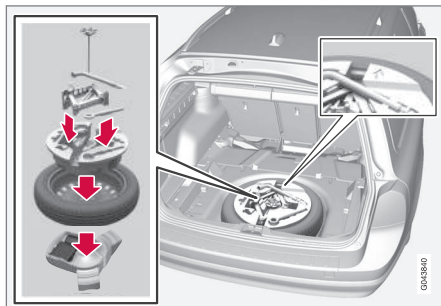

Located under the cargo area floor are the car's towing eye, jack* and wheel wrench*. There is also space here for the sleeve for the locking wheel bolts and tools for the plastic wheel bolt caps.

Applies to Bi-Fuel* cars

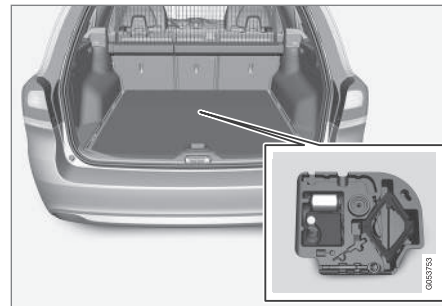

The tools are located in the storage compartment in the cargo area.

1. Fold the backrest of the centre seat forward to access the compartment.
2. Packing instructions: The emergency puncture repair kit's compressor box is slightly wedge-shaped and must be positioned with the wide side facing up.
3. Tension the jack*, if applicable, using the tensioning strap.

Related information

- Emergency puncture repair* (p. 341)
- Towing eye (p. 317)
- Changing wheels - removing wheels (p. 328)
- Wheel bolts (p. 327)
- Jack* (p. 333)



Jack*

A jack is used to raise the car, e.g. when changing the tyres.

The original jack should only be used for changing to the spare wheel. The jack's thread must always be well greased.

i NOTE

The normal car jack is only designed for occasional, short-term use, such as when changing a wheel after a puncture, changing to winter/summer wheels, etc. Only the jack for the specific car model may be used to raise the car. If the car is to be jacked up more often, or for a longer time than is required just to change a wheel, use of a garage jack is recommended. In this instance, follow the instructions for use that come with the equipment.

Tools - returning into place

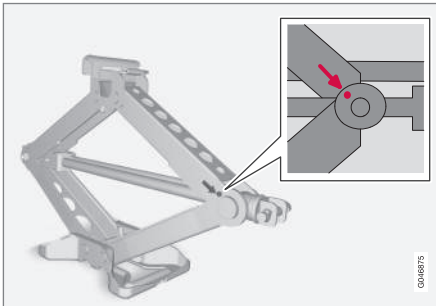

The tools and jack* must be returned to their correct places after use. The jack needs to be cranked together to the correct position in order to have space.

The foam block and spare wheel are replaced in the reverse order to taking out. Note that there is an arrow on the upper foam block. It must point forwards in the car.

! IMPORTANT

The tools and jack* must be stored in the intended location in the car's cargo area when not in use.

i NOTE

If the floor hatch in the cargo area floor is not closed then privacy locking does not work.

Related information

- Warning triangle (p. 331)
- Emergency puncture repair* (p. 341)

First aid kit*

The first aid box contains first aid equipment.

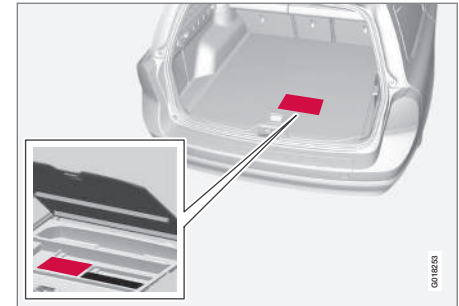

A case with first aid equipment is located under the floor in the cargo area.

i NOTE

If the car has been locked with privacy locking then the boot lid/tailgate and floor hatch cannot be opened, see Privacy locking* (p. 175).



Applies to Bi-Fuel* cars

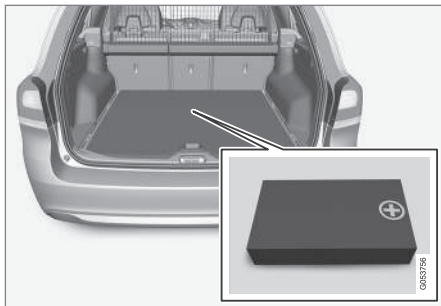

The first-aid kit is located in the storage compartment in the front part of the cargo area.

Tyre pressure monitoring*⁴

Tyre pressure monitoring warns the driver when the pressure is too low in one or more of the car's tyres. For certain markets the tyre pressure monitoring is standard in accordance with legal requirements.

There are two systems for tyre pressure monitoring, TPMS (Tyre Pressure Monitoring System) and TM (Tyre Monitor). In the event of uncertainty about which system the car has, open the menu system **MY CAR** and search for the car's settings:

- The **Tyre pressure** menu is used if it is TPMS, see Tyre pressure monitoring system (TPMS)* - general (p. 335)
- The **Tyre monitoring** menu is used if it is TM, see Tyre pressure monitoring (TM)* (p. 339).

The system does not replace normal tyre maintenance.

Related information

- Tyre pressure monitoring system (TPMS)* - general (p. 335)
- Tyre pressure monitoring (TPMS)* - adjust (recalibration) (p. 336)
- Tyre pressure monitoring (TPMS)* - rectifying low tyre pressure (p. 339)
- Tyre pressure monitoring (TPMS)* - activate/deactivate (p. 337)

- Tyre pressure monitoring (TPMS)* - recommendations (p. 338)
- Tyre pressure monitoring (TPMS)* - drive-able punctured tyres* (p. 338)

⁴ Standard in certain markets.



Tyre pressure monitoring system (TPMS)*¹² - general

Tyre pressure monitoring (TPMS) (Tyre Pressure Monitoring System) warns the driver when the pressure is too low in one or more of the car's tyres.*

Tyre pressure monitoring uses sensors located inside the air valve in each wheel. When the car is driven at about 30 km/h the system detects the tyre pressure. If the pressure is too low then a warning lamp  illuminates in the combined instrument panel and one of the following messages is shown:

- Tyre pressure low Check front right tyre
- Tyre pressure low Check front left tyre
- Tyre pressure low Check rear right tyre
- Tyre pressure low Check rear left tyre
- Tyre needs air now Check front right tyre
- Tyre needs air now Check front left tyre
- Tyre needs air now Check rear right tyre
- Tyre needs air now Check rear left tyre

¹² Standard in certain markets.

• Tyre pressure system Service required

Both factory-fitted and optional wheels can be equipped with TPMS sensors in the valves.

If wheels without TPMS sensors are used or if a sensor has failed then **Tyre pressure system Service required** will be shown.

Always check the system after changing a wheel in order to ensure that replacement wheels work with the system.

For information on the correct tyre pressure, see Tyres - air pressure (p. 323).

The system does not replace normal tyre maintenance.

IMPORTANT

If a fault occurs in the TPMS system the warning lamp  in the combined instrument panel will flash for approx. 1 minute and then illuminate with a constant glow. A message is also shown in the combined instrument panel.

Related information

- Tyre pressure monitoring (TPMS)* - adjust (recalibration) (p. 336)
- Tyre pressure monitoring (TPMS)* - rectifying low tyre pressure (p. 339)

- Tyre pressure monitoring (TPMS)* - activate/deactivate (p. 337)
- Tyre pressure monitoring (TPMS)* - recommendations (p. 338)
- Tyre pressure monitoring (TPMS)* - drive-able punctured tyres* (p. 338)



Tyre pressure monitoring (TPMS)*¹⁹ - adjust (recalibration)

Tyre pressure monitoring (TPMS) (Tyre Pressure Monitoring System) warns the driver when the pressure is too low in one or more of the car's tyres.*

TPMS can be adjusted in order to follow Volvo's tyre pressure recommendations (p. 323), such as when driving with a heavy load, for example.

NOTE

The car must be stationary when calibration is started.

Settings are made using the centre console's controls, see MY CAR (p. 116).

1. Inflate the tyres to the desired pressure in accordance with the tyre pressure label on the driver's side door pillar (between front and rear doors).
2. Start the engine.
3. Select the menu system **MY CAR** to open the menus for tyre pressure.
4. Select **Calibrate tyre pressure** and press **OK**.

¹⁹ Standard in certain markets.

²¹ Standard in certain markets.

5. Drive for at least 10 minutes at a speed of at least 30 km/h.
 - > Calibration is performed automatically following initialisation by the driver. The system provides no confirmation when the calibration is complete.

The new reference values apply until steps 1-5 are carried out again.

Related information

- Tyre pressure monitoring* (p. 334)
- Tyres - air pressure (p. 323)

Tyre pressure monitoring system (TPMS)*²¹ - status

Tyre pressure monitoring (TPMS) (Tyre Pressure Monitoring System) warns the driver when the pressure is too low in one or more of the car's tyres.*

System and tyre status

The current status of the system and the tyres can be checked, see MY CAR (p. 116).

1. Select the menu system **MY CAR** to open the menus for tyre monitoring.
2. Select **Tyre pressure**.

The status is colour-coded for each tyre in accordance with the following:

- All-green: the system is operating normally and the tyre pressure in all tyres is slightly above the recommended level.
- Yellow wheel: corresponding tyre's pressure is too low.
- Red wheel: corresponding tyre's pressure is very low.
- All wheels grey: the system is temporarily unavailable. It may be necessary to drive the car for a few minutes at a speed above 30 km/h before the system becomes active again.
- All wheels grey and the message **Tyre pressure system Service required**: an



error has occurred in the system. Contact a Volvo dealer or workshop.

Clearing warning messages

If a tyre pressure message has been shown and the TPMS warning lamp has been illuminated:

1. Check the tyre pressure on the indicated tyre/tyres with a tyre pressure gauge.
2. Inflate the tyre/tyres to the correct pressure in accordance with the tyre pressure label on the driver's side door pillar (between front and rear doors).
3. In some cases it may be necessary to drive the car for a few minutes at a speed above 30 km/h in order to clear the warning text. At which point, the TPMS warning lamp is extinguished as well.



NOTE

- The TPMS system uses a so-called compensated pressure value, based on both tyre temperature and ambient temperature. This means that the tyre pressure may differ slightly from the recommended pressures listed on the tyre pressure label on the driver's side door pillar (between front and rear doors). For this reason, it may be necessary to inflate the tyres to a slightly higher pressure in order to clear a low tyre pressure message.
- To avoid incorrect tyre pressure, the pressure should be checked on cold tyres. "Cold tyres" means the tyres are the same temperature as the ambient temperature (approx. 3 hours after the car has been driven). After a few kilometres of driving, the tyres warm up and the pressure increases.



WARNING

- Incorrect tyre pressure may lead to tyre failure, which could result in the driver losing control of the car.
- The system cannot indicate sudden tyre damage in advance.

Tyre pressure monitoring (TPMS)*²² - activate/deactivate²³

Tyre pressure monitoring (TPMS) (Tyre Pressure Monitoring System) warns the driver when the pressure is too low in one or more of the car's tyres.*



NOTE

The car must be stationary when the tyre pressure monitoring is activated/deactivated.

Settings are made using the centre console's controls, see MY CAR (p. 116).

1. Start the engine.
2. Select the menu system **MY CAR** to open the menus for tyre pressure.
3. Select **Tyre pressure** and press **OK**.
 - > An **X** is shown in the information display if the system is activated, the option disappears if the system is deactivated.

Related information

- Tyre pressure monitoring* (p. 334)

²² Standard in certain markets.

²³ Only in certain markets.



Tyre pressure monitoring (TPMS)*²⁵ - recommendations

Tyre pressure monitoring (TPMS) (Tyre Pressure Monitoring System)* warns the driver when the pressure is too low in one or more of the car's tyres.

- Volvo recommends that TPMS sensors are fitted to all wheels on the car, including winter wheels.
- Volvo recommends that sensors are not moved between different wheels.
- The spare wheel is not equipped with a TPMS sensor.
- If the spare wheel or a wheel without a TPMS sensor is used, the error message **Tyre pressure system Service required** will be shown in the combined instrument panel.
- If a wheel has been changed, or if the TPMS sensor has been moved to another wheel then the seal, nut and valve core must be replaced.
- When TPMS sensors are installed, the car should be switched off for at least 15 minutes otherwise an error message will be shown in the combined instrument panel.

WARNING

When inflating a tyre equipped with TPMS, hold the nozzle of the pump directly against the valve to avoid damaging the valve.

NOTE

- After a tyre has been inflated, always refit the dust cap in order to avoid damage to the valve from gravel, dirt, etc.
- Only use plastic dust caps. Metal dust caps can rust and become difficult to unscrew.

NOTE

If you want to change the tyre dimension then the TPMS system must be reconfigured. For further information - contact a Volvo dealer.

Related information

- Tyre pressure monitoring* (p. 334)

Tyre pressure monitoring (TPMS)*²⁷ - driveable punctured tyres*

If SST (Self Supporting run flat Tires)* is selected, the car is also equipped with TPMS (p. 334).

This type of tyre has a specially reinforced side wall that makes continued driving possible to a limited extent despite the tyre losing all or some of its pressure. These tyres are fitted on a special rim. (Normal tyres can also be fitted to this rim.)

If an SST tyre loses tyre pressure then the yellow TPMS lamp in the combined instrument panel illuminates and a message is shown in the information display. If this occurs, reduce speed to max. 80 km/h. The tyre must be replaced as soon as possible.

Drive carefully, in some cases it can be difficult to see which tyre is faulty. In order to establish which tyre needs attention, check all four tyres.

²⁵ Standard in certain markets.

²⁷ Standard in certain markets.

**! WARNING**

Only people with knowledge of SST tyres should fit them.

SST tyres must only be fitted together with TPMS.

After an error message about low tyre pressure has been shown, do not drive faster than 80 km/h.

Maximum mileage before tyre replacement is 80 km.

Avoid hard driving such as sudden braking or turning.

SST tyres must be replaced if they are damaged or punctured.

Related information

- Tyre pressure monitoring* (p. 334)

Tyre pressure monitoring (TPMS)*²⁹ - rectifying low tyre pressure

The tyre pressure monitoring system TPMS (Tyre Pressure Monitoring System)³⁰ warns the driver when the pressure is too low in one or more of the car's tyres and indicates the tyre to which it applies.

Yellow is shown at the first indication of low tyre pressure, stop and check the tyre pressure as soon as possible.

Red indicates a much lower pressure than recommended, stop and rectify the tyre pressure immediately.

If a message for low tyre pressure is shown in the display:

1. Check the tyre pressure on the tyre in question.
2. Inflate the tyre(s) to the correct pressure.
3. Drive at least at 30 km/h for several minutes and check that the message disappears.

Related information

- Tyre pressure monitoring* (p. 334)

Tyre pressure monitoring (TM)*³²

The TM (Tyre Monitor) system senses the rotation speed of the tyres in order to determine whether they have the correct tyre pressure. If the pressure is too low, the tyre's diameter is changed and, as a result, so is the rotation speed. By comparing the tyres with each other the system can determine whether one or more tyres have pressure that is too low.

Messages

If the tyre pressure is too low then a warning lamp () illuminates in the combined instrument panel and one of the following messages is shown:

- Tyre pressure low Check front right tyre
- Tyre pressure low Check front left tyre
- Tyre pressure low Check rear right tyre
- Tyre pressure low Check rear left tyre
- Tyre pressure low Check tyres
- Tyre pressure system Service required
- The tyre pressure system is currently not active

²⁹ Standard in certain markets.

³⁰ Option only in certain markets.

³² Standard in certain markets.



IMPORTANT

If a fault occurs in the TM system the warning lamp in the combined instrument panel will flash for approx. 1 minute and then illuminate with a constant glow. A message is also shown in the combined instrument panel.

The system does not replace normal tyre maintenance.

TM calibration

In order for TM to work correctly, a reference value for the tyre pressure must be determined. This must be performed each time the tyres are changed or the tyre pressure is changed.

Recalibration

Settings are made using the centre console's controls, see MY CAR (p. 116).

1. Switch off the ignition.
2. Inflate all tyres to the desired pressure in accordance with the tyre pressure label on the driver's side door pillar (between front and rear doors) and select key position **II**, see Key positions - functions at different levels (p. 81).
3. Select the menu system **MY CAR** to open the menus for tyre monitoring.
4. Select **Calibrate tyre pressure** and press **OK**.

5. Start and drive the car.
 - > Recalibration is carried out while the car is being driven and can be interrupted at any time. If the engine is switched off while recalibration is in progress then it is resumed when the car is driven again. The system provides no confirmation when the calibration is complete.

The new reference value applies until steps 1-5 are repeated.

NOTE

Remember that the TM system must be recalibrated at each tyre change or if the tyre pressure is changed. If new reference values are not stored then the system cannot function properly.

NOTE

- After a tyre has been inflated, always refit the dust cap in order to avoid damage to the valve from gravel, dirt, etc.
- Only use plastic dust caps. Metal dust caps can rust and become difficult to unscrew.

System and tyre status

The current status of the system and the tyres can be checked, see MY CAR (p. 116).

1. Select the menu system **MY CAR** to open the menus for tyre monitoring.
2. Select **Tyre monitoring**.

The status is colour-coded for each tyre in accordance with the following:

- All-green: the system is operating normally and the tyre pressure in all tyres is slightly above the recommended level.
- Yellow wheel: corresponding tyre's pressure is too low.
- All wheels yellow: two or more tyres have pressure that is too low.
- All wheels grey and the message **The tyre pressure system is currently not active**: the tyre pressure system is temporarily deactivated. It may be necessary to drive the car for a short time above 30 km/h before the system becomes active again.
- All wheels grey and the message **Tyre pressure system Service required**: an error has occurred in the system. Contact a Volvo dealer or workshop.

Clearing warning messages

If a tyre pressure message has been shown and the TM warning lamp has been illuminated:



1. Check the tyre pressure in all tyres with a tyre pressure gauge.
2. Inflate the tyre/tyres to the correct pressure in accordance with the tyre pressure label on the driver's side door pillar (between front and rear doors).
3. Recalibrate the TM system.

NOTE

To avoid incorrect tyre pressure, the pressure should be checked on cold tyres. "Cold tyres" means the tyres are the same temperature as the ambient temperature (approx. 3 hours after the car has been driven). After a few kilometres of driving, the tyres warm up and the pressure increases.

WARNING

- Incorrect tyre pressure may lead to tyre failure, which could result in the driver losing control of the car.
- The system cannot indicate sudden tyre damage in advance.

Emergency puncture repair*

The emergency puncture repair kit, Temporary Mobility Kit (TMK), is used to seal a puncture and check and adjust the tyre pressure (p. 430).

The emergency puncture repair kit (p. 343) consists of a compressor and a bottle of sealant. The sealing works as a temporary repair. The sealing fluid bottle must be replaced before its expiration date and after use. The sealing fluid effectively seals tyres punctured in the tread.

NOTE

The emergency puncture repair kit is only intended for sealing tyres with a puncture in the tread.

The emergency puncture repair kit has limited capacity to seal tyres which have punctures in the wall. Do not seal tyres with the emergency puncture repair kit if they have larger slits, cracks or similar damage. Connect the compressor to one of the car's 12 V sockets. Choose the socket that is nearest to the punctured tyre.

IMPORTANT

If the compressor is connected to one of the two 12 V sockets, in the tunnel console, no other current consumer must be connected to the other one.

NOTE

The compressor for temporary emergency puncture repair has been tested and approved by Volvo.

Related information

- Emergency puncture repair* - operation (p. 343)
- Emergency puncture repair* - rechecking (p. 345)
- Emergency puncture repair kit* - overview (p. 343)
- Tools (p. 332)



Emergency puncture repair kit* - location

The emergency puncture repair kit, Temporary Mobility Kit (TMK), is used to seal a puncture and check and adjust the tyre pressure.

Location of the emergency puncture repair kit

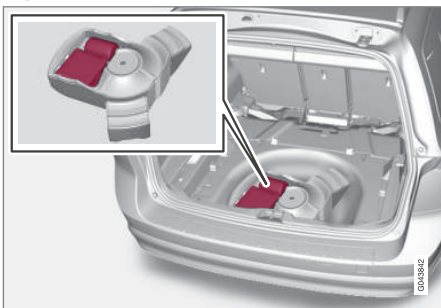

The emergency puncture repair kit is located under the floor in the cargo area.

Applies to Bi-Fuel* cars

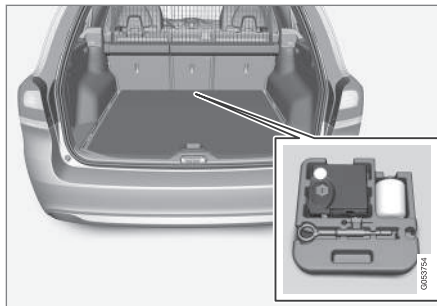

The emergency puncture repair kit is located in the storage compartment in the front part of the cargo area.

i NOTE

The emergency puncture repair kit is only intended for sealing tyres with a puncture in the tread.

! IMPORTANT

If the compressor for emergency puncture repair is connected to one of the two sockets (p. 157) in the tunnel console then no other current consumer may be connected to the other one.

i NOTE

The compressor for temporary emergency puncture repair has been tested and approved by Volvo.

Related information

- Emergency puncture repair kit* - overview (p. 343)
- Emergency puncture repair kit* - sealant (p. 347)
- Emergency puncture repair* (p. 341)



Emergency puncture repair kit* - overview

Overview of the component parts of the emergency puncture repair kit, Temporary Mobility Kit (TMK).

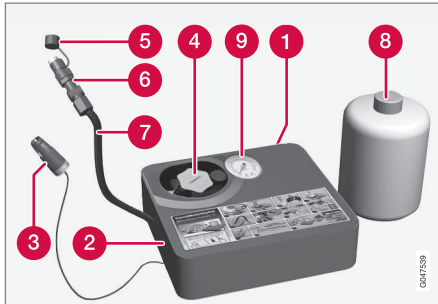

- 1 Label, maximum permitted speed
- 2 Switch
- 3 Cable
- 4 Bottle holder (orange cap)
- 5 Protective cap
- 6 Pressure reducing valve
- 7 Air hose
- 8 Sealing fluid bottle
- 9 Pressure gauge

Related information

- Emergency puncture repair kit* - location (p. 342)
- Emergency puncture repair kit* - sealant (p. 347)
- Emergency puncture repair* (p. 341)

Emergency puncture repair* - operation

Sealing a puncture with the emergency puncture repair kit, Temporary Mobility Kit (TMK).

Emergency puncture repair

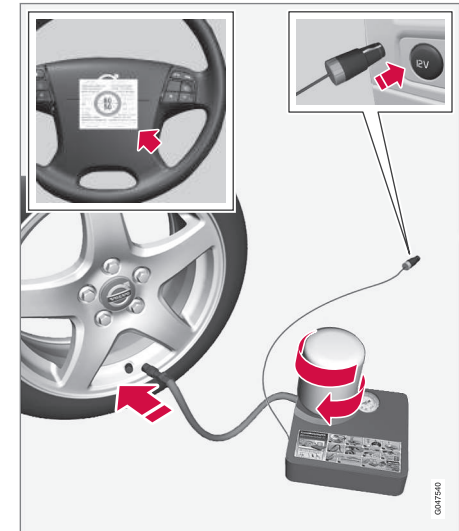

For information on the function of the parts, see Emergency puncture repair kit* - overview (p. 343).



09 Wheels and tyres

09



1. Set up the warning triangle and activate the hazard warning lights if a tyre is being sealed in a trafficked location.

If the puncture was caused by a nail or similar, allow this to remain in the tyre. It helps to seal the hole.

2. Detach the label for maximum permitted speed (which is fitted on one side of the compressor) and affix it to the steering wheel.

WARNING

You should not drive faster than 80 km/h after the emergency tyre repair kit has been used. Volvo recommends that you visit an authorised Volvo workshop for inspection of the sealed tyre (maximum driving distance is 200 km). The staff there can determine whether or not the tyre can be repaired or if it needs to be replaced.

WARNING

The sealing fluid can irritate the skin. In the case of contact with skin, wash away the fluid with soap and water.

3. Check that the switch is in position **0** and locate the cable and the air hose.

NOTE

Do not break the bottle's seal before use. The seal is broken automatically when the bottle is screwed in.

4. Unscrew the orange cap and unscrew the bottle's stopper.
5. Screw the bottle into its holder.

WARNING

Do not unscrew the bottle, it is equipped with a reverse catch to prevent leakage.

6. Connect the hose from the compressor to the valve.
7. Plug the cable into the 12 V socket and start the car.

NOTE

If the compressor is connected to one of the two 12 V sockets in the tunnel console then no other current consumer may be connected to the other one.

WARNING

Do not leave children in the car without supervision when the engine is running.

8. Flick the switch to position **I**.

WARNING

Never stand next to the tyre when the compressor is running. If cracks or unevenness arise then the compressor must be switched off immediately. The journey should not be continued. Contacting an authorised tyre centre is recommended.

NOTE

When the compressor starts, the pressure can increase up to 6 bar but the pressure drops after approximately 30 seconds.

9. Inflate the tyre for 7 minutes.

IMPORTANT

Risk of overheating. The compressor must not run for more than 10 minutes.



- Switch off the compressor to check the pressure on the pressure gauge. Minimum pressure is 1.8 bar and maximum 3.5 bar. (Release air with the pressure reducing valve if the tyre pressure is too high.)

WARNING

If the pressure is below 1.8 bar then the hole in the tyre is too big. The journey should not be continued. Contacting an authorised tyre centre is recommended.

- Switch off the compressor and unplug the cable from the 12 V socket.
- Detach the hose from the tyre valve and fit the valve cap.

- As soon as possible, drive approximately 3 km at a maximum speed of 80 km/h so that the sealing fluid can seal the tyre.

NOTE

Sealant will spurt out of the puncture during the first few rotations of the tyre.

WARNING

Make sure that nobody is standing near the car and gets the sealing fluid splashed onto them when the car is driven away. The distance should be at least two metres.

Related information

- Emergency puncture repair* (p. 341)
- Emergency puncture repair* - rechecking (p. 345)
- Emergency puncture repair kit* - overview (p. 343)

Emergency puncture repair* - rechecking

When a tyre has been sealed with the emergency puncture repair kit, Temporary Mobility Kit (TMK), a subsequent check must be made after approx. 3 kilometres of driving.

Check tyre pressure

- Reconnect the equipment.
- Read the tyre pressure on the pressure gauge.
 - If it is below 1.3 bar³³ then the tyre is insufficiently sealed. The journey should not be continued. Contact a tyre centre.
 - If the tyre pressure is higher than 1.3 bar³³, the tyre must be inflated to the pressure specified in accordance with the tyre pressure table, see Tyres - approved tyre pressures (p. 430). Release air using the pressure reducing valve if the tyre pressure is too high.

³³ 1 bar = 100 kPa.



09 Wheels and tyres

09



WARNING

Do not unscrew the bottle, it is equipped with a reverse catch to prevent leakage.

3. Make sure the compressor is switched off. Detach the air hose and cable.

Fit the valve cap.

NOTE

- After a tyre has been inflated, always refit the dust cap in order to avoid damage to the valve from gravel, dirt, etc.
- Only use plastic dust caps. Metal dust caps can rust and become difficult to unscrew.

NOTE

The sealing fluid bottle and the hose must be replaced after use. Volvo recommends that this replacement is performed by an authorised Volvo workshop.

WARNING

Check the tyre pressure regularly.

Volvo recommends that the car is driven to the nearest authorised Volvo workshop for the replacement/repair of the damaged tyre.

Advise the workshop that the tyre contains sealing fluid.

WARNING

You should not drive faster than 80 km/h after the emergency tyre repair kit has been used. Volvo recommends a visit to an authorised Volvo workshop for inspection of the sealed tyre (maximum driving distance is 200 km). The staff there can determine whether or not the tyre can be repaired or if it needs to be replaced.

Related information

- Emergency puncture repair* (p. 341)
- Emergency puncture repair* - operation (p. 343)
- Emergency puncture repair kit* - overview (p. 343)

Emergency puncture repair kit* - inflating the tyres

The car's original tyres can be inflated using the compressor in the emergency puncture repair kit (p. 343).

1. The compressor must be switched off. Make sure that the switch is in position **0** and locate the cable and air hose.
2. Unscrew the wheel's dust cap and screw in the air hose valve connection to the bottom of the thread on the tyre's air valve.

WARNING

Inhaling car exhaust fumes could result in danger to life. Never leave the engine running in sealed areas or areas that lack sufficient ventilation.

WARNING

Do not leave children in the car without supervision when the engine is running.

3. Connect the cable to one of the car's 12 V sockets and start the car.
4. Start the compressor by flicking the switch to position **I**.

**! IMPORTANT**

Risk of overheating. The compressor must not run for more than 10 minutes.

5. Inflate the tyre to the pressure specified in accordance with the tyre pressure table, see Tyres - approved tyre pressures (p. 430). Release air using the pressure reducing valve if the tyre pressure is too high.
6. Switch off the compressor. Detach the air hose and cable.
7. Refit the dust cap.

Related information

- Emergency puncture repair* (p. 341)
- Emergency puncture repair kit* - overview (p. 343)
- Emergency puncture repair* - rechecking (p. 345)

Emergency puncture repair kit* - sealant

The container (bottle) with the emergency puncture repair kit (p. 343) contains sealant and it can be replaced.

Replace the bottle when the expiration date has passed. Treat the old bottle as environmentally hazardous waste.

! WARNING

The bottle contains 1,2-Ethanol and natural rubber-latex.

Harmful if ingested. Could result in allergic reaction in the event of skin contact.

Avoid contact with the skin and eyes.

Store out of the reach of children.

Related information



- Emergency puncture repair* (p. 341)



Type approval - tyre pressure monitoring (TPMS)

Type approval of the sensors in tyre pressure monitoring - TPMS (Tyre Pressure Monitoring System) can be read in the table.*

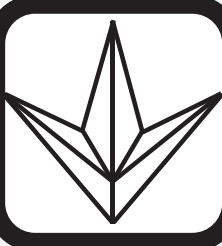

Country/Area	
Brazil	<div data-bbox="557 236 876 446" style="border: 1px solid black; padding: 10px; text-align: center;"><p>Modelo: S180052050</p><p>Agência Nacional de Telecomunicações 1542-12-2149</p><p>(01) 07894476056448</p><div style="border: 1px solid black; padding: 2px; font-size: 8px; margin: 5px auto; width: 80%;"><p>Este equipamento opera em caráter secundário, isto é, não tem direito a proteção contra interferência prejudicial, mesmo de estações do mesmo tipo, e não pode causar interferência a sistemas operando em caráter primário.</p></div></div> <div data-bbox="906 435 919 471" style="text-align: right; font-size: 8px;">000090</div>
Ukraine	<div data-bbox="587 538 842 799" style="border: 2px solid black; border-radius: 15px; padding: 20px; text-align: center;"></div> <div data-bbox="906 766 919 801" style="text-align: right; font-size: 8px;">000091</div>



09 Wheels and tyres

09



Country/Area	
Israel	<div data-bbox="497 184 938 488" style="border: 1px solid black; padding: 10px;"><p data-bbox="587 202 849 225">שם הדגם (Hebrew: Model name)</p><p data-bbox="655 238 780 260">S180052050</p><p data-bbox="507 286 930 309">שם היצרן וכתובתו (Hebrew: Manufacturer and address)</p><p data-bbox="625 331 812 409">Continental AG Siemensstraße 12 93055 Regensburg</p><p data-bbox="906 434 919 468" style="writing-mode: vertical-rl; transform: rotate(180deg);">0051154</p></div>



Declaration of Conformity (Declaration of Conformity)

Country/ Area																					
Countries in the EU:	<div data-bbox="274 240 335 296" style="text-align: center;"> </div> <p data-bbox="274 311 550 338">Exporting country: Germany</p> <p data-bbox="274 349 710 376">Manufacturer: Continental Automotive GmbH</p> <p data-bbox="274 387 571 414">Type of equipment: TPMS unit</p> <div data-bbox="274 425 718 957" style="border: 1px solid black; padding: 10px;"> <div style="text-align: center;"> <p><small>Continental Automotive Group - Fahrzeug-TPMS-System</small></p> </div> <p style="font-size: small;"> Josef Löffler 185 7633 CFHF 1000 Phone: +49 (0)41 750-2542 Fax: +49 (0)41 750-25542 Josef.Loeffler@continental-corporation.com </p> <table border="0" style="width: 100%; font-size: x-small;"> <tr> <td>Issued:</td> <td>For message used:</td> <td>For reference:</td> <td>For reference:</td> </tr> <tr> <td>April 16, 2012</td> <td>TG1C Valve</td> <td></td> <td></td> </tr> </table> <p>Declaration of Conformity in accordance with Directive 1999/5/EC (R&TTE Directive)</p> <p>Manufacturer: Continental Automotive GmbH Address: Siemensstrasse 12 D-10585 Regensburg Germany</p> <p>Product type designation: 816000350 Intended use: Tyre Pressure Monitoring Sensor</p> <p>The product mentioned above complies with the essential requirements and other relevant provisions of Directive 1999/5/EC, when used for its intended purpose.</p> <p>Health and safety pursuant to Art. 3(1)(a): Applied standard(s): EN 60 800-1:2006 + A11:2009 + A2:2010 + A3:2011 EN 62 479-2:2010</p> <p>Electromagnetic compatibility pursuant to Art. 3(1)(b): Applied standard(s): EN 301 489-1 V1.8.1 (2006-04) EN 301 489-3 V1.4.1 (2002-08)</p> <p>Efficient use of spectrum pursuant to Art. 3(2): Applied standard(s): EN 300 220-1 V2.3.1 (2010-02) EN 300 220-2 V2.3.1 (2010-02)</p> <p>The following marking applies to the above-mentioned product:</p> <div style="display: flex; justify-content: space-between; align-items: flex-start;"> <div style="font-size: x-small;"> Continental Automotive GmbH Regensburg, 93120-04-18 Andreas Wolf Executive Vice President Body & Security </div> <div style="font-size: x-small;"> Norbert Müller Cluster Product Group 1 Body & Security </div> <div style="font-size: x-small;"> </div> </div> <div style="font-size: x-small; margin-top: 10px;"> <table border="0"> <tr> <td>Continental Automotive Group</td> <td>Phone: +49 (0) 41 750-2500</td> <td>Registered Office</td> <td>Continental Financial Services</td> </tr> <tr> <td>Head Office</td> <td>Head Office</td> <td>Continental Tyres</td> <td>Continental Tyres</td> </tr> <tr> <td>Head Office</td> <td>Head Office</td> <td>Continental Tyres</td> <td>Continental Tyres</td> </tr> </table> </div> </div>	Issued:	For message used:	For reference:	For reference:	April 16, 2012	TG1C Valve			Continental Automotive Group	Phone: +49 (0) 41 750-2500	Registered Office	Continental Financial Services	Head Office	Head Office	Continental Tyres	Continental Tyres	Head Office	Head Office	Continental Tyres	Continental Tyres
Issued:	For message used:	For reference:	For reference:																		
April 16, 2012	TG1C Valve																				
Continental Automotive Group	Phone: +49 (0) 41 750-2500	Registered Office	Continental Financial Services																		
Head Office	Head Office	Continental Tyres	Continental Tyres																		
Head Office	Head Office	Continental Tyres	Continental Tyres																		

00011943





09 Wheels and tyres



09

Country/ Area	
Czech Republic:	Continental tímto prohlašuje, že tento Radio Transmitter je ve shodě se základními požadavky a dalšími příslušnými ustanoveními směrnice 1999/5/ES.
Denmark:	Undertegnede Continental erklærer herved, at følgende udstyr Radio Transmitter overholder de væsentlige krav og øvrige relevante krav i direktiv 1999/5/EF.
Germany:	Hiermit erklärt Continental, dass sich das Gerät Radio Transmitter in Übereinstimmung mit den grundlegenden Anforderungen und den übrigen einschlägigen Bestimmungen der Richtlinie 1999/5/EG befindet.
Estonia:	Käesolevaga kinnitab Continental seadme Radio Transmitter vastavust direktiivi 1999/5/EÜ põhinõuetele ja nimetatud direktiivist tulenevatele teistele asjakohastele sätetele.
UK	Hereby, Continental declares that this Radio Transmitter is in compliance with the essential requirements and other relevant provisions of Directive 1999/5/EC.
Spain:	Por medio de la presente Continental declara que el Radio Transmitter cumple con los requisitos esenciales y cualesquiera otras disposiciones aplicables o exigibles de la Directiva 1999/5/CE.
Greece:	ΜΕ ΤΗΝ ΠΑΡΟΥΣΑ Continental ΔΗΛΩΝΕΙ ΟΤΙ Radio Transmitter ΣΥΜΜΟΡΦΩΝΕΤΑΙ ΠΡΟΣ ΤΙΣ ΟΥΣΙΩΔΕΙΣ ΑΠΑΙΤΗΣΕΙΣ ΚΑΙ ΤΙΣ ΛΟΙΠΕΣ ΣΧΕΤΙΚΕΣ ΔΙΑΤΑΞΕΙΣ ΤΗΣ ΟΔΗΓΙΑΣ 1999/5/ΕΚ.
France:	Par la présente Continental déclare que l'appareil Radio Transmitter est conforme aux exigences essentielles et aux autres dispositions pertinentes de la directive 1999/5/CE.
Italy:	Con la presente Continental dichiara che questo Radio Transmitter è conforme ai requisiti essenziali ed alle altre disposizioni pertinenti stabilite dalla direttiva 1999/5/CE.
Latvia:	Ar šo Continental deklarē, ka Radio Transmitter atbilst Direktīvas 1999/5/EK būtiskajām prasībām un citiem ar to saistītajiem noteikumiem.
Lithuania:	Šiuo Continental deklaruoja, kad šis Radio Transmitter atitinka esminius reikalavimus ir kitas 1999/5/EB Direktyvos nuostatas.
Netherlands:	Hierbij verklaart Continental dat het toestel Radio Transmitter in overeenstemming is met de essentiële eisen en de andere relevante bepalingen van richtlijn 1999/5/EG.



Country/ Area	
Malta:	Hawnhekk, Continental, jiddikjara li dan Radio Transmitter jikkonforma mal-htigijiet essenzjali u ma provvedimenti oħrajn relevanti li hemm fid-Dirrettiva 1999/5/EC.
Hungary:	Alulírott, Continental nyilatkozom, hogy a Radio Transmitter megfelel a vonatkozó alapvető követelményeknek és az 1999/5/EC irányelv egyéb előírásainak.
Poland:	Niniejszym Continental oświadcza, że Radio Transmitter jest zgodny z zasadniczymi wymogami oraz pozostałymi stosownymi postanowieniami Dyrektywy 1999/5/EC.
Portugal:	Continental declara que este Radio Transmitter está conforme com os requisitos essenciais e outras disposições da Directiva 1999/5/CE.
Slovenia:	Continental izjavlja, da je ta Radio Transmitter v skladu z bistvenimi zahtevami in ostalimi relevantnimi določili direktive 1999/5/ES.
Slovakia:	Continental týmto vyhlasuje, že Radio Transmitter spĺňa základné požiadavky a všetky príslušné ustanovenia Smernice 1999/5/ES.
Finland:	Continental vakuuttaa täten että Radio Transmitter tyyppinen laite on direktiivin 1999/5/EY oleellisten vaatimusten ja sitä koskevien direktiivin muiden ehtojen mukainen.
Sweden:	Härmed intygar Continental att denna Radio Transmitter står i överensstämmelse med de väsentliga egenskapskrav och övriga relevanta bestämmelser som framgår av direktiv 1999/5/EG.
Iceland:	Hér með lýsir Continental yfir því að Radio Transmitter er í samræmi við grunnkröfur og aðrar kröfur, sem gerðar eru í tilskipun 1999/5/EC.
Norway:	Continental erklærer herved at utstyret Radio Transmitter er i samsvar med de grunnleggende krav og øvrige relevante krav i direktiv 1999/5/EF.

Related information

- Tyre pressure monitoring* (p. 334)

10



MAINTENANCE AND SERVICE

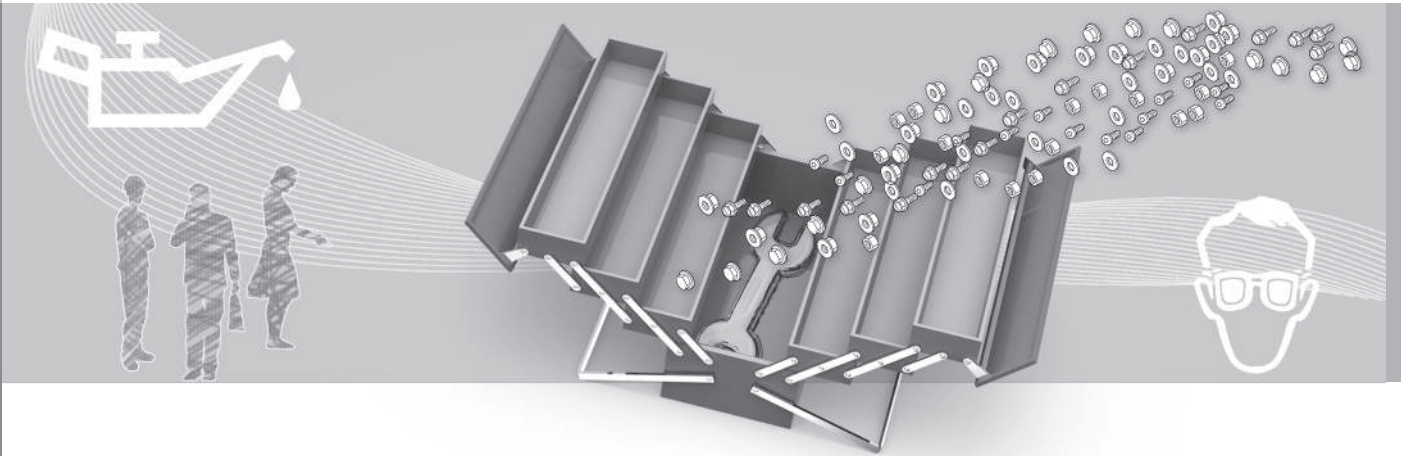



Volvo service programme

To keep the car as safe and reliable as possible, follow the Volvo service programme as specified in the Service and Warranty Booklet.

Volvo recommends engaging an authorised Volvo workshop to perform the service and maintenance work. Volvo workshops have the personnel, special tools and service literature to guarantee the highest quality of service.

IMPORTANT

For the Volvo warranty to apply, check and follow the instructions in the Service and Warranty Booklet.

Related information

- Climate control system - fault tracing and repair (p. 369)

Book service and repair*¹

Manage service, repair and booking information directly in your Internet-connected car.

This service¹ provides a convenient way to book a service and workshop visit directly in the car. Car information is sent to your dealer, who can prepare the workshop visit. The dealer will contact you to schedule an appointment time. For certain markets, the system reminds you of a scheduled appointment time as it approaches and the navigation system² can also guide you to the workshop when the time comes.

Before the service can be used

Volvo ID and my profile

- Register a Volvo ID. For more information and how to create a Volvo ID, see Volvo ID (p. 21).
- Log in to the owner portal My Volvo, go to your profile and carry out the following:
 1. Check that the car is connected to your profile.
 2. Check that your contact information is correct.
 3. Select the Volvo dealer you want to contact for service and repair.

4. Choose preferred communication channel (phone). Booking information is always sent to the car and to you via email.

Prerequisite for booking from car

- To send and receive booking information from and to the car, the car must be connected to the Internet, see the Sensus Infotainment supplement for information about how to connect the car to the Internet.
- Since the booking information is sent over your private phone subscription, you will be asked whether you want to send the information. The question is asked once and then applies to the selected connection for a limited time.
- For the service to work and for the system to communicate via the car's screen, notifications/pop-up messages must be accepted. In the normal view for the **MY CAR** source, press **OK/MENU** and then **Service & repair → Display notifications**.

Using the service

All menus and settings are accessed from the normal view in **MY CAR** by pressing **OK/MENU** and then **Service & repair**.

When it is time for service, and in some cases when the car is in need of repair, this is noti-

¹ Applies to certain markets.

² Applies to Sensus Navigation.



fied in the combined instrument panel (p. 65) and via a pop-up menu in the screen.

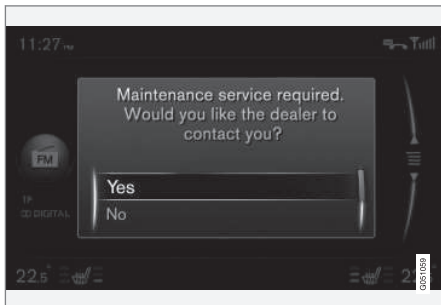

Service message in the screen.

Meaning of the answer options in the screen's pop-up menu:

- **Yes** - A booking enquiry is sent to your dealer who then comes back with a booking proposal. The service lamp and service message in the combined instrument panel are extinguished.
- **No** - No more pop-up messages will be shown in the screen. The message in the combined instrument panel remains. After this option has been selected, it is possible to start the manual booking in the car, see below.
- **Postpone** - The pop-up menu is shown the next time the car is started.

¹ Applies to certain markets.

² Applies to Sensus Navigation.

³ Vehicle Identification Number

Book a service or repair manually¹

1. Press the **MY CAR** button in the centre console and select **Service & repair** → **Dealer information** → **Request service or repair**.
 - > Vehicle data is sent automatically to your dealer.
2. The dealer sends a booking proposal to the car.
3. Accept or request a new booking proposal.

After the booking has been accepted the booking information is stored in the car, see My bookings. The car will automatically communicate with you via the screen by means of reminders about the booking and guide you to the workshop visit.

You can also book a workshop visit via My Volvo. Go to "My bookings" and select "Update" in order to gain access to bookings from My Volvo.

My bookings¹

Show booking information in the car's screen. Accept or request a new booking proposal.

- Select **Service & repair** → **My bookings**.

Call the dealer¹

With a Bluetooth® phone connected to the car, you can call your dealer. For connecting the phone, see the Sensus Infotainment supplement.

- Select **Service & repair** → **Dealer information** → **Call dealer**.

Using the navigation system^{1, 2}

Enter your workshop as destination or waypoint in the navigation system.

- Select **Service & repair** → **Dealer information** → **Set single destination**.
- Select **Service & repair** → **Dealer information** → **Add as waypoint**.

Sending vehicle data¹

Vehicle data are sent to a central Volvo database (not your dealer) from which Volvo dealers can retrieve vehicle information using the car's identification number (VIN³). The number is printed in the car's service and warranty booklet, alternatively inside the windscreen's bottom left-hand corner.

- Select **Service & repair** → **Send car data**.



Booking information and vehicle data

When you decide to book a service from your car, the booking information and vehicle data will be sent. Vehicle data information consists of information within the following areas:

- service requirement
- function status
- fluid levels
- Meter reading
- the car's vehicle identification number (VIN³)
- The car's software version.

Related information

- Volvo ID (p. 21)

Inspection and service of the system for vehicle gas*⁴

The system for vehicle gas must be inspected regularly by an authorised workshop - an authorised Volvo workshop is recommended.

WARNING

The gas is compressed to high pressure. This system must only be serviced and repaired by an authorised workshop.

Never attempt to disassemble or adjust the gas system or its component parts yourself- risk of serious personal injury.

³ Vehicle Identification Number

⁴ Applies to the Bi-Fuel model variant.



Raising the car

When raising the car it is important that the jack or lifting arms are fitted in the intended points on the car's underbody.



NOTE

Volvo recommends only using the jack that belongs to the car model in question. If a jack is selected other than the one recommended by Volvo, follow the instructions supplied with the equipment.

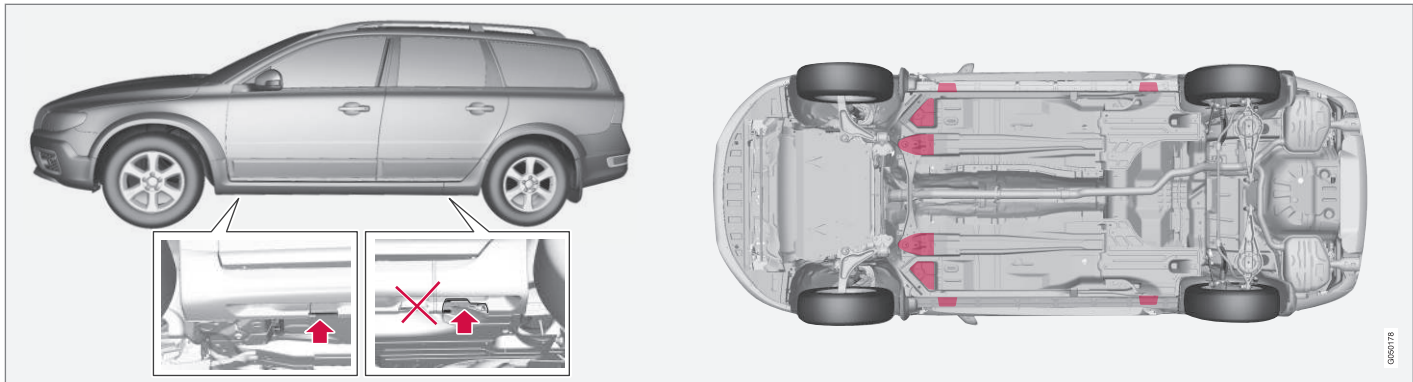

Jacking points (arrows) for the jack that belongs to the car and lifting points (marked in red).

If the car is raised with a front workshop jack then this must be positioned under one of the four lifting points furthest in under the car. If the car is raised with a rear workshop jack then it must be positioned under one of the lifting points. Ensure that the workshop jack is positioned so that the car cannot slide off the jack. Always use axle stands or similar.

If the car is raised with a two-pillar workshop lift then the front and rear lifting arms can be positioned under the outer lifting points (jacking points). Alternatively, the inner lifting points can be used at the front.

Related information

- Changing wheels - removing wheels (p. 328)



Bonnet - opening and closing

The bonnet can be opened when the handle by the pedals has been pulled backward and the lock by the radiator grille has been moved to the left.



- 1 Pull the handle by the pedals. You will hear when the catch releases.
- 2 Move the catch to the left and open the bonnet. (The catch hook is located between the headlamp and radiator grille, see illustration.)

WARNING

Check that the bonnet locks properly when closed.

Related information

- Engine compartment - checking (p. 361)
- Engine compartment - overview (p. 360)

Engine compartment - overview

The overview shows some service-related components.

Engine compartment 4-cyl.

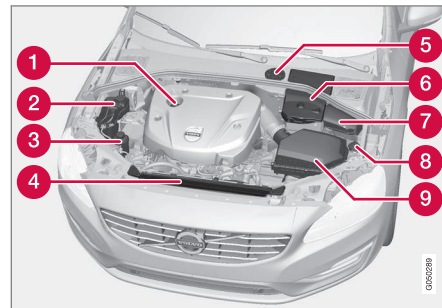

The appearance of the engine compartment may differ depending on engine variant.

- 1 Filling engine oil
- 2 Coolant expansion tank
- 3 Power steering fluid reservoir
- 4 Radiator
- 5 Reservoir for brake and clutch fluid (located on the driver's side)
- 6 Starter battery
- 7 Relay and fuse box
- 8 Filling washer fluid
- 9 Air filter



! WARNING

The ignition system has very high voltage and output. The voltage in the ignition system is highly dangerous. The car's electrical system must always be in key position **0** when work is being performed in the engine compartment; see Key positions - functions at different levels (p. 81).

Do not touch the spark plugs or ignition coil when the car's electrical system is in key position **II** or when the engine is hot.

Engine compartment except 4-cyl.

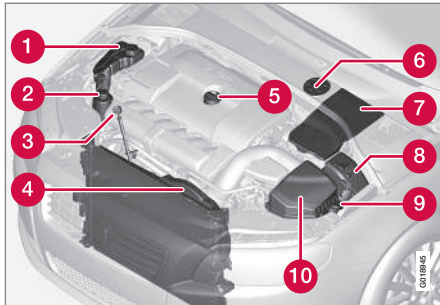

The appearance of the engine compartment may differ depending on engine variant.

- 1 Coolant expansion tank
- 2 Power steering fluid reservoir
- 3 Engine oil dipstick⁵

- 4 Radiator
- 5 Filling engine oil
- 6 Reservoir for brake and clutch fluid (located on the driver's side)
- 7 Starter battery
- 8 Relay and fuse box
- 9 Filling washer fluid
- 10 Air filter

! WARNING

The ignition system has very high voltage and output. The voltage in the ignition system is highly dangerous. The car's electrical system must always be in key position **0** when work is being performed in the engine compartment; see Key positions - functions at different levels (p. 81).

Do not touch the spark plugs or ignition coil when the car's electrical system is in key position **II** or when the engine is hot.

Related information

- Bonnet - opening and closing (p. 360)
- Engine compartment - checking (p. 361)

Engine compartment - checking

Some oils and fluids should be checked at regular intervals.

Regular checking

Check the following oils and fluids at regular intervals, e.g. when refuelling:

- Coolant
- Engine oil
- Power steering fluid
- Washer fluid

! WARNING

Remember that the radiator fan (located at the front of the engine compartment, behind the radiator) may start automatically some after the engine has been switched off.

Always have the engine cleaned by a workshop - an authorised Volvo workshop is recommended. There is a risk of fire if the engine is hot.

Related information

- Bonnet - opening and closing (p. 360)
- Engine compartment - overview (p. 360)
- Coolant - level (p. 366)
- Engine oil - checking and filling (p. 363)
- Power steering fluid - level (p. 368)
- Washer fluid - filling (p. 377)

⁵ Engines with electronic oil level sensor do not have a dipstick (5-cyl. diesel).



Engine oil - general

An approved engine oil must be used in order that the recommended service intervals can be applied.

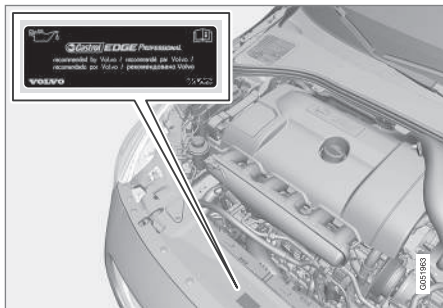

Volvo recommends:



When driving under adverse conditions, see Engine oil - adverse driving conditions (p. 416).

! IMPORTANT

In order to fulfil the requirements for the engine's service intervals all engines are filled with a specially adapted synthetic engine oil at the factory. The choice of oil has been made very carefully with regard to service life, starting characteristics, fuel consumption and environmental impact.

An approved engine oil must be used in order that the recommended service intervals can be applied. Only use a prescribed grade of oil for both filling and oil change, otherwise you will risk affecting service life, starting characteristics, fuel consumption and environmental impact.

Volvo Car Corporation disclaims all warranty liability if engine oil of the prescribed grade and viscosity is not used.

Volvo recommends that oil changes are carried out at an authorised Volvo workshop.

Volvo uses different systems for warning of low/high oil level or low oil pressure. Certain engine variants have an oil pressure sensor, and then the combined instrument panel's warning symbol for low oil pressure is used. Other variants have an oil level sensor, when the driver is informed via the instrument's warning symbol  and display texts. Cer-

tain variants have both systems. Contact a Volvo dealer for more information.

Change the engine oil and oil filter in accordance with the intervals specified in the Service and Warranty Booklet.

Using oil of a higher than specified grade is permitted. If the car is driven in adverse conditions, Volvo recommends using an oil of a higher grade; see Engine oil - adverse driving conditions (p. 416).

For filling capacities, see Engine oil - grade and volume (p. 417).

Related information

- Engine oil - checking and filling (p. 363)



Engine oil - checking and filling

The oil level is detected on certain engine variants with the electronic oil level sensor, on other engine variants it is checked with the oil dipstick.

Engine with oil dipstick⁶

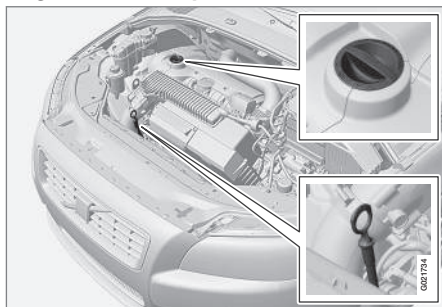

Dipstick and filler pipe.

Checking the oil level in a new car is especially important before the first scheduled oil change.

Volvo recommends checking the oil level every 2 500 km. The most accurate measurements are made on a cold engine before starting. The measurement will be inaccurate if taken immediately after the engine is switched off. The dipstick will indicate that

the level is too low because the oil has not had time to flow down into the oil sump.

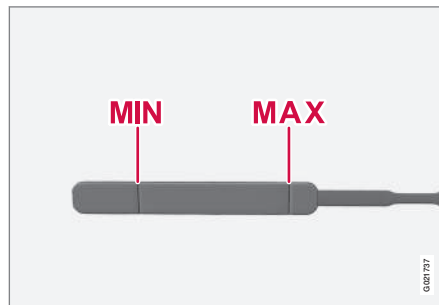

The oil level must be between the **MIN** and **MAX** marks.

Measurement and filling if required

1. Ensure that the car is level. After switching off the engine it is important to wait 5 minutes to allow the oil time to run back to the sump.
2. Pull up and wipe the dipstick.
3. Re-insert the dipstick.
4. Pull it out and check the level.
5. If the level is close to **MIN** then 0.5 litres should be added. If the level is significantly below, then an additional amount is required.

6. If required, check the level again, do it after driving a short distance. Then repeat steps 1 - 4.

! WARNING

Never fill above the **MAX** mark. The level should never be above **MAX** or below **MIN** as this could lead to engine damage.

! WARNING

Do not spill oil onto the hot exhaust manifold due to the risk of fire.

Engine with electronic oil level sensor, 4-cyl.

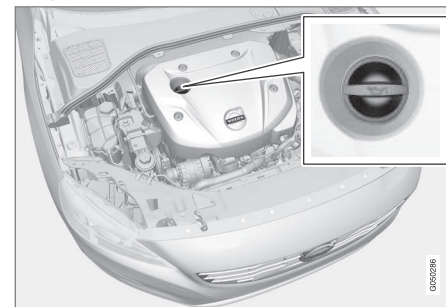

Filler pipe⁷.

⁶ Does not apply to 4-cyl. engine or 5-cyl. diesel engine, which have electronic oil level sensor.

⁷ Engines with electronic oil level sensor do not have a dipstick.



10 Maintenance and service



In some cases, oil may need to be topped up between service intervals.

No action needs to be taken on engine oil level until a message is shown in the combined instrument panel's display, see the following illustration.

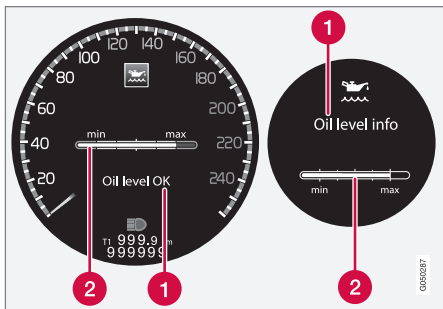

Message and graphic in the display. The left-hand display is shown in the digital combined instrument panel and the right-hand in the analogue.

- 1 Message
- 2 Engine oil level

The oil level is checked using the electronic oil level gauge with the thumbwheel when the engine is switched off, see Menu navigation - combined instrument panel (p. 113).

WARNING

If the message **Oil service required** is shown, visit a workshop - an authorised Volvo workshop is recommended. The oil level may be too high.

IMPORTANT

If notified of low oil level, only fill with the volume specified, for example, 0.5 litres.

NOTE

The system cannot directly detect changes when the oil is filled or drained. The car must have been driven approx. 30 km and have been stationary for 5 minutes with the engine switched off and on level ground before the oil level indication is correct.

WARNING

Do not spill oil onto the hot exhaust manifold due to the risk of fire.

Measuring the oil level, 4-cyl.

If the oil level needs to be checked then it should be carried out in accordance with the following sequence.

1. Activate key position **II**; see Key positions - functions at different levels (p. 81).

2. Rotate the thumbwheel on the left-hand stalk switch to position **Oil level**.
 - > You will then see information displayed about the engine oil level.

For more information on menu navigation, see Menu navigation - combined instrument panel (p. 113).

NOTE

If the right conditions for measuring the oil level are not met (time after engine shut-down, the car's inclination, outside temperature, etc.) then the message **Not available** will be shown. This does **not** mean that there is something wrong in the car's systems.



Engine with electronic oil level sensor, 5-cyl. diesel

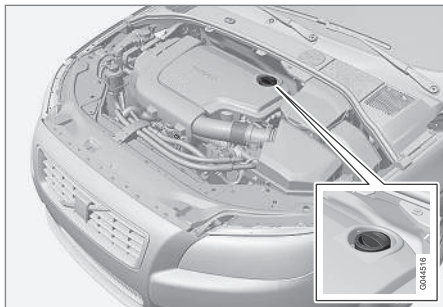

Filler pipe⁸.

No action needs to be taken on engine oil level until a message is shown in the combined instrument panel's display, see the following illustration.

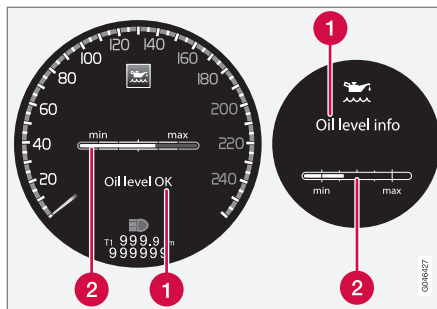

Message and graphic in the display. The left-hand display is shown in the digital combined instrument panel and the right-hand in the analogue.

- 1 Message
- 2 Engine oil level

The oil level is checked using the electronic oil level gauge with the thumbwheel when the engine is switched off, see Menu navigation - combined instrument panel (p. 113).

WARNING

If the message **Oil service required** is shown, visit a workshop - an authorised Volvo workshop is recommended. The oil level may be too high.

IMPORTANT

In the event of the message **Oil level low** Refill 0.5 litre, only fill with 0.5 litres.

NOTE

The oil level is only detected by the system during driving. The system cannot directly detect changes when the oil is filled or drained. The car must be driven about 30 km before the oil level display is correct.

WARNING

Do not fill more oil if filling level (3) or (4) appears as shown in the illustration below. The level must never be above **MAX** or below **MIN**, as this could lead to engine damage.

WARNING

Do not spill oil onto the hot exhaust manifold due to the risk of fire.

⁸ Engines with electronic oil level sensor do not have a dipstick.



Measuring the oil level, 5-cyl. diesel

If the oil level needs to be checked then it should be carried out in accordance with the following sequence.

1. Activate key position **II**; see Key positions - functions at different levels (p. 81).
2. Rotate the thumbwheel on the left-hand stalk switch to position **Oil level**.
 - > You will then see information displayed about the engine oil level.

For more information on menu navigation, see Menu navigation - combined instrument panel (p. 113).

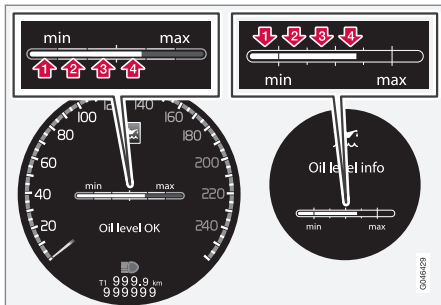

The figures 1-4 represent filling level. Do not fill more oil if filling level (3) or (4) is shown. Recommended filling level is 4. Message and graphic in the display. The left-hand display is shown in the digital combined instrument panel and the right-hand in the analogue.

Related information

- Engine oil - general (p. 362)

Coolant - level

The coolant cools the internal combustion engine to the correct operating temperature. The heat that is transferred from the engine to the coolant can be used to heat the passenger compartment.

The coolant level must lie between the **MIN** and **MAX** marks on the expansion tank.

Checking the level and topping up

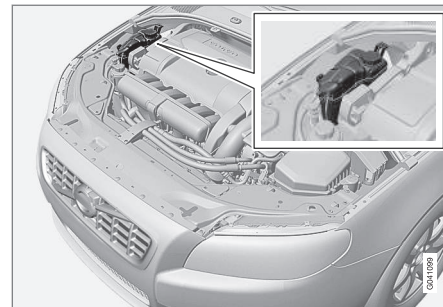

When topping up the coolant, follow the instructions on the packaging. Never top up with water only. The risk of freezing increases with both too little and too much coolant concentrate.

**! WARNING**

Coolant can be very hot. If the coolant requires topping up when the engine is at operating temperature, unscrew the expansion tank cap slowly to gently release the overpressure.

For capacities and for standards regarding water quality; see Coolant - grade and volume (p. 419).

Check the coolant regularly

The level must be between the **MIN** and **MAX** marks on the expansion tank. If the system is not filled sufficiently, high temperatures could occur, causing a risk of damage to the engine.

! IMPORTANT

- A high content of chlorine, chlorides and other salts may cause corrosion in the cooling system.
- Always use coolant with anti-corrosion agent as recommended by Volvo.
- Ensure that the coolant mixture is 50% water and 50% coolant.
- Mix the coolant with approved quality tap water. In the event of any doubt about water quality, used ready-mixed coolant in accordance with Volvo recommendations.
- When changing coolant/replacing cooling system components, flush the cooling system clean with approved quality tap water or flush with ready-mixed coolant.
- The engine must only be run with a well-filled cooling system. Otherwise, temperatures that are too high may occur resulting in the risk of damage (cracks) in the cylinder head.

Brake and clutch fluid - level

*Brake and clutch fluid level should be between the reservoir **MIN** and **MAX** marks.*

Checking the level

Brake and clutch fluid have a common reservoir. The level must be between the **MIN** and **MAX** marks that are visible inside the reservoir. Check the level regularly.

Change the brake fluid every other year or at every other regular service.

The fluid should be changed annually on cars driven in conditions requiring hard, frequent braking, such as driving in mountains or tropical climates with high humidity.

For capacities and recommended brake fluid grade, see Brake fluid - grade and volume (p. 422).

! WARNING

If the brake fluid is under the **MIN** level in the brake fluid reservoir, do not drive further before topping up the brake fluid. Volvo recommends that the reason for the loss of brake fluid is investigated by an authorised Volvo workshop.



Filling

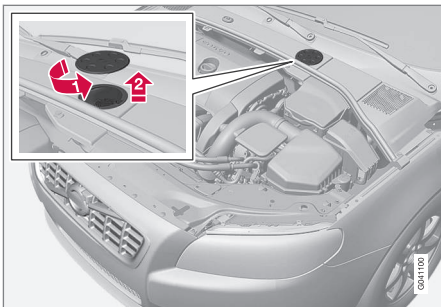

The fluid reservoir is located on the driver's side.

The fluid reservoir is protected under the cover over the cold zone in the engine compartment. The round cover must be removed first before the reservoir cap can be reached.

- 1 Turn and open the cover located on the covering.
- 2 Unscrew the reservoir cap and fill the fluid. The level must be between the **MIN** and **MAX** marks, which are located on the inside of the reservoir.

IMPORTANT

Do not forget to refit the cap.

Power steering fluid - level

The power steering fluid level must be between the reservoir's **MIN** and **MAX** marks. The fluid does not need to be changed.

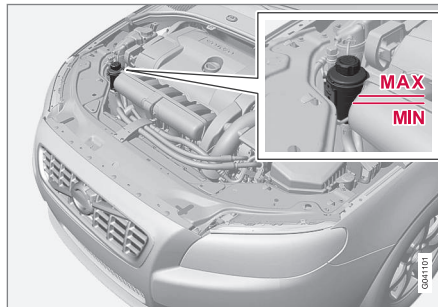

IMPORTANT

Keep the area around the power steering fluid reservoir clean when checking. The cover must not be opened.

Check the level frequently. The fluid does not require changing. The level must be between the **MIN** and **MAX** marks.

For recommended fluid grade, see Power steering fluid - grade (p. 422).



NOTE

If a fault should arise in the power steering system, or if the engine is switched off and must be towed, then the car can still be steered.



Climate control system - fault tracing and repair

The air conditioning system must only be serviced and repaired by an authorised workshop.

Fault tracing and repair

The air conditioning system contains fluorescent tracing agents. Use ultraviolet light when looking for leaks.

Volvo recommends that you contact an authorised Volvo workshop.

WARNING

The air conditioning system contains pressurised refrigerant R134a. This system must only be serviced and repaired by an authorised workshop.

Related information

- Volvo service programme (p. 355)

Lamp replacement - general

Lamp replacement can be carried out for bulbs. When replacing LED and Xenon lamps, please refer to a workshop.

The bulbs are specified (p. 375). The following list contains locations of bulbs and other light sources that are specialised, such as LED⁹ lamps, or are unsuitable for changing for some other reason, except at a workshop¹⁰:

- Active Xenon headlamps - ABL (Xenon lamps)
- Position/parking lamps front
- Daytime running lights
- Side direction indicators, door mirrors on the V70
- Approach lighting, door mirrors
- Interior lighting
- Position/parking lamps rear
- Side marker lamps rear
- Brake light
- Reversing lamp
- Rear fog lamp.

WARNING

On cars with Xenon headlamps, the replacement of Xenon lamps must be carried out at a workshop - an authorised Volvo workshop is recommended. Working with Xenon lamps demands extreme caution because the headlamp is equipped with a high voltage unit.

WARNING

The car's electrical system must be in key position **0** for bulb replacement; see Key positions - functions at different levels (p. 81).

IMPORTANT

Never touch the glass part of the bulbs with your fingers. Grease from your fingers is vaporised by the heat, coating the reflector and then causing damage.

NOTE

If an error message remains after the broken bulb has been replaced then we recommend that you visit an authorised Volvo workshop.

⁹ LED (Light Emitting Diode)

¹⁰ An authorised Volvo workshop is recommended.



NOTE

Outside lighting such as headlamps, fog lamps and rear lamps may temporarily have condensation on the inside of the lens. This is normal, all exterior lighting is designed to withstand this. Condensation is normally vented out of the lamp housing when the lamp has been switched on for a time.

Related information

- Lamp replacement - headlamps (p. 370)
- Lamp replacement - location of rear lamps (p. 373)
- Lamp replacement - vanity mirror lighting (p. 374)
- Lamp replacement - lighting in cargo area (p. 374)
- Lamp replacement - number plate lighting (p. 373)

Lamp replacement - headlamps

All of the headlamp bulbs are replaced via the engine compartment. First loosen and remove the whole headlamp.

Removing the headlamp

Set the car's electrical system in key position **0**, see Key positions - functions at different levels (p. 81).

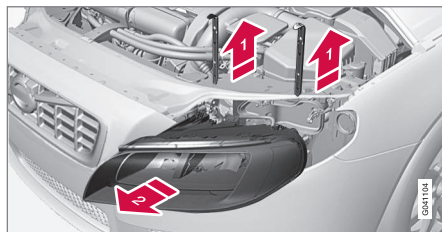

- Pull out the headlamp's locking pins.
- Pull the headlamp straight forward.

IMPORTANT

Do not pull the electrical cable, only the connector.

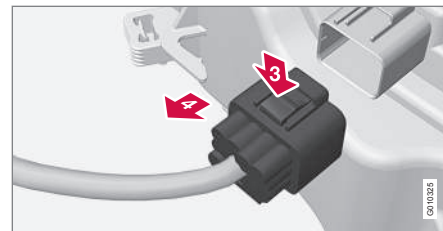

- Detach the headlamp connector by pressing down the clip with your thumb.
- At the same time, guide out the connector with your other hand.
5. Lift out the headlamp and place it on a soft surface to avoid scratching the lens.
6. Replace the bulb in question.

Securing the headlamp

1. Plug in the connector, a clicking sound should be heard.
2. Reinstall the headlamp and locking pins. Check that they are firmly inserted.
3. Check the lighting.

The headlamp must be mounted and the connector firmly connected before the lighting is switched on or the remote control key is inserted into the ignition switch.



Related information

- Lamp replacement - general (p. 369)
- Lamp replacement - cover for main/dipped beam bulbs (p. 371)
- Lamps - specifications (p. 375)

Lamp replacement - cover for main/dipped beam bulbs

Main/dipped beam bulbs are accessed by releasing the headlamp's larger cover.

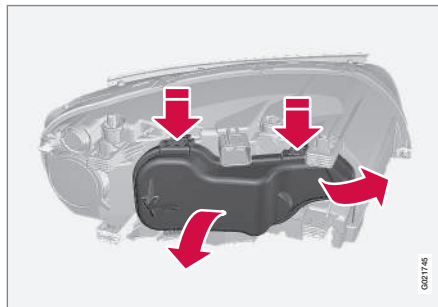

Before starting to replace a bulb, see Lamp replacement - headlamps (p. 370).

1. Open the lock clamp by pressing up/out.
2. Press down the clips on the cover and remove it.

Reinstall the cover in reverse order.

Related information

- Lamp replacement - headlamps (p. 370)
- Lamp replacement - dipped beam (p. 371)
- Lamp replacement - main beam (p. 372)
- Lamp replacement - extra main beam (p. 372)

Lamp replacement - dipped beam

The dipped beam bulb is fitted inside the headlamp's larger cover.

i NOTE

Applies to cars with halogen headlamps.

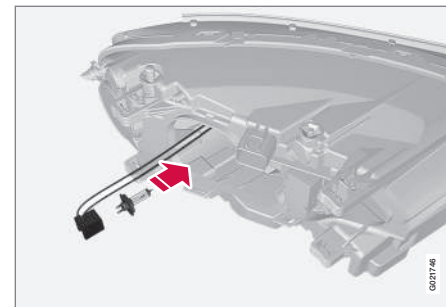

1. Detach the headlamp (p. 370).
2. Remove the cover (p. 371).
3. Unplug the connector from the bulb.
4. Detach the bulb by pressing the holder downwards.
5. Fit the new bulb in the socket and snap it in. It can only be secured in one position.

Reinstall the parts in reverse order.

Related information

- Lamps - specifications (p. 375)



Lamp replacement - main beam

The main beam bulb is fitted inside the headlamp's larger cover.

i NOTE

Applies to cars with halogen headlamps.

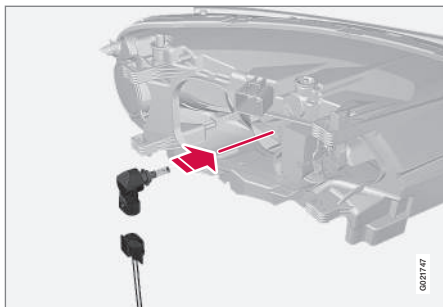

1. Detach the headlamp (p. 370).
2. Remove the cover (p. 371).
3. Detach the bulb by turning anticlockwise and then pulling straight out.
4. Unplug the connector from the bulb.
5. Replace the bulb and align it in the socket and turn clockwise in order to secure it. It can only be secured in one position.

Reinstall the parts in reverse order.

Related information

- Lamps - specifications (p. 375)

Lamp replacement - extra main beam

The extra main beam bulb is fitted inside the headlamp's larger cover.

i NOTE

Applies to cars with Xenon headlamps*.

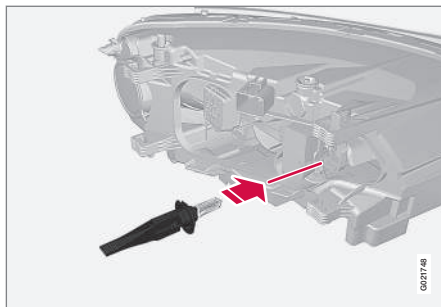

1. Detach the headlamp (p. 370).
2. Remove the cover (p. 371).
3. Detach the bulb by pressing the holder downwards.
4. Unplug the connector from the bulb.
5. Fit the new bulb in the socket and snap it in. It can only be secured in one position.

Reinstall the parts in reverse order.

Related information

- Lamps - specifications (p. 375)

Lamp replacement - direction indicators front

The direction indicator lamp is fitted inside the headlamp's smaller cover.

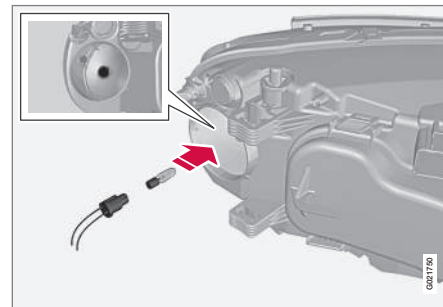

1. Detach the headlamp (p. 370).
2. Remove the small round cover.
3. Pull the bulb holder in order to extract the bulb.
4. Remove the blown bulb and fit a new one. It can only be installed in one way.
5. Fit the bulb holder in the socket and press until a clicking sound is heard.
6. Refit the cover. It must be fitted and pressed in until a clicking sound is heard.

Reinstall the parts in reverse order.

Related information

- Lamps - specifications (p. 375)



Lamp replacement - rear lamp

Rear direction indicators are replaced from inside the cargo area.

Lamp housing, rear

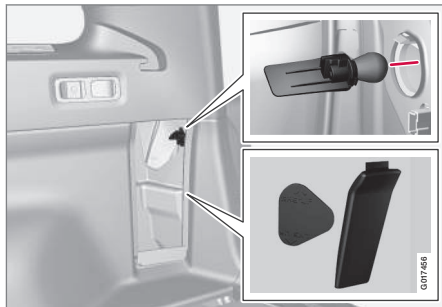

The direction indicator bulb in the rear lamp cluster is replaced from inside the cargo area.

1. Open the panel.
2. Remove the insulation by pulling it straight out.
3. Loosen the bulb holder by turning its handle anticlockwise.
4. Detach the bulb by pulling it straight out.

Related information

- Lamp replacement - location of rear lamps (p. 373)
- Lamps - specifications (p. 375)

Lamp replacement - location of rear lamps

The overview shows the location of the lamps at the rear.

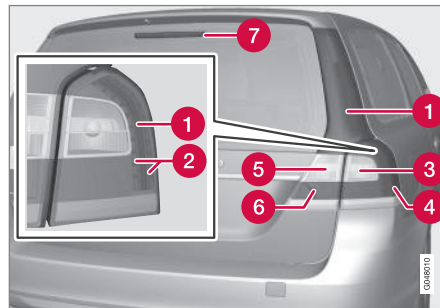

- 1 Position/parking lights (LED)
- 2 Brake light (LED)
- 3 Indicator (p. 373)
- 4 Side marker lamps (LED)
- 5 Reversing lamp (p. 373)
- 6 Fog lamp (p. 373)
- 7 Brake light (LED)

Related information

- Lamp replacement - general (p. 369)
- Lamps - specifications (p. 375)

Lamp replacement - number plate lighting

The number plate lighting is located under the tailgate handle.



1. Remove the screws with a screwdriver.
2. Carefully detach the whole lamp housing and withdraw it.
3. Replace the bulb.
4. Refit the whole lamp housing and screw it into place.

Related information

- Lamps - specifications (p. 375)



Lamp replacement - lighting in cargo area

The cargo area lighting is located in the tail-gate.

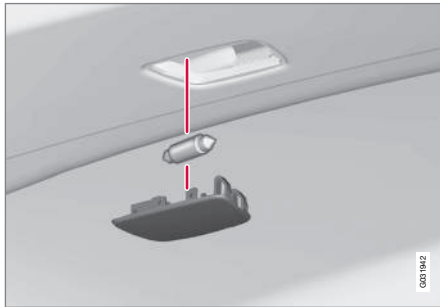

1. Insert a screwdriver and gently prize so that the lamp housing comes loose.
2. Replace the bulb.
3. Check that the bulb illuminates and press back the lamp housing.

Related information

- Lamps - specifications (p. 375)

Lamp replacement - vanity mirror lighting

The vanity mirror's lamps are fitted inside the lamp lenses.

Removal of lamp lens

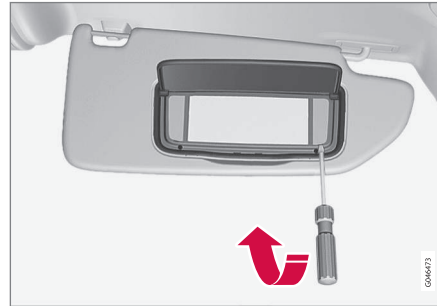

1. Insert a screwdriver under the lamp lens and gently prize up the lock lugs on the edge.
2. Snap off the lamp lens.
3. Use needle-nose pliers to pull the bulb straight out to the side and replace with a new one. Note! - Do not pinch hard with the pliers. Otherwise the lamp lens could then be crushed.

Attaching the lamp lens

1. Refit the lamp lens.
2. Press it into place.

Related information

- Lamps - specifications (p. 375)



Lamps - specifications

The specifications apply to bulbs. When replacing LED and Xenon lamps, please refer to a workshop.

Lighting	W ^A	Type
Dipped beam, halogen	55	H7 LL
Main beam, Halogen	65	H9
Extra main beam, ABL	55	H7 LL
Front direction indicators	21	H21W LL
Side direction indicators, door mirrors ^B	5	WY5W LL
Glovebox lighting	5	Socket SV8.5 Length 43 mm
Vanity mirror lighting	2	T5 Socket W2x4.6d
Cargo area lighting	10	Socket SV8.5 Length 43 mm

Lighting	W ^A	Type
Number plate lighting	5	C5W LL
Direction indicators, rear	21	PY21W SV

^A Watt

^B Replacement of bulbs only on the XC70. The V70 is equipped with LED lamps.

Related information

- Lamp replacement - general (p. 369)

Wiper blades

The wiper blades sweep water away from the windscreen and rear window. Together with the washer fluid they clean the windows and ensure visibility for driving.

The windscreen wiper blades must be in service position when they are to be replaced.

Service position



Wiper blades in service position.

In order to change, clean or lift the wiper blades (for scraping off ice from the windscreen, for example) they must be in service position.



IMPORTANT

Before placing the wiper blades in the service position, make sure that they are not frozen down.



10 Maintenance and service



1. Insert the remote control key in the ignition switch¹¹ and briefly press the **START/STOP ENGINE** button to set the car's electrical system to key position **I**. For detailed information on key positions, see Key positions - functions at different levels (p. 81).
2. Briefly press the **START/STOP ENGINE** button again to set the car's electrical system in key position **0**.
3. Within 3 seconds, move the right stalk switch up and hold it in position for approx. 1 second.
 - > The wipers then move to standing straight up.

The wipers return to their starting position when you briefly press the **START/STOP ENGINE** button to set the car's electrical system to key position **I** (or when the car is started).

! IMPORTANT

If the wiper arms in service position have been folded up from the windscreen, they must be folded back down onto the windscreen before the wipers are allowed to return to their starting position. This is to avoid scraping the paint on the bonnet.

Replacing the wiper blades

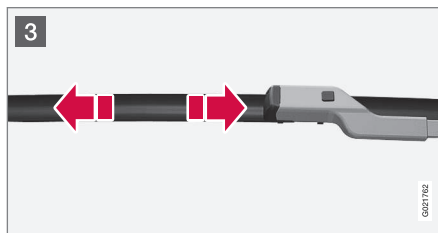
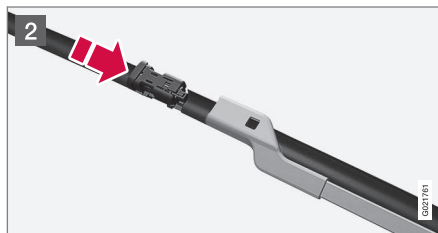
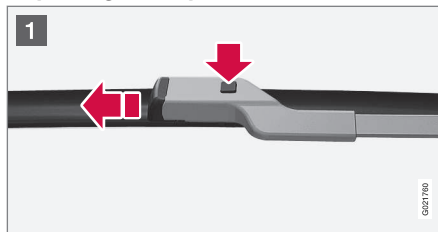

- 1 Fold up the wiper arm when it is in service position. Press the button located on the wiper blade mounting and pull straight out parallel with the wiper arm.
- 2 Slide in the new wiper blade until a "click" is heard.
- 3 Check that the blade is firmly installed.
4. Fold the wiper arm back towards the windscreen.

The wipers return from service position to their starting position when you briefly press the **START/STOP ENGINE** button to set the car's electrical system to key position **I** (or when the car is started).

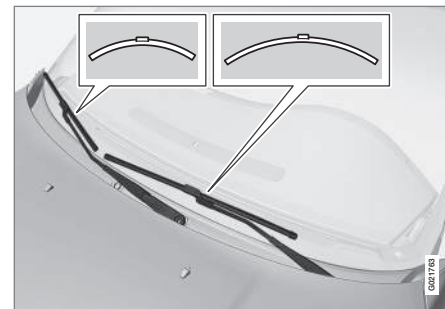

¹¹ Not necessary in cars with the Keyless function.

**i NOTE**

The wiper blades are different lengths. The blade on the driver's side is longer than on the passenger side.

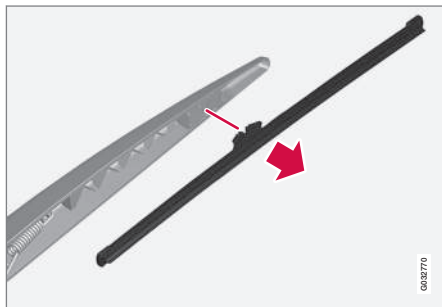
Replacing the wiper blades, rear window

1. Fold out the wiper arm.
2. Grip the inner section of the blade (by the arrow).
3. Turn anticlockwise to use the blade's end position against the wiper arm as a lever to detach the blade more easily.
4. Press the new wiper blade into position. Check that it is firmly installed.
5. Lower the wiper arm.

Cleaning

For cleaning wiper blades and windscreen, see Car wash (p. 398).

i IMPORTANT

Check the blades regularly. Neglected maintenance shortens the service life of the wiper blades.

Related information

- Washer fluid - filling (p. 377)

Washer fluid - filling

Washer fluid is used for cleaning the headlamps and windows. Washer fluid with anti-freeze must be used when the temperature is below freezing point.

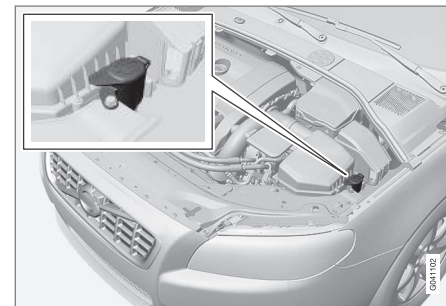

Topping up the washer fluid takes place by opening the blue cap.

The windscreen and headlamp washers share a common reservoir.

i NOTE

When there is approx. 1 litre of washer fluid remaining in the reservoir, a message to top up the washer fluid will be shown in the combined instrument panel, together with the symbol .



10 Maintenance and service



Prescribed grade: Washer fluid recommended by Volvo - with frost protection during cold weather and below freezing point.

! IMPORTANT

Use Volvo genuine washer fluid or equivalent with a recommended pH of between 6 and 8, in working dilution (e.g. 1:1 with neutral water).

! IMPORTANT

Use washer fluid with antifreeze when the temperature is below freezing to avoid freezing in the pump, reservoir and hoses.

Volume:

- Cars **with** headlamp washing: 6.5 litres.
- Cars **without** headlamp washing: 4.5 litres.

Related information

- Wiper blades (p. 375)
- Wipers and washers (p. 104)

Starter battery - general

The starter battery is used to drive the starter motor and other electrical equipment in the car.

The starter battery is a traditional 12 V battery.

The service life and function of the starter battery is influenced by factors such as the number of starts, discharging, driving style, driving conditions, climatic conditions, etc.

- Never disconnect the starter battery when the engine is running.
- Check that the cables to the starter battery are correctly connected and properly tightened.

	Engine	
	Petrol	Diesel
Voltage (V)	12	12
Cold start capacity ^A - CCA ^B (A)	520-800	700-800

^A In accordance with SAE or EN standard.

^B Cold Cranking Amperes.

! IMPORTANT

When replacing the starter battery, in cars with Start/Stop function, a battery of the correct type must be fitted, EFB¹² in cars with manual gearbox and AGM¹³ in cars with automatic gearbox.

! IMPORTANT

If the starter battery is replaced, make sure you replace it with a battery with the same cold starting capacity and type as the original battery (see the label on the battery).

i NOTE

- The starter battery's container size should be consistent with the original battery's dimensions.
- The starter battery's height is different depending on size.

¹² Enhanced Flooded Battery.

¹³ Absorbed Glass Mat.

**! WARNING**

- The battery can generate oxyhydrogen gas, which is highly explosive. A spark can be formed if a jump lead is connected incorrectly, and this can be enough for the battery to explode.
- The battery contains sulphuric acid, which can cause serious burns.
- If sulphuric acid comes into contact with eyes, skin or clothing, flush with large quantities of water. If acid splashes into the eyes - seek medical attention immediately.

! IMPORTANT

When charging the starter battery or the support battery (p. 382), only use a modern battery charger with controlled charging voltage. Fast charging function must not be used since it may damage the battery.

! IMPORTANT

If the following instruction is not observed then the energy saving function for information system may be temporarily disengaged, and/or the message in the combined instrument panel's information display about the starter battery's state of charge may be temporarily inapplicable, following the connection of an external starter battery or battery charger:

- The negative battery terminal on the car's starter battery must **never** be used for connecting an external starter battery or battery charger - only the **car chassis** may be used as the grounding point.

See Jump starting with battery (p. 270) for a description of how the cable clamps must be attached.

i NOTE

The life of the battery is shortened if it becomes discharged repeatedly.

The life of the battery is affected by several factors, including driving conditions and climate. Battery starting capacity decreases gradually with time and therefore needs to be recharged if the car is not used for a longer time or when it is only driven short distances. Extreme cold further limits starting capacity.

To maintain the battery in good condition, at least 15 minutes of driving/week is recommended or that the battery is connected to a battery charger with automatic trickle charging.

A battery that is kept fully charged has a maximum service life.

Related information





- Battery - symbols (p. 380)
- Starter battery - replacement (p. 380)
- Battery - Start/Stop (p. 382)



Battery - symbols

There are information and warning symbols on the batteries.

Symbols on the batteries

	Use protective goggles.
	Further information in the owner's manual for the car.
	Store the battery out of the reach of children.
	The battery contains corrosive acid.

	Avoid sparks and naked flames.
	Risk of explosion.
	Must be taken for recycling.

i NOTE
An expended battery must be recycled in an environmentally safe manner as it contains lead.

Related information

- Starter battery - general (p. 378)

Starter battery - replacement

The starter battery in the car can be replaced without the help of a workshop.

The starter battery is a traditional 12 V battery.

Removal

First of all: Take the remote control key from the ignition switch and wait at least 5 minutes before any electrical connections are touched - this is because the car's electrical system needs to store the necessary information to control modules.

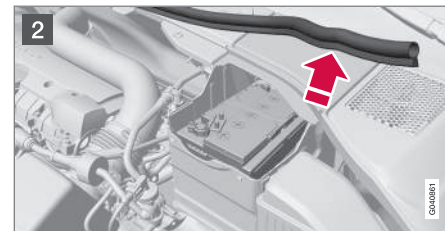
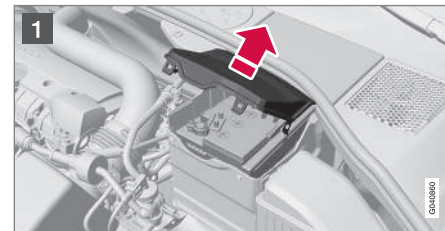

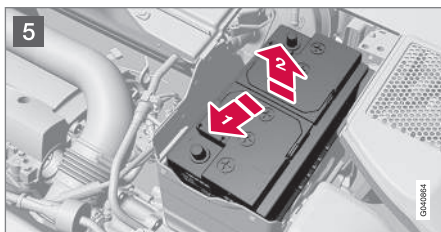
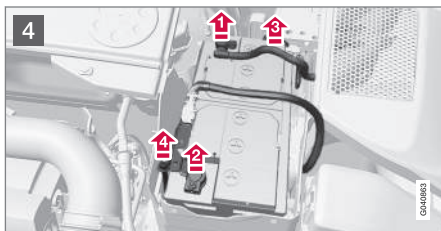
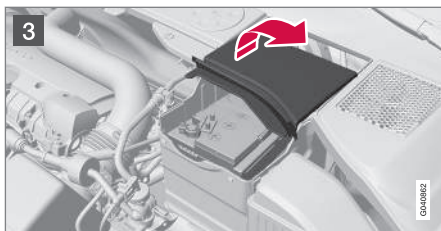

- 1 Open the clips on the front cover and remove the cover.
- 2 Release the rubber moulding so that the rear cover is free.

- 3 Remove the rear cover by screwing one quarter turn and lifting it away.

WARNING

Connect and remove the positive and negative cables in the correct order.

4

- 1 Detach the black negative cable.
- 2 Detach the red positive cable.
- 3 Detach the ventilation hose from the battery.
- 4 Loosen the screw holding the battery clamp.

5

- 1 Move the battery aside.
- 2 Lift it up.

Fitting

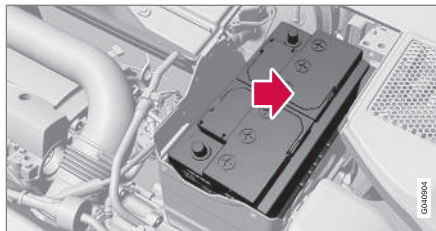

1. Lower the battery into the battery box.
2. Move the battery inward and to the side until it reaches the rear edge of the box.
3. Tighten the clamp that holds the battery.
4. Connect the ventilation hose.
 - > Check that it is correctly connected to both battery and outlet in the body.
5. Connect the red positive cable.
6. Connect the black negative cable.
7. Press in the rear cover. (See earlier section "Removal".)
8. Fit the rubber moulding. (See "Removal".)
9. Align the front cover and secure it with the clips. (See "Removal".)

For more information on the car's starter battery, see Jump starting with battery (p. 270).



Battery - Start/Stop

Cars with the Start/Stop function are equipped with a support battery in addition to the starter battery.

Cars with the Start/Stop function are equipped with two 12 V batteries - one extra powerful starter battery for starting and one support battery that helps during the Start/Stop function's starting sequence.

For more information on the Start/Stop function, see Start/Stop* (p. 281).

For more information on the car's starter battery, see Jump starting with battery (p. 270).

The following table shows specifications for the starter battery and support battery respectively in cars with Start/Stop function.

	Battery	
	Start, 12 V	Support, 12 V
Cold start capacity ^A - CCA ^B (A)	720 ^C 760 ^D	Left-hand drive car: 120 ^E 170 ^F Right-hand drive car: 120
Size, L×W×H (mm)	278×175×190	Left-hand drive car: 150×90×106 ^E 150×90×130 ^F Right-hand drive car: 150×90×106

	Battery	
	Start, 12 V	Support, 12 V
Capacity (Ah)	70	Left-hand drive car: 8 ^E 10 ^F Right-hand drive car: 8

A In accordance with EN standard.

B Cold Cranking Amperes.

C Manual gearbox.

D Automatic gearbox.

E Manual gearbox in combination with Start/Stop function that only auto-stops when the car is completely stationary.

F Others.



IMPORTANT

When replacing the starter battery, in cars with Start/Stop function, a battery of the correct type must be fitted, EFB¹⁴ in cars with manual gearbox and AGM¹⁵ in cars with automatic gearbox.

When replacing the support battery, a battery of AGM type must be fitted.

¹⁴ Enhanced Flooded Battery.

¹⁵ Absorbed Glass Mat.

* Option/accessory, for more information, see Introduction.



NOTE

- The higher the current take-off in the car, the more the alternator must be working and the batteries charging = Increased fuel consumption.
- When the capacity of the starter battery has fallen below the lowest permissible level then the Start/Stop function is disengaged.

Temporarily reduced Start/Stop function due to high current take-off means:

- The engine starts automatically¹⁶ without the driver depressing the clutch pedal (manual gearbox).
- The engine starts automatically without the driver lifting his/her foot off the foot brake pedal (automatic gearbox).

¹⁶ Automatic starting can only take place if the gear lever is in neutral position.

¹⁷ See Starter battery - general (p. 378) for detailed description of the starter battery.

Location of the batteries

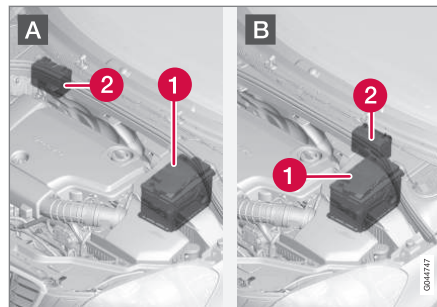

A: Left-hand drive car. B: Right-hand drive car.
(1) Starter battery¹⁷ (2) Support battery.

The support battery normally requires no more service than the normal starter battery. A workshop should be contacted in the event of questions or problems - an authorised Volvo workshop is recommended.

IMPORTANT

If the following instruction is not observed then the Start/Stop function may temporarily cease to work after the connection of an external battery or battery charger:

- The negative battery terminal on the car's starter battery must **never** be used for connecting an external battery or battery charger - only the **car chassis** may be used as the grounding point.

See Jump starting with battery (p. 270) for a description of how the cable clamps must be attached.



NOTE

If the battery has become so discharged that everything is "black" and in principle the car does not have all the normal electrical functions and the engine is subsequently started using an external battery or battery charger, then the Start/Stop function will be activated. It will then be possible for the engine to be auto-stopped but in the event of an auto-stop the Start/Stop function may fail to auto-start the engine due to inadequate capacity in the battery.

The battery must first be charged in order to ensure a successful auto-start after an auto-stop. At an outside temperature of +15 °C the battery needs to be charged for at least 1 hour. At a lower outside temperature a charging time of 3-4 hours is recommended. The recommendation is that the battery is charged using an external battery charger.

If this is not possible then the recommendation is to temporarily deactivate the Start/Stop function until the battery has been adequately recharged.

For more information on charging the starter battery, see Starter battery - general (p. 378).

Related information

- Battery - symbols (p. 380)

Electrical system

The electrical system is single-pole and uses the chassis and engine casing as a conductor.

The car has a voltage-regulated AC alternator.

The size, type and performance of the starter battery depend on the car's equipment and function.

IMPORTANT

If the starter battery is replaced, make sure you replace it with a battery with the same cold starting capacity and type as the original battery (see the label on the battery).

Related information

- Starter battery - replacement (p. 380)
- Starter battery - general (p. 378)

Fuses - general

All electrical functions and components are protected by a number of fuses in order to protect the car's electrical system from damage by short circuiting or overloading.

If an electrical component or function does not work, it may be because the component's fuse was temporarily overloaded and failed. If the same fuse fails repeatedly then there is a fault in the circuit. Volvo recommends that you visit an authorised Volvo workshop for checking.

Changing

1. Look in the fuse diagram to locate the fuse.
2. Pull out the fuse and check from the side to see whether the curved wire has blown.
3. If this is the case, replace it with a new fuse of the same colour and amperage.



WARNING

Never use a foreign object or a fuse with an amperage higher than that specified when replacing a fuse. This could cause significant damage to the electrical system and possibly lead to fire.



Location of central electrical units

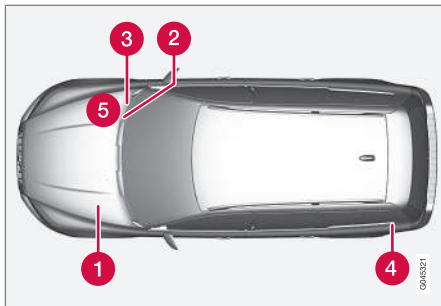

Central electrical unit locations in a left-hand drive car. In a right-hand drive car the central electrical units under the glovebox change sides.

- ① Engine compartment
- ② Under the glovebox
- ③ Under the glovebox
- ④ Cargo area
- ⑤ Engine compartment cold zone (only Start/Stop)

Related information

- Fuses - in engine compartment (p. 386)
- Fuses - under glovebox (p. 390)
- Fuses - in the control module under the glovebox (p. 392)
- Fuses - in cargo area (p. 394)

- Fuses - in the engine compartment's cold zone (p. 396)



10 Maintenance and service

Fuses - in engine compartment

Fuses in the engine compartment protect engine and brake functions, amongst other things.

10

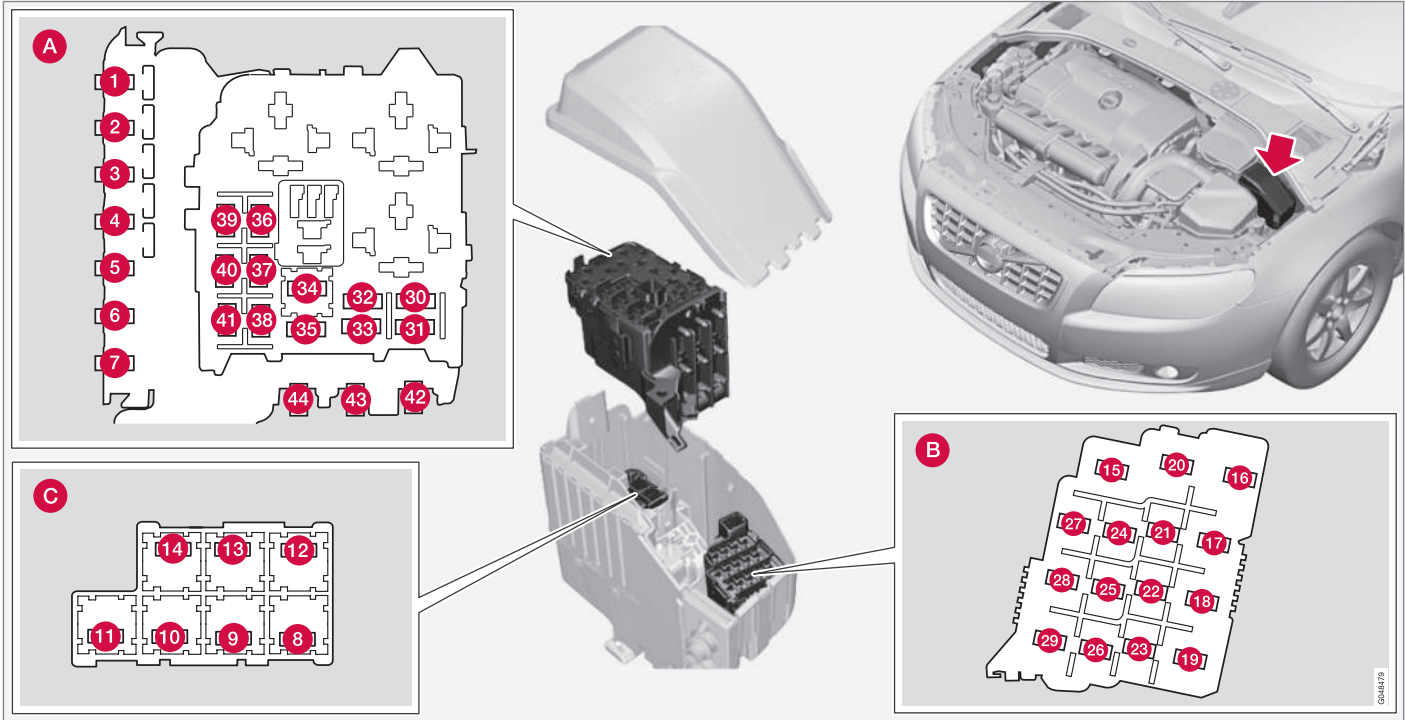



General fuses, engine compartment

On the inside of the cover there are tweezers that facilitate the procedure for the removal and fitting of fuses.

Positions (see preceding illustration)

- A** Engine compartment, upper
- B** Engine compartment, front
- C** Engine compartment, lower

These fuses are all located in the engine compartment box. The fuses in (C) are located under (A).

On the inside of the cover is a label that shows the location of the fuses.

- Fuses 1-7 and 42-44 are of the "Midi Fuse" type and must only be replaced by a workshop¹⁸.
- Fuses 8-15 and 34 are of the "JCASE" type and should be replaced by a workshop¹⁸.
- Fuses 16-33 and 35-41 are of the "Mini Fuse" type.

	Function	[A] ^A
1	Primary fuse for the central electronic module (CEM) under the glovebox ^B	50
2	Primary fuse for the central electronic module (CEM) under the glovebox	50
3	Primary fuse for central electrical unit in cargo area ^B	60
4	Primary fuse for relay/fuse box under the glovebox	60
5	Primary fuse for relay/fuse box under the glovebox ^B	60
6	-	-
7	Electric additional heater ^{AB}	100
8	Heated windscreen ^{AB} , left-hand side	40
9	Windscreen wipers	30
10	Parking heater*	25
11	Ventilation fan ^C	40
12	Heated windscreen ^{AB} , right-hand side	40

	Function	[A] ^A
13	ABS pump	40
14	ABS valves	20
15	Headlamp washers*	20
16	Headlamp levelling*; Active Xenon headlamps - ABL*	10
17	Primary fuse for the central electronic module (CEM) under the glovebox	20
18	ABS	5
19	Adjustable steering force*	5
20	Engine control module; Transmission control module; Airbags	10
21	Heated washer nozzles*	10
22	-	-
23	Headlamp control	5
24	-	-
25	-	-

¹⁸ An authorised Volvo workshop is recommended.



10 Maintenance and service



	Function	[A] ^A
26	-	-
27	Relay coils	5
28	Auxiliary lamps*	20
29	Horn	15
30	Relay coil in main relay for engine management system (4-cyl.); Engine control module (4-cyl.)	5
	Relay coil in main relay for engine management system (5, 6-cyl.); Engine control module (5, 6-cyl.)	10
31	Transmission control module	15
32	Solenoid clutch A/C (5, 6-cyl. petrol); Supporting coolant pump (4-cyl. diesel)	15
33	Relay coil in relay for solenoid clutch A/C (5, 6-cyl. petrol); Relay coils in central electrical unit in engine compartment cold zone (Start/Stop)	5
34	Start relay (5, 6-cyl. petrol) ^C	30

	Function	[A] ^A
35	Glow control module (5-cyl. diesel)	10
	Engine control module (4-cyl.); Ignition coils (5, 6-cyl. petrol); Capacitor (6-cyl.)	20
36	Engine control module (5, 6-cyl. petrol)	10
	Engine control module (5-cyl. diesel)	15
	Engine control module (4-cyl.)	20
37	Mass air flow sensor (4-cyl.); Thermostat(4-cyl. petrol); EVAP valve (4-cyl. petrol); Cooling pump for EGR (4-cyl. diesel)	10
	Mass air flow sensor (5-cyl. diesel, 6-cyl.); Control valves (5-cyl. diesel); Injectors (5, 6-cyl. petrol); Engine control module (5, 6-cyl. petrol)	15

	Function	[A] ^A
38	Solenoid clutch A/C (5, 6-cyl.); Valves (5, 6-cyl.); Engine control module (6-cyl.); Mass air flow sensor (5-cyl. petrol); Oil level sensor	10
	Valves (4-cyl.); Oil pump (4-cyl. petrol); Lambda-sond, centre (4-cyl. petrol); Lambda-sond, rear (4-cyl. diesel)	15
39	Lambda-sond, front (4-cyl.); Lambda-sond, rear (4-cyl. petrol)	15
	EVAP valve (5, 6-cyl. petrol); Lambda-sonds (5, 6-cyl.); Control module radiator roller cover (5-cyl. diesel)	
40	Coolant pump (5-cyl. petrol); Crankcase ventilation heater (5-cyl. petrol); Oil pump automatic gearbox (5-cyl. petrol Start/Stop)	10
	Ignition coils (4-cyl. petrol)	15
	Diesel filter heater (diesel)	20



	Function	[A] ^A
41	Control module, radiator roller cover (5-cyl. petrol)	5
	Solenoid clutch A/C (4-cyl.); Glow control module (4-cyl. diesel); Oil pump (4-cyl. diesel)	7.5
	Crankcase ventilation heater (5-cyl. diesel); Oil pump automatic gearbox (5-cyl. diesel Start/Stop)	10
42	Coolant pump (4-cyl. petrol)	50
	Glow plugs (diesel)	70
43	Cooling fan (4 - 5-cyl. petrol)	60
	Cooling fan (6-cyl., 4, 5-cyl. diesel)	80
44	Power steering	100

^A Ampere

^B For cars with the Start/Stop function this fuse location is empty - see instead Fuses - in the engine compartment's cold zone (p. 396).

^C For cars with the Start/Stop function this fuse location is empty - see instead Fuses - in the engine compartment's cold zone (p. 396).

Related information

- Fuses - under glovebox (p. 390)
- Fuses - in the control module under the glovebox (p. 392)
- Fuses - in cargo area (p. 394)



Fuses - under glovebox

Fuses under the glovebox protect the infotainment system and seat functions, amongst other things.



Positions

	Function	[A] ^A
1	Primary fuse for audio control module*; Primary fuse for fuses 16-20: Infotainment	40
2	-	-
3	-	-
4	Heated steering wheel*	10

	Function	[A] ^A
5	-	-
6	-	-
7	12 V socket, cargo area*	15
8	Control panel, driver's door	20
9	Control panel, front passenger door	20

	Function	[A] ^A
10	Control panel, rear passenger door, right	20
11	Control panel, rear passenger door, left	20
12	Keyless*	20
13	Power seat, driver's side*	20
14	Power seat, passenger side*	20

0901150



	Function	[A] ^A
15	-	-
16	Infotainment Control Module or Screen ^B	5
17	Audio control unit (amplifier)*; TV*; Digital radio*	10
18	Audio control module or Control module Sensus ^B	15
19	Telematics*; Bluetooth*	5
20	-	-
21	Sunroof*; Interior lighting roof; Climate sensor*; Damper motors, air intake	5
22	12 V socket, tunnel console	15
23	Seat heating, rear right*	15
24	Seat heating, rear left*	15
25	-	-
26	Seat heating, front passenger side Seat ventilation front passenger side*	15

	Function	[A] ^A
27	Seat heating, front driver's side Seat ventilation front driver's side*	15
28	Parking assistance*	5
29	AWD control module*	15
30	Active chassis Four-C*	10

^A Ampere

^B Certain model variants.

Related information

- Fuses - in engine compartment (p. 386)
- Fuses - in the control module under the glovebox (p. 392)
- Fuses - in cargo area (p. 394)
- Fuses - in the engine compartment's cold zone (p. 396)



10 Maintenance and service

Fuses - in the control module under the glovebox

Fuses in the control module under the glovebox protect airbag and collision warning system functions, amongst other things.

10

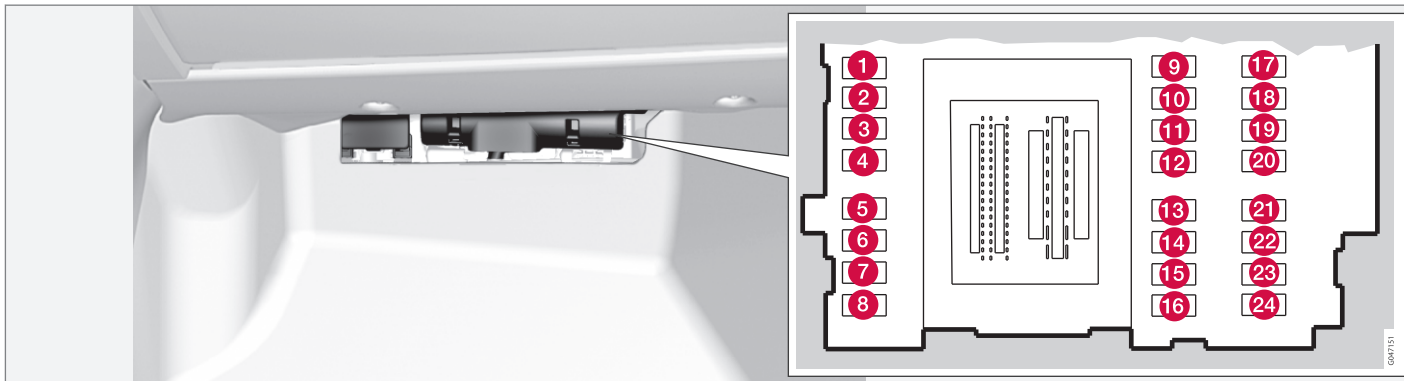

Positions

	Function	[A] ^A
1	Rear window wiper	15
2	-	-
3	Interior lighting; Driver's door control panel, power windows; Power seats*	7.5
4	Combined instrument panel	5

	Function	[A] ^A
5	Adaptive cruise control, ACC*; collision warning system*	10
6	Interior lighting; Rain sensor*	7.5
7	Steering wheel module	7.5
8	Central locking system, fuel filler flap	10

	Function	[A] ^A
9	Rear window washer	15
10	Windscreen washers	15
11	Unlocking, tailgate	10
12	Folding head restraint*	10
13	Fuel pump	20



	Function	[A] ^A
14	Movement detector alarm*; Climate panel	5
15	Steering lock	15
16	Siren*; Data link connector OBDII	5
17	-	-
18	Airbags	10
19	Collision warning system*	5
20	Accelerator pedal sensor; Dimming interior rearview mirror*; Seat heating, rear* Electric additional heater*	7.5
21	Infotainment control module (Performance); Audio (Performance)	15
22	Brake light	5
23	Sunroof*	20
24	Immobiliser	5

^A Ampere

Related information

- Fuses - in engine compartment (p. 386)
- Fuses - under glovebox (p. 390)

- Fuses - in cargo area (p. 394)
- Fuses - in the engine compartment's cold zone (p. 396)



Fuses - in cargo area

Fuses in the cargo area protect the electric parking brake, amongst other things.

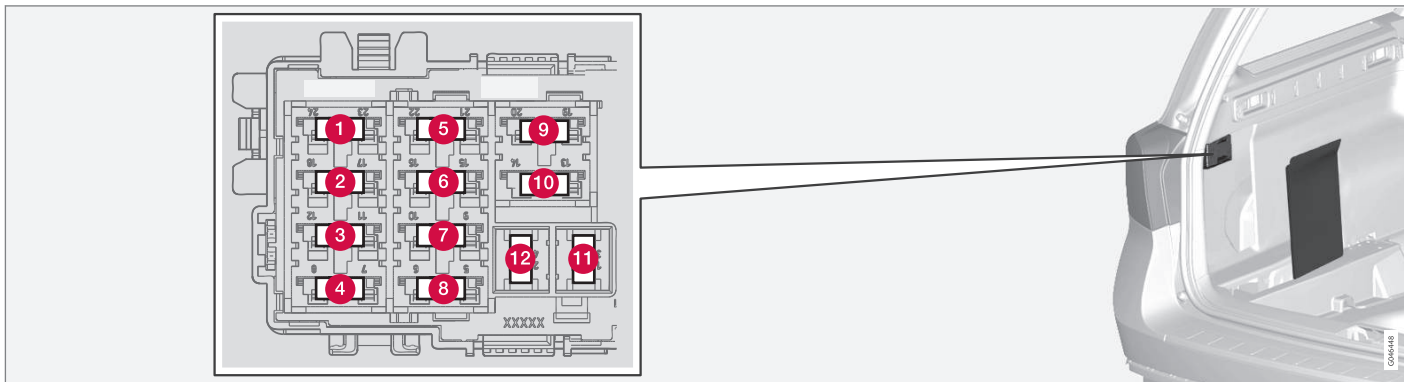

The fuse box is located behind the upholstery on the left-hand side.

Positions

	Function	[A] ^A
1	Electric parking brake, left	30
2	Electric parking brake, right	30
3	Rear window defroster	30
4	Trailer socket 2*	15
5	Power operated tailgate*	20

	Function	[A] ^A
6	-	-
7	-	-
8	-	-
9	-	-
10	-	-

	Function	[A] ^A
11	Trailer socket 1*	40
12	-	-

A Amperes

Related information

- Fuses - in engine compartment (p. 386)
- Fuses - under glovebox (p. 390)



- Fuses - in the control module under the glovebox (p. 392)
- Fuses - in the engine compartment's cold zone (p. 396)



Fuses - in the engine compartment's cold zone

Fuses in the engine compartment's cold zone are fitted in cars with the Start/Stop function.

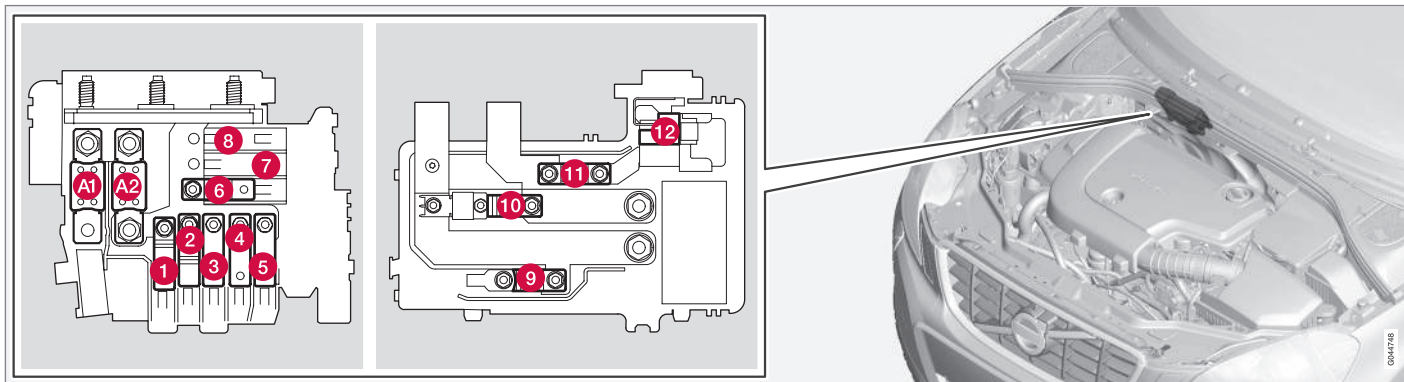

Fuse locations in the engine compartment's cold zone.

- Fuses A1 and A2 are of the "MEGA Fuse" type and must only be replaced by a workshop¹⁹.
- Fuses 1-11 are of the "Midi Fuse" type and must only be replaced by a workshop¹⁹.
- Fuse 12 is of the "Mini Fuse" type.

For more information on Start/Stop - see Start/Stop* (p. 281).

Positions

	Function	[A] ^A
A1	Main fuse for central electrical unit in the engine compartment	175

	Function	[A] ^A
A2	Main fuse for central electronic module (CEM) under the glovebox, relay/fuse box under the glovebox, central electrical unit in cargo area	175
1	Electric additional heater*	100

¹⁹ An authorised Volvo workshop is recommended.



	Function	[A] ^A
2	Primary fuse for the central electronic module (CEM) under the glovebox	50
3	Primary fuse for relay/fuse box under the glovebox	60
4	Heated windscreen*	60
5	Primary fuse for central electrical unit in cargo area	60
6	Ventilation fan	40
7	-	-
8	-	-
9	Start relay	30
10	-	-
11	Support battery	70
12	Central electronic module (CEM) - reference voltage support battery	5

^A Ampere

Related information

- Fuses - in engine compartment (p. 386)
- Fuses - under glovebox (p. 390)

- Fuses - in the control module under the glovebox (p. 392)
- Fuses - in cargo area (p. 394)



Car wash

The car should be washed as soon as it becomes dirty. Wash the car in a car wash with oil separator. Use car shampoo.

Handwashing

- Remove bird droppings from the paintwork as soon as possible. Bird droppings contain chemicals that affect and discolour paintwork very quickly. An authorised Volvo workshop is recommended for the removal of any discoloration.
- Hose down the underbody.
- Rinse the whole car until the loose dirt has been removed in order to reduce the risk of scratches from washing. Do not spray directly onto the locks.
- If necessary, use cold degreasing agent on very dirty surfaces. Note that the surfaces must not then be warmed up by the sun!
- Wash using a sponge, car shampoo and plenty of lukewarm water.
- Clean the wiper blades with a lukewarm soap solution or car shampoo.
- Dry the car using a clean, soft chamois or a water scraper. If you avoid allowing water droplets to dry in strong sunlight then the risk of water stains that may need to be polished away is reduced.

WARNING

Always have the engine cleaned by a workshop. There is a risk of fire if the engine is hot.

IMPORTANT

Dirty headlamps have impaired functionality. Clean them regularly, when refuelling for example.

Do not use any corrosive cleaning agents but use water and a non-scratching sponge instead.

NOTE

Outside lighting such as headlamps, fog lamps and rear lamps may temporarily have condensation on the inside of the lens. This is normal, all exterior lighting is designed to withstand this. Condensation is normally vented out of the lamp housing when the lamp has been switched on for a time.

Automatic car washes

An automatic car wash is a simple and quick way of washing the car, but it cannot reach everywhere. Handwashing the car is recommended for achieving optimum results.

NOTE

The car must only be washed by hand over the first few months. This is because the paint is more delicate when it is new.

High-pressure washing

When using high-pressure washing, use sweeping movements and make sure that the nozzle does not come closer than 30 cm to the surface of the car (the distance applies to all exterior parts). Do not spray directly onto the locks.

Testing the brakes

WARNING

Always test the brakes after washing the car, including the parking brake, to ensure that moisture and corrosion do not attack the brake linings and reduce braking performance.

Lightly depress the brake pedal now and then when driving long distances in rain or slush. The heat from the friction causes the brake linings to warm up and dry. Do the same thing after starting in very damp or cold weather.

Wiper blades

Asphalt, dust and salt residue on wiper blades, as well as insects, ice etc. on the



windscreen, impair the service life of wiper blades.

For cleaning:

- Set the wiper blades to the service position, see Wiper blades (p. 375).

NOTE

Wash the wiper blades and windscreen regularly with lukewarm soap solution or car shampoo. Do not use any strong solvents.

Exterior plastic, rubber and trim components

A special cleaning agent available from Volvo dealers is recommended for the cleaning and care of coloured plastic parts, rubber and trim components, such as glossy trim mouldings. When using such a cleaning agent the instructions must be followed carefully.

IMPORTANT

Avoid waxing and polishing on plastic and rubber.

When using degreasant on plastic and rubber, only rub with light pressure if it is necessary. Use a soft washing sponge.

Polishing glossy trim mouldings could wear away or damage the glossy surface layer.

Polishing agent that contains abrasive must not be used.

Rims

Only use rim cleaning agent recommended by Volvo.

Strong rim cleaning agents can damage the surface and cause stains on chrome-plated aluminium rims.

Related information

- Polishing and waxing (p. 399)
- Cleaning the interior (p. 401)
- Water and dirt-repellent coating (p. 400)

Polishing and waxing

Polish and wax the car if the paintwork is dull or to give the paintwork extra protection.

The car does not need to be polished until it is at least one year old. However, the car can be waxed during this time. Do not polish or wax the car in direct sunlight.

Wash and dry the car thoroughly before you begin polishing or waxing. Clean off asphalt and tar stains using tar remover or white spirit. More stubborn stains can be removed using fine rubbing paste designed for car paintwork.

Polish first with a polish and then wax with liquid or solid wax. Follow the instructions on the packaging carefully. Many preparations contain both polish and wax.

IMPORTANT

Avoid waxing and polishing on plastic and rubber.

When using degreasant on plastic and rubber, only rub with light pressure if it is necessary. Use a soft washing sponge.

Polishing glossy trim mouldings could wear away or damage the glossy surface layer.

Polishing agent that contains abrasive must not be used.



IMPORTANT

Only paint treatment recommended by Volvo should be used. Other treatment such as preserving, sealing, protection, lustre sealing or similar could damage the paintwork. Paintwork damage caused by such treatments is not covered by Volvo warranty.

Related information

- Car wash (p. 398)

Water and dirt-repellent coating

The windows are treated with a surface coating that improves visibility in difficult weather conditions.

Water and dirt-repellent coating*



There is natural wear of the water-repellent coating.

Maintenance:

- Never use products such as car wax, degreaser or similar on glass surfaces as this could ruin their water-repellent properties.
- Take care when cleaning so as not to damage the glass surface.
- To avoid damaging glass surfaces when removing ice – only use plastic ice scrapers.
- Treatment with a special finishing agent available from Volvo dealers is recommended in order to maintain the water-repellent properties on the side windows. This should be used first after three years and then each year.

IMPORTANT

Do not use a metal ice scraper to remove ice from the windows. Use the heating to remove ice from the door mirrors, see Windows and rearview and door mirrors - heating (p. 109).

Related information

- Car wash (p. 398)



Rustproofing

The car received a thorough and complete rustproofing at the factory. Parts of the body are made of galvanised sheet metal. The underbody is protected by a wear-resistant anti-corrosion compound. A thin, penetrating rustproofing fluid was sprayed into the exposed members, cavities, closed sections and side doors.

Inspection and maintenance

The car's anti-corrosion protection does not normally need to be maintained, but keeping the car clean always helps to further reduce the risk of corrosion. Strong alkaline or acidic cleaning solutions must always be avoided on the glossy trim components. Any stone chips should be rectified as soon as they are discovered.

Related information

- Paint damage (p. 402)

Cleaning the interior

Only use cleaning agents and car care products recommended by Volvo. Clean regularly and treat stains at once for best results. Vacuuming is important prior to using cleaning agents.

! IMPORTANT

- Certain items of coloured clothing (e.g. dark jeans and suede garments) may stain the upholstery. If this occurs, it is important to clean and treat these parts of the upholstery as soon as possible.
- Never use strong solvents such as washer fluid, pure petrol or white spirit to clean the interior, since this may damage the upholstery as well as other interior materials.
- Never spray the cleaning agent directly onto components that have electrical buttons and controls. Wipe them instead using a moistened cloth containing the cleaning agent.
- Sharp objects and Velcro may damage the fabric upholstery.

Fabric upholstery and ceiling upholstery

Volvo offers a comprehensive fabric care product for fabric upholstery and ceiling upholstery which, when used in accordance with the instructions, preserves the properties

of the upholstery. The fabric care product is available for purchase from a Volvo dealer.

Leather upholstery

Volvo's leather upholstery is treated to preserve its original appearance.

Leather upholstery is a natural product that changes and acquires a beautiful patina over time. Regular cleaning and treatment are required in order that the properties and colours of the leather shall be preserved. Volvo offers a comprehensive product, Volvo Leather Care Kit/Wipes, for the cleaning and treatment of leather upholstery which, when used in accordance with the instructions, preserves the leather's protective coating.

To achieve best results, Volvo recommends the cleaning and application of the protective cream once to four times per year (or more if required). The Volvo Leather Care Kit/Wipes is available for purchase from a Volvo dealer.

Leather steering wheel

Leather needs to breathe. Never cover the leather steering wheel with protective plastic. Volvo Leather Care Kit/Wipes is recommended for cleaning the leather steering wheel.

Interior plastic, metal and wood parts

A fibrillated fibre or microfibre cloth, lightly moistened with water, available from Volvo dealers, is recommended for cleaning interior parts and surfaces.



Do not scrape or rub stains. Never use strong stain removers. A special cleaning agent available from Volvo dealers can be used for more difficult cleaning.

Seatbelts

Use water and a synthetic detergent. A special textile cleaning agent is available from a Volvo dealer. Ensure that the seatbelt is dry before allowing it to retract.

Inlay mats and floor mat

Remove inlaid carpets for separate cleaning of the floor carpet and the inlaid carpets. Use a vacuum cleaner to remove dust and dirt. Each inlay mat is secured with pins.

Remove the inlay mat by taking hold of the inlay mat at each pin and lifting the mat straight up.

Fit the inlay mat in place by pressing it in at each pin.

WARNING

Only use one inlaid mat at each seat, and check before setting off that the mat by the driver's seat is firmly affixed and secured in the pins so that it does not get caught adjacent to and under the pedals.

A special textile cleaner is recommended for stains on the floor mat after vacuuming. Floor mats must be cleaned with agents recommended by a Volvo dealer.

Related information

- Car wash (p. 398)

Paint damage

Paint is an important part of the car's rust-proofing and should therefore be checked regularly. The most common types of paintwork damage are stone chips, scratches, and marks on the edges of wings, doors and bumpers.

Touching up minor paintwork damage

To avoid the onset of rust, damaged paintwork should be rectified immediately.

Materials that may be needed



- Primer²⁰ - a special adhesive primer in a spray can is available for e.g. plastic-coated bumpers.
- base coat and clear coat - are available in spray cans or as touch-up pens/sticks²¹.
- Masking tape.
- fine sand paper²⁰.

Colour code

The label for colour code is located on the car's door pillar and is visible when the right-hand rear door is opened.

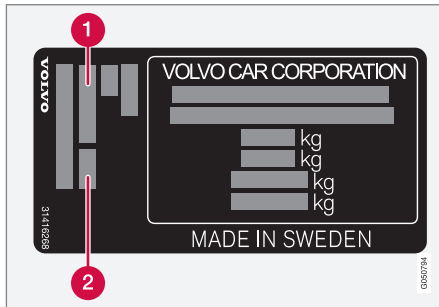

- 1 Exterior colour code
- 2 Any secondary exterior colour code

It is important that the correct colour is used. For product label location, see Type designations (p. 405).

²⁰ If required.

²¹ Follow the instructions that are included with the package for the touch-up pen/stick.

Repairing minor paint damage such as stone chips and scratches

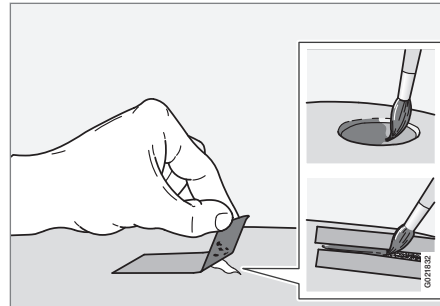

Before work is started, the car must be clean and dry as well as at a temperature above 15 °C.

1. Apply a piece of masking tape over the damaged surface. Then remove the tape to remove any loose paint.

If the damage has reached down to a metal surface (sheet steel), it is preferable to use a primer. In the event of damage to a plastic surface, an adhesive primer should be used for better results - spray into the spray can's cap and brush thinly.

2. Before painting, gentle polishing using a very fine polishing agent may be carried out locally if required (e.g. if there are any uneven edges). Clean the surface thoroughly and allow to dry.
3. Stir the primer well and apply using a fine brush, matchstick or similar. Finish with base coat and clear coat once the primer has dried.
4. For scratches, proceed as above, but mask around the damaged area to protect the undamaged paintwork.

i NOTE

If the stone chip has not penetrated down to the metal and an undamaged layer of paint remains in place, fill in with base coat and clear coat as soon as the surface has been cleaned.

Related information

- Rustproofing (p. 401)



SPECIFICATIONS

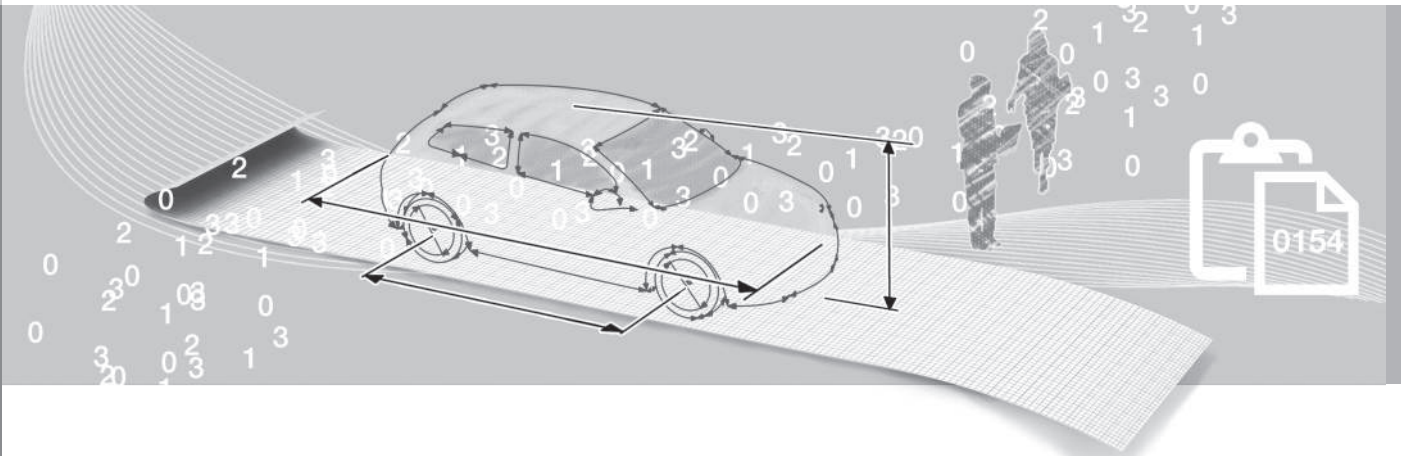

Type designations

Type designation, vehicle identification number, etc., i.e. information unique to the car, can be read on a label in the car.

11 Specifications



Label location

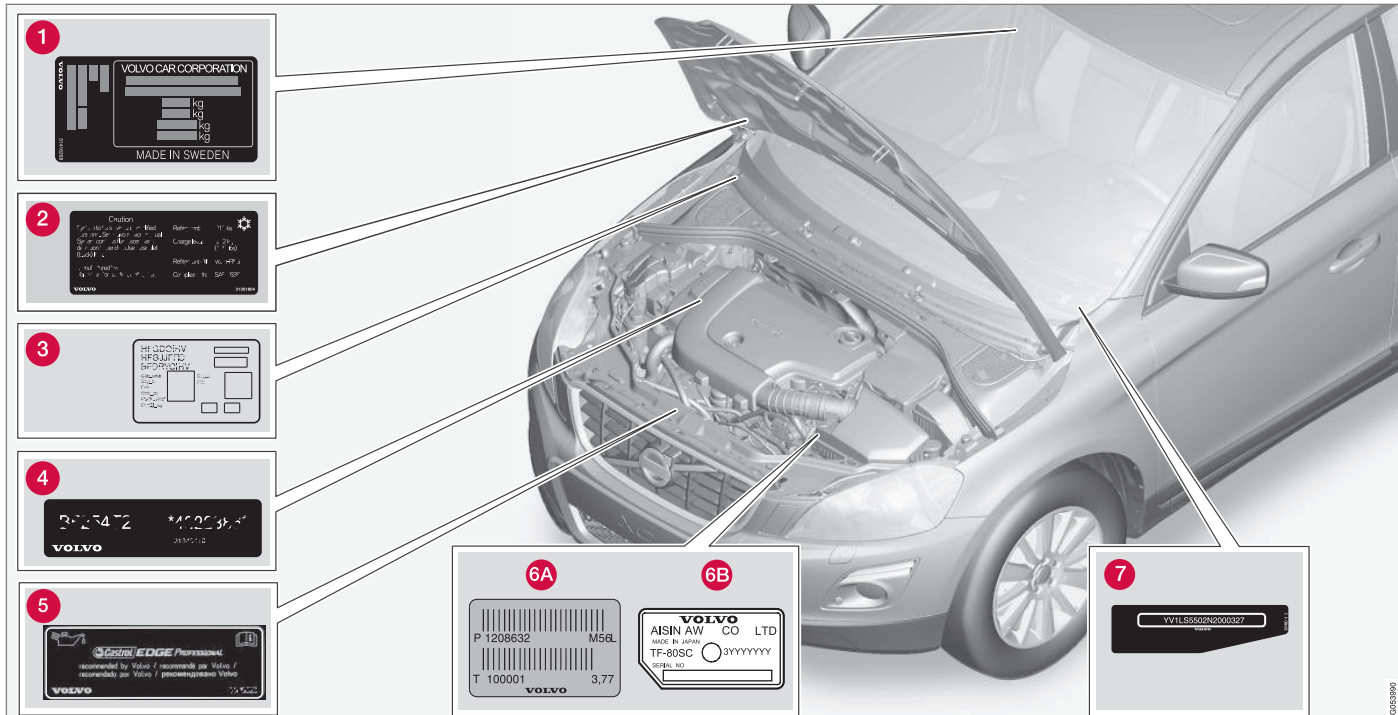

The illustration is schematic - details may vary depending on market and model.

Knowing the car's type designation, vehicle identification and engine numbers can facilitate all contact with an authorised Volvo

dealer regarding the car and when ordering spare parts and accessories.

1 Type designation, vehicle identification number, permissible maximum weights and code designation for exterior colour

and type approval number. The decal is positioned on the door pillar, and will be visible when the right-hand rear door is opened.

- 2 Label for A/C system.
- 3 Label for parking heater.
- 4 Engine code and engine serial number.
- 5 Label for engine oil.
- 6 Gearbox type designation and serial number.
 - A Manual gearbox
 - B Automatic gearbox
- 7 Car's identification number (VIN Vehicle Identification Number).

Further information on the car is presented in the registration document.

NOTE

It is not intended that the decals illustrated in the owner's manual should be exact replicas of those in the car. They are included to show their approximate appearance and location in the car. The information that applies to your particular car can be found on the decal on the car.

Related information

- Weights (p. 410)
- Engine specifications (p. 414)

11 Specifications

Dimensions

Measurement of car length, height, etc. can be read in the table.

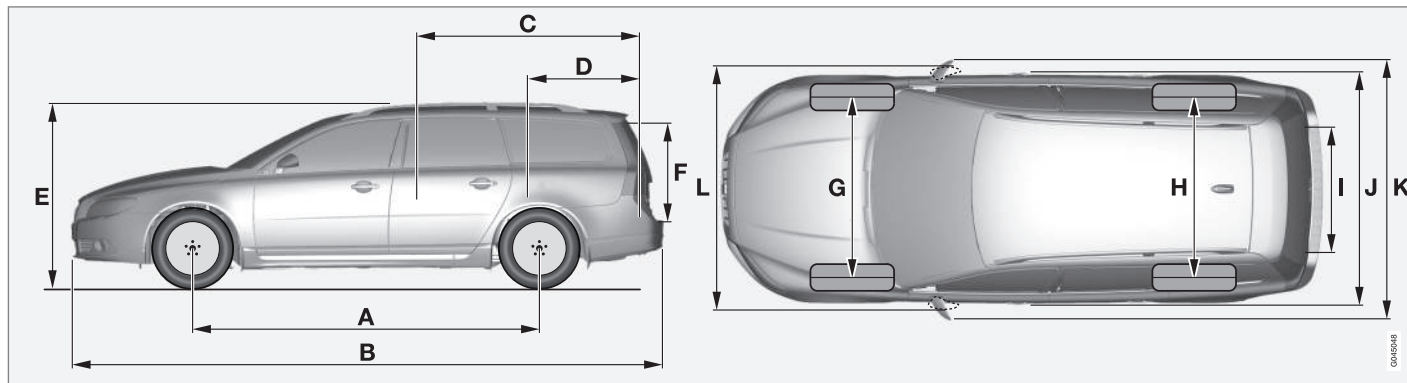

V70.

	Dimensions	mm
A	Wheelbase	2816
B	Length	4814
C	Load length, floor, folded seat	1878
D	Load length, floor	1089
E	Height	1547
F	Load height	724

	Dimensions	mm
G	Front track	1588 ^A
		1578 ^B
H	Rear track	1586 ^A
		1576 ^B
I	Load width, floor	1153
J	Width	1861 (1876 ^C)

	Dimensions	mm
K	Width including door mirrors	2106
L	Width including folded-in door mirrors	1907

A with 16"50 and 17"50 wheel
 B with 17"55 and 18"55 wheel
 C with Keyless drive*

©2014

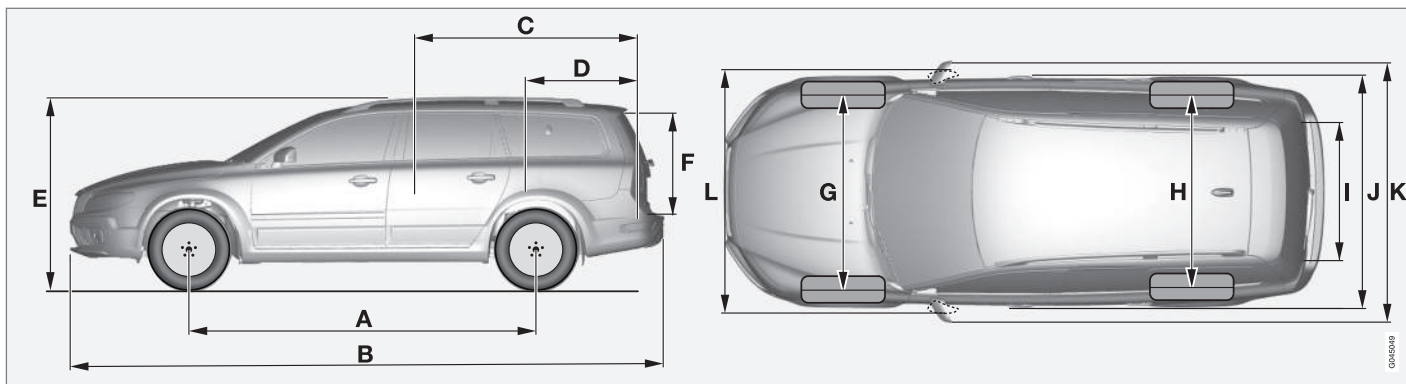

XC70.

	Dimensions	mm
A	Wheelbase	2815
B	Length	4838
C	Load length, floor, folded seat	1878
D	Load length, floor	1089
E	Height	1604
F	Load height	724
G	Front track	1614 ^A 1604 ^B

	Dimensions	mm
H	Rear track	1580 ^A 1570 ^B
I	Load width, floor	1153
J	Width	1870 (1876 ^C)
K	Width including door mirrors	2119
L	Width including folded-in door mirrors	1925

A with 16"50 wheel
 B with 17"55 and 18"55 wheel
 C with Keyless drive*

Weights

Max. gross vehicle weight, etc. can be read on a label in the car.

Kerb weight includes the driver, the fuel tank 90% full and all fluids.

The weight of passengers and accessories, and towball load (p. 411) (when a trailer is hitched) influence the load capacity and are not included in the kerb weight.

Permitted max. load = Gross vehicle weight - Kerb weight.

NOTE

The documented kerb weight applies to cars in the standard version - i.e. a car without extra equipment or accessories. This means that for every accessory added the loading capacity of the car is reduced correspondingly by the weight of the accessory.

Examples of accessories that reduce loading capacity are the Kinetic/Momentum/Summum equipment levels, as well as other accessories such as Towbar, Load carrier, Space box, Audio system, Auxiliary lamps, GPS, Fuel-driven engine block heater, Safety grille, Carpets, Cargo cover, Power seats, etc.

Weighing the car is a certain way of ascertaining the kerb weight of your own particular car.

WARNING

The car's driving characteristics change depending on how heavily it is loaded and how the load is distributed.

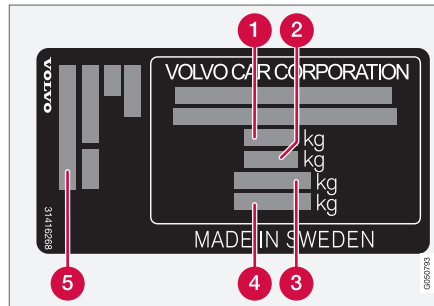

For information on label location, see Type designations (p. 405).

- 1 Max. gross vehicle weight
- 2 Max. train weight (car+trailer)
- 3 Max. front axle load
- 4 Max. rear axle load
- 5 Equipment level

Max. load: See registration document.

Max. roof load: 100 kg.

Related information

- Towing capacity and towball load (p. 411)

Towing capacity and towball load

Towing capacity and towball load for driving with a trailer can be read in the tables.



NOTE

Not all engines are available in all markets.

Max. weight braked trailer



NOTE

The use of a stabiliser hitch on the towing bracket is recommended for trailers heavier than 1800 kg.

V70 Engine	Engine code ^A	Gearbox	Max. weight braked trailer (kg)	Max. towball load (kg)
All	All	All	1200	50
T4	B4204T19	Manual, M66	1600	75
T4	B4204T19	Automatic, TF-71SC	1600	75
T5/Bi-Fuel	B4204T11	Automatic, TG-81SC	1800	90
D2	D4204T20	Manual, M66	1800	90
D2	D4204T20	Automatic, TF-71SC	1800	90
D3	D4204T9	Manual, M66	1800	90
D3	D4204T9	Automatic, TF-71SC	1800	90
D4	D4204T5	Manual, M66	1800	90

11 Specifications



V70 Engine	Engine code ^A	Gearbox	Max. weight braked trailer (kg)	Max. towball load (kg)
D4	D4204T5	Automatic, TG-81SC	1800	90
D4 AWD	D5244T12	Automatic, TF-80SD	2000	90

^A Engine code, component and serial number can be read on the engine; see Type designations (p. 405).

XC70 Engine	Engine code ^A	Gearbox	Max. weight braked trailer (kg)	Max. towball load (kg)
All	All	All	1200	50
T5	B4204T11	Automatic, TG-81SC	1800	90
T5 AWD	B5254T14	Automatic, TF-80SC	2000	90
T5 AWD	B5254T12	Automatic, TF-80SC / TF-80SD	2000	90
D4	D4204T5	Manual, M66	1800	90
D4	D4204T5	Automatic, TG-81SC	1800	90
D4 AWD	D5244T12	Manual, M66	2100	90
D4 AWD	D5244T12	Automatic, TF-80SD	2100	90
D4 AWD	D5244T17	Manual, M66	2100	90
D4 AWD	D5244T17	Automatic, TF-80SD	2100	90
D5 AWD	D5244T20	Automatic, TF-80SD	2100	90

^A Engine code, component and serial number can be read on the engine; see Type designations (p. 405).

Max. weight unbraked trailer

Max. weight unbraked trailer (kg)	Max. towball load (kg)
750	50

Related information

- Weights (p. 410)
- Driving with a trailer* (p. 309)

11 Specifications

Engine specifications

Engine specifications (output etc.) for each respective engine alternative can be read in the table.

NOTE
Not all engines are available in all markets.

V70 Engine	Engine code ^A	Output (kW/rpm)	Output (hp/rpm)	Torque (Nm/rpm)	No. of cylinders	Bore (mm)	Stroke (mm)	Swept volume (litres)	Compression ratio
T4	B4204T19	140/4700	190/4700	300/1300-4000	4	82.0	93.2	1,969	11.3:1
T5/Bi-Fuel	B4204T11	180/5500	245/5500	350/1500-4800	4	82.0	93.2	1,969	10.8:1
D2	D4204T20	88/3750	120/3750	280/1500-2250	4	82.0	93.2	1,969	16.0:1
D3	D4204T9	110/3750	150/3750	320/1750-3000	4	82.0	93.2	1,969	16.0:1
D4	D4204T5	133/4250	181/4250	400/1750-2500	4	82.0	93.2	1,969	15.8:1
D4 AWD	D5244T12	133/4000	181/4000	420/1500-2500	5	81.0	93.2	2.400	16.5:1

^A Engine code, component and serial number can be read on the engine; see Type designations (p. 405).

XC70 Engine	Engine code ^A	Output (kW/rpm)	Output (hp/rpm)	Torque (Nm/rpm)	No. of cylinders	Bore (mm)	Stroke (mm)	Swept volume (litres)	Compression ratio
T5	B4204T11	180/5500	245/5500	350/1500-4800	4	82.0	93.2	1,969	10.8:1
T5 AWD	B5254T14	183/5400	249/5400	360/1800-4200	5	83.0	92,3	2,497	9.5:1
T5 AWD	B5254T12	187/5400	254/5400	360/1800-4200	5	83.0	92,3	2,497	9.5:1
D4	D4204T5	133/4250	181/4250	400/1750-2500	4	82.0	93.2	1,969	15.8:1

XC70 Engine	Engine code ^A	Output (kW/rpm)	Output (hp/rpm)	Torque (Nm/rpm)	No. of cylinders	Bore (mm)	Stroke (mm)	Swept volume (litres)	Compression ratio
D4 AWD	D5244T12	133/4000	181/4000	420/1500–2500	5	81.0	93.2	2.400	16.5:1
D4 AWD	D5244T17	120/4000	163/4000	420/1500–2500	5	81.0	93.2	2.400	16.5:1
D5 AWD	D5244T20	162/4000	220/4000	440/1500–3000	5	81.0	93.2	2.400	16.5:1

^A Engine code, component and serial number can be read on the engine; see Type designations (p. 405).

Related information

- Coolant - grade and volume (p. 419)
- Engine oil - grade and volume (p. 417)

Engine oil - adverse driving conditions

Adverse driving conditions can lead to abnormally high oil temperature or oil consumption. Below are some examples of adverse driving conditions.

Check the oil level (p. 363) more frequently for long journeys:

- towing a caravan or trailer
- in mountainous regions
- at high speeds
- in temperatures colder than -30 °C or hotter than +40 °C.

The above also apply to shorter driving distances at low temperatures.

Choose a fully synthetic engine oil for adverse driving conditions. It provides extra protection for the engine.

Volvo recommends:



! IMPORTANT

In order to fulfil the requirements for the engine's service intervals all engines are filled with a specially adapted synthetic engine oil at the factory. The choice of oil has been made very carefully with regard to service life, starting characteristics, fuel consumption and environmental impact.

An approved engine oil must be used in order that the recommended service intervals can be applied. Only use a prescribed grade of oil for both filling and oil change, otherwise you will risk affecting service life, starting characteristics, fuel consumption and environmental impact.

Volvo Car Corporation disclaims all warranty liability if engine oil of the prescribed grade and viscosity is not used.

Volvo recommends that oil changes are carried out at an authorised Volvo workshop.

Related information

- Engine oil - grade and volume (p. 417)
- Engine oil - general (p. 362)

Engine oil - grade and volume

Engine oil grade and volume for each respective engine alternative can be read in the table.

Volvo recommends:

**NOTE**

Not all engines are available in all markets.

V70 Engine	Engine code ^A	Oil grade	Volume, incl. oil filter (litres)
D4 AWD	D5244T12	Oil grade: ACEA A5/B5 Viscosity: SAE 0W-30	approx. 5.9
T4	B4204T19	Castrol Edge Professional V 0W-20 or VCC RBS0-2AE 0w20	approx. 5.9
T5/Bi-Fuel	B4204T11		approx. 5.9

11 Specifications



V70 Engine	Engine code ^A	Oil grade	Volume, incl. oil filter (litres)
D2	D4204T20	Castrol Edge Professional V 0W-20 or VCC RBS0-2AE 0w20	approx 5.2
D3	D4204T9		approx 5.2
D4	D4204T5		approx 5.2

^A Engine code, component and serial number can be read on the engine; see Type designations (p. 405).

XC70 Engine	Engine code ^A	Oil grade	Volume, incl. oil filter (litres)
D4 AWD	D5244T12	Oil grade: ACEA A5/B5 Viscosity: SAE 0W-30	approx. 5.9
D4 AWD	D5244T17		approx. 5.9
D5 AWD	D5244T20		approx. 5.9
T5	B4204T11	Castrol Edge Professional V 0W-20 or VCC RBS0-2AE 0w20	approx. 5.9
D4	D4204T5		approx 5.2
T5 AWD	B5254T12	Oil grade: ACEA A5/B5 Viscosity: SAE 0W-30	approx 5.5
T5 AWD	B5254T14		approx 5.5

^A Engine code, component and serial number can be read on the engine; see Type designations (p. 405).

Related information

- Engine oil - adverse driving conditions (p. 416)
- Engine oil - checking and filling (p. 363)

Coolant - grade and volume

Approved coolant volume for each respective engine alternative can be read in the table.

Prescribed grade: Coolant recommended by Volvo mixed with 50% water¹, see the packaging.

NOTE

Not all engines are available in all markets.

Engine ^A		Volume (litres)
T4	B4204T19	8,3 (8,7 ^B)
T5/Bi-Fuel	B4204T11	
D2	D4204T20	8,9 (9,2 ^B)
D3	D4204T9	
D4	D4204T5	

Engine ^A		Volume (litres)
T5 AWD	B5254T12	8.9
T5 AWD	B5254T14	
D4 AWD	D5244T12	
D4 AWD	D5244T17	
D5 AWD	D5244T20	

^A Engine code, component and serial number can be read on the engine; see Type designations (p. 405).

^B Applies to cars with fuel-driven heater.

Related information

- Coolant - level (p. 366)

¹ Water quality must fulfil the standard STD 1285.1.

Transmission fluid - grade and volume

The prescribed transmission fluid and volume for each respective gearbox alternative can be read in the table.

Manual gearbox

Manual gearbox	Volume (litres)	Prescribed transmission fluid
M66	approx. 1.9 ^A approx. 1.45 ^B	BOT 350M3

A Applies to 5-cylinder engines.

B Applies to other engines.

i NOTE

The gearbox oil does not need to be changed under normal driving conditions. However, it may be necessary under adverse driving conditions.

Automatic gearbox

Automatic gearbox	Volume (litres)	Prescribed transmission fluid
TF-71SC	approx 6.8	AW1
TF-80SC	approx 7.0	AW1
TF-80SD	approx 7.0	AW1
TG-81SC	approx. 6.6 ^A approx. 7.5 ^B	AW1

A Petrol engines

B Diesel engines

**NOTE**

The gearbox oil does not need to be changed under normal driving conditions. However, it may be necessary under adverse driving conditions.

Related information

- Engine oil - adverse driving conditions (p. 416)
- Type designations (p. 405)

Brake fluid - grade and volume

The medium in a hydraulic brake system is called brake fluid, and it is used to transfer pressure from e.g. a brake pedal via a master brake cylinder to one or more slave cylinders, which in turn act on a mechanical brake.

Prescribed grade: DOT 4

Volume: 0.6 litres

Related information

- Brake and clutch fluid - level (p. 367)

Power steering fluid - grade

Power steering fluid is the denomination of the medium used in the car's power steering system.

Prescribed grade: Power steering fluid recommended by Volvo.

Related information

- Power steering fluid - level (p. 368)

Fuel tank - volume

Fuel tank volume for each respective engine alternative can be read in the table.

Engine	Volume (litres)	Prescribed grade
Petrol engine	approx. 70	Fuel - petrol (p. 304)
Diesel engine	approx. 70	Fuel - diesel (p. 304)

Vehicle gas tank (CNG) - applies to Bi-Fuel

Tank volume	approx. 17 kg
-------------	---------------

 NOTE

Filling stations may have different tank pressures, so fillable gas volume may differ from one refuelling to another.

Related information

- Filling up with fuel (p. 302)
- Engine specifications (p. 414)

11 Specifications

Specifications for air conditioning

Prescribed grades and volumes of fluids and lubricants in the air conditioning system can be read in the tables below.

A/C decal

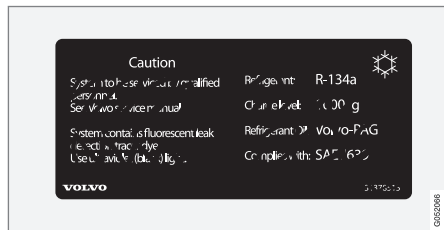

The label is fitted on the inside of the bonnet.

Refrigerant

Engine	Weight	Prescribed grade
5-cylinder diesel	720 g	R134a
other	800 g	

WARNING

The air conditioning system contains pressurised refrigerant R134a. This system must only be serviced and repaired by an authorised workshop.

Compressor oil

Engine	Volume	Prescribed grade
4-cylinder	60 ml	PAG SP-A2
5-cylinder	110 ml	PAG SP-10

Related information

- Climate control system - fault tracing and repair (p. 369)
- Type designations (p. 405)

Fuel consumption and CO2 emissions

Fuel consumption in a vehicle is measured in litres per 100 km and CO2 emissions in grams per km.

Explanation

CO ₂	gram/km
Fuel	litre/100 km

	Urban driving
	Extra-urban driving
	Combined driving

man	manual gearbox
aut	Automatic gearbox

NOTE
If the consumption and emission data is missing then it is included in the enclosed supplement.







NOTE
Not all engines are available in all markets.

V70 							
		CO ₂		CO ₂		CO ₂	
T4 (B4204T19)	man	-	-	-	-	-	-
T4 (B4204T19)	aut	-	-	-	-	-	-
T5 (B4204T11)	aut	211	9.0	125	5.4	156	6.7
D2 ^A (D4204T20)	man	-	-	-	-	-	-

11

11 Specifications



V70 							
		CO ₂		CO ₂		CO ₂	
D2 ^B (D4204T20)	man	-	-	-	-	-	-
D2 ^A (D4204T20)	aut	-	-	-	-	-	-
D2 ^B (D4204T20)	aut	-	-	-	-	-	-
D3 ^A (D4204T9)	man	-	-	-	-	-	-
D3 ^B (D4204T9)	man	-	-	-	-	-	-
D3 ^A (D4204T9)	aut	-	-	-	-	-	-
D3 ^B (D4204T9)	aut	-	-	-	-	-	-
D4 ^A (D4204T5)	man	-	-	-	-	-	-
D4 ^B (D4204T5)	man	121	4.7	102	3.9	109	4.2
D4 ^A (D4204T5)	aut	-	-	-	-	-	-

V70 							
		CO ₂		CO ₂		CO ₂	
D4 ^B (D4204T5)	aut	135	5.3	107	4.1	117	4.5
D4 AWD (D5244T12)	aut	189	7.1	137	5.2	156	5.9







A Does **not** apply to the low-emissions variant.

B This **only** applies to the low-emissions variant.

XC70 							
		CO ₂		CO ₂		CO ₂	
T5 (B4204T11)	aut	209	9.0	127	5.4	157	6.7
T5 (B5254T12)	aut	264	11.3	167	7.2	202	8.7
D4 (D4204T5)	man	126	4.8	108	4.1	115	4.4
D4 (D4204T5)	aut	146	5.6	116	4.4	127	4.8
D4 AWD (D5244T12)	man	-	-	-	-	-	-

11 Specifications



XC70 							
		CO ₂		CO ₂		CO ₂	
D4 AWD (D5244T12)	aut	180	6.9	137	5.2	153	5.8
D4 AWD (D5244T17)	man	-	-	-	-	-	-
D4 AWD (D5244T17)	aut	180	6.9	137	5.2	153	5.8
D5 AWD (D5244T20)	aut	180	6.9	137	5.2	153	5.8

Fuel consumption and emission values in the table above are based on specific EU cycles², that apply to cars with kerb weight in the basic version and without extra equipment. The car's weight may increase depending on equipment. This, as well as how heavily the car is loaded, increases fuel consumption and carbon dioxide emissions.

There are several reasons for increased fuel consumption compared with the table's values. Examples of this are:

- The driver's driving style.
- If the customer has specified wheels larger than those fitted as standard on the model's basic version, then resistance increases.
- High speed results in increased wind resistance.
- Fuel quality, road and traffic conditions, weather and the condition of the car.

Even a combination of the above-mentioned examples can result in significantly improved

consumption. For further information, please refer to the regulations referred to².

Large deviations in fuel consumption may arise in a comparison with the EU driving cycles² which are used in the certification of the car and on which the consumption figures in the table are based.

² Official fuel consumption figures are based on two standardised driving cycles in a laboratory environment ("EU driving cycles") all in accordance with EU Regulation no 692/2008 and 715/2007 (Euro 5 / Euro 6) and UN ECE Regulation no 101. The regulations cover the driving cycles for urban driving and extra-urban driving. - Urban driving - the measurement starts with cold starting the engine. The driving is simulated. - Extra-urban driving - the car is accelerated and braked at speeds between 0-120 km/h. The driving is simulated. - Cars with manual gearbox are started in 2nd gear (applies to cars with up to 18-inch wheels). The value for combined driving, which is reported in the table, is a combination of urban driving and extra-urban driving, in accordance with legal requirements. CO₂ emissions - the exhaust gases are collected in order to calculate the carbon dioxide emissions during the two driving cycles. These are then analysed and give the value for CO₂ emissions.

i NOTE

Extreme weather conditions, driving with a trailer or driving at high altitudes in combination with fuel grade are factors that could affect the car's performance.

CO2 emissions and fuel consumption (vehicle gas - CNG) - for Bi-Fuel

	aut
Methane gas gram CO ₂ /km	129
Biogas gram CO ₂ /km	41
Combined driving kg/100 km	4.5

CNG specifications

Type designation	Bi-Fuel
Output, CNG	Power output is the same as for petrol.
Emission level	Euro 6

i NOTE

- There are many different qualities of gas, as well as gases with lower energy content and range.
- The fuel consumption specified above applies for combined driving. During urban driving or fast motorway driving the consumption is higher and during calm extra-urban driving it is lower.

Related information

- Economical driving (p. 308)
- Weights (p. 410)

11 Specifications

Tyres - approved tyre pressures

Approved tyre pressures for each respective engine alternative can be read in the table.



NOTE

All engines, tyres or combinations of these are not always available in all markets.

V70 Engine	Tyre size	Speed (km/h)	Load, 1-3 persons		Max. load		ECO pressure ^A
			Front (kPa) ^B	Rear (kPa)	Front (kPa)	Rear (kPa)	Front/rear (kPa)
All engines	225/55 R 16	0 - 160	220	210	260	260	260
	225/50 R 17	160 +	260	260	270	270	-
	205/60 R 16	0 - 160	230	210	260	260	260
	235/40 R 18	160 +	270	270	290	290	-
	235/40 R 19						
Temporary Spare Tyre		max. 80	420	420	420	420	-

^A Economical driving.

^B In certain countries there is the "bar" unit beside the SI unit "Pascal": 1 bar = 100 kPa.



WARNING

19-inch wheels must **never** be used on V70 cars that are **not** equipped with the R-Design or Sport chassis options. The use of 19-inch wheels on cars with **standard chassis** constitutes a safety risk, with a risk of vehicle damage, and it impairs the car's driving characteristics.

XC70 Engine	Tyre size	Speed (km/h)	Load, 1-3 persons		Max. load		ECO pressure ^A
			Front (kPa) ^B	Rear (kPa)	Front (kPa)	Rear (kPa)	Front/rear (kPa)
All engines	215/65 R 16	0 - 160	230	230	260	260	260
	235/55 R 17						
	235/50 R 18 235/45 R 19	160 +	240	240	280	280	-
Temporary Spare Tyre		max. 80	420	420	420	420	-

^A Economical driving.

^B In certain countries there is the "bar" unit beside the SI unit "Pascal": 1 bar = 100 kPa.

Related information

- Tyres - dimensions (p. 325)
- Tyres - air pressure (p. 323)
- Type designations (p. 405)

A

ACC – Adaptive cruise control.....	205
Active Bending Lights (ABL).....	95
Active chassis - FOUR-C.....	195
Active main beam.....	93
Active Xenon headlamps.....	95
Active Yaw Control.....	196
Adapting driving characteristics.....	195
Adaptive Cruise Control.....	205
change cruise control functionality.....	214
deactivate.....	212
fault tracing.....	217
function.....	206
managing speed.....	209
overtaking.....	212
overview.....	208
radar sensor.....	215
setting the time interval.....	210
standby mode.....	211
temporary deactivation.....	211
Additional heater	
electric.....	151, 152
fuel-driven.....	151
Adjusting the steering wheel.....	86
Airbag	
activating/deactivating, PACOS.....	34
driver's side.....	32, 40
passenger side.....	33, 34, 40
AIRBAG	32, 33
Airbag system.....	31
warning symbol.....	30
Air cleaning	
material.....	133
passenger compartment....	131, 132, 133
Air conditioning.....	140
Air conditioning, fluid	
volume and grade.....	424
Air conditioning system	
repair.....	369
Air distribution.....	134
Recirculation.....	141
table.....	143
Air quality system IAQS.....	133
Alarm.....	190, 191, 192
alarm indicator.....	191
alarm signals.....	192
automatic re-arming.....	191
checking the alarm.....	173
reduced alarm level.....	192
remote control key not working.....	191
Alcohol lock.....	260

Allergy and asthma inducing substances.	132
All Wheel Drive, (AWD).....	279
All Wheel Drive (AWD).....	279
Approach lighting.....	99, 171
Automatic car washes.....	398
Automatic gearbox.....	273, 276
manual gear positions (Geartronic)....	273
towing and recovery.....	316
trailer.....	311
Automatic relocking.....	183
AWD, All Wheel Drive.....	279

B

Backrest.....	82
front seat, lowering.....	82
rear seat, folding.....	85
Bag holder	161
Battery.....	300, 378
jump starting.....	270
maintenance.....	378
overload.....	300
remote control key/PCC.....	177
symbols on the battery.....	380
warning symbols.....	380
Bi-fuel	
introduction.....	24

- Bi-Fuel
Switch..... 307
- BLIS..... 254, 255
- Bonnet, opening..... 360
- Book service and repair..... 355
- Booster seat
lowering..... 52
raising..... 51
seating position..... 50
- Brake and clutch fluid..... 367
- Brake fluid
grade and volume..... 422
- Brake light..... 96
- Brakes..... 292, 294
Anti-lock braking system, ABS..... 293
brake light..... 96
brake system..... 292, 293, 294
Emergency Brake Assistance, EBA ... 294
emergency brake lights..... 96
filling brake fluid..... 368
handbrake..... 295
symbols in the combined instrument
panel..... 293
- Bulbs, see Lighting..... 370
- C**
- Camera sensor..... 225, 236
- Car care..... 398
Leather upholstery..... 401
- Cargo area
cargo cover..... 165
lighting..... 98
mounting points..... 160
protective net..... 162
- Cargo cover..... 165
- Car key memory..... 168
- Car upholstery..... 401
- Car washing..... 398
- Catalytic converter..... 308
Recovery..... 317
- Chassis settings..... 195
- Checking the engine oil level..... 362
- Children
child safety locks..... 43
child seat and airbag..... 49
child seats and side airbags..... 37
location in car..... 49
safety..... 37, 43
- Child safety locks..... 188, 189
- Child seat
integrated two-stage booster seat..... 50
- Child seats..... 43
ISOFIX fixture system for child seats... 53
recommended..... 44
size classes for child seats with ISO-
FIX fixture system..... 53
types..... 55
upper mounting points for child seats.. 57
- City Safety™..... 223
- Cleaning
automatic car wash..... 398
car washing..... 398
rims..... 399
seatbelts..... 402
upholstery..... 401
- Clean Zone Interior Package (CZIP)..... 132
- Climate control
actual temperature..... 131
auto-regulation..... 139
general..... 130
personal preferences..... 133
sensors..... 131
temperature control..... 139
- Clock, adjustment..... 75
- CO₂ emissions..... 425
- Collision..... 41
- Collision warning..... 230, 231

Collision warning system			
function.....	231		
general limitations.....	235		
operation.....	234		
Pedestrian detection.....	233		
Radar sensor.....	215, 223		
Collision Warning System with Auto Brake.....	230		
Colour code, paint.....	403		
Combined instrument panel.....	65, 66		
Compass.....	110		
calibration.....	111		
Condensation in headlamps.....	398		
Controls, lights.....	88		
Control symbols.....	66, 68		
Coolant			
volume and grade.....	419		
Coolant, checking and filling.....	366		
Cooling system.....	299		
overheating.....	299		
Crash, see Collision.....	41		
Cruise control.....	203		
deactivate.....	205		
managing speed.....	203		
resume set speed.....	205		
temporary deactivation.....	204		
Cyclist detection.....	232		
CZIP (Clear Zone Interior Package).....	132		
D			
Daytime running lights.....	91		
Deadlock.....	187		
deactivation.....	187		
temporary deactivation.....	188		
Defroster.....	140		
Detachable towbar			
storage.....	312		
Diesel.....	304		
run out of fuel.....	305		
Diesel particle filter.....	306		
Dimensions.....	408		
Dipstick, electronic.....	363, 365		
Direction indicator.....	97		
Direction indicators.....	97		
direction of rotation.....	322		
Disengaging the gear selector inhibitor... ..	278		
Display lighting.....	90		
Distance Warning.....	220		
Limitations.....	221		
Symbols and messages.....	222		
Door mirrors.....	108		
Driveable punctured tyres.....	338		
Driver Alert Control.....	240		
operation.....	241		
Driver Alert System.....	240		
Driving.....	301		
cooling system.....	299		
with a trailer.....	309		
with the tailgate open.....	300		
Driving in water.....	299		
Driving with a trailer			
towball load.....	411		
towing capacity.....	411		
E			
ECC, electronic climate control.....	136		
Eco Cruise.....	290		
EcoGuide.....	69		
Ec labelling, FSC, owner's manual.....	24		
Economical driving.....	308		
ECO pressure.....	430		
Electrical socket.....	157		
cargo area.....	161		
Electrical system.....	384		
Electric parking brake			
low battery voltage.....	295		

- Electronic climate control - ECC..... 136
- Emergency equipment
 first aid kit..... 333
 warning triangle..... 331
- Emergency puncture repair..... 341, 342
 action..... 343
 inflating the tyres..... 346
 rechecking..... 345
- Emergency puncture repair kit
 location..... 342
 overview..... 343
 sealing fluid..... 347
- Emissions of carbon dioxide..... 425
- Engine
 deactivate..... 266
 overheating..... 299
 start..... 265
 Start/Stop..... 281
- Engine and passenger compartment heater
 messages..... 149
 timer..... 147
- Engine block heater..... 145
- Engine block heater and passenger compartment heater
 direct start..... 146
 immediate stop..... 147
- Engine braking, automatic..... 280
- Engine compartment
 coolant..... 366
 oil..... 362
 overview..... 360
 power steering fluid..... 368
- Engine oil..... 362, 416
 adverse driving conditions..... 416
 filter..... 362
 grade and volume..... 417
- Engine specifications..... 414
- Error messages
 Adaptive Cruise Control..... 218
 Driver Alert Control..... 242
 Lane Departure Warning..... 246
 see Messages and symbols..... 218, 297
- Error messages in BLIS..... 257
- ERS - Remote Start..... 267
- exhaust gases, toxic, sucked in..... 300
- External dimensions..... 408
- F**
- Fan
 ECC..... 139
- Fault tracing for the camera sensor..... 226
- First aid..... 333
- First aid kit..... 333
- Fluids, capacities..... 377, 419, 420, 422, 423, 424
- Fluids and oils..... 419, 420, 422, 424
- Fog lamp
 rear..... 95
- Foot brake..... 292, 293, 294
- FOUR-C - Active chassis..... 195
- FSC, ecolabelling..... 24
- Fuel..... 303, 304
 fuel consumption..... 425
 fuel economy..... 323, 324
 fuel filter..... 305
- Fuel-driven heater
 timer..... 147
- Fuelling
 CNG..... 306
 filling..... 302, 306
 fuel cap..... 302, 306
 fuel filler flap..... 302
 fuel filler flap, manual opening..... 302
- Fuel tank
 volume..... 423
- Fuse box..... 385
- Fuses..... 384
 cargo area..... 394
 changing..... 384
 cold zone..... 396

engine compartment.....	386
General.....	384
Start/Stop.....	396
under glovebox.....	390, 392

G

Gas tank	
capacity.....	423
Gearbox.....	271
automatic.....	273, 276
manual.....	271
Gear indicator.....	272
Gear selector inhibitor.....	278
Gear selector inhibitor, mechanical disen- gagement.....	278
Geartronic.....	273
Glass	
laminated/reinforced.....	24
Glovebox.....	156
locking.....	184
Gross vehicle weight.....	410
GSI - Gear selector assistance.....	272

H

Handbrake.....	295
Hazard warning flashers.....	96
HDC.....	280
Headlamp control.....	88
Headlamp levelling.....	90
Headlamp pattern, adjusting.....	100
Headlamp pattern adjustment.....	100
Active Bending Lights	100
Halogen headlamp.....	100
Headlamps.....	370
head restraint	
centre seat, rear.....	84
lowering.....	85, 86
Heated washer nozzles.....	105
Heating	
rearview and door mirrors.....	109
rear window.....	109
seats.....	137
steering wheel.....	88
windscreen.....	109
Heat-reflecting windscreen.....	19
High engine temperature.....	299
High-pressure headlamp washing.....	105
Hill Descent Control.....	280

Hill Start Assist.....	279
Home safe light duration.....	99
Horn.....	87

I

IAQS - Interior Air Quality System.....	133
Immobiliser.....	169
Indicator symbols.....	70
Inflatable curtain.....	37, 40
Information button, PCC.....	172, 173
Information display.....	65, 66
Inlaid mats.....	157
Instrument lighting, see Lighting.....	90
Instrument overview	
left-hand drive car.....	59
right-hand drive car.....	62
Instruments and controls.....	59, 62
Interior Air Quality System (IAQS)	
Air cleaning.....	133
Interior lighting, see Lighting.....	98
Interior rearview mirror.....	110
automatic dimming.....	110
Intermittent wiping.....	104

Internet-connected car
 book service and repair..... 355

J

Jack..... 333
 Journey statistics..... 128
 Jump starting..... 270

K

Kerb weight..... 410
 Key..... 167, 169
 Key blade..... 174, 175
 Keyless drive... 178, 179, 180, 181, 182, 265
 Keyless - locking..... 180
 Keyless start (keyless drive).... 178, 179,
 180, 181, 182, 265
 Keyless - unlocking..... 181
 Keypad in the steering wheel..... 87
 Key positions..... 80

L

Labels..... 405
 Laminated glass..... 24
 Lamps, see Lighting..... 369
 Lane assistance
 operation..... 244, 245
 Lane Departure Warning (LDW)..... 243, 244
 Laser sensor..... 227
 Leather upholstery, washing instructions 401
 Light indications, PCC..... 173
 Lighting..... 369
 Active Xenon headlamps..... 95
 approach lighting..... 99, 171
 automatic lighting, passenger compartment..... 98
 bulbs, specifications..... 375
 controls..... 98
 daytime running lights..... 91
 display lighting..... 90
 headlamp levelling..... 90
 home safe lighting..... 99
 instrument lighting..... 90
 in the passenger compartment..... 98
 main/dipped beam..... 92
 position/parking lamps..... 91
 rear fog lamp..... 95
 tunnel detection..... 92

Lighting, bulb replacement..... 370
 bulb holder, rear..... 373
 cargo area..... 374
 dipped beam (cars with halogen headlamps)..... 371
 direction indicators, front..... 372
 main beam (cars with active xenon headlamps)..... 372
 main beam (cars with halogen headlamps)..... 372
 number plate lighting..... 373
 vanity mirror..... 374

Loading

cargo area..... 158
 General..... 158
 long load..... 159
 mounting points..... 160
 roof load..... 160

Lock

locking..... 183
 unlocking..... 183

Lockable wheel bolts..... 327

Lock confirmation 169

Locking/unlocking

glovebox..... 184
 inside..... 183
 tailgate..... 185

M

Main/dipped beam, see Lighting.....	92
Main beam, automatic activation.....	93
maintenance	
Rustproofing.....	401
Manual gearbox.....	271
GSI - Gear selector assistance.....	272
Towing and recovery.....	316
trailer.....	311
Manual gear positions (Geartronic).....	273
Max. roof load.....	410
Memory function in seat.....	83
Menus	
Combined instrument panel.....	113
menu overview.....	114
Messages.....	116
Messages and symbols	
Adaptive Cruise Control.....	218
Collision Warning with Auto	
Brake.....	229, 238
Driver Alert Control.....	242
Engine block heater and passenger	
compartment heater.....	149
Lane Departure Warning.....	246
Messages in BLIS.....	257
Messages in the information display.....	115

Meters

fuel gauge.....	65, 67
speedometer.....	65, 67
tachometer.....	65, 67

misting

attending to the windows.....	130
-------------------------------	-----

Misting

condensation in headlamps.....	398
--------------------------------	-----

Mood lighting.....	99
--------------------	----

MY CAR.....	116
-------------	-----

O

Oil, see also Engine oil.....	416, 417
-------------------------------	----------

Oil level low.....	362
--------------------	-----

Output.....	414
-------------	-----

outside temperature gauge.....	74
--------------------------------	----

Overheating.....	299, 309
------------------	----------

Owner's manual, ecolabelling.....	24
-----------------------------------	----

P

PACOS.....	34
------------	----

Paddle on the steering wheel.....	87
-----------------------------------	----

Paintwork

colour code.....	403
damage and touch-up.....	402

Panel lighting.....	90
---------------------	----

Panic function.....	171
---------------------	-----

Park Assist.....	247, 249
------------------	----------

backward.....	248
---------------	-----

fault indicator.....	250
----------------------	-----

function.....	247
---------------	-----

parking assistance sensors.....	250
---------------------------------	-----

Park assist camera.....	251
-------------------------	-----

settings.....	253
---------------	-----

Parking brake.....	295
--------------------	-----

Passenger compartment filter.....	132
-----------------------------------	-----

Passenger compartment heater.....	145
-----------------------------------	-----

PCC – Personal Car Communicator

functions.....	170
----------------	-----

range.....	173, 178
------------	----------

Pedestrian detection.....	230
---------------------------	-----

Personal Car Communicator.....	173
--------------------------------	-----

Petrol grade.....	304
-------------------	-----

Pinch protection, sunroof.....	113
--------------------------------	-----

Polishing.....	399
----------------	-----

Position/parking lamps.....	91
-----------------------------	----

Power guide.....	69
------------------	----

Power operated tailgate.....	186
------------------------------	-----

Power seat..... 83

Powershift gearbox..... 276, 316

Power steering fluid
grade..... 422

Power sunroof..... 112

Power windows..... 106

Privacy locking..... 175

Protective grille..... 163

Protective net..... 163

Q

Queue Assist..... 212

Queue assistance..... 212

R

Radar sensor..... 206
Limitations..... 215

Rain sensor..... 104

Rear bulbs
location..... 373

Rear seat
Heating..... 137

Rearview and door mirrors
compass..... 110
door..... 108
electrically retractable..... 108
heating..... 109
interior..... 110

Rear window
heating..... 109

Recommendations during driving..... 301

Recommended child seats
table..... 44

Recovery..... 318

Refrigerant..... 369

Regeneration..... 306

Relay/fuse box, see Fuses..... 384

Remote control immobiliser..... 170

Remote control key..... 167, 168, 169
battery replacement..... 177
detachable key blade..... 174, 175
functions..... 170
loss..... 167
range..... 172, 178

Remote control key system, type approval..... 192

Remote Start - ERS..... 267

Resetting, trip meter..... 121, 125

Resetting the door mirrors..... 108

Resetting the power windows..... 107

Retractable power door mirrors..... 108

Reverse gear inhibitor..... 272

Road sign information..... 200
Limitations..... 202
operation..... 200

Roof load, max. weight..... 410

Rustproofing..... 401

S

Safety lock
children..... 43

Safety mode..... 41
moving the car..... 43
start attempt..... 42

Sealing fluid..... 347

Seat, see Seats..... 82

Seatbelt..... 27
loosen..... 28
pregnancy..... 29
putting on..... 28
rear seat..... 29
seatbelt reminder..... 29
seatbelt tensioner..... 30

Seatbelt reminder..... 29

- Seatbelt tensioner..... 30, 40
- Seats..... 82
- head restraints, rear..... 84
 - heating..... 137
 - Heating..... 137
 - lowering the front backrest..... 82
 - lowering the rear backrest..... 85
 - power..... 83
 - ventilated front seats..... 138
- Securing loads (Loading)..... 160
- Self Supporting run flat Tyres (SST)..... 338
- Sensus..... 79
- Service position..... 375
- Service programme..... 355
- Set time interval..... 220
- Side airbag SIPS..... 36, 40
- SIPS airbag..... 36
- Skidding..... 301
- slippery driving conditions..... 301
- Soot filter..... 306
- SOOT FILTER FULL..... 306
- spare wheel..... 328
- installation..... 330
- Speed ratings, tyres..... 326
- Spin control..... 196
- Stability and traction control system 196,
- operation..... 196
- Stability system..... 196
- Stains..... 401
- Start/Stop..... 281
- function and operation..... 282
 - the engine does not stop..... 283
- Steering force, speed related..... 195
- Steering force level, see Steering force... 195
- Steering lock..... 266
- Steering wheel..... 86
- heating..... 88
 - keypad..... 87
 - paddle..... 87
 - steering wheel adjustment..... 86
- Stone chips and scratches..... 402
- Storage spaces
- glovebox..... 156
 - tunnel console..... 156
- Storage spaces in the passenger compartment..... 154
- Sunroof
- opening and closing..... 112
 - pinch protection..... 113
 - sunscreen..... 113
 - ventilation position..... 112
- Sunscreen, sunroof..... 113
- Switching off the engine..... 266
- Symbols
- indicator symbols..... 66, 68, 70
 - warning symbols..... 66, 68
- Symbols and messages
- Adaptive Cruise Control..... 218
 - Collision Warning with Auto Brake..... 229, 238
 - Driver Alert Control..... 242
 - Lane Departure Warning..... 246
- System
- tripping..... 40
- ## T
-
- Tailgate..... 186
- close..... 186
 - Locking/unlocking..... 185
 - Open..... 186
 - power..... 186
- Temperature
- actual temperature..... 131
- Temperature control..... 139
- TM - Tyre Monitor..... 339
- Tools..... 332
- Total airing function..... 130, 184

- Towbar
 detachable, attachment..... 314
 detachable, removal..... 315
- Towbar, see Towing equipment..... 312
- Towbar - detachable
 attachment/removal..... 314, 315
- Towing..... 316
 towing eye..... 317
- Towing bracket..... 312
 specifications..... 313
- Towing capacity and towball load..... 411
- Towing eye..... 317
- TPMS - Tyre Pressure Monitoring.... 334,
 335, 336
- Traction control..... 196
- Trailer..... 309
 cable..... 309, 310
 driving with a trailer..... 309
- Transmission..... 271
- Transmission oil
 volume and grade..... 420
- Transponder..... 19
- Tread depth..... 327
- Tread wear indicators..... 323
- Trip computer..... 117, 119, 123, 127, 128
- Trip meter..... 74
- Trip meter, resetting..... 121, 125
- Troubleshooting
 Adaptive Cruise Control..... 217
- Tunnel console..... 156
 12 V socket..... 157
 cigarette lighter and ashtray..... 156
- Tunnel detection..... 92
- Type approval
 radar system..... 258
 remote control key system..... 192
 tyre pressure monitoring..... 348
- Type designations..... 405
- Tyre dimension..... 325
- Tyre load index..... 326
- Tyre pressure label..... 323
- Tyre pressure monitoring. 334, 335, 336, 339
 Adjust..... 336
 arming..... 337
 deactivate..... 337
 driveable punctured tyres (SST)..... 338
 low tyre pressure..... 339
 recommendations..... 338
- Tyres
 direction of rotation..... 322
 maintenance..... 321
 pressure..... 323, 430
 puncture repair..... 341
 specifications..... 430
- tread depth..... 327
- tread wear indicators..... 323
- tyre pressure monitoring..... 334, 335,
 336, 339
- winter tyres..... 327

U

- Unlocking
 from the inside..... 183
 from the outside..... 183
- Unlocking with the key blade..... 181

V

- Vanity mirror..... 98, 157
- Vehicle gas..... 75, 357
- Vehicle gas tank (CNG)
 capacity..... 423
- Ventilation..... 134
- Vibration damper..... 312
- Volvo ID..... 21
- Volvo Sensus..... 79

W

Warning lamp

Adaptive Cruise Control.....	206
collision warning system.....	234
stability and traction control system..	196

Warning lamps

Airbags – SRS.....	72
alternator not charging.....	72
Fault in brake system.....	72
Low oil pressure.....	72
Parking brake applied.....	72
seatbelt reminder.....	29, 72
Warning.....	72

Warning sound

collision warning system.....	234
-------------------------------	-----

Warning symbols..... 66, 68, 72

Warning triangle..... 331

Washer fluid..... 377

Washer nozzles, heated..... 105

Washers

rear window.....	105
washer fluid, filling.....	377
windscreen.....	105

Water and dirt-repellent coating..... 400

Water-repellent surface, cleaning..... 400

Waxing..... 399

Weights

kerb weight.....	410
------------------	-----

Wheel bolts..... 327

lockable.....	327
---------------	-----

Wheel rim, dimensions..... 325

Wheel rims

cleaning.....	399
---------------	-----

Wheels

installation.....	330
removal.....	328
snow chains.....	327

Whiplash injury, WHIPS..... 38

WHIPS

child seat/booster cushion.....	39
seating position.....	39
whiplash protection.....	38, 40

Windows, rearview and door mirrors..... 400

Windscreen

heating.....	109, 140
--------------	----------

Windscreen washing..... 105

Windscreen wiper..... 104

rain sensor.....	104
------------------	-----

Winter driving..... 301

Winter tyres..... 327

Wiper blades..... 375

changing.....	376
---------------	-----

Cleaning.....	377
---------------	-----

replacing, rear window.....	377
-----------------------------	-----

Service position.....	375
-----------------------	-----

Wipers and washing..... 104

