



V90

OWNER'S MANUAL



# VÄLKOMMEN!

We hope you will enjoy many years of driving pleasure in your Volvo. The car has been designed for the safety and comfort of you and your passengers. Volvo is one of the world's safest passenger vehicles. Your Volvo is also designed to meet applicable safety and environmental requirements.

In order to increase your enjoyment of your Volvo, we recommend that you read the instructions and maintenance information in this owner's manual. The owner's manual is also available as a mobile app (Volvo Manual) and on the Volvo Cars support site ([support.volvocars.com](https://support.volvocars.com)).

# TABLE OF CONTENTS

## INTRODUCTION

This is how you find owner's information	14
Digital owner's manual in the car	15
Navigating in the digital owner's manual	16
Owner's Manual in mobile devices	18
Volvo Cars support site	19
Reading the owner's manual	19
Recording data	22
Important information on accessories, extra equipment and diagnostic socket	23
Volvo ID	23
Drive-E - cleaner driving pleasure	25
IntelliSafe-driver support	28
Sensus - connection and maintenance	29
The owner's manual and the environment	32
Windows, glass and mirrors	32
Overview of the centre display	33
Operating the centre display	36
Navigating in the centre display's views	40
Symbols in the centre display's status bar	45
Change settings for the centre display	45
Function view with buttons for car functions	47
Using the keyboard in the centre display	49
Writing characters/letters by hand on the screen	53

Introduction to vehicle gas (Bi-Fuel)*	54
--	----

## SAFETY

Safety	56
Safety during pregnancy	56
Whiplash Protection System	57
Pedestrian Protection System	58
Seatbelt	59
Seatbelt tensioner	59
Fastening/unfastening a seatbelt	60
Door and seatbelt reminder	62
Airbags	63
Driver and passenger airbags	64
Activating/deactivating the passenger airbag*	66
Side airbag	68
Inflatable curtain	69
Safety mode	69
Starting/moving the car after safety mode	70
Child safety	71
Child seats	71
Upper mounting points for child seats	73
Lower mounting points for child seats	74
Table for location of child seats using the car's seatbelts	75
i-Size/ISOFIX mounting points	77
Table for location of ISOFIX child seats	78



	<b>INSTRUMENTS AND CONTROLS</b>				
Table for location of i-Size child seats	81	Instruments and controls, left-hand drive car	86	Voice recognition control of radio and media	118
Integrated booster cushion*	82	Instruments and controls, right-hand drive car	87	Voice recognition control of climate control	119
Folding up the integrated booster cushion*	82	Driver display	90	Voice recognition and map navigation	120
Folding down the integrated booster cushion*	84	Driver display settings	94	Manual front seat	121
		Indicator symbols in the driver display	95	Power front seat*	121
		Warning symbols in the driver display	97	Adjusting the power front seat*	122
		Outside temperature gauge	98	Using the memory function in the power front seat*	122
		Clock	99	Multi-functional front seat*	123
		Fuel gauge for vehicle gas*	99	Adjusting functions in the multi-functional front seat*	124
		License agreement for the driver display	100	Adjusting the passenger seat from the driver's seat*	127
		Application menu in the driver display	105	Rear seat	128
		Using the application menu in the driver display	106	Adjusting the head restraints in the rear seat	128
		Messages in the driver display and the centre display	107	Lowering the backrests in the rear seat	130
		Managing messages in the driver display and the centre display	109	Steering wheel	131
		Managing messages saved from the driver display and centre display	110	Adjusting the steering wheel	132
		Head-up display*	112	Headlamp control	134
		Voice recognition	115	Headlamp levelling	135
		Using voice recognition	116	Position lamps	136
		Settings for voice recognition	117	Daytime running lights	137
		Voice recognition control of the phone	118	Dipped beam	137

Activating/deactivating main beam	138
Active bending lights*	141
Adapting the beam pattern from the headlamps	141
Front fog lamps/cornering lights*	142
Rear fog lamp	142
Brake lights	143
Hazard warning flashers	143
Using direction indicators	144
Passenger compartment lighting	145
Home safe light duration	148
Approach light duration	148
Using windscreen wipers	148
Activating/deactivating the rain sensor	149
Windscreen and headlamp washers	150
Rear window wiper and washer	151
Power windows	151
Operating power windows	152
Using the sun blind*	153
Adjusting the door mirrors	153
Interior rearview mirror	155
Compass*	156
Calibrating the compass*	157
Panorama roof*	158

Operating the panorama roof*	159
HomeLink®*	162
Programming HomeLink®*	163
Trip computer	165
Show trip data in the driver display	166
Show trip statistics in the centre display	168
Settings view	169
Categories in the settings view	170
Changing system settings in the settings view	172
Resetting settings in the settings view	173
Driver profiles	173
Selecting driver profile	174
Editing a driver profile	175
Linking remote control key to driver profile	176
Importing/exporting a driver profile from/to USB	177
Changing settings for apps	178
Resetting user data for change of ownership	178

## CLIMATE CONTROL

Climate control	180
Climate control - sensors	181
Perceived temperature	181
Air quality	182
Passenger compartment filter	183
Clean Zone Interior Package*	183
Interior Air Quality System*	183
Climate controls	184
Climate controls in the centre display	185
Climate controls at the rear of the tunnel console*	186
Auto-regulating the climate	187
Activating/deactivating air conditioning	188
Regulating the temperature	188
Regulating the fan level	191
Activating/deactivating defrost of windows and door mirrors	192
Activating/deactivating air recirculation	194
Air distribution	195
Changing the air distribution	196
Opening/closing and aiming the air vents	197
Table of air distribution options	199
Activating/deactivating heating of the seats*	201
Activating/deactivating ventilation of the seats*	202

Activating/deactivating heating of steering wheel*	203
Parking climate*	204
Starting/stopping preconditioning*	205
Timer for preconditioning*	206
Setting the timer for preconditioning*	206
Activating/deactivating the timer for preconditioning*	208
Starting/switching off climate comfort retention*	208
Symbols and messages for parking climate control*	210
Heater*	211
Parking heater*	212
Additional heater*	213

## LOADING AND STORAGE

Passenger compartment interior	216
Tunnel console	217
Electrical sockets	218
Using the cigarette lighter*	222
Emptying ashtrays*	222
Using the glovebox	223
Sun visors	224
Cargo area	224
Loading	225
Load retaining eyelets	226
Bag hooks	226
Through-load hatch in the rear seat	227
Cargo cover*	228
Safety net*	230
Safety grille*	232

## LOCKS AND ALARM

Remote control key	234
Remote control key range	236
Red Key - Restricted remote control key*	237
Antenna locations for the start and lock system	238
Locking/unlocking from the outside	239
Indication on locking/unlocking the car	241
Locking/unlocking from the inside	243
Deadlocks*	244
Locking/unlocking the tailgate	245
Using private locking	247
Detachable key blade	248
Locking/unlocking with the detachable key blade	249
Power operated tailgate*	251
Opening/closing the tailgate with foot movement*	254
Replacing the battery in the remote control key	255
Immobiliser	258
Child safety locks	259
Alarm*	260
Automatic arming/rearming of the alarm*	262
Disarming the alarm* without working remote control key	262

Type approval for the remote control key system 263

## DRIVER SUPPORT

Speed-dependent steering force	270	Limitations of Distance Warning*	288
Roll Stability Control	270	Adaptive cruise control*	288
Electronic stability control	271	Activating and starting the adaptive cruise control*	292
Sport mode for electronic stability control	272	Managing the speed of the adaptive cruise control*	293
Symbols and messages for electronic stability control	273	Setting the time interval for the adaptive cruise control*	294
Speed limiter*	275	Deactivating/activating the adaptive cruise control*	295
Activating and starting the speed limiter	276	Overtaking assistance with the adaptive cruise control* or Pilot Assist*	296
Managing speed for the speed limiter	276	Change of target and automatic braking with the Adaptive Cruise Control	297
Deactivating/reactivating the speed limiter	277	Limitations of the adaptive cruise control*	298
Switching off the speed limiter	278	Change between Cruise control and adaptive cruise control*	299
Automatic speed limiter*	279	Symbols and messages for the adaptive cruise control*	300
Activating/deactivating the automatic speed limiter	280	Pilot Assist*	302
Changing the tolerance for the Automatic speed limiter	281	Activating and starting the Pilot Assist*	305
Cruise control	282	Managing the speed for Pilot Assist*	307
Activating and starting the Cruise control	282	Setting the time interval for Pilot Assist*	308
Managing speed for the Cruise control	283	Deactivating/activating the Pilot Assist*	309
Deactivating/reactivating the cruise control	284	Change of target and automatic braking with Pilot Assist*	311
Deactivating Cruise Control	285	Limitations of Pilot Assist*	312
Distance Warning*	286		
Activating and setting the time interval for Distance warning*	287		

Symbols and messages for Pilot Assist*	314	Road Sign Information*	346	Park Assist Pilot*	372
Radar unit	316	Sign display with Road Sign Information	346	Parking with Active parking assistance*	374
Limitations of the radar unit	317	Speed camera information*	348	Limitations of Park Assist Pilot*	377
Type approval for radar units	321	Activating/deactivating Road Sign Information	349	Messages for Park Assist Pilot*	379
Camera unit	324	Limitations of Road Sign Information*	350		
Limitations of the camera unit	325	Driver Alert Control	350		
City Safety	328	Activate/deactivate Driver Alert Control	351		
Setting the warning distance for City Safety	330	Limitations of Driver Alert Control	352		
Detection of obstacles with City Safety™	331	Lane Keeping Aid	352		
City Safety in cross traffic	333	Activate/deactivate Lane Keeping Aid	354		
City Safety when evasive manoeuvres are prevented	334	Symbols and messages for lane assistance	356		
Limitations of City Safety	335	Run-off Mitigation	358		
Messages for City Safety	337	Symbols and messages for Run-off Mitigation	360		
Rear Collision Warning	338	Park Assist*	361		
Blind Spot Information*	338	Activating/deactivating Parking assistance*	363		
Activate/deactivate Blind Spot Information*	340	Limitations of Parking assistance*	363		
Limitations of Blind Spot Information*	341	Messages for Park Assist*	365		
Cross Traffic Alert*	341	Park Assist Camera*	366		
Activate/deactivate Cross Traffic Alert*	342	Park assist lines and fields for the Park Assist Camera*	368		
Limitations of Cross Traffic Alert	343	Starting the Park Assist Camera*	370		
Messages for Blind Spot Information* and Cross Traffic Alert*	345	Limitations of the Park Assist Camera*	371		

## STARTING AND DRIVING

Alcohol lock*	382	Emergency brake lights	406	Towing bracket*	422
Bypass of the alcohol lock*	382	Brake assistance	406	Extendable/retractable towing brackets*	423
Before starting the engine with the alcohol lock	382	Auto braking after a collision	406	Towing bracket specifications*	425
Ignition positions	383	Parking brake	407	Driving with a trailer	426
Starting the car	384	Using the parking brake	408	Driving with a trailer under special conditions	428
Switching off the car	385	In the event of a fault in the parking brake	409	Trailer Stability Assist*	428
Steering lock	386	Hill start assist	410	Towing eye	430
Using jump starting with another battery	386	Automatic braking when stationary	410	Towing	431
Gearbox	387	Driving in water	411	Recovering the car	432
Gear positions for automatic gearbox	388	Overheating in the engine and drive system	412		
Manual gearbox	390	Overloading the starter battery	413		
Gear shift indicator*	390	Preparations for a long trip	413		
Gear selector inhibitor	392	Winter driving	414		
Changing gear with steering wheel paddles*	393	Opening/closing the fuel filler flap and refuelling	415		
Start/Stop	394	Filling vehicle gas*	416		
Using the Start/Stop function	394	Button for gas operation*	417		
Conditions for the Start/Stop function	396	Handling of fuel	418		
Drive modes*	398	Petrol	418		
Drive mode ECO	400	Diesel	419		
Level control* and shock absorption	403	Empty tank and diesel engine	420		
All-wheel drive*	403	Diesel particulate filter	421		
Brake functions	404	Economical driving	422		
Foot brake	404				

## AUDIO AND MEDIA

Audio and media	434	Using Apple CarPlay*	451	Terms and conditions for services and Customer Privacy Policy	480
Apps	434	Settings for Apple CarPlay*	452		
Audio settings	435	Android Auto*	453		
Radio	436	Settings for Android Auto*	454		
Changing and searching radio stations	436	Technical specifications for media	455		
RDS radio	439	Phone	456		
Digital radio	440	Connect phone	457		
Linking between different radio bands FM and DAB	440	Connecting/disconnecting the phone	458		
Settings for radio	441	Managing phone calls	459		
Media player	442	Managing text messages	461		
Media playback	443	Managing the phone book	462		
Gracenote®	445	Settings for phone	462		
Searching media	446	Settings for text messages	463		
CD player*	446	Bluetooth settings	463		
Media via Bluetooth	447	Online car*	463		
Connecting media via Bluetooth	447	Connecting the car	464		
Media via AUX/USB input	447	Sharing Internet via Wi-Fi hotspot	465		
Connecting media via AUX/USB input video	448	No or poor connection	466		
Audio settings for media	448	Remove Wi-Fi network	467		
TV*	449	Wi-Fi technologies and security	467		
Using the TV*	449	Settings for car modem*	468		
Apple CarPlay*	450	Downloading, updating and uninstalling apps	468		
		License agreement for audio and media	470		

## WHEELS AND TYRES

Tyres	482
Tyres' rotation direction	483
Tread wear indicators on the tyres	484
Checking the tyre pressures	484
Tyre monitoring*	485
Checking tyre pressure with the tyre monitoring system*	487
Rectifying low tyre pressure with tyre monitoring*	488
Calibrating tyre monitoring*	489
Emergency puncture repair kit	490
Using the emergency puncture repair kit	491
Inflate tyres with the compressor from the emergency puncture repair kit	494
When changing wheels	495
Removing a wheel	495
Fitting the wheels	497
Wheel bolts	498
Spare wheel*	498
Winter wheels	499
Tool kit	500
Warning triangle	500
Jack*	501
First aid kit	502
Dimension designation for wheel rim	502

Dimension designation for tyre 502

## MAINTENANCE AND SERVICE

Volvo service programme	506
Car status	506
Book service and repair	506
Inspection and service of the system for vehicle gas*	509
Remote updates	509
System updates	510
Data transmission between car and workshop	511
Raise the car	512
Opening and closing the bonnet	514
Engine compartment overview	515
Engine oil	516
Checking and filling with engine oil	517
Topping up coolant	518
Servicing the climate control system	520
Bulb replacement	520
Replacing the dipped beam bulb	522
Replacing the main beam lamp	523
Replacing daytime running light bulb/position lamp bulb, front	524
Replacing the front direction indicator bulb	524
Replacing the reversing lamp bulb	525
Replacing the rear fog lamp bulb	526
Bulb specifications	526



Wiper blades in service position	527
Replacing a wiper blade	528
Filling washer fluid	529
Starter battery	530
Symbols on the batteries	533
Support battery	533
Fuses	535
Replacing a fuse	536
Fuses in engine compartment	537
Fuses under glovebox	542
Fuses in cargo area	546
Cleaning the exterior	549
Polishing and waxing	551
Rustproofing	552
Cleaning the interior	552
Cleaning the centre display	553
Paint damage	554
Repairing paint damage	555

## SPECIFICATIONS

Type designations	558
Dimensions	561
Weights	563
Towing capacity and towball load	564
Engine specifications	566
Engine oil — specifications	567
Adverse driving conditions for engine oil	569
Coolant — specifications	570
Transmission fluid — specifications	570
Brake fluid — specifications	570
Fuel tank - volume	571
Air conditioning — specifications	571
Fuel consumption and CO2 emissions	573
Approved wheel and tyre sizes	576
Load index and speed rating	577
Approved tyre pressures	578

## ALPHABETICAL INDEX

Alphabetical Index	579
--------------------	-----



# INTRODUCTION

## This is how you find owner's information

Owner's information is available in several different product formats, both digital and printed. The owner's manual is available in the car's centre display, as a mobile app and on the Volvo Cars support site. There is a Quick Guide and a supplement to the owner's manual available in the glovebox, with specifications and fuse information, amongst other things. A printed owner's manual can be ordered.

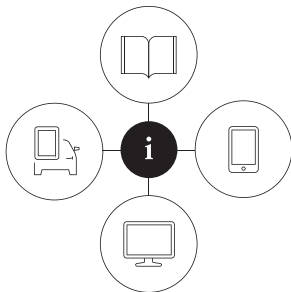

©2020

### The car's centre display<sup>1</sup>



In the centre display, drag down the top view and tap on **Owner's manual**. Available here are options for visual navigation with exterior and interior images of the car. The information is searchable and is also

divided into categories.

### Mobile app

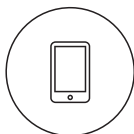

In App Store or Google Play, search for "Volvo Manual", download the app to your smartphone or tablet and select the car. Available in the app are video tutorials and options for visual navigation with exterior and interior images of the car. It is easy to navigate between the different sections in the owner's manual and the content is searchable.

### Volvo Cars support site



Go to [support.volvocars.com](http://support.volvocars.com) and select your country. Here you can find owner's manuals, both online and in PDF format. On the Volvo Cars support site there are also video tutorials and further information and

help regarding your Volvo and your car ownership. The page is available for most markets.

### Printed information



There is a supplement to the owner's manual<sup>1</sup> in the glovebox that contains information on fuses and specifications, as well as a summary of important and practical information.

There is also a Quick Guide available in printed format that helps you to get started with the most commonly used functions in the car.

Depending on equipment level selected, market, etc. additional owner's information may also be available in printed format in the car.

A printed owner's manual and associated supplement can be ordered. Contact a Volvo dealer to order.

### Changing the language in the car's centre display

Changing the language in the centre display may mean that some owner's information does not correspond to national or local laws and regulations. Don't change to a language that's difficult to understand, it may then be difficult to find your way back in the structure on the screen.

<sup>1</sup> A complete printed manual is included with the car for markets without owner's manual in the centre display.

**! IMPORTANT**

The driver is always responsible that the vehicle is driven safely in traffic and that applicable laws and regulations are followed. It is also important that the car is maintained and handled in accordance with Volvo's recommendations in the owner's information.

If there should be a difference between the information in the centre display and the printed information then it is always the printed information that applies.

**Related information**

- Digital owner's manual in the car (p. 15)
- Owner's Manual in mobile devices (p. 18)
- Volvo Cars support site (p. 19)
- Reading the owner's manual (p. 19)

**Digital owner's manual in the car**

A digital<sup>2</sup> version of the owner's manual is available in the car's centre display.

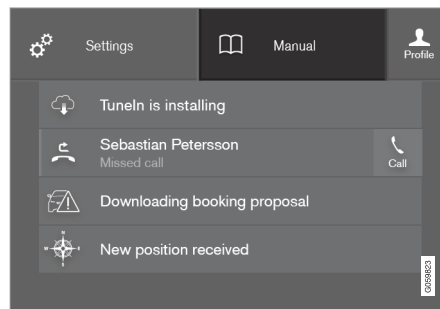

The digital owner's manual is accessed from the top view.

To open the digital owner's manual - drag down the top view in the centre display and tap on **Owner's manual**.

**i NOTE**

The digital owner's manual is not available while driving.

There is a range of different options for finding information in the digital owner's manual. The options can be reached from the start page of



the owner's manual. One way is from the top menu, with a tap on ☰.

**Symbols and their meaning in the owner's manual menu**

	<p>Leads to the start page of the Owner's Manual.</p>
	<p>Articles grouped by category. The same article may appear in several categories.</p>
	<p>Leads to a Quick Guide page with links for a selection of articles that can be particularly useful to read. Provides answers to common questions about the car.</p>

<sup>2</sup> Applies for most markets.

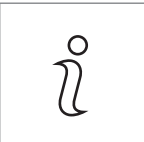

Symbols and their meaning in the owner's manual menu	
	Exterior and interior overview images of the car. Different parts are designated with hotspots that lead to articles about those parts of the car.
	
	All articles that have been favoured are compiled here.

Symbols and their meaning in the owner's manual menu	
	Leads to short video tutorials for different functions in the car.
	Indicates what version of the Owner's Manual is available in the car and provides other useful information.

**Related information**

- Navigating in the digital owner's manual (p. 16)

**Navigating in the digital owner's manual**

The digital owner's manual can be accessed from the centre display in the car. The content is searchable and it is easy to navigate between different sections.

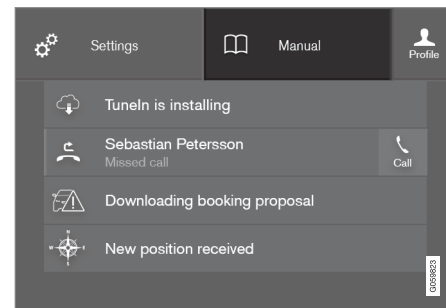

The digital owner's manual is accessed from the top view.

**Open the digital owner's manual**



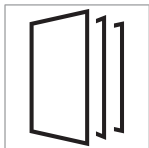

- To open the digital owner's manual - drag down the top view in the centre display and tap on **Owner's manual**.

There is a range of different options for finding information in the digital owner's manual. To access the owner's manual menu – press  in the upper bar of the owner's manual.

## Searching using categories



The articles in the owner's manual are structured into main categories and subcategories. The same article can be found in several appropriate categories in order to be found more easily.

1. Press  and then select **Categories**.
  - > The main categories are shown in a list.
2. Tap on a main category ().
  - > A list of subcategories () and articles () is shown.
3. Tap on an article to open it. To go back, press the back arrow.

## Hotspots for exterior and interior



Exterior and interior overview images of the car. Different parts are designated with hotspots that lead to articles about those parts of the car.



1. Press  and then select **Exterior/Interior**.
  - > Exterior/interior images are shown with so-called hotspots in place. The hotspot leads to articles about the corresponding part of the car. Swipe horizontally over the screen to browse among the images.
2. Tap on a hotspot.
  - > The title of the article about the area is shown.
3. Tap on the title to open the article. To go back, press the back arrow.

## Learn about the car's most common functions with the Quick Guide



Leads to a page with links for a selection of articles that can be particularly useful to read in order to get to know the most common functions of the car. The articles can also be accessed via categories, but are collected here for quick access. Tap on an article in order to read it in its entirety.

## Favourites



Located here are the articles that have been saved as favourites. Tap on an article in order to read it in its entirety.

## Saving/deleting articles as favourites

Save an article as favourite by pressing  at the top right when an article is open. When an article has been saved as a favourite the star is filled in:



To remove an article as a favourite, press the star again in the current article.

## Video

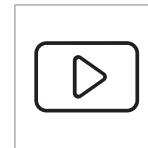

Leads to short video tutorials for different functions in the car.

## Information

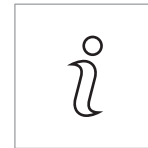

Tap on the symbol to obtain information about which version of the owner's manual is available in the car as well as other useful information.

« **Start page**



Tap on the symbol to go back to the start page in the owner's manual.

**Using the search function**

1. Tap on **Q** in the top menu of the owner's manual. A keyboard appears in the lower part of the screen.
2. Type in a keyword, such as "seatbelt".
  - > Suggestions for articles and categories are shown while letters are being entered.
3. Tap on the article/category to access it.

**Related information**

- Digital owner's manual in the car (p. 15)
- Using the keyboard in the centre display (p. 49)

**Owner's Manual in mobile devices**

The owner's manual is available as a mobile app from both the App Store and Google Play. The app is adapted for smartphones and tablets.



The owner's manual can be downloaded as a mobile app from the App Store or Google Play. The QR code provided here takes you directly to the app. Alternatively, you can search for "Volvo manual" in the App Store or Google Play.

The app contains a video along with exterior and interior images where different parts of the car are highlighted with so-called hotspots, which lead to articles about the area in question. It is easy to navigate between the different sections in the owner's manual and the content is searchable.

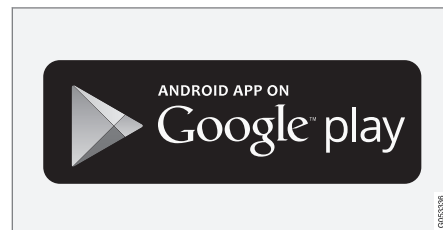
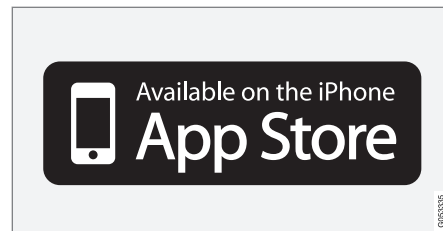

The mobile app is available from both the App Store and Google Play.

**Related information**

- Reading the owner's manual (p. 19)
- Volvo Cars support site (p. 19)



## Volvo Cars support site

More information on your car is available on the Volvo Cars website and support site. There you can navigate through to My Volvo<sup>3</sup>, a personal web page for you and your car.

### Support on the Internet

Go to support.volvocars.com to visit the site. The support site is available for most markets.

It contains support for functions such as web-based services and functions, Volvo On Call\*, the navigation system\* and apps. Videos and step-by-step instructions explain different procedures, e.g. how to connect the car to the Internet via a mobile phone.

### Downloadable information

#### Maps

For cars equipped with Sensus Navigation, there is the facility to download maps from the support page.

#### Owner's manuals as PDF

Owner's manuals are available for download in PDF format. Select car model and model year to download the manual as required.

### Contact

The support site contains contact details to customer support and your nearest Volvo dealer.

## My Volvo on the Internet<sup>3</sup>

From www.volvocars.com it is possible to navigate through to My Volvo Web which is a personal Web page for you and your car.

Create a personal Volvo ID, log in to My Volvo Web and get an overview of service, agreements and warranties, amongst other things. At My Volvo Web there is also information about accessories and software adapted for your car model.

### Related information

- Volvo ID (p. 23)

## Reading the owner's manual

A good way of getting to know your new car is to read the owner's manual, ideally before your first journey.

Reading the owner's manual is a good way to become familiar with new functions, get advice on how best to handle the car in different situations and learn how to make the best use of all the car's features. Please pay attention to the safety instructions contained in the owner's manual.

Development work is constantly underway in order to improve our product. Modifications may mean that information, descriptions and illustrations in the owner's manual differ from the equipment in the car. We reserve the right to make modifications without prior notice.

Do not remove this manual from the car - if problems should arise then the necessary information about where and how to seek professional help will be missing.

© Volvo Car Corporation

### Options/accessories

In addition to standard equipment, the owner's manual also describes options (factory fitted equipment) and certain accessories (retrofitted extra equipment).

<sup>3</sup> Applies to certain markets.



## INTRODUCTION

- ◀ All types of option/accessory are marked with an asterisk: \*.

The equipment described in the owner's manual is not available in all cars - they have different equipment depending on adaptations for the needs of different markets and national or local laws and regulations.

In the event of uncertainty over what is standard or an option/accessory, contact a Volvo dealer.

### Special texts

#### **WARNING**

Warning texts appear if there is a risk of injury.

#### **IMPORTANT**

"Important" texts appear if there is a risk of damage.

#### **NOTE**

NOTE texts give advice or tips that facilitate the use of e.g. features and functions.

### Footnote

The owner's manual contains information in certain locations in the form of a footnote at the bottom of the page or at the end of a table. This information is an addition to the text that it refers

to via a number. If the footnote refers to text in a table then letters are used instead of numbers for referral.

### Message texts

There are displays in the car that show menu and message texts. In the owner's manual the appearance of these texts differs from the normal text. Examples of menu texts and message texts: **Phone, New message.**

### Decals

The car contains different types of decal which are designed to convey important information in a simple and clear manner. The decals in the car have the following descending degree of importance for the warning/information.

### Warning of personal injury

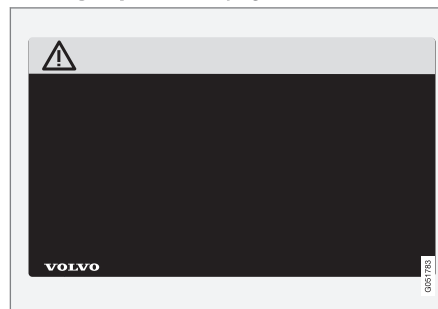

Black ISO symbols on yellow warning field, white text/image on black message field. Used to indi-

cate the presence of danger which, if the warning is ignored, may result in serious personal injury or fatality.

### Risk of property damage



White ISO symbols and white text/image on black or blue warning field and message field. Used to indicate the presence of danger which, if the warning is ignored, may result in damage to property.

## Information

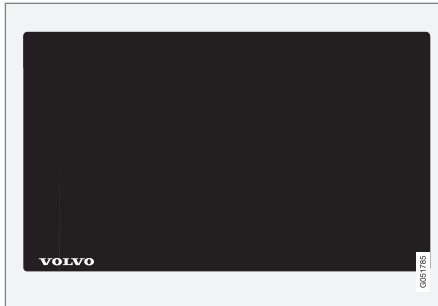

White ISO symbols and white text/image on black message field.

### **i** NOTE

It is not intended that the decals illustrated in the owner's manual should be exact replicas of those in the car. They are included to show their approximate appearance and location in the car. The information that applies to your particular car is available on the respective decals for your car.

## Procedure lists

Procedures where action must be taken in a certain sequence are numbered in the owner's manual:

- 1 When there is a series of illustrations for step-by-step instructions each step is num-

bered in the same way as the corresponding illustration.

- A** Lists of letters appear adjacent to the series of illustrations where the order of the instructions is not significant.
- 1** Arrows appear numbered and unnumbered and are used to illustrate a movement.
- A** Arrows with letters are used to clarify a movement when the relative order is of no relevance.

If there is no series of illustrations for step-by-step instructions then the different steps are numbered with normal numbers.

## Position lists

- 1** Red circles containing a number are used in overview images where different components are pointed out. The number recurs in the position list featured in connection with the illustration that describes the item.

## Bulleted lists

A bulleted list is used when there is a list of points in the owner's manual.

Example:

- Coolant
- Engine oil

## Related information

Related information refers to other articles containing closely associated information.

## Images

The manual's images are sometimes schematic and may deviate from the car's appearance depending on equipment level and market.

## To be continued

▶▶ This symbol is located furthest down to the right when an article continues on the following page.

## Continued from previous page

◀◀ This symbol is located furthest up to the left when an article continues from the previous page.

## Related information

- Digital owner's manual in the car (p. 15)
- Owner's Manual in mobile devices (p. 18)
- Volvo Cars support site (p. 19)

### Recording data

As part of Volvo's safety and quality assurance, certain information about the vehicle's operation, functionality and incidents are recorded in the car.

This vehicle is equipped with an "Event Data Recorder" (EDR). Its primary purpose is to register and record data related to traffic accidents or collision-like situations, such as times when the airbag deploys or the vehicle strikes an obstacle in the road. The data is recorded in order to increase understanding of how vehicle systems work in these types of situations. The EDR is designed to record data related to vehicle dynamics and safety systems for a short time, usually 30 seconds or less.

The EDR in this vehicle is designed to record data related to the following in the event of traffic accidents or collision-like situations:

- How the various systems in the car worked
- Whether the driver and passenger seatbelts were fastened/tensioned
- The driver's use of the accelerator or brake pedal
- The travel speed of the vehicle

This information can help us better understand the circumstances in which traffic accidents, injuries and damage occur. The EDR only records data when a non-trivial collision situation occurs. The EDR does not record any data during normal

driving conditions. Similarly, the system never registers who is driving the vehicle or the geographic location of the accident or near-miss situation. However, other parties, such as the police, could use the recorded data in combination with the type of personally identifiable information routinely collected after a traffic accident. Special equipment and access to either the vehicle or the EDR is required to be able to interpret the registered data.

In addition to the EDR, the car is equipped with a number of computers designed to continually check and monitor the function of the car. They can record data during normal driving conditions, but in particular register faults affecting the vehicle's operation and functionality, or upon activation of the vehicle's driver support function (e.g. City Safety and the auto brake function).

Some of the recorded data is required to enable service and maintenance technicians to diagnose and remedy any faults that occurred in the vehicle. The registered information is also needed to enable Volvo to satisfy legal requirements laid out in laws and by government authorities. Information registered in the vehicle is stored in its computer until the vehicle is serviced or repaired.

In addition to the above, the registered information can be used in aggregate form for research and product development with the aim of continuously improving the safety and quality of Volvo cars.

Volvo will not contribute to the above-described information being disclosed to third parties without the vehicle owner's consent. To comply with national legislation and regulations, Volvo may be forced to disclose information of this nature to the police or other authorities who may assert a legal right to access such. Special technical equipment which Volvo and workshops that have entered into agreements with Volvo have access to is required to be able to read and interpret the recorded data. Volvo is responsible that the information, which is transferred to Volvo during servicing and maintenance, is securely stored and managed and that its management complies with relevant legal requirements. For further information - contact a Volvo dealer.

## Important information on accessories, extra equipment and diagnostic socket

Incorrect connection and installation of accessories, extra equipment or software/diagnostic tools may have a negative effect on the car's electronic system.

Certain accessories only function when associated software is installed in the car's computer system. Volvo therefore recommends always making contact with an authorised Volvo workshop before the installation of accessories or extra equipment that are connected to or affect the electrical system.

## Connection of equipment to the car's diagnostic socket

### WARNING

Volvo Cars accepts no responsibility for the consequences of cases where non-authorized equipment is connected to the car's data link connector (On-Board-Diagnostics (OBD-II)).

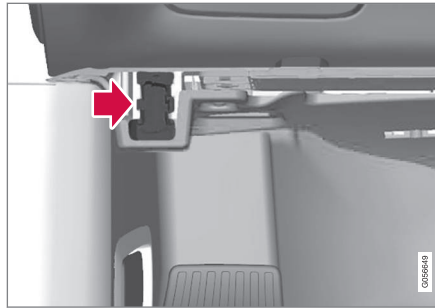

The diagnostic socket is located under the instrument panel and on the same side as the steering wheel.

## Volvo ID

Volvo ID provides access to a wide range of personalized Volvo services<sup>4</sup> online.

It is possible to create a Volvo ID from the car, My Volvo<sup>5</sup> or the Volvo On Call app<sup>6</sup>. Certain functions and services require that the car is registered to a personal Volvo ID. Registering the Volvo ID to the car makes a wide range of Volvo services available directly from the car.

Examples of services:

- My Volvo - A personal web page for you and your car.
- Volvo On Call\* - Volvo ID is used when logging in to the Volvo On Call app.
- Send to Car - Makes it possible to send an address from an Internet map service directly to the car.
- Book Service and Repair - Register your preferred workshop/dealer in My Volvo to be able to book service directly from the car.

## Creating a Volvo ID

It is possible to create a Volvo ID in different ways. If the Volvo ID is created with My Volvo or the Volvo On Call app, the Volvo ID must also be registered to the car to enable use of the various Volvo ID services.

<sup>4</sup> The services available may vary over time and vary depending on equipment level and market.

<sup>5</sup> Available in certain markets.

<sup>6</sup> If you have Volvo On Call\*.

### ◀◀ **In My Volvo<sup>5</sup>**

1. Go to [www.volvocars.com](http://www.volvocars.com) and navigate through to My Volvo.
2. Enter a personal email address.
3. Follow the instructions that are automatically sent to the specified email address.
  - > A Volvo ID has now been created. Read below to learn how to register the ID to the car.

### **With Volvo On Call mobile app<sup>6</sup>**

1. Download the latest version of the Volvo On Call app from a smartphone, via e.g. App Store, Windows Phone or Google Play.
2. Choose to create a Volvo ID from the app's start page and enter a personal email address.
3. Follow the instructions that are automatically sent to the specified email address.
  - > A Volvo ID has now been created. Read below to learn how to register the ID to the car.

### **Registering your Volvo ID to the car**

If you created your Volvo ID via the web or the Volvo On Call app, register it to your car as follows:

1. Download the Volvo ID app from **Download Centre** in the centre display's app view.

#### **NOTE**

To download apps, the car must be connected to the Internet.

2. Start the app and enter your Volvo ID/your email address.
3. Follow the instructions that are automatically sent to the email address linked to your Volvo ID.
  - > Your Volvo ID is now registered to the car. Volvo ID services can now be used.

### **Creating and registering a Volvo ID for the car**

1. If not done already, download the Volvo ID app from **Download Centre**.
2. Start the app and register a personal email address.

3. Follow the instructions that are automatically sent to the specified email address.
  - > A Volvo ID has now been created and automatically registered to the car. Volvo ID services can now be used.

### **Advantages of Volvo ID**

- One user name and one password to access online services, i.e. only one username and one password to remember.
- If the username/password for a service (e.g. Volvo On Call) is changed, then it is also changed automatically for other services (e.g. My Volvo).

### **Related information**

- Downloading, updating and uninstalling apps (p. 468)
- Connecting the car (p. 464)

<sup>5</sup> Available in certain markets.

<sup>6</sup> If you have Volvo On Call\*.

## Drive-E - cleaner driving pleasure

Volvo Car Corporation is constantly working on the development of safer and more efficient

products and solutions in order to reduce the negative impact on the environment.



Environmental care is one of Volvo Cars' core values and influences all operations. The environmental work is based on the whole life cycle of the car and takes into account the environmental impact it has, from design to scrapping and recycling. Volvo Cars' basic principle is that every new product developed must have less impact on the environment than the product it replaces.

Volvo's environmental management work has resulted in the development of more effective and less polluting drivelines Drive-E. Personal environment is also important to Volvo - the air

inside a Volvo is, for example, cleaner than the air outside thanks to the climate control system.

Your Volvo complies with stringent international environmental standards. All Volvo's manufacturing units must be ISO 14001 certified, and this supports a systematic approach to the operation's environmental issues, which leads to continuous improvement with reduced environmental impact. Holding the ISO certificate also means that environmental laws and regulations in force are complied with. Volvo also requires that its partners must also meet these requirements.

## Fuel consumption

Since a large part of a car's total environmental impact stems from its use, the emphasis of Volvo Cars' environmental work is on reducing fuel consumption, carbon dioxide emissions and other air pollutants. Volvo cars have competitive fuel consumption in each of their respective classes. Lower fuel consumption generally results in lower emission of the greenhouse gas, carbon dioxide.

### ◀◀ **Contributing to a better environment**

An energy-efficient and fuel-efficient car not only contributes to a reduced impact on the environment, but also means reduced costs for the owner of the car. As the driver, it is easy to reduce fuel consumption and thereby save money and contribute to a better environment - here is some advice:

- Plan for an effective average speed. Speeds above approx. 80 km/h (approx. 50 mph) and below 50 km/h (approx. 30 mph) lead to increased energy consumption.
- Follow the Service and Warranty Booklet's recommended intervals for service and maintenance of the car.
- Avoid letting the engine idle - switch off the engine when stationary for longer periods. Pay attention to local regulations.
- Plan the journey - a lot of unnecessary stops and uneven speed contribute to increased fuel consumption.
- Use preconditioning\* before starting in cold conditions - it improves starting capacity and reduces wear in cold weather. The engine reaches normal operating temperature more quickly, which decreases consumption and reduces emissions.

Also remember to always dispose of environmentally hazardous waste, such as batteries and oil, in an environmentally safe manner. Consult a workshop in the event of uncertainty about how this

type of waste should be discarded - an authorised Volvo workshop is recommended.

### **Efficient emission control**

Your Volvo is manufactured following the concept "Clean inside and out" - a concept that encompasses a clean interior environment as well as highly efficient emission control. In many cases the exhaust emissions are well below the applicable standards.

### **Clean air in the passenger compartment**

A passenger compartment filter prevents dust and pollen from entering the passenger compartment via the air intake.

The Interior Air Quality System (IAQS)\* ensures that the incoming air is cleaner than the air in the traffic outside.

The system cleans the air in the passenger compartment from contaminants such as particles, hydrocarbons, nitrous oxides and ground-level ozone. If the outside air is contaminated then the air intake is closed and the air is recirculated. Such a situation may arise in heavy traffic, queues and tunnels for example.

IAQS is a part of the Clean Zone Interior Package (CZIP)\*, which also includes a function that allows the fan to start when the car is unlocked with the remote control key.

### **Interior**

The material used in the interior of a Volvo is carefully selected and has been tested in order to be pleasant and comfortable. Some of the details are hand-made, such as the seams of the steering wheel that are sewn by hand. The interior is monitored in order not to emit strong odours or substances that cause discomfort in the event of e.g. high heat and bright light.

### **Volvo workshops and the environment**

Regular maintenance creates the conditions for a long service life and low fuel consumption for your car. In this way you also contribute to a cleaner environment. When Volvo's workshops are entrusted with the service and maintenance of your car it becomes part of Volvo's system. Volvo makes clear demands regarding the way in which workshop premises shall be designed in order to prevent spills and discharges into the environment. The workshop staff have the knowledge and the tools required to guarantee good environmental care.

### **Recycling**

Since Volvo works from a life cycle perspective, it is also important that the car is recycled in an environmentally sound manner. Almost all of the car can be recycled. The last owner of the car is therefore requested to contact a dealer for referral to a certified/approved recycling facility.



**Related information**

- Drive modes\* (p. 398)
- The owner's manual and the environment (p. 32)
- Economical driving (p. 422)
- Fuel consumption and CO2 emissions (p. 573)
- Air quality (p. 182)

### **IntelliSafe-driver support**

IntelliSafe is the Volvo Cars concept concerning car safety. It comprises a number of systems that contribute to making a car journey safe, to the prevention of injuries and to the protection of passengers from other road users.

#### **Support**

There are systems incorporated in IntelliSafe that help the driver to drive the car in a safe manner. The driver support functions incorporated in the car include e.g. the adaptive cruise control (Adaptive Cruise Control)\* that ensures that a constant distance is held between the car and the vehicle in front.

Pilot Assist\* helps the driver to keep the car between the lane's edge markings, combined with maintaining a preset time interval to the vehicle ahead.

Park Assist Pilot\* helps the driver park the car by sensing the area around it.

Other examples of systems that help the driver are the Active main beam, Cross Traffic Alert (CTA)\* and Blind Spot Information (BLIS)\* systems.

#### **Prevention**

An example of a function that helps to prevent accidents is City Safety. The function warns the driver of risks of collision with another vehicle, pedestrians, cyclists or larger animals. If the driver

does not react to the warning and the risk of collision is imminent then City Safety can automatically brake the car.

Lane Keeping Aid (LKA)\* is another example of a function that helps to prevent accidents by warning the driver and giving corrective steering interventions if the car is about to cross a lane side line.

Also available is the run-off mitigation function (Run off mitigation), whose purpose is to reduce the risk of the car unintentionally leaving the road, and it actively steers the car back onto the road.

#### **Protection**

To protect the driver and passengers, the car is equipped with seatbelt tensioners which can tension the seatbelts in critical situations and in collisions. It also has airbags and inflatable curtains, as well as Whiplash Protection System (WHIPS) which protects against whiplash injuries.

A Pedestrian Protection System (PPS) is also available for mitigating a pedestrian's impact with the car in the event of a frontal collision.

#### **Related information**

- Adaptive cruise control\* (p. 288)
- Park Assist Pilot\* (p. 372)
- Activating/deactivating main beam (p. 138)
- Activate/deactivate Cross Traffic Alert\* (p. 342)

- Blind Spot Information\* (p. 338)
- City Safety (p. 328)
- Lane Keeping Aid (p. 352)
- Roll Stability Control (p. 270)
- Seatbelt (p. 59)
- Safety (p. 56)
- Airbags (p. 63)
- Pilot Assist\* (p. 302)
- Run-off Mitigation (p. 358)
- Whiplash Protection System (p. 57)

## Sensus - connection and maintenance

Sensus makes it possible to surf the Internet, use different types of apps and make the car a Wi-Fi hotspot.

### This is Sensus

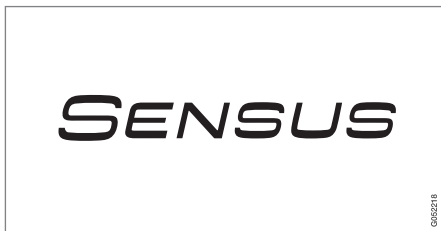

Sensus offers an intelligent interface and online connectivity with the digital world. An intuitive navigation structure makes it possible to receive relevant support, information and entertainment when it is necessary, without distracting the driver.

Sensus covers all solutions in the car that are connected with entertainment, online connectivity, navigation\* and the user interface between driver and car. It is Sensus that makes communication possible between you, the car and the outside world.

## Information when it is needed, where it is needed

The different displays in the car provide information at the right time. The information is shown in different locations based on how it should be prioritised by the driver.

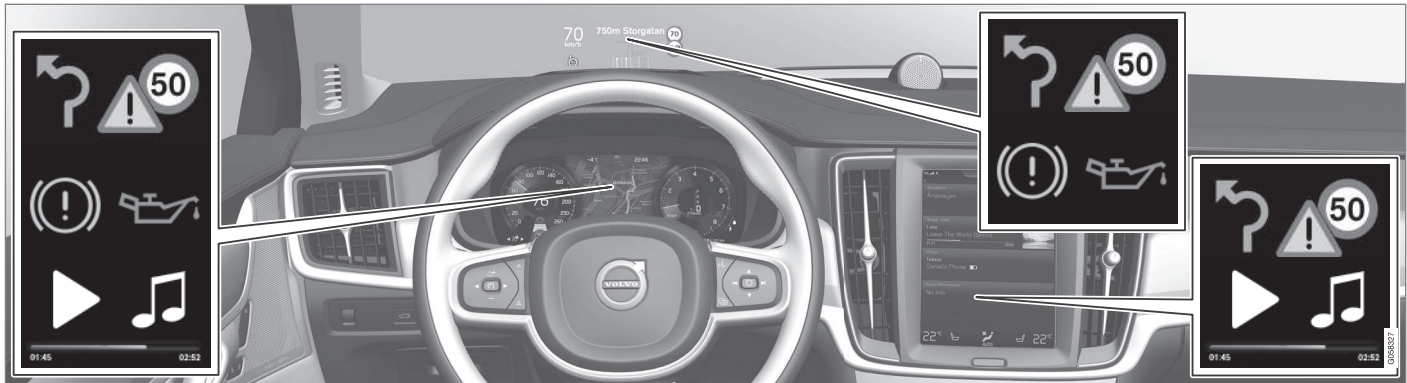

Different types of information are shown in different displays depending on how the information should be prioritised.

**Head-up display\***

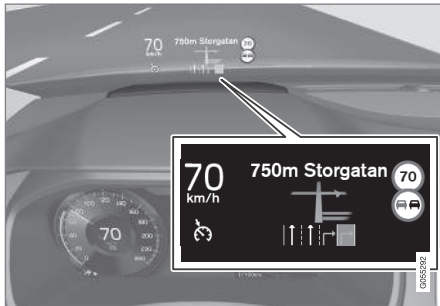

The head-up display shows selected information that the driver should deal with as soon as possible. Such information includes traffic warnings,

speed information and navigation\* information. Road Sign Information and incoming phone calls are also shown in the head-up display. The display is operated via the right-hand steering wheel keypad and via the centre display.

**Driver display**



12-inch driver display.



8-inch driver display.

The driver display shows information on speed and e.g. incoming calls or song tracks being played. The display is operated via the two steering wheel keypads.

### Centre display



Many of the main functions of the car are controlled from the centre display, a touch screen which reacts to touch. The number of physical buttons and controls in the car is therefore minimal. The screen can even be operated while wearing gloves.

The climate control system, the entertainment system and seat position are controlled from here, for example. The information that is shown in the centre display can be acted on by the driver or someone else in the car when the opportunity arises.

### Voice recognition system



The voice recognition system can be used without the driver needing to take his/her hands off the steering wheel. The system can understand natural speech. Use voice recognition to play back a song, call some-

one, increase the temperature or read out a text message.

For more information about all functions/systems, see the relevant section in the owner's manual or its supplement.

### Related information

- Operating the centre display (p. 36)
- Navigating in the centre display's views (p. 40)
- Head-up display\* (p. 112)

- Driver display (p. 90)
- Voice recognition (p. 115)
- Online car\* (p. 463)
- Audio and media (p. 434)

## The owner's manual and the environment

The Owner's Manual is printed on paper originating from controlled forests.

The Forest Stewardship Council (FSC)<sup>®</sup> symbol shows that the paper pulp in a printed owner's manual comes from FSC<sup>®</sup>-certified forests or other controlled sources.

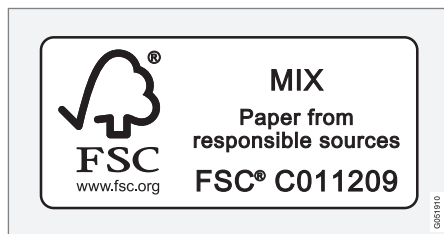

### Related information

- Drive-E - cleaner driving pleasure (p. 25)

## Windows, glass and mirrors

The car contains controls for windows, glass and mirrors. Some of the windows in the car are reinforced with lamination, which makes the passenger compartment more soundproof, amongst other things.

### Laminated glass

The windscreen and panorama\* roof have laminated glass. The glass is reinforced, which provides better protection against break-ins and improved sound insulation in the passenger compartment. Laminated glass is available as an option for certain other glass surfaces.



The symbol is shown on the windows where the glass is laminated<sup>7</sup>.

### Related information

- Panorama roof\* (p. 158)
- Power windows (p. 151)
- Activating/deactivating defrost of windows and door mirrors (p. 192)
- Using the sun blind\* (p. 153)
- Interior rearview mirror (p. 155)
- Adjusting the door mirrors (p. 153)
- Head-up display\* (p. 112)

- Using windscreen wipers (p. 148)
- Windscreen and headlamp washers (p. 150)

<sup>7</sup> Does not apply to the windscreen or panorama roof\* which are always laminated and thus do not have this symbol.

## Overview of the centre display

Many of the car's functions are controlled from the centre display. Presented here is the centre display and its options.



Three of the centre display's basic views. Swipe right or left to access the function or app view respectively<sup>8</sup>.

**1** Function view - car functions that are activated/deactivated with a press. Certain func-

tions are also so-called trigger functions, which means they open a window with set-

<sup>8</sup> The views are reversed for right-hand drive cars.



ting options. Examples of such are **Camera** and parking functions.

- 2 Home view - the first view that is shown when the screen is started.
- 3 Application view (app view) - apps that have been downloaded (third-party apps) and apps for embedded functions, such as **FM radio**. Tap on an app icon to open the app.
- 4 Status bar - the activities in the car are shown right at the top of the screen. Network/connection information is shown on the left-hand side of the status bar, while media-related information, the clock and indication about on-going background activity are shown on the right.
- 5 Top view - drag the tab down in order to access the top view. **Settings, Owner's manual, Profile** and the car's saved messages are accessed from here.
- 6 Navigation - leads to map navigation, with e.g. Sensus Navigation\*. Tap on the subview to expand it.
- 7 Media - recently used apps associated with media. Tap on the subview to expand it.
- 8 Phone - the phone function can be reached from here. Tap on the subview to expand it.

- 9 Extra subview - recently used apps/car functions that do not belong in any of the other subviews. Tap on the subview to expand it.
- 10 Climate row - information and direct interaction to set temperature, seat heating level and fan level. Tap on the symbol in the centre of the climate row in order to open the climate view with more setting options.

### Related information

- Operating the centre display (p. 36)
- Navigating in the centre display's views (p. 40)
- Function view with buttons for car functions (p. 47)
- Changing settings for apps (p. 178)
- Symbols in the centre display's status bar (p. 45)
- Settings view (p. 169)
- Media player (p. 442)
- Phone (p. 456)
- Climate controls in the centre display (p. 185)
- Cleaning the centre display (p. 553)

### Operating the centre display

Many of the car's functions are controlled and regulated from the centre display. The centre display is a touch screen that reacts to touch.

### Using the touch screen functionality in the centre display

The screen reacts differently depending on whether you press, drag or swipe across it. Actions such as browsing between different

views, marking objects, scrolling in a list and moving apps can be performed by touching the screen in different ways.



An infrared film enables the screen to detect a finger that is just in front of the screen. This technology makes it possible to use the screen even with gloves on.





Two people can interact with the screen at the same time, e.g. to adjust the climate for the driver and passenger side respectively.

**!** **IMPORTANT**

Do not use sharp objects on the screen as they may scratch it.

The table below presents the different procedures for operating the screen:

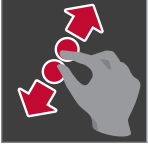
Procedure	Execution	Result
	Press once.	Highlights an object, confirms a selection or activates a function.
	Press twice in quick succession.	Zooms in on a digital object, such as the map*.
	Press and hold.	Grabs an object. Can be used to move apps or map points on the map*. Press and hold your finger against the screen and at the same time drag the object to the desired location.
	Tap once with two fingers.	Zooms out from a digital object, such as the map*.

Procedure	Execution	Result
	Drag	Changes between different views, scrolls a list, text or view. Hold depressed and drag in order to move apps or map points on the map*. Drag horizontally or vertically across the screen.
	Swipe/drag quickly	Changes between different views, scrolls a list, text or view. Drag horizontally or vertically across the screen.
	Drag apart	Zooms in.
	Drag together	Zooms out.

◀◀ **Turn off the screen and reactivate it**



Home button for the centre display.

When the centre display is switched off, the screen is dimmed so as not to be disruptive whilst driving. The climate row will still be visible, and apps and other functions connected to the screen will continue to run.

1. Give a long press on the physical home button below the screen.
  - > The screen goes dark except for the climate row, which continues to be shown. All functions continue to run, such as climate control, audio, guiding\* and apps. In this mode, the screen can be cleaned with the cloth supplied; see the section "Cleaning the centre display".

2. Reactivate the screen - briefly tap on the home button.
  - > The view that was displayed before the screen was switched off will be shown again.

**i NOTE**

The screen cannot be deactivated when a prompt to perform an action is shown on the screen.

**i NOTE**

The centre display deactivates automatically when the engine is off and the driver's door is opened.

**Returning to home view from another view**

1. Briefly press the home button.
  - > The last position of the home view is shown.
2. Briefly press again.
  - > All subviews of the home view are set to their default mode.

**i NOTE**

In home view standard mode - briefly press the home button. An animation that describes access to the different views is shown on the screen.

**Moving apps and buttons for car functions**

The apps and buttons for car functions in the app view and function view respectively can be moved and organised as desired.

1. Tap on an app/button and hold depressed.
  - > The app/button changes size and becomes slightly transparent. It is then possible to move it.
2. Drag the app/button to a vacant space in the view.

The maximum number of rows available for use in order to position apps/buttons is 48. To move an app/button outside the visible view, drag it to the bottom of the view. New rows are then added, where the app/button can be located.

An app/button can thus be located further down and is then not visible in the normal mode for the view.

Swipe across the screen to scroll upward/downward in the view.

**i NOTE**

Hide the apps that you rarely or never use by moving them to the bottom, off the visible screen. This way it will be easier to find the apps you use more often.

**Scrolling in a list, article or view**

When a scroll indicator is visible in the screen, it is possible to scroll downward or upward in the view. Swipe downwards/upwards anywhere in the view.

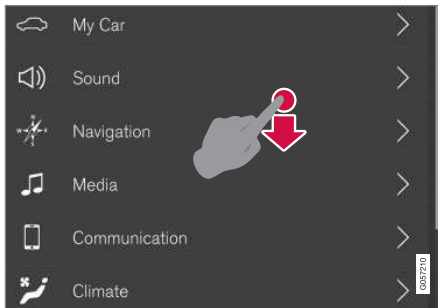

The scroll indicator appears in the centre display when it is possible to scroll in the view.

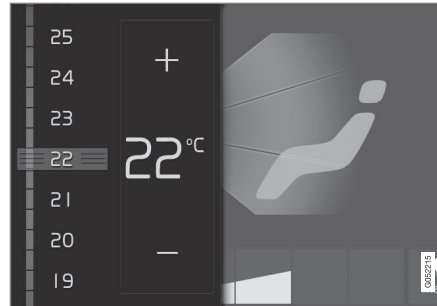
**Using the controls in the centre display**

Temperature control.

The control is used for many of the car's functions. Regulate e.g. temperature by means of one of the following:

- drag the control to the desired temperature,
- tap on +/- in order to raise/lower the temperature gradually, or
- tap on the desired temperature on the control.

**Related information**

- Navigating in the centre display's views (p. 40)
- Settings view (p. 169)
- Sensus - connection and maintenance (p. 29)
- Remote control key range (p. 236)

- Downloading, updating and uninstalling apps (p. 468)
- Using the keyboard in the centre display (p. 49)
- Change settings for the centre display (p. 45)

## Navigating in the centre display's views

There are five different basic views in the centre display: home view, top view, climate view, application view (app view) and function view. The screen is started automatically when the driver's door is opened.

### Home view

Home view is the view that is shown when the screen is started. It consists of four subviews: **Navigation**, **Media**, **Phone** and an extra subview.

An app/car function selected from the app/function view starts in the respective subview of the home view. For example **FM radio** starts in the **Media** subview.

The extra subview contains the last used app/car function that is not associated with any of the other three areas.

The subviews show brief information about each different app.

#### **NOTE**

The first time the car is used, some of the home view's subviews have no content.

#### **NOTE**

In home view standard mode - briefly press the home button. An animation that describes access to the different views is shown on the screen.

## Expanding a subview from default mode

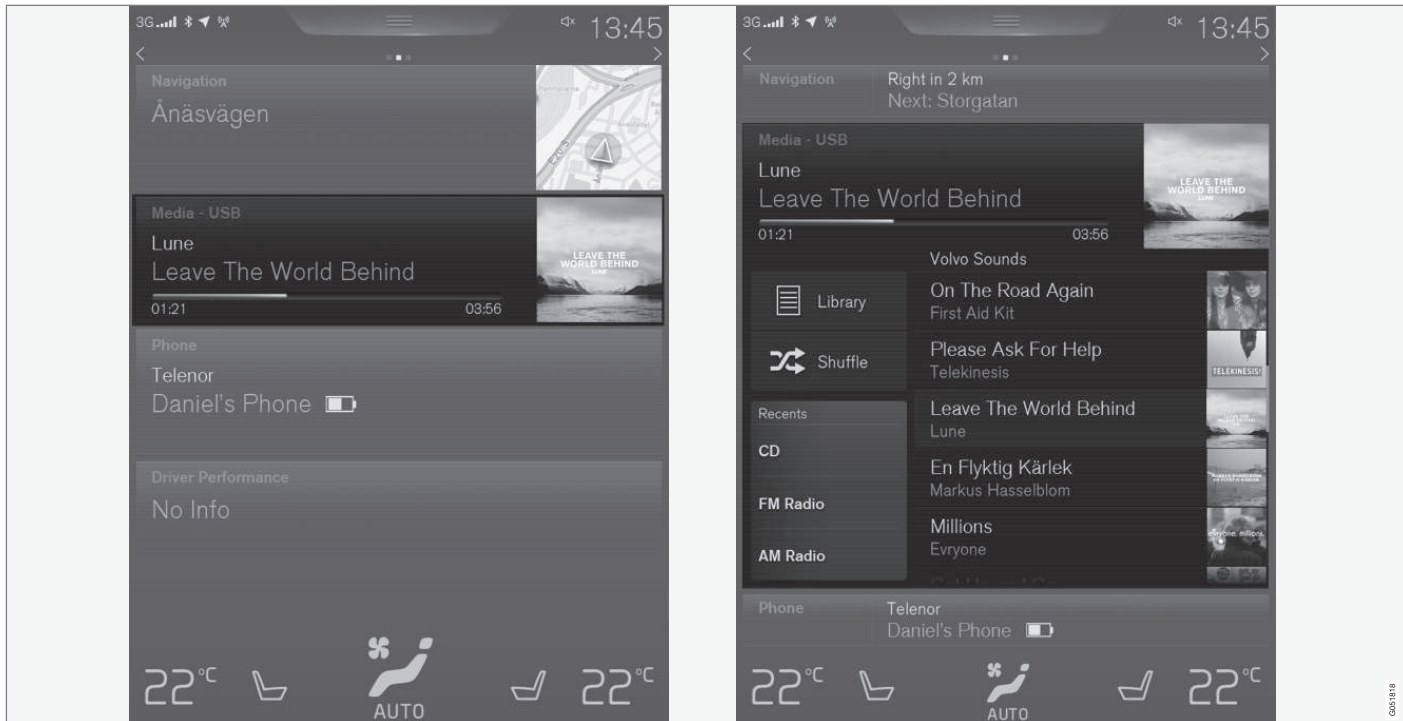

Standard mode and expanded mode of a subview in the centre display.

## INTRODUCTION

### ◀ Expanding a subview:

- Press anywhere on the subview. When a subview is expanded, the fourth subview in the home view is temporarily forced away. The other two are minimised and only certain information is shown.

The expanded view provides access to the basic functions of the app.

### Closing an expanded subview:

- The subview can be closed in three different ways.
  - Tap on the upper part of the expanded subview.
  - Tap on another subview (that subview will then open in expanded mode instead).
  - Briefly press the physical home button below the centre display.

### Opening/closing a subview in full screen mode

The extra subview and the subview for **Navigation** can be opened out in full screen mode, with even more information and more setting options.

When a new subview is opened in full-screen mode, no information from the other subviews is shown.



In expanded mode, open the app in full screen - press on the symbol.



Press on the symbol to go back to the expanded mode, or press the home button at the bottom of the screen.



Home button for the centre display.

There is always the option to go back to home view by pressing the home button. Go back to the home view's standard view from full screen mode - press twice on the home button.

## Status bar

The activities in the car are shown at the top of the screen. Network/connection information is shown on the left-hand side of the status bar, while media-related information, the clock and indication that background activity is in progress are shown on the right.

## Top view

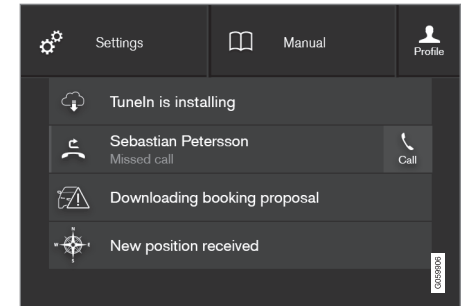

Top view dragged down.

A tab is located in the centre of the status bar at the top of the screen. Open the top view by pressing on the tab or by dragging/swiping from the top downwards across the screen.

In the top view, access is available to:

- **Settings**
- **Owner's manual**
- **Profile**
- The car's saved messages.



Exit the top view - press outside the top view, on the home button or at the bottom of the top view and drag upward. The underlying view is then visible and available for use again.

### **i** NOTE

The top view is not available during starting/shutdown or when a message is shown on the screen. It is also not available when climate view is shown.

### Go into the top view from an app

Drag down the top view when an app is running, e.g. FM radio:

- Press **FM Radio Settings** - settings that are associated with FM radio are shown.
- Press **FM Radio Manual** - an article that is associated with FM radio is opened.

This only applies to some of the apps in the car. For third party apps that are downloaded, it is not possible to access app-specific articles or settings, for example.

### Climate view

The climate row is always visible at the bottom of the screen. The most common climate settings can be made directly there, such as setting temperature, seat heating and fan.



Press the symbol in the centre of the climate row to open the climate view and gain access to more climate settings.



Press the symbol to close the climate view and return to the previous view.

### Application view

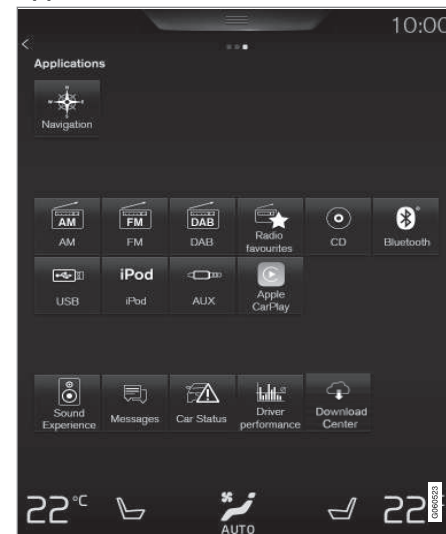

Application view with the car's apps.

Swipe from right to left<sup>9</sup> across the screen in order to access the application view (app view) from the home view. Apps that have been downloaded (third-party apps) and apps for embedded functions, such as **FM radio**, are found here. Certain apps show brief information directly in the

<sup>9</sup> Applies to left-hand drive cars. For right-hand drive cars - swipe in the opposite direction.

◀ app view, such as the number of unread text messages for **Messages**.

Tap on an app to open it. It then opens in the subview to which it belongs, such as **Media**.

Depending on the amount of apps, it is possible to scroll downward in the app view. Do this by swiping/dragging from the bottom and up.

To move an app:

1. Tap on the app and hold depressed.
  - > The app becomes slightly transparent and larger when it is ready to be moved.
2. Drag the app to the desired location.

**i NOTE**

Apps and car function buttons cannot be added to locations that are already occupied.

Go back to the home view again by swiping from left to right<sup>9</sup> across the screen, or by pressing the home button.

### Function view

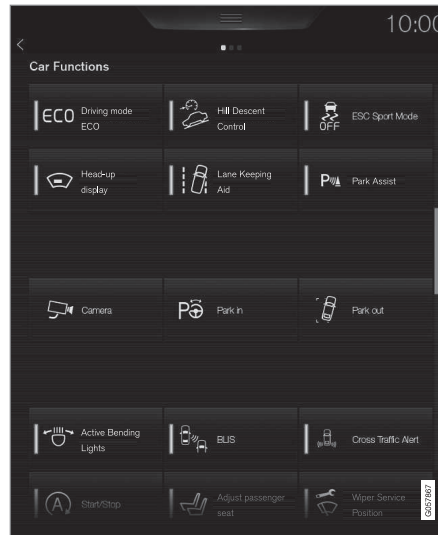

The function view with buttons for different car functions.

Swipe from left to right<sup>9</sup> across the screen in order to access the function view from the home view. From here you can activate/deactivate different car functions, e.g. **Lane Departure Warning**, **Lane Keeping Aid\*** and **Park Assist\***.

Depending on the amount of functions, it is also possible here to scroll downward in the view. Do this by swiping/dragging from the bottom and up.

Unlike in app view, where an app is opened with a press, a function is activated/deactivated by pressing the relevant function button. Some functions (trigger functions) open in a new window when pressed.

Just as in app view, it is possible to move the function buttons around and arrange them in the desired order.

### Related information









- Operating the centre display (p. 36)
- Overview of the centre display (p. 33)
- Function view with buttons for car functions (p. 47)
- Changing settings for apps (p. 178)
- Symbols in the centre display's status bar (p. 45)
- Climate controls in the centre display (p. 185)









<sup>9</sup> Applies to left-hand drive cars. For right-hand drive cars - swipe in the opposite direction.

## Symbols in the centre display's status bar

Overview of the symbols that can be shown in the centre display's status bar.

The status bar shows activities in progress and, in some cases, their status. Not all symbols are shown all the time due to the limited space in the status bar.

Symbol	Specification
	Roaming activated.
	Signal strength in mobile phone network.
	Bluetooth device connected.
	Bluetooth activated but no device connected.
	Connected to Wi-Fi network.
	Tethering activated (Wi-Fi hotspot). The car then shares the available connection.
	Car modem activated.
	Remote diagnostics active.
	Process in progress.

Symbol	Specification
	Preconditioning in progress.
	Audio source being played back.
	Audio source stopped.
	Phone call in progress.
	Audio source muted.
	News is received from the radio channel.
	Traffic information is received.
	Clock.

### Related information

- Messages in the driver display and the centre display (p. 107)
- Navigating in the centre display's views (p. 40)

## Change settings for the centre display

The centre display is started automatically when the driver's door is opened. The settings can be changed for the centre display to personalise sound and themes. The screen can be switched off so as not to be disruptive whilst driving.

### Switching off/changing the system sounds volume in the centre display.

The system sounds volume in the centre display can be adjusted or switched off:

1. Press **Settings** in the top view in the centre display.
2. Press **Sound** → **System Volumes**.
3. Under **Screen Touch**, drag the control to change the volume/switch off screen touch sounds and **Keypad Touch** in order to adjust the volume/switch off screen keyboard touch sounds. Drag the control to the desired volume.

### Changing the appearance of the screen

1. Press **Settings** in the top view.
2. Press **My Car** → **Displays** → **Display Themes**.
3. Then select theme, e.g. **Minimalistic** or **Chrome Rings**.

As a supplement to these appearances, it is possible to choose between **Normal** and **Bright**.



## INTRODUCTION

- ◀◀ With **Normal**, the screen background is dark and the text is light. This alternative is the default for all themes. A light variant can also be selected, in which the background is light and the text is dark. This alternative can be useful in e.g. strong daylight.

This alternative is always available for the user and is not affected by the surrounding lighting.

### **Related information**

- Settings view (p. 169)
- Sensus - connection and maintenance (p. 29)
- Cleaning the centre display (p. 553)
- Operating the centre display (p. 36)

## Function view with buttons for car functions

All the buttons for car functions are located in the function view, one of the centre display's

basic views. Navigate to the function view from home view by swiping from left to right across the screen<sup>10</sup>.

## Different types of buttons

There are three different types of buttons for car functions; see below:

Type of button	Property	Affects car function
Function buttons	Have on/off positions. When a function is running, an LED indicator illuminates to the left of the icon for the button. Press the button to activate/deactivate a function.	Most buttons in function view are function buttons.
Trigger buttons	Do not have on/off positions. When a trigger button is pressed, a window for the function opens. For example, it may be a window for changing a seat's position.	<ul style="list-style-type: none"> <li>● <b>Camera</b></li> <li>● <b>Headrest fold</b></li> <li>● Functions for folding seats</li> <li>● <b>Head-up display adjustments</b></li> </ul>
Parking buttons	Have on, off and scan modes. Similar to the function buttons but with an extra position for parking scanning.	<ul style="list-style-type: none"> <li>● <b>Park In</b></li> <li>● <b>Park Out</b></li> </ul>

<sup>10</sup> Applies to left-hand drive cars. For right-hand drive cars - swipe in the opposite direction.

## ◀ The buttons' different modes



When the LED indicator illuminates in green on a function or parking button, the function is activated. When a function is activated, extra text with an explanation for certain functions is shown. The text is shown for a few seconds and then the button is shown with the LED indicator illuminated.

For **Lane Keeping Aid**, the text **Works only at certain speeds** is shown, for example, when the button is depressed.

Briefly tap on the button once in order to activate/deactivate the function.

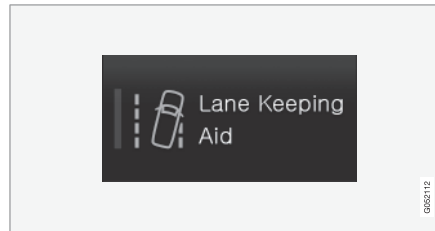

The function is deactivated when the LED indicator is extinguished.

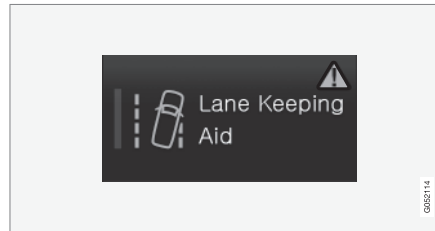

When a warning triangle is shown in the right-hand section of the button there is something not working as intended.

### Related information

- Overview of the centre display (p. 33)
- Navigating in the centre display's views (p. 40)
- Categories in the settings view (p. 170)

## **Using the keyboard in the centre display**

The centre display keyboard makes it possible to make entries using keys. It is also possible to "draw in" letters and characters on the screen by hand.

## **Making entries with the keyboard**

The keyboard can be used to enter characters, letters and numbers, e.g. to write text messages from the car, enter passwords or search for articles in the digital owner's manual.

The keyboard is only shown when entries can be made on the screen.

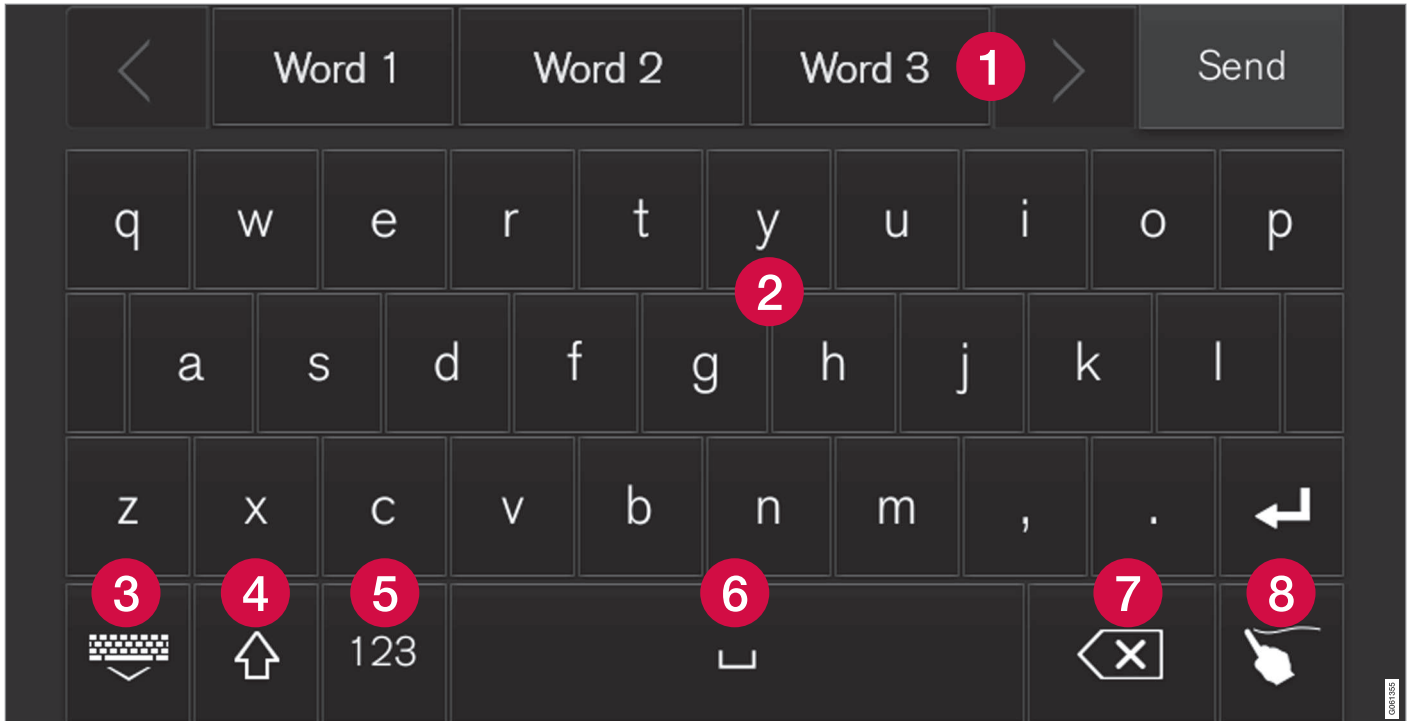

The image shows an overview of some of the buttons which may be shown in the keyboard. The appearance varies depending on language settings and the context in which the keyboard is being used.



- 1 Row of suggested words or characters<sup>11</sup>. The suggested words are adjusted as new letters are being entered. Browse among the suggestions by pressing on the right and left arrows. Tap on a suggestion to select it. Note that this function is not supported by all language selections. If not available, the row will not be shown on the keyboard.
- 2 The characters available on the keyboard depend on which language was selected (see point 7). Tap on a character to enter it.
- 3 The button works in different ways, depending on the context in which the keyboard is used - either to enter @ (when an email address is entered) or to **create a new row** (for normal text input).
- 4 Hides the keyboard. If this is not possible, the button is not shown.
- 5 Used to enter capital letters. Press again to enter one capital letter and then continue with lower-case letters. Another press makes all letters capital letters. The next press restores the keyboard to lower-case letters. In this mode, the first letter after a full stop, exclamation mark or question mark is a capital letter. The first letter in the text field is also a capital letter. In text fields intended for names or addresses, each word automatically starts with a capital letter. In text fields for password, web address or email address

entry, all letters are automatically lower case unless otherwise set with the button.

- 6 Number entry. The keyboard (2) is then shown with numbers. Press ABC, which in number mode is shown instead of 123, to return to the letter keyboard, or #\~ to open the keyboard with special characters.
- 7 Changes text input language, e.g. UK. The available characters and word suggestions (1) vary depending on the selected language. Press to open a list of languages and then tap on the language to be used. To add additional languages in the keyboard - see the heading "Changing keyboard language" below.
- 8 Space.
- 9 Undoes entered text. Press briefly to delete one character at a time. Hold the button depressed to delete characters more quickly.
- 10 Changes keyboard mode to write letters and characters by hand instead. Read more under the heading "Writing characters/ letters by hand on the screen".

Press the confirmation button above the keyboard (not visible in the image) to confirm the entered text. The appearance of the button differs depending on context.

## Changing the keyboard language

To make it possible to switch between different languages for the keyboard, the languages must first be added under **Settings**.

### Adding/deleting languages in settings

The keyboard is automatically set to the same languages as the system language. The keyboard language can be manually adapted without affecting the system language.

1. Press **Settings** in the top view.
2. Press **System** → **Keyboard Layouts**.
3. Select one or more languages from the list.
  - > It is now possible to switch between the selected languages directly from the keyboard for text input.

If no languages have been actively selected under **Settings**, the keyboard uses the same language as the car's system language; see the section "Changing system settings in the settings view".

<sup>11</sup> Applies to Asiatic languages.

## ◀ Switching between different languages in the keyboard



When a number of languages have been selected in **Settings**, the keyboard button (shown in context as number 7 in the illustration above) is used to switch between different languages.

To change keyboard language:

1. Press and hold the button (see image above).
  - > A list opens.
2. Select the required language. If more than four languages have been selected under **Settings**, it is possible to scroll in the list from the keyboard.
  - > The keyboard is adapted to the selected language and other word suggestions are given.

## Variants of a letter or character

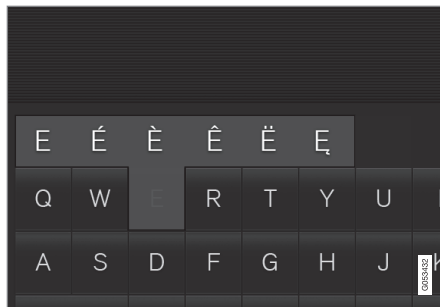

To enter a variant of a letter/character, e.g. **é** or **è**:

1. Press and hold the letter/character.
  - > A box with possible variants of the letter/character opens.
2. Press the required variant. If none of the variants are selected, the original letter/character is entered.

## Related information

- Settings view (p. 169)
- Operating the centre display (p. 36)
- Managing text messages (p. 461)
- Changing system settings in the settings view (p. 172)

## Writing characters/letters by hand on the screen

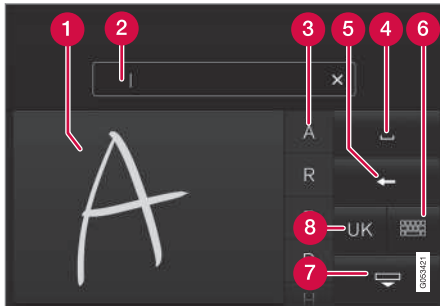

- 1 Area for writing letters/characters.
- 2 Text field where letters/characters are entered as they are drawn out on the screen.
- 3 Suggested letters/characters. The list is scrollable.
- 4 Space.
- 5 Undo entered text. Press briefly to delete one letter/character at a time. Wait a moment before pressing again to delete the next letter/character, etc.
- 6 Return to the keyboard with regular character input.

7 Hide the keyboard. If this is not possible, the button is not shown.

8 Change text input language.

### Writing characters/letters by hand

1. Write a character/letter in the area for handwritten letters (1).
  - > A number of suggested characters or letters is shown (3). The most likely choice is found at the top of the list.
2. Enter the character/letter by waiting a moment.
  - > The character/letter at the top of the list is entered. It is also possible to select a different character by pressing the required character/letter in the list.

### Deleting/changing characters/letters written by hand

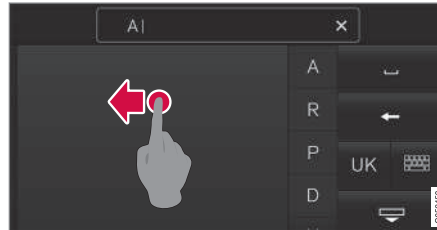

Delete all characters in the text field (2) by swiping across the handwriting field (1).

- There are several options for deleting/changing characters/letters:
  - Press the intended letter in the list (3).
  - Press the text undo button (5) to delete the letter and begin again.
  - Swipe horizontally from right to left<sup>12</sup> over the area for handwritten letters (1). Delete multiple letters by swiping over the area several times.
  - Pressing the X in the text field (2) deletes all of the entered text.

### Changing row in the free text field with handwriting

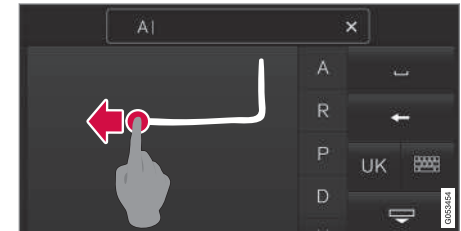

Change row by hand by drawing the above character in the handwriting field<sup>13</sup>.

### Related information

- Managing text messages (p. 461)
- Changing system settings in the settings view (p. 172)

<sup>12</sup> For Arabic keyboard - swipe in the opposite direction. Swiping from right to left creates a space.

<sup>13</sup> For Arabic keyboards - draw the same character, but reversed.

## Introduction to vehicle gas (Bi-Fuel)\*

Cars with Bi-Fuel engines can be driven on either vehicle gas or petrol. Vehicle gas can be biogas or natural gas, or a mixture of the two. Vehicle gas is also called CNG (Compressed Natural Gas).

Methane is the main component in vehicle gas. In natural gas, the methane content varies between 85% and 98%. In biogas, the content is almost 100%.

The tanks for vehicle gas are mounted under the floor in the cargo area and do not affect the normal petrol tank.

The system is tested in the same way as for petrol cars. The system is closed which means that leaks are avoided during filling, for example. The gas tanks are protected and are made to withstand a collision. The gas is lighter than air, non-toxic and has a higher ignition temperature than petrol and diesel. The risk of fire or explosions in the event of traffic accidents is therefore lower than with petrol and diesel.

The tank is equipped with a safety valve that allows the gas to evacuate from the tank in the event of abnormally high pressures. This valve ensures that the tank cannot explode.

### **WARNING**

In the event of an accident, the vehicle must be inspected and approved by an authorised Volvo workshop before it may be used again. Always notify the emergency services on site that the vehicle is equipped with a CNG-system.

### **WARNING**

Smoking and naked flames are prohibited during refuelling, service and repair work. In the event of a possible fire, leave the vehicle immediately and stand a safe distance away.

Do not under any circumstances disassemble or adjust the system or its component parts yourself. Carrying out such acts entails risk of serious personal injury. All service and repair work must therefore, for safety reasons, only be carried out by a trained mechanic - an authorized Volvo workshop is recommended.

### **WARNING**

If you smell gas in or around the vehicle, switch over to petrol immediately and have the vehicle checked by the nearest trained mechanics.

If the car is placed in a spray/paint curing booth with a drying temperature higher than 60 °C the system pressure must not exceed 50 bar, check that the CNG tank is almost empty for this.

SAFETY

## Safety

The vehicle is equipped with several safety systems that work together to protect the vehicle's driver and passengers in the event of an accident.

The car is equipped with a number of sensors that react in the event of an accident and activate different safety systems, such as different types of airbags and seatbelt tensioners. Depending on the specific accident situation, such as collisions at different angles, rollover or driving off the road, the systems react in different ways to provide the best protection.

There are also mechanical safety systems such as Whiplash Protection System. The car is also constructed so that a large part of the force of a collision is distributed to beams, pillars, floor, roof and other parts of the body.

The car's safety mode may be activated after a collision if an important function in the car has been damaged.

### Warning symbol in driver display



The warning symbol is illuminated in the driver display when the car's electrical system is set in ignition position II. The symbol is extinguished after

approx. 6 seconds if the car's safety system is fault-free.

### WARNING

If the warning symbol remains illuminated or is switched on during driving and the message **SRS airbag Service urgent Drive to workshop** is shown in the driver display, it means that part of one of the safety systems does not have full functionality. Volvo recommends that an authorised Volvo workshop should be contacted as soon as possible.



If the specific warning symbol is broken then the general warning symbol is illuminated instead and the driver display shows the same message.

### Related information

- Safety during pregnancy (p. 56)
- Seatbelt (p. 59)
- Airbags (p. 63)
- Whiplash Protection System (p. 57)
- Pedestrian Protection System (p. 58)
- Safety mode (p. 69)
- Child safety (p. 71)

## Safety during pregnancy

It is important that the seatbelt is used correctly during pregnancy, and that pregnant drivers adjust their seating position.

### Seatbelt

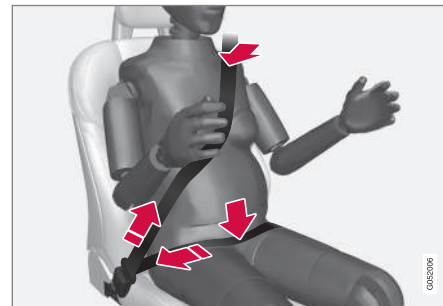

The diagonal section should wrap over the shoulder then be routed between the breasts and to the side of the abdomen.

The lap section should lay flat over the thighs and as low as possible under the abdomen. – It must never be allowed to ride upward. Remove the slack from the seatbelt and ensure that it fits as close to the body as possible. In addition, check that there are no twists in the seatbelt.

### Seating position

As the pregnancy progresses, pregnant drivers must adjust the seat and steering wheel such that they can easily maintain control of the vehi-

cle as they drive (which means that they must be able to easily operate the foot pedals and steering wheel). The aim should be to position the seat with as large a distance as possible between abdomen and steering wheel.

### Related information

- Safety (p. 56)
- Seatbelt (p. 59)
- Manual front seat (p. 121)
- Power front seat\* (p. 121)

## Whiplash Protection System

Whiplash Protection System (WHIPS) is a protection against whiplash injuries. The system consists of energy-absorbing backrests and seat cushions, and specially designed head restraints in the front seats.

WHIPS is deployed in the event of a rear-end collision, where the angle and speed of the collision and the nature of the colliding vehicle all have an influence.

When WHIPS is deployed, the front seat backrests are lowered backward and the seat cushions move downward to change the seating position of the driver and front seat passenger. This reduces the risk of whiplash injury.

### WARNING

WHIPS is a supplement to the seatbelts. Always use a seatbelt.

### WARNING

Never modify or repair the seat or WHIPS yourself. Volvo recommends that an authorised Volvo workshop should be contacted.

If the front seats have been subjected to a major load, such as in conjunction with a collision, the seats must be replaced. Some of the seats' protective properties may have been lost even if they do not appear damaged.

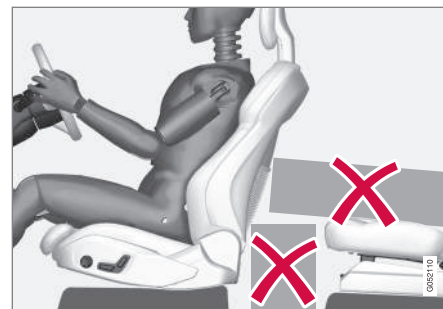

Do not leave any objects on the floor behind or under the front seats or in the rear seat that may prevent WHIPS from functioning.

### WARNING

Do not squeeze rigid objects between the rear seat cushion and the front seat's backrest.

### WARNING

If a rear seat backrest is folded down, the corresponding front seat must be moved forward so that it does not make contact with the folded backrest.

## Seating position

For optimum protection from WHIPS the driver and passenger must have the correct seating position and make sure that the system's function is not obstructed.



- ◀◀ Set the correct seating position in the front seat before driving starts.

Driver and front seat passenger should sit in the centre of the seat with as little space as possible between the head and the head restraint.

### WHIPS and child seats

The protection provided by the car to children seated in a child seat or on a booster cushion is not diminished by WHIPS.

### Related information

- Safety (p. 56)
- Manual front seat (p. 121)
- Power front seat\* (p. 121)
- Rear Collision Warning (p. 338)
- Child seats (p. 71)

## Pedestrian Protection System

The Pedestrian Protection System (PPS) is a system which, in certain frontal collisions, contributes to mitigating a pedestrian's impact with the car.

In certain frontal collisions with a pedestrian, the sensors in the front of the car react and the system is activated.

When PPS is activated, the following occur:

- The rear section of the bonnet is raised.
- An automatic alarm is sent via Volvo On Call\*.

The sensors are active at a speed of approx. 25-50 km/h (15-30 mph).

The sensors are designed to detect a collision with an object that has similar properties to those of the human leg.

### NOTE

There may be objects in the traffic environment that prompt a signal to the sensors that is similar to a collision with a pedestrian. It is possible that the system will be activated in the event of a collision with such an object.

### WARNING

Do not fit any accessories or change anything in the front. Incorrect intervention at the front may cause incorrect function in the system and lead to serious injury and damage to the car.

Volvo recommends that genuine wiper arms are used and that only genuine parts are used for them.

### WARNING

Volvo recommends contacting an authorised Volvo workshop in the event of any damage to the front of the car in order to ensure that the system is intact.

## Symbols in the driver display

Symbol	Specification
	PPS has been activated, or a fault has occurred in the system. Follow the recommendation given.

### Related information

- Safety (p. 56)



## Seatbelt

Heavy braking can have serious consequences if the seatbelts are not used.

It is important that the seatbelt lies against the body so it can provide maximum protection. Do not lean the backrest too far back. The seatbelt is designed to protect in a normal seating position.

### WARNING

Remember not to clip or hook the seatbelt to hooks or other interior fittings, as this prevents the belt from tightening properly.

### WARNING

The seatbelts and airbags interact. If a seatbelt is not used or is used incorrectly, this may diminish the protection provided by the airbag in the event of a collision.

### WARNING

Never modify or repair the seatbelts yourself. Volvo recommends that an authorised Volvo workshop should be contacted.

If the seatbelt has been subjected to a major load, such as in conjunction with a collision, the entire seatbelt must be replaced. Some of the seatbelt's protective properties may have been lost even if the seatbelt does not appear damaged. The seatbelt must also be replaced if it shows signs of wear or damage. The new seatbelt must be type-approved and designed for installation at the same location as the replaced seatbelt.

### Related information

- Safety (p. 56)
- Seatbelt tensioner (p. 59)
- Fastening/unfastening a seatbelt (p. 60)
- Door and seatbelt reminder (p. 62)

## Seatbelt tensioner

The car is fitted with pyrotechnic and electric seatbelt tensioners that can tension the seatbelts in critical situations and collisions.

### Seatbelt tensioner during collision

All the seatbelts are equipped with a pyrotechnic seatbelt tensioner.

The pyrotechnic seatbelt tensioner tensions the seatbelt in the event of a collision with sufficient force in order to more effectively restrain the occupant.

### Seatbelt tensioner during critical situations

The driver and front passenger seatbelts are equipped with an electric seatbelt tensioner.

The seatbelt tensioners work together and can be activated together with the driver support systems City Safety and Rear Collision Warning. In critical situations, such as panic braking, sharp evasive action, driving off the road (e.g. the car rolls over into a ditch, lifts off the ground or hits some off-road object), skidding, or risk of collision, the seatbelt can be tensioned by the seatbelt tensioner's electric motor.

The electric seatbelt tensioner adjusts the occupant to a better position, reducing the risk of striking the car's interior and improving the effect of safety systems, such as the car's airbags.



### **IMPORTANT**

If the passenger airbag is deactivated, the electric seatbelt tensioner on the passenger side will also be deactivated.

#### **Resetting the electric seatbelt tensioner**

Once the critical situation has passed, the seatbelt and electric seatbelt tensioner are reset automatically.

If the belt still remains tensioned:

1. Stop the car at a safe place.
2. Unfasten the seatbelt and then refasten it.
  - > The seatbelt and electric seatbelt tensioner are reset.

### **WARNING**

Never modify or repair the seatbelts yourself. Volvo recommends that an authorised Volvo workshop should be contacted.

If the seatbelt has been subjected to a major load, such as in conjunction with a collision, the entire seatbelt must be replaced. Some of the seatbelt's protective properties may have been lost even if the seatbelt does not appear damaged. The seatbelt must also be replaced if it shows signs of wear or damage. The new seatbelt must be type-approved and designed for installation at the same location as the replaced seatbelt.

#### **Related information**

- Seatbelt (p. 59)
- Fastening/unfastening a seatbelt (p. 60)
- Door and seatbelt reminder (p. 62)
- City Safety (p. 328)
- Rear Collision Warning (p. 338)
- Activating/deactivating the passenger airbag\* (p. 66)

#### **Fastening/unfastening a seatbelt**

Make sure that all passengers have fastened their seatbelts before starting to drive.

#### **Fastening a seatbelt**

1. Pull out the seatbelt slowly and make sure it is not twisted or damaged.

### **NOTE**

The seatbelt locks and cannot be withdrawn:

- if it is pulled out too quickly
- during braking and acceleration
- if the car leans heavily.

2. Lock the belt by inserting the locking tab in the intended buckle.
  - > A loud "click" indicates that the belt has locked.

### **WARNING**

Always insert the tongue of the seatbelt into the buckle on the correct side. The seatbelts and buckles would otherwise possibly not function as intended in the event of a collision. There is a risk of serious injury.

3. In the front seats the seatbelt can be adjusted for height.



Press together the seat mounting and move the seatbelt up or down.

Position the belt as high as possible without it chafing against your throat.

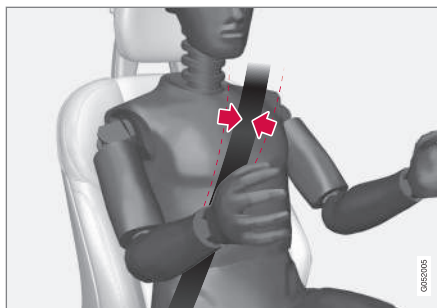

The seatbelt must pass over the shoulder (not down over the arm).

4. Tension the hip strap over the lap by pulling the diagonal shoulder belt up towards the shoulder.

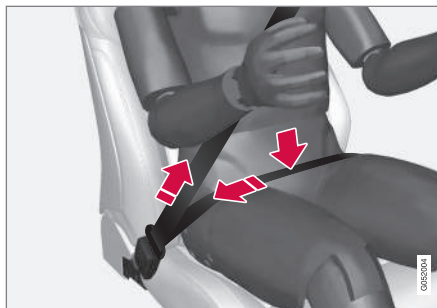

The hip strap must be positioned low down (not over the abdomen).

#### **⚠ WARNING**

Each seatbelt is designed for only one person.

#### **⚠ WARNING**

Remember not to clip or hook the seatbelt to hooks or other interior fittings, as this prevents the belt from tightening properly.

#### **⚠ WARNING**

Do not make any damages on seatbelts nor insert any foreign objects into a buckle. The seatbelts and buckles would then possibly not function as intended in the event of a collision. There is a risk of serious injury.

#### **Unfastening a seatbelt**

1. Press the red button on the seatbelt buckle and then let the belt retract.
2. If the seatbelt does not retract fully, feed it in by hand so that it does not hang loose.

#### **Related information**

- Seatbelt (p. 59)
- Seatbelt tensioner (p. 59)
- Door and seatbelt reminder (p. 62)

## Door and seatbelt reminder

The system reminds unbelted occupants to wear a seatbelt, and also warns about an open door, bonnet, tailgate or fuel filler flap.

### Driver display graphics

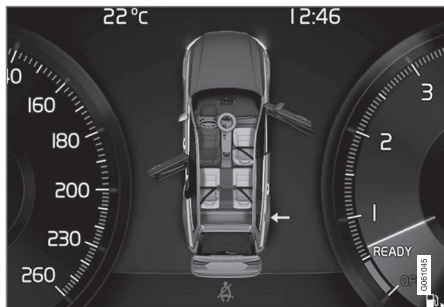

Graphics in the driver display with different types of warnings. The warning colour on the door and tailgate is dependent on the vehicle's speed.

The driver display's graphics show which seats in the car are occupied by belted and unbelted passengers.

The same graphic also shows if the bonnet, tailgate, fuel filler flap or any door is open.

The graphics are cleared automatically after approximately 30 seconds of driving, or by pressing on the right-hand the steering wheel keypad's **O** button.

## Seatbelt reminder



Visual reminder in the roof console.

A visual reminder is given in the roof console and by means of the warning symbol in the driver display.

The acoustic reminder is dependent on speed, driving time and distance.

The belt status of the driver and passengers is shown in the driver display graphics when a belt is buckled or unbuckled.

Child seats are not covered by the seatbelt reminder system.

### Front seat

A visual and acoustic reminder remind the driver and front seat passenger to use a seatbelt if either of them is not wearing one.

## Rear seat

The seatbelt reminder in the rear seat has two subfunctions:

- Provides information on which seatbelts are being used in the rear seat. The driver display's graphics are shown when the seatbelts are in use.
- Reminding that a seatbelt in the rear seat is unfastened during a journey by means of a visual and acoustic reminder. The reminder stops when the seatbelt is refastened, or it can be acknowledged manually by pressing the **O** button on the right-hand steering wheel keypad.

## Reminder for doors, bonnet, tailgate and fuel filler flap

If the bonnet, tailgate, fuel filler flap or a door is not closed properly, the driver display's graphics show what is open. Stop the car in a safe place as soon as possible and close the source of the warning.



If the car is driven at a speed lower than approx. 10 km/h (6 mph) then the driver display's information symbol illuminates.



If the car is driven at a speed higher than approx. 10 km/h (6 mph) then the driver display's warning symbol illuminates.

### Related information

- Seatbelt (p. 59)
- Seatbelt tensioner (p. 59)
- Fastening/unfastening a seatbelt (p. 60)

### Airbags

The car is equipped with airbags and inflatable curtains for driver and passengers.

#### WARNING

The airbag system's control module is located in the centre console. If the centre console is drenched with water or other liquid, disconnect the cables to the starter battery. Do not attempt to start the car since the airbags may deploy. Recovering the car. Volvo recommends that it is transported to an authorised Volvo workshop.

### Deployed airbags

If any of the airbags have deployed, the following is recommended:

- Recovering the car. Volvo recommends that it is transported to an authorised Volvo workshop. Do not drive with deployed airbags.
- Volvo recommends engaging an authorised Volvo workshop to handle the replacement of components in the car's safety systems.
- Always contact a doctor.

#### WARNING

Never drive with deployed airbags. They can make steering difficult. Other safety systems may also be damaged. The smoke and dust created when the airbags are deployed can cause skin and eye irritation/injury after intensive exposure. In case of irritation, wash with cold water. The rapid deployment sequence and airbag fabric may cause friction and skin burns.

### Related information

- Safety (p. 56)
- Driver and passenger airbags (p. 64)
- Side airbag (p. 68)
- Inflatable curtain (p. 69)

## Driver and passenger airbags

As a supplement to the seatbelts, the vehicle is equipped with airbags on the driver and passenger sides in the front seat.

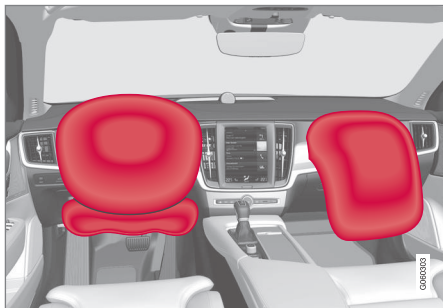

Driver and passenger airbags<sup>1</sup>.

In the event of a frontal collision, the airbags help to protect the head, face and chest of the driver and passenger as well as the knees and legs<sup>1</sup> of the driver.

A sufficiently violent collision trips the sensors and the airbag/airbags is inflated. The airbag cushions the initial collision impact for the occupant. The airbag deflates when compressed by the collision. When this occurs, smoke escapes into the car. This is completely normal. The entire

process, including inflation and deflation of the airbag, occurs within tenths of a second.

### **i** NOTE

The detectors react differently depending on the nature of the collision and whether or not the seatbelts are fastened. Applies to all belt positions.

It is therefore possible that only one (or none) of the airbags may inflate in a collision. The detectors sense the force of the collision on the vehicle and the action is adapted accordingly so that none, one or more airbags are deployed.

### **⚠** WARNING

The seatbelts and airbags interact. If the belt is not used or is used incorrectly, this may diminish the protection provided by the airbag in the event of a collision.

To minimise the risk of injury if the airbag deploys, passengers must sit as upright as possible with their feet on the floor and backs against the backrest.

### **⚠** WARNING

Volvo recommends that an authorised Volvo workshop should be contacted for repair. Defective work in the airbag system could cause malfunction and result in serious personal injury.

## Driver airbags

### **Airbag in the steering wheel**

This airbag is fitted into the centre of the steering wheel. The steering wheel is marked **AIRBAG**.

### **Knee airbag<sup>1</sup>**

The airbag is folded up in the lower part of the instrument panel on the driver's side. Its cover panel is marked **AIRBAG**.

### **⚠** WARNING

Do not place or attach any object on the top or front of the panel where the knee airbag is stowed.

## Passenger airbag

The airbag is folded up into a compartment above the glovebox. Its cover panel is marked **AIRBAG**.

<sup>1</sup> The car is only equipped with knee airbag in certain markets.

**⚠ WARNING**

Do not put objects in front of or above the dashboard where the passenger airbag is located.

**Label for passenger airbag**

Label on the passenger side's sun visor.



Label on the passenger side's door pillar. The label becomes visible when the passenger door is opened.

The warning label for the passenger airbag is positioned as shown above.

**⚠ WARNING**

If the car is not equipped with a switch to activate/deactivate the passenger airbag, the airbag will always be activated.

**⚠ WARNING**

Never allow anybody to stand or sit in front of the front passenger seat.

Never use a rear-facing child seat on the front passenger seat if the airbag is activated.

Front-facing passengers (children and adults) must never sit on the front passenger seat if the passenger airbag is deactivated.

Failure to follow the advice given above can endanger life or lead to serious personal injury.

**Related information**

- Airbags (p. 63)
- Activating/deactivating the passenger airbag\* (p. 66)

## Activating/deactivating the passenger airbag\*

The passenger airbag can be deactivated if the car is equipped with a switch, Passenger Airbag Cut Off Switch (PACOS).

### Switch

The switch for the passenger airbag is located on the passenger end of the instrument panel and is accessible when the passenger door is open.

Check that the switch is in the required position.

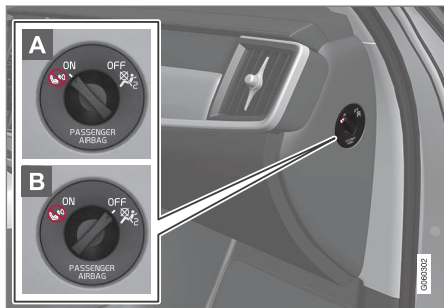

- A ON** - the airbag is activated and all front-facing passengers (children and adults) can sit safely on the passenger seat.
- B OFF** - The airbag is deactivated and children in rear-facing child seats can sit safely on the passenger seat.

### WARNING

If the car is not equipped with a switch to activate/deactivate the passenger airbag, the airbag will always be activated.

## Activating the passenger airbag



- 1** Pull the switch outward and turn from **OFF** (B) to **ON** (A).
  - > The driver display shows the message **Passenger airbag on Please acknowledge**.

### NOTE

If the passenger airbag has been activated/deactivated with the car in ignition position **I** or lower, a message is shown in the driver display and the following indicator in the roof console approx. 6 seconds after the car's electrical system has been set in ignition position **II**.



- Confirm the message by pressing the right-hand steering wheel keypad's **O** button.

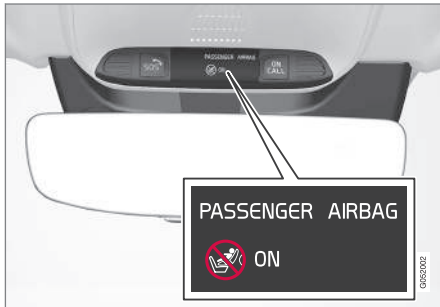

- > A text message and a warning symbol in the roof console indicate that the airbag for the front passenger seat is activated.

### **⚠ WARNING**

Never use a rear-facing child seat on the front passenger seat when the airbag is activated.

The passenger airbag must always be activated when front-facing passengers (children and adults) are sitting in the front passenger seat.

Failure to follow the advice given above can endanger life or lead to serious personal injury.

### Deactivating the passenger airbag



- Pull the switch outward and turn from **ON** (A) to **OFF** (B).

- > The driver display shows the message **Passenger airbag off Please acknowledge.**

### **i NOTE**

If the passenger airbag has been activated/deactivated with the car in ignition position **I** or lower, a message is shown in the driver display and the following indicator in the roof console approx. 6 seconds after the car's electrical system has been set in ignition position **II**.

- Confirm the message by pressing the right-hand steering wheel keypad's **O** button.

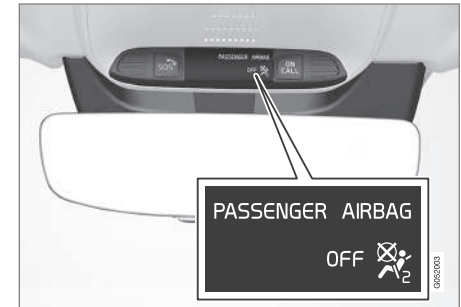

- > A text message and a symbol in the roof console indicate that the airbag for the front passenger seat is deactivated.

### **⚠ WARNING**

Front-facing passengers (children and adults) must never sit on the passenger seat when the airbag is deactivated.

Failure to follow the advice given above can endanger life or lead to serious personal injury.

### **! IMPORTANT**

If the passenger airbag is deactivated, the electric seatbelt tensioner on the passenger side will also be deactivated.

#### ◀ Related information

- Driver and passenger airbags (p. 64)
- Seatbelt tensioner (p. 59)
- Child seats (p. 71)

### Side airbag

The side airbags on the driver and passenger seats protect the chest and hip in the event of a collision.



The side airbags are fitted in the outer backrest frames of the front seats and help to protect the driver and passengers in the front seat.

A sufficiently violent collision trips the sensors and the side airbags are inflated. The airbag inflates between the occupant and the door panel and thereby cushions the initial impact. The airbag deflates when compressed by the collision. The side airbag is normally only deployed on the side of the collision.

#### **⚠ WARNING**

Volvo recommends that an authorised Volvo workshop should be contacted for repair. Defective work in the side airbag system could cause malfunction and result in serious personal injury.

#### **⚠ WARNING**

Do not put objects in the area between the outside of the seat and the door panel, since this area is required by the side airbag.

Volvo recommends the use only of car seat covers approved by Volvo. Other seat covers may impede the operation of the side airbags.

#### **⚠ WARNING**

Side airbags are a supplement the seatbelts. Always use a seatbelt.

### Side airbag and child seats

The protection provided by the car to children seated in a child seat or on a booster cushion is not diminished by the side airbag.

#### Related information

- Airbags (p. 63)
- Child seats (p. 71)

## Inflatable curtain

The inflatable curtain, Inflatable Curtain (IC), helps to prevent the driver and passengers from striking their heads on the inside of the car during a collision.

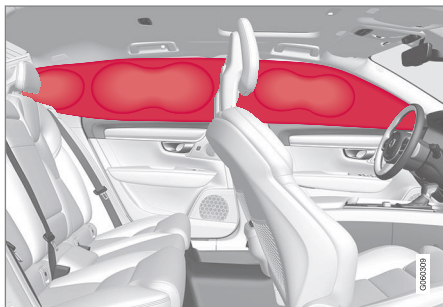

The inflatable curtain is mounted along both sides of the headlining and helps protect the driver and outer seat passengers of the car. The panels are labelled with **IC AIRBAG**.

A sufficiently violent collision trips the sensors and the inflatable curtain is inflated.

### WARNING

Never hang or attach heavy items onto the handles in the roof. The hooks are only designed for light coats and jackets (not for solid objects such as umbrellas).

Do not screw or install anything onto the car's headlining, door pillars or side panels. This could compromise the intended protection. Volvo recommends only using Volvo genuine parts that are approved for fitting within these areas.

### WARNING

Leave 10 cm space between the load and the side windows if the car is loaded to above the top edge of the door windows. Otherwise, the intended protection of the inflatable curtain, which is concealed in the headlining, may be compromised.

### WARNING

The inflatable curtain is a supplement to the seatbelts. Always use a seatbelt.

## Related information

- Airbags (p. 63)

## Safety mode

Safety mode is a protective state that is triggered when a collision may have damaged any of the car's vital functions, such as the fuel lines, sensors for any of the safety systems, or the brake system.

If the car has been involved in a collision, the text **Safety mode See Owner's manual** is shown in the driver display together with the warning symbol. This means that the car has reduced functionality.

If the car is set in safety mode, it is possible to try to reset the system and then start and move the car from a dangerous position.

### WARNING

Never attempt to repair your car or reset the electronics yourself if the car has been in safety mode. This could result in personal injury or the car not functioning as normal. Volvo recommends that engaging an authorised Volvo workshop to check and restore the car to normal status after **Safety mode See Owner's manual** has been shown.

### WARNING

If the car is in safety mode it must not be towed. It must be transported from its location. Volvo recommends that it is transported to an authorised Volvo workshop.

#### ◀◀ Related information

- Safety (p. 56)
- Starting/moving the car after safety mode (p. 70)

### Starting/moving the car after safety mode

If the car is set in safety mode, it is possible to try to start and then move the car from a dangerous position.

#### Starting the car after safety mode

1. First, check that no fuel is leaking from the car. There must be no smell of fuel either.

If everything seems normal and you have checked for indications of fuel leakage, you may attempt to start the car.

#### WARNING

Never, under any circumstances, attempt to restart the car if it smells of fuel when the **Safety mode See Owner's manual** message is shown in the driver display. Leave the car at once.

2. Turn the start knob to **STOP** and release it.

3. Then try to start the car.
  - > The car's electronics carry out a systems check and then try to resume normal status.

#### IMPORTANT

If the message **Safety mode See Owner's manual** is still shown on the display the car must not be driven or towed but a vehicle recovery service must then be used instead. Even if the car appears to be driveable, hidden damage may make the car impossible to control once moving.

### Moving the car after safety mode

1. If the message **Normal mode The car is now in normal mode** is shown in the driver display after a start attempt, the car can be moved carefully out of a dangerous position.
2. Do not move the car further than necessary.

#### WARNING

If the car is in safety mode it must not be towed. It must be transported from its location. Volvo recommends that it is transported to an authorised Volvo workshop.

### Related information

- Safety mode (p. 69)

## Child safety

Volvo has child safety equipment (child seats, booster cushions and attachment devices) which is designed for fitting in this particular car.

Using Volvo's child safety equipment, the optimum conditions are obtained for the child to travel safely in the car. In addition, the child safety equipment fits well and is simple to use.

Children of all ages and sizes must always sit correctly secured in the car. Never allow a child to sit on the knee of a passenger.

Volvo recommends that children travel in rear-facing child seats until as late an age as possible, at least up to 3-4 years of age, and then in front-facing booster cushions/child seats until the child is 140 cm tall.

### **i** NOTE

Legal provisions about the type of child seat that must be used for children of different ages and heights vary from country to country. Check what does apply.

### **i** NOTE

In the event of questions when fitting child safety products, contact the manufacturer for clearer instructions.

## Related information

- Safety (p. 56)
- Child seats (p. 71)
- Integrated booster cushion\* (p. 82)

## Child seats

The position of a child in the car and the choice of equipment are dictated by the child's weight and size.

Children should sit comfortably and safely. Make sure that the child seat is being used correctly.

Look in the installation instructions for the child seat for the correct fitting.

### **i** NOTE

When using child safety products it is important to read the installation instructions included.

## Location of child seats



Rear-facing child seat and airbag are not compatible.

Always fit rear-facing child seats in the rear seat if the passenger airbag is activated. If a child is



## SAFETY

- ◀ sitting on the front passenger seat then he/she could suffer serious injury if the airbag deploys.

If the passenger airbag is deactivated then rear-facing child seats can be fitted on the front passenger seat.

### **i** NOTE

Regulations regarding the placement of children in cars vary from country to country. Check what does apply.

### **⚠** WARNING

Never allow anybody to stand or sit in front of the front passenger seat.

Never use a rear-facing child seat on the front passenger seat if the airbag is activated.

Front-facing passengers (children and adults) must never sit on the front passenger seat if the passenger airbag is deactivated.

Failure to follow the advice given above can endanger life or lead to serious personal injury.

### Child seat installation

The following points are important to consider when a child seat is being fitted in the car.

### **⚠** WARNING

Booster cushions/child seats with steel braces or some other design that could rest on the seatbelt buckle's opening button must not be used, as they could cause the seatbelt buckle to open accidentally.

Do not secure the straps for the child seat into the seat's horizontal adjustment bar or in springs, rails or beams under the seat. Sharp edges may damage the straps.

Do not allow the upper section of the child seat to rest against the windscreen.

### Installation in the front seat

- When fitting rear-facing child seats, check that the passenger airbag is deactivated.
- When fitting front-facing child seats, check that the passenger airbag is activated.
- Only use child seats that are recommended by Volvo, are universally approved or are semi-universal, and where the car is included on the manufacturer's vehicle list.
- ISOFIX child seats can only be fitted when the car is equipped with the ISOFIX console<sup>2</sup> accessory.
- If the child seat is equipped with lower straps, Volvo recommends that the lower mounting points are used with these<sup>2</sup>.

- The ISOFIX guide can be used in order to facilitate child seat installation.

### Installation in the rear seat

- Only use child seats that are recommended by Volvo, are universally approved or are semi-universal, and where the car is included on the manufacturer's vehicle list.
- A child seat with support legs must not be fitted in the centre seat.
- The outer seats are equipped with the ISOFIX fixture system and are approved for i-Size<sup>3</sup>.
- The outer seats are equipped with upper mounting points. Volvo recommends that child seat's upper straps should be pulled through the hole in the head restraint before being tensioned at the mounting point. If this is not possible, follow the recommendations from the child seat manufacturer.
- If the child seat is equipped with lower straps, never adjust the position of the seat in front after the straps have been fitted in the lower mounting points. Always remember to remove the lower straps when the child seat is not installed.

<sup>2</sup> The accessory range varies depending on market.

<sup>3</sup> Varies depending on market.

### Label for passenger airbag



Label on the passenger side's sun visor.



Label on the passenger side's door pillar. The label becomes visible when the passenger door is opened.

The warning label for the passenger airbag is positioned as shown above.

### Related information

- Child safety (p. 71)
- Upper mounting points for child seats (p. 73)
- Lower mounting points for child seats (p. 74)
- i-Size/ISOFIX mounting points (p. 77)
- Activating/deactivating the passenger airbag\* (p. 66)

### Upper mounting points for child seats

The car is equipped with upper mounting points for child seats on the rear seat's outer seats.

The upper mounting points are primarily intended for use with front-facing child seats.

Always follow the manufacturer's installation instructions when connecting a child seat to the upper mounting points.

### The location of the mounting points

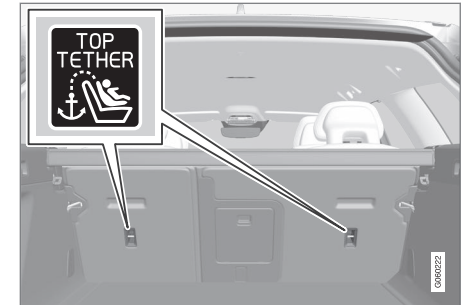

Mounting point locations are indicated by symbols on the rear of the backrest.

The mounting points are located on the rear of the rear seat's outer seats.





## **⚠ WARNING**

The child seat's upper straps must be routed through the hole in the head restraint leg before they are tensioned at the mounting point. If this is not possible, follow the recommendations from the child seat manufacturer.

## **i NOTE**

Fold the head restraints in order to facilitate fitting this type of child seat in cars with folding head restraints on the outer seats.

## **i NOTE**

In cars with a cargo cover over the luggage compartment, this must be removed before child seats can be attached to the securing points.

### **Related information**

- Child seats (p. 71)
- Lower mounting points for child seats (p. 74)
- i-Size/ISOFIX mounting points (p. 77)
- Table for location of child seats using the car's seatbelts (p. 75)

## **Lower mounting points for child seats**

The car is equipped with lower mounting points for child seats in the front seat\* and the rear seat.

The lower mounting points are designed to be used in conjunction with certain rear-facing child seats.

Always follow the manufacturer's installation instructions when connecting a child seat to the lower mounting points.

### **The location of the mounting points**



Mounting point locations in the front seat.

The mounting points in the front seat are located on the sides of the passenger seat's legroom.

The mounting points in the front seat are only mounted if the vehicle is equipped with a switch to activate/deactivate the passenger airbag\*.

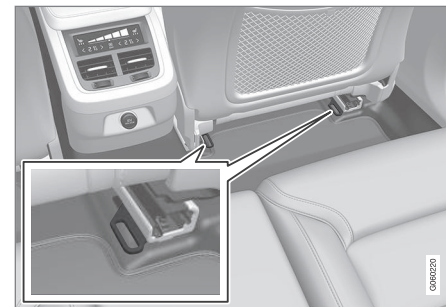

Mounting point locations in the rear seat.

The mounting points in the rear seat are located on the rear section of the front seat's floor rails.

### **Related information**

- Child seats (p. 71)
- Upper mounting points for child seats (p. 73)
- i-Size/ISOFIX mounting points (p. 77)
- Table for location of child seats using the car's seatbelts (p. 75)
- Activating/deactivating the passenger airbag\* (p. 66)



## Table for location of child seats using the car's seatbelts

The table gives a recommendation for which child seats suit which locations, and for what size of child.

<b>i</b> <b>NOTE</b>
Always read the section "Child seats" before fitting a child seat in the car.

Weight	Front seat (with deactivated airbag, only rear-facing child seats)	Front seat (with activated airbag, only front-facing child seats)	Outer rear seat	Centre rear seat
Group 0 max 10 kg	U <sup>A, B</sup>	X	U <sup>B</sup>	U <sup>B</sup>
Group 0+ max 13 kg	U <sup>A, B</sup>	X	U <sup>B</sup>	U <sup>B</sup>
Group 1 9-18 kg	L <sup>C</sup>	U <sup>F, A, D</sup>	U, L <sup>C</sup>	U
Group 2 15-25 kg	L <sup>C</sup>	U <sup>F, A</sup>	U <sup>E, F</sup> , B <sup>*, G</sup> , L <sup>C</sup>	U <sup>E</sup>





Weight	Front seat (with deactivated airbag, only rear-facing child seats)	Front seat (with activated airbag, only front-facing child seats)	Outer rear seat	Centre rear seat
Group 3 22-36 kg	X	UF <sup>A</sup>	U <sup>F,H</sup> , B <sup>*,G</sup>	U <sup>H</sup>

U: Suitable for universal category restraints approved for use in this mass group.

UF: Suitable for front-facing universally approved child seats.

L: Suitable for particular child restraints. These restraints may be of the specific vehicle, restricted or semi-universal categories.

B: Built-in restraint approved for this mass group.

X: The seat is not suitable for children in this mass group.

A Adjust the backrest to a more upright position.

B Volvo recommends: Volvo infant seat (type approval E1 04301146).

C Volvo recommends: Volvo reversible seat in the rear-facing position (type approval E5 04192); Volvo rear-facing seat (type approval E5 04212).

D Volvo recommends rear-facing child seat for children in this mass group.

E Volvo recommends: Volvo reversible seat in the front-facing position (type approval E5 04191); booster cushion with and without back (type approval E5 04216); Volvo booster cushion with backrest (type approval E1 04301169); Volvo booster seat (type approval E1 04301312).

F Volvo recommends: Römer KidFix XP (type approval E1 04301312).

G Volvo recommends: integrated booster cushion.

H Volvo recommends: booster cushion with and without back (type approval E5 04216); Volvo booster cushion with backrest (type approval E1 04301169).

### WARNING

Never use a rear-facing child seat on the front passenger seat if the passenger airbag is activated.

- Table for location of i-Size child seats (p. 81)

### Related information

- Child seats (p. 71)
- Upper mounting points for child seats (p. 73)
- Table for location of ISOFIX child seats (p. 78)

## i-Size/ISOFIX mounting points

The car is equipped with i-Size/ISOFIX<sup>4</sup> mounting points for child seats in the rear seat.

i-Size/ISOFIX is a fixture system for car child seats that is based on an international standard.

Always follow the manufacturer's installation instructions when connecting a child seat to the i-Size/ISOFIX mounting points.

### The location of the mounting points



Mounting point locations are indicated by symbols<sup>4</sup> on the upholstery of the backrest.

The mounting points for i-Size/ISOFIX are located behind covers in the lower section of the rear seat's backrest, in the outer seats.

Lift the covers in order to access the mounting points.

### Related information

- Child seats (p. 71)
- Upper mounting points for child seats (p. 73)
- Lower mounting points for child seats (p. 74)
- Table for location of i-Size child seats (p. 81)
- Table for location of ISOFIX child seats (p. 78)

<sup>4</sup> Names and symbols change depending on market.

### Table for location of ISOFIX child seats

The table gives a recommendation for which ISOFIX child seats suit which locations, and for what size of child.

The child seat must be approved in accordance with UN Reg R44 and the car model must be included in the manufacturer's vehicle list.

<b>i NOTE</b>
Always read the section "Child seats" before fitting a child seat in the car.

Weight	Size class <sup>A</sup>	Type of child seat	Front seat (with deactivated air-bag, only rear-facing child seats) <sup>B</sup>	Front seat (with activated air-bag, only front-facing child seats) <sup>B</sup>	Outer rear seat	Centre rear seat
Group 0 max 10 kg	E	Rear-facing infant seat	IL <sup>B,C</sup> , X <sup>D</sup>	X	IL <sup>C</sup>	X
Group 0+ max 13 kg	E	Rear-facing infant seat	IL <sup>B,C,E</sup> , X <sup>D</sup>	X	IL <sup>C</sup>	X
	C	Rear-facing child seat				
	D	Rear-facing child seat				

Weight	Size class <sup>A</sup>	Type of child seat	Front seat (with deactivated air-bag, only rear-facing child seats) <sup>B</sup>	Front seat (with activated air-bag, only front-facing child seats) <sup>B</sup>	Outer rear seat	Centre rear seat
Group 1 9-18 kg	A	Front-facing child seat	X	IL <sup>B, E, F</sup> , X <sup>D</sup>	IL <sup>F</sup> , IU <sup>F</sup>	X
	B	Front-facing child seat				
	B1	Front-facing child seat				
	C	Rear-facing child seat	IL <sup>B, E</sup> , X <sup>D</sup>	X	IL <sup>G</sup>	X
	D	Rear-facing child seat				

IL: Suitable for particular ISOFIX child restraint systems. These child restraint systems are those of the specific vehicle, restricted or semi-universal categories.

IUF: Suitable for ISOFIX forward child restraint systems of universal category approved for use in the mass group.

X: Not suitable for ISOFIX child restraint systems.

<sup>A</sup> For child seats with the ISOFIX fixture system there is a size classification to help users choose the right type of child seat. The size class can be read on the child seat's label.

<sup>B</sup> Works for the installation of ISOFIX child seats that are semi-universally approved (IL) if the car is equipped with the ISOFIX console accessory (the accessory range varies depending on market).

<sup>C</sup> Volvo recommends: Volvo infant seat secured using the ISOFIX fixture system (type approval E1 04301146).

<sup>D</sup> Applicable if the car is not fitted with an ISOFIX bracket.

<sup>E</sup> Adjust the backrest so that the head restraint does not touch the child seat.

<sup>F</sup> Volvo recommends rear-facing child seat for children in this mass group.

<sup>G</sup> Volvo recommends: BeSafe iZi Kid X3 ISOfix (type approval E5 04200).

### WARNING

Never use a rear-facing child seat on the front passenger seat if the passenger airbag is activated.

### NOTE

If an i-Size/ISOFIX child seat has no size classification, the car model must be included on the vehicle list for the child seat.

### NOTE

Volvo recommends contacting an authorised Volvo dealer for information about which i-Size/ISOFIX child seats Volvo recommends.

◀◀ **Related information**

- Child seats (p. 71)
- i-Size/ISOFIX mounting points (p. 77)
- Table for location of i-Size child seats (p. 81)
- Table for location of child seats using the car's seatbelts (p. 75)

## Table for location of i-Size child seats

The table gives a recommendation for which i-Size child seats suit which locations, and for what size of child.

The child seat must be approved in accordance with UN Reg R129.

<b>i NOTE</b>
Always read the section "Child seats" before fitting a child seat in the car.

Type of child seat	Front seat (with deactivated airbag, only rear-facing child seats)	Front seat (with activated airbag, only front-facing child seats)	Outer rear seat	Centre rear seat
i-Size child seats	X	X	i-U <sup>A</sup>	X

i-U: Suitable for i-Size "universal" child seat, front-facing and rear-facing.

X: Not suitable for universally approved child seats.

<sup>A</sup> Volvo recommends rear-facing child seats for this group.

### Related information

- Child seats (p. 71)
- i-Size/ISOFIX mounting points (p. 77)
- Table for location of ISOFIX child seats (p. 78)
- Table for location of child seats using the car's seatbelts (p. 75)

## Integrated booster cushion\*

The integrated booster cushions on the outer seats in the rear seat allow children to sit comfortably and safely.

The booster cushion is specially designed to provide optimum safety. In combination with the seatbelt it is approved for children who weigh between 15 and 36 kg and who are at least 97 cm in height.

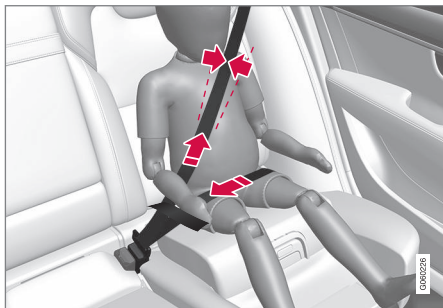

Correct position, the seatbelt must pass over the shoulder.

Check before driving that:

- the integrated booster cushion is in locked mode
- the seatbelt is in contact with the child's body and is not slack or twisted
- the seatbelt does not lie across the child's throat or below the shoulder

- the lap section of the seatbelt is positioned low over the pelvis to provide optimal protection.

### WARNING

Volvo recommends that repair or replacement is only carried out by an authorised Volvo workshop. Do not make any modifications or additions to the booster cushion. If an integrated booster cushion has been subjected to a major load, such as in conjunction with a collision, the entire booster cushion must be replaced. Even if the booster cushion appears to be undamaged, it may not afford the same level of protection. The booster cushion must also be replaced if it is heavily worn.

### WARNING

If the instructions for the integrated booster cushion are not followed then the child could sustain serious injury in the event of an accident.

## Related information

- Child safety (p. 71)
- Folding up the integrated booster cushion\* (p. 82)
- Folding down the integrated booster cushion\* (p. 84)

## Folding up the integrated booster cushion\*

The integrated booster cushions on the outer seats in the rear seat are folded up for use.

The booster cushion can be folded up in two positions. The position that should be used depends on the weight of the child.

	Lower position	Upper position
Weight	22-36 kg	15-25 kg

Lower position:

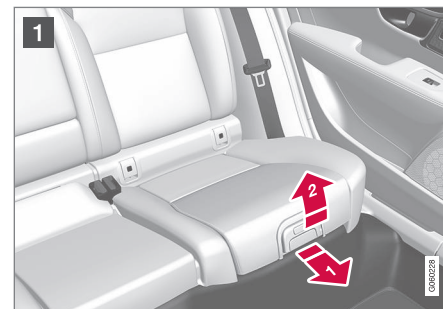

- 1 Pull the handle forward and up in order to release the booster cushion.





- 2** Press the booster cushion backwards to lock. Upper position, start from the lower position:



- 1** Press the button to release the booster cushion.

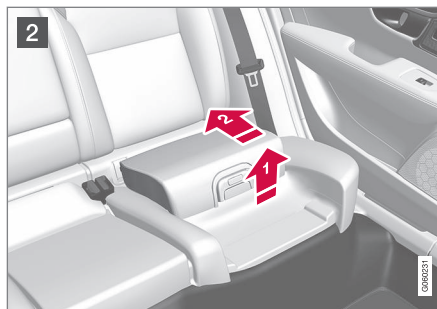

- 2** Lift the booster cushion up at the front edge and press it back against the backrest to lock.

### **WARNING**

If the instructions for the integrated booster cushion are not followed then the child could sustain serious injury in the event of an accident.

### **NOTE**

It is not possible to adjust the booster seat from the upper position to the lower position. From the upper position, the booster seat must first be fully lowered into the seat cushion, and then folded up to the lower position.

### Related information

- Integrated booster cushion\* (p. 82)
- Folding down the integrated booster cushion\* (p. 84)

## Folding down the integrated booster cushion\*

The integrated booster cushions on the outer seats in the rear seat can be folded down when not in use.

### **i** NOTE

It is not possible to adjust the booster seat from the upper position to the lower position. From the upper position, the booster seat must first be fully lowered into the seat cushion, and then folded up to the lower position.



- 1** Pull the handle forwards to release the cushion.



- 2** Press down with your hand in the centre of the cushion in order to lock it.

### **!** IMPORTANT

Check that there are no loose objects (e.g. toys) left behind in the space under the cushion before lowering.

### **i** NOTE

Before the rear backrest is lowered, the booster cushion must be lowered first.

### Related information

- Integrated booster cushion\* (p. 82)
- Folding up the integrated booster cushion\* (p. 82)

# INSTRUMENTS AND CONTROLS

## Instruments and controls, left-hand drive car

The overviews show where the displays and controls near the driver are located.

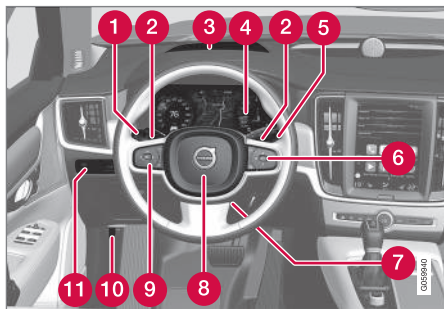

	Display/function/control
1	Position lamps, daytime running lights, dipped beam, main beam, direction indicators, front fog lamps/cornering lights*, rear fog lamp, resetting the trip meter
2	Steering wheel paddles for manual gear changing in an automatic gearbox*
3	Head-up display*
4	Driver display
5	Wipers and washing, rain sensor*

	Display/function/control
6	Right-hand steering wheel keypad
7	Steering wheel adjustment
8	Horn
9	Left-hand steering wheel keypad
10	Bonnet opening
11	Display lighting, tailgate unlocking, tailgate opening/closing*, halogen head-lamp levelling



	Display/function/control
1	Front reading lamps and interior lighting
2	Panorama roof*
3	Display in roof console
4	Manual dimming of interior rearview mirror

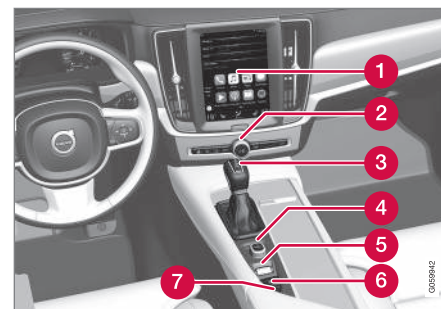

	Display/function/control
1	Centre display
2	Hazard warning flashers, max defroster/heated windscreen*, media, glovebox door opening
3	Gear selector

	Display/function/control
4	Ignition dial
5	Drive mode control*
6	Parking brake
7	Automatic braking when stationary

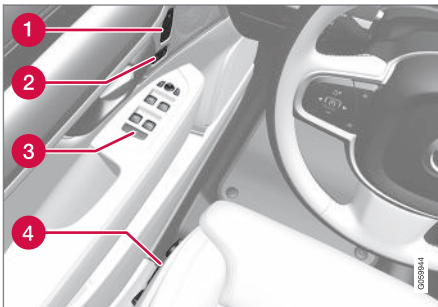

	Display/function/control
1	Memory for setup of: <ul style="list-style-type: none"> <li>power front seat*</li> <li>Door mirrors</li> <li>Head-up display*</li> </ul>
2	Door opening, locking/unlocking of side doors and tailgate

	Display/function/control
3	Power windows, door mirrors
4	Adjusting front seat

## Instruments and controls, right-hand drive car

The overviews show where the displays and controls near the driver are located.

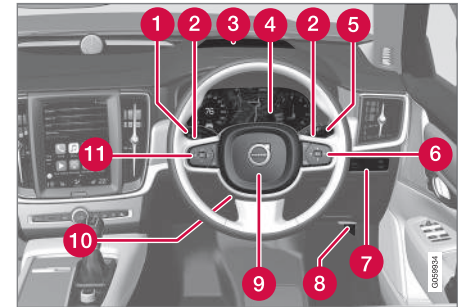

	Display/function/control
1	Position lamps, daytime running lights, dipped beam, main beam, direction indicators, front fog lamps/cornering lights*, rear fog lamp, resetting the trip meter
2	Steering wheel paddles for manual gear changing in an automatic gearbox*
3	Head-up display*
4	Driver display
5	Wipers and washing, rain sensor*





	Display/function/control
6	Right-hand steering wheel keypad
7	Display lighting, unlocking the tailgate, opening/closing the tailgate*
8	Bonnet opening
9	Horn
10	Steering wheel adjustment
11	Left-hand steering wheel keypad



	Display/function/control
1	Front reading lamps and interior lighting
2	Panorama roof*
3	Display in roof console
4	Manual dimming of interior rearview mirror

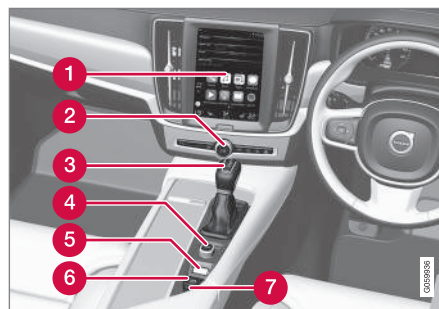

	Display/function/control
1	Centre display
2	Hazard warning flashers, max defroster/ heated windscreen*, media, glovebox door opening
3	Gear selector

	Display/function/control
4	Ignition dial
5	Drive mode control*
6	Parking brake
7	Automatic braking when stationary

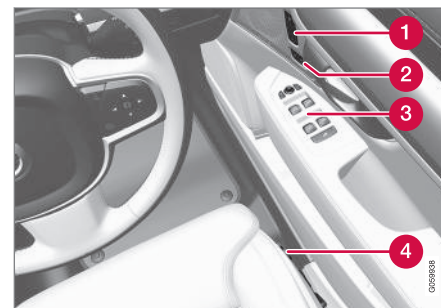

	Display/function/control
1	Memory for setup of: <ul style="list-style-type: none"> <li>• power front seat*</li> <li>• Door mirrors</li> <li>• Head-up display*</li> </ul>
2	Door opening, locking/unlocking of side doors and tailgate

	Display/function/control
3	Power windows, door mirrors
4	Adjusting front seat

### Driver display

The driver display shows information about the car and driving.

The driver display contains gauges, indicators and indicator and warning symbols. The content of the driver display depends on the car's equipment, settings and which functions are active at that time.

The driver display is available in two versions, 12-inch and 8-inch.

#### **⚠ WARNING**

In the event of a fault in the driver display the information on e.g. brakes, airbags or other safety systems may not be shown. In which case, the driver cannot check the status of the car's systems or receive current warnings and information.

#### **⚠ WARNING**

If the driver display should extinguish, not illuminate on activation/start or be fully or partially illegible, the car must not be used. You should visit a workshop immediately. Volvo recommends an authorised Volvo workshop.

### Driver display, 12-inch



Location in the driver display:

On the left	In the middle	On the right
Speedometer	Indicator and warning symbols	Tachometer <sup>A</sup>
Trip meter	Outside temperature gauge	ECO gauge <sup>A</sup>
Odometer	Clock	Gear shift indicator
Cruise control and speed limiter information	Messages, in some cases with graphics	Drive mode
Road Sign Information*	Door and seatbelt information	Fuel gauge



On the left	In the middle	On the right
–	Media player	Status of the Start/Stop function
–	Navigation map*	Distance to empty tank
–	Phone	Instantaneous fuel consumption
–	Voice recognition	App menu (activated via steering wheel keypad)

A Depending on selected drive mode.

### Driver display, 8-inch



Location in the driver display:

On the left	In the middle	On the right
Fuel gauge	Speedometer	Media player
Drive mode	Road Sign Information*	Phone



## INSTRUMENTS AND CONTROLS



On the left	In the middle	On the right
Gear shift indicator	Cruise control and speed limiter information	Navigation information*
Tachometer <sup>A</sup>	Door and seatbelt information	Clock
ECO gauge <sup>A</sup>	Status of the Start/Stop function	App menu (activated via steering wheel keypad)
Distance to empty tank	–	Instantaneous fuel consumption
Outside temperature gauge	–	Odometer
Indicator and warning symbols	–	Trip meter
–	–	Indicator and warning symbols
–	–	Voice recognition
–	–	Engine temperature gauge
–	–	Messages, in some cases with graphics

<sup>A</sup> Depending on selected drive mode.

\* Option/accessory.

### Location of adaptable symbol



Example of indicator symbol in the 12-inch driver display.

In the centre of the driver display, different symbols can be shown for different types of message. It may be in the form of an indicator or warning symbol, or consist of an image sequence that starts from this position and is then converted to a larger image.

### Activating the driver display

The driver display is activated as soon as a door is opened, i.e. in ignition position **0**. The driver display extinguishes after a while if it is not used. To reactivate it, proceed with one of the following:

- Depress the brake pedal.
- Turn the ignition knob to ignition position to **I**.
- Open one of the doors.

### Related information

- Driver display settings (p. 94)
- Indicator symbols in the driver display (p. 95)
- Warning symbols in the driver display (p. 97)
- Application menu in the driver display (p. 105)
- License agreement for the driver display (p. 100)

## Driver display settings

Settings for the driver display can be made in the driver display's application menu, and in the centre display's **Settings** menu.

### Settings in the app menu

In the app menu, you can choose which information is shown on the driver display from

- trip computer
- media player
- phone
- navigation system\*.

The application menu in the driver display is opened and navigated using the steering wheel's right-hand keypad, see the section "Using the application menu in the driver display".

### Settings in the centre display

#### Selecting information type

1. Tap on **Settings** in the centre display's top view.
2. Press **My Car → Displays → Driver Display Information**.

3. Select what should be shown in the background:
  - **Show no information in background**
  - **Show information for current playing media**
  - **Show navigation even if no route is set**<sup>1</sup>.

The 12-inch driver display shows the information in the centre, and the 8-inch driver display shows the information in the top right-hand field.

#### Selecting theme

1. Tap on **Settings** in the centre display's top view.
2. Tap on **My Car → Displays → Display Themes**
3. Select a theme (appearance) for the driver display:
  - **Glass**
  - **Minimalistic**
  - **Performance**
  - **Chrome Rings**.

#### Selecting language

1. Tap on **Settings** in the centre display's top view.

2. Tap on **System → System Language** to select language.
  - > A change will affect the language in all displays.



#### Related information



- Driver display (p. 90)
- Application menu in the driver display (p. 105)
- Settings view (p. 169)







<sup>1</sup> The map is only shown with 12-inch driver display. In the 8-inch driver display, only guidance is shown. For more information, see the section "Displays and controls for map navigation" and "Map navigation in the driver display".

## Indicator symbols in the driver display

The indicator symbols alert the driver that a function is activated, that a system is operating, or that a fault or abnormal condition exists.

Symbol	Specification
	<b>Information, read display text</b> When one of the car's systems does not behave as intended, this information symbol illuminates and a text appears on the driver display. The information symbol can also illuminate in conjunction with other symbols.
	<b>Fault in brake system</b> The symbol lights up when there is a fault in the parking brake.
	<b>ABS fault</b> If this symbol illuminates then the system is not working. The car's regular brake system continues to work, but without the ABS function.

Symbol	Specification
	<b>Automatic brake on</b> The symbol illuminates when the function is activated and the foot brake or parking brake is acting. The brake holds the car stationary when it has stopped.
	<b>Tyre pressure system</b> The symbol illuminates when tyre pressure is too low. If there is a fault in the tyre pressure system, the symbol will flash for approx. 1 minute and then illuminate with a constant glow. This may be because the system cannot detect or warn of low tyre pressure as intended.
	<b>Emissions system</b> If the symbol illuminates after the engine has been started then it may be due to a fault in the car's emissions system. Drive to a workshop for checking. Volvo recommends that an authorised Volvo workshop is contacted.

Symbol	Specification
 	<b>Left and right-hand direction indicator</b> The symbols flash when the direction indicators are used.
	<b>Position lamps</b> The symbol lights up when the position lamps are switched on.
	<b>Fault in the headlamp system</b> The symbol illuminates if a fault has occurred in the ABL function (Active Bending Lights) or if another fault has occurred in the headlamp system.
	<b>Active main beam on</b> The symbol lights up blue when the automatic main beam is on.
	<b>Active main beam off</b> The symbol lights up white when the automatic main beam is off.



Symbol	Specification
	<b>Main beam On</b> The symbol illuminates when main beam is on and with main beam flash.
	<b>Active main beam on</b> The symbol lights up blue when active main beam is on. Position lamps are switched on.
	<b>Active main beam off</b> The symbol lights up white when active main beam is off. Position lamps are switched on.
	<b>Main beam On</b> The symbol lights up when main beam and the position lamps are switched on.
	<b>Front fog lamps on</b> This symbol illuminates when the front fog lamp is switched on.
	<b>Rear fog lamp on</b> This symbol illuminates when the rear fog lamp is switched on.

Symbol	Specification
	<b>Rain sensor on</b> This symbol illuminates when the rain sensor is on.
	<b>Preconditioning on</b> The symbol illuminates when the engine block and passenger compartment heater/air conditioning are preconditioning the car.
	<b>Stability system</b> A flashing symbol indicates that the stability system is operating. If the symbol illuminates with constant glow then there is a fault in the system.
	<b>Stability system, sport mode</b> The symbol illuminates when the sport mode is activated. Sport mode allows for a more active driving experience. The system then detects whether the accelerator pedal, steering wheel movements and cornering are more active than in normal driving and then allows controlled skidding of the rear section up to a certain level before it intervenes and stabilises the car.

Symbol	Specification
	<b>Lane assistance</b> White symbol: Lane assistance is on and road lines are detected. Grey symbol: Lane assistance is on but road lines are not detected. Yellow symbol: Lane assistance warns/intervenes.
	<b>Lane assistance and rain sensor</b> White symbol: Lane assistance is on and road lines are detected. Rain sensor is on. Grey symbol: Lane assistance is on but road lines are not detected. Rain sensor is on.

### Reminder for doors, bonnet, tailgate and fuel filler flap

If the bonnet, tailgate, fuel filler flap or door is not closed properly then the information or warning symbol and graphics illuminate in the driver display.

### Related information

- Driver display (p. 90)
- Warning symbols in the driver display (p. 97)
- Door and seatbelt reminder (p. 62)

## Warning symbols in the driver display

The warning symbols alert the driver that an important function is activated or that a serious fault or condition exists.



### WARNING



If the brake fluid is below the **MIN** level in the brake fluid reservoir, do not drive further before topping up the brake fluid.

The loss of brake fluid must be investigated by a workshop. Volvo recommends contacting an authorised Volvo workshop.



### WARNING

If the BRAKE and ABS symbols are lit at the same time, there is a risk that the rear end will skid during heavy braking.

Symbol	Specification
	<p><b>Warning</b></p> <p>The red warning symbol illuminates when a fault has been indicated which could affect the safety and/or driveability of the car. An explanatory text is shown on the driver display at the same time. The warning symbol can also illuminate in conjunction with other symbols.</p>
	<p><b>Seatbelt reminder</b></p> <p>This symbol flashes if someone in a front seat has not put on their seatbelt or if someone in a rear seat has taken off their seatbelt.</p>
	<p><b>Airbags</b></p> <p>If the symbol remains illuminated or illuminates while driving, a fault has been detected in one of the car's safety systems. Read the message in the driver display. Volvo recommends that an authorised Volvo workshop is contacted.</p>

Symbol	Specification
	<p><b>Fault in brake system</b></p> <p>If this symbol illuminates, the brake fluid level may be too low. Visit the nearest authorised workshop to have the brake fluid level checked and rectified.</p>
	<p><b>Parking brake applied</b></p> <p>This symbol illuminates with a constant glow when the parking brake is applied.</p> <p>A flashing symbol means that a fault has arisen. Read the message in the driver display.</p>



Symbol	Specification
	<p><b>Low oil pressure</b></p> <p>If this symbol illuminates during driving then the engine's oil pressure is too low. Stop the engine immediately and check the engine oil level, top up if necessary. If the symbol illuminates and the oil level is normal, contact a workshop. Volvo recommends that an authorised Volvo workshop is contacted.</p>
	<p><b>Alternator not charging</b></p> <p>This symbol illuminates during driving if a fault has occurred in the electrical system. Visit a workshop. Volvo recommends that an authorised Volvo workshop is contacted.</p>

### Reminder for doors, bonnet, tailgate and fuel filler flap

If the bonnet, tailgate, fuel filler flap or door is not closed properly then the information or warning symbol and graphics illuminate in the driver display.

#### Related information

- Driver display (p. 90)
- Indicator symbols in the driver display (p. 95)
- Door and seatbelt reminder (p. 62)
- Safety (p. 56)

### Outside temperature gauge

The outside temperature gauge is shown in the driver display.

A sensor detects the temperature outside of the car.

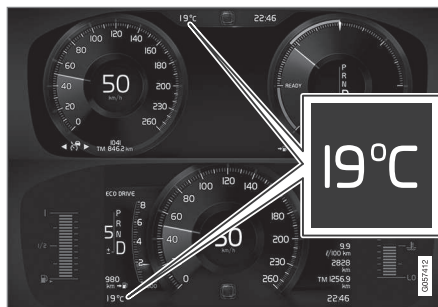

Outside temperature gauge location in the 12-inch and 8-inch driver display.

If the car has been stationary, the gauge may display a temperature reading that is too high.

When the outside temperature is within the range +2°C to -5°C, a snowflake symbol is shown in the driver display as a warning for potentially slippery conditions. The snowflake symbol is also illuminated briefly in the head-up display, if the car is equipped with one.

### Outside temperature gauge setting

Change the unit for the temperature gauge via the centre display's top view.

- Select **Settings** → **System** → **Units of Measurement** and select the required unit type, **Metric**, **Imperial** or **US**.

#### Related information

- Driver display (p. 90)
- Climate control - sensors (p. 181)



## Clock

The clock is shown in both the driver display and the centre display.

### Location

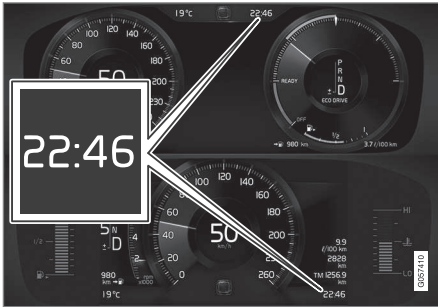

Clock location in the 12-inch and 8-inch driver display.

In the centre display, the clock is located at the top right of the status bar.

In certain situations, messages and information may cover the clock in the driver display.

### Settings for time and date

Select **Settings** → **System** → **Date and Time** in the centre display's top view to change settings for time and date format.

Adjust time and date by pressing the up or down arrow on the touch screen.

### Automatic time for cars with GPS

If the car is equipped with a navigation system then **Auto Time** can be selected. The time zone is then adjusted automatically based on the location of the car. For certain types of navigation systems, the current location (country) must also be set to obtain the right time zone. If **Auto Time** is not selected, time and data are adjusted with arrow up or arrow down on the touch screen.

### Summer time

In certain countries, it is possible to select automatic setting of summer time with **Auto**. For other countries, summer time can be set with **On** or **Off**.

### Related information

- Driver display (p. 90)
- Settings view (p. 169)

## Fuel gauge for vehicle gas\*

A car with the Bi-Fuel engine alternative has a separate fuel gauge for vehicle gas.



Markings above the button show the current fuel level.

Number of LEDs	Colour of LEDs	Fuel level (%)
5	Green	81-100
4	Green	61-80
3	Green	41-60
2	Green	21-40
1	Green	11-20
1	Red	0-10



- ◀◀ When the vehicle gas tank is empty the switch sounds 3 times. The level gauge extinguishes and the system automatically changes over to petrol.

**i NOTE**

Ensure that the petrol tank never runs dry because the car always starts on petrol.

**Related information**

- Filling vehicle gas\* (p. 416)
- Button for gas operation\* (p. 417)

**License agreement for the driver display**

A license is an agreement for the right to operate a certain activity or the right to use someone else's entitlement according to the terms and conditions in the agreement. The following text is Volvo's agreement with the manufacturer/developer.

**BSD 4-clause "Original" or "Old" License**

Copyright (c) 1982, 1986, 1990, 1991, 1993 The Regents of the University of California. All rights reserved.

Redistribution and use in source and binary forms, with or without modification, are permitted provided that the following conditions are met:

1. Redistributions of source code must retain the above copyright notice, this list of conditions and the following disclaimer.
2. Redistributions in binary form must reproduce the above copyright notice, this list of conditions and the following disclaimer in the documentation and/or other materials provided with the distribution.
3. All advertising materials mentioning features or use of this software must display the following acknowledgement: This product includes software developed by the University of California, Berkeley and its contributors.

4. Neither the name of the University nor the names of its contributors may be used to endorse or promote products derived from this software without specific prior written permission.

THIS SOFTWARE IS PROVIDED BY THE REGENTS AND CONTRIBUTORS "AS IS" AND ANY EXPRESS OR IMPLIED WARRANTIES, INCLUDING, BUT NOT LIMITED TO, THE IMPLIED WARRANTIES OF MERCHANTABILITY AND FITNESS FOR A PARTICULAR PURPOSE ARE DISCLAIMED. IN NO EVENT SHALL THE REGENTS OR CONTRIBUTORS BE LIABLE FOR ANY DIRECT, INDIRECT, INCIDENTAL, SPECIAL, EXEMPLARY, OR CONSEQUENTIAL DAMAGES (INCLUDING, BUT NOT LIMITED TO, PROCUREMENT OF SUBSTITUTE GOODS OR SERVICES; LOSS OF USE, DATA, OR PROFITS; OR BUSINESS INTERRUPTION) HOWEVER CAUSED AND ON ANY THEORY OF LIABILITY, WHETHER IN CONTRACT, STRICT LIABILITY, OR TORT (INCLUDING NEGLIGENCE OR OTHERWISE) ARISING IN ANY WAY OUT OF THE USE OF THIS SOFTWARE, EVEN IF ADVISED OF THE POSSIBILITY OF SUCH DAMAGE.

**BSD 3-clause "New" or "Revised" License**

Copyright (c) 2011-2014, Yann Collet.

Redistribution and use in source and binary forms, with or without modification, are permitted provided that the following conditions are met:

1. Redistributions of source code must retain the above copyright notice, this list of conditions and the following disclaimer.
2. Redistributions in binary form must reproduce the above copyright notice, this list of conditions and the following disclaimer in the documentation and/or other materials provided with the distribution.
3. Neither the name of the organisation nor the names of its contributors may be used to endorse or promote products derive from this software without specific prior written permission.

THIS SOFTWARE IS PROVIDED BY THE COPYRIGHT HOLDERS AND CONTRIBUTORS "AS IS" AND ANY EXPRESS OR IMPLIED WARRANTIES, INCLUDING, BUT NOT LIMITED TO, THE IMPLIED WARRANTIES OF MERCHANTABILITY AND FITNESS FOR A PARTICULAR PURPOSE ARE DISCLAIMED. IN NO EVENT SHALL THE COPYRIGHT HOLDER OR CONTRIBUTORS BE LIABLE FOR ANY DIRECT, INDIRECT, INCIDENTAL, SPECIAL, EXEMPLARY, OR CONSEQUENTIAL DAMAGES (INCLUDING, BUT NOT LIMITED TO, PROCUREMENT OF SUBSTITUTE GOODS OR SERVICES; LOSS OF USE, DATA, OR PROFITS; OR BUSINESS INTERRUPTION) HOWEVER CAUSED AND ON ANY THEORY OF LIABILITY,

WHETHER IN CONTRACT, STRICT LIABILITY, OR TORT (INCLUDING NEGLIGENCE OR OTHERWISE) ARISING IN ANY WAY OUT OF THE USE OF THIS SOFTWARE, EVEN IF ADVISED OF THE POSSIBILITY OF SUCH DAMAGE.

### **BSD 2-clause "Simplified" license**

Copyright (c) <YEAR>, <OWNER> All rights reserved.

Redistribution and use in source and binary forms, with or without modification, are permitted provided that the following conditions are met:

1. Redistributions of source code must retain the above copyright notice, this list of conditions and the following disclaimer.
2. Redistributions in binary form must reproduce the above copyright notice, this list of conditions and the following disclaimer in the documentation and/or other materials provided with the distribution.

THIS SOFTWARE IS PROVIDED BY THE COPYRIGHT HOLDERS AND CONTRIBUTORS "AS IS" AND ANY EXPRESS OR IMPLIED WARRANTIES, INCLUDING, BUT NOT LIMITED TO, THE IMPLIED WARRANTIES OF MERCHANTABILITY AND FITNESS FOR A PARTICULAR PURPOSE ARE DISCLAIMED. IN NO EVENT SHALL THE COPYRIGHT OWNER OR CONTRIBUTORS BE LIABLE FOR ANY DIRECT, INDIRECT, INCIDENTAL, SPECIAL,

EXEMPLARY, OR CONSEQUENTIAL DAMAGES (INCLUDING, BUT NOT LIMITED TO, PROCUREMENT OF SUBSTITUTE GOODS OR SERVICES; LOSS OF USE, DATA, OR PROFITS; OR BUSINESS INTERRUPTION) HOWEVER CAUSED AND ON ANY THEORY OF LIABILITY, WHETHER IN CONTRACT, STRICT LIABILITY, OR TORT (INCLUDING NEGLIGENCE OR OTHERWISE) ARISING IN ANY WAY OUT OF THE USE OF THIS SOFTWARE, EVEN IF ADVISED OF THE POSSIBILITY OF SUCH DAMAGE.

The views and conclusions contained in the software and documentation are those of the authors and should not be interpreted as representing official policies, either expressed or implied, of the FreeBSD Project.

### **FreeType Project License**

1. 1 Copyright 1996-1999 by David Turner, Robert Wilhelm, and Werner Lemberg  
Introduction The FreeType Project is distributed in several archive packages; some of them may contain, in addition to the FreeType font engine, various tools and contributions which rely on, or relate to, the FreeType Project. This license applies to all files found in such packages, and which do not fall under their own explicit license. The license affects thus the FreeType font engine, the test programs, documentation and makefiles, at the very least. This license was inspired by the BSD, Artistic, and IJG





(Independent JPEG Group) licenses, which all encourage inclusion and use of free software in commercial and freeware products alike. As a consequence, its main points are that:

- o We don't promise that this software works. However, we are interested in any kind of bug reports. ('as is' distribution)
- o You can use this software for whatever you want, in parts or full form, without having to pay us. ('royalty-free' usage)
- o You may not pretend that you wrote this software. If you use it, or only parts of it, in a program, you must acknowledge somewhere in your documentation that you've used the FreeType code. ('credits')

We specifically permit and encourage the inclusion of this software, with or without modifications, in commercial products, provided that all warranty or liability claims are assumed by the product vendor. Legal Terms 0. Definitions Throughout this license, the terms 'package', 'FreeType Project', and 'FreeType archive' refer to the set of files originally distributed by the authors (David Turner, Robert Wilhelm, and Werner Lemberg) as the 'FreeType project', be they named as alpha, beta or final release. 'You' refers to the licensee, or person using the project, where 'using' is a generic term including compiling the project's source code as well as linking it to form a 'program' or 'executable'. This program is referred to as 'a program using the FreeType engine'. This

license applies to all files distributed in the original FreeType archive, including all source code, binaries and documentation, unless otherwise stated in the file in its original, unmodified form as distributed in the original archive. If you are unsure whether or not a particular file is covered by this license, you must contact us to verify this. The FreeType project is copyright (C) 1996-1999 by David Turner, Robert Wilhelm, and Werner Lemberg. All rights reserved except as specified below.

1. No Warranty THE FREETYPE ARCHIVE IS PROVIDED 'AS IS' WITHOUT WARRANTY OF ANY KIND, EITHER EXPRESSED OR IMPLIED, INCLUDING, BUT NOT LIMITED TO, WARRANTIES OF MERCHANTABILITY AND FITNESS FOR A PARTICULAR PURPOSE. IN NO EVENT WILL ANY OF THE AUTHORS OR COPYRIGHT HOLDERS BE LIABLE FOR ANY DAMAGES CAUSED BY THE USE OR THE INABILITY TO USE, OF THE FREETYPE PROJECT. As you have not signed this license, you are not required to accept it. However, as the FreeType project is copyrighted material, only this license, or another one contracted with the authors, grants you the right to use, distribute, and modify it. Therefore, by using, distributing, or modifying the FreeType project, you indicate

that you understand and accept all the terms of this license.

2. Redistribution Redistribution and use in source and binary forms, with or without modification, are permitted provided that the following conditions are met:
    - o Redistribution of source code must retain this license file ('licence.txt') unaltered; any additions, deletions or changes to the original files must be clearly indicated in accompanying documentation. The copyright notices of the unaltered, original files must be preserved in all copies of source files.
    - o Redistribution in binary form must provide a disclaimer that states that the software is based in part of the work of the FreeType Team, in the distribution documentation. We also encourage you to put an URL to the FreeType web page in your documentation, though this isn't mandatory. These conditions apply to any software derived from or based on the FreeType code, not just the unmodified files. If you use our work, you must acknowledge us. However, no fee need be paid to us.
3. Advertising The names of FreeType's authors and contributors may not be used to endorse or promote products derived from this software without specific prior written permission. We suggest, but do not require, that you use one or more of the following phrases to refer to this software in your documentation or advertising materials:

- 'FreeType Project', 'FreeType Engine', 'FreeType library', or 'FreeType Distribution'.
4. **Contacts** There are two mailing lists related to FreeType: o [freetype@freetype.org](mailto:freetype@freetype.org) Discusses general use and applications of FreeType, as well as future and wanted additions to the library and distribution. If you are looking for support, start in this list if you haven't found anything to help you in the documentation. o [devel@freetype.org](mailto:devel@freetype.org) Discusses bugs, as well as engine internals, design issues, specific licenses, porting, etc. o <http://www.freetype.org> Holds the current FreeType web page, which will allow you to download our latest development version and read online documentation. You can also contact us individually at: David Turner <[david.turner@freetype.org](mailto:david.turner@freetype.org)> Robert Wilhelm <[robert.wilhelm@freetype.org](mailto:robert.wilhelm@freetype.org)> Werner Lemberg <[werner.lemberg@freetype.org](mailto:werner.lemberg@freetype.org)>

### Libpng License

This copy of the libpng notices is provided for your convenience. In case of any discrepancy between this copy and the notices in the file `png.h` that is included in the libpng distribution, the latter shall prevail.

### **COPYRIGHT NOTICE, DISCLAIMER, and LICENSE:**

If you modify libpng you may insert additional notices immediately following this sentence.

libpng versions 1.0.7, July 1, 2000, through 1.0.13, April 15, 2002, are Copyright (c) 2000-2002 Glenn Randers-Pehrson and are distributed according to the same disclaimer and license as libpng-1.0.6 with the following individuals added to the list of Contributing Authors

Simon-Pierre Cadieux

Eric S. Raymond

Gilles Vollant

and with the following additions to the disclaimer:

There is no warranty against interference with your enjoyment of the library or against infringement. There is no warranty that our efforts or the library will fulfill any of your particular purposes or needs. This library is provided with all faults, and the entire risk of satisfactory quality, performance, accuracy, and effort is with the user.

libpng versions 0.97, January 1998, through 1.0.6, March 20, 2000, are Copyright (c) 1998, 1999 Glenn Randers-Pehrson, and are distributed according to the same disclaimer and license as libpng-0.96, with the following individuals added to the list of Contributing Authors:

Tom Lane

Glenn Randers-Pehrson

Willem van Schaik

libpng versions 0.89, June 1996, through 0.96, May 1997, are Copyright (c) 1996, 1997 Andreas Dilger Distributed according to the same disclaimer and license as libpng-0.88, with the following individuals added to the list of Contributing Authors:

John Bowler

Kevin Brace

Sam Bushell

Magnus Holmgren

Greg Roelofs

Tom Tanner

libpng versions 0.5, May 1995, through 0.88, January 1996, are Copyright (c) 1995, 1996 Guy Eric Schalnat, Group 42, Inc.

For the purposes of this copyright and license, "Contributing Authors" is defined as the following set of individuals:

Andreas Dilger

Dave Martindale

Guy Eric Schalnat

Paul Schmidt

Tim Wegner

The PNG Reference Library is supplied "AS IS". The Contributing Authors and Group 42, Inc. disclaim all warranties, expressed or implied, including, without limitation, the warranties of



◀◀ merchantability and of fitness for any purpose. The Contributing Authors and Group 42, Inc. assume no liability for direct, indirect, incidental, special, exemplary, or consequential damages, which may result from the use of the PNG Reference Library, even if advised of the possibility of such damage.

Permission is hereby granted to use, copy, modify, and distribute this source code, or portions hereof, for any purpose, without fee, subject to the following restrictions:

1. The origin of this source code must not be misrepresented.
2. Altered versions must be plainly marked as such and must not be misrepresented as being the original source.
3. This Copyright notice may not be removed or altered from any source or altered source distribution.

The Contributing Authors and Group 42, Inc. specifically permit, without fee, and encourage the use of this source code as a component to supporting the PNG file format in commercial products. If you use this source code in a product, acknowledgment is not required but would be appreciated.

A "png\_get\_copyright" function is available, for convenient use in "about" boxes and the like:  
`printf("%s",png_get_copyright(NULL));`

Also, the PNG logo (in PNG format, of course) is supplied in the files "pngbar.png" and "pngbar.jpg (88x31) and "pngnow.png" (98x31).

Libpng is OSI Certified Open Source Software. OSI Certified Open Source is a certification mark of the Open Source Initiative.

Glenn Randers-Pehrson randeg@alum.rpi.edu  
April 15, 2002

### MIT License

Copyright (c) <year> <copyright holders>

Permission is hereby granted, free of charge, to any person obtaining a copy of this software and associated documentation files (the "Software"), to deal in the Software without restriction, including without limitation the rights to use, copy, modify, merge, publish, distribute, sublicense, and/or sell copies of the Software, and to permit persons to whom the Software is furnished to do so, subject to the following conditions:

The above copyright notice and this permission notice shall be included in all copies or substantial portions of the Software.

THE SOFTWARE IS PROVIDED "AS IS", WITHOUT WARRANTY OF ANY KIND, EXPRESS OR IMPLIED, INCLUDING BUT NOT LIMITED TO THE WARRANTIES OF MERCHANTABILITY, FITNESS FOR A PARTICULAR PURPOSE AND NONINFRINGEMENT. IN NO EVENT SHALL

THE AUTHORS OR COPYRIGHT HOLDERS BE LIABLE FOR ANY CLAIM, DAMAGES OR OTHER LIABILITY, WHETHER IN AN ACTION OF CONTRACT, TORT OR OTHERWISE, ARISING FROM, OUT OF OR IN CONNECTION WITH THE SOFTWARE OR THE USE OR OTHER DEALINGS IN THE SOFTWARE.

### zlib License

The zlib/libpng License Copyright (c) <year> <copyright holders>

This software is provided 'as-is', without any express or implied warranty. In no event will the authors be held liable for any damages arising from the use of this software.

Permission is granted to anyone to use this software for any purpose, including commercial applications, and to alter it and redistribute it freely, subject to the following restrictions:

1. The origin of this software must not be misrepresented; you must not claim that you wrote the original software. If you use this software in a product, an acknowledgment in the product documentation would be appreciated but is not required.
2. Altered source versions must be plainly marked as such, and must not be misrepresented as being the original software.
3. This notice may not be removed or altered from any source distribution.

## SGI Free Software B License Version 2.0.

SGI FREE SOFTWARE LICENSE B (Version 2.0, Sept. 18, 2008)

Copyright (C) [dates of first publication] Silicon Graphics, Inc. All Rights Reserved. Permission is hereby granted, free of charge, to any person obtaining a copy of this software and associated documentation files (the "Software"), to deal in the Software without restriction, including without limitation the rights to use, copy, modify, merge, publish, distribute, sublicense, and/or sell copies of the Software, and to permit persons to whom the Software is furnished to do so, subject to the following conditions: The above copyright notice including the dates of first publication and either this permission notice or a reference to <http://oss.sgi.com/projects/FreeB/> shall be included in all copies or substantial portions of the Software.

THE SOFTWARE IS PROVIDED "AS IS", WITHOUT WARRANTY OF ANY KIND, EXPRESS OR IMPLIED, INCLUDING BUT NOT LIMITED TO THE WARRANTIES OF MERCHANTABILITY, FITNESS FOR A PARTICULAR PURPOSE AND NONINFRINGEMENT. IN NO EVENT SHALL SILICON GRAPHICS, INC. BE LIABLE FOR ANY CLAIM, DAMAGES OR OTHER LIABILITY, WHETHER IN AN ACTION OF CONTRACT, TORT OR OTHERWISE, ARISING FROM, OUT OF OR IN CONNECTION WITH THE SOFTWARE

OR THE USE OR OTHER DEALINGS IN THE SOFTWARE.

Except as contained in this notice, the name of Silicon Graphics, Inc. shall not be used in advertising or otherwise to promote the sale, use or other dealings in this Software without prior written authorization from Silicon Graphics, Inc.

### Related information

- Driver display (p. 90)

## Application menu in the driver display

Application menu (app menu) in the driver display provides quick access to commonly used functions for certain apps.



The app menu in the driver display can be used instead of using the centre display.

The app menu is shown in the driver display and is controlled using the steering wheel's right-hand keypad. The app menu makes it easy to switch between different apps or functions within the apps without having to let go of the steering wheel and take your eyes off the road.

### App menu functions

Different apps give access to different types of functions. The following apps and their associated functions can be controlled from the app menu:



App	Functions
Trip computer	Selection of trip meter, selection of what to show in the driver display, etc.
Media player	Selection of active source for the media player.
Phone	Calling a contact from the call list.
Navigation	Pause guide, start guide to recently used destination, etc.

### Related information

- Driver display (p. 90)
- Overview of the centre display (p. 33)
- Using the application menu in the driver display (p. 106)

## Using the application menu in the driver display

The application menu (the app menu) in the driver display is operated with the steering wheel's right-hand keypad.

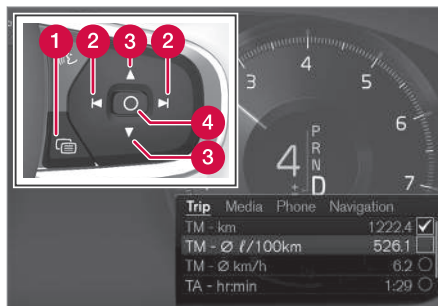

The app menu and the steering wheel's right-hand keypad.

- 1 Open/close
- 2 Left/right
- 3 Up/down
- 4 Confirm

## Opening/closing the app menu

- Press on open/close (1).

(It is not possible to open the app menu while there is an unacknowledged message in the driver display. The message must be confirmed before the app menu can be opened.)

> The app menu opens/closes.

The app menu closes automatically after a period of inactivity or after certain options have been selected.

## Navigating and selecting in the app menu

1. Navigate between the different apps that are available by tapping on left or right (2).
  - > Functions for previous/next app are shown in the app menu.
2. Browse through the functions for the selected app by tapping on up or down (3).
3. Confirm or highlight an option for the function by pressing on confirm (4).
  - > The function is activated and for some options the app menu then closes.

If the app menu is opened again, the functions of the most recently selected app are shown first.



## Related information

- Application menu in the driver display (p. 105)
- Managing messages in the driver display and the centre display (p. 109)

## Messages in the driver display and the centre display

The driver display and centre display can show messages to inform or assist the driver in the event of different events.

### Driver display



Message in the driver display<sup>2</sup>.



Message in the driver display<sup>3</sup>.

The driver display shows messages that are of high priority for the driver.

The messages can be shown in different parts of the driver display depending on what other information is currently being displayed. After a while, or when the message has been acknowledged/ action taken if required, the message disappears from the driver display. If a message needs to be saved, it is placed in the **Car status** app, which is opened from the app view in the centre display.

Message composition may vary and they can be shown together with graphics, symbols or buttons for acknowledging the message or accepting a request, for example.

<sup>2</sup> With 8-inch driver display.

<sup>3</sup> With 12-inch driver display.

◀◀ **Service messages**

Shown below is a selection of important service messages and their meanings.

Message	Specification
<b>Stop safely<sup>A</sup></b>	Stop and switch off the engine. Serious risk of damage - consult a workshop <sup>B</sup> .
<b>Turn off engine<sup>A</sup></b>	Stop and switch off the engine. Serious risk of damage - consult a workshop <sup>B</sup> .
<b>Service urgent Drive to workshop<sup>A</sup></b>	Contact a workshop <sup>B</sup> to check the car immediately.
<b>Service required<sup>A</sup></b>	Contact a workshop <sup>B</sup> to check the car as soon as possible.
<b>Regular maintenance Book time for maintenance</b>	Time for regular service - contact a workshop <sup>B</sup> . Shown before the next service date.
<b>Regular maintenance Time for maintenance</b>	Time for regular service - contact a workshop <sup>B</sup> . Shown at the next service date.

Message	Specification
<b>Regular maintenance Maintenance overdue</b>	Time for regular service - contact a workshop <sup>B</sup> . Shown when the service date has passed.
<b>Temporarily off<sup>A</sup></b>	A function has been temporarily switched off and is reset automatically while driving or after starting again.

<sup>A</sup> Part of message, shown together with information on where the problem has arisen.

<sup>B</sup> An authorised Volvo workshop is recommended.

**Centre display**

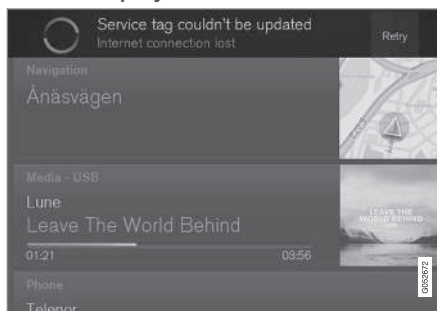

Message in the centre display.

The centre display shows messages that are of lower priority for the driver.

Most messages are shown above the centre display's status bar. After a while, or when any required action related to the message has been taken, the message disappears from the status bar. If a message needs to be saved, it is positioned in the top view in the centre display.

Message composition may vary and they can be shown together with graphics, symbols or a button for activating/deactivating a function linked to the message.

**Pop-up messages**

In some cases, a message is shown in the form of a pop-up window. Pop-up messages have higher priority than messages shown in the status bar and require acknowledgement/action before they disappear. Messages that need to be saved are positioned in the top view in the centre display.

**Related information**

- Driver display (p. 90)
- Overview of the centre display (p. 33)
- Managing messages in the driver display and the centre display (p. 109)
- Managing messages saved from the driver display and centre display (p. 110)

## Managing messages in the driver display and the centre display

Messages in the driver display and centre display are managed with the steering wheel's right-hand keypad and in the centre display's views.

### Driver display

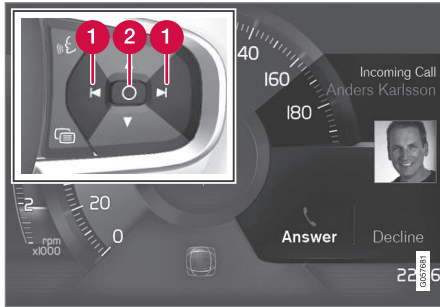

Message in the driver display<sup>4</sup> and the steering wheel's right-hand keypad.



Message in the driver display<sup>5</sup> and the steering wheel's right-hand keypad.

- 1 Left/right
- 2 Confirm

Some messages in the driver display contain one or more buttons for acknowledging the message or accepting a request, for example.

### Managing a new message

For messages with buttons:

1. Navigate between the different buttons that are available by tapping on left or right (1).
2. Confirm the selection by pressing on confirm (2).
  - > The message disappears from the driver display.

For messages without buttons:

- Close the message by pressing on confirm (2), or allow the message to close automatically after a while.
  - > The message disappears from the driver display.

If a message needs to be saved, it is placed in the **Car status** app, which is opened from the app view in the centre display. The message **Car message stored in Car Status application** is shown in the centre display in conjunction with this.

### Centre display

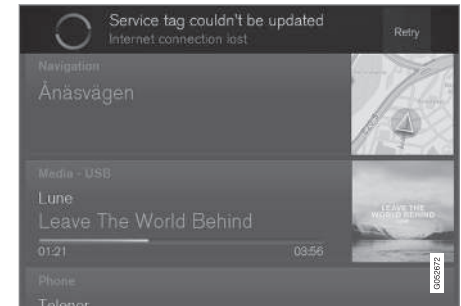

Message in the centre display.

Some messages in the centre display have a button (or several buttons in pop-up messages) for

<sup>4</sup> With 8-inch driver display.

<sup>5</sup> With 12-inch driver display.

- ◀◀ e.g. activating/deactivating a function linked to the message.

### Managing a new message

For messages with buttons:

- Press the button to perform the action or allow the message to close automatically after a while.
  - > The message disappears from the status bar.

For messages without buttons:

- Close the message by tapping on it, or allow the message to close automatically after a while.
  - > The message disappears from the status bar.

If a message needs to be saved, it is positioned in the top view in the centre display.

### Related information

- Messages in the driver display and the centre display (p. 107)
- Managing messages saved from the driver display and centre display (p. 110)

## Managing messages saved from the driver display and centre display

Whether saved from the driver display or the centre display, messages are managed in the centre display.

### Messages saved from the driver display

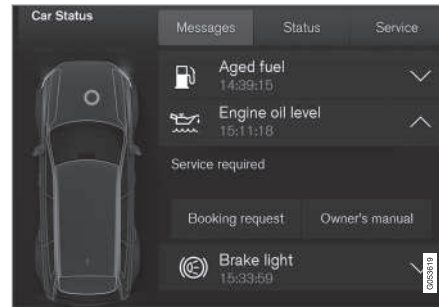

Saved messages and possible options in the **Car status** app.



Messages that are shown in the driver display and that need to be saved are added in the **Car status** app in the centre display. The message **Car message stored in Car Status application** is shown

in the centre display in conjunction with this.

### Reading a saved message

To read a saved message immediately:

- Press the button to the right of the **Car message stored in Car Status application** message in the centre display.
  - > The saved message is shown in the **Car status** app.

To read a saved message later:

1. Open the **Car status** app from the app view in the centre display.
  - > The app is opened in the bottom subview of the home view.
2. Select the **Messages** tab in the app.
  - > A list of saved messages is shown.
3. Press on the arrow to the right to maximise/minimise a message.
  - > More information on the message is shown in the list and the image to the left in the app shows information about the message graphically.

### Managing a saved message

In maximised mode, some messages have two buttons available to book service or read the owner's manual.

To book service for a saved message:

- In maximised mode for the message, press **Request appoint.****Call to make Appointment**<sup>6</sup> for help in booking service.
  - > With **Request appoint:** The **Appointments** tab opens in the app and creates a request to book service and repair work.

With **Call to make Appointment:** The phone app is initiated and calls a service centre to book service and repair work.

To read the owner's manual for a saved message:

- In maximised mode for the message, press **Owner's manual** to read about the message in the owner's manual.
  - > The owner's manual opens in the centre display and shows information linked to the message.

Saved messages in the app are deleted automatically each time the engine is started.

### Messages saved from the centre display

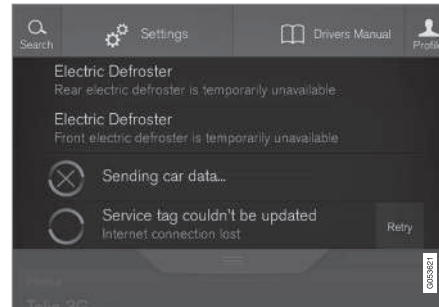

Saved messages and possible options in the top view.

Messages that are shown in the centre display that need to be saved are added in the top view of the centre display.

### Reading a saved message

1. Open the top view in the centre display.
  - > A list of saved messages is shown. Messages with an arrow to the right can be maximised.
2. Press on the arrow to maximise/minimise the message.

### Managing a saved message

Some messages have a button for e.g. activating/deactivating a function linked to the message.

- Press the button to perform the action.

Saved messages in the top view are deleted automatically when the car is switched off.

### Related information

- Messages in the driver display and the centre display (p. 107)
- Managing messages in the driver display and the centre display (p. 109)

<sup>6</sup> Depending on market.

## Head-up display\*

The head-up display supplements the car's driver display and projects information from the driver display onto the windscreen. The projected image can only be seen from the driver position.

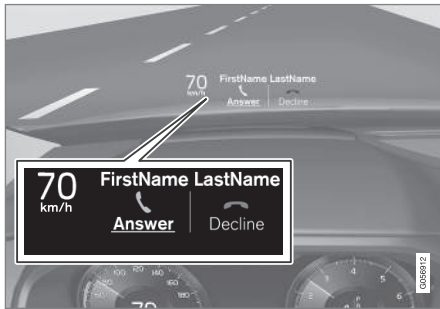

Incoming phone calls.

The head-up display shows warnings and information relating to speed, cruise control functions, navigation, etc. in the driver's field of vision. Road sign information and incoming phone calls are also shown in the head-up display.

**! IMPORTANT**

The display unit from which the information is projected is located in the instrument panel. To avoid damage to the display unit's cover glass - do not store any objects on the cover glass and make sure that no objects fall down onto it.

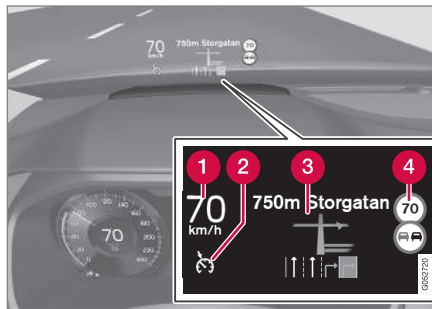

Examples of what can be shown in the display.

- 1 Speed
- 2 Cruise control
- 3 Navigation
- 4 Road signs

A number of symbols can be shown temporarily in the head-up display, e.g.:



If the warning symbol illuminates - read the warning message in the driver display.



If the information symbol illuminates - read the message in the driver display.

**i NOTE**

The driver's ability to see the information in the head-up display is impaired by the following:

- use of polarising sunglasses
- a driving position which means that the driver is not sitting centred in the seat
- objects on the display unit's cover glass
- unfavourable light conditions.

**i NOTE**

Certain visual defects may cause headaches and a feeling of stress during the use of the head-up display.

## City Safety in the head-up display

### **i** NOTE

When City Safety\* is activated, the information in the head-up display is replaced by a graphic for City Safety. This graphic is illuminated even if the head-up display is switched off.

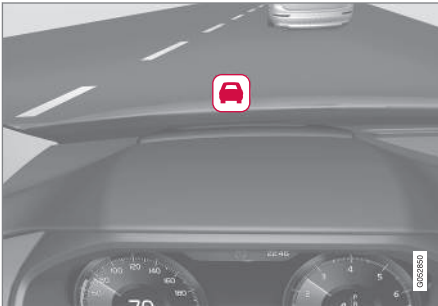

The graphic for City Safety flashes in order to catch the driver's attention.

## Activating/deactivating the head-up display

This function can be activated/deactivated in two ways via the centre display:

## Via the function view

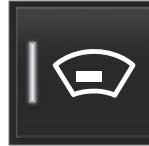

Press the **Head-up display** button.

## Via settings

1. Press **Settings** in the top view.
2. Press **My Car → Displays**.
3. Select/deselect **Head-Up Display**.

The option can be saved as a personal setting in the driver profile.

### **i** NOTE

Activation/deactivation and adjustment of the head-up-display can only be performed when it shows a projected image. The car's engine must be running.

## Settings for head-up display

Select the option and adjust the settings for the head-up display's projection onto the windscreen.

## Selecting display options

1. Tap on **Settings** in the centre display's top view.
2. Press **My Car → Displays → Head-Up Display Options**.

3. Select which functions should be shown:

- **Show Navigation**
- **Show Road Sign Information**
- **Show Driver Support**
- **Show Phone**.

The setting can be saved as a personal setting in the driver profile.



◀ **Adjusting brightness and vertical position**



1. Press the **Head-up display adjustments** button in the function view in the centre display.
2. Adjust the brightness and vertical position of the projected image in the driver's field of vision using the steering wheel's right-hand keypad.

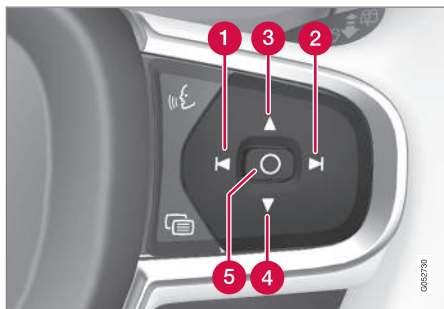

- 1 Reducing the brightness
- 2 Increasing the brightness

- 3 Raising the position
- 4 Lowering the position
- 5 Confirm

The brightness of the graphics is automatically adapted to their background light conditions. The brightness is also affected by the adjustment of the brightness in the car's other displays.

The vertical position can be stored in the memory function of the power front seat\*.

**Calibrate the horizontal position**

The head-up display's horizontal position may need to be calibrated if the windscreen or display unit is replaced. Calibration means that the projected image is rotated clockwise or anticlockwise.

1. Tap on **Settings** in the centre display's top view.
2. Select **My Car** → **Displays** → **Head-Up Display Calibration**.
3. Calibrate the image's horizontal position with the steering wheel's right keypad.

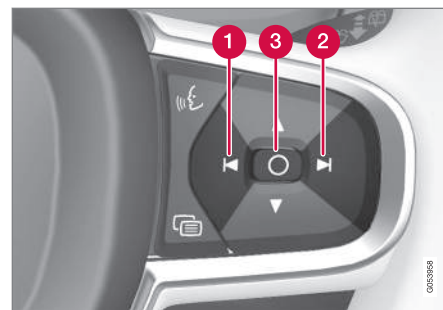

- 1 Rotate anticlockwise
- 2 Rotate clockwise
- 3 Confirm

**Cleaning**

Gently wipe the display's cover glass with a clean and dry microfibre cloth. If necessary, lightly moisten the microfibre cloth.

Never use strong stain removers. A special cleaning agent available from Volvo dealers can be used for more difficult cleaning.

**When replacing the windscreen**

Cars with head-up display are equipped with a special type of windscreen that meets the requirements for displaying the projected image.



When replacing the windscreen - contact an authorised workshop<sup>7</sup>. The correct version of the windscreen must be fitted in order that the head-up display's graphics shall be displayed correctly.

### Related information

- Function view with buttons for car functions (p. 47)
- Settings view (p. 169)
- Steering wheel (p. 131)
- Using the memory function in the power front seat\* (p. 122)
- Driver display (p. 90)

## Voice recognition<sup>8</sup>

The voice recognition system allows the driver to use voice recognition to control certain functions of the media player, Bluetooth-connected phone, the climate system and Volvo's navigation system\*.

Voice commands offer convenience and help the driver to avoid being distracted, and instead concentrate on driving and focus attention on the road and the traffic conditions.

### WARNING

The driver always holds overall responsibility for driving the vehicle in a safe manner and complying with all applicable rules of the road.

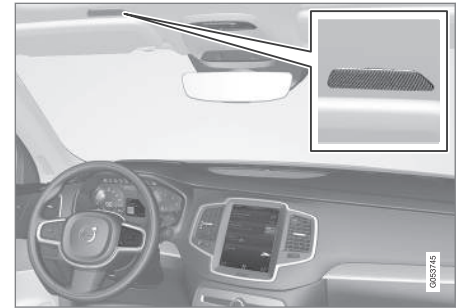

Voice control system microphone

Voice recognition control takes place in dialogue form with spoken commands from the user and verbal response from the system. The voice recognition system uses the same microphone as the Bluetooth handsfree system and the voice recognition system's replies come via the car's speakers. In some cases, a text message is also shown in the driver display. Functions are controlled from the right-hand steering wheel keypad. Settings are made via the centre display.

### System updating

The voice recognition system is continuously improved. Download updates for optimal performance, see [support.volvocars.com](http://support.volvocars.com).

<sup>7</sup> An authorised Volvo workshop is recommended.

<sup>8</sup> Applies to certain markets.

## ◀ Related information

- Using voice recognition (p. 116)
- Voice recognition control of the phone (p. 118)
- Voice recognition control of radio and media (p. 118)
- Voice recognition control of climate control (p. 119)
- Voice recognition and map navigation (p. 120)
- Settings for voice recognition (p. 117)

## Using voice recognition<sup>9</sup>

Basic instructions for using voice recognition control.





Depress the steering wheel button for voice recognition  to activate the system and initiate a dialogue using voice commands.

Remember the following during communication:

- For a command - speak after the tone in a normal voice at normal speed.
- Do not speak while the system is replying (the system cannot understand commands during this time).
- Avoid background noise in the passenger compartment by having the doors, windows and sunroof closed.

Voice recognition can be deactivated as follows:

- by saying "**Cancel**".
- with a long press on the voice recognition button on the steering wheel .

To speed up communication and skip the prompts from the system, press the steering wheel button for voice recognition  when the system voice is speaking and say the next command.

## Example of voice recognition control

Press , say "**Call [Forename] [Surname] [number category]**" - calls the selected contact from the phone book if the contact has more than one phone number (e.g. home, mobile, work), e.g.:

Press , say "**Call Robin Smith Mobile**".

## Commands/phrases

The following commands are always available for use:

- "**Repeat**" - repeats the last voice instruction in the ongoing dialogue.
- "**Cancel**" - discontinue the dialogue.
- "**Help**" - starts a help dialogue. The system replies with the commands available in the current situation, a prompt or an example.

Commands for specific functions are described in the corresponding sections, e.g. Voice recognition control of the phone.

<sup>9</sup> Applies to certain markets.

## Digits

The number commands are stated differently depending on the function to be controlled:

- **Phone numbers and postcodes** must be spoken individually, number by number, e.g. zero three one two two four four three (03122443).
- **House numbers** can be spoken individually or in groups, e.g. two two or twenty-two (22). For English and Dutch, several groups can be said in sequence, e.g. twenty-two twenty-two (22 22). For English, double or triple can be used, e.g. double zero (00). Numbers can be given within the range 0-2300.
- **Frequencies** can be spoken as ninety eight point eight (98.8), a hundred and four point two or hundred four point two (104.2).

## Related information

- Voice recognition (p. 115)
- Voice recognition control of the phone (p. 118)
- Voice recognition control of radio and media (p. 118)
- Voice recognition control of climate control (p. 119)
- Voice recognition and map navigation (p. 120)
- Settings for voice recognition (p. 117)

## Settings for voice recognition<sup>10</sup>

Several settings for the voice recognition system can be made.

1. Press **Settings** in top view.
2. Press **System** → **Voice Control** and select settings.
  - **Repeat Voice Command**
  - **Gender**
  - **Speech Rate**

### Audio settings

1. Press **Settings** in top view.
2. Press **Sound** → **System Volumes** → **Voice Control** and select settings.

### Change language

Voice recognition is not possible for all languages. Languages available for voice recognition are marked with an icon in the language list - .

Changing the language also affects menu, message and help texts.

1. Press **Settings** in top view.
2. Press **System** → **System Language** and select language.

## Related information

- Voice recognition (p. 115)
- Using voice recognition (p. 116)
- Voice recognition control of the phone (p. 118)
- Voice recognition control of radio and media (p. 118)
- Voice recognition control of climate control (p. 119)
- Voice recognition and map navigation (p. 120)

<sup>10</sup> Applies to certain markets.

## Voice recognition control of the phone<sup>11</sup>

Command for voice recognition control of a Bluetooth-connected mobile phone to e.g. call a contact, a number, or to listen to a message.

To specify a contact in the phone book, the voice recognition command must include contact information that is entered in the phone book. If a contact, e.g. **Robyn Smith**, has several phone numbers then the number category can also be stated, e.g. **Home** or **Mobile**: "**Call Robin Smith Mobile**".

Tap on  and say one of the following commands:

- "**Call [contact]**" - dials the selected contact from the phone book.
- "**Call [phone number]**" - dials the phone number.
- "**Recent calls**" - displays the call list.
- "**Read message**" - message is read out. If there are several messages - select which message should be read out.

### Related information

- Voice recognition (p. 115)
- Using voice recognition (p. 116)
- Settings for voice recognition (p. 117)

<sup>11</sup> Applies to certain markets.

<sup>12</sup> Applies to certain markets.

## Voice recognition control of radio and media<sup>12</sup>

Command for voice recognition control of radio and media player.

Tap on  and say one of the following commands:

- "**Media**" - starts a dialogue for media and radio and shows examples of commands.
- "**Play [artist]**" - plays back music by the selected artist.
- "**Play [song title]**" - plays back the selected song.
- "**Play [song title] from [album]**" - plays back the selected song from the selected album.
- "**Play [TV channel name]**" - starts the selected TV channel.
- "**Play [radio station]**" - starts playing back the selected radio channel.
- "**Tune to [frequency]**" - starts the selected radio frequency in the current frequency band. If no radio source is active, the FM band is started by default.
- "**Tune to [frequency] [wavelength]**" - starts the selected radio frequency in the selected frequency band.

- "**Radio**" - starts FM radio.
- "**Radio FM**" - starts FM radio.
- "**Radio AM**" - starts AM radio.
- "**DAB**" - starts DAB radio.
- "**TV**" - starts playback from TV\*.
- "**CD**" - starts playback from CD\*.
- "**USB**" - starts playback from USB.
- "**iPod**" - starts playback from iPod.
- "**Bluetooth**" - starts playback from a Bluetooth-connected media source.
- "**Similar music**" — plays back music similar to the music currently playing back from USB devices.

### Related information

- Voice recognition (p. 115)
- Using voice recognition (p. 116)
- Settings for voice recognition (p. 117)

## Voice recognition control of climate control<sup>13</sup>

Voice recognition commands for the climate control system to e.g. change temperature, activate a heated seat or change fan level.

Press  and say one of the following commands:

- **"Climate"** - starts a dialogue for climate control and shows examples of commands.
- **"Set temperature to X degrees"** - sets the desired temperature.
- **"Raise temperature"/"Lower temperature"** - raise/lower the temperature setting one step.
- **"Sync temperature"** - synchronises the temperature for all climate zones in the car with the temperature set for the driver's side.
- **"Air on feet"/"Air on body"** - opens the desired air flow.
- **"Air on feet off"/"Air on body off"** - closes the desired air flow.
- **"Set fan to max"/"Turn off fan"** - changes the air flow to **Max/Off**.
- **"Raise fan speed"/"Lower fan speed"** - raises/lowers the fan level one step.
- **"Turn on auto"** - activates automatic climate regulation.
- **"Air condition on"/"Air condition off"** - activates/deactivates the air conditioning.
- **"Recirculation on"/"Recirculation off"** - activates/deactivates the air circulation.
- **"Turn on defroster"/"Turn off defroster"** - activates/deactivates defrosting of windows and door mirrors.
- **"Turn on max defroster"/"Turn max defroster off"** - activates/deactivates the max defroster.
- **"Turn on electric defroster"/"Turn off electric defroster"** - activates/deactivates the heated windscreen\*.
- **"Turn on rear defroster"/"Turn off rear defroster"** - activates/deactivates the heated rear window and door mirrors.
- **"Turn steering wheel heat on"/"Turn steering wheel heat off"** - activates/deactivates the heated steering wheel\*.
- **"Raise steering wheel heat"/"Lower steering wheel heat"** - raises/lowers the setting for the heated steering wheel\* one step.
- **"Turn on seat heat"/"Turn off seat heat"** - activates/deactivates the heated seat\*.
- **"Raise seat heat"/"Lower seat heat"** - raises/lowers the setting for the heated seat\* one step.
- **"Turn on seat ventilation"/"Turn off seat ventilation"** - activates/deactivates the seat ventilation\*.
- **"Raise seat ventilation"/"Lower seat ventilation"** - raises/lowers the setting for the ventilated seat\* one step.

### Related information

- Voice recognition (p. 115)
- Using voice recognition (p. 116)
- Settings for voice recognition (p. 117)
- Climate control (p. 180)

<sup>13</sup> Applies to certain markets.

## Voice recognition and map navigation<sup>14</sup>

Command for voice control of the navigation system, e.g. set destination or pause guidance.

Tap on  and say one of the following commands:

- **"Navigation"** - Initiates a navigation dialogue and shows examples of commands.
- **"Take me home"** - Guidance is given to the **Home** position.
- **"Go to [City]"** - Specifies a city as a destination. Example "Drive to London".
- **"Go to [Address]"** - Specifies an address as a destination. An address must contain city and street. Example "Drive to 5 King Street".
- **"Add intersection"** - Starts a dialogue where two streets must be specified. The intersection point of the specified streets then becomes the destination.
- **"Go to [Post code]"** - Specifies a post code as a destination. Example "Drive to 1 2 3 4 5".
- **"Go to [contact]"** - Specifies an address from the phone book as a destination. Example "Drive to Robyn Smith".
- **"Search [POI category]"** - Searches for adjacent points of interest (POI) within a certain category (e.g. restaurants).<sup>15</sup> To have the list sorted along the route - say **"Along the route"** when the results list is shown.
- **"Search [POI category] in [City]"** - Searches for points of interest (POI) within a certain category and city. The results list is sorted according to the city's centre point. Example "Search for restaurant in London".
- **"Search [POI name]"**. Example "Search Hyde Park".
- **"Change country/Change state"**<sup>16, 17</sup> - Changes the search area for navigation.
- **"Show favourites"** - Shows favoured positions in the driver display.
- **"Clear itinerary"** - Erases all the stored intermediate destinations and final destination in an itinerary.
- **"Repeat voice guidance"** - Repeats the last spoken guidance.
- **"Turn off voice guidance"** - Switches off voice guidance.
- **"Turn on voice guidance"** - Starts the switched-off voice guidance.

### Related information

- Voice recognition (p. 115)
- Using voice recognition (p. 116)
- Settings for voice recognition (p. 117)

<sup>14</sup> Applies to certain markets.

<sup>15</sup> The user has the option of calling the POI or specifying it as a destination.

<sup>16</sup> In European countries, "Country" is used instead of "State".

<sup>17</sup> For Brazil and India, the search area is changed via the centre display.

## Manual front seat

The car's front seats have different setting options for optimum seating comfort.

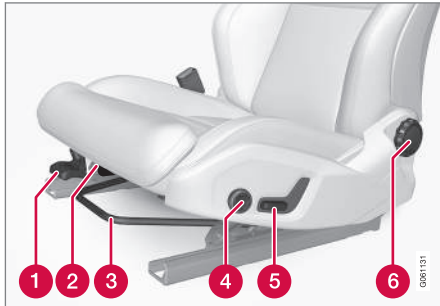

- 1 Raise/lower the front edge of the seat cushion\* by pumping up/down.
- 2 Change the length of the seat cushion by pulling the lever up and moving the seat cushion forward/backward by hand.
- 3 Adjust the seat forward/backward by lifting the handle and adjusting the distance to the steering wheel and pedals. Check that the seat is locked after the position has been adjusted.
- 4 Change the lumbar support\* by pressing the button upward/downward/forward/back.

- 5 Raise/lower the seat by means of adjusting the control up/down.
- 6 Change the backrest rake by turning the control knob.

### **⚠ WARNING**

Adjust the position of the driver's seat before setting off, never while driving. Make sure that the seat is in locked position in order to avoid personal injury in the event of heavy braking or an accident.

### Related information

- Power front seat\* (p. 121)
- Multi-functional front seat\* (p. 123)
- Activating/deactivating heating of the seats\* (p. 201)
- Seatbelt (p. 59)

## Power front seat\*

The car's front seats have different setting options for optimum seating comfort. The power seat can be moved forward/backward and up/down. The front edge of the seat cushion can be raised/lowered and the backrest rake can be changed. The lumbar support can be adjusted upward/downward/forward/backward.

The power seats have overload protection which is tripped if a seat is blocked by an object. If this happens, remove the object and then operate the seat again.

The seat can be adjusted for a period of time after unlocking the door without the engine running. Seat adjustment can always be performed when the engine is running. Adjustment can also be performed for a period of time after the engine has been switched off.

### Related information

- Multi-functional front seat\* (p. 123)
- Adjusting the power front seat\* (p. 122)
- Using the memory function in the power front seat\* (p. 122)
- Manual front seat (p. 121)
- Activating/deactivating heating of the seats\* (p. 201)

## Adjusting the power front seat\*

Set to desired sitting position using the control on the front seat's seating section.

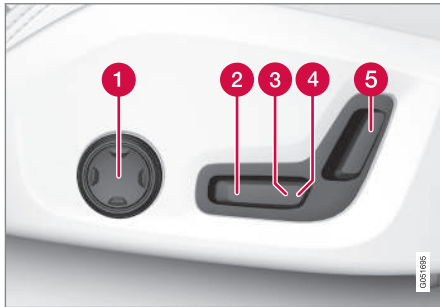

- 1 Change the lumbar support by pressing the button upward/downward/forward/back.
- 2 Raise/lower the seat cushion front edge by adjusting the control up/down.
- 3 Raise/lower the seat by means of adjusting the control up/down.
- 4 Move the seat forward/backward by adjusting the control forward/backward.
- 5 Change the backrest rake by adjusting the control forward/backward.

Only one movement (forward/back/up/down) can be made at a time.

The backrests of the front seats cannot be lowered fully forward.

## Related information

- Power front seat\* (p. 121)
- Using the memory function in the power front seat\* (p. 122)
- Multi-functional front seat\* (p. 123)
- Seatbelt (p. 59)

## Using the memory function in the power front seat\*

The memory function stores settings for the seat, door mirrors, and head-up display\*.

It is possible to store two different settings with the memory function. The memory function keypad is located either on one front door or both\*.

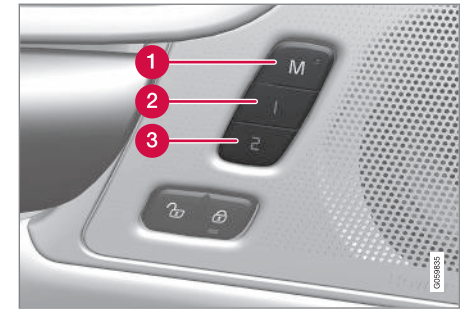

- 1 Button **M** for storing settings.
- 2 Memory button
- 3 Memory button

## Store setting

1. Adjust seat, door mirrors and head-up display to the desired position.
2. Push the **M** button and release. The light indicator in the button illuminates.



3. Within three seconds, depress the **1** or **2** button.
  - > When the position has been stored in the selected memory button an acoustic signal sounds and the light indicator in the **M** button extinguishes.

If none of the memory buttons is depressed within three seconds then the **M** button extinguishes and no storing takes place.

The seat must be adjusted again before a new memory can be set.

### Using a stored setting

A stored setting can be used with the front door either open or closed:

#### Open front door

- Depress one of the memory buttons **1** or **2** with a short press. Seat, door mirrors and head-up display move and then stop at the positions stored in the selected memory button.

#### Closed front door

- Hold one of the memory buttons **1** or **2** depressed until seat, door mirrors and head-up display stop in the positions that are stored in the selected memory button.

If the memory button is released, the movement of the seat, door mirrors and head-up display will be stopped.

### WARNING

Risk of crushing! Make sure that children do not play with the keypad. Check that there are no objects in front of, behind or under the seat during adjustment. Make sure that none of the passengers in the rear seat is in danger of becoming trapped.

### Related information

- Power front seat\* (p. 121)
- Adjusting the power front seat\* (p. 122)

### Multi-functional front seat\*

Enhance the seating comfort using the multi-function control.



Multi-function control, located on the side of the seat's seating section.

The multi-function control can, in some variants, be used to adjust the lumbar support\*, side support\*, cushion length and massage settings\*. Settings made with the multi-function control are shown in the centre display\*. Certain function selections can also be made directly in the centre display.

### Centre display

The driver and the passenger seat settings that are made with the multi-function control are shown in the centre display. If the settings for only one of the front seats are shown in the centre display, the settings are positioned centred in



◀◀ the screen. When it is possible to show setting options for both the front seats, the driver's setting options are shown in the upper half and the passenger's in the lower half.

To stop showing the seat settings view in the centre display, press the home button, which is located under the centre display.

### Related information

- Power front seat\* (p. 121)
- Adjusting functions in the multi-functional front seat\* (p. 124)
- Activating/deactivating heating of the seats\* (p. 201)

## Adjusting functions in the multi-functional front seat\*

Both the multi-function control on the seat and the centre display can be used in order to change the settings. The range of settings is shown in the centre display\*.



Multi-function control, located on the side of the seat's seating section.

To activate the multi-function control, turn the control upwards/downward.

## Adjusting message settings\* in the front seat

The front seat has massage in the backrest. The massage is performed by air cushions that can massage with different settings.

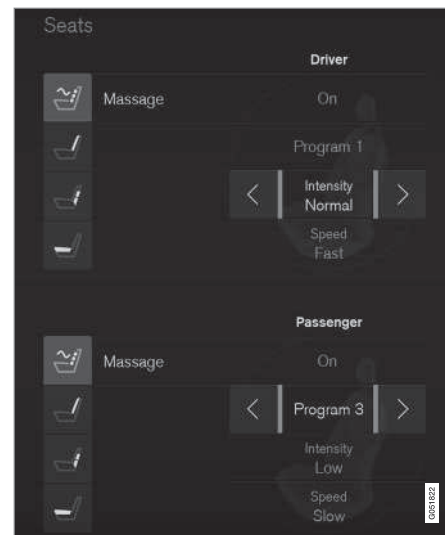

View for message in the centre display.

1. Activate the multi-function control by turning the control upward/downward. The seat settings view will be shown on the centre display.
2. Select **Message** in the seat settings view.

- To choose between the different massage functions, select either directly in the touch screen or by moving the cursor up/down using the multi-function control's upper/lower button. Change the setting in the selected function by selecting directly in the touch screen or by pressing the arrows, or by using the multi-function control's front/rear button.

### Settings for massage

The following setting options are available for massage:

- **On/Off:** Select **On/Off** in order to switch on/off the massage function.
- **Programs 1-5:** There are 5 preset massage programs. Select between **Swell, Tread, Advanced, Lumbar** and **Shoulder**.
- **Intensity:** Select between **Low, Normal** and **High**.
- **Speed:** Select between **Slow, Normal** and **Fast**.

### Restarting massage

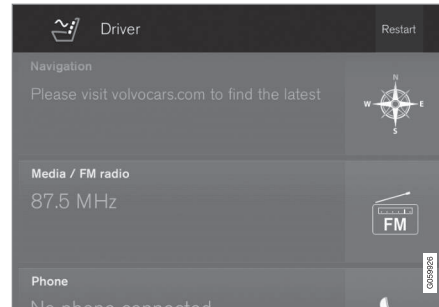

Button for restarting massage in the centre display.

The massage function is deactivated automatically after 20 minutes. The function is reactivated manually.

- Tap on **Restart** in the centre display in order to restart the selected massage program.
  - > The massage program restarts. If no action is taken, the message remains shown in the top view.

It is not possible to use the massage function when the engine is switched off.

### Adjusting side support\* in the front seat backrests

The sides of the backrest can be adjusted to provide side support.

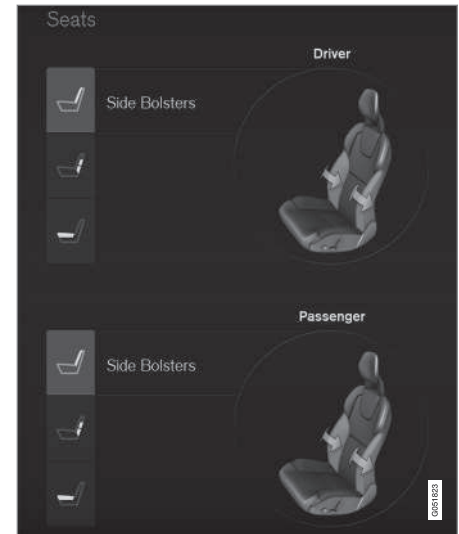

View for adjustable side support in the centre display.

To adjust the side support:

1. Activate the multi-function control by turning the control upward/downward. The seat settings view will be shown on the centre display.



- ◀ 2. Select **Side bolsters** in the seat settings view.
- Press the front seat button in order to increase the side support.
  - Press the rear seat button in order to reduce the side support.

### Adjusting the lumbar support\* in the front seat

The lumbar support can be adjusted upward/downward/forward/backward.

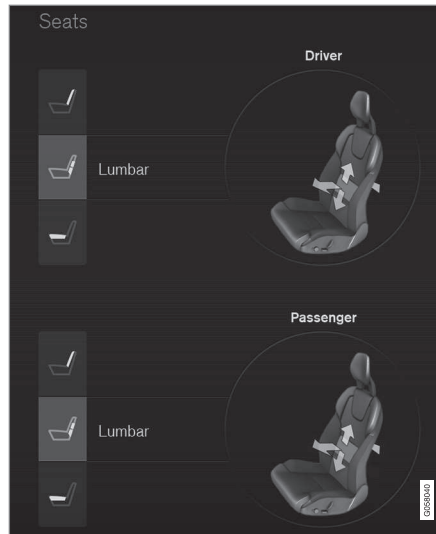

View for lumbar support in the centre display.

To adjust the lumbar support:

1. Activate the multi-function control by turning the control upward/downward. The seat settings view will be shown on the centre display.

2. Select **Lumbar** in the seat settings view.
  - Press the seat button up/down to move the lumbar support up/down.
  - Press the front seat button in order to increase the lumbar support.
  - Press the rear seat button in order to decrease the lumbar support.

### Extending the seat cushion in the front seat

Seat cushion length can be adjusted by using the multi-function control on the seat.

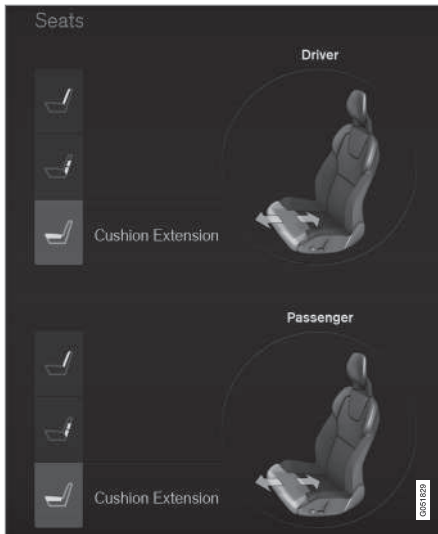

View for extension of the cushion in the centre display.

1. Activate the multi-function control by turning the control upward/downward. The seat settings view will be shown on the centre display.
2. Select **Cushion extension** in the seat settings view.
  - Press the front seat button in order to extend the seat cushion.
  - Press the rear seat button in order to retract the seat cushion.

### Related information

- Multi-functional front seat\* (p. 123)
- Managing messages saved from the driver display and centre display (p. 110)

### Adjusting the passenger seat from the driver's seat\*

The front passenger seat can be adjusted from the driver's seat.

#### Activating the function

The function can be activated in two ways via the centre display:

#### Via the function view



Press the **Adjust passenger seat** button to activate.

#### Via settings

1. Press **Settings** in the top view.
2. Press **My Car** → **Seats**.
3. Select **Adjust Passenger Seat From Driver Position** to activate.

### Adjust passenger seat

From activation of the function, the driver must adjust the passenger seat within 10 seconds. If no adjustment is made within this time the function is deactivated.

The driver adjusts the passenger seat using the controls on the driver's seat:



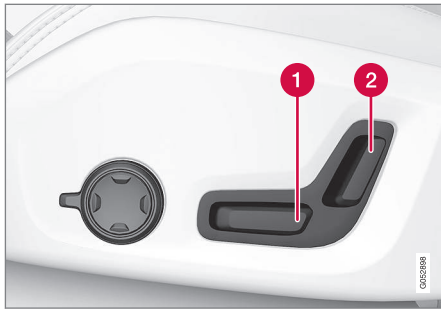

- 1 Move the passenger seat forward/backward by adjusting the control forward/backward.
- 2 Change the passenger seat's backrest rake by adjusting the control forward/backward.

**Related information**

- Power front seat\* (p. 121)
- Adjusting the power front seat\* (p. 122)
- Seatbelt (p. 59)

**Rear seat**

The car has 5 seats. The second seat row is divided into two parts, with one or two passenger seats respectively.

**Related information**

- Lowering the backrests in the rear seat (p. 130)
- Adjusting the head restraints in the rear seat (p. 128)
- Activating/deactivating heating of the seats\* (p. 201)

**Adjusting the head restraints in the rear seat**

Adjust the centre seat head restraint according to the height of the passenger. Fold down the outer seat head restraints\* to improve rearward visibility.

**Adjusting the head restraint, centre seat**

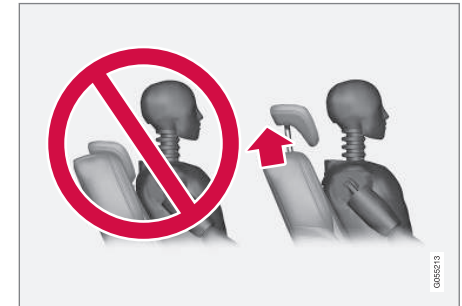

The centre seat's head restraint must be adjusted according to the passenger's height so that, if possible, the whole of the back of the head is covered. Slide it up manually as required.

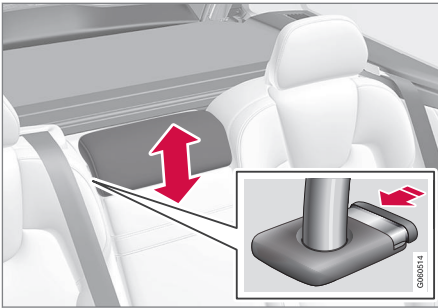

To lower the head restraint, the button (see illustration) must be depressed while the restraint is carefully moved down.

#### **⚠ WARNING**

The centre seat head restraint must be in its lowest position when the centre seat is not used. When the centre seat is used, the head restraint must be correctly adjusted to the height of the passenger so that it covers the whole of the back of the head if possible.

### Electrical lowering of the rear seat's outer head restraints\*



The outer head restraints can be lowered in two ways via the centre display:

#### Via the function view



Press the **Headrest fold** button to activate/deactivate lowering.

#### Via settings

The car's electrical system must be in the ignition position **II**.

1. Press **Settings** in the top view.
2. Press **My Car** → **Seats**.

3. Select **Fold Headrest On Second Row Seats** to lower the rear outer head restraints.

#### **⚠ WARNING**

Do not lower the outer head restraints if there are passengers in any of the outer seats.

Move the head restraint back manually until a click is heard.

#### **⚠ WARNING**

The head restraints must be in locked position after being raised.

#### Related information

- Rear seat (p. 128)
- Lowering the backrests in the rear seat (p. 130)

## Lowering the backrests in the rear seat

The rear seat's backrest is divided into two parts. The two parts can be lowered forward individually.

### **⚠ WARNING**

Adjust the seat and fix it before driving away. Take care when adjusting the seat. Uncontrolled or careless adjustment can lead to trapping injuries.

### **! IMPORTANT**

There must be no objects on the rear seat when the backrest is to be folded down. The seat belts must not be connected either. Otherwise there is a risk of damaging the rear seat upholstery.

### **! IMPORTANT**

The integrated booster cushions\* on the outer seats must be lowered before lowering the seat.

The armrest\* for the centre seat must be raised before lowering the seat.

If the car has private locking, the tailgate must be closed before lowering the seat.

### **i NOTE**

The front seats may need to be pushed forwards, and/or the backrests adjusted upwards, in order that the rear backrests can be fully folded forward.

## Lowering the backrest

### Car with electronic folding

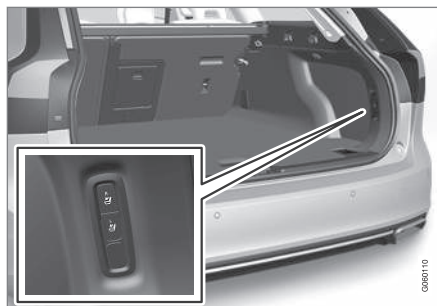

If the car is equipped with electronic folding of the rear seat\* there are buttons located in the cargo area. The backrests can also be lowered manually.

### **⚠ WARNING**

Pay attention that people are not at risk of being trapped during the automatic folding of the rear seat. Since this takes place automatically on the press of a button, no one must be on or too close to the rear seat.

For electronically controlled folding of backrests:

1. Ensure that there are no occupants or objects in the rear seat.
2. Lower the centre seat's head restraint manually.
3. Hold the button for folding depressed. The buttons are marked L and R for left and right backrest section respectively.
4. The backrests are lowered automatically to horizontal position. The head restraints are also lowered automatically.

To facilitate folding of the rear seat, the car must be stationary and the tailgate open.

To lower the backrest manually:



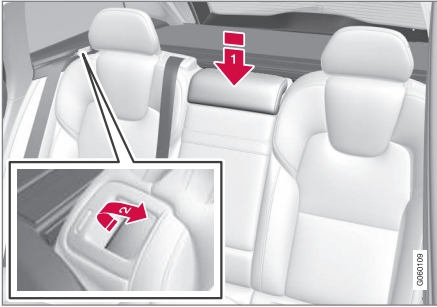

1. Lower the centre head restraint manually.
2. Pull forward the handles that are fitted in the car's left and right-hand rear seat backrests.
3. The backrest disengages from the lock and is automatically lowered to the horizontal position.

### Car without electronic folding

If the car is only equipped with manual lowering of rear seat:

1. Lower the centre seat's head restraint manually.
2. Pull forward the handles that are fitted in the car's left and right-hand rear seat backrests.
3. The seat is released from the lock but remains in the same position. Lower the backrest to the horizontal position.

### Raising the backrest

Raising the backrest to upright position is carried out manually:

1. Move the backrest up/down manually.
2. Slide the backrest until the catch engages.
3. The head restraint is raised manually.
4. If necessary, raise the centre seat's head restraint.

### Related information

- Rear seat (p. 128)
- Adjusting the head restraints in the rear seat (p. 128)

### Steering wheel

The steering wheel has controls for horn, driver support systems and voice recognition, amongst other things.

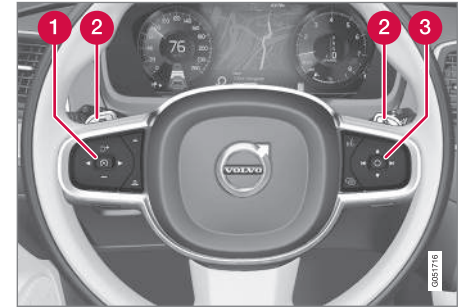

Keypads and paddles\* in the steering wheel.

- 1 Controls for driver support systems<sup>18</sup>.
- 2 Paddle shifter\* for manual gear changing in an automatic gearbox.
- 3 Controls for voice recognition, head-up display settings, and menu, message and phone handling.

<sup>18</sup> Speed Limiter\*, Cruise Control, Adaptive Cruise Control\*, Distance Warning\* and Pilot Assist\*.

◀ **Horn**



The horn is located in the centre of the steering wheel.

**Related information**

- Adjusting the steering wheel (p. 132)
- Activating/deactivating heating of steering wheel\* (p. 203)
- Speed limiter\* (p. 275)
- Cruise control (p. 282)
- Adaptive cruise control\* (p. 288)
- Distance Warning\* (p. 286)
- Pilot Assist\* (p. 302)
- Changing gear with steering wheel paddles\* (p. 393)
- Voice recognition (p. 115)
- Head-up display\* (p. 112)

- Using the application menu in the driver display (p. 106)
- Managing messages in the driver display and the centre display (p. 109)
- Phone (p. 456)

**Adjusting the steering wheel**

The steering wheel can be adjusted in different positions.

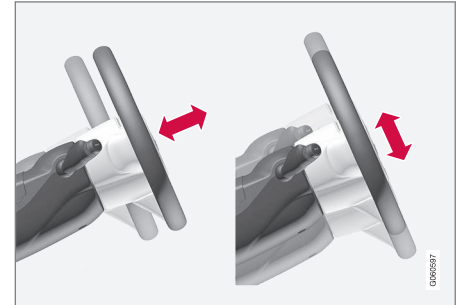

The steering wheel can be adjusted for height and for depth.

Steering wheel adjustment can be made in different ways depending on whether or not the car is equipped with knee airbag<sup>19</sup>.

### **WARNING**

Adjust the steering wheel and fix it before driving away.

With speed related power steering the level of steering force can be adjusted. Steering force is regulated according to the car's speed in order to give the driver enhanced road responsiveness.

#### **With knee airbag**

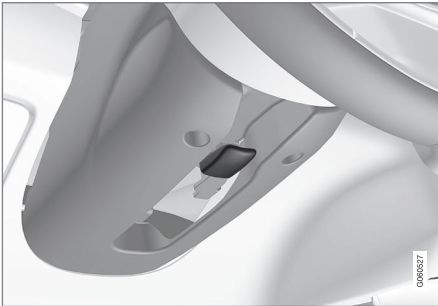

Adjusting the steering wheel.

1. Push the lever forwards to release the steering wheel.

2. Adjust the steering wheel to the position that suits you.
3. Pull the lever back to fix the steering wheel in place. If the lever is stiff, press the steering wheel lightly at the same time as you move the lever back.

#### **Without knee airbag**



Adjusting the steering wheel.

1. Pull the lever backwards to release the steering wheel.
2. Adjust the steering wheel to the position that suits you.
3. Push the lever forwards to secure the steering wheel. If the lever is stiff, press the steering wheel lightly at the same time as you move the lever back.

#### **Related information**

- Steering wheel (p. 131)
- Speed-dependent steering force (p. 270)



<sup>19</sup> The car is only equipped with knee airbag in certain markets.

## Headlamp control

Use the light controls in the left-hand stalk switch to activate external lighting. Use the thumbwheels in the instrument panel to adjust headlamp levelling<sup>20</sup> and the brightness of the interior lighting.

## Rotating ring in the steering wheel stalk switch



Position	Specification
0	Daytime running lights when the car's electrical system is in ignition position II or when the car is running. Main beam flash can be used.
	Daytime running lights and position lamps when the car's electrical system is in ignition position II or when the car is running. Position lamps when the car is parked <sup>A</sup> . Main beam flash can be used.
	Dipped beam and position lamps. Main beam can be activated. Main beam flash can be used.

Position	Specification
AUTO	Daytime running lights and position lamps in daylight when the car's electrical system is in ignition position II or when the car is running. Dipped beam and position lamps in weak daylight or darkness, or when the front fog lamp* and/or rear fog lamp are activated. The Active main beam function can be activated. Main beam can be activated when dipped beam is switched on. Main beam flash can be used.
	Active main beam on/off.

<sup>A</sup> Also at **stationary** when the car is running, provided that the rotating ring is moved to this position from **another position**.

Volvo recommends that **AUTO** mode is used when the vehicle is driven.

<sup>20</sup> Applies to vehicles with halogen headlamps.

**⚠ WARNING**

The car's audio system is not able to determine when daylight is too weak or sufficiently strong, e.g. in fog and rain, in all situations.

The driver is always responsible for ensuring that the car is driven with a beam pattern suitable for the traffic situation and in accordance with applicable traffic regulations.

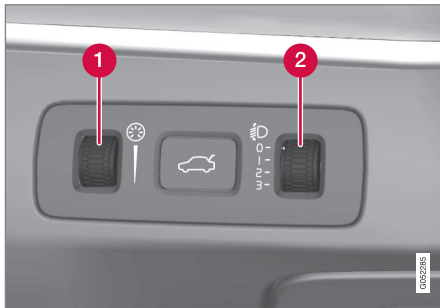
**Thumbwheel in the instrument panel**

**1** Thumbwheel for adjusting interior brightness

**2** Thumbwheel for headlamp levelling

A car with LED<sup>21</sup> headlamps\* has automatic headlamp levelling and therefore does not have the thumbwheel for headlamp levelling.

**Adjusting the interior brightness**

The lamps inside the car come on differently depending on the ignition position used.

The thumbwheel adjusts the brightness of display lighting, control lighting, ambient light and ambience light\*.

**Headlamp levelling**

The load in the car changes the vertical alignment of the headlamp beam, which could dazzle oncoming motorists. Avoid this by adjusting the height of the beam. Lower the beam if the car is heavily laden.

For different load cases and settings, see the section "Headlamp levelling".

**Related information**

- Passenger compartment lighting (p. 145)
- Activating/deactivating main beam (p. 138)
- Ignition positions (p. 383)
- Position lamps (p. 136)
- Headlamp levelling (p. 135)

**Headlamp levelling**

Headlamp levelling<sup>22</sup> is adjusted using one of the thumbwheels in the instrument panel.

1. Leave the engine running, or have the car's electrical system in ignition position **I**.
2. Roll the thumbwheel up/down to raise/lower beam alignment.

The position in which the thumbwheel should be set for a number of load cases is shown below.

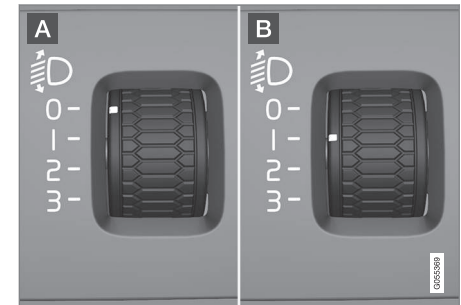

Examples of thumbwheel position.

**A** Thumbwheel in position 0

**B** Thumbwheel in position 1

<sup>21</sup> LED (Light Emitting Diode)

<sup>22</sup> Applies to vehicles with halogen headlamps.



Load case	Thumb-wheel position
Only driver.	0
Driver and passenger in the front passenger seat.	0
Driver and passenger in the front passenger seat.	1
Three passengers in the rear seat.	1
Driver and passenger in the front passenger seat. Three passengers in the rear seat. 220 kg load in the cargo area.	1
Driver and maximum load in the cargo area.	2

**Related information**

- Headlamp control (p. 134)

**Position lamps**

The position lamps are switched on with the rotating ring on the stalk switch.

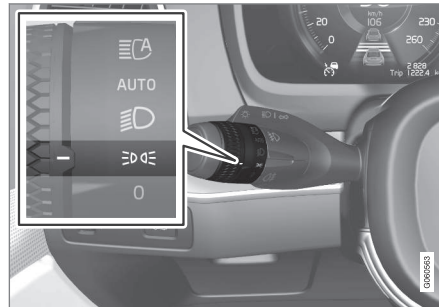

Stalk switch rotating ring in position lamps position.

Turn the rotating ring to the 00000 position - the position lamps are switched on (number plate lighting is switched on at the same time).

If the car's electrical system is in ignition position II or the car is running then the daytime running lights are switched on instead of the front position lamps. However, this does not apply at **stationary** when the car is running, if the rotating ring is moved to position 00000 from **another position**. In this case, the position lamps are switched on.

If the tailgate is opened when it is dark outside, the rear position lamps come on (if not already switched on) to warn road users approaching

from behind. This takes place irrespective of the position of the rotating ring or the ignition position of the car's electrical system.

When driving for more than 30 seconds at max. 10 km/h (approx. 6 mph), or if the speed exceeds 10 km/h (approx. 6 mph), the daytime running lights are switched on. The driver should turn to a position other than 00000.

**Related information**

- Headlamp control (p. 134)
- Ignition positions (p. 383)

## Daytime running lights

The daytime running lights are switched on when the rotating ring on the stalk switch is in position **0**, **☰☑☒** or **AUTO** as well as when the car's electrical system is in ignition position **II** or when the car is running. For the **AUTO** position, this only applies in daylight. In weak daylight or darkness, dipped beam is switched on instead.

### Daytime running lights during the day. DRL

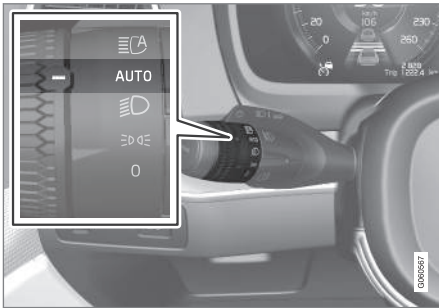

Stalk switch rotating ring in **AUTO** position.

If the stalk switch rotating ring is in the **AUTO** position, the daytime running lights (Daytime Running Lights - DRL) are switched on when the car is driven in daylight. The car automatically changes lighting from daytime running light to dipped beam in weak daylight or darkness.

Changing to dipped beam also takes place if the front fog lamp and/or rear fog lamp are activated.

At **stationary** when the car is running, the position lamps are switched on instead of other lighting, if the rotating ring is moved to the position for position lamps, **☰☑☒**, from **another position**.

### **⚠** WARNING

This system help to save energy - it cannot determine in all situations when daylight is too weak or sufficiently strong, e.g. in mist and rain.

The driver is always responsible for ensuring that the car is driven with the correct beam pattern for the traffic situation and in accordance with applicable traffic regulations.

### Related information

- Headlamp control (p. 134)
- Dipped beam (p. 137)
- Ignition positions (p. 383)

## Dipped beam

When driving with the stalk switch's rotating ring in the **AUTO** position, dipped beam is activated automatically in weak daylight or darkness.

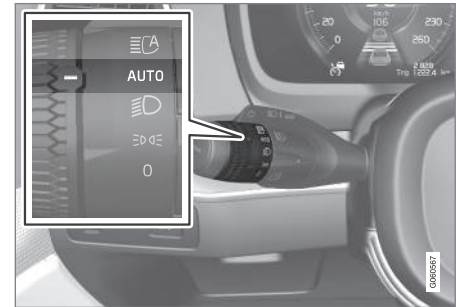

Stalk switch rotating ring in **AUTO** position.

With the stalk switch's rotating ring in the **AUTO** position, dipped beam is activated automatically in weak daylight or darkness, when the car's electrical system is in ignition position **II** or when the car is running.

With the stalk switch's rotating ring in **AUTO** position, dipped beam is also activated automatically if:

- the front fog lamps\* are activated
- the rear fog lamp is activated
- the front and rear fog lamps are activated



- ◀◀ Dipped beam is always switched on when the rotating ring on the stalk switch is in position  when the car's electrical system is in ignition position II or when the car is running.

### Tunnel detection

The car detects when it is driven into a tunnel and switches from daytime running lights to dipped beam.

Note that the rotating ring in the left-hand stalk switch must be in **AUTO** mode for tunnel detection to work.

### Related information

- Daytime running lights (p. 137)
- Headlamp control (p. 134)
- Ignition positions (p. 383)



## Activating/deactivating main beam

Main beam is activated with the stalk switch.

Active main beam is activated with the rotating ring on the stalk switch.



Steering wheel stalk switch with rotating ring.

-  Position for main beam flash
-  Position for main beam

### Main beam flash

Move the stalk switch backwards slightly to main beam flash position. Main beam comes on until the stalk switch is released.

## Main beam

Main beam can be activated when the steering wheel stalk switch's rotating ring is in position

**AUTO**<sup>23</sup> or . Activate main beam by moving the stalk switch forwards. Deactivate by moving the stalk switch backwards.

When main beam has been activated the  symbol illuminates in the driver display.

## Active main beam

Active main beam is a function which uses a camera sensor at the top edge of the windscreen to detect the headlamp beams from oncoming traffic or the rear lights of vehicles in front, and then switches from main beam to dipped beam. The function can also take streetlights into account.

Main beam is reactivated when the camera sensor no longer sees any oncoming vehicles or vehicles ahead.

## Car with halogen headlamps

The lighting returns to main beam about a second after the camera sensor no longer detects the headlamp beams from oncoming traffic or the rear lights from vehicles in front.

<sup>23</sup> When dipped beam is activated.



### Car with LED<sup>24</sup> headlamps\*

If the active main beam has the on/off functionality<sup>25</sup> then the lighting returns to main beam about a second after the camera sensor no longer detects the headlamp beams from oncoming traffic or the rear lights from vehicles in front.

If the active main beam has adaptive functionality<sup>25</sup> then, unlike what happens during conventional dimming, the light beam continues to illuminate with main beam on both sides of oncoming traffic or vehicles ahead - only the part of the light beam that points directly to the vehicle is dimmed.

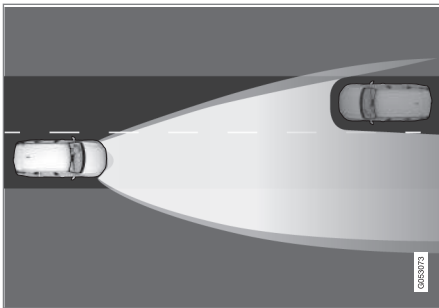

Adaptive functionality: Dipped beam directly towards oncoming vehicle, but continued main beam on both sides of the vehicle.

The lighting returns to full main beam about a second after the camera sensor no longer detects the headlamp beams from oncoming traffic or the rear lights from vehicles in front.

### Activate/deactivate

The function can start while driving in the dark when the car's speed is approx. 20 km/h (12 mph) or higher.

Activate/deactivate active main beam by turning the stalk switch's rotating ring to position  and release. If active main beam is deactivated while main beam is on, the lighting is immediately reset to dipped beam.

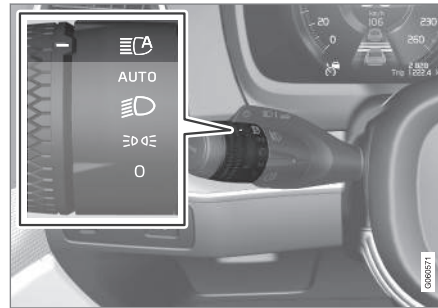

When active main beam is activated, the symbol  illuminates with a white glow in the driver display.

When main beam is activated, the symbol shines blue. This also applies for LED headlamps if the main beam is partially dimmed, i.e. if the light beam shines with slightly more than dipped beam.

<sup>24</sup> LED (Light Emitting Diode)

<sup>25</sup> Depending on the car's equipment level.

## Manual operation

### NOTE

Keep the windscreen surface in front of the camera sensor free from ice, snow, mist and dirt.

Do not stick or attach anything to the windscreen in front of the camera sensor as this may reduce effectiveness or cause one or more of the systems dependent on the camera to stop working.



If this symbol is shown in the driver display, together with the message **Active High Beam Temporarily unavailable**, then switching between main and dipped beam must be performed manually. The rotating ring on the stalk switch can still be in the **AUTO** position. The  symbol extinguishes when these messages are shown.



The same applies if this symbol is shown together with the message **Windscreen sensor blocked, see Owner's manual**.

Active main beam may be temporarily unavailable e.g. in situations with dense fog or heavy rain. When active main beam becomes available again, or the windscreen sensors are no longer blocked,

the message goes out and the  symbol illuminates.

### WARNING

Active main beam is an aid for using the optimum beam pattern when conditions are favourable.

The driver always bears responsibility for manually switching between main and dipped beam when traffic situations or weather conditions so require.

### IMPORTANT

Examples of when manual switching between main and dipped beam may be required:

- In heavy rain or dense fog
- In freezing rain
- In snow flurries or slush
- In moonlight
- When driving in poorly lit built-up areas
- When the traffic ahead has weak lighting
- If there are pedestrians on or beside the road
- If there are highly reflective objects such as signs in the vicinity of the road
- When the lighting from oncoming traffic is obscured by e.g. a crash barrier
- When there is traffic on connecting roads
- On the brow of a hill or in a hollow
- In sharp bends.

Read more about the camera sensor's limitations in the section "Limitations for City Safety".

### Related information

- Headlamp control (p. 134)
- Limitations of City Safety (p. 335)

## Active bending lights\*

Active bending lights are designed to provide maximum illumination in bends and junctions.

Cars with LED<sup>26</sup> headlamps\* can have active bending lights, depending on the car's equipment level.

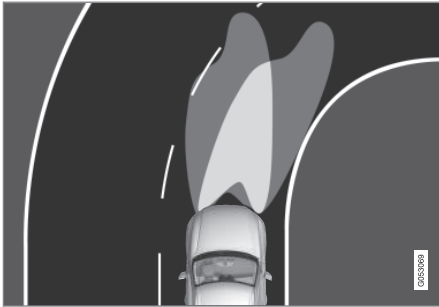

Headlamp pattern with function deactivated (left) and activated (right) respectively.

The LED headlamps can include the Active bending lights function, depending on the car's equipment level. Active bending lights follow steering wheel movements to provide maximum illumination in bends and junctions and thereby increase safety.

The function is activated automatically when the car is started. In the event of a fault in the func-

tion, the  symbol illuminates in the driver display at the same time as the driver display shows an explanatory text.

The function is only active in weak daylight or darkness and only when the car is moving and dipped beam is switched on.

## Deactivating/activating the function

The function is in activated mode when the car is delivered from the factory and can be deactivated/activated via the centre display in two ways:

### Via the function view



Press the **Active Bending Lights** button.

### Via settings

1. Press **Settings** in the top view.
2. Press **My Car** → **Lights and Lighting** → **Exterior Lights**.
3. Deselect/select **Active Bending Lights**.

### Related information

- Settings view (p. 169)
- Front fog lamps/cornering lights\* (p. 142)

## Adapting the beam pattern from the headlamps

If the car is equipped with LED headlamps with adaptive functionality, then the headlamp pattern should be reset when changing from right to left-hand traffic, and vice versa.

### Halogen headlamps

The headlamp pattern does not need to be adjusted. The headlamp pattern is designed in such a way that oncoming traffic is not dazzled.

### LED headlamps\*

The headlamp pattern should be adjusted if the active main beam has adaptive functionality; see the section "Activating/deactivating main beam". The car must remain stationary and be running when the headlamp pattern is changed between right and left-hand traffic.

1. Press **Settings** in the top view in the centre display.
2. Press **My Car** → **Lights and Lighting** → **Exterior Lights**.
3. Select **Temporary Right Hand Traffic/Temporary Left Hand Traffic**.

### Related information

- Settings view (p. 169)
- Activating/deactivating main beam (p. 138)



<sup>26</sup> LED (Light Emitting Diode)

## Front fog lamps/cornering lights\*

The front fog lamps have cornering lights that shine diagonally to the side.



Button for front fog lamps.

The front fog lamps can only be switched on when ignition position **II** is active or the car is running and the rotating ring on the stalk switch is in position **AUTO**,  or .

Press the on/off button. The  symbol in the driver display illuminates when the front fog lamps are switched on.

The front fog lamps are switched off automatically when the ignition knob is turned to **STOP** or when the stalk switch's rotating ring is turned to position **0**.

### NOTE

Regulations on the use of fog lamps vary from country to country.

## Cornering lights

The front fog lamps include the cornering lights function, which temporarily illuminates the area diagonally in front of the car in the direction the steering wheel is turned on a sharp bend, or in the direction shown by the direction indicators.

The function is activated in weak daylight or darkness when the stalk switch's rotating ring is in the **AUTO** or  position and the speed of the car is lower than approx. 30 km/h (20 mph).

In addition, both cornering lights are switched on as a supplement to the reversing lamp during reversing.

The function is activated when the car is supplied from the factory and can be deactivated/activated via the centre display.

## Related information

- Headlamp control (p. 134)
- Rear fog lamp (p. 142)
- Active bending lights\* (p. 141)
- Ignition positions (p. 383)

## Rear fog lamp



When visibility is reduced by fog the rear fog lamp can be used so that other road users can detect the vehicle in front at an early stage.



Button for rear fog lamp.



The rear fog lamp consists of a lamp on the left-hand side on a left-hand drive car, or on the right-hand side on a right-hand drive car.

The rear fog lamp can only be switched on when:

- ignition position **II** is active or the car is running and the stalk switch's rotating ring is in position **AUTO** or 
- the stalk switch's rotating ring is in position  and the front fog lamps are switched on.

Press the on/off button. The  symbol in the driver display illuminates when the rear fog lamp is switched on.

The rear fog lamp is switched off automatically when:

- the ignition knob is turned to **STOP** or when the stalk switch's rotating ring is set in position 
- the stalk switch's rotating ring is in position  and the front fog lamps are switched off.

#### **NOTE**

Regulations on the use of rear fog lamps vary from country to country.

#### **Related information**

- Headlamp control (p. 134)
- Front fog lamps/cornering lights\* (p. 142)
- Ignition positions (p. 383)

## **Brake lights**

The brake light automatically comes on during braking.

The brake light is switched on when the brake pedal is depressed. In addition, it is switched on when one of driver support systems Adaptive cruise control\*, City Safety or Rear Collision Warning brakes the car.

#### **Related information**

- Emergency brake lights (p. 406)
- Adaptive cruise control\* (p. 288)
- City Safety (p. 328)
- Rear Collision Warning (p. 338)

## **Hazard warning flashers**

The hazard warning flashers warn other road users by means of all of the car's direction indicator lamps flashing simultaneously when this function is activated.

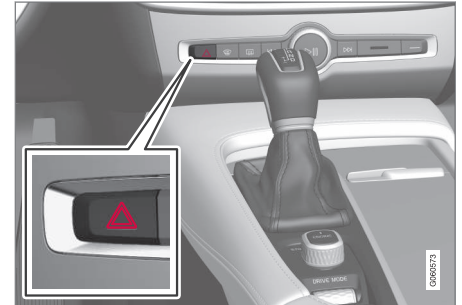

Button for hazard warning flashers.

Press the button to activate the hazard warning flashers.

The hazard warning flashers are automatically activated when the car brakes so powerfully that the emergency brake lights are activated and the speed is low. The hazard warning flashers start to flash after the emergency brake lights have stopped flashing and are then deactivated automatically when the car drives away again or are deactivated if the button is depressed.

## ◀ Related information

- Using direction indicators (p. 144)
- Emergency brake lights (p. 406)

## Using direction indicators

The car's direction indicators are operated with the left-hand stalk switch. The direction indicator lamps flash three times or continuously, depending on how far up or down the stalk switch is moved.



Direction indicators.

### Short flash sequence

- ➡ Move the stalk switch up or down to the first position and release. The direction indicator lamps flash three times. The function can be activated/deactivated via the centre display.

### **i** NOTE

- This automatic flashing sequence can be stopped by moving the stalk switch immediately in the opposite direction.
- If the symbol for direction indicators in the driver display flashes more quickly than normal - see the message in the driver display.

### Continuous flash sequence

- ➡ Move the stalk switch up or down to its end position.

The stalk switch remains in its position and is moved back manually, or automatically by the steering wheel movement.

### Related information

- Headlamp control (p. 134)
- Hazard warning flashers (p. 143)
- Settings view (p. 169)

## Passenger compartment lighting

The passenger compartment lighting is activated/deactivated with the buttons in the overhead controls above the front seats and the rear seat.

All lighting in the passenger compartment can be switched on and off manually within 30 minutes from when:

- the car has been switched off and its electrical system is in ignition position **0**
- the car has been unlocked but it has not been started.

## Front lighting



Controls in roof console for the front reading lamps and passenger compartment lighting.

- 1 Reading lamp, left-hand side
- 2 Passenger compartment lighting
- 3 Auto function for passenger compartment lighting
- 4 Reading lamp, right-hand side

## Front reading lamps

The reading lamps on the right and left-hand sides can be turned on and off by briefly pressing the buttons in the roof console. Brightness is adjusted by holding the button pressed in.

## Passenger compartment lighting

The floor lighting and interior roof lighting are switched on or off with a short press on the button in the roof console.

## Auto function for passenger compartment lighting

The automatic function is activated by a short press on the **AUTO** button in the roof console. The light indicator in the button illuminates when the automatic function is activated. Press the **AUTO** button to switch the passenger compartment lighting on and off in accordance with the following.

Passenger compartment lighting:

- illuminates when the car is unlocked and when it is switched off
- extinguishes when the car is started and when it is locked
- comes on and goes off, respectively, when a side door is opened or closed
- remains on for two minutes if one of the side doors is open.

## Rear lighting

The rear area of the car has reading lighting, which is also used as passenger compartment lighting.

The reading lamps are located in the interior roof.



Reading lamps above the rear seat<sup>27</sup>.



Reading lamp above the rear seat in cars with panorama roof\*.

The reading lamps are switched on or off by briefly pressing the button on the lamp. Brightness is adjusted by holding the button pressed in.

### Glovebox lighting

Glovebox lighting is switched on and off respectively when the lid is opened or closed.

### Vanity mirror lighting\*

The lighting for the vanity mirror in the sun visor is switched on and off respectively when the cover is opened or closed.

### Ground lighting

The ground lighting is switched on and off when the corresponding door is opened or closed.

### Door sill lighting

The door sill lighting is switched on and off when the corresponding door is opened or closed.

### Lighting in the cargo area

The lighting in the cargo area is switched on and off respectively when the tailgate is opened or closed.

### Ambient light

1. Press **Settings** in the top view in the centre display.
2. Press **My Car** → **Lights and Lighting** → **Interior Lighting**.

3. Choose between the following settings:

- Under **Ambient Light Intensity**, select from **Off**, **Low** and **High**.
- Under **Ambient Light Level**, select from **Reduced** and **Full**.



Controls located next to the steering wheel.

The intensity of the ambient light can be adjusted using the control in the instrument panel:

- Turn the thumbwheel to adjust the intensity.

### Ambience lights\*

The car is equipped with a number of LEDs that make it possible to change the colour of the light. These lights are switched on when the car is running.

<sup>27</sup> In cars with panorama roof\* there are two lamp units, one on each side of the roof.



The ambience lights can be changed via the centre display:

### Changing the brightness of the lights

1. Press **Settings** in the top view in the centre display.
2. Press **My Car** → **Lights and Lighting** → **Interior Lighting** → **Interior Mood Lighting**.
3. Under **Interior Mood Light Intensity**, select from **Off**, **Low** and **High**.

### Changing the colour of the light

1. Press **Settings** in the top view in the centre display.
2. Press **My Car** → **Lights and Lighting** → **Interior Lighting** → **Interior Mood Lighting**.
3. Choose between **By Temperature**, **By Colour** and **Theme Colours** in order to change the colour of the light.

With colour option **By Temperature**, the colour of the light changes according to the set passenger compartment temperature.



Controls located next to the steering wheel.

The intensity of the ambience light can be adjusted using the controls in the instrument panel:

- Turn the thumbwheel to adjust the intensity.

### Lighting in storage compartments in doors

The lighting in storage compartments in doors is switched on when the car is running. The brightness can be finely adjusted using the control in the instrument panel.

### Lighting in front cup holders in tunnel console

The lighting in the front cup holders is switched on when the car is unlocked and is switched off when the car is locked. The brightness can be finely adjusted using the control in the instrument panel.

### Related information

- Headlamp control (p. 134)
- Ignition positions (p. 383)
- Settings view (p. 169)

## Home safe light duration

Some of the exterior lighting can be kept switched on to work as home safe lighting after the car has been locked.

To activate the function:

1. Switch off the car.
2. Move the left-hand stalk switch forward toward the instrument panel and release.
3. Get out of the car and lock the door.

When the function is activated, dipped beam, position lamps, lighting in the outside handles\* and number plate lighting are switched on.

The length of time that home safe lighting remains on can be set via the centre display.

### Related information

- Approach light duration (p. 148)
- Settings view (p. 169)

## Approach light duration

Approach lighting is switched on when the car is unlocked and is used to switch on the car's lighting at a distance.

When the function is activated with the remote control key during unlocking, the position lamps, lighting in outer handles\*, number plate lighting, interior roof lighting and floor lighting will switch on. If a door is opened within the activation time, the time for the lighting in the outside handles\* and the interior lighting will be extended.

The function can be deactivated/activated via the centre display.

### Related information

- Home safe light duration (p. 148)
- Remote control key (p. 234)
- Settings view (p. 169)

## Using windscreen wipers

The windscreen wiper cleans the windscreen. Different settings for the windscreen wiper are made with the right-hand steering wheel stalk switch.

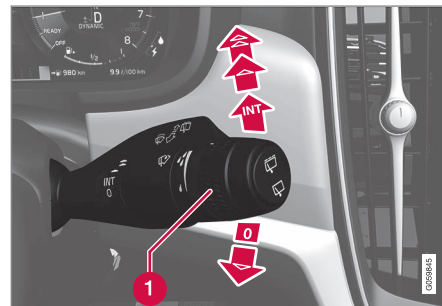

Right-hand stalk switch.

- 1 Thumbwheel sensitivity/frequency

### Single sweep



Lower the stalk switch and release to make one sweep.

### Windscreen wipers off



Move the stalk switch to position 0 to switch off the windscreen wipers.

### Intermittent wiping



Set the number of sweeps per time unit with the thumbwheel when intermittent wiping is selected.

### Continuous wiping



Raise the stalk switch for the wipers to sweep at normal speed.



Raise the stalk switch further for the wipers to sweep at high speed.

#### ! IMPORTANT

Before activating the wipers - ensure that the wiper blades are not frozen in, and that any snow or ice on the windscreen (and rear window) is scraped away.

#### ! IMPORTANT

Use plenty of washer fluid when the wipers are cleaning the windscreen. The windscreen must be wet when the windscreen wipers are operating.

### Related information

- Activating/deactivating the rain sensor (p. 149)
- Windscreen and headlamp washers (p. 150)
- Wiper blades in service position (p. 527)

### Activating/deactivating the rain sensor

The rain sensor automatically starts the windscreen wipers based on how much water it detects on the windscreen. Rain sensor sensitivity can be adjusted with the thumbwheel on the right-hand stalk switch.

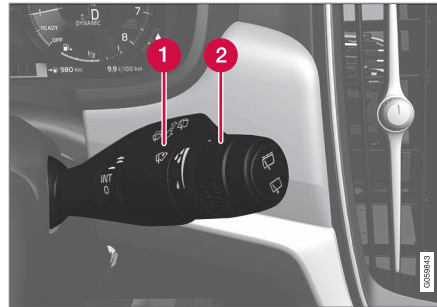

Right-hand stalk switch.

- 1 Rain sensor button
- 2 Thumbwheel sensitivity/frequency

When the rain sensor is activated, the rain sensor symbol  is shown in the driver display.

#### Activating the rain sensor

When activating the rain sensor, the car must be running or the electrical system in ignition position **I** or **II** while the windscreen wiper stalk

switch must be in position **0** or in the position for a single sweep.

Activate the rain sensor by pressing the rain sensor button .

Press the stalk switch down for the wipers to make an extra sweep.

Turn the thumbwheel upward for higher sensitivity and downward for lower sensitivity. An extra sweep is made when the thumbwheel is turned upward.

#### Deactivating the rain sensor

Deactivate the rain sensor by pressing the rain sensor button  or moving the stalk switch up to another wiper program.

The rain sensor is deactivated automatically in ignition position **0** or when the engine is switched off.

The rain sensor is deactivated automatically when wiper blades are set in service position. The rain sensor is reactivated when service position has been deactivated.

#### ! IMPORTANT

The windscreen wipers could start and be damaged in an automatic car wash. Deactivate the rain sensor while the car is running or when the car's electrical system is in ignition position **I** or **II**. The symbol in the driver display extinguishes.



## ◀ Activating/deactivating the memory function

The memory function for the rain sensor can be activated in such a way that the rain sensor button does not need to be depressed each time the car is started:

1. Press **Settings** in the top view in the centre display.
2. Press **My Car** → **Wipers**.
3. Select **Rain Sensor Memory** to activate/deactivate the memory function.

### Related information

- Using windscreen wipers (p. 148)
- Wiper blades in service position (p. 527)
- Rear window wiper and washer (p. 151)

## Windscreen and headlamp washers

Windscreen and headlamp washers clean the windscreen and headlamps. Washing/wiping is started by means of the right-hand stalk switch.

### Starting windscreen and headlamp washers



Washing function, right-hand stalk switch.

- Move the right-hand stalk switch toward the steering wheel to start the windscreen and headlamp washers.
  - > The windscreen wipers will make several more sweeps once the stalk switch has been released.

### ! IMPORTANT

Avoid activating the washer system when it is frozen or the washer reservoir is empty, otherwise there is a risk of damaging the pump.

## Heated washer nozzles\*

The washer nozzles are heated automatically in cold weather to prevent the washer fluid from freezing.

## Headlamp washing\*

To save fluid, the headlamps are washed automatically at every fifth windscreen wash cycle.

## Reduced washing

If only approx. 1 litre of washer fluid remains in the reservoir and the message **Washer fluid Level low, refill**, together with the  symbol, is shown in the driver display, then the supply of washer fluid to the headlamps is switched off. This is in order to prioritise cleaning the windscreen and the visibility through it.

### Related information

- Using windscreen wipers (p. 148)
- Rear window wiper and washer (p. 151)
- Filling washer fluid (p. 529)

## Rear window wiper and washer



Rear window wiper and washer clean the rear window. Washing/wiping is started and settings are changed by means of the right-hand steering wheel stalk switch.

### **i** NOTE

The rear window wiper is equipped with overheating protection which means that the motor is switched off if it overheats. The rear window wiper works again after a cooling-down period.

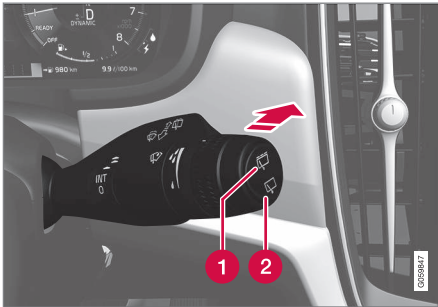
## Using the rear window wiper and washer



- 1 Select  for intermittent wiping with the rear window wiper.
- 2 Select  for continuous speed with the rear window wiper.

- Move the right-hand steering wheel stalk switch forward to start rear window washing and wiping.

## Activating/deactivating wiping when reversing

1. Press **Settings** in the top view in the centre display.
2. Press **My Car** → **Wipers**.
3. Select **Auto Rear Wiper** to activate/deactivate wiping when reversing.

Engaging reverse gear while the windscreen wipers are on initiates rear window wiping. The function stops when reverse gear is disengaged.

If the rear window wiper is already on at continuous speed, no change is made.

## Related information

- Using windscreen wipers (p. 148)
- Windscreen and headlamp washers (p. 150)
- Activating/deactivating the rain sensor (p. 149)

## Power windows

Using the driver's door control panel, all power windows can be operated - using the control panels in the other doors operates the power window in the individual door.



Driver's door control panel.

- 1 Electric child safety locks\* that prevent children from being able to open the rear doors from inside and open/close the rear windows.
- 2 Controls for rear windows.
- 3 Controls for front windows.

## Related information

- Operating power windows (p. 152)
- Child safety locks (p. 259)

## Operating power windows

Using the driver's door control panel, all power windows can be operated - using the control panels in the other doors operates the power window in the individual door.

### WARNING

Check that no children or other passengers are trapped when the windows are closed from the driver's door.

### WARNING

Check that no children or other passengers are trapped if/when the windows are closed using the remote control key.



### WARNING

If there are children in the car - remember to always switch off the power supply to the power windows by setting the car's electrical system in ignition position **0** and then take the remote control key with you when leaving the car.

## Operating



Operating the power windows.

-  Operating without auto
-  Operating with auto

Using the driver's door control panel, all power windows can be operated - using the control panels in the other doors can only operate the power window in the individual door. Only one control panel can be operated at a time.

In order for the power windows to be used, the ignition position must be at least **I**. The power windows can be operated for a few minutes after the car has been switched off and after the ignition has been switched off - although not after a door has been opened.

Closing of the windows is stopped and the window is opened if anything prevents its movement. It is possible to override the pinch protection

when closing has been interrupted, e.g. if ice has formed on the window. After two successive closing interruptions the pinch protection will be overridden and the automatic function deactivated for a short while, now it is possible to close by holding the button in its raised position.

### NOTE

One way to reduce the pulsating wind noise when the rear windows are open is to also open the front windows slightly.

### NOTE

The windows cannot be opened at speeds above approx. 180 km/h (112 mph), but they can be closed.

### Operating without auto

Move one of the controls up/down gently. The power windows move up/down as long as the control is held in position.

### Operating with auto

Move one of the controls up/down to the end position and release it. The window runs automatically to its end position.

### Operating with the remote control key, door handle or central locking button

To control the power windows from the outside with the remote control key or door handle, or from the inside with the central locking button, see the section "Remote control key", "Locking/unlocking from the outside" or "Locking/unlocking from the inside".

### Resetting

If the starter battery is disconnected then the function for automatic opening must be reset so that it can work correctly.

1. Gently raise the front section of the button to raise the window to its end position and hold it there for one second.
2. Release the button briefly.
3. Raise the front section of the button again for one second.

### **⚠ WARNING**

A reset must take place for pinch protection to work.

### Related information

- Power windows (p. 151)
- Ignition positions (p. 383)
- Remote control key (p. 234)
- Locking/unlocking from the outside (p. 239)
- Locking/unlocking from the inside (p. 243)

### Using the sun blind\*

Sun blinds are built into each rear door.

#### In the rear door - manually operated



- 1 Hook with associated catch
- Pull up the sun blind and attach it to the hook in the upper door frame.

The window can still be opened and closed with the sun blind up.

### Adjusting the door mirrors

The door mirror positions are adjusted with the joystick in the driver's door control panel.



Controls for door mirrors.

### Adjusting

1. Press the **L** button for the left-hand door mirror or the **R** button for the right-hand door mirror. The light in the button illuminates.
2. Adjust the position with the joystick in the centre.
3. Press the **L** or **R** button again. The light should no longer be illuminated.

### **⚠ WARNING**

Both mirrors are the wide-angle type to provide optimal vision. Objects may appear further away than they actually are.



#### ◀ Memory function in power front seat\*

Door mirror positions can be saved in the memory function of the power front seat.

#### Angling the door mirror when parking<sup>28</sup>

The door mirror can be angled down for the driver to view the side of the road when parking for example.

- Engage reverse gear and press the **L** or **R** button.

When reverse gear is disengaged the mirror automatically returns to its original position after approx. 10 seconds, or earlier by pressing the button labelled **L** or **R** respectively.

#### Automatic angling of the door mirror when parking<sup>28</sup>

When reverse gear is engaged the door mirror is automatically angled down so that the driver can see the side of the road when parking for example. When reverse gear is disengaged the mirror automatically returns to its original position after a short time.

Settings for this function are set via the centre display:

1. Press **Settings** in the top view.
2. Press **My Car → Mirrors and Easy Entry**.

3. Under **Exterior Mirror Tilt at Reverse**, select **Off**, **Driver**, **Passenger** or **Both** to activate/deactivate and to select which review mirror should be angled.

#### Automatic retraction when locking\*

When the car is locked/unlocked with the remote control key the door mirrors are automatically retracted/extended.

The function can be activated/deactivated via the centre display:

1. Press **Settings** in the top view.
2. Press **My Car → Mirrors and Easy Entry**.
3. Select **Fold Mirror When Locked** to activate/deactivate.

#### Resetting to neutral

Mirrors that have been moved out of position by an external force must be reset electrically to the neutral position for electric retracting/extending to work correctly:

1. Retract the mirrors with the **L** and **R** buttons.
2. Fold them out again with the **L** and **R** buttons.
3. Repeat the above procedure as necessary.

The mirrors are now reset in neutral position.

#### Automatic dimming\*

Bright light from behind is automatically dimmed by the interior rearview and door mirrors.

For the door mirrors to be fitted with this function requires that the interior rearview mirror also has automatic dimming, see the section "Interior rearview mirror".

Automatic dimming is always active while driving, apart from when gearbox reverse position is selected. Dimming sensitivity can be adjusted in three levels and will affect the interior rearview and the door mirrors.

#### **i** NOTE

When sensitivity is changed there is no immediately noticeable change in dimming, but the change will be complete after a while.

Settings for this function are set via the centre display:

1. Press **Settings** in the top view.
2. Press **My Car → Mirrors and Easy Entry**.
3. Under **Rearview Mirror Auto Dimming**, select **Normal**, **Dark** or **Light**.

<sup>28</sup> Only in combination with power seat with memory.



### Retractable power door mirrors\*

The mirrors can be retracted for parking/driving in narrow spaces:

1. Depress the **L** and **R** buttons simultaneously (ignition position must be at least **I**).
2. Release them after approximately 1 second. The mirrors automatically stop in the fully retracted position.

Fold out the mirrors by pressing down the **L** and **R** buttons simultaneously. The mirrors automatically stop in the fully extended position.

### Related information

- Interior rearview mirror (p. 155)
- Settings view (p. 169)
- Using the memory function in the power front seat\* (p. 122)

### Interior rearview mirror

The interior rearview mirror can be dimmed with a control in the mirror's lower edge. Alternatively, the rearview mirror dims automatically.



- 1 Control for dimming

### Manual dimming

Bright light from behind could be reflected in the rearview mirror and dazzle the driver. Use dimming with the dimming control when lights from behind are distracting:

1. Use dimming by moving the control in towards the passenger compartment.
2. Return to normal mode by moving the control towards the windscreen.

### Automatic dimming\*

Bright light from behind is automatically dimmed by the rearview mirror. The control for manual dimming is not available on mirrors with automatic dimming.

The rearview mirror contains two sensors - one forward facing and one rearward facing - that work together to identify and eliminate dazzling light. The forward facing sensor detects ambient light, while the rearward facing sensor detects the light from vehicle headlights behind.

#### **i** NOTE

If the sensors are obscured by e.g. parking permits, transponders, sun visors or objects in the seats or in the cargo area in such a way that light is prevented from reaching the sensors, then the dimming function of the interior rearview and door mirrors is reduced.

Automatic dimming is always active while driving, apart from when gearbox reverse position is selected. Dimming sensitivity can be adjusted in three levels and will affect the interior rearview and the door mirrors.

#### **i** NOTE

When sensitivity is changed there is no immediately noticeable change in dimming, but the change will be complete after a while.



◀ Settings for this function are set via the centre display:

1. Press **Settings** in the top view.
2. Press **My Car → Mirrors and Easy Entry**.
3. Under **Rearview Mirror Auto Dimming**, select **Normal, Dark** or **Light**.

### Related information

- Adjusting the door mirrors (p. 153)
- Settings view (p. 169)

### Compass\*

The upper right-hand corner of the rearview mirror has an integrated display that shows the compass direction in which the front of the car is pointing.

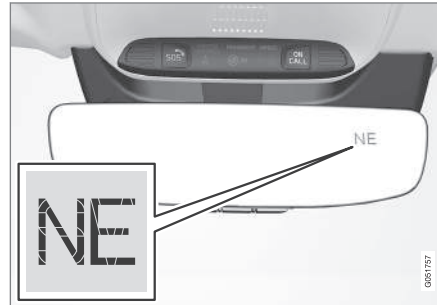

Rearview mirror with compass.

Eight different compass directions are shown by their English abbreviations: **N** (north), **NE** (north east), **E** (east), **SE** (south east), **S** (south), **SW** (south west), **W** (west) and **NW** (north west).

### Activating/deactivating the compass

The compass is activated automatically when the car is started.

To deactivate/activate the compass:

- Depress the button on the underside of the rearview mirror using e.g. a paper clip.

### Related information

- Calibrating the compass\* (p. 157)
- Ignition positions (p. 383)
- Activating/deactivating defrost of windows and door mirrors (p. 192)

## Calibrating the compass\*

The earth is divided into 15 magnetic zones. The compass should be calibrated if the car is moved between several magnetic zones.

Proceed as follows to perform calibration:

1. Stop the car in a large open area free from steel structures and high-voltage power lines.
2. Start the car and switch off all electrical equipment (air conditioning, wipers, etc.) and ensure that all doors are closed.

### **i** NOTE

Calibration may fail or not start at all if electrical equipment is not switched off.

3. Hold the button on the underside of the rearview mirror depressed (use a paper clip or similar) for approx. 3 seconds. The number of the current magnetic zone is shown.

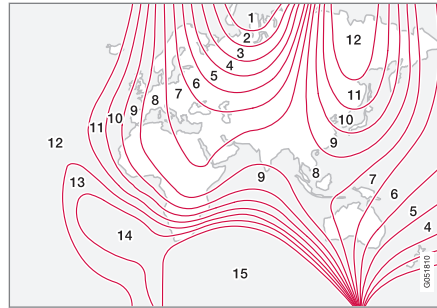

Magnetic zones.

4. Press the button repeatedly until the required magnetic zone (1–15) is shown. See the map of magnetic zones for the compass.
5. Wait until the display returns to showing the character **C**, or hold the button on the underside of the rearview mirror depressed for approx. 6 seconds until the character **C** is shown.
6. Drive slowly in a circle at a speed of no more than 10 km/h (6 mph) until a compass direction is shown in the display, indicating that calibration is complete. Then drive a further 2 circles to fine-tune calibration.

7. **Cars with heated windscreen\*:** If the character **C** is shown in the display when the heated windscreen is activated, perform the calibration in accordance with point 6 above with the heated windscreen activated.
8. Repeat the above procedure as necessary.

### Related information

- Compass\* (p. 156)

## Panorama roof\*

The panorama roof is divided into two glass sections. The front section can be opened vertically at the rear edge (ventilation position) or horizontally (open position). The rear section is fixed roof glass.

The panoramic roof has a wind deflector.

The panorama roof has a sun blind made of perforated fabric and located under the glass roof to provide extra protection from factors such as strong sunlight.



The panoramic roof and sun blind are operated with a control located in the roof.

The control is activated when the car's electrical system is in ignition position **I** or **II**.

### **WARNING**

Children, other passengers or objects may be trapped by the panorama roof's moving parts.

- Always operate the panorama roof with caution.
- Do not allow children to play with the controls.
- Remember to always switch off the power supply to the panorama roof by setting the car's electrical system in ignition position **0**, and then take the remote control key with you when leaving the car.

### **IMPORTANT**

Do not open the panorama roof when load carriers are fitted.

## Wind deflector

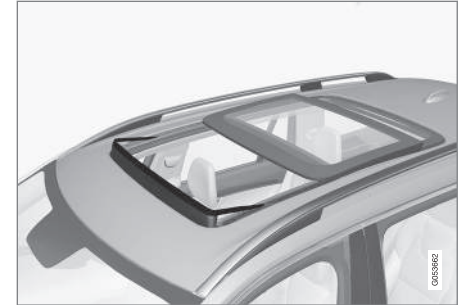

The panorama roof has a wind deflector that is raised when the panorama roof is in the open position.

### **Related information**

- Operating the panorama roof\* (p. 159)
- Ignition positions (p. 383)

## Operating the panorama roof\*

When operating with the control in the roof, the panoramic roof is first opened horizontally to a comfort position.

In ventilation position, the front glass cover in the roof is raised at the rear.

### **⚠ WARNING**

Children, other passengers or objects may be trapped by the panorama roof's moving parts.

- Always operate the panorama roof with caution.
- Do not allow children to play with the controls.
- Remember to always switch off the power supply to the panorama roof by setting the car's electrical system in ignition position **0**, and then take the remote control key with you when leaving the car.

### **⚠ IMPORTANT**

Do not open the panorama roof when load carriers are fitted.

In order that the panoramic roof and sun blind can be operated, the car's electrical system must be in at least ignition position **I**.

## Operating with the control in the roof

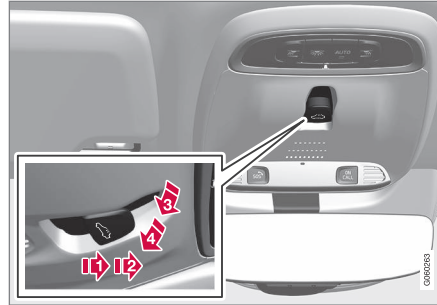

- ➔ Opening, manual
- ➔ Opening, automatic
- ➔ Closing, manual
- ➔ Closing, automatic

### Manual operation

1. To open the sun blind - press the control backwards to the position for manual opening. The sun blind moves towards maximum opening position for as long as the control is held depressed rearward.

2. Open the panorama roof - press the control backwards a second time to the position for manual opening. The panoramic roof first reaches comfort position<sup>29</sup>. In order to open to maximum opening position - press the control backwards a third time.

Close the roof/blind by repeating the preceding procedure in reverse order - press the control forward/downward to the manual closing position instead.

The movement of the roof is stopped if the control is released or when the glass reaches the comfort position or the maximum opening or closing position.

### **i NOTE**

For manual opening, the sun blind must be fully open before the panoramic roof can be opened. When the procedure is reversed, the panoramic roof must be fully closed before the sun blind can be closed.

<sup>29</sup> Comfort position is an open position for the glass cover, where wind noise and resonance noise are at a comfortably low level while driving.



### ◀ Automatic operation

1. Open the sun blind to maximum position - press the control backward to the position for automatic opening and release.
2. To open the panorama roof, press the control backwards a second time to the position for automatic opening and release. The panoramic roof first reaches comfort position<sup>29</sup>. To open to the maximum opening position - press the control a third time backward to the position for automatic opening and release.

Close the roof/blind by repeating the preceding procedure in reverse order - press the control forward/downward to the automatic closing position instead.

The movement of the roof is stopped when the glass reaches the comfort position or the maximum opening or closing position. The movement is also stopped if the control is operated again in the opposite direction to the direction of movement in progress.

The movement of the roof is not stopped when the glass reaches the comfort position when closing from maximum opening position.

### Automatic operation - rapid opening/closing

The panorama roof and sun blind can be opened/closed simultaneously:

- To open - press the control rearward to the automatic operation position twice and release.
- To close - press the control forward/downward to the automatic operation position twice and release.

The movement of the roof is stopped when the glass reaches the comfort position or the closing position. The movement is also stopped if the control is operated again in the opposite direction to the direction of movement in progress.

The movement of the roof is not stopped when the glass reaches the comfort position when closing from maximum opening position. The movement of the blind is never stopped when the roof reaches comfort position.

### Ventilation position

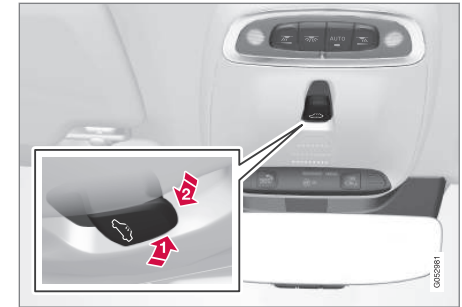

Ventilation position, vertically at the rear edge.

- 1 Open by pressing the control upward.
- 2 Close by pressing the control forward/downward.

When the ventilation position is selected the front glass cover is raised at its rear edge. If the sun blind is fully closed when ventilation position is selected, then it opens automatically approx. 50 mm.

### Automatic closing of the sun blind

When the car is parked in sunny/hot weather, the sun blind closes automatically 15 minutes after the car is locked. This is in order to lower the passenger compartment temperature and protect the car upholstery from being bleached by the sun.

<sup>29</sup> Comfort position is an open position for the glass cover, where wind noise and resonance noise are at a comfortably low level while driving.

The function is deactivated when the car is supplied from the factory and can be activated/deactivated:

1. Press **Settings** in the top view in the centre display.
2. Press **My Car → Locking**.  
Select **Auto Close Sunroof Curtain** to activate/deactivate.

## Closing using the remote control key, central locking button or door handles

### Remote control key

- Give a long press on the remote control key's lock button  until the panorama roof and sun blind start moving towards the closed position. Then release the lock button.

Movement stops if the remote control key's lock button is pressed again or when the roof/blind has reached the closed position.

### Central locking button



Central locking button.

When the car's electrical system is set in at least ignition position **I**, the central locking button in the driver's door or passenger door\* can be used to close the panoramic roof.

- Give a long press on the central locking button  until the panorama roof and sun blind start moving towards the closed position. Then release the button.

Movement stops if the central locking button is pressed again or when the roof/blind has reached the closed position.

### Door handle

Cars equipped with keyless locking/unlocking\* have a touch-sensitive recess on the outer part of the outside door handle.

- Place your finger against the touch-sensitive recess on the outside of one of the door handles until the panorama roof and sun blind start moving towards the closed position. Then remove your finger from door handle's recess.

Movement stops if you place your finger against the door handle recess again or once the roof/blind has reached the closed position.

### WARNING

If the panorama roof is closed with the remote control key, the central locking button or door handle, check that no one risks being trapped.

### IMPORTANT

Check that the panoramic roof is properly closed when closing.

### Pinch protection

The panorama roof has pinch protection that is triggered if the glass cover or the sun blind is blocked by an object during closing. In the event of blocking, the glass cover or sun blind stops and is then opened automatically to approx. 50 mm from the blocked position (or to full ventilation position). The pinch protection is also active when the glass cover or sun blind is opened.

If the pinch protection has deployed then it is still possible to operate the glass cover and/or sun



- ◀◀ blind once more in the same direction without pinch protection, if this is done within 10 seconds after pinch protection deployment. It is therefore possible to override the pinch protection when closing has been interrupted e.g. if ice has formed around the glass cover, by continually pressing the control forward/downward until the glass cover and/or sun blind is closed.

**Related information**

- Panorama roof\* (p. 158)
- Ignition positions (p. 383)
- Remote control key (p. 234)
- Locking/unlocking from the inside (p. 243)
- Locking/unlocking from the outside (p. 239)

**HomeLink®<sup>30</sup>**

HomeLink® is a programmable remote control that is integrated into the car's electrical system.

**General**

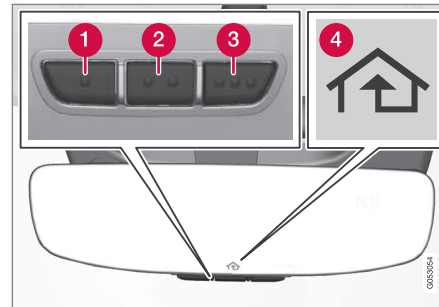

- 1 Button 1
- 2 Button 2
- 3 Button 3
- 4 Indicator lamp

HomeLink®<sup>31</sup> is a programmable remote control that can remotely control up to three different devices (e.g., garage door openers, alarm systems, outdoor and indoor lighting, etc.) and thus replace their remote controls. HomeLink® is supplied built into the interior rearview mirror. The

HomeLink® panel consists of three programmable buttons and one indicator lamp in the mirror glass.

For more information about HomeLink®, visit [www.HomeLink.com](http://www.HomeLink.com), [www.youtube.com/HomeLinkGentex](http://www.youtube.com/HomeLinkGentex) or call the toll-free number 00 8000 466 354 65 (or the toll number +49 6838 907 277).

**⚠ WARNING**

- If HomeLink® is used to control a garage door or gate, ensure that nobody is near the door or gate while it is in motion.
- While programming HomeLink, the garage door or gate being programmed may activate. For this reason, make sure that nobody is in the vicinity of the door or gate while programming is in progress.
- The car should be outside the garage while a garage door opener is being programmed.
- Do not use HomeLink® for any garage door that does not have safety stop and safety reverse.

Save the original remote controls for future programming (e.g. when changing to another car or for use in another vehicle). It is also recom-

<sup>30</sup> Applies to certain markets.

<sup>31</sup> HomeLink and the HomeLink house symbol are registered trademarks of Gentex Corporation.



mended that the programming for the buttons is deleted when the car is sold; see the section "Programming HomeLink®".

### Related information

- Programming HomeLink®\* (p. 163)

## Programming HomeLink®<sup>32</sup>

Instructions for programming HomeLink®.

### Programming HomeLink®

#### NOTE

In certain vehicles the ignition must be switched on or in "accessory position" before HomeLink® can be programmed or used. Preferably fit new batteries in the remote control that will be replaced by HomeLink® for faster programming and improved transmission of the radio signal. The HomeLink® buttons should be reset before programming, see the heading "Resetting the HomeLink® buttons". When the reset is complete, HomeLink® is set in "learn mode" and ready for programming.

1. Press the<sup>33</sup> button on HomeLink® you want to program. The indicator lamp<sup>33</sup> on HomeLink® should flash yellow once per second. It is not necessary to hold the button depressed.

2. Aim the remote control towards the HomeLink® button to be programmed and hold it 2-8 cm from the button. Do not obstruct the indicator lamp on HomeLink®.

**Note:** Some remote controls can program HomeLink® better at a distance of 15-20 cm. Bear this in mind if you encounter problems during programming.

3. Press and hold the button on the original remote control to be programmed on HomeLink® and keep an eye on the indicator lamp. Do not release the button until the indicator lamp has switched from flashing yellow once per second to either flashing green 10 times per second or illuminating in a constant green glow. The button on the remote control can be released once the indicator lamp flashes or illuminates in green.

**Note:** For some receivers, programming step 3 may need to be replaced with the instructions in step 4.

4. Press and release the button on the original remote control every other second until the indicator lamp has changed from flashing yellow once per second to either flashing green 10 times per second or illuminating in a constant green glow.

<sup>32</sup> Applies to certain markets.

<sup>33</sup> See section "HomeLink®\*" for the location of buttons and indicator lamp.



5. Depress the programmed HomeLink® button and check the indicator lamp.

> **Constant green glow:** If the indicator lamp illuminates in a constant green glow, **programming is complete.** The garage door, gate or similar should now be activated when the programmed button is depressed.

**Flashes green 10 times per second:**

Depress the button being programmed, **hold it depressed for 2 seconds and then release it.** Repeat the sequence of pressing/holding/releasing a second time and, depending on the receiver model, even a third time. Programming should now be complete and the garage door, gate or similar should now be activated when the programmed button is depressed.

**If the receiver is still not activated:**

Continue with programming steps 6-8 to complete programming.

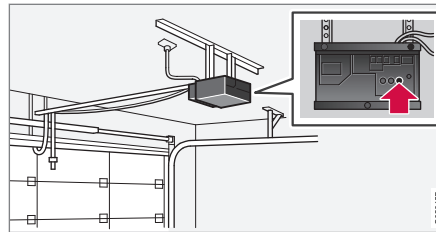

6. Locate programming button<sup>34</sup> on the receiver for the garage door or similar. It is normally located near the antenna bracket on the receiver.
7. Depress and release the receiver's programming button. Step 8 must be completed within 30 seconds of the button being depressed.
8. Depress the button being programmed, **hold it depressed for 2 seconds and then release it.** Repeat the sequence of pressing/holding/releasing a second time and, depending on the receiver model, even a third time. **Programming is now be complete** and the garage door, gate or similar should now be activated when the programmed button is depressed.

**Operation**

When HomeLink® is fully programmed it can be used in place of the separate original remote controls.

Depress the programmed button. The garage door, gate, alarm system or similar is activated (may take a few seconds). The indicator lamp illuminates or flashes when the button has been depressed. Naturally the original remote controls can still be used in parallel with HomeLink® if required.

<p><b>i NOTE</b></p>	<p>If the ignition is switched off, HomeLink® will work for 30 minutes after the driver's door has been opened.</p>
----------------------	---

In the event of programming problems, contact HomeLink® at [www.HomeLink.com](http://www.HomeLink.com), [www.youtube.com/HomeLinkGentex](http://www.youtube.com/HomeLinkGentex) or call the toll-free number 00 8000 466 354 65 (or the toll number +49 6838 907 277).

**Resetting the HomeLink® buttons**

It is only possible to reset all of the HomeLink® buttons at the same time, not each button individually. However, individual buttons can be reprogrammed; see the section "Programming individual buttons" below.

<sup>34</sup> Button designation and colour vary depending on manufacturer.

1. Depress buttons 1 and 3 on HomeLink® and hold them depressed until the indicator lamp begins flashing green (about 10 seconds).
2. Release the buttons.
  - > HomeLink® is now set to "learn mode" and is ready to be reprogrammed; see the section "Programming HomeLink®" above.

### Programming individual buttons

To reprogram an individual HomeLink® button, proceed as follows:

1. Depress the required button and **do not release**.
2. After approx. 20 seconds when the indicator lamp on HomeLink® starts to flash yellow, start with step 1 from the section "Programming HomeLink®" above.

**Note:** If the button to be reprogrammed is not programmed with a new unit, it will resume the previously saved programming.

For more information or to provide feedback about HomeLink®, visit [www.HomeLink.com](http://www.HomeLink.com), [www.youtube.com/HomeLinkGentex](http://www.youtube.com/HomeLinkGentex) or call the toll-free number 00 8000 466 354 65 (or the toll number +49 6838 907 277).

### Related information

- HomeLink®\* (p. 162)

## Trip computer

The car's trip computer records and calculates values such as e.g. distance, fuel consumption and average speed whilst driving.

In order to facilitate fuel-efficient driving, information is recorded about both instantaneous and average fuel consumption. The information from the trip computer can be shown in the driver display.

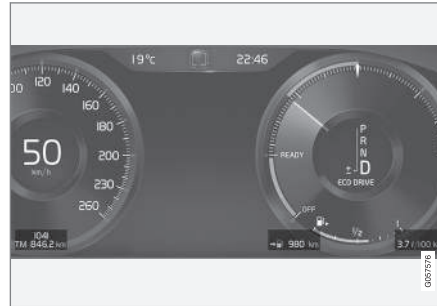

12-inch driver display.

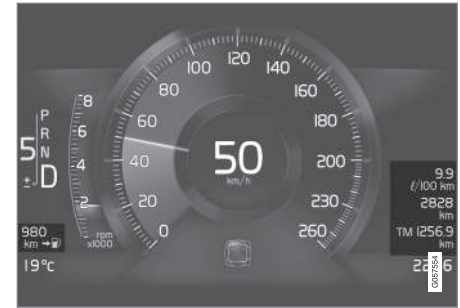

8-inch driver display.

The following meters are included in the trip computer:

- Trip meter
- Odometer
- Instantaneous fuel consumption
- Distance to empty tank
- Tourist - alternative speedometer

### Trip meter

There are two trip meters, TM and TA.

TM can be reset manually and TA is reset automatically if the car is not used for at least four hours.

The following information is registered while driving:



- ◀• Mileage
- Driving time
- Average speed
- Average fuel consumption.

The values apply from the trip meter's latest reset.

### Odometer

The odometer records the car's total mileage. This value cannot be reset to zero.

### Instantaneous fuel consumption

This gauge shows the fuel consumption that the car has at the moment. The value is updated approximately every second.

### Applies to Bi-Fuel\* cars

During gas operation the trip computer shows the equivalent consumption of gas.

### Distance to empty tank

The trip computer calculates the remaining mileage with the fuel available in the tank.

The calculation is based on the average fuel consumption over the last 30 km and the remaining driveable fuel quantity.

No guaranteed range remains when the gauge shows "----". In which case, refuel as soon as possible.

**i NOTE**

There may be a slight deviation if the driving style has been changed.

An economic driving style generally results in a longer driving distance.

### Applies to Bi-Fuel\* cars

**i NOTE**

Display of distance to empty only applies to the petrol tank.

### Tourist - alternative speedometer

The alternative digital speedometer makes it easier to drive in countries where speed limit signs are in a different unit than that shown in the car's instruments.

The digital speed is then shown in the opposite unit to that shown in the analogue speedometer. If the analogue speedometer is graduated in **mph**, the digital speedometer shows the corresponding speed in **km/h** and vice versa.

### Related information

- Show trip data in the driver display (p. 166)
- Show trip statistics in the centre display (p. 168)

## Show trip data in the driver display

The trip computer's recorded and calculated values can be shown in the driver display.

The values are saved in a trip computer app. Via the app menu, you can choose which information is shown on the driver display.

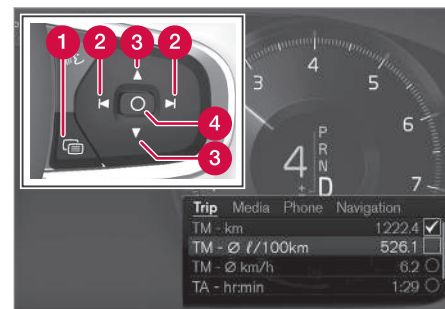

Open and navigate in the app menu<sup>35</sup> using the right-hand steering wheel keypad.

- 1 App menu
- 2 Left/right
- 3 Up/down
- 4 Confirm

<sup>35</sup> The appearance of the display may vary depending on instrument variant.

1. Open the app menu in the driver display by pressing (1).

(It is not possible to open the app menu while there is an unacknowledged message in the driver display. The message must be confirmed before the app menu can be opened.)

2. Navigate to the trip computer app to left or right with (2).
  - > The top four menu rows show measured values for trip meter TM. The next four menu rows show measured values for trip meter TA. Scroll up or down in the list with (3).
3. Scroll down to the option buttons to select which information to show in the driver display:
  - Instantaneous fuel consumption
  - Distance to empty tank
  - Odometer
  - Mileage for trip meter TM, TA, or no display of mileage
  - Tourist (alternative speedometer).

Select or deselect an option with the **O** button (4). The change is made immediately.

### Resetting the trip meter



Reset the trip meter TM with one long press on the **RESET** button on the left-hand stalk switch.

Trip meter TA only has automatic resetting. The meter is reset if the car is not used for four hours or more.

### Change unit

Change the units for mileage, speed, etc. via the centre display as follows:

1. Press **Settings** in the top view.
2. Press **System** → **Units**.
3. Under **Units of Measurement**, select the required unit standard: **Metric**, **Imperial** or **US**.

### **i** NOTE

In addition to in the trip computer, these units are also changed in Volvo's navigation system\*.

### Related information

- Trip computer (p. 165)
- Show trip statistics in the centre display (p. 168)
- Using the application menu in the driver display (p. 106)

## Show trip statistics in the centre display

Trip statistics from the trip computer are displayed graphically in the centre display and provide an overview that facilitates more fuel-efficient driving.

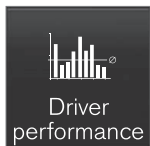

Open the **Driver performance** app in app view in order to show the trip statistics.

Each bar in the diagram symbolises a distance of 1, 10 or 100 km, alternatively miles. The bars are filled in from the right as driving progresses. The bar on the far right shows the value for the current distance.

The average fuel consumption and total driving time are calculated since the last time the trip statistics were reset.

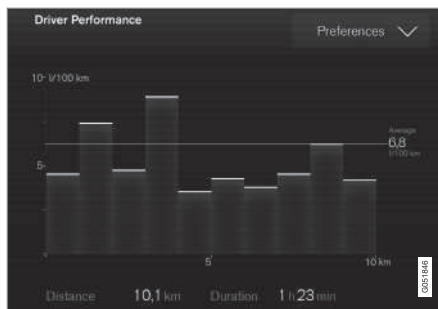

Trip statistics from the trip computer<sup>36</sup>.

### Settings for trip statistics

Press **Preferences** to

- change graph scale. Select resolution 1, 10 or 100 km/miles for the bar.
- reset data after every trip. Performed when the car has been stationary for more than 4 hours.
- reset data for the current trip.

Trip statistics, calculated average consumption and total driving time are always reset simultaneously.

### Change unit

Change the unit for mileage, fuel consumption, etc. via the centre display as follows:

1. Press **Settings** in the top view.
2. Press **System** → **Units**.
3. Under **Units of Measurement**, select the required unit standard: **Metric**, **Imperial** or **US**.

### Related information

- Trip computer (p. 165)
- Show trip data in the driver display (p. 166)

<sup>36</sup> The figure is schematic, the layout may vary depending on selected unit standard or updated software.

## Settings view

Settings and information for many of the car's functions can be managed in the centre display's settings view.

### Opening/closing and navigating in the settings view

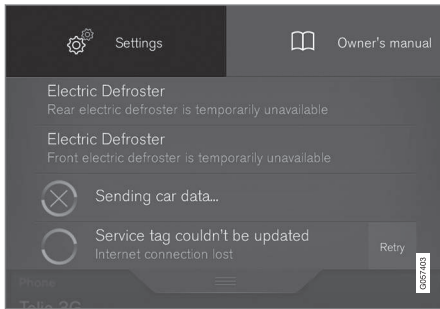

Top view with button for **Settings**.

1. Drag down the tab at the top of the centre display to open the top view.
2. Press **Settings** to open the settings view.
3. Press one of the categories shown and navigate to subcategories and **Settings** by pressing again.
4. Press **Back** to go back in the settings view.  
Press **Close** to close the settings view.

## Changing a setting

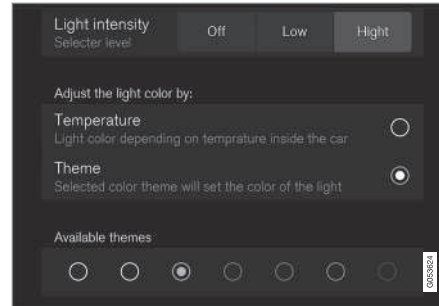

A subcategory in the settings view with different types of settings (here, a multi-selector button and radio buttons).

1. Press on categories and subcategories to navigate to the required setting.
2. Change one or more settings. Different types of settings are changed in different ways (see the table below for a description of each type).  
> The changes are saved immediately.

### Types of settings

There are several different types of settings:

Setting type	Description
Trigger function	Starts an app or separate view for more advanced settings through a press on the text, e.g. to connect a device with Bluetooth.
Radio button	Select a setting from several options by pressing the required radio button, e.g. to select a system language.
Multi-selector button	Select a level for something by pressing the required part of the button, e.g. to select a sensitivity level for City Safety.
Checkbox	Activate/deactivate a function by pressing on the box to select/deselect it, e.g. to select automatic start of seat heating.
Slider	Select a level for something within an interval by pressing and dragging the slider, e.g. to select volume level.
Display of information	No actual setting. Shows information about something, e.g. the car's identification number.

## ◀◀ Related information

- Overview of the centre display (p. 33)
- Categories in the settings view (p. 170)

## Categories in the settings view

The settings view has a number of main categories and subcategories where settings and information for many of the car's functions are collected.

The settings view has 7 main categories: **My Car**, **Sound**, **Navigation**, **Media**, **Communication**, **Climate** and **System**.

In turn, each category contains a number of subcategories and setting options. The tables below show the first level of subcategories. The setting options for a function or area are described in more detail in the corresponding section of the owner's manual. For system settings not described in the corresponding section, see the section "Changing system settings in the settings view".

Some settings are personal, which means that they can be saved to a **Driver Profiles**. Other settings are global, which means they are not linked to a driver profile. The tables below provide an overview showing whether a category's settings are personal, global or a mixture of both.

### My Car

Subcategories	Settings
Displays	Personal
IntelliSafe	Mixed
Park Assist	Global

Subcategories	Settings
Drive Mode/Individual Drive Mode*	Mixed
Lights and Lighting	Mixed
Mirrors and Easy Entry	Personal
Locking	Mixed
Parking Brake and Suspension	Mixed
Seats	Mixed
Wipers	Mixed
Suspension	Global

### Sound

Subcategories	Settings
Sound Experience*	Personal
Tone	Personal
Balance	Personal
System Volumes	Mixed

### Navigation

Subcategories	Settings
Map	Personal
Route and Guidance	Personal



Subcategories	Settings
Traffic	Personal
Guidance	Personal
System	Personal

## Media

Subcategories	Settings
AM/FM radio	Personal
DAB	Personal
Gracenote®	Personal
Video	Personal

## Communication

Subcategories	Settings
Phone	-
Text Messages	-
Bluetooth Devices	-
Wi-Fi	Global
Car Wi-Fi Hotspot	Global
Car Modem Internet	Global

Subcategories	Settings
Volvo On Call	-
Volvo Service Networks	Global

## Climate

The main category **Climate** has no subcategories.

## System

Subcategories	Settings
Driver Profile	Personal
Date and Time	-
System Language	Personal
Keyboard Layouts	Global
Voice Control	Personal
Units	Personal
Storage	-
Software Updates	-
Factory reset	-
Services	-

## Related information

- Settings view (p. 169)
- Changing system settings in the settings view (p. 172)

## Changing system settings in the settings view

The **System** category in the settings view collects general settings and information for car systems, such as language and units.

The system settings under **Driver Profile, Date and Time, Keyboard Layouts, Voice Control, Software Updates, Factory reset, Factory Reset** and **Services** are described in the corresponding section of the owner's manual.

### Changing system language

1. Press **Settings** in the top view in the centre display.
2. Press **System** → **System Language**.
3. Select system language. Languages that support voice recognition have a voice recognition symbol.
  - > The language in the driver display, centre display and head-up display is changed.

### Changing system units

#### Changing length and volume units

1. Press **Settings** in the top view in the centre display.
2. Press **System** → **Units** → **Units of Measurement**.

3. Select from the following unit standards:
  - **Metric** - kilometres, litres and degrees Celsius.
  - **Imperial** - miles, gallons and degrees Celsius.
  - **US** - miles, gallons and degrees Fahrenheit.
  - > The units in the driver display, centre display and head-up display are changed.

### See storage information

1. Press **Settings** in the top view in the centre display.
2. Press **System** → **Storage**.
  - > Storage information for the car's hard disk is shown, including total capacity, available capacity and how much space installed applications are using.

### See the car's vehicle identification number

1. Press **Settings** in the top view in the centre display.
2. Press **System** → **Vehicle Identification Number**.
  - > The car's vehicle identification number (VIN<sup>37</sup>) is shown.

### Related information

- Categories in the settings view (p. 170)
- Driver profiles (p. 173)
- Clock (p. 99)
- Using the keyboard in the centre display (p. 49)
- Settings for voice recognition (p. 117)
- System updates (p. 510)
- Resetting settings in the settings view (p. 173)
- Book service and repair (p. 506)

<sup>37</sup> Vehicle Identification Number.

## Resetting settings in the settings view

It is possible to reset all modified settings in the settings view to their default values at once.

### Types of resets

There are three different types of resets for settings in the settings view:

- **Factory Reset** - clears all data and media and resets all settings to their default values.
- **Reset Car Settings** - resets global settings to their default values.
- **Reset Personal Settings** - clears personal data and resets personal settings to their default values.

## Resetting settings

### **i** NOTE

**Factory reset** is only possible when the car is stationary.

1. Press **Settings** in the top view in the centre display.
2. Press **System** → **Factory reset**.
3. Select the required reset type.
  - > A pop-up window is shown.

4. Press **OK** to confirm the reset.

For **Reset Personal Settings**, the reset must be confirmed by pressing **Reset for the active profile** or **Reset for all profiles**.

> Selected settings are reset.

### Related information

- Changing system settings in the settings view (p. 172)
- Driver profiles (p. 173)
- Resetting user data for change of ownership (p. 178)

## Driver profiles

Many of the settings made in the car can be adapted according to the driver's personal preferences and can be saved in one or more driver profiles.

The personal settings are automatically saved in the active driver profile. Each key can be linked to a driver profile. When the linked key is used, the car is adapted to the settings of that specific driver profile.

### What settings are saved in the driver profiles?

Many of the settings made in the car will be automatically saved in the active driver profile if the profile is not locked; see the section "Editing a driver profile". Settings made in the car are either personal or global. Only personal settings are saved in driver profiles.

Settings that can be saved in a driver profile include, amongst other things, screens, mirrors, front seats, navigation, audio and media system, language and voice control.

Some settings, referred to as global settings, can be changed but are not saved to a specific driver profile. Changes to global settings affect all profiles.

### ◀ **Global settings**

The global settings and parameters are not changed when changing between driver profiles. They remain the same regardless of which driver profile is active.

Keyboard layout settings are an example of global settings. If driver profile X is used to add additional languages to the keyboard, these remain available for use even if driver profile Y is used. The keyboard layout settings are not saved to a specific driver profile - the settings are global.

### **Personal preferences**

If driver profile X was used to e.g. set centre display brightness, driver profile Y is not affected by this setting. It has been saved to driver profile X - the brightness setting is a personal setting.

Refer to the section "Categories in the settings view" for more information on which settings are personal and which are global.

### **Related information**

- Editing a driver profile (p. 175)
- Categories in the settings view (p. 170)
- Selecting driver profile (p. 174)

### **Selecting driver profile**

The last used driver profile is the one selected when the car is unlocked. It is possible to change to another driver profile after the car has been unlocked.

When the centre display has been started, the selected driver profile is shown at the top of the screen. The driver profile last used is the one that will be active next time the car is unlocked. However, if the remote control key has been linked to a driver profile then this is what is selected when the car is started. See "Linking remote control key to driver profile".

There are two options for changing to another driver profile.

Option 1:

1. Tap on the name of the driver profile shown in the top of the centre display when the display has been started.
  - > A list of selectable driver profiles is shown.
2. Select the driver profile required.
3. Press **Confirm**.
  - > The driver profile is selected and the system loads the settings for the new driver profile.

Option 2:

1. Drag down the top view in the centre display.

2. Press **Profile**.

> The same list as for Option 1 is shown.

3. Select the driver profile required.

4. Press **Confirm**.

> The driver profile is selected and the system loads the settings for the new driver profile.

### **Related information**

- Driver profiles (p. 173)
- Editing a driver profile (p. 175)
- Linking remote control key to driver profile (p. 176)

## Editing a driver profile

It is possible to change the name of the different driver profiles used in the car.

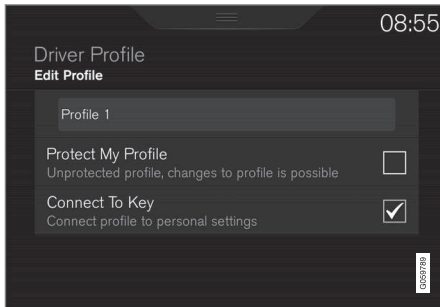

All types of changes to driver profiles are made from the top view in the centre display - **Settings** → **System** → **Driver Profiles**.

### Renaming a driver profile

Rename a driver profile starting from the **Driver Profile** window:

1. Press **Edit Profile**.
  - > A menu opens, where the profile can be edited.
2. Tap in the box **Profile Name**.
  - > A keyboard appears, and it is possible to change the name. Tap on  to close the keyboard.

3. Save the name change by tapping on **Back/Close**.
  - > The name has now been changed.

#### **NOTE**

A profile name cannot start with a space, as the profile name will not then be saved.

### Resetting settings in the driver profiles

Settings that have been saved to one or more driver profiles can be reset if the car is stationary.

#### **NOTE**

**Factory reset** is only possible when the car is stationary.

1. Press **Settings** in the top view.
2. Press **System** → **Factory Reset** → **Reset Personal Settings**.
3. Select one of the options **Reset for the active profile**, **Reset for all profiles** or **Cancel**.

### Related information

- Driver profiles (p. 173)
- Resetting settings in the settings view (p. 173)
- Using the keyboard in the centre display (p. 49)

## Linking remote control key to driver profile

It is possible to link your key to a driver profile. The driver profile along with all of its settings will then be automatically selected every time the car is used with that specific remote control key.

The first time the remote control key is used, it is not linked to any specific driver profile. When the car is started, the **Guest** profile will automatically be activated.

A driver profile can be selected manually without linking it to the key. When the car is unlocked, the last active driver profile is activated. Once the key has been linked to a driver profile, a driver profile does not need to be selected when that specific key is used.

## Linking a remote control key to a driver profile

First select the profile to be linked to the key, if the profile to be linked is not already active. The active profile can then be linked to the key.

1. Press **Settings** in the top view in the centre display.
2. Press **System → Driver Profiles**.
3. Select the desired profile. The **Guest** profile cannot be linked to a key.

4. Drag down the top view and tap on **Settings → System → Driver Profiles → Edit Profile**.
5. Select **Connect key** to link the profile with the key. It is not possible to link a driver profile to a different key than the one currently being used in the car. If there are multiple keys in the car, the message **More than one key is found, put the key you want to connect on backup reader** will be displayed.



Backup reader's location in the tunnel console.

- > When the message **Profile connected to key** is shown, the key and the driver profile are linked.
6. Press **OK**.
    - > This key is now linked to the driver profile and will remain linked as long as the **Connect key** box is not unticked.

## Related information

- Driver profiles (p. 173)
- Editing a driver profile (p. 175)
- Remote control key (p. 234)

## Importing/exporting a driver profile from/to USB

The personal settings saved in the driver profiles can be exported/imported to other cars via USB.

Follow these steps in order to import/export a driver profile from/to a USB memory:

1. Press **Settings** in the top view in the centre display.
2. Press **System** → **Driver Profiles**.



USB socket in tunnel console.

3. Insert a USB memory in the tunnel console.

4. Select **Import profile from USB/Export profile to USB**.

### **i** NOTE

Only one USB memory can remain inserted in the port while profiles are being imported and exported. If there is more than one then there is the risk that the profile is saved to the wrong USB memory or that the car cannot find a profile to import.

### **i** NOTE

A number of profiles can be exported to a USB memory, but only one profile can be imported at a time. When a profile is imported it overwrites the car's current profile. The profile name is also written over.

The guest profile cannot be exported or imported.

5. Select the profile to be imported or the profile(s) to be exported.
  - > The current driver profile is overwritten when a new one is imported.
6. Select **OK**.

If the export fails, it may be due to the following:

- The USB memory is full.
- The USB memory is incorrectly inserted or was pulled out during the export.

If the import fails, it may be due to the following:

- The USB memory is incorrectly inserted or was pulled out during the import.
- There is no driver profile saved on the USB memory.
- The file for the driver profile on the USB memory is corrupt.

### Related information

- Driver profiles (p. 173)

### Changing settings for apps

All of the car's apps are listed in the app view. The app settings that relate to the car's embedded functions can be changed from the centre display's top view.

#### Apps for embedded functions - basic apps

The apps installed in the car from the beginning, e.g. **FM radio** and **USB**, are a part of Sensus and are part of the car's embedded functions. Settings for these apps can be changed directly in the top view in the centre display.

#### Change the settings for a basic app

1. Tap on the app, e.g. **FM radio**.
2. Drag down the top view.
3. Press **FM Radio Settings**.
4. Change settings as desired and confirm the selections.
5. Press either the physical home button or the virtual close button.

Most of the car's basic apps have this contextual setting option, but not all. Refer to the section "Categories in the settings view" for more information on how settings are changed.

#### Third party apps

Third party apps are not included in the car's system from the beginning, but are the type that can be downloaded e.g. **Volvo ID**. Here the settings

are always made inside the app and not from the top view.

#### Related information

- Navigating in the centre display's views (p. 40)
- Settings view (p. 169)
- Downloading, updating and uninstalling apps (p. 468)
- Categories in the settings view (p. 170)

### Resetting user data for change of ownership

In the event of a change of ownership, user data and system settings should be restored to factory settings.

The settings in the car can be reset at different levels. Restore all user data and system settings to the original factory settings in the event of a change of ownership. In the event of a change of ownership it is also important to change the owner of the Volvo On Call\* service.

#### Related information

- Resetting settings in the settings view (p. 173)
- Volvo ID (p. 23)



CLIMATE CONTROL

## Climate control

The car is equipped with electronic climate control. The climate control system cools or heats as well as dehumidifies the air in the passenger compartment.

### 2-zone climate

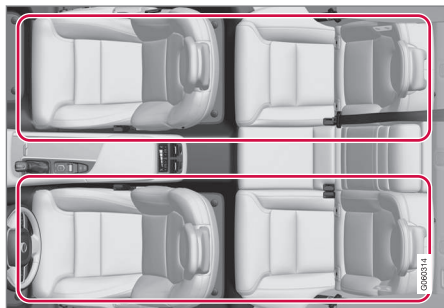

Climate zones with 2-zone climate.

With 2-zone climate, the temperature in the passenger compartment can be set separately for the left and right-hand sides.

All climate control system functions are controlled from the centre display and physical buttons in the centre console.

### 4-zone climate\*

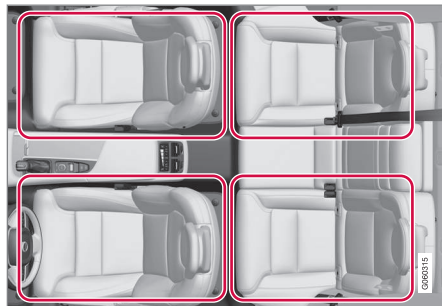

Climate zones with 4-zone climate.

With 4-zone climate the temperature in the passenger compartment can be set separately for the left and right-hand sides in both the front and rear seat.

All climate control system functions are controlled from the centre display and physical buttons in the centre console. The functions for the rear seat can also be controlled from the climate panel at the rear of the tunnel console.

### Related information

- Climate control - sensors (p. 181)
- Perceived temperature (p. 181)
- Air quality (p. 182)
- Climate controls (p. 184)
- Air distribution (p. 195)

- Parking climate\* (p. 204)
- Voice recognition control of climate control (p. 119)

## Climate control - sensors

The climate control system has a number of sensors to help control the climate in the car.

### Sensor location

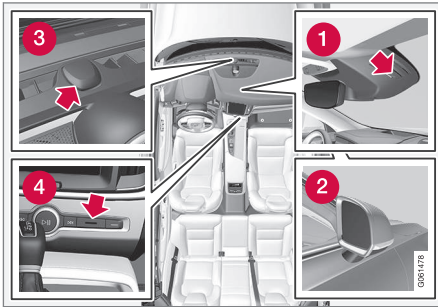

- 1 Moisture sensor - in the casing by the interior rearview mirror.
- 2 Outside temperature sensor - in the right-hand door mirror.
- 3 Sun sensor - on the upper side of the instrument panel.
- 4 Temperature sensor for the passenger compartment - by the physical buttons in the centre console.

#### **i** NOTE

Do not cover or block the sensors with clothing or other objects.

With the Interior Air Quality System\* there is also an air quality sensor that is fitted into the climate control system air intake.

### Related information

- Climate control (p. 180)
- Perceived temperature (p. 181)
- Interior Air Quality System\* (p. 183)

## Perceived temperature

The climate control system regulates the climate in the passenger compartment based on the perceived temperature, not on actual temperature.

The temperature you select in the passenger compartment corresponds to the physically perceived temperature as affected by factors such as the ambient temperature, air speed, humidity, solar radiation, etc. in and around the car at the time.

The system includes a sun sensor which detects on which side the sun is shining into the passenger compartment. This means that the temperature can differ between the right and left-hand side's air vents despite the controls being set for the same temperature on both sides.

### Related information

- Climate control (p. 180)
- Climate control - sensors (p. 181)
- Regulating the temperature (p. 188)

## Air quality

The materials selected for the passenger compartment and the air cleaning system ensure that the air quality in the passenger compartment is high.

### Materials in the passenger compartment

The interior of the passenger compartment is designed to be pleasant and comfortable, even for people with contact allergies and for asthma sufferers.

Tested materials have been developed in order to minimise the quantity of dust in the passenger compartment and to contribute to making the passenger compartment easier to keep clean.

The carpets in both the passenger compartment and the cargo area are removable and easy to remove and clean.

Use cleaning agents and car care products recommended by Volvo to clean the interior.

### Air cleaning system

In addition to the passenger compartment filter, the modifications for Clean Zone Interior Package\* and the air quality system Interior Air Quality System\* also help to maintain high air quality in the passenger compartment.

### Clean Zone\*

The Clean Zone function checks whether or not all conditions have been met for good air quality in the passenger compartment.

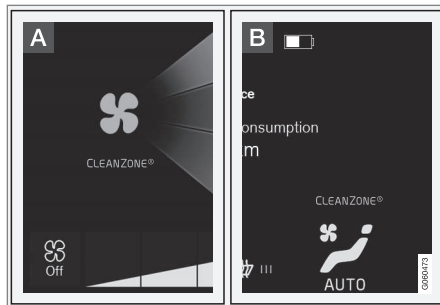

**A** The indicator is visible in the climate view in the centre display.

**B** The indicator is visible in the climate row when the climate view is not open.

If the conditions have not been met then the **Clean Zone** text is white. When all conditions have been met, this is indicated by the text changing colour to blue.

Conditions that are checked:

- That all doors and the tailgate are closed.
- That all side windows and the panorama roof\* are closed.
- That the air quality system Interior Air Quality System\* is activated.

- That the ventilation fan is activated.
- That the air recirculation is deactivated.

#### **i** NOTE

Clean Zone does not indicate that the air quality is good. It only indicates that the conditions for good air quality have been met.

### Related information

- Climate control (p. 180)
- Passenger compartment filter (p. 183)
- Clean Zone Interior Package\* (p. 183)
- Interior Air Quality System\* (p. 183)
- Cleaning the interior (p. 552)
- Climate controls in the centre display (p. 185)

## Passenger compartment filter

All air entering the car's passenger compartment is cleaned with a filter.

### Replacing the passenger compartment filter

To maintain high climate system performance, the filter must be changed at regular intervals. Follow the Volvo Service Programme for the recommended replacement intervals. If the car is used in a severely contaminated environment, it may be necessary to replace the filter more often.

#### **i** NOTE

There are different types of passenger compartment filter. Make sure that the correct filter is fitted.

### Related information

- Air quality (p. 182)
- Clean Zone Interior Package\* (p. 183)
- Interior Air Quality System\* (p. 183)
- Volvo service programme (p. 506)

## Clean Zone Interior Package\*

Clean Zone Interior Package (CZIP) comprises a series of modifications that keep the passenger compartment even clearer from allergy and asthma-inducing substances.

The following is included:

- An enhanced fan function that means that the fan starts when the car is unlocked with the remote control key. The fan fills the passenger compartment with fresh air. The function starts when required and is disengaged automatically after a time or when one of the passenger compartment doors is opened. The amount of time the fan runs is reduced gradually due to reduced need up until the car is 4 years old.
- The fully automatic air quality system Interior Air Quality System (IAQS).

### Related information

- Air quality (p. 182)
- Passenger compartment filter (p. 183)
- Interior Air Quality System\* (p. 183)

## Interior Air Quality System\*

Interior Air Quality System (IAQS) is a fully automatic air quality system that separates gases and particles to reduce the levels of odours and contaminants in the passenger compartment.

IAQS is a part of the Clean Zone Interior Package (CZIP) and cleans the air in the passenger compartment from contaminants such as particles, hydrocarbons, nitrous oxides and ground-level ozone.

If the air quality sensor senses that the outside air is contaminated, the air intake is closed and air recirculation is activated.

#### **i** NOTE

The air quality sensor must always be enabled to ensure the best air in the passenger compartment.

In a cold climate recirculation is limited so as to prevent misting.

In the event of misting, the defrost functions for windscreen, side windows and rear window should be used.

### Activating/deactivating the air quality sensor

It is possible to set whether the air quality sensor should be activated/deactivated.



1. Press **Settings** in the top view in the centre display.
2. Press **Climate**.
3. Select **Air Quality Sensor** to activate/deactivate the air quality sensor.

### Related information

- Air quality (p. 182)
- Passenger compartment filter (p. 183)
- Clean Zone Interior Package\* (p. 183)
- Activating/deactivating air recirculation (p. 194)

## Climate controls

The climate control system's functions are controlled from the centre display, physical buttons in the centre console and the climate panel at the rear of the tunnel console\*.

### Overview of climate controls



- 1 Climate controls in the centre display.
- 2 Defrost buttons in the centre console.
- 3 Climate controls at the rear of the tunnel console\*.

### Related information

- Climate control (p. 180)
- Climate controls in the centre display (p. 185)
- Climate controls at the rear of the tunnel console\* (p. 186)

- Activating/deactivating defrost of windows and door mirrors (p. 192)

## Climate controls in the centre display

All climate functions can be regulated from the climate row and the climate view in the centre display.

### Climate row

The most common climate functions can be regulated from the climate row.

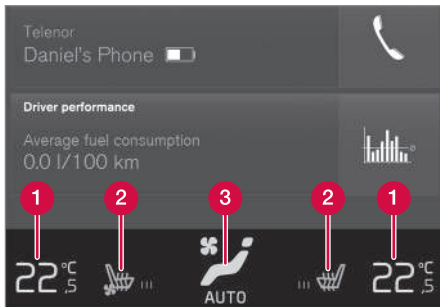

- 1 Temperature controls for driver and passenger side.
- 2 Controls for heated\* and ventilated\* driver and front passenger seat, as well as heated steering wheel\*.
- 3 Button for access to the climate view. The graphic on the button shows activated climate settings.

### Climate view

One tap on the centre button in the climate row gives access to the climate view. The climate view is divided into the tabs **Main climate**, **Rear climate\*** and **Parking climate\***. Change between the tabs by swiping left/right or by pressing the respective heading.

#### Main climate

In addition to the climate row's functions, other main climate functions can also be controlled in the **Main climate** tab.

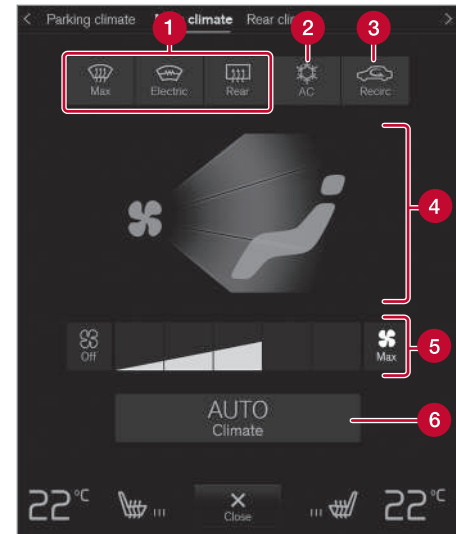

- 1 **Max, Electric, Rear** - Controls for defrosting the windows and door mirrors.
- 2 **AC** - Controls for air conditioning.
- 3 **Recirc** - Controls for air recirculation.
- 4 Controls for air distribution.
- 5 Fan control for front seat (with 2-zone climate, the control is shared with the rear seat).
- 6 **AUTO** - Auto regulating the climate.



#### ◀ Rear climate control\*

All climate functions for the rear seat can be regulated in the **Rear climate** tab.

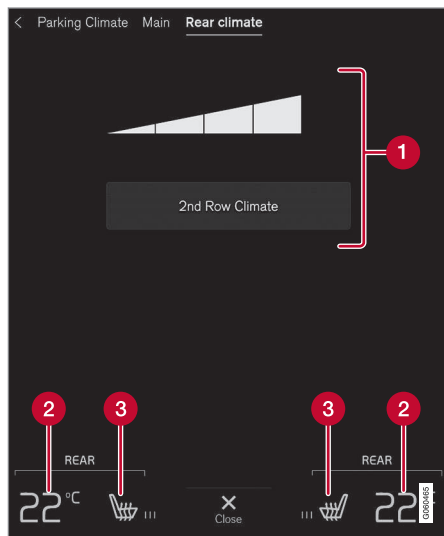

- 1** 2nd row climate - Controls for climate functionality in the rear seat. Fan controls for rear seat.
- 2** Temperature controls for rear seat.
- 3** Controls for heated rear seat\*.

#### Parking climate\*

The car's parking climate control can be regulated in the **Parking climate** tab.

#### Related information

- Climate controls (p. 184)
- Activating/deactivating defrost of windows and door mirrors (p. 192)
- Activating/deactivating air conditioning (p. 188)
- Activating/deactivating air recirculation (p. 194)
- Changing the air distribution (p. 196)
- Regulating the fan level (p. 191)
- Auto-regulating the climate (p. 187)
- Regulating the temperature (p. 188)
- Activating/deactivating heating of the seats\* (p. 201)
- Activating/deactivating ventilation of the seats\* (p. 202)
- Activating/deactivating heating of steering wheel\* (p. 203)
- Parking climate\* (p. 204)

#### Climate controls at the rear of the tunnel console\*

The rear seat's climate functions are controlled from the climate panel at the rear of the tunnel console.

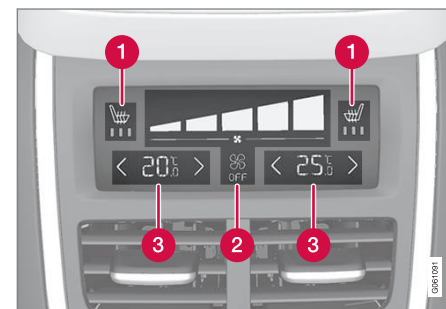

- 1** Controls for heated rear seat\*.
- 2** Fan controls for rear seat.
- 3** Temperature controls for rear seat.

If the car is not equipped with a climate panel at the rear of the tunnel console, but has heated rear seats\*, there are physical buttons at the rear of the tunnel console for controlling these.

#### Related information

- Climate controls (p. 184)
- Activating/deactivating heating of the seats\* (p. 201)



- Regulating the fan level (p. 191)
- Regulating the temperature (p. 188)

### Auto-regulating the climate

With an auto-regulated climate, several climate functions are controlled automatically by the climate control system.

Auto-regulation automatically controls the air recirculation, air conditioning and air distribution.



Auto-regulation button in the climate view.

1. Open the climate view in the centre display.

2. Give a short or long press on **AUTO**.

Temperature and fan level are changed depending on whether a short or long press is given:

- Short press - resets to previous settings for auto-regulated climate control.
  - Long press - changes to default settings: 22 °C/72 °F and level **3** (level **2** in the rear seat<sup>1</sup>).
- > Auto-regulation of the climate is activated/deactivated and the button illuminates/extinguishes.

### Related information

- Climate controls in the centre display (p. 185)

<sup>1</sup> For cars with 4-zone climate\*.

## Activating/deactivating air conditioning

The air conditioning cools and dehumidifies incoming air as required.

## Activating/deactivating the main air conditioning

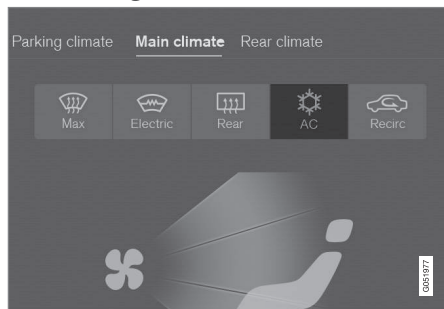

The air conditioning button in the climate view.

1. Open the climate view in the centre display.
2. Press **AC**.
  - > The air conditioning is activated/deactivated and the button illuminates/extinguishes.

When the air conditioning is activated, the climate control system automatically controls starting and switching off as required.

**NOTE**

Close all side windows and the panorama roof\* for air conditioning to work optimally.

**NOTE**

It is not possible to activate the air conditioning when the fan control is in **Off** position.

### Related information

- Climate controls in the centre display (p. 185)

## Regulating the temperature

The temperature can be set separately for the left and right-hand sides. With 4-zone climate\* the temperature can also be set separately for the front and rear seats.

### Regulating temperature for front seat<sup>2</sup>



Temperature buttons in the climate row.

1. Press the left or right-hand side temperature button in the centre display's climate row to open the controls.

<sup>2</sup> For 2-zone climate, also rear seat.

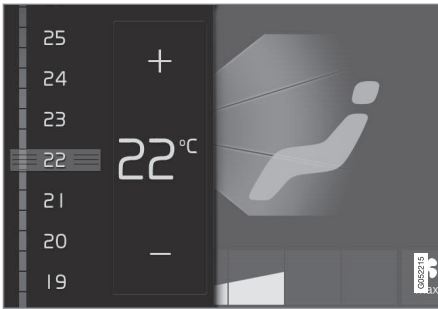

Temperature control.

2. Regulate the temperature by either of the following:
  - drag the control to the desired temperature, or
  - press +/– to raise/lower the temperature gradually.
- > The temperature changes and the button shows the set temperature.

### Synchronising the temperature

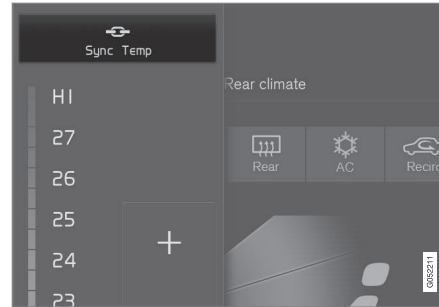

Synchronisation button on the driver's side temperature controls.

1. Press the driver's side temperature button in the centre display's climate row in order to open the controls.
2. Press **Synchronise temperature**.
  - > The temperature for all zones in the car is synchronised with the temperature set for the driver's side and the synchronisation symbol is shown adjacent to the temperature button.

Synchronisation is stopped by a further press on **Synchronise temperature** or by changing the passenger side or rear seat\* temperature settings.

### Regulating temperature for rear seat\*

#### From the front seat

Temperature buttons in the **Rear climate** tab in the climate view.

1. Open the climate view in the centre display and select the tab for **Rear climate**.
2. Press the left or right-hand side temperature button to open the control.



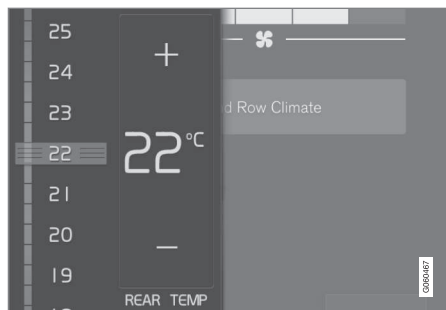

Temperature control.

3. Regulate the temperature by means of the following:
  - drag the control to the desired temperature
  - press +/- to raise/lower the temperature gradually.
  - > The temperature changes and the button shows the set temperature.

### From the rear seat



Temperature control on the climate panel at the rear of the tunnel console.

- Press the left or right-hand side </> buttons on the tunnel console's climate panel in order to lower/raise the temperature gradually.
  - > The temperature changes and the screen in the climate panel shows the set temperature.

#### **i** NOTE

Heating or cooling cannot be hastened by selecting a higher or lower temperature than the actual desired temperature.

### Related information

- Climate controls (p. 184)
- Climate controls in the centre display (p. 185)
- Climate controls at the rear of the tunnel console\* (p. 186)
- Perceived temperature (p. 181)

## Regulating the fan level

The fan can be set to five different automatic fan levels as well as **Off** and **Max**. With 4-zone climate\* the fan level can be set separately for the front and rear seats.

### Regulating fan level for front seat<sup>3</sup>

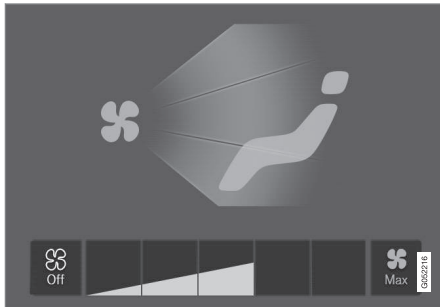

Fan control buttons in the climate view.

1. Open the climate view in the centre display.
2. Tap on the desired fan level, **Off**, **1-5** or **Max**.
  - > Fan level is changed and the buttons for the selected level illuminate.

### ! IMPORTANT

If the fan is fully switched off then the air conditioning is not engaged, which results in a risk of misting on the insides of the windows.

<sup>3</sup> For 2-zone climate, also rear seat.

## Regulating fan level for rear seat\*

### From the front seat

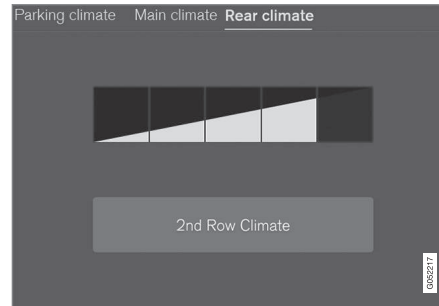

The fan control buttons in the tab **Rear climate** in the climate view.

1. Open the climate view in the centre display and select the tab for **Rear climate**.
2. Tap on the desired fan level, **1-5**.

The rear seat's fan level can be switched off by tapping on **2nd row climate**.

- > Fan level is changed and the buttons for the selected level illuminate.

### From the rear seat



Fan controls on the climate panel at the rear of the tunnel console.

- Press the desired fan level, **Off** or **1-5** on the tunnel console climate panel.
  - > Fan level is changed and the buttons for the selected level illuminate.

### i NOTE

The fan level for the rear seat cannot be set if the fan level for the front seat is in position **Off**.

**NOTE**

The climate control system automatically adjusts the air flow within the selected fan level based on requirements. This means that the fan speed may change even though the fan level is the same.

**Related information**

- Climate controls in the centre display (p. 185)
- Climate controls at the rear of the tunnel console\* (p. 186)

**Activating/deactivating defrost of windows and door mirrors**

The three functions max defroster, heated windscreen\*, and heated rear window and door mirrors are used to quickly remove misting and ice from the windows and door mirrors.

**From physical buttons in the centre console**

The centre console contains physical buttons for quick access to the defrost functions.

With heated windscreen\* the max defroster can only be activated individually from the climate view in the centre display.

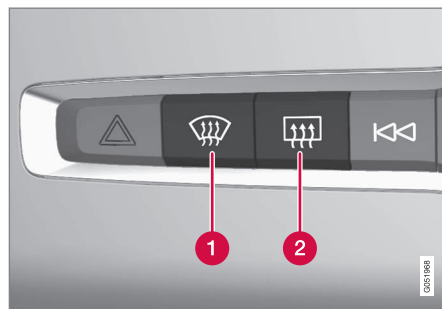

Physical buttons in the centre console.

- 1 Button for heated windscreen\* and max defroster.
- 2 Button for heated rear window and door mirrors.

Cars without heated windscreen:

- Press the button (1).
  - > Max defroster is activated/deactivated and the button illuminates/extinguishes.

Cars with heated windscreen:

- Press the button (1) repeatedly in order to switch between the three levels:
  - Activated heated windscreen
  - Activated heated windscreen and max defroster
  - Deactivated.
- > Heated windscreen and max defroster are activated/deactivated and the button illuminates/extinguishes.

**NOTE**

Max defroster starts with a certain delay in order to avoid a short increase in fan level if the heated windscreen is deactivated by two quick presses of the button.

Rear window and door mirror defrosters:

- Press the button (2).
  - > Heated rear window and door mirrors are activated/deactivated and the button illuminates/extinguishes.

## From the climate view in the centre display

### Activating/deactivating max defroster

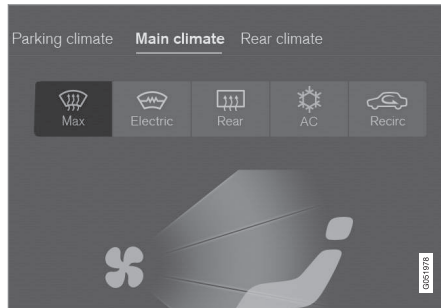

Max defroster button in the climate view.

1. Open the climate view in the centre display.
2. Press **Max**.

- > Max defroster is activated/deactivated and the button illuminates/extinguishes.

Max defroster deactivates auto-regulation of the climate and air recirculation, activates air conditioning and changes the fan level to **5** and the temperature to **HI**.

When max defroster is deactivated, the climate control system returns to the previous settings.

#### **i** NOTE

Changing the fan level to **5** increases the noise level.

### Activating/deactivating heated windscreen\*

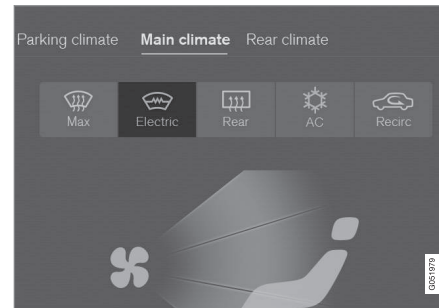

The button for heated windscreen in the climate view.

1. Open the climate view in the centre display.
2. Press **Electric**.
  - > Heated windscreen is activated/deactivated and the button illuminates/extinguishes.

#### **i** NOTE

A triangular area at the end of each side of the windscreen is not electrically heated, where de-icing may take longer.

#### **i** NOTE

The heated windscreen may affect the performance of transponders and other communication equipment.

#### **i** NOTE

If the heated windscreen is activated when the Start/Stop function has auto-stopped the engine then the engine will be restarted.



### ◀◀ **Activating/deactivating heated rear window and door mirrors**

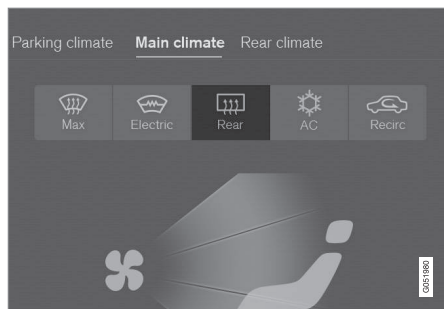

The button for heated rear window and door mirrors in the climate view.

1. Open the climate view in the centre display.
2. Press **Rear**.
  - > Heated rear window and door mirrors are activated/deactivated and the button illuminates/extinguishes.

### **Activating/deactivating automatic start of heated windows**

It is possible to set whether automatic start of heated windscreen\* and heated rear window and door mirrors should be activated/deactivated when the engine is started. With automatic start activated, heating will start when there is a risk of ice or misting on the windscreen/window. The heating switches off automatically when the

windscreen/window is sufficiently warm and the ice or misting is gone.

1. Press **Settings** in the top view in the centre display.
2. Press **Climate**.
3. Select **Auto Front Defroster** to activate/deactivate automatic start of heated windscreen.

Select **Auto Rear Defroster** to activate/deactivate automatic start of heated rear window and door mirrors.

### **Related information**

- Climate controls (p. 184)
- Climate controls in the centre display (p. 185)

### **Activating/deactivating air recirculation**

The air recirculation shuts out bad air, exhaust fumes, etc. from the passenger compartment, by means of no outside air being drawn into the car.

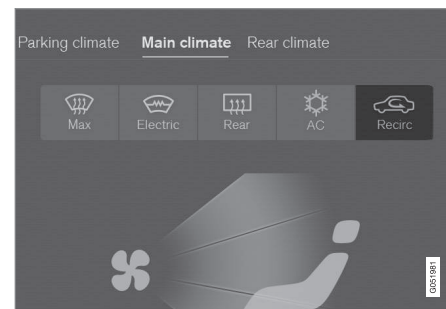

The air recirculation button in the climate view.

1. Open the climate view in the centre display.
2. Press **Recirc**.
  - > Air recirculation is activated/deactivated and the button illuminates/extinguishes.

### **! IMPORTANT**

If the air in the car is recirculated for too long then there is a risk of misting on the insides of the windows.



**i NOTE**

It is not possible to activate air recirculation when max defroster is activated.

**Activating/deactivating the timer for air recirculation**

It is possible set whether the air recirculation timer should be activated/deactivated. When the timer is activated, air recirculation is automatically switched off after 20 minutes.

1. Press **Settings** in the top view in the centre display.
2. Press **Climate**.
3. Select **Recirculation Timer** to activate/deactivate the air recirculation timer.

**Related information**

- Climate controls in the centre display (p. 185)

**Air distribution**

The climate control system distributes the incoming air via a number of different vents in the passenger compartment.

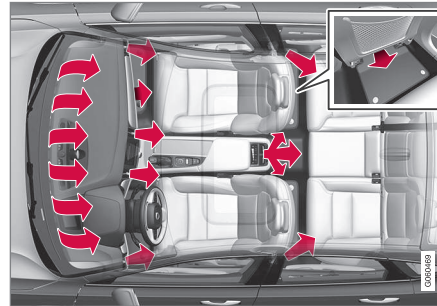
**Overview of air distribution**

Air distribution in the passenger compartment with 4-zone climate.

**Automatic and manual air distribution**

With auto-regulated climate running the air distribution takes place automatically. If necessary, the air distribution can be controlled manually.

**Adjustable air vents**

There are 6 or 8\* adjustable air vents in the passenger compartment depending on the climate control system.

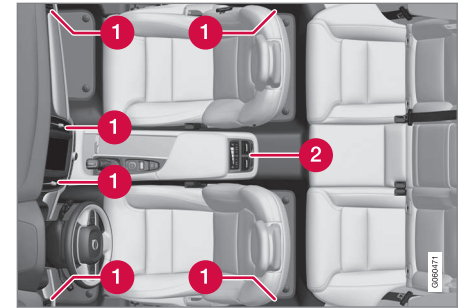

Location of adjustable air vents in the passenger compartment.

- 1 With 2-zone climate - four on the instrument panel and one on each of the door pillars between the front and rear doors.
- 2 Addition with 4-zone climate\* - two at the rear of the tunnel console.

**i NOTE**

Remember that small children may be sensitive to air flows and draughts.

**Related information**

- Climate control (p. 180)
- Changing the air distribution (p. 196)
- Opening/closing and aiming the air vents (p. 197)



## CLIMATE CONTROL

- Table of air distribution options (p. 199)
- Auto-regulating the climate (p. 187)

### Changing the air distribution

The air distribution can be changed manually if required.

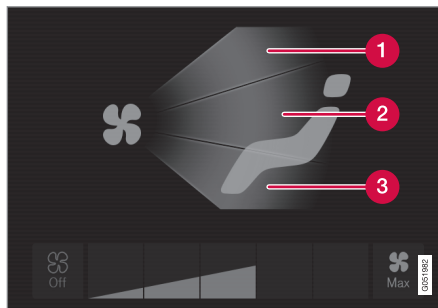

The air distribution buttons in the climate view.

- ❶ Air distribution - windscreen defroster vents
- ❷ Air distribution - air vents in instrument panel and centre console
- ❸ Air distribution - air vents in the floor

1. Open the climate view in the centre display.
2. Press one or more of the air distribution buttons in order to open/close the corresponding air flow.
  - > The air distribution is changed and the buttons illuminate/extinguish.

### Related information

- Air distribution (p. 195)
- Opening/closing and aiming the air vents (p. 197)
- Table of air distribution options (p. 199)
- Climate controls in the centre display (p. 185)

## Opening/closing and aiming the air vents

Some air vents in the passenger compartment can be opened, closed and aimed individually.

If the door pillar vents and instrument panel outer vents are aimed toward the side windows, then misting can be removed.

If the door pillar vents are aimed inwards then, in a hot climate, a comfortable environment is obtained in the passenger compartment.

## Opening/closing the air vents

Air vents for the front seat:

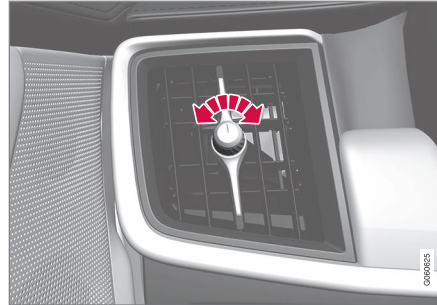

Air vent knob<sup>4</sup>.

- Turn the knob in order to open/close the air flow from the vent.  
The air flow is at maximum when the marking on the knob is in vertical position.

Air vents for the rear seat:



The air vent's thumbwheel<sup>4</sup>.

- Roll the thumbwheel in order to open/close the air flow from the nozzle.  
The longer the white lines on the thumbwheel that are visible, the higher the air flow.

<sup>4</sup> The illustration is schematic - nozzle design varies depending on location.

◀◀ **Aiming the air vents**

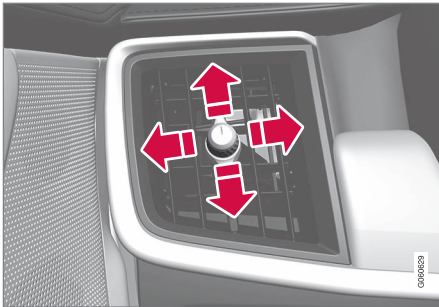

The air vent's lever<sup>4</sup>.

- Move the lever sideways/vertically in order to aim the air flow from the nozzle.

**Related information**





- Air distribution (p. 195)
- Changing the air distribution (p. 196)
- Table of air distribution options (p. 199)

---

<sup>4</sup> The illustration is schematic - nozzle design varies depending on location.





## Table of air distribution options

The air distribution can be changed manually if required. The following options are available for setting.

	Air distribution	Purpose
	<p>If all air distribution buttons are deselected in manual mode, the climate control system returns to automatically regulated climate control.</p>	
	<p>Main air flow from the defroster vents. Some air flows from other air vents.</p>	<p>Counteracts misting and icing in a cold and humid climate (to achieve this, fan level must not be low).</p>
	<p>Main air flow from the air vents in the instrument panel. Some air flows from other air vents.</p>	<p>Provides efficient cooling in a hot climate.</p>
	<p>Main air flow from the air vents at the floor. Some air flows from other air vents.</p>	<p>Provides heat or cooling to the floor.</p>





	Air distribution	Purpose
	<p>Main air from the defroster vents and air vents in the instrument panel. Some air flows from other air vents.</p>	<p>Provides good comfort in hot and dry climates.</p>
	<p>Main air flow from the defroster vents and air vents at the floor. Some air flows from other air vents.</p>	<p>Provides good comfort and good demisting in a cold or humid climate.</p>
	<p>Main air flow from the air vents in the instrument panel and air vents at the floor. Some air flows from other air vents.</p>	<p>Provides good comfort in sunny weather with cool outdoor temperatures.</p>
	<p>Main air flow from the defroster vents, from the air vents in the instrument panel and air vents at the floor.</p>	<p>Gives balanced comfort in the passenger compartment.</p>

**Related information**

- Air distribution (p. 195)
- Changing the air distribution (p. 196)
- Opening/closing and aiming the air vents (p. 197)
- Climate controls in the centre display (p. 185)

## Activating/deactivating heating of the seats\*

The seats can be heated in order to increase comfort for driver and passengers when it is cold.

### Activating/deactivating heating of the front seat\*



Steering wheel and seat buttons in the climate row.

1. Press the left or right-hand side's steering wheel and seat button in the climate row in order to open the controls for seat and steering wheel.

If the car is not equipped with ventilated seats or heated steering wheel, the button for heated seats is immediately available in the climate row.

2. Repeatedly press the button for heated seats in order to change between the four levels: **Off, High, Medium** and **Low**.
  - > The level changes and the button shows the set level.

### Activating/deactivating heating of the rear seat\*

#### From the front seat\*



Buttons for heated seats in the group **Rear climate** in the climate view.

1. Open the climate view in the centre display and select the tab for **Rear climate**.
2. Repeatedly press the button for heated seats in order to change between the four levels: **Off, High, Medium** and **Low**.
  - > The level changes and the button shows the set level.

#### From the rear seat

With 2-zone climate:

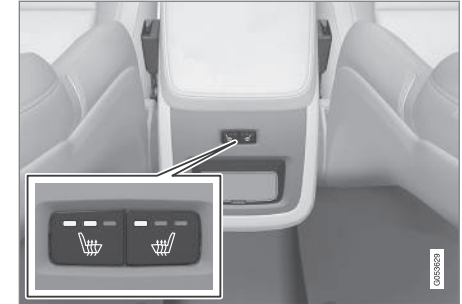

Buttons for heated seats at the rear of the tunnel console.

- Press repeatedly on the left or right-hand side's physical buttons for heated seats at the rear of the tunnel console to switch between the four levels: **Off, High, Medium** and **Low**.
  - > The level changes and the LEDs in the button show the set level.

With 4-zone climate\*:



Seat heating indication and controls on the climate panel at the rear of the tunnel console.

- Press repeatedly on the left or right-hand side's buttons for heated seats on the tunnel console's climate panel to switch between the four levels: **Off**, **High**, **Medium** and **Low**.
  - > The level changes and the screen in the climate panel shows the set level.

### **WARNING**

Heated seats must not be used by people who find it difficult to perceive an increase in temperature due to a lack of sensation or who otherwise have problems operating the controls for the heated seats. Otherwise they may suffer burn injuries.

### Activating/deactivating automatic start of heated seats

It is possible to set whether automatic start of heated seats should be activated/deactivated when the engine is started. With automatic start activated, heating will start in the event of low ambient temperature.

1. Press **Settings** in the top view in the centre display.
2. Press **Climate**.
3. Under **Auto Driver Seat Heating Level** and **Auto Passenger Seat Heating Level**, select **Off**, **Low**, **Medium** or **High** in order to activate/deactivate the automatic starting of the heating for the driver and passenger seats and to select the level.

### Related information

- Climate controls (p. 184)
- Climate controls in the centre display (p. 185)
- Climate controls at the rear of the tunnel console\* (p. 186)

### Activating/deactivating ventilation of the seats\*

The seats can be ventilated, for example, to remove moisture from clothes.

The ventilation system consists of fans in the seats and backrests that draw air through the seat upholstery. The cooling effect increases the cooler the passenger compartment air becomes. The system can be activated when the engine is running and takes seat temperature, solar radiation and outside temperature into consideration.



### Activating/deactivating ventilation of the front seat\*

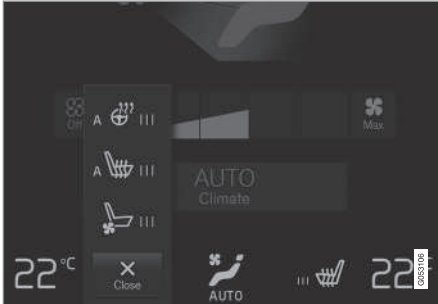

Steering wheel and seat buttons in the climate row.

1. Press the left or right-hand side's steering wheel and seat button in the climate row in the centre display in order to open the controls for seat and steering wheel.

If the car is not equipped with heated seats or heated steering wheel, the button for ventilated seats is immediately available in the climate row.

2. Repeatedly press the button for ventilated seats in order to change between the four levels: **Off**, **High**, **Medium** and **Low**.
  - > The level changes and the button shows the set level.

#### **i** NOTE

The seat ventilation should be used carefully by people sensitive to draughts. Level **Low** is recommended for long-term use.

#### **i** IMPORTANT

Seat ventilation cannot be started if the passenger compartment temperature is too low. This is in order to avoid cooling down the person sitting in the seat.

#### Related information

- Climate controls (p. 184)
- Climate controls in the centre display (p. 185)

### Activating/deactivating heating of steering wheel\*

The steering wheel can be heated in order to increase comfort for the driver when it is cold.

### Activating/deactivating heating of steering wheel



Steering wheel and seat buttons in the climate row.

1. Press the driver's side steering wheel and seat button in the climate row of the centre display in order to open the controls for seat and steering wheel.

If the car is not equipped with heated seats or ventilated seats, the button for heated steering wheel is immediately available in the climate row.



2. Repeatedly press the button for heated steering wheel in order to change between the four levels: **Off**, **High**, **Medium** and **Low**.
- > The level changes and the button shows the set level.

### Activating/deactivating automatic start of heated steering wheel

It is possible to set whether automatic start of heated steering wheel should be activated/deactivated when the engine is started. With automatic start activated, heating will start in the event of low ambient temperature.

1. Press **Settings** in the top view in the centre display.
2. Press **Climate**.
3. Under **Auto Steering Wheel Heating Level**, select **Off**, **Low**, **Medium** or **High** in order to activate/deactivate the automatic starting of steering wheel heating and to select the level.

### Related information

- Climate controls (p. 184)
- Climate controls in the centre display (p. 185)
- Steering wheel (p. 131)

### Parking climate\*

The climate of the car's passenger compartment can be preconditioned or maintained while the car is parked.

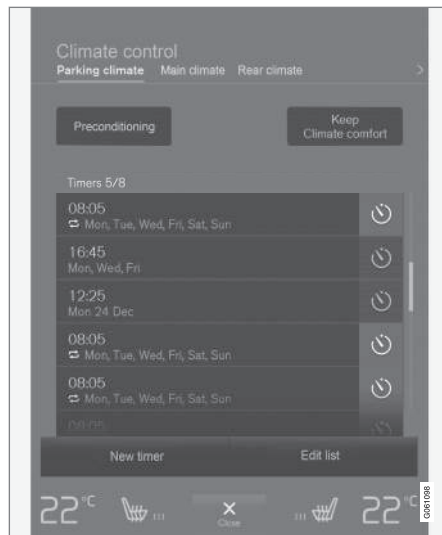

Preconditioning and climate comfort retention are controlled from the **Parking climate** tab in the centre display's climate view.

### Preconditioning

Preconditioning of the car before driving reduces wear and energy needs during a journey.

Preconditioning can use direct start or be set via the timer.

The function utilises several systems in different cases:

- The parking heater\*, in a cold climate, warms up both the passenger compartment and the engine.
- The ventilation, in a hot climate, cools the passenger compartment to the current outer temperature.

### NOTE

During preconditioning of the passenger compartment, the car works to reach comfort temperature and not the temperature set in the climate control system.

### Climate comfort retention

The climate in the car's passenger compartment can be maintained while the car is parked, e.g. if the engine needs to be switched off but the driver or passenger(s) wants to remain in the car and maintain the level of climate comfort.

Starting climate comfort retention is only possible via direct start.

The function utilises several systems in different cases:

- Residual heat from the engine, in a cold climate, heats the passenger compartment to comfort temperature.
- The ventilation, in a hot climate, cools the passenger compartment to the current outer temperature.

### **i** NOTE

Climate comfort retention is switched off when the car is locked from the outside to avoid using residual heat unnecessarily. Use of the function is intended to maintain climate comfort when driver or passengers remain inside the car.

### Related information

- Climate control (p. 180)
- Starting/stopping preconditioning\* (p. 205)
- Timer for preconditioning\* (p. 206)
- Starting/switching off climate comfort retention\* (p. 208)
- Symbols and messages for parking climate control\* (p. 210)
- Heater\* (p. 211)
- Parking heater\* (p. 212)

### Starting/stopping preconditioning\*

Preconditioning warms the passenger compartment and engine or airs the passenger compartment before driving. The function can use direct start from the centre display or a mobile phone.

### Starting/stopping from the centre display



Preconditioning button in the **Parking climate** tab in the climate view.

1. Open the climate view in the centre display.
2. Select the **Parking climate** tab.
3. Press **Preconditioning**.
  - > Preconditioning is started/switched off and the button is illuminated/extinguished.

### **i** NOTE

The car's doors and windows should be closed during the preconditioning of the passenger compartment.

### **⚠** WARNING

Do not use preconditioning if the car is equipped with a heater\*:

- In unventilated spaces indoors. Exhaust gases are emitted if the heater starts.
- In locations with combustible or flammable material nearby. Fuel, gas, long grass, sawdust, etc. may ignite.
- When there is a risk that the heater's exhaust line may be blocked. For example, deep snow inside the front right-hand wheel housing can obstruct the heater's ventilation.

Remember that the preconditioning can be started by a timer that has been set for a long time in advance.

### Starting from the app\*

Start of preconditioning and information about the selected settings can be managed from a device that has the Volvo On Call\* app. The preconditioning warms the passenger compartment to the comfort temperature or airs it to the current outer temperature.



- ◀◀ To be able to also cool the passenger compartment to the comfort temperature (with the car's air conditioning) the engine remote start function Engine Remote Start - ERS<sup>5</sup> via the Volvo On Call\* app. can be used.

### Related information

- Parking climate\* (p. 204)
- Timer for preconditioning\* (p. 206)
- Starting/switching off climate comfort retention\* (p. 208)
- Symbols and messages for parking climate control\* (p. 210)
- Heater\* (p. 211)

### Timer for preconditioning\*

The timer can be set so that the preconditioning is finished at a predetermined time.

The timer can handle up to 8 different settings for:

- A time on a single date
- A time on one or more days of the week, with or without repetition.

### Related information

- Parking climate\* (p. 204)
- Setting the timer for preconditioning\* (p. 206)
- Activating/deactivating the timer for preconditioning\* (p. 208)
- Starting/stopping preconditioning\* (p. 205)
- Symbols and messages for parking climate control\* (p. 210)

### Setting the timer for preconditioning\*

The timer for preconditioning can manage up to 8 time settings.

### Adding a time setting

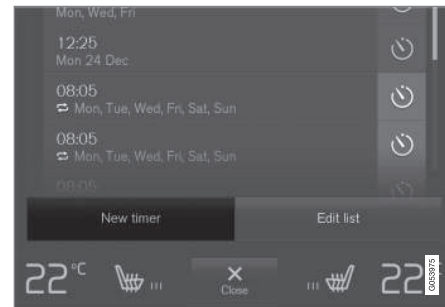

The button to add a time setting in the **Parking climate** tab in the climate view.

1. Open the climate view in the centre display.
2. Select the **Parking climate** tab.

<sup>5</sup> Certain car models and markets.

- Press **Add timer**.  
> A pop-up window is shown.

### **i** NOTE

It is not possible to add a time setting if there already are 8 settings entered for the timer. Delete a time setting in order to be able to add a new one.

- Tap on **Date** to set the time for a single date.  
Tap on **Days** to set the time for one or more days of the week.  
**With Days:** Activate/deactivate repetition by ticking/unticking the box for **Repeat weekly**.
- With **Date:** Select the date for preconditioning by scrolling the date list with the arrows.  
**With Days:** Select the days of the week for preconditioning by tapping on the buttons for the days of the week.
- Set the time when the preconditioning should be finished by scrolling with the arrows.
- Tap on **Confirm** in order to add the time setting.  
> The time setting is added to the list and is activated.

### **!** WARNING

Do not use preconditioning if the car is equipped with a heater\*:

- In unventilated spaces indoors. Exhaust gases are emitted if the heater starts.
- In locations with combustible or flammable material nearby. Fuel, gas, long grass, sawdust, etc. may ignite.
- When there is a risk that the heater's exhaust line may be blocked. For example, deep snow inside the front right-hand wheel housing can obstruct the heater's ventilation.

Remember that the preconditioning can be started by a timer that has been set for a long time in advance.

### Editing a time setting

- Open the climate view in the centre display.
- Select the **Parking climate** tab.
- Press the time setting that is to be changed.  
> A pop-up window is shown.
- Edit the time setting in the same way as described in "Adding a time setting" above.

### Deleting a time setting

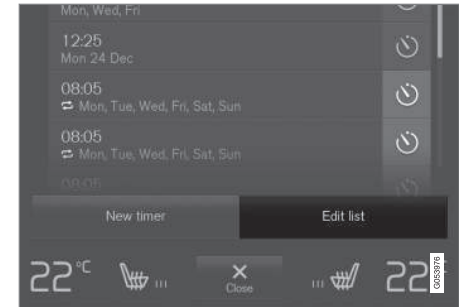

The button for editing the list/deleting the time setting in the tab **Parking climate** in the climate view.

- Open the climate view in the centre display.
- Select the **Parking climate** tab.
- Press **Edit list**.
- Press the delete icon to the right in the list.  
> The icon changes to the text **Delete**.
- Press **Delete** to confirm.  
> The time setting is removed from the list.

### Related information

- Timer for preconditioning\* (p. 206)
- Activating/deactivating the timer for preconditioning\* (p. 208)
- Heater\* (p. 211)

## Activating/deactivating the timer for preconditioning\*

A time setting in the timer for preconditioning can be activated or deactivated based on need.



The timer buttons in the **Parking climate** tab in the climate view.

1. Open the climate view in the centre display.
2. Select the **Parking climate** tab.
3. Activate/deactivate a time setting by tapping on the timer button to the right of the setting.
  - > The time setting is activated/deactivated and the button illuminates/extinguishes.

## ⚠ WARNING

Do not use preconditioning if the car is equipped with a heater\*:

- In unventilated spaces indoors. Exhaust gases are emitted if the heater starts.
- In locations with combustible or flammable material nearby. Fuel, gas, long grass, sawdust, etc. may ignite.
- When there is a risk that the heater's exhaust line may be blocked. For example, deep snow inside the front right-hand wheel housing can obstruct the heater's ventilation.

Remember that the preconditioning can be started by a timer that has been set for a long time in advance.

## Related information

- Timer for preconditioning\* (p. 206)
- Setting the timer for preconditioning\* (p. 206)
- Heater\* (p. 211)

## Starting/switching off climate comfort retention\*

Climate comfort retention maintains the climate in the passenger compartment after driving. The function can use direct start from the centre display.



Button for climate comfort retention in the **Parking climate** tab in the climate view.

1. Open the climate view in the centre display.
2. Select the **Parking climate** tab.
3. Press **Keep climate comfort**.
  - > Climate comfort retention is started/switched off and the button illuminates/extinguishes.

**i NOTE**

It is not possible to start climate comfort retention if there is not enough residual heat in the engine to maintain the passenger compartment climate, or if the outside temperature is above approx. 20 °C.

**i NOTE**

Climate comfort retention is switched off when the car is locked from the outside to avoid using residual heat unnecessarily. Use of the function is intended to maintain climate comfort when driver or passengers remain inside the car.

**Related information**





- Parking climate\* (p. 204)
- Starting/stopping preconditioning\* (p. 205)

## Symbols and messages for parking climate control\*

A number of symbols and messages regarding parking climate control can be shown in the driver display.



This symbol illuminates in the driver display when the parking heater is active.

Symbol	Message	Specification
	Parking climate Service required	Parking climate control is disengaged. Contact a workshop <sup>A</sup> to check the function as soon as possible.
	Parking climate Temporarily unavailable	Parking climate control is temporarily disengaged. If the problem persists for some time, contact a workshop <sup>A</sup> to check the function.
	Parking climate Unavailable Fuel level too low	Parking climate control cannot be activated when the fuel level is too low to start the parking heater*. Filling the vehicle's normal fuel tank.
	Parking climate Unavailable Charge level too low	Parking climate control cannot be activated if the charge level of the starter battery is too low to start the parking heater*. Charging the battery.

<sup>A</sup> An authorised Volvo workshop is recommended.

### Related information

- Parking climate\* (p. 204)
- Starting/stopping preconditioning\* (p. 205)
- Starting/switching off climate comfort retention\* (p. 208)
- Timer for preconditioning\* (p. 206)
- Heater\* (p. 211)
- Managing messages in the driver display and the centre display (p. 109)



## Heater\*

The heater helps the engine and passenger compartment reach the correct temperature before and during driving.

The heater has two subfunctions:

- Parking heater - heats the engine and passenger compartment, if necessary, when the parking climate control's preconditioning\* is activated.
- Additional heater - heats the passenger compartment and engine, if necessary, during driving.

The heater is fuel-driven and is fitted in the front right-hand wheel housing.



This symbol illuminates in the driver display when the heater is active.

### **i** NOTE

When the heater is running, smoke may be emitted from the right-hand front wheel housing and a low hum may be heard. A ticking sound from the fuel pump may also be heard from the rear section of the car. This is perfectly normal.

## Battery and charging

The heater is powered by the car's starter battery. If the charge level of the starter battery is too low, then the heater is switched off automatically and the driver display shows a message.

### **i** NOTE

Make sure that there is enough charge in the battery if the heater needs to be used.

## Fuel and refuelling<sup>6</sup>

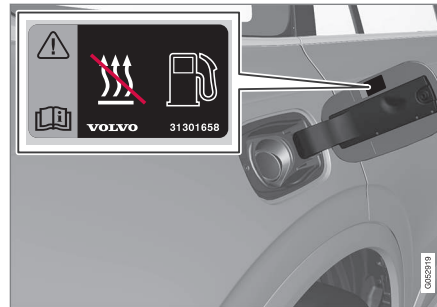

Warning label on fuel filler flap.

The heater uses fuel from the car's normal fuel tank.

If the car is parked on a steep hill, the front of the car should point downhill to ensure that there is a supply of fuel to the heater.

If the level in the fuel tank is too low then the heater is switched off automatically and the driver display shows a message.

### **i** NOTE

Make sure there is enough fuel in the car's normal fuel tank if the heater needs to be used.

### **!** WARNING

Fuel which spills out could be ignited. Switch off the fuel-driven heater before starting to refuel.

Check in the driver display that the heater is switched off. The heat symbol is shown when it is operating.

## Related information

- Parking heater\* (p. 212)
- Additional heater\* (p. 213)
- Parking climate\* (p. 204)

<sup>6</sup> Applies to fuel-driven heater.

**Parking heater\***

The parking heater helps the passenger compartment reach the correct temperature before driving.

The parking heater is one of two subfunctions of the car's heater. The heater is fitted in the front right-hand wheel housing.

**i NOTE**

When the heater is running, smoke may be emitted from the right-hand front wheel housing and a low hum may be heard. A ticking sound from the fuel pump may also be heard from the rear section of the car. This is perfectly normal.

The parking heater starts automatically when extra heat is required if the parking climate control's preconditioning\* is activated.

It is then switched off automatically when the right temperature, the time of a set timer or the heater's maximum running time has been reached.

The heater's maximum running time is 40 minutes.

**i NOTE**

Make sure there is enough fuel in the car's normal fuel tank if the heater needs to be used.

Make sure that there is enough charge in the starter battery if the heater needs to be used.

**! IMPORTANT**

Repeated use of the parking heater combined with short journeys may discharge the battery and impair starting.

If the heater is used on a regular basis, then the car should be driven for the same amount of time that the heater is used in order to ensure that the car's battery is recharged with the same amount of energy as consumed by the parking heater. The parking heater is used for a maximum of 40 minutes each time.

**! WARNING**

Do not use preconditioning if the car is equipped with a heater\*:

- In unventilated spaces indoors. Exhaust gases are emitted if the heater starts.
- In locations with combustible or flammable material nearby. Fuel, gas, long grass, sawdust, etc. may ignite.
- When there is a risk that the heater's exhaust line may be blocked. For example, deep snow inside the front right-hand wheel housing can obstruct the heater's ventilation.

Remember that the preconditioning can be started by a timer that has been set for a long time in advance.

**! WARNING**

If there is a smell of fuel, unusual amounts of smoke, black smoke, or unusual sounds coming from the parking heater, switch off the heater and, if possible, pull out its fuse. Volvo recommends that an authorised Volvo workshop should be contacted for repair.

**Related information**

- Heater\* (p. 211)
- Additional heater\* (p. 213)
- Parking climate\* (p. 204)
- Fuses in engine compartment (p. 537)

## Additional heater\*

The additional heater helps the passenger compartment and engine reach the correct temperature while driving.

The additional heater is one of two subfunctions of the car's heater. The heater is fitted in the front right-hand wheel housing.

### **i** NOTE

When the heater is running, smoke may be emitted from the right-hand front wheel housing and a low hum may be heard. A ticking sound from the fuel pump may also be heard from the rear section of the car. This is perfectly normal.

The additional heater starts and is controlled automatically when heating is required while the car is being driven.

It then switches off automatically when the car is switched off.

### **i** NOTE

Make sure there is enough fuel in the car's normal fuel tank if the heater needs to be used.

Make sure that there is enough charge in the starter battery if the heater needs to be used.

## Activating/deactivating automatic start for the additional heater

It is possible to set whether automatic start for the additional heater should be activated/deactivated.

1. Press **Settings** in the top view in the centre display.
2. Press **Climate**.
3. Select **Additional Heater** to activate/deactivate automatic start of the additional heater.

### **i** NOTE

Volvo recommends that the automatic start for the additional heater should be switched off for short driving distances.

## Related information

- Heater\* (p. 211)
- Parking heater\* (p. 212)



LOADING AND STORAGE

## Passenger compartment interior

Overview of the passenger compartment's interior and storage locations.

### Front seat

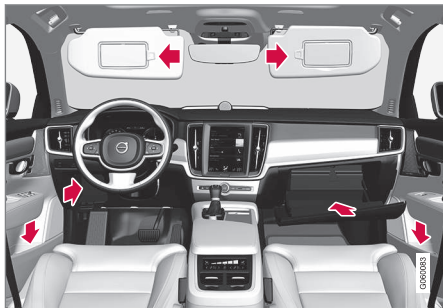

Storage compartment in the door panel and by the steering wheel, glovebox and sun visors.

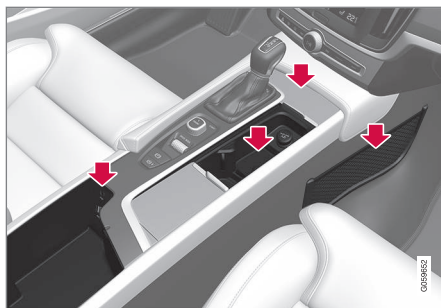

Storage spaces with cup holder, ashtray\*, electrical socket and cigarette lighter\*, mesh pocket\*, as well as an AUX/USB socket in the tunnel console.

### Rear seat

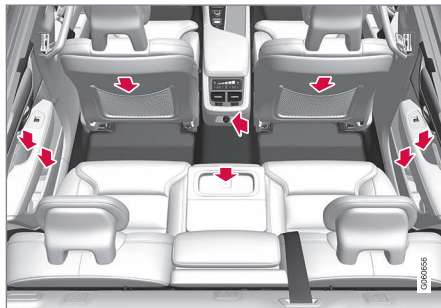

Storage compartment and ashtray\* in the door panel, cup holder\* in the centre seat backrest, storage pocket\* on the front seat backrest and also electrical sockets and cigarette lighter\* in the tunnel console.

**⚠ WARNING**

Keep loose objects such as mobile phones, cameras, remote controls for accessories, etc. in the glove compartment or other compartments. Otherwise they may injure people in the car in the event of sudden braking or a collision.

### Related information

- Tunnel console (p. 217)
- Using the glovebox (p. 223)
- Sun visors (p. 224)
- Electrical sockets (p. 218)
- Emptying ashtrays\* (p. 222)

## Tunnel console

The tunnel console is located between the front seats.

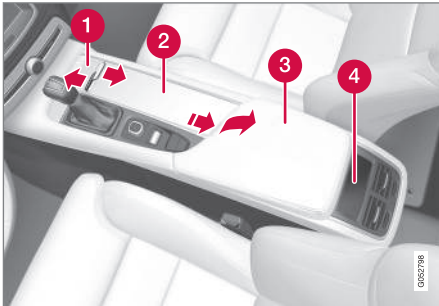

- 1 Storage compartment with hatch\*. The hatch is opened/closed with a push on the handle.
- 2 Storage compartment with cup holder for driver and passenger as well as 12 V socket. If ashtray and cigarette lighter were specified then there is a cigarette lighter in the 12 V socket and a detachable ashtray in the cup holder.
- 3 Storage compartment and AUX/USB input under the armrest.
- 4 Climate controls for the rear seat climate functions\* or storage compartment.

## Related information

- Passenger compartment interior (p. 216)
- Electrical sockets (p. 218)
- Using the cigarette lighter\* (p. 222)
- Emptying ashtrays\* (p. 222)
- Connecting media via AUX/USB input (p. 448)
- Climate controls at the rear of the tunnel console\* (p. 186)

## Electrical sockets

In the tunnel console there are two 12 V electrical sockets and one 230 V electrical socket\*, in the cargo area there is one 12 V electrical socket\*.

For the sockets to supply current, the car's electrical system must be set in the lowest ignition position **I**. The sockets are then active as long as the starter battery level does not become too low.

If the engine is switched off and the car is locked, the sockets are deactivated. If the engine is switched off and the car is not locked, or is locked with blocked lock position temporarily deactivated, then the sockets continue to be active for a further ten minutes.

### **i** NOTE

Remember that use of the electrical socket with the engine switched off entails a risk of discharging the starter battery, which can limit functionality.

## 230 V electrical socket\*

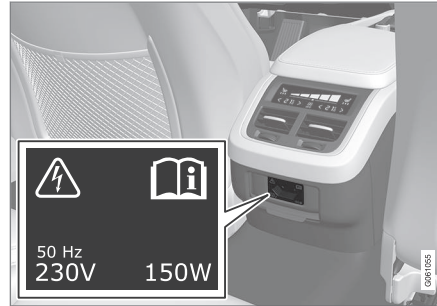

230 V electrical socket in tunnel console, rear seat.

The socket can be used for various accessories requiring a 230 V supply, e.g. chargers and laptop computers.

### **!** IMPORTANT

Maximum socket output is 150 W.

### Using the socket

1. Pull down the socket cover and insert the accessory's plug.
  - > The diode on the socket indicates its status.
2. Check that the diode is illuminated with a steady green light - only then is current available at the socket.

3. Disconnect the accessory by pulling out the plug - do not pull on the cable.

Pull up the cover when the socket is not being used or the socket is left unattended.

### **!** IMPORTANT

- Do not use accessories with large or heavy connectors - they can damage the socket or come loose when driving.
- Do not use accessories that can cause interference to the car's radio receiver or electrical system for example.
- Position the accessory so that it is not at risk of injuring the driver or passengers in the event of heavy braking or collision.
- Keep an eye on connected accessories as they can generate heat that can burn passengers or the interior.

### **!** WARNING

- Only use accessories that are undamaged and fault-free. The accessories must be rated for 230 V and 50 Hz with connectors designed for the socket. The accessories must have a CE marking, UL marking or an equivalent safety marking.
- Never allow sockets, connectors or accessories to come into contact with water or other liquids. Do not touch or use the socket if it appears to be dam-



aged or has come into contact with water or other liquid.

- Do not connect junction sockets, adapters or extension cables to the socket as these can override the socket's safety features.
- The socket is equipped with a protective cover, ensure that nothing protrudes in or damages the socket preventing the cover from doing its job. Do not leave children in the car unsupervised when the socket is active.

Failure to follow the advice given above can lead to severe or fatal electric shocks.

### Status indication

A diode on the socket indicates its status:

Status indication	Reason	Action
Steady green light	The socket is delivering current to a connected device.	None.
Blinking orange light	The temperature of the socket's voltage converter is too high (because for example the accessory draws too high a current or the passenger compartment is too warm).	Remove the plug and let the voltage converter cool down before reinserting the plug.
	The connected accessory draws too much current (intermittently or continuously) or is defective.	None. The accessory cannot be connected to the socket.



Status indication	Reason	Action
Diode not illuminated	The socket does not sense that a plug has been inserted.	Check that the plug is properly inserted into the socket.
	The socket is not active.	Switch the car's electrical system to the lowest ignition position I.
	The socket has been active but is now deactivated.	Start the engine and/or charge the starter battery.

If the problem persists, contact a workshop - an authorised Volvo workshop is recommended.

**⚠ WARNING**

Never modify or repair the 230 V electrical socket yourself. Volvo recommends that an authorised Volvo workshop should be contacted.

**12 V electrical socket**



12 V electrical socket in tunnel console, front seat.



12 V electrical socket in tunnel console, rear seat.



12 V electrical socket in cargo area\*.

The sockets can be used for various accessories designed for 12 V, such as music players, cooler boxes and mobile phones.

The socket in the tunnel console can be complemented with a cigarette lighter\*.

**⚠ IMPORTANT**

Maximum socket output is 120 W per socket.

**Using the sockets**

1. Remove the blanking plug (tunnel console) or fold down the cover (cargo area) and plug in the accessory.
2. Unplug the accessory's connector and refit the blanking plug (tunnel console) or fold up the cover (cargo area) when the socket is not being used or if the socket is left unattended.

**Related information**

- Passenger compartment interior (p. 216)

## Using the cigarette lighter\*

The cigarette lighter can be mounted in the 12 V sockets in the front and rear sections of the tunnel console.

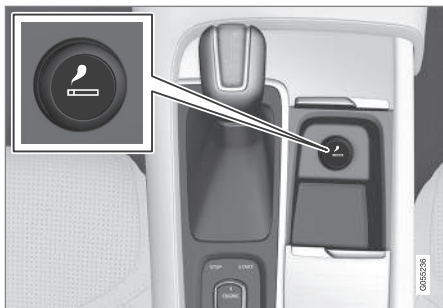

Cigarette lighter in the tunnel console, front seat.



Cigarette lighter in the tunnel console, rear seat.

1. Press in the button on the lighter.
  - > When the lighter is glowing the button hops up.
2. Pull out the lighter from the socket and light a cigarette on the glowing coils.
3. Replace the lighter in the socket.

### **!** IMPORTANT

Observe caution when the lighter is activated so that the glowing part does not damage the interior for example.

### Related information

- Tunnel console (p. 217)
- Electrical sockets (p. 218)
- Emptying ashtrays\* (p. 222)

## Emptying ashtrays\*

With a cigarette lighter in the car, there are detachable ashtrays in the tunnel console's cup holders and in the door panels for the rear seat.

### Emptying an ashtray in the tunnel console

1. Detach the ashtray by pulling it straight up from the cup holder and empty the contents.
2. Refit the ashtray in the cup holder.

### Emptying an ashtray in the door panels for the rear seat

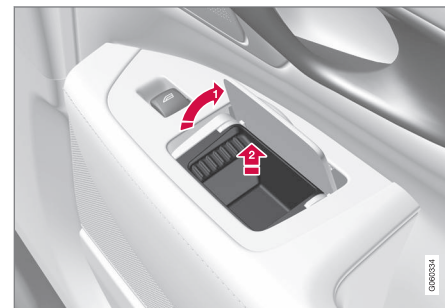

1. Open the ashtray's cover and then press the cover up to a fully vertical position.
  - > The catch that holds the ashtray in place is released.
2. Lift up the ashtray and empty the contents.

3. Refit the ashtray and allow it to slide down in the tracks on the sides.

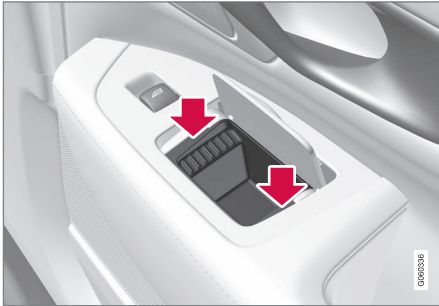

4. Carefully press the two short sides of the ashtray.  
 > The catch that holds the ashtray in place reattaches.

#### Related information

- Passenger compartment interior (p. 216)
- Tunnel console (p. 217)
- Using the cigarette lighter\* (p. 222)

### Using the glovebox

The glovebox is located on the passenger side.

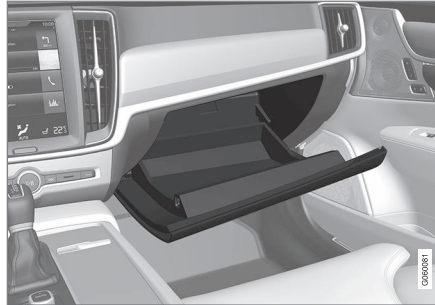

The printed owner's manual and maps can be kept in the glovebox, for example. There is also a pen holder on the inside of the lid.

#### Locking/unlocking the glovebox\*

The glovebox can be locked, e.g. when the car is taken in for service, left at a hotel or similar. The glovebox can only be locked/unlocked with the accompanying key.

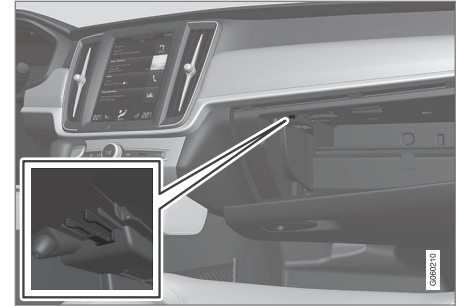

The key's designated storage space

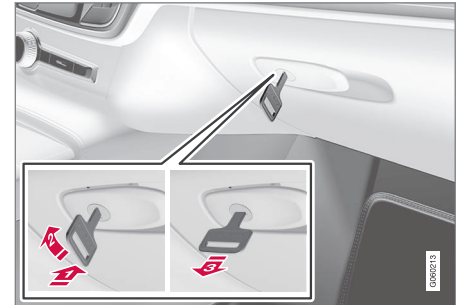

Locking the glovebox:

- 1 Insert the key in the glovebox lock cylinder.
- 2 Turn the key 90 degrees clockwise.
- 3 Pull out the key.

– Unlock by carrying this out in reverse order.



#### ◀ Using the glovebox as a cooled area\*

The glovebox can be used for cooling of e.g. drinks or food. The cooling works when the climate control system is active (i.e. when the car is set in ignition position **II** or when the engine is running).

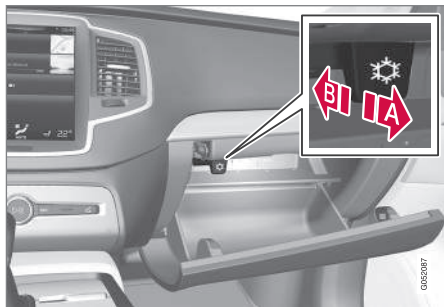

**A** Cooling activated

**B** Cooling deactivated

- Activate/deactivate the cooling by moving the control to the end position toward the passenger compartment/glovebox.

#### Related information

- Passenger compartment interior (p. 216)
- Using private locking (p. 247)

#### Sun visors

The rear of each sun visor includes a vanity mirror with card holder.

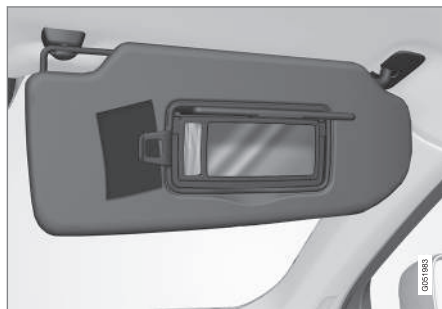

Vanity mirror with lighting plus card holder.

The vanity mirror lighting\* is switched on automatically when the lid is lifted.

The vanity mirror frame incorporates a holder for e.g. cards or tickets.

#### Related information

- Passenger compartment interior (p. 216)

#### Cargo area

The car has a flexible cargo area that makes it possible to transport and secure large objects.

By folding down the backrests in the rear seat, the cargo area can become quite spacious. Use load retaining eyelets or bag holders to secure the load, and the extendable cargo cover\* to conceal the load if desired. The warning triangle and first-aid kit are also stored in the cargo area.

The car's towing eye and puncture repair kit or spare wheel\* are stored under the cargo area floor.

#### Related information

- Through-load hatch in the rear seat (p. 227)
- Lowering the backrests in the rear seat (p. 130)
- Loading (p. 225)
- Tool kit (p. 500)

## Loading

There are a number of things to remember when loading the car.

Payload depends on the car's kerb weight. The total of the weight of the passengers and all accessories reduces the car's payload by a corresponding weight.

### WARNING

The car's driving properties change depending on the weight and positioning of the load.

## Recommendations for loading in the cargo area

- Position the load firmly against the rear seat's backrest.
- Centre the load.
- Heavy objects should be placed as low as possible. Avoid placing heavy loads on lower backrests.
- Cover sharp edges with something soft to avoid damaging the upholstery.
- Secure all loads to the load retaining eyelets with straps or web lashings.

### WARNING

A loose object weighing 20 kg can, in a frontal collision at a speed of 50 km/h (30 mph) carry the impact of an item weighing 1000 kg.

### WARNING

The protection provided by the inflatable curtain in the headlining may be compromised or eliminated by high loads.

- Never load cargo above the backrest.

### WARNING

Always secure the load. During heavy braking the load may otherwise shift, causing injury to the car's occupants.

Cover sharp edges and sharp corners with something soft.

Switch off the engine and apply the parking brake when loading/unloading long items. Otherwise you may accidentally knock the gear lever or gear selector with the load into a drive position - and the car could then move off.

## Increasing the space in the cargo area

To expand the cargo area and simplify loading, the rear seat's backrest can be lowered. Note

that objects must not prevent the function of the WHIPS system for the front seats if any of the rear seat's backrests is folded down.

A through-load hatch in the rear seat can be folded down for carrying long and narrow loads.

## Recommendations for roof loads

For loading on the car's roof, the load carriers<sup>1</sup> that Volvo have developed are recommended. This is in order to avoid damage to the car and in order to achieve the maximum possible safety during a journey.

Carefully follow the installation instructions supplied with the carriers.

- Check periodically that the load carriers and load are properly secured. Lash the load securely with retaining straps.
- Distribute the load evenly over the load carriers. Put the heaviest objects at the bottom.
- The size of the area exposed to the wind, and therefore fuel consumption, increase with the size of the load.
- Drive gently. Avoid quick acceleration, heavy braking and hard cornering.

<sup>1</sup> Volvo's load carriers are available for purchase at authorised Volvo dealers.



**⚠ WARNING**

The car's centre of gravity and driving characteristics are altered by roof loads.

Read about maximum permitted roof load in the section on Weights.

**Related information**

- Load retaining eyelets (p. 226)
- Locking/unlocking the tailgate (p. 245)
- Through-load hatch in the rear seat (p. 227)
- Lowering the backrests in the rear seat (p. 130)
- Safety grille\* (p. 232)
- Safety net\* (p. 230)
- Cargo cover\* (p. 228)
- Weights (p. 563)

**Load retaining eyelets**

The folding load retaining eyelets are used to fasten straps in order to anchor items in the cargo area.

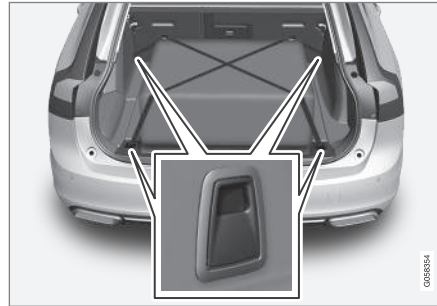

**⚠ WARNING**

Hard, sharp and/or heavy objects which protrude may cause injury under violent braking.

Always secure large and heavy objects with a seatbelt or cargo retaining straps.

**Related information**

- Loading (p. 225)
- Bag hooks (p. 226)
- Safety grille\* (p. 232)
- Safety net\* (p. 230)
- Cargo cover\* (p. 228)

**Bag hooks**

Bag hooks, together with an elastic strap, hold bags in place and prevent them from falling over and spreading their contents across the cargo area.

**Under the floor hatch\***

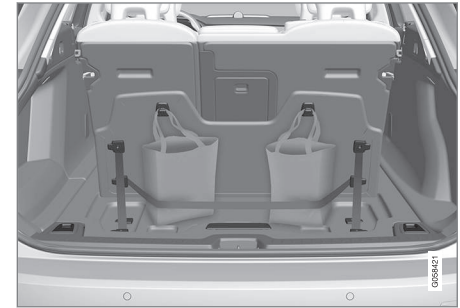



There are two bag hooks and an elastic strap<sup>2</sup> in the cover, which is part of the floor hatch in the cargo area. The strap can be fitted in four different positions.

Lift up the cover in order to use the bag hooks. Fasten the bags in a suitable position with the enclosed elastic strap. If the bags have handles and are a suitable height - hang them in the hooks.

### Along the sides

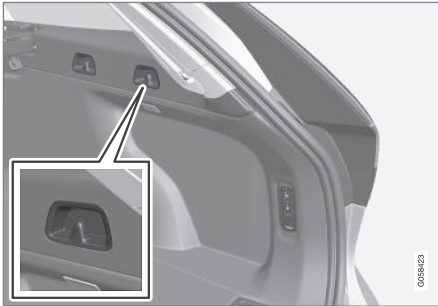

There are two bag hooks in the side panel on each side of the cargo area.

### **!** IMPORTANT

The bag hooks may be loaded with a maximum of 5 kg.

### Related information

- Loading (p. 225)
- Safety grille\* (p. 232)
- Safety net\* (p. 230)
- Cargo cover\* (p. 228)

### Through-load hatch in the rear seat

The hatch in the rear seat's backrest can be opened to transport long narrow items, e.g. skis.

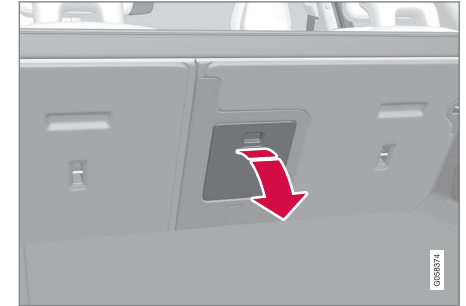

1. In the cargo area, grip the hatch's handle and fold down the hatch.
2. Fold forward the armrest in the rear seat.

If the private locking\* function is used then the hatch must be closed.

### Applies to Bi-Fuel\* cars

Due to the raised cargo area floor in a car with vehicle gas tank, it is not possible to use the through-load hatch.

<sup>2</sup> It is possible to reorder additional elastic straps at a Volvo dealer.

◀◀ **Related information**

- Using private locking (p. 247)
- Loading (p. 225)
- Load retaining eyelets (p. 226)

**Cargo cover\***

In the extended position, the cargo cover prevents visual access to the cargo area.

**Installation**

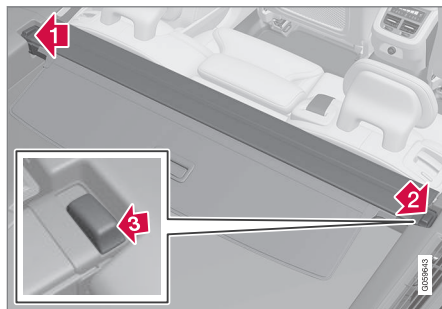

- Insert one of the cargo cover's end pieces in the recess in the side panel in the cargo area.
- Then insert the other end piece in the recess in the side panel on the opposite side.
- Press down the end pieces on both sides - one by one.
  - > When a "click" is heard and the red marking on each end piece has disappeared, the cargo cover is attached - check that it is affixed securely.



4. Fold the cargo cover's front sealing disc forward to eliminate the space between the cargo cover and the rear seat's backrests.

If the safety net\* shall be used at the same time as the cargo cover then the safety net must be fitted first.

**Usage**

There are two extended positions for the cargo cover - a full-cover position and a loading position, where it is partially extended to make it easier to reach further into the cargo area.

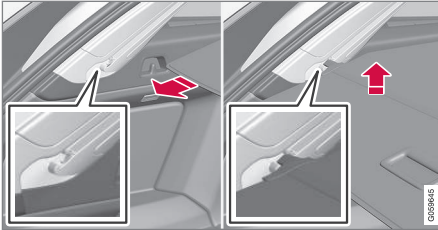
**Full-cover position**

1. Grip the handle and pull out the cargo cover so that it slides over the side panels in the cargo area. Pull to the end position.
2. Guide the cover's attachment pins into the grooves in the side panels. Release, while at the same time angling the handle slightly upwards so that the attachment pins hook in.
  - > The cargo cover is locked in the full-cover position.

**Loading mode**

From the full-cover position:

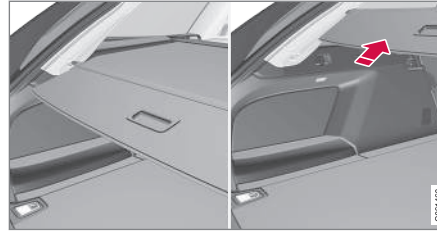

- Grip the handle to release the attachment pins from the hooks.
  - > The cover retracts until it stops in the loading position.

Returning to full-cover position from loading position:

1. Grip the handle and pull the cargo cover out to the end position.
2. Release the handle so that the attachment pins hook into the hooks.
  - > The cover is then locked in the loading position.

With an automatic\* cargo cover, the cover will be retracted from full-cover position to loading position every time the tailgate is opened, and extended again when the tailgate is closed. The cargo cover detects if something is obstructing its movement and then retracts automatically.

**i NOTE**

The cargo cover may not operate automatically in low passenger compartment temperatures.

**! IMPORTANT**

Do not load objects on top of the cargo cover.

**! IMPORTANT**

Pay attention to the risk of crushing when opening and closing with the automatic\* cargo cover.

**! IMPORTANT**

If the cargo area is loaded with a bulky load then the automatic\* cargo cover is moved to retracted position in order to avoid it making contact with the load.



## LOADING AND STORAGE

### ◀ Retracting

1. From the full-cover position:

Lift up the handle and pull it backward to disengage the cargo cover's attachment pins and then release.

From loading position:

Grip the handle and pull out the cargo cover in the grooves - pull to the full-cover position. Lift up the handle and pull it backward to disengage the attachment pins and then release.

2. Retract the cover with its attachment pins outside of the side panels until it stops in the retracted position.

Remember that a retracted cargo cover may obstruct rearward visibility.

### Removal

In retracted position:

1. Depress the button on one of the retracted cargo cover's end pieces and lift out that end.
2. Angle the cover up/out carefully.
  - > The other end piece loosens automatically and the cover can be lifted out of the cargo area.

### Related information

- Loading (p. 225)
- Safety grille\* (p. 232)

- Safety net\* (p. 230)
- Load retaining eyelets (p. 226)

### Safety net\*

The safety net prevents loads from being thrown forward in the passenger compartment in the event of sudden braking.

The safety net is fitted into four mounting points.

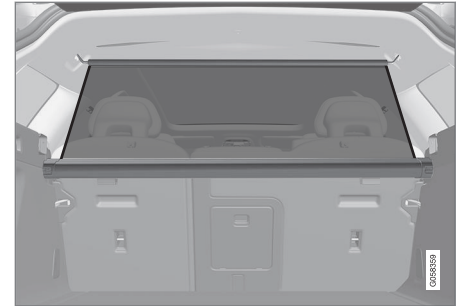

For reasons of safety, the safety net must always be fastened and anchored as described below.

The net is made of a strong nylon fabric and can be secured two different locations in the car:

- Rear fitting - behind the rear seat.
- Front fitting - behind the front seats.

### **WARNING**

Loads in the luggage compartment must be anchored well, and also using a correctly fitted safety net.

## Installation

### Rear fitting

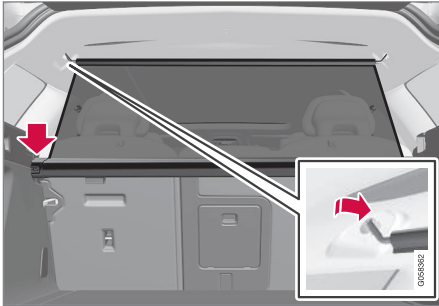

1. If necessary, fold the rear seat backrests forward in order to facilitate installation.
2. Lower the safety net cassette's end pieces over the mounting eyelets in the recess of the side panels. Press down the end piece one side at a time. Check that the cassette is properly secured.
3. Pull up the net.
4. Hook one of the safety net's retaining hooks into the rear roof mounting and then press it forward to the end position.
5. Hook the other of the safety net's retaining hooks on the opposite side and press it forward to the end position.

### Front fitting

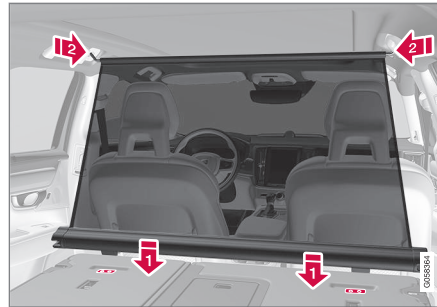

1. Fold the rear seat's backrest forward.
2. Align the safety net cassette's anchor rails in front of the backrest's attachment lugs.
3. Slide the cassette into the attachment lugs.
4. Pull up the net.
5. Hook one of the safety net's retaining hooks into the front roof mounting and then press it forward to the end position.
6. Hook the other of the safety net's retaining hooks on the opposite side and press it forward to the end position.

### Removing and storing

1. Undo the safety net from the roof mountings by pressing the retaining hooks backwards. Allow the net to roll into the cassette.

2.



Rear fitting:

Press the button on each side of the cassette in order to release the end pieces from the mounting eyelets. Lift out the safety net.

Front fitting:

Slide the cassette from the attachment lugs and lift out the safety net.

### Related information

- Loading (p. 225)
- Safety grille\* (p. 232)
- Cargo cover\* (p. 228)
- Load retaining eyelets (p. 226)

## Safety grille\*

The safety grille prevents loads or pets in the cargo area from being thrown forward in the passenger compartment.

The safety grille is crash-tested in accordance with the ECE R17 legal requirement and fulfils Volvo's strength requirements.

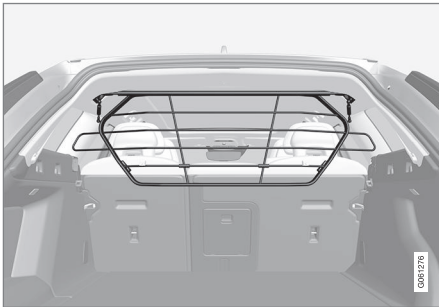

For safety reasons, the safety grille must always be attached and anchored correctly.

### **WARNING**

Under no circumstances may anybody remain in the cargo area while the car is moving. This is to avoid injury in the event of heavy braking or an accident.

## Installation

Before first installing the safety grille, the existing plastic roof mountings must be replaced with steel roof mountings. Volvo recommends that replacing roof mountings is performed at an authorised Volvo workshop or dealer.

1. Fold the rear seat's backrest forward.
2. Make sure that the safety grille is turned in the right direction. Lift in the safety grille through one of the rear side doors.

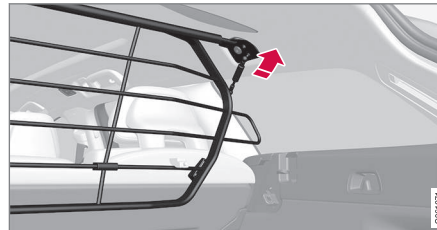

3. Position the safety grille's brackets on the roof mountings.

The next step is facilitated if two people hold the safety grille in the right position.

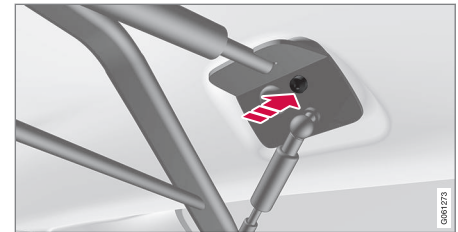

4. Fit the enclosed screw and screw in. Repeat on the other side.  
> Check that the safety grille is firmly fitted.

For more information about the tools required and methods for fitting/removal, see the installation instructions<sup>3</sup> that were included with the initial purchase.

### **IMPORTANT**

The protective grille cannot be folded up or down when a cargo cover is fitted.

## Related information

- Loading (p. 225)
- Load retaining eyelets (p. 226)
- Safety net\* (p. 230)
- Cargo cover\* (p. 228)

<sup>3</sup> Installation instructions no. 31659257.

LOCKS AND ALARM

## Remote control key

The remote control key locks/unlocks the doors and tailgate. The remote control key needs to be inside the car for it to be started.



Remote control key, on left, and button-less key (Key Tag), on right.

The remote control key is not physically used when starting since the car is equipped with support for keyless starting (Passive Start) as standard. The key needs to be located in the front of the passenger compartment, e.g. in the driver's pocket or in the cup holder in the tunnel console, to be able to start the car. See the section "Starting the engine".

As an option, keyless locking/unlocking of doors and tailgate (Passive Entry\*) is also available. The key then has a range extending in a semicircle with a radius of approx. 1.5 metres out from the driver's door and approx. 1 metre out from the

tailgate. See the section "Remote control key range".

With keyless starting and keyless locking/unlocking, the remote control key can be located anywhere in the passenger compartment or the cargo area and maintain the functionality to start the car.

Each of the remote control keys that are supplied with the car can be linked to a driver profile with unique settings for the car. When a key with a specific profile is used, the car's settings are adjusted to match the settings for that profile. See the section "Driver profiles".

### Button-less key (Key Tag)

For cars equipped with keyless locking/unlocking\*, a slightly smaller, lighter and button-less key (Key Tag) is supplied. It works the same way as the normal remote control key when it comes to keyless starting and locking/unlocking. It has no detachable key blade and the battery cannot be replaced. A new key tag can be ordered from an authorised Volvo workshop.

### Ordering additional keys

The car is supplied with two remote control keys - one key tag is supplied if the car is equipped with keyless locking/unlocking\*. Additional keys can be ordered. A total of twelve keys can be programmed and used for one single car. If additional keys are ordered, additional driver profiles

are added - one per new remote control key. This also applies for the key tag.

In the event of a lost key, see the heading "Loss of a remote control key" below.

### Remote control key buttons



The remote control key has four buttons - one on the left-hand side and three on the right-hand side.

**🔒 Locking** - Pressing the button locks the doors and the tailgate and also arms the alarm\*. Press and hold to close all of the windows and the panorama roof\* simultaneously. See the section "Locking/unlocking from the outside" and "Locking/unlocking from the inside".

**🔓 Unlocking** - Pressing the button unlocks the doors and tailgate and also disarms the alarm. A longer press opens all the windows



simultaneously, also called Global opening<sup>1</sup>. See the section "Locking/unlocking from the outside".

 **Tailgate** - Unlocks the tailgate only and disarms its alarm. On cars with power operated tailgate\*, the tailgate is opened automatically when the button is held depressed. The tailgate is also closed with a long press - acoustic warning signals sound. See the section "Power operated tailgate".

 **Panic function** - Used to attract attention in an emergency. Press and hold the button for at least 3 seconds or press it twice within 3 seconds to activate the direction indicators and the horn. The function can be turned off with the same button once it has been active for at least 5 seconds. Otherwise the function switches off automatically after 3 minutes.

## WARNING

If anyone is left in the car, make sure the power windows and sunroof are de-energised by always taking the remote control key with you when you leave the car.

### NOTE

Be aware of the risk of locking the remote control key/Key Tag in the car.

A remote control key/Key Tag left in the car will be deactivated when the car is locked and the alarm is armed using another valid key. The deactivated key is reactivated when the car is unlocked.

### Interference

Remote control key functions for keyless starting and keyless locking/unlocking\* can be disrupted by electromagnetic fields and screening.

### NOTE

Avoid storing the remote control key close to metal objects or electronic apparatus, e.g. mobile phones, tablets, laptops or chargers - preferably no closer than 10-15 cm.

If there is still interference - use the remote control key's key blade and then place the key in the backup reader in the cup holder to disarm the car. See section "Locking/unlocking with the detachable key blade".

### NOTE

When the remote control key is placed in the cup holder, make sure that no other car keys, metal objects or electronic apparatus (e.g. mobile phones, tablets, laptops or chargers) are in the cup holder. Several car keys close to each other in the cup holder can cause interference with each other.

### Loss of a remote control key

If you lose a remote control key then a new one can be ordered at a workshop - an authorised Volvo workshop is recommended. The remaining remote control keys must be taken to the workshop. The code of the missing key must be erased from the system as a theft prevention measure.

The current number of keys registered to the car can be checked in the centre display's top view.

### Related information

- Remote control key range (p. 236)
- Detachable key blade (p. 248)
- Replacing the battery in the remote control key (p. 255)
- Locking/unlocking from the inside (p. 243)
- Locking/unlocking from the outside (p. 239)
- Driver profiles (p. 173)



<sup>1</sup> Used, for example, to quickly air the car during hot weather.

- Power operated tailgate\* (p. 251)
- Starting the car (p. 384)
- Red Key - Restricted remote control key\* (p. 237)

### Remote control key range

In order for the remote control key to work properly it needs to be within a certain distance from the car.

#### For manual use

The remote control key's functions for e.g. locking/unlocking that are activated by pressing on  or  have a range that extends approx. 20 metres from the car.

If the car does not verify a button being pressed - move closer and try again.

#### For keyless use<sup>2</sup>

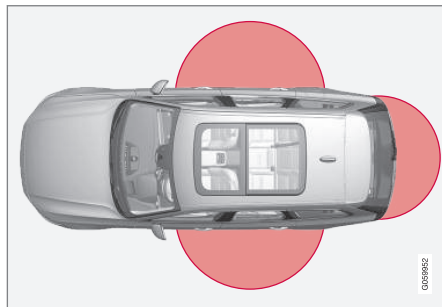

The marked area in the illustration shows areas covered by the system's antennas.

For keyless use, a remote control key or the button-less key (Key Tag) must be within a semicir-

cle format area with a radius of approx. 1.5 metres on both long sides and approx. 1 metre from the tailgate.

#### NOTE

The remote control key functions may be disrupted by surrounding radio waves, buildings, topographical conditions, etc. The car can always be locked/unlocked with the key blade.

#### If the remote control key is removed from the car



If the remote control key is removed from the car when the engine is running, the warning message **Car key not found Removed from car** is shown in the driver display and an acoustic reminder sounds when the last door is closed.

The message extinguishes when the key is returned to the car, followed by a press of the right-hand keypad's **O** button, or when the last door is closed.

#### Related information

- Remote control key (p. 234)
- Antenna locations for the start and lock system (p. 238)

<sup>2</sup> Only applies to cars equipped with the keyless locking/unlocking option (Passive Entry).

## Red Key - Restricted remote control key\*

A Red Key enables the car owner to set limits for certain car properties. The restrictions are intended to promote safe driving of the car, e.g. when it is loaned out.



For a Red Key, it is possible to define the car's maximum speed, set speed reminders and determine the loudspeaker system's maximum volume. In addition, some of the car's driver support systems will always be active. Other functions of the key are the same as those of a normal remote control key.

One or more Red Keys can be ordered from a Volvo dealer. A total of eleven keys with restrictions can be programmed and used for a single

car - at least one must be a normal remote control key.

The settings for Red Key are made by the user of the normal remote control key from the centre display's top view; go to: **Settings** → **System** → **Driver Profiles** → **Red Keys**

Some of the car's driver support functions cannot be deactivated by the user of a Red Key.

The restrictions are intended to act as measures to reduce the risk of accidents, thereby making it feel safer to hand over the car to e.g. young drivers, valet parking or a workshop. The settings cannot be changed by the person using a Red Key.

### Possible settings

The following settings can be made to apply for a Red Key:

#### Speed limiter (Speed Limiter)<sup>3</sup> (On/Off):

- Setting interval: 50-250 km/h (30-160 mph)
- Setting during first use is 120 km/h (75 mph)
- Increments: 1 km/h (1 mph)



The driver display shows the symbol and message

**Red key Speed limitation cannot be exceeded.**

#### Speed reminder<sup>3</sup> (On/Off):

- Setting interval: 0-250 km/h (0-160 mph)
- Setting during first use is: 50, 70 and 90 km/h (30, 45 and 55 mph)
- Increments: 1 km/h (1 mph)
- Max. number of simultaneous reminders: 6

#### Muted max. volume<sup>3</sup> (On/Off):

- Setting at first use: On

#### Adaptive cruise control<sup>\*</sup>:

- Setting at first use: Longest intervals
- See the section "Adaptive cruise control" for more information

### Driver support functions

The following driver support functions will always be active for the user of a Red Key:

- Blind Spot Information (BLIS)<sup>\*</sup> - see section "Blind Spot Information"
- Lane assistance (LDW and LKA)<sup>\*</sup> - see section "Lane assistance"
- Distance warning<sup>\*</sup> - see section "Distance warning"
- City Safety - see section "City Safety"
- Driver Alert Control (DAC)<sup>\*</sup> - see section "Driver Alert Control"
- Road Sign Information<sup>\*</sup> - see section "Road Sign Information".

<sup>3</sup> Option, only available with Red Key.

### ◀ Related information

- Remote control key (p. 234)
- Adaptive cruise control\* (p. 288)
- Distance Warning\* (p. 286)
- Blind Spot Information\* (p. 338)
- City Safety (p. 328)
- Lane Keeping Aid (p. 352)
- Driver Alert Control (p. 350)
- Road Sign Information\* (p. 346)
- Driver profiles (p. 173)

### Antenna locations for the start and lock system

The car is equipped with a keyless start and lock system<sup>4</sup> and therefore has a number of built-in antennae positioned at different locations in the car.

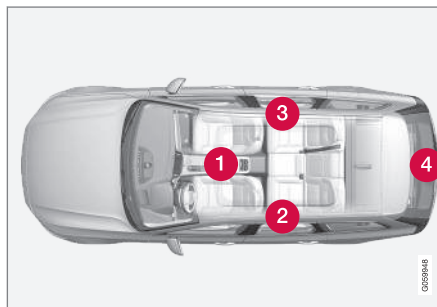

Antenna locations.

- 1 Under the cup holder in the front section of the tunnel console
- 2 In the upper front section of the left-hand rear door<sup>5</sup>
- 3 In the upper front section of the right-hand rear door<sup>5</sup>
- 4 In the cargo area

### WARNING

People with pacemaker operations should not come closer than 22 cm to the keyless system's antennae with their pacemaker. This is to prevent interference between the pacemaker and the keyless system.

### Related information

- Remote control key (p. 234)
- Remote control key range (p. 236)

<sup>4</sup> The keyless lock system only applies to cars equipped with keyless locking/unlocking (Passive Entry\*).

<sup>5</sup> Only in cars equipped with keyless locking/unlocking (Passive Entry\*).

## Locking/unlocking from the outside

The car is locked/unlocked from the outside using buttons on the remote control key or with the door or tailgate handles if the car is equipped with keyless locking/unlocking (Passive Entry)\*. The tailgate can be operated via power operation\* and/or foot movement\*.

### Locking/unlocking



The buttons on the remote control key can be used to lock/unlock all doors and the tailgate simultaneously.

### Locking

The driver's door must be closed in order for the lock sequence to be activated. If any of the other doors or the tailgate is open, then these are not locked and their alarms armed\* until they are closed. The alarm's movement detectors\* are activated when all the doors and the tailgate are closed and locked.

### **i** NOTE

Be aware of the risk of locking the remote control key/Key Tag in the car.

A remote control key/Key Tag left in the car will be deactivated when the car is locked and the alarm is armed using another valid key. The deactivated key is reactivated when the car is unlocked.

### **!** WARNING

Do not allow anyone to remain in the car without first deactivating the deadlocks in order to avoid the risk of anyone being locked in.

### Unlocking

If it is not possible to lock/unlock with the remote control key, the battery may be discharged - in which case, lock or unlock the driver's door with the detachable key blade. See the section "Detachable key blade" for more information.

### **i** NOTE

Always try moving closer to the car and making another unlock attempt.

### Settings for remote-controlled unlocking

It is possible to select different sequences for unlocking.

1. Tap on **Settings** in the centre display's top view.
2. Press **My Car** → **Locking** → **Remote and Interior Unlock**.
3. Select option:
  - **Unlock All Doors**
    - unlocks all doors simultaneously.
  - **Single Door**
    - unlocks the driver's door. Unlocking all of the doors requires two presses on the remote control key's unlock button.

The settings made for the **Remote and Interior Unlock** function also affect central unlocking via opening handles from the inside. For more information about how unlocking from the inside is affected, see the section "Locking/unlocking from the inside".

### Keyless locking/unlocking\*

If the car is equipped with keyless locking/unlocking\*, it is sufficient to have the remote control key in the vicinity e.g. in a pocket or a bag, making it more convenient to open the car if your hands are full. For information on the system's range, see the section "Remote control key range".



#### ◀ Touch-sensitive surfaces

The outside of the door handles contains a recess for locking, while the inside contains a touch-sensitive surface for unlocking. The tailgate handle has a rubberised pressure plate that is only used for unlocking.

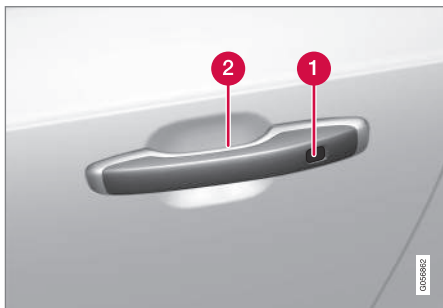

- 1 Touch-sensitive recess for locking
- 2 Touch-sensitive surface for unlocking

#### **i** NOTE

It is important that only one touch-sensitive surface is activated at a time. Gripping the handle while touching the lock surface risks giving double commands. This means that the requested activity (locking/unlocking) will not be executed, or will be executed with a delay.

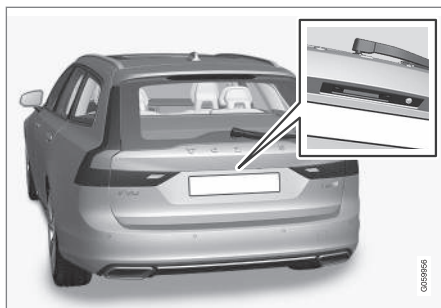

Rubberised pressure plate on the boot lid used for unlocking only.

#### Keyless locking

All side doors must be closed to be able to lock the car. The tailgate, on the other hand, can be open when locking the car with a side door handle.

- Touch the marked surface towards the rear on the outside of a door handle after the door has been closed, or press the lock button on the bottom edge of the tailgate before closing it.
  - > The lock indicator in the windscreen starts to flash to indicate the car is locked.

To close all side windows and the panorama roof\* simultaneously - place a finger against the touch-sensitive recess on the outside of the door handle until all side windows and the panorama roof\* are closed.

#### Keyless entry

- Grasp a door handle or press the rubberised pressure plate beneath the tailgate handle to unlock the car.
  - > The lock indicator in the windscreen extinguishes to confirm the car is unlocked - open the doors or tailgate as usual.

#### Settings for Keyless entry

It is possible to select different sequences for Keyless entry.

1. Tap on **Settings** in the centre display's top view.
2. Tap on **My Car** → **Locking** → **Keyless Unlock**
3. Select option:
  - **All Doors**
    - unlocks all doors simultaneously.
  - **Single Door**
    - unlocks selected door.

#### Automatic relocking

If none of the doors or the tailgate is opened within two minutes of unlocking, they are locked automatically. This function prevents the car from being left unlocked unintentionally.

#### Unlocking with Volvo On Call

It is possible to remotely unlock the car with the Volvo On Call\* app.

## Related information

- Remote control key (p. 234)
- Power operated tailgate\* (p. 251)
- Locking/unlocking the tailgate (p. 245)
- Opening/closing the tailgate with foot movement\* (p. 254)
- Remote control key range (p. 236)
- Detachable key blade (p. 248)
- Alarm\* (p. 260)

## Indication on locking/unlocking the car

When the car is locked or unlocked using the remote control key, the direction indicators confirm that locking/unlocking was correctly performed.

It is possible to separately adapt the indication for locking/unlocking, see the heading "Select how the car confirms locking and unlocking".

## Exterior indication

### Locking

- The car's hazard warning flashers indicate locking by flashing and retracting the door mirrors<sup>6</sup>.

### Unlocking

- The car's hazard warning flashers indicate unlocking by two flashes and extending the door mirrors<sup>6</sup>.

All doors, tailgate and bonnet must be closed to indicate the car is locked.

If locking is performed with only the driver's door closed<sup>7</sup>, the car will be locked but indication will only occur after all doors, tailgate and bonnet have been closed.

## Lock and alarm indicator

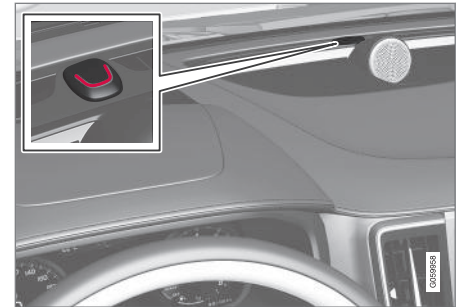

The lock and alarm indicator on the instrument panel show the status of the alarm system.

Long flash indicates locking of the car. When the car is locked, this will be indicated by short, pulsating flashes.

<sup>6</sup> Only for cars with retractable power door mirrors.

<sup>7</sup> Does not apply to cars equipped with the keyless locking/unlocking (Passive Entry\*).

## ◀◀ Indication in lock buttons

### Front doors



Lock buttons with indicator lamp in the front door.

An illuminated indicator lamp in the lock button of either front door indicates that all doors are locked. If any door is opened, the lamp will extinguish in both doors.

### In all doors\*



Lock button with indicator lamp in the rear door.

An illuminated indicator lamp in the lock button for one of the doors indicates that the door in question is locked. If any door is unlocked, its lamp will extinguish while the others will continue to illuminate.

### Select how the car confirms locking and unlocking

Different options for indicating locking/unlocking can be set via the centre display.

1. Tap on **Settings** in the centre display's top view.
2. Press **My Car** → **Locking** → **Visible Locking Feedback**.
3. Select setting for audible and visible response.

Read more about indication of locking/unlocking in section "Approach lighting" and "Adjusting the door mirrors".

### Related information

- Locking/unlocking from the outside (p. 239)
- Approach light duration (p. 148)
- Adjusting the door mirrors (p. 153)





## Locking/unlocking from the inside

The doors and tailgate can be locked and unlocked from inside using the central locking controls in the front doors. The lock controls\* on the rear doors each lock their own rear door.

### Central locking



Locking/unlocking button with indicator lamp in the front door.

- Press the  button to lock and the  button to unlock.

### Unlocking

- Press the  button to unlock all side doors and the tailgate.

A long press on the  button opens all the side windows simultaneously - also called global opening<sup>8</sup>.

<sup>8</sup> Used, for example, to quickly air the car during hot weather.

### Alternative unlocking method





Opening handle for alternative unlocking in the front door.

- Pull the opening handle on one of the front doors and release.
  - > If the **Unlock All Doors** option is selected for the **Remote and Interior Unlock** function for the remote control key, all doors will be unlocked. If the **Single Door** option is selected, only the individual front door will be unlocked and opened.

For more information about **Remote and Interior Unlock**, see the section "Locking/unlocking from the outside".

### Locking

- Press the  button - both front doors must be closed.
  - > All doors and the tailgate are locked.

A long press on the  button closes all side windows and the panorama roof\* simultaneously.

### Lock button\* rear doors



Locking button with indicator lamp in the rear door.

The rear door lock buttons only lock their respective rear door.

To unlock the rear door:

- Pull the door handle - the rear door unlocks and opens.

### ◀ Settings for automatic locking

The doors and tailgate can be locked automatically when the car starts to move.

1. Tap on **Settings** in the centre display's top view.
2. Press **My Car → Locking**.
3. Select **Auto Lock Doors While Driving**.

### Related information

- Locking/unlocking from the outside (p. 239)
- Indication on locking/unlocking the car (p. 241)

### Deadlocks\*

Deadlocks means that all door handles are mechanically disengaged, which prevents doors being opened from the inside.

Deadlocks are activated with the remote control key and in keyless locking (Passive Entry)\*. Deadlocks are activated with a delay of about 10 seconds after the doors have locked.

#### NOTE

If a door is opened within the delay time then the sequence is interrupted and the alarm is deactivated.

The car can only be unlocked with the remote control key, keyless unlocking or the Volvo On Call\* app when deadlocks are activated.

The front left door can also be unlocked with the detachable key blade. If the car is unlocked with the detachable key blade, the alarm\* will be triggered. See the section "Alarm" for switching off the alarm.

#### WARNING

Do not allow anyone to remain in the car without first deactivating the deadlocks in order to avoid the risk of anyone being locked in.

### Switching off deadlocks temporarily

If someone is going to stay in the car but the doors must be locked from the outside, then deadlocks can be temporarily switched off with the **Reduced guard** function.



Tap on the **Reduced guard** button in the centre display's function view.

Reducing the alarm level can also be selected via the centre display's top view.

- Tap on **Settings → My Car → Locking** and select **Reduced Guard**.

After this, **Reduced Guard** is shown in the centre display and deadlocks are temporarily deactivated in the subsequent locking of the car.

In conventional locking, the electrical sockets are deactivated immediately, but when deadlocks are temporarily deactivated, they will be active for a maximum of 10 minutes after locking.

If the car is unlocked and then locked again, deadlocks must be temporarily deactivated again. Note that the alarm's movement and tilt detectors\* are switched off at the same time.

The system is reset the next time the engine is started.

**i NOTE**

- Remember that the alarm is activated when the car is locked.
- If any of the doors are opened from the inside then the alarm is triggered.

**Related information**

- Remote control key (p. 234)
- Locking/unlocking from the outside (p. 239)
- Locking/unlocking from the inside (p. 243)
- Locking/unlocking with the detachable key blade (p. 249)
- Alarm\* (p. 260)

**Locking/unlocking the tailgate**

The tailgate can be locked/unlocked and opened in different ways depending on the equipment level of the car.

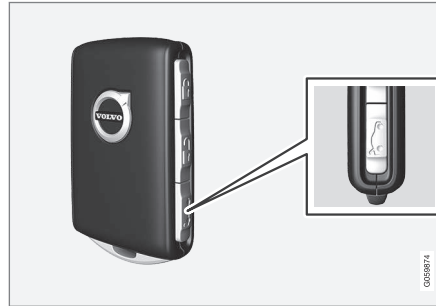
**Unlocking the tailgate with the remote control key**

The alarm for the tailgate can be disarmed and the tailgate unlocked by using the remote control key's  button.

There are two different ways to unlock the tailgate

1. Press the remote control key's  button.
  - > The lock and alarm indicator on the instrument panel extinguishes in order to show that the alarm is not armed for the whole of the car.

The alarm's level and movement sensors and the sensors for opening the tailgate are disconnected.

The tailgate is unlocked, but remains closed while the doors remain locked and their alarm functions armed.

To open the tailgate, grip the rubber pressure plate beneath the tailgate handle and open the tailgate.

If the tailgate is not opened within 2 minutes then it is relocked and the alarm is re-armed.

2. With the power operated tailgate\* option
  - Long press (approx. 1.5 seconds) on the remote control key's  button
    - > The tailgate is unlocked and opened, while the doors remain locked and their alarm functions armed.



## ◀◀ Keyless unlocking of the tailgate\*

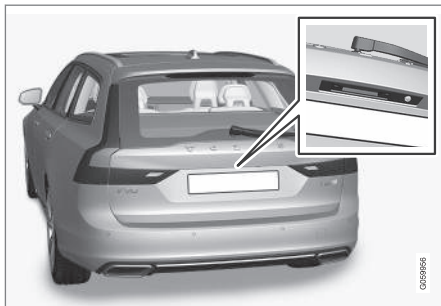

Rubber plate with pressure-sensitive surface.

The tailgate is held closed by an electrical lock. You simply need to have the remote control key in the vicinity e.g. in a pocket or a bag.

1. To open the tailgate - lightly press on the rubberised pressure plate beneath the tailgate handle.
  - > The lock is released.

### **i** NOTE

If the remote key is not detected sufficiently close to the tailgate, locking/unlocking will not work. See the section "Remote key range" for more information.

2. Lift by the outside handle in order to fully open the tailgate.

### **!** IMPORTANT

- Minimal force is required to release the rear hatch lock - just gently press the rubberised panel.
- Do not place the lift force on the rubber panel when opening the rear hatch - lift the handle. Using too much force may damage the electrical contacts on the rubber panel.

### **⚠** WARNING

Do not drive with an open tailgate! Toxic exhaust fumes could be drawn into the car through the cargo area.

## Unlocking the tailgate from the inside of the car



To unlock the tailgate:

1. Brief press on the button on the instrument panel.
  - > The tailgate can be unlocked and opened from the outside by grasping the rubberised pressure plate.
2. Plus with the power operated tailgate option
  - Long press on the button on the instrument panel.
  - > The tailgate opens.

### Locking with the remote control key

- Press the remote control key's button.
  - > The lock and alarm indicator on the instrument panel starts to flash - the car is locked and the alarm\* is armed.

## Related information

- Remote control key (p. 234)
- Power operated tailgate\* (p. 251)
- Opening/closing the tailgate with foot movement\* (p. 254)

## Using private locking

The tailgate can be locked with the private locking function when the car is taken in for service, left at a hotel or similar.

### NOTE

The car needs to be in ignition mode I as a minimum for the private locking function to be activated.



Function button for private locking. Depending on the current status of the lock, **Private locking unlocked** or **Private locking locked** is shown.

## Enter the security code before using for the first time

A security code needs to be selected during the first time the function is used. It can then be used to deactivate private locking if the selected PIN code has been lost or forgotten. The security code acts as a PUK code for all subsequent PIN codes set for the private locking function.

Save the security code in a safe place.

1. The security code can be activated from the function view or the top view in the centre display.
  - Tap on the **Private Locking** button in the function view.

Or:

  - Tap on **Settings** in the top view. Tap on **My Car → Locking** and select **Private Locking**.
    - > A pop-up window is shown.
2. Enter the desired security code.
  - > The security code is saved. The private locking function is now ready to be activated.

If the system has been reset then the above procedure needs to be repeated.

## Activate private locking

1. The function can be activated from the function view or the top view in the centre display.
  - Tap on the **Private Locking** button in the function view.

Or:

  - Tap on **Settings** in the top view. Tap on **My Car → Locking** and select **Private Locking**.
    - > A pop-up window is shown.



- ◀ 2. Enter the code to be used in order to unlock the tailgate after locking and tap on **Confirm**.
- > The tailgate is locked. Locking is confirmed by a green indication at the button in the function view and the private locking box being ticked in the settings view.

### Deactivate private locking

1. The function can be deactivated from the function view or the top view in the centre display.
  - Tap on the **Private Locking** button in the function view.

Or:

  - Tap on **Settings** in the top view. Tap on **My Car → Locking** and select **Private Locking**.
  - > A pop-up window is shown.
2. Enter the code that was used for locking and tap on **Confirm**.
  - > The tailgate is unlocked. Unlocking is confirmed by the green indication at the button in the function view disappearing and the tick disappearing from the private locking box in the settings view.

**i NOTE**

If the PIN code has been lost/forgotten, or if the wrong PIN code has been entered more than three times, the security code can be used to deactivate the private locking.

**i NOTE**

If private locking is activated and the car is unlocked via Volvo On Call\* or the Volvo On Call\* app, private locking will be deactivated automatically.

### Related information

- Using the glovebox (p. 223)
- Locking/unlocking the tailgate (p. 245)

## Detachable key blade

The remote control key contains a detachable key blade of metal with which a number of functions can be activated and some operations carried out.

The key blade's unique code is provided by authorised Volvo workshops, which are recommended when ordering new key blades.

### The key blade's application areas

Using the remote control key's detachable key blade:

- the left-hand<sup>9</sup> front door can be opened manually if central locking cannot be activated with the remote control key.
- all doors are emergency locked - see the section "Locking/unlocking with detachable key blade".
- the rear doors' mechanical child safety locks can be activated/deactivated - see the section "Child safety locks".

The button-less key<sup>10</sup> (Key Tag) does not have a detachable key blade. If necessary, use the detachable key blade from the normal remote control key.

<sup>9</sup> This applies whether the car is left-hand drive or right-hand drive.

<sup>10</sup> Supplied with cars equipped with the keyless locking/unlocking option (Passive Entry\*).

## Detaching the key blade



- 1** **1**▶ Hold the remote control key with the front visible and the Volvo logo facing the right way - slide the button at bottom edge by the key ring to the right. Guide the front side's shell a few millimetres upwards.
- 2**▶ The shell will then come free and can be lifted off the key.



- 2** **1**▶ Detach the key blade by angling it up.



- 3** Return the key blade to its intended position in the remote control key after use.
- 1**▶ Refit the shell by pressing it downward until a clicking sound is heard.
- 2**▶ Then slide the shell back sedan.
- > A further click will indicate that the shell is securely attached.

## Related information

- Locking/unlocking with the detachable key blade (p. 249)
- Child safety locks (p. 259)
- Remote control key (p. 234)

## Locking/unlocking with the detachable key blade

Amongst other things, the detachable key blade can be used to unlock the car from the outside - e.g. if the remote control key's battery has become discharged.

## Unlocking

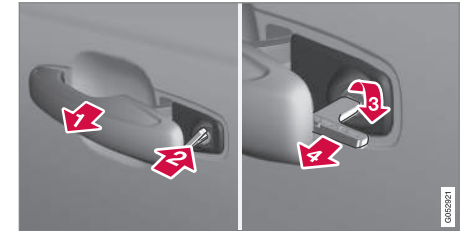

- 1**▶ Pull out the front door handle on the left-hand side<sup>11</sup> to its end position so that the lock cylinder become visible.
- 2**▶ Insert the key in the lock cylinder.
- 3**▶ Turn clockwise 45 degrees so that the key blade is pointing straight back.
- 4**▶ Turn the key back 45 degrees to its starting position. Remove the key from the lock cylinder and release the handle so that the rear section of the handle is resting against the car again.

<sup>11</sup> This applies whether the car is right-hand drive or left-hand drive.

## LOCKS AND ALARM

5. Pull out the handle.  
> The door opens.

Locking will be performed in the same way, but with an anticlockwise turn 45 degrees instead of clockwise in step (3).

### Switching off the alarm\*

#### **i** NOTE

When the door is unlocked using the key blade and is then opened, the alarm is triggered.



The backup reader's location in the cup holder.

Deactivate the alarm as follows:

1. Place the remote control key in the backup reader in the bottom of the cup holder in the tunnel console.

2. Then turn the start knob to **START** and release it.  
> The control automatically returns to its starting position - the alarm signal stops and the alarm switches off.

### Locking

It is also possible to lock the car with the remote control key's detachable key blade e.g. in the event of a loss of power or if the key's battery has become discharged.

The left-hand front door can be locked with its lock cylinder and the detachable key blade.

Other doors have no lock cylinders and instead have a lock switch on the end of each door which must be depressed using the key blade - they are then mechanically locked/blocked to prevent them being opened from outside.

The doors can still be opened from the inside.

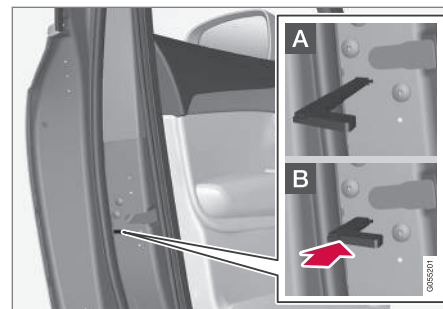

Manual locking of the door. Not to be mixed up with the child safety locks.

- Remove the detachable key blade from the remote control key. Insert the key blade in the hole for lock reset and press the key in until the key bottoms, approx. 12 mm.
- A** The door can be opened from both the outside and the inside.
- B** The door is blocked against opening from the outside. To return to position A, the inner door handle must be opened.
- The doors can also be unlocked with the unlock button on the remote control key or with the central locking button on the driver's door.



**i NOTE**

- A door's lock reset only locks that particular door - not all doors simultaneously.
- A manually locked rear door with activated manual or electric child safety locks cannot be opened from either the outside or the inside. A rear door that is locked in this way can only be unlocked with the remote control key or central locking button.

**Related information**

- Detachable key blade (p. 248)

**Power operated tailgate\***

The car's tailgate can be opened/closed electrically.

Opening/closing via a foot movement is also available as an extended option - see the section "Opening/closing the power operated tailgate with foot movement" for more information.



**Opening**

The tailgate can be opened with its handle, with foot movement\*, a button on the instrument panel or the remote control key.



Opening/closing button on the instrument panel.



Choose one of the following options to open the tailgate:

- Light press on the tailgate handle.
- Long press on the instrument panel's  button. Keep it depressed until the tailgate starts to open.
- Long press on the remote control key's  button. Keep it depressed until the tailgate starts to open.

**Closing**

The tailgate can be closed via the instrument panel's button, with foot movement\*, with the remote control key or the buttons<sup>12</sup> along the bottom edge of the tailgate.

Choose one of the following options to close the tailgate.

- Long press on the instrument panel's  button or the remote control key's  button.
  - > The tailgate closes automatically and acoustic signals sound - the tailgate remains unlocked.

<sup>12</sup> A car with keyless locking/entry (Passive Entry\*) has one button for closing and one button for closing and locking.



Button for closing and locking on the underside of the tailgate.

- Press the button<sup>12</sup> on the underside of the tailgate to close.
- > The tailgate closes automatically - the tailgate remains unlocked.

**i NOTE**

The button is active 24 hours after the hatch has been left open. Thereafter, it must be closed manually.

- Press the button<sup>12</sup> on the underside of the tailgate to close it and simultaneously lock the tailgate and doors (all doors must be closed for locking).
- > The tailgate closes automatically - the tailgate and doors are locked, and the alarm\* is armed.

**i NOTE**

If the remote key is not detected sufficiently close to the tailgate, locking/unlocking will not work. See the section "Remote key range" for more information.

**i NOTE**

When using key-free\* blocking/closing, three signals will sound if the key is not detected sufficiently close to the tailgate. See the sections "Remote key range" and "Locks and remote keys" for more information.

**! IMPORTANT**

During manual tailgate operation, open or close it slowly. Do not use force to open/close it if there is resistance. It may be damaged and stop working correctly.

**Cancel opening/closing**

- There are five ways to cancel opening/closing:
  - Press the button on the instrument panel.
  - Press the remote control key's button.
  - Press the close button<sup>12</sup> along the bottom edge of the tailgate.
  - Press the rubberised pressure plate beneath the outside handle.
  - Using the foot movement\* (see section "Opening/closing power operated tailgate with foot movement" for more information).
- > Tailgate movement will be interrupted and the tailgate will stop and can then be manoeuvred manually.

**Programmable max. opening**

The maximum opening position of the tailgate can be adjusted, e.g. to suit a low ceiling height in a garage.

To adjust max. opening:

1. Open the tailgate - stop it in the open position.

<sup>12</sup> A car with keyless locking/entry (Passive Entry\*) has one button for closing and one button for closing and locking.

2. Press the  button on the underside of the tailgate for at least 3 seconds.
  - > Two short acoustic signals sound to indicate that the set position has been saved.

To reset max. opening:

- Manually move the tailgate to its highest possible position - press the  button on the tailgate for at least 3 seconds.
  - > Two acoustic signals sound to indicate that the set position has been cleared. The tailgate will then assume its max. position when opened.

#### NOTE

- If the system has been operating continuously for a long time, it is switched off to avoid overload. It can be used again after about 2 minutes.

#### Pinch protection

If something with sufficient resistance prevents the tailgate from opening/closing then the pinch protection is activated.

- During opening - movement is interrupted, the tailgate stops and a long acoustic signal sounds.
- During closing - movement is interrupted, the tailgate stops, a long acoustic signal sounds and the tailgate returns to the programmed max. position.

#### WARNING

Observe the risk of trapping when opening/closing. Before starting opening/closing, check that there is nobody near to the tailgate as trapping may have serious consequences. Always operate the tailgate with caution.

#### Pre-tensioned springs

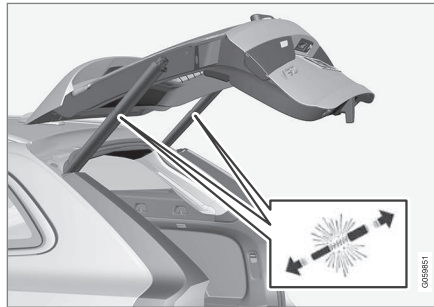

The pre-tensioned springs for the power operated tailgate.

#### WARNING

Do not open the pre-tensioned springs for the power operated tailgate. They are pre-tensioned with high pressure and can cause injury if opened.

#### Related information

- Opening/closing the tailgate with foot movement\* (p. 254)
- Remote control key range (p. 236)

## Opening/closing the tailgate with foot movement\*

To facilitate the operation of the tailgate when your hands are occupied, it can be opened/closed by means of a forward kicking motion under the rear bumper.

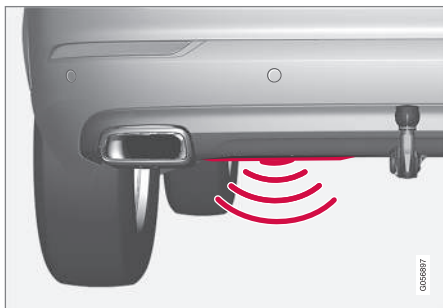

The sensor is positioned to the left of centre in the bumper<sup>13</sup>.

One of the car's remote control keys must be within range<sup>14</sup> behind the car in order for opening/closing to be possible. This also applies to an already unlocked car in order to avoid accidental opening e.g. in a car wash.

## Operation



Kicking motion within the detector's valid activation area.

## Opening/closing

### **i** NOTE

The foot-operated tailgate function is available in two versions:

- Opening and closing with foot movement
- Only unlocking with foot movement (lift up the tailgate manually to open it)

Note that the function for opening and closing with foot movement requires the "Power operated tailgate"\* option.

- Make **one** slow, forward kicking motion under the left part of the rear bumper. Then take a step back. The bumper must not be touched.
- > A short acoustic signal sounds when opening/closing is activated - the tailgate is opened/closed.

If the tailgate is on open position then it is always closed on activation via foot movement.

The tailgate can also be closed via the instrument panel's button, the remote control key or the button(s)<sup>15</sup> under the tailgate. For more information, see the section "Power operated tailgate".

If several kicking motions take place without an approved remote control key being located behind the car, opening will not be possible until after a certain delay.

Do not leave your foot positioned under the car during the kicking motion. This could cause activation to fail.

## Cancel opening/closing

- Make **one** slow forward kicking motion when opening/closing is in progress in order to stop the movement of the tailgate.

The remote control key does not have to be in the vicinity of the car to cancel opening/closing.

<sup>13</sup> If the car is equipped with skid plate/diffuser\* then the detector is positioned out towards the left-hand corner of the bumper.

<sup>14</sup> See the section "Remote control key range" for more information.

<sup>15</sup> Only applies to a car equipped with keyless locking/entry (Passive Entry)\*.

**i NOTE**

There is a risk of reduced function, or no function, if the rear bumper is loaded with large amounts of ice, snow, dirt or similar. For this reason, make sure you keep it clean.

**i NOTE**

Pay attention to the possibility that the system may be activated in a car wash or similar if the remote key is within range.

**Related information**

- Locking/unlocking the tailgate (p. 245)
- Power operated tailgate\* (p. 251)
- Remote control key range (p. 236)

**Replacing the battery in the remote control key**

The battery in the remote control key needs to be replaced when it has become discharged.

**i NOTE**

All batteries have a limited service life and must eventually be replaced (does not apply to Key Tag). The service life of the battery varies depending on how often the vehicle/key is used.

The battery for the remote control key should be replaced if:



the information symbol illuminates and the message **Car key battery low** See **Owner's manual** is shown in the driver display

and/or

- the locks repeatedly do not react to signals from the remote control key within 20 metres from the car.

**i NOTE**

Always try moving closer to the car and making another unlock attempt.

The battery in the button-less key<sup>16</sup> (Key Tag) cannot be replaced - a new key can be ordered from an authorised Volvo workshop.

**! IMPORTANT**

A discharged Key Tag must be handed over to an authorised Volvo workshop. The key must be deleted from the car since it is still possible to use it to start the car via back-up start.

<sup>16</sup> This key is supplied with a car equipped with the keyless locking/entry option (Passive Entry\*).

◀ Opening and changing



- 1 Hold the remote control key with the front visible and the Volvo logo facing the right way - slide the button at bottom edge by the key ring to the right. Slide the front side's shell a few millimetres upwards.
   
 The shell will then come free and can be lifted off the key.

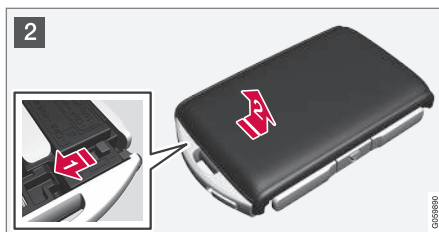

- 2 Move the button to the side and slide the back shell a few millimetres upwards.
   
 The shell will then come free and can be lifted off the key.

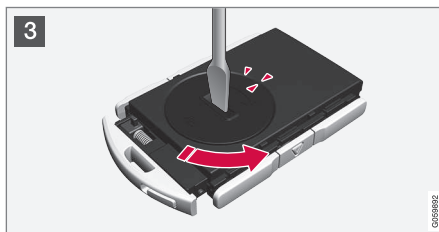

- 3 Use a screwdriver or similar to turn the battery cover anticlockwise until the markings meet at the **OPEN** text. Carefully lift away the battery cover by pressing e.g. a fingernail into the recess. Then prize the battery cover upwards.

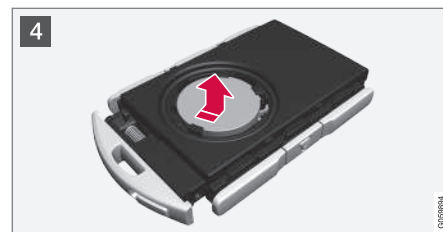

- 4 The battery (+) side is facing upwards. Then carefully prize loose the battery as illustrated.

**IMPORTANT**  
 Avoid touching new batteries and their contact surfaces with your fingers as this may impair their function.

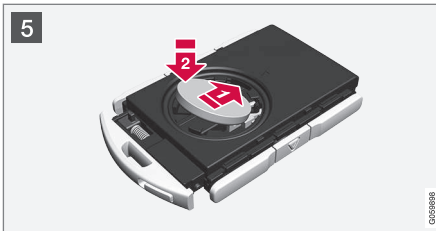

- 5 Install a new battery with the (+) side up. Avoid touching the remote control key's battery contacts with your fingers.

1 Place the battery in the holder with the edge down. Then slide the battery forwards so that it fastens under the two plastic catches.

2 Press the battery down so that it fastens under the upper black plastic catch.

**i NOTE**

Use batteries with the designation CR2032, 3 V.

**i NOTE**

Volvo recommends that the batteries to be used in the remote control key fulfil UN Manual of Test and Criteria, Part III, subsection 38.3. Batteries fitted in the factory or replaced by an authorised Volvo workshop fulfil the above criteria.

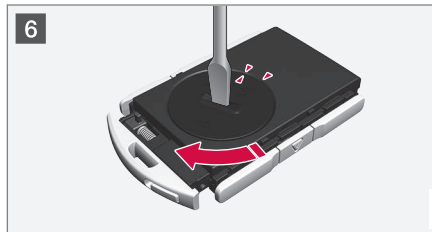

- 6 Refit the battery cover and turn it clockwise until the marking aligns with the **CLOSE** text.



- 7 1 Reposition the rear side's shell and press it down until a clicking sound can be heard.
- 2 Then slide the shell back sedan.
- > A further click will indicate that the shell is properly positioned and securely attached.



8 Turn the remote control key over and refit the front side's shell by pressing it down until a clicking sound can be heard.

Then slide the shell back sedan.

> A further click will indicate that the shell is securely attached.

**! IMPORTANT**

Make sure that exhausted batteries are disposed of in a manner which is kind to the environment.

**Related information**

- Remote control key (p. 234)

**Immobiliser**

The electronic immobiliser is a theft protection system that prevents an unauthorised person from starting the car.

The car can only be started with the correct remote control key.

The following error message in the driver display is related to the electronic immobiliser:

Symbol	Message	Specification
	<b>Car key not found</b> See Owner's manual	Error reading the remote control key during starting - place the key in the cup holder near the key symbol and try again.

**Remote-controlled immobiliser with tracking system<sup>17</sup>**

The car is fitted with a system which makes it possible to track and locate the car and to remotely activate the immobiliser, which prevents starting the engine. Contact your nearest Volvo dealer for more information and assistance with activating the system.

The following error message in the driver display is related to the remote-controlled immobiliser with tracking system:

Symbol	Message	Specification
	<b>Remotely immobilised</b> <b>Car not possible to start</b>	The remote-controlled immobiliser with tracking system is activated. The car cannot be started. Contact Volvo On Call Service Centre.

**Related information**

- Remote control key (p. 234)
- Remote control key range (p. 236)

<sup>17</sup> Only certain markets and in combination with Volvo On Call\*.



## Child safety locks

The child safety locks prevent children from being able to open a rear door from the inside. There is an electric\* and a manual lock.

### Electric activation/deactivation\*

The electric child safety locks can be activated/deactivated in all ignition positions higher than 0. Activation/deactivation can be performed up to 2 minutes after switching off the engine, provided that no door is opened. See the section "Ignition position" for more information.



Button for electric activation/deactivation.

1. Start the engine or choose an ignition position higher than 0.

2. Press the button in the driver's door control panel.
  - > The driver display shows the message **Rear child lock Activated** and the button's lamp illuminates - the locks are active.

When the electric child safety lock is active then the rear:

- windows can only be opened with the driver's door control panel
- doors cannot be opened from inside.

To deactivate the locks:

- Press the button in the driver's door control panel.
  - > The driver display shows the message **Rear child lock Deactivated** and the button's lamp goes out - the locks are deactivated.

The current setting is stored when the engine is switched off - if the child safety locks are activated at engine shutdown, the function will remain activated the next time the engine is started.

Symbol	Message	Specification
	<b>Rear child lock Activated</b>	Child safety locks are activated.
	<b>Rear child lock Deactivated</b>	Child safety locks are deactivated.

### Manual activation/deactivation

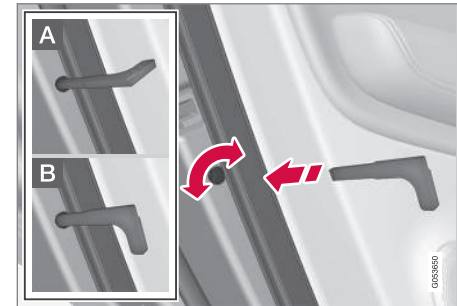

Manual child safety locks. Not to be mixed up with manual door locks.

- Use the remote control key's detachable key blade to turn the knob. For more information, see the section "Detachables key blade".

- ◀◀ **A** The door is blocked against opening from the inside.
- B** The door can be opened from both the outside and the inside.

**i NOTE**

- A door's knob control only blocks that particular door - not both rear doors simultaneously.
- Cars with an electric child safety lock do not have a manual child lock.

**Related information**

- Detachable key blade (p. 248)
- Ignition positions (p. 383)

**Alarm\***

The alarm alerts e.g. in the event of a break-in in the car.

When armed, the alarm is triggered if:

- a door, the bonnet or the tailgate is opened<sup>18</sup>
- a movement is detected in the passenger compartment (if fitted with a movement detector\*)
- the car is raised or towed away (if fitted with a tilt detector\*)
- the starter battery's cable is disconnected or
- the siren is disconnected.



If there is a fault in the alarm system, the driver display shows the symbol and the message **Alarm system failure Service required**. In which

case, contact a workshop - an authorised Volvo workshop is recommended.

**i NOTE**

Do not attempt to repair or alter components in the alarm system yourself. Any such attempts may affect the terms of the insurance.

**i NOTE**

The movement sensors trigger an alarm in the event of movement in the passenger compartment - air currents are also registered. For this reason the alarm is triggered if the car is left with a window or the panoramic roof\* open or if the passenger compartment heater is used.

To avoid this: Close the window/panoramic roof when leaving the car. If the car's integrated parking heater (or a portable electric heater) shall be used - direct the airflow from the air vents so that they are not pointing upwards into the passenger compartment. Alternatively, reduced alarm level can be used - see the section further down in this article.

**Arming the alarm**

Lock and arm the car alarm as follows:

- press the remote control key's lock button
- touch in the marked area on the outside of the door handle<sup>19</sup> or
- push on the tailgate's rubberised pressure plate<sup>19</sup>.

If the car is equipped with a power-operated tailgate, the button on the underside of the tailgate can also be used to lock the car and arm the car alarm.

<sup>18</sup> Applies to certain markets.

<sup>19</sup> Only applies to a car with keyless locking/entry (Passive Entry\*)

## Deactivate the alarm

Unlock and disarm the car alarm as follows:

- press the remote control key's unlock button
- grip one of the door handles<sup>19</sup> or
- push on the tailgate's rubberised pressure plate<sup>19</sup>.

## Switching off a triggered alarm

- Press the remote control key's unlock button or set the car in ignition position **I** by turning the ignition dial to **START** and then releasing.

### **i** NOTE

- Remember that the alarm is activated when the car is locked.
- If any of the doors are opened from the inside then the alarm is triggered.

## Alarm signals

When the alarm has been triggered, the following happens:

- A siren sounds for 30 seconds or until the alarm is switched off.
- The direction indicators flash for 5 minutes or until the alarm is switched off.

If the cause of alarm activation is not rectified, the alarm cycle is repeated up to 10 times<sup>20</sup>.

## Lock and alarm indicator

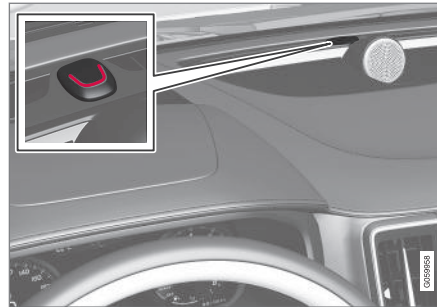

A red LED on the instrument panel indicates the alarm system's status:

- LED not lit – alarm not armed.
- The LED flashes once every other second – alarm is armed.
- After the alarm has been disarmed, the LED flashes rapidly for up to 30 seconds or until ignition position **I** has been selected by turning the ignition dial to **START** and releasing it - the alarm has been triggered.

## Reduced alarm level

Reduced guard means that the movement and tilt detectors can be temporarily deactivated.

Switch off the movement and tilt detectors in order to avoid accidental triggering of the alarm - e.g. if a dog is left in a locked car or during transport on a car train or car ferry. The procedure is the same as with the temporary disengaging of the deadlocks function.



Press the **Reduced guard** button in the centre display's function view in order to switch off the movement and tilt detectors temporarily.

For more information, see the section "Deadlocks".

## Related information

- Automatic arming/rearming of the alarm\* (p. 262)
- Disarming the alarm\* without working remote control key (p. 262)
- Deadlocks\* (p. 244)

<sup>19</sup> Only applies to a car with keyless locking/entry (Passive Entry\*)

<sup>20</sup> Applies to certain markets.

## Automatic arming/rearming of the alarm\*

Automatic rearming of the alarm prevents the car being left with the alarm disarmed unintentionally.

If the car is unlocked with the remote control key (which disarms the alarm) but none of the doors or the tailgate is opened within two minutes, then the alarm is automatically re-armed. The car is relocked at the same time.

In certain markets, the alarm is re-armed automatically after a certain delay after the driver's door has been opened and closed without being locked.

### Related information

- Alarm\* (p. 260)
- Disarming the alarm\* without working remote control key (p. 262)

## Disarming the alarm\* without working remote control key

The car can be unlocked and disarmed even if the remote control key does not work, e.g. if the remote control key's battery is dead.

1. Open the driver's door with the detachable key blade.
  - > The alarm is triggered.



The backup reader's location in the cup holder.

2. Place the remote control key in the backup reader in the tunnel console's cup holder.
3. Turn the ignition dial to **START** and release.
  - > The alarm is deactivated.

### Related information

- Alarm\* (p. 260)
- Automatic arming/rearming of the alarm\* (p. 262)
- Detachable key blade (p. 248)
- Starting the car (p. 384)

## Type approval for the remote control key system

Type approval for the remote control key system can be read in the table.

## Lock system keyless start (Passive Start) and keyless locking/unlocking (Passive Entry\*)

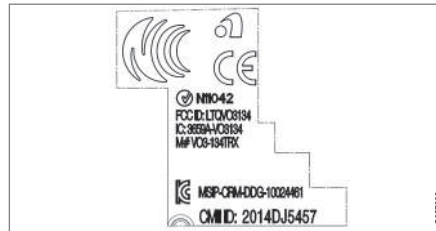

CEM marking for the remote control key system. For supplementary type approval number, see the table below.

Country/Area	Type approval	
Jordan	TRC/LPD/2014/250	
Serbia	P1614120100	
Argentina	CNC ID: C-14771	

LOCKS AND ALARM



Country/Area	Type approval	
Brazil	MT-3245/2015	
Indonesia	Nomor: 38301/SDPPI/2015	
Malaysia	RAAT/37A/0315/S(15-0663)	
Mexico	IFETEL: RLVDEVO15-0396	
Russia		
The United Arab Emirates	ER37847/15 DA0062437/11	

For more information about type approval for the remote control key system, see [support.volvocars.com](http://support.volvocars.com).

**Remote control key**

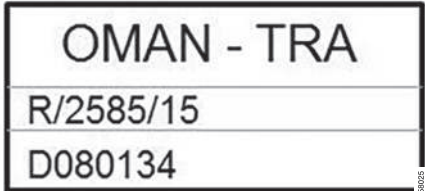
Country/Area	Type approval	
Jordan	TRC/LPD/2015/104	
Morocco	AGREE PAR L'ANRT MAROC Numéro d'agrément: MR 10668 ANRT 2015 Date d'agrément: 24/07/2015	
Mexico	IFETEL Marca: HUF Modelo (s): HUF8423 NOM-121-SCT1-2009 La operación de este equipo está sujeta a las siguientes dos condiciones: (1) es posible que este equipo o dispositivo no cause interferencia perjudicial y (2) este equipo o dispositivo debe aceptar cualquier interferencia, incluyendo la que pueda causar su operación no deseada.	
Oman		 <p>OMAN - TRA R/2585/15 D080134</p> <p style="text-align: right; font-size: small;">01/06/2015</p>

LOCKS AND ALARM



Country/Area	Type approval	
Serbia		
The United Arab Emirates		



**Key Tag**

Country/Area	Type approval	
Jordan	TRC/LPD/2015/107	
Morocco	AGREE PAR L'ANRT MAROC Numéro d'agrément: MR 10667 ANRT 2015 Date d'agrément: 24/07/2015	

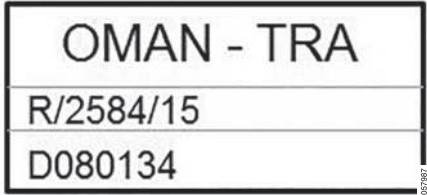

Country/Area	Type approval	
Mexico	IFETEL Marca: HUF Modelo (s): HUF8432 NOM-121-SCT1-2009 La operación de este equipo está sujeta a las siguientes dos condiciones: (1) es posible que este equipo o dispositivo no cause interferencia perjudicial y (2) este equipo o dispositivo debe aceptar cualquier interferencia, incluyendo la que pueda causar su operación no deseada.	
Oman		 <p>OMAN - TRA R/2584/15 D080134</p>

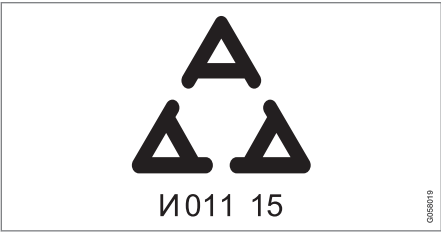

Country/Area	Type approval	
Serbia		 <p style="text-align: right; font-size: small;">01058119</p>
The United Arab Emirates		 <p style="text-align: right; font-size: small;">01058122</p>

**Related information**

- Remote control key (p. 234)

DRIVER SUPPORT

## Speed-dependent steering force

Speed related power steering causes the steering wheel force to increase with the speed of the car in order to give the driver enhanced sensitivity.

On motorways the steering feels firmer. When parking and at low speed steering is light and requires only a slight effort.

### NOTE

In certain situations the power steering may become too hot and then needs to be temporarily cooled - during this time the power steering operates with reduced power and turning the steering wheel may then be perceived to be slightly heavier.

In parallel with the temporarily reduced steering assistance, the driver display shows a message.

## Change the steering force level\*

To select the steering force level, go to the "Drive modes" section and see the description at the alternative INDIVIDUAL under the heading "Selectable drive modes".

For the car models without a drive mode control with its INDIVIDUAL option, the selection of steering force is instead made via the centre display's top view and the following search path:

Settings → My Car → Drive Modes → Steering force

Selection of steering force is not accessible while turning is in progress.

### Related information

- Drive modes\* (p. 398)

## Roll Stability Control

Roll Stability Control (RSC) is a stabiliser system that minimises the risk of overturning, for example during sudden evasive manoeuvres or if the car skids.

The RSC system registers if and how much the car's lateral inclination changes. This information is used to calculate the risk of the car overturning. If the car is at risk, its electronic stability control system engages, the engine torque is reduced and one or more wheels are braked until the car has regained its stability.

### WARNING

Under normal driving conditions, the RSC system improves the car's road safety, but this must not be taken as a reason to increase speed. Always follow the normal precautions for safe driving.

### Related information

- Electronic stability control (p. 271)
- Safety (p. 56)

## Electronic stability control

Electronic stability control (Electronic Stability Control — ESC) helps the driver to avoid skidding and improves the car's traction.



The activation of the ESC system during braking may be noticed as a throbbing sound. The car may accelerate slower than expected when the accelerator pedal is depressed.

### WARNING

The stability system ESC is supplementary assistance - it cannot handle all situations in all road conditions.

The driver always bears responsibility that the vehicle is driven safely and that applicable road traffic rules and regulations are followed.

The ESC system consists of the following functions:

- Active Yaw Control
- Spin Control
- Traction control system
- Engine Drag Control
- Trailer stability assist

## Active Yaw Control

The function checks the driving and brake force of the wheels individually in order to stabilise the car.

## Spin Control

The function prevents the driving wheels from spinning against the road surface during acceleration.

## Traction control system

The function is active at low speed and transfers power from the driving wheel that is spinning to the one that is not.

## Engine Drag Control

Engine Drag Control (Engine Drag Control — EDC) prevents involuntary wheel locking, e.g. after shifting down or engine braking when driving in low gear on slippery road surfaces.

Involuntary wheel locking while driving can, amongst other things, impair the driver's ability to steer the car.

## Trailer stability assist\*<sup>1</sup>

The function of trailer stability assist (Trailer Stability Assist - TSA) is to stabilise a car with attached trailer in situations where snaking occurs. For more information, see the "Driving with a trailer" section.

### NOTE

The TSA function is deactivated if sport mode is activated.

## Related information

- Sport mode for electronic stability control (p. 272)
- Symbols and messages for electronic stability control (p. 273)
- Roll Stability Control (p. 270)
- Driving with a trailer (p. 426)

<sup>1</sup> Trailer stability assist is included when installing the Volvo genuine towbar.

## Sport mode for electronic stability control

Electronic stability control (Electronic Stability Control — ESC) helps the driver to avoid skidding and improves the car's traction.

The ESC system is always activated — it cannot be switched off. However, the driver can select Sport mode, which allows for a more active driving experience.

In Sport mode the ESC system detects whether the accelerator pedal, steering wheel movements and cornering are more active than in normal driving and then allows a certain degree of controlled skidding with the rear section before ESC intervenes and stabilises the car.

For example, if the driver stops a controlled skid by releasing the accelerator pedal, the ESC system intervenes and stabilises the car.

Sport mode also provides maximum traction if the car has become bogged down or is driving on a loose surface, such as sand or deep snow.

### Select/deselect Sport mode



The Sport mode is activated/deactivated in the centre display's function view.

- Tap on the **ESC Sport Mode** button in function view.
  - > Sport mode is activated/deactivated, a green/grey indicator is displayed in the button.



The driver display indicates Sport mode by displaying this symbol with a constant glow until the function is deactivated or the engine is switched off. The next time the engine is started, the ESC system is back in its normal mode again.

### Limitations for Sport mode

The **ESC Sport Mode** function cannot be selected when one of the functions from speed limiter, cruise control or adaptive cruise control is activated.

### Related information





- Electronic stability control (p. 271)
- Speed limiter\* (p. 275)
- Cruise control (p. 282)
- Adaptive cruise control\* (p. 288)

## Symbols and messages for electronic stability control

A number of symbols and messages regarding electronic stability control (Electronic Stability

Control -ESC) can be shown on the driver display.

The following table shows some examples.

Symbol	Message	Specification
	Constant glow for approx. 2 seconds.	System check when the engine is started.
	Flashing light.	ESC system is being activated.
	Constant glow.	Sport mode is selected. <b>NOTE:</b> The ESC system is not deactivated in this mode — it is partly reduced.
	<b>ESC</b> <b>Temporarily off</b>	ESC system has been temporarily reduced due to excessive brake temperature - the function is reactivated automatically when the brakes have cooled.
	<b>ESC</b> <b>Service required</b>	ESC system disengaged. <ul style="list-style-type: none"> <li>• Stop the car in a safe place, switch off the engine and start it again.</li> <li>• Visit a workshop if the message remains - an authorised Volvo workshop is recommended.</li> </ul>

◀◀ **Related information**

- Electronic stability control (p. 271)
- Sport mode for electronic stability control (p. 272)
- Managing messages in the driver display and the centre display (p. 109)



## Speed limiter\*

A speed limiter (Speed Limiter — SL) can be regarded as a reverse cruise control — the driver regulates the speed using the accelerator pedal but is prevented by the speed limiter from accidentally exceeding a pre-selected/preset maximum speed.

### Overview

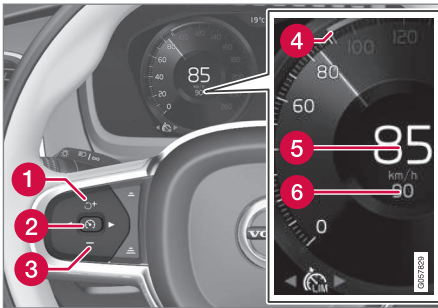

Buttons and symbols for functions<sup>2</sup>.

- 1 Increase the stored maximum speed or reactivate the speed limiter and resume the stored maximum speed
- 2 Activate the speed limiter and store the current speed, or deactivate the speed limiter
- 3 Reduces stored maximum speed
- 4 Marker for stored max speed

- 5 The car's current speed
- 6 Stored maximum speed

### WARNING

The Speed Limiter is an aid and cannot deal with all traffic, weather and road conditions.

The driver must always pay attention to traffic conditions and take action when the Speed Limiter is not maintaining a suitable speed.

The driver always has the ultimate responsibility for the car being driven safely and in accordance with applicable traffic rules and regulations, even when the Speed Limiter function is in use.

### Limitations

On steep downhill gradients the speed limiter's braking effect may be inadequate and hence the stored maximum speed may be exceeded. In this case, the driver is alerted by the message **Speed limit exceeded** in the driver display.

### NOTE

A text message that the maximum speed is exceeded will be activated if the speed has been exceeded by at least 3 km/h (approx. 2 mph).

### Related information

- Activating and starting the speed limiter (p. 276)
- Managing speed for the speed limiter (p. 276)
- Deactivating/reactivating the speed limiter (p. 277)
- Switching off the speed limiter (p. 278)
- Automatic speed limiter\* (p. 279)

<sup>2</sup> NOTE: The illustration is schematic - details may vary depending on car model.

## Activating and starting the speed limiter

The speed limiter function (Speed Limiter - SL) must first be selected and activated in order to be able to regulate the speed.

### Activate the speed limiter

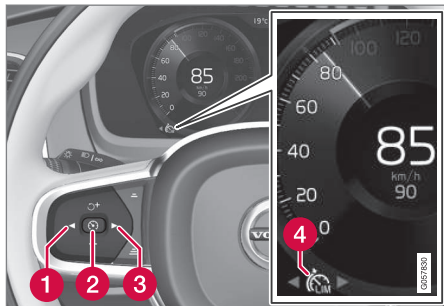



NOTE: The illustration is schematic - details may vary depending on car model.

- Press ◀ (1) or ▶ (3) to browse to the symbol/function  (4).
  - > The symbol is shown and the speed limiter can then be activated.

### Start the speed limiter

The lowest maximum speed that can be stored is 30 km/h (20 mph).

- With the symbol/function  displayed, press the steering wheel button  (2).
  - > The speed limiter starts and the current speed is stored as the maximum speed.

### Related information



- Speed limiter\* (p. 275)
- Managing speed for the speed limiter (p. 276)
- Deactivating/reactivating the speed limiter (p. 277)
- Switching off the speed limiter (p. 278)

## Managing speed for the speed limiter

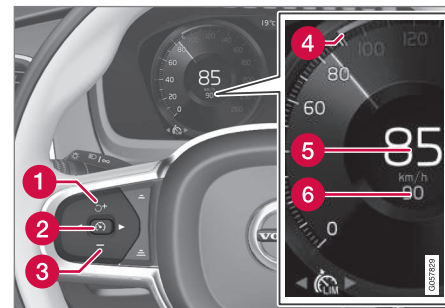
The speed limiter (Speed Limiter - SL) can be set to different speeds.



NOTE: The illustration is schematic - details may vary depending on car model.

- Change the stored maximum speed with short or long presses on the steering wheel button  (1) or  (3):
  - Use **short presses** to adjust +/- 5 km/h (+/- 5 mph) with **each press**.
  - **Hold the button depressed** to adjust +/- 1 km/h (+/- 1 mph) and **release** when the driver display's marking (4)/(6) is **at the desired speed**.
    - > The speed set after the last press is stored in the memory.

## Related information

- Speed limiter\* (p. 275)
- Activating and starting the speed limiter (p. 276)
- Deactivating/reactivating the speed limiter (p. 277)
- Switching off the speed limiter (p. 278)

## Deactivating/reactivating the speed limiter

The speed limiter (Speed Limiter - SL) can be temporarily deactivated so that it is set in the standby mode and can be reactivated later.

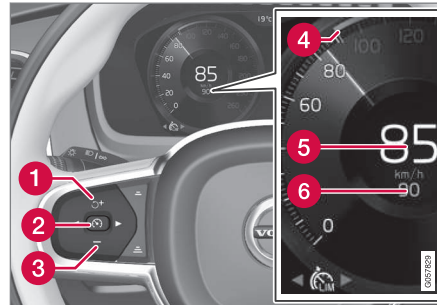

NOTE: The illustration is schematic - details may vary depending on car model.

### Deactivate the speed limiter and set it in standby mode

- Press the steering wheel button  (2).
  - > The speed limit markings and symbols in the driver display change colour from WHITE to GREY - the speed limiter is now temporarily deactivated and the driver can exceed the maximum speed setting.

### Reactivating the speed limiter from standby mode

- Press the steering wheel button  (1).
  - > The driver display's speed limit markings change colour from GREY to WHITE - the car's speed is then limited again by the last stored maximum speed.

or

- Press the steering wheel button  (2).
  - > The speed limiter indicators and symbols in the driver display change colour from GREY to WHITE — the car will now apply its current speed as the maximum speed.

### Temporary increase in speed with the accelerator pedal

The speed limiter can also be temporarily overridden with the accelerator pedal without the speed limiter being set in standby mode - e.g. to be able to quickly accelerate the car out of a situation. In which case, proceed as follows:

1. Fully depress the accelerator pedal and release it so that acceleration is interrupted when the desired speed has been reached.
  - > In this case, the speed limiter is still activated and the driver display's symbol is therefore WHITE.
2. Fully release the accelerator pedal when the temporary acceleration is finished.
  - > The car is then braked automatically below the last stored maximum speed.



#### ◀ Related information

- Speed limiter\* (p. 275)
- Activating and starting the speed limiter (p. 276)
- Managing speed for the speed limiter (p. 276)
- Switching off the speed limiter (p. 278)

### Switching off the speed limiter

The speed limiter Speed Limiter — SL can be deactivated.

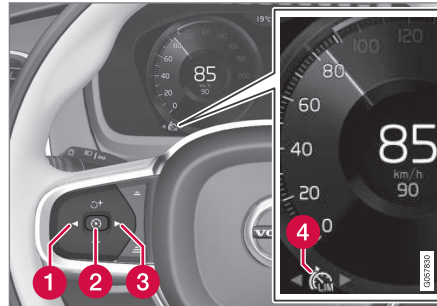

NOTE: The illustration is schematic - details may vary depending on car model.

1. Press the steering wheel button (2).  
> The speed limiter is set in standby mode.
2. Press the steering wheel button (1) or (3) to change to another function.  
> The driver display's symbol and indicator for speed limiter (4) are switched off - which deletes the set/stored maximum speed.
3. Press the steering wheel button (2) again.  
> Another function is activated.

#### Related information

- Speed limiter\* (p. 275)
- Activating and starting the speed limiter (p. 276)
- Managing speed for the speed limiter (p. 276)
- Deactivating/reactivating the speed limiter (p. 277)

### Automatic speed limiter\*

The automatic speed limiter (Automatic Speed Limiter - ASL) function helps the driver to adapt the car's maximum speed to the speed shown on the road signs.

The speed limiter function (Speed Limiter — SL) can be changed to automatic speed limiter.

The automatic speed limiter uses speed information from the Road Sign Information<sup>3</sup> function to automatically adapt the car's maximum speed.

**⚠ WARNING**



The automatic speed limiter function is an aid, and does not work in all driving situations, traffic, weather and road conditions. The driver always bears responsibility for maintaining the correct distance and speed, as well as when the automatic speed limiter is being used.

Even if the driver clearly sees the speed-related road sign, the speed from the Road sign information function may be incorrect - in such cases the driver must intervene him/herself and accelerate or brake to a suitable speed.

See also the heading "Limitations for Road sign information".

### Is SL or ASL active?

Symbols in the driver display show which speed limiter function is active:

Symbol	SL	ASL
 A	✓	✓
 Sign symbol <sup>B</sup> after "70" = ASL is activated.		✓

A WHITE symbol: Function active, GREY symbol: Standby mode.  
 B See the following heading "ASL symbol" regarding the meaning of the symbol's colour.

### The ASL symbol

 The sign symbol (displayed alongside the stored speed, "70", in the centre of the speedometer) can be shown in three colours with the following meanings:

ings:

Colour of sign symbol	Meaning
Greenish yellow	ASL is active
Grey	ASL has been set in standby mode
Amber/Orange	ASL is in temporary standby mode <sup>A</sup>

A For example, scanning of a sign failed.

### Limitations of ASL

Automatic speed limitation takes place using speed information from the RSI<sup>3</sup> function - not from the speed limit road signs that the car passes.

If RSI<sup>3</sup> cannot interpret and provide speed information to the ASL, then the ASL is set in standby mode and changes over to SL. In such cases the driver must intervene and brake to a suitable speed.

The ASL will be reactivated when the RSI<sup>3</sup> function can once again interpret and provide speed information to the ASL.

See also the heading "Limitations for Road Sign Information".

<sup>3</sup> Road Sign Information – RSI



#### ◀ Related information

- Speed limiter\* (p. 275)
- Activating/deactivating the automatic speed limiter (p. 280)
- Changing the tolerance for the Automatic speed limiter (p. 281)
- Road Sign Information\* (p. 346)
- Limitations of Road Sign Information\* (p. 350)

### Activating/deactivating the automatic speed limiter

The automatic speed limiter function (Automatic Speed Limiter - ASL) can be activated and deactivated as a supplement to the speed limiter (Speed Limiter - SL).



The function is activated/deactivated in function view in the centre display.

#### Activating the automatic speed limiter

1. Tap on the **Speed Sign Assist** button in function view.
  - > ASL is set in standby mode, a green indicator appears on the button, and the driver display shows a sign symbol in the centre of the speedometer.
2. Press the steering wheel button .
- > ASL is activated with the car's current speed.

### Deactivating the automatic speed limiter

- Tap on the **Speed Sign Assist** button in function view.
  - > ASL is deactivated and the button's indication becomes GREY - SL is activated instead.

#### **WARNING**

After switching from ASL to SL the car will no longer follow the signed speed limit but only the maximum speed stored in memory.

#### Related information

- Automatic speed limiter\* (p. 279)
- Changing the tolerance for the Automatic speed limiter (p. 281)

## Changing the tolerance for the Automatic speed limiter

The speed limiter function (Automatic Speed Limiter - ASL) can be set for different tolerance levels.

It is possible to increase/decrease the signed speed limit. If, for example, the car follows a signed speed limit of 70 km/h (43 mph) the driver can instead choose to allow the car to maintain 75 km/h (47 mph).

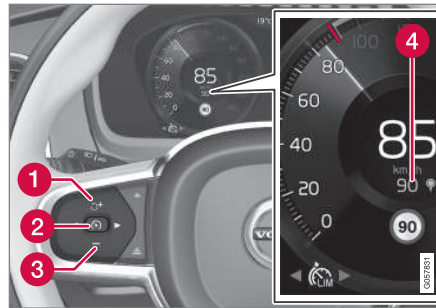

Buttons and symbols for functions.

- Press the steering wheel button **+** (1) until 70 km/h (43 mph) in the centre of the speedometer (4) changes to 75 km/h (47 mph).
  - > After which, the car uses the selected tolerance 5 km/h (4 mph) as long as signs passed are showing 70 km/h (43 mph).

The tolerance is followed until a road sign with a lower or higher speed is passed - then the car follows the new signed speed limit instead and the tolerance is deleted from the memory.

If the Road Sign Information\* function is activated, the signed speed limit will then be shown with a RED indicator on the speedometer.

The tolerance is adjusted in the same way as the speed setting is in the speed limiter.

### **i** NOTE

The maximum selectable tolerance is +/- 10 km/h (5 mph).

### Related information

- Automatic speed limiter\* (p. 279)
- Activating/deactivating the automatic speed limiter (p. 280)
- Road Sign Information\* (p. 346)
- Managing speed for the speed limiter (p. 276)

## Cruise control

The cruise control (Cruise Control - CC) helps the driver maintain an even speed, resulting in a more relaxed driving on motorways and long, straight roads in regular traffic flows.

### Overview

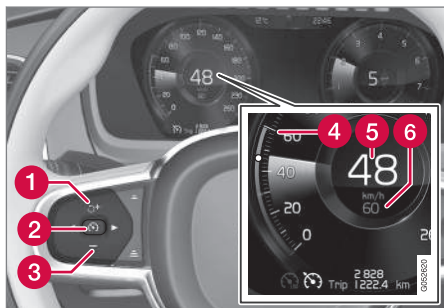

Buttons and symbols for functions.

- 1 Increase the stored speed or reactivate the Cruise control and resume the stored speed
- 2 Activate the Cruise control and store the current speed, or deactivate the Cruise control
- 3 Reduces stored speed
- 4 Marker for stored speed
- 5 The car's current speed
- 6 Stored speed

In cars equipped with the adaptive cruise control option, the driver can change between CC and ACC - see "Change between Cruise control and adaptive cruise control".

### **⚠ WARNING**

The driver must always be observant with regard to the traffic conditions and intervene when the cruise control is not maintaining a suitable speed and/or suitable distance.

The driver always bears ultimate responsibility for ensuring that the vehicle is driven safely.

### Related information

- Activating and starting the Cruise control (p. 282)
- Managing speed for the Cruise control (p. 283)
- Deactivating/reactivating the cruise control (p. 284)
- Deactivating Cruise Control (p. 285)
- Change between Cruise control and adaptive cruise control\* (p. 299)
- Adaptive cruise control\* (p. 288)

## Activating and starting the Cruise control

Cruise control function (Cruise Control - CC) must first be selected and activated in order to be able to regulate the speed.



NOTE: The illustration is schematic - details may vary depending on car model.



### Active Cruise Control

- Press ◀ (1) or ▶ (3) to browse to the symbol/function  (4).
  - > The symbol is shown and the cruise control can then be activated.

### Start Cruise Control

In order to start the Cruise control from the standby mode, the car's current speed must be 30 km/h (20 mph) or higher. The lowest speed that can be stored is 30 km/h (20 mph).



- With the symbol/function  displayed, press the steering wheel button  (2).
  - > Cruise Control starts and the current speed becomes the stored speed.

### **i** NOTE

Cruise Control cannot be enabled at speeds below 30 km/h (20 mph).

### Related information

- Cruise control (p. 282)
- Managing speed for the Cruise control (p. 283)
- Deactivating/reactivating the cruise control (p. 284)
- Deactivating Cruise Control (p. 285)

## Managing speed for the Cruise control

The cruise control (Cruise Control - CC) can be set to different speeds.

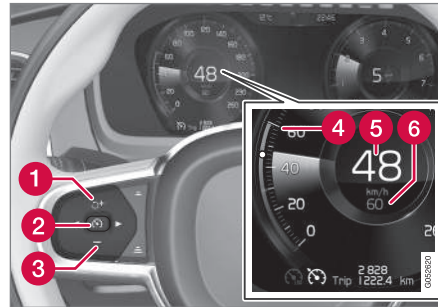

NOTE: The illustration is schematic - details may vary depending on car model.

- Change the stored speed with short or long presses on steering wheel button **+** (1) or **-** (3):
  - Use **short presses** to adjust +/- 5 km/h (+/- 5 mph) with **each press**.
  - **Hold the button depressed** to adjust +/- 1 km/h (+/- 1 mph) and **release** when the driver display's marking (4)/(6) is **at the desired speed**.
- > The speed set after the last press is stored in the memory.

If the driver increases the car's speed using the accelerator pedal before pressing the steering wheel button **+**, the speed stored will be the car's speed when the button is depressed, provided the driver's foot is on the accelerator pedal at the moment when the button is depressed.

A temporary increase in speed with the accelerator pedal, e.g. during overtaking, does not affect the setting - the car returns to the last stored speed when the accelerator pedal is released.

### Using engine braking instead of the foot brake

With Cruise Control, speed is regulated with less frequent application of the foot brake. On a downhill gradient it may sometimes be desirable to start moving a little faster and limit the acceleration by engine braking. In this case the driver can temporarily disable foot brake application by Cruise Control.

- Depress the accelerator pedal about halfway down and release.
  - > Cruise Control will disengage its automatic foot braking and then uses engine braking only.

### Related information

- Cruise control (p. 282)
- Activating and starting the Cruise control (p. 282)

- Deactivating/reactivating the cruise control (p. 284)
- Deactivating Cruise Control (p. 285)

### Deactivating/reactivating the cruise control

The cruise control (Cruise Control - CC) can be temporarily deactivated so that it is set in the standby mode and can be reactivated later.

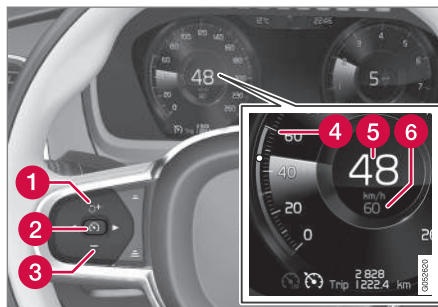

NOTE: The illustration is schematic - details may vary depending on car model.

### Deactivate Cruise Control and set in standby mode

- Press the steering wheel button  (2).
  - > The speed limit markings and symbols in the driver display change colour from WHITE to GREY — Cruise Control is now temporarily deactivated and the driver can temporarily exceed the set speed.

### Standby mode on driver intervention

The cruise control is temporarily deactivated and set in standby mode if:

- the foot brake is used
- the gear selector is moved to **N** position
- the clutch pedal is held depressed for longer than 1 minute
- the driver maintains a speed higher than the stored speed for longer than 1 minute.

The driver must then control the speed himself/herself.

A temporary increase in speed with the accelerator pedal, e.g. during overtaking, does not affect the setting - the car returns to the last stored speed when the accelerator pedal is released.

### Automatic standby mode

Cruise control is temporarily disengaged and set in standby mode if:

- wheels lose traction
- engine speed is too low/high
- brake temperature is too high
- speed falls below 30 km/h (20 mph).

The driver must then control the speed himself/herself.

### Reactivating cruise control from standby mode

- Press the steering wheel button  (1).
  - > The cruise control markings and symbols in the driver display change colour from GREY to WHITE — the car will now follow the most recently stored speed again.

or

- Press the steering wheel button  (2).
  - > The cruise control markings and symbols in the driver display change colour from GREY to WHITE — the car will now follow the current speed.

#### NOTE

A marked speed increase may occur once the speed has been resumed by pressing steering wheel button .

#### Related information



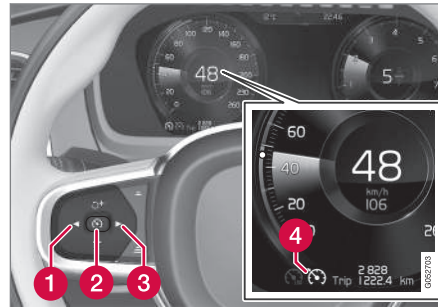

- Cruise control (p. 282)
- Activating and starting the Cruise control (p. 282)
- Managing speed for the Cruise control (p. 283)
- Deactivating Cruise Control (p. 285)

## Deactivating Cruise Control

Cruise control Cruise Control — CC can be deactivated.



Buttons and symbols for functions.

1. Press the steering wheel button  (2).
  - > Cruise control is set in standby mode.
2. Press the steering wheel button  (1) or  (3) to change to another function.
  - > The driver display's symbol and indicator for Cruise control (4) are switched off - which deletes the set/stored speed.
3. Press the steering wheel button  (2) again.
  - > Another function is activated.

In cars equipped with adaptive cruise control\* it is possible to change between both cruise control

functions - see the heading "Change between CC and ACC".

#### Related information

- Cruise control (p. 282)
- Activating and starting the Cruise control (p. 282)
- Managing speed for the Cruise control (p. 283)
- Deactivating/reactivating the cruise control (p. 284)
- Change between Cruise control and adaptive cruise control\* (p. 299)

## Distance Warning\*

The Distance Warning function (Distance Alert) warns the driver if the time interval to the vehicle ahead becomes too short.

Distance warning is active at speeds above 30 km/h (20 mph) and only reacts to the vehicle ahead travelling in the same direction. No distance information is provided for oncoming, slow or stationary vehicles.

### **i** NOTE

Distance warning is deactivated during the time the adaptive cruise control is active.

### **⚠** WARNING

Distance warning only reacts if the distance to the vehicle ahead is shorter than the preset value - the speed of the driver's vehicle is not affected.

## Head-up display\*

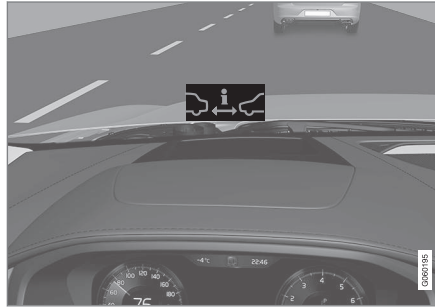

Symbol for Distance Warning on the windscreen<sup>4</sup>.

In cars equipped with head-up display, a symbol is shown on the windscreen for as long as the time interval to the vehicle ahead is shorter than the preset value. However, this presupposes that the **Show Driver Support** function is activated via settings in the car's menu system; see the heading "Head-up display" for how this works.

### **i** NOTE

Information on the windscreen may be difficult to see in strong sunlight and when wearing sunglasses.

## Related information

- Activating and setting the time interval for Distance warning\* (p. 287)
- Limitations of Distance Warning\* (p. 288)
- Head-up display\* (p. 112)
- Adaptive cruise control\* (p. 288)

<sup>4</sup> NOTE: The illustration is schematic - details may vary depending on car model.

## Activating and setting the time interval for Distance warning\*

The Distance warning (Distance Alert) function can be activated/deactivated and a time interval can be set.

### Activating/deactivating Distance warning



The function is activated/deactivated in function view in the centre display.

- Tap on the **Distance Alert** button in function view.
  - > Distance warning is activated/deactivated, a green/grey indicator is displayed in the button.

### Setting the time interval for Distance warning



Different time intervals to the vehicle in front can be selected and shown in the driver display as 1-5 horizontal lines - the more lines the longer the time interval. One line represents about 1 second to the vehicle in front, 5 lines represents about 3 seconds.

The same symbol is also shown when the adaptive cruise control function is activated.

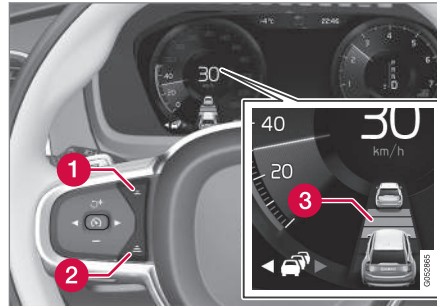

Control for time interval.

- 1 Decrease time interval
- 2 Increase time interval
- 3 Distance indicator

- Press the steering wheel button (1) or (2) to increase or decrease the time interval.
  - > The distance indicator (3) shows the current time interval.

### **i** NOTE

The higher the speed the longer the calculated distance in metres for a given time interval.

The set time interval is also used by the Adaptive Cruise Control function.

Only use the time intervals permitted by local traffic regulations.

### Related information

- Distance Warning\* (p. 286)
- Limitations of Distance Warning\* (p. 288)
- Adaptive cruise control\* (p. 288)

### Limitations of Distance Warning\*

The Distance warning (Distance Alert) function may have limitations in certain situations.

**i NOTE**

Strong sunlight, reflections or strong variations in light intensity, as well as wearing sunglasses, could mean that the warning light in the windscreen cannot be seen.

Poor weather or winding roads could affect the radar unit's capacity to detect vehicles in front.

The size of other vehicles could also affect detection capacity, e.g. motorcycles. This could mean that the warning lamp illuminates at a shorter distance than the setting or that the warning is temporarily absent.

Extremely high speeds can also cause the lamp to illuminate at a shorter distance than that set due to limitations in sensor range.

**i NOTE**

The function uses the car's radar unit, which has some general limitations, see the "Limitations for radar unit" section.

### Related information

- Distance Warning\* (p. 286)
- Activating and setting the time interval for Distance warning\* (p. 287)
- Limitations of the radar unit (p. 317)

### Adaptive cruise control\*

The adaptive cruise control (Adaptive Cruise Control - ACC) helps the driver to maintain an even speed combined with a pre-selected time interval to the vehicle ahead.

An adaptive cruise control provides a more relaxing driving experience on long journeys on motorways and long straight main roads in smooth traffic flows.

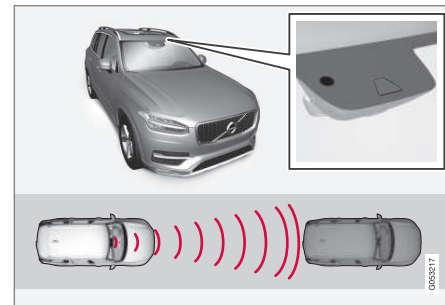

The camera and radar unit measures the distance to the vehicle ahead<sup>5</sup>.

The driver selects the desired speed and a time interval to the vehicle ahead. If the camera and radar unit detects a slower vehicle in front of the car, the speed is adapted automatically via the preset time interval to the vehicle. When the road

<sup>5</sup> NOTE: The illustration is schematic - details may vary depending on car model.

is clear again the car returns to the selected speed.

### WARNING

The Adaptive cruise control is an aid, which cannot handle all traffic, weather and road conditions.

The driver must always be observant with regard to the prevailing traffic conditions and intervene if the Adaptive cruise control does not maintain a suitable speed or suitable time interval.

Read all the sections about the adaptive cruise control in the owner's manual in order to learn about its limitations, of which the driver should be aware before the function is used.

The driver always bears responsibility for maintaining the correct time interval and speed - even when the Adaptive cruise control is being used.

Adaptive cruise control regulates the speed with acceleration and braking. It is normal for the brakes to emit a low sound when they are being used to adjust the speed.

The adaptive cruise control aims to control the speed in a smooth way. In situations that demand sudden braking the driver must brake himself/herself. This applies in case of large speed differ-

ences or if the vehicle in front brakes suddenly. Due to the limitations of the radar unit, braking may come unexpectedly or not at all.

The adaptive cruise control aims to follow the vehicle ahead in the same lane at a time interval set by the driver. If the radar unit cannot see any vehicle in front then the car will instead maintain the speed set and stored by the driver. This also takes place if the speed of the vehicle ahead increases and exceeds the stored speed.

The following applies for cars with automatic gearbox:

- Adaptive cruise control can follow another vehicle at speed from 0 km/h up to 200 km/h (125 mph).

The following applies for cars with manual gearbox:

- The Adaptive cruise control can follow another vehicle at speeds from 30 km/h (20 mph) up to 200 km/h (125 mph).

### WARNING

Adaptive cruise control is not a collision avoidance system. The driver must intervene if the system does not detect a vehicle in front.

The adaptive cruise control does not brake for humans or animals, and not for small vehicles such as bicycles and motorcycles. Nor for low trailers, oncoming, slow or stationary vehicles and objects.

Do not use the Adaptive cruise control, for example, in city traffic, at junctions, on slippery surfaces, with a lot of water or slush on the road, in heavy rain/snow, in poor visibility, on winding roads or on slip roads.

### IMPORTANT

Maintenance of adaptive cruise control components must only be performed at a workshop - an authorised Volvo workshop is recommended.

◀ **Overview**  
**Controls**

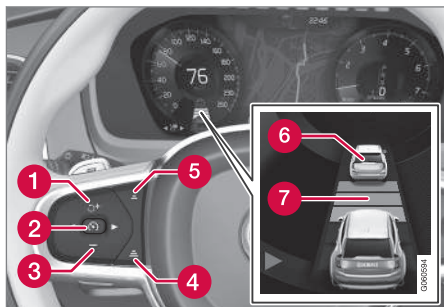

Buttons and symbols for functions<sup>5</sup>.

- 1 Increases stored speed or reactivates the adaptive cruise control and resumes stored speed and time interval
- 2 Activate the adaptive cruise control and store the current speed or deactivate the adaptive cruise control
- 3 Reduces stored speed
- 4 Increases the time interval to vehicles ahead
- 5 Reduces the time interval to vehicles ahead

- 6 Target vehicle indicator: ACC has detected and is following a target vehicle at the preset time interval
- 7 Symbol for time interval to vehicles ahead

In cars equipped with the adaptive cruise control option, the driver can change between CC and ACC - see "Change between Cruise control and adaptive cruise control".

**Driver display**

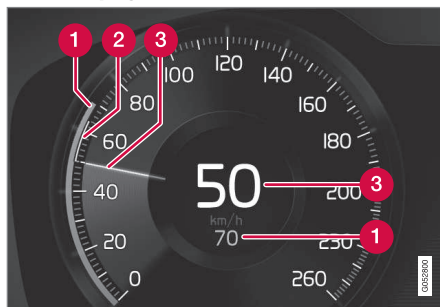

Indication of speeds<sup>5</sup>.

- 1 Stored speed
- 2 Speed of vehicle ahead.
- 3 Current speed of your car.

To see different combinations of symbols depending on traffic situation - see the heading

"Symbols and messages for the adaptive cruise control".

**Collision risk warning**

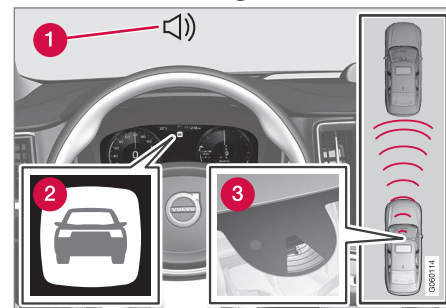

Audio and symbol for collision warning<sup>5</sup>

- 1 Acoustic warning signal in the event of a risk of collision
- 2 Warning signal in the event of a risk of collision
- 3 Distance measurement with the camera and radar unit

Adaptive Cruise Control uses approx. 40% of the capacity of the foot brake. If the car needs to be braked more heavily than the adaptive cruise control is capable of and the driver does not brake, the warning lamp and acoustic warning are

<sup>5</sup> NOTE: The illustration is schematic - details may vary depending on car model.



activated to alert the driver that immediate intervention is required.

### **⚠ WARNING**

The adaptive cruise control only warns of vehicles which its radar unit has detected - hence a warning may not be given, or it may be given with a certain delay. Do not wait for a warning without braking when so required.

### **Head-up display\***

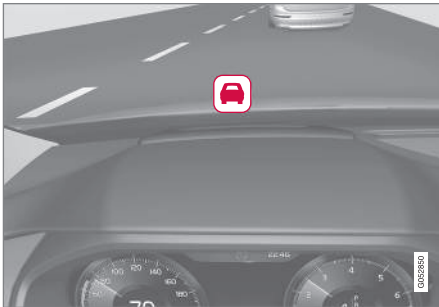

Symbol for collision warning on the windscreen<sup>5</sup>.

In cars equipped with a head-up display, the warning is shown on the windscreen by a flashing symbol.

### **NOTE**

Information on the windscreen may be difficult to see in strong sunlight and when wearing sunglasses.

### **Related information**

- Activating and starting the adaptive cruise control\* (p. 292)
- Managing the speed of the adaptive cruise control\* (p. 293)
- Setting the time interval for the adaptive cruise control\* (p. 294)
- Change of target and automatic braking with the Adaptive Cruise Control (p. 297)
- Change between Cruise control and adaptive cruise control\* (p. 299)
- Overtaking assistance with the adaptive cruise control\* or Pilot Assist\* (p. 296)
- Deactivating/activating the adaptive cruise control\* (p. 295)
- Limitations of the adaptive cruise control\* (p. 298)
- Symbols and messages for the adaptive cruise control\* (p. 300)
- Pilot Assist\* (p. 302)
- Distance Warning\* (p. 286)

- Head-up display\* (p. 112)
- Limitations of the radar unit (p. 317)

<sup>5</sup> NOTE: The illustration is schematic - details may vary depending on car model.

## Activating and starting the adaptive cruise control\*

The adaptive cruise control (Adaptive Cruise Control - ACC) must first be activated and then started if it is to control the speed and distance.

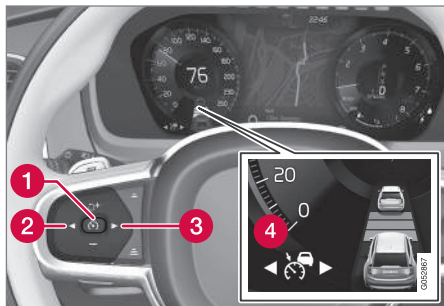

NOTE: The illustration is schematic - details may vary depending on car model.



### Activate Adaptive Cruise Control

Immediately after the engine is started the Adaptive Cruise Control is in the standby mode.

- Press ◀ (2) or ▶ (3) to browse to the symbol/function  (4).
  - > The symbol is displayed and Adaptive Cruise Control is set in standby mode.

### Start Adaptive Cruise Control

In order to start the ACC the following requirements apply:

- The driver's seatbelt must be buckled and the driver's door must be closed.
- There must be a vehicle (the "target vehicle") within reasonable distance in front of the car, or the current speed must be at least 15 km/h (9 mph).
- For cars with manual gearbox. Speed must be at the lowest 30 km/h (20 mph).
- With the symbol/function  displayed - press the steering wheel button  (1).
  - > Adaptive cruise control starts and the current speed is stored, which is shown in figures in the centre of the speedometer.

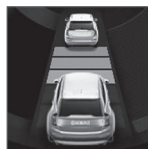

The time interval is only adjusted to the vehicle ahead by the ACC when the distance symbol shows two vehicles.



At the same time a speed range is marked.

The higher speed is the stored/selected speed and the lower speed is that of the vehicle ahead (target vehicle).

### Related information

- Adaptive cruise control\* (p. 288)

## Managing the speed of the adaptive cruise control\*

The adaptive cruise control (Adaptive Cruise Control -ACC) can be set to different speeds.

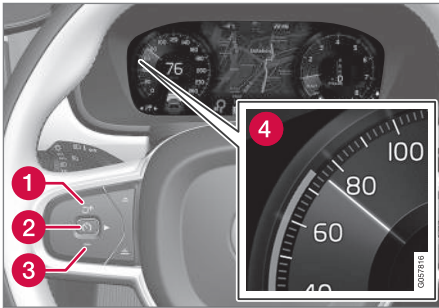

NOTE: The illustration is schematic - details may vary depending on car model.

- Change the stored speed with short or long presses on steering wheel button **+** (1) or **-** (3):
  - Use **short presses** to adjust +/- 5 km/h (+/- 5 mph) with **each press**.
  - **Hold the button depressed** to adjust +/- 1 km/h (+/- 1 mph) and **release** when the driver display's marking (4) is **at the desired speed**.
- > The speed set after the last press is stored in the memory.

If the driver increases the car's speed using the accelerator pedal before pressing the steering wheel button **+**, the speed stored will be the car's speed when the button is depressed, provided the driver's foot is on the accelerator pedal at the moment when the button is depressed.

A temporary increase in speed with the accelerator pedal, e.g. during overtaking, does not affect the setting - the car returns to the last stored speed when the accelerator pedal is released.

### Automatic gearbox

Adaptive cruise control can follow another vehicle at speed from 0 km/h up to 200 km/h (125 mph).

Note that the lowest programmable speed for the adaptive cruise control is 30 km/h (20 mph) - even though it is capable of following another vehicle down to 0 km/h, a speed lower than 30 km/h (20 mph) cannot be selected/stored.

Maximum speed selectable is 200 km/h (125 mph).

### Manual gearbox

The Adaptive cruise control can follow another vehicle at speeds from 30 km/h (20 mph) up to 200 km/h (125 mph).

The lowest programmable speed for the Adaptive cruise control is 30 km/h (20 mph) - the maximum speed is 200 km/h (125 mph).

### Related information

- Adaptive cruise control\* (p. 288)

## Setting the time interval for the adaptive cruise control\*

The adaptive cruise control (Adaptive Cruise Control -ACC) can be set to different time intervals.



Different time intervals to the vehicle in front can be selected and shown in the driver display as 1-5 horizontal lines - the more lines the longer the time interval. One line represents about 1 second to the vehicle in front, 5 lines represents about 3 seconds.

The same symbol is also shown when the Distance Warning function is activated.

### **i** NOTE

When the symbol in the driver display shows two cars, ACC is following the vehicle in front at a pre-set time interval.

When only one car is shown, there is no vehicle within a reasonable distance ahead.

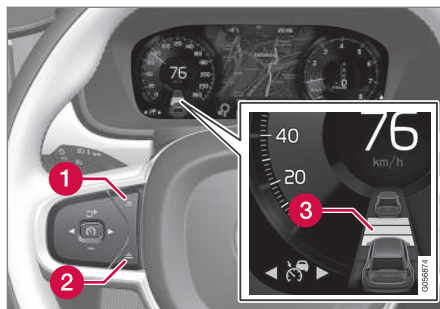

Control for time interval.

- 1** Decrease time interval
- 2** Increase time interval
- 3** Distance indicator

- Press the steering wheel button (1) or (2) to increase or decrease the time interval.
  - > The distance indicator (3) shows the current time interval.

The adaptive cruise control allows the time interval to vary significantly in certain situations in order to allow the car to follow the vehicle in front smoothly and comfortably. At low speed, when the distances are short, the adaptive cruise control increases the time interval slightly.

Note that a short time interval only allows the driver a short time to react and take action if any unforeseen problem should arise.

### **i** NOTE

Only use the time intervals permitted by local traffic regulations.

If the adaptive cruise control does not appear to react when activated, this may be because the time distance to the vehicle in front is preventing an increase in speed.

The higher the speed the longer the calculated distance in metres for a given time interval.

### Related information

- Adaptive cruise control\* (p. 288)
- Managing the speed of the adaptive cruise control\* (p. 293)
- Distance Warning\* (p. 286)

## Deactivating/activating the adaptive cruise control\*

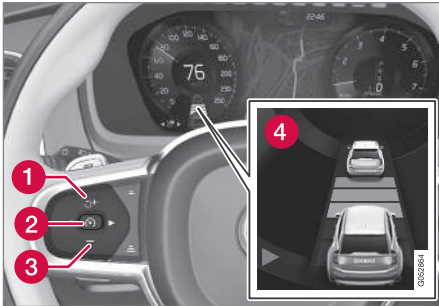

The adaptive cruise control (Adaptive Cruise Control - ACC) can be temporarily deactivated so that it is set in the standby mode and can later be reactivated.

### Deactivate Adaptive Cruise Control and set it in standby mode



NOTE: The illustration is schematic - details may vary depending on car model.

To temporarily switch off Adaptive Cruise Control and set it in standby mode:

- Press the steering wheel button  (2).
- > The  symbol on the driver display changes colour from WHITE to GREY and the stored speed in the centre of the speedometer changes from BEIGE to GREY.

In standby mode, the driver must him/herself control both speed and distance.

When the adaptive cruise control is in standby mode and the car drives too close to a vehicle ahead, the driver is warned about the short distance by the Distance Warning function instead (see reference to the heading "Distance Warning" at the end of this section).

### Standby mode on driver intervention

The adaptive cruise control is temporarily deactivated and set in standby mode if:

- the foot brake is used
- the gear selector is moved to **N** position.
- the driver maintains a speed higher than the stored speed for longer than 1 minute.
- the clutch pedal is depressed for approx. 1 minute - applies to cars with manual gearbox.

In this situation, the driver must intervene and adapt the speed and distance to the vehicle ahead.

A temporary increase in speed with the accelerator pedal, e.g. during overtaking, does not affect the setting - the car returns to the last stored speed when the accelerator pedal is released.

### Automatic standby mode

Adaptive cruise control is dependent on other systems, e.g. stability control/anti-skid ESC. If any of these systems stops working, adaptive cruise control is switched off automatically.

In the event of automatic deactivation a signal will sound and a message is shown in the driver display. The driver must then intervene and adapt the speed and distance to the vehicle ahead.

Automatic deactivation may occur if:

- the speed is below 5 km/h (3 mph) and ACC is uncertain whether the vehicle ahead is a stationary vehicle or an object, such as a speed bump.
- the speed is below 5 km/h (3 mph) and the vehicle ahead turns off so that ACC no longer has a vehicle to follow.
- speed is reduced to below 30 km/h (20 mph) - only applies to cars with manual gearbox.
- the driver opens the door
- the driver takes off the seatbelt
- engine speed is too low/high
- wheels lose traction
- brake temperature is high
- the parking brake is applied
- the camera and radar unit is covered by e.g. snow or heavy rainfall (camera lens/radio waves are blocked).



## ◀ Reactivating adaptive cruise control from standby mode

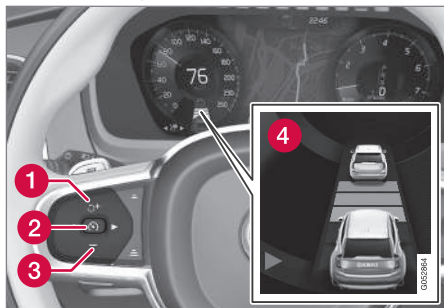

NOTE: The illustration is schematic - details may vary depending on car model.

To reactivate ACC from standby mode:

- Press the steering wheel button  (1).
  - > The speed is then set to the most recently stored speed.

### NOTE

A marked speed increase may occur once the speed has been resumed by pressing steering wheel button .

### Related information

- Adaptive cruise control\* (p. 288)
- Distance Warning\* (p. 286)

## Overtaking assistance with the adaptive cruise control\* or Pilot Assist\*

Adaptive cruise control (Adaptive Cruise Control - ACC) or Pilot Assist can assist the driver when overtaking other vehicles.

When ACC or Pilot Assist is following another vehicle and the driver indicates the intention to

overtake by activating the direction indicator<sup>6</sup>, adaptive cruise control or Pilot Assist helps by accelerating the car towards the vehicle ahead before the car reaches the overtaking lane.

The function then delays reducing speed in order to avoid premature braking when the driver's car is approaching a slower vehicle.

The function remains active until the driver's vehicle has cleared the overtaken vehicle.

### WARNING

Be aware that this function can be activated in more situations other than during overtaking, e.g. when a direction indicator is used to indicate a change of lane or exit to another road - the car will then accelerate briefly.

### Starting Overtaking Assistance

The following conditions must exist for Overtaking Assistance to be activated:

- there must be a vehicle in front (the "target vehicle")
- the speed must be at least 70 km/h (43 mph)
- the stored speed for ACC or Pilot Assist must be high enough for overtaking to take place safely.

- Activate the direction indicator.

Use the left direction indicator in a car with the steering wheel on the left, or the right direction indicator in a car with the steering wheel on the right.

> Overtaking assistance is started.

### Limitations

When using Overtaking Assistance the driver should be prepared for sudden changes in conditions. In some conditions Overtaking Assistance can cause unwanted acceleration.

Some situations should be avoided for this reason. Examples of such situations are:

- the car is approaching an exit road in order to turn off in the same direction that is normally used for overtaking
- the vehicle in front slows before your car has entered the overtaking lane
- traffic in the overtaking lane is slowing
- a car designed for right-hand traffic is being driven in a country with left-hand traffic (or vice versa).

Situations of this kind can be avoided by temporarily setting ACC or Pilot Assist in standby mode.

### Related information

- Pilot Assist\* (p. 302)
- Adaptive cruise control\* (p. 288)

## Change of target and automatic braking with the Adaptive Cruise Control

In combination with automatic gearbox, the adaptive cruise control (Adaptive Cruise Control - ACC) has functionality for change of target and braking at certain speeds.

### Change of target

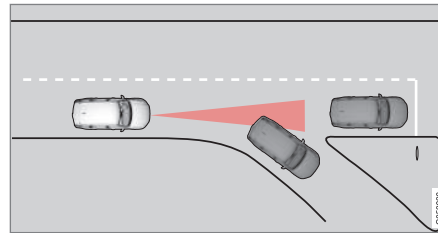

If the target vehicle in front suddenly turns then there may be stationary traffic in front.

When the adaptive cruise control is following another vehicle at speeds **below 30 km/h** (20 mph) and the target is changed from a moving vehicle to a stationary vehicle, the adaptive cruise control will brake for the stationary vehicle.

### WARNING

When the adaptive cruise control is following another vehicle at speeds **in excess of** approx. 30 km/h (20 mph) and the target is changed from a moving vehicle to a stationary vehicle, the adaptive cruise control will ignore the stationary vehicle and instead select the stored speed.

- The driver must then intervene him/herself and brake.

### Automatic standby mode with change of target

The adaptive cruise control is disengaged and set in standby mode:

- when the speed is below 5 km/h (3 mph) and the adaptive cruise control is uncertain whether the target object is a stationary vehicle or some other object, such as a speed bump.
- when the speed is below 5 km/h (3 mph) and the vehicle ahead turns off so the adaptive cruise control no longer has a vehicle to follow.

### Automatic braking

For shorter stops in connection with inching in slow traffic or at traffic lights driving is automatically resumed if the stops do not exceed about 3 seconds - if it takes longer before the car in

<sup>6</sup> On left flash only in left-hand-drive car, or right flash in right-hand-drive car.

- ◀ front starts moving again then the adaptive cruise control is set in standby mode with automatic braking.
- The Adaptive Cruise Control is reactivated in one of the following ways:
  - Press the steering wheel button .
  - Depress the accelerator pedal.
- > The Adaptive Cruise Control resumes following the vehicle ahead if it starts moving forward within 6 seconds.

**i NOTE**

ACC can keep the car stationary for a maximum of 5 minutes. After this the parking brake is applied and adaptive cruise control is disengaged.

The parking brake must be released before the adaptive cruise control can be reactivated.

**Cessation of automatic braking**

In some situations, automatic braking ceases on reaching 0 km/h and Adaptive Cruise Control is set in standby mode. This means that the brakes are released and the car may start to roll - the driver must therefore intervene and brake the car himself/herself to keep it stationary.

This may take place in the following situations:

- the driver puts his/her foot on the brake pedal
- the parking brake is applied
- the gear selector is moved to **P**, **N**, or **R** position
- the driver sets the adaptive cruise control in the standby mode.

**Automatic activation of parking brake**

In certain situations the parking brake is applied to keep the car stationary.

This takes place if the adaptive cruise control is holding the car stationary with the foot brake and:

- the driver opens the door or takes off his/her seatbelt
- ACC has kept the car stationary for more than approx. 5 minutes
- the brakes have overheated
- the engine is switched off.

**Related information**

- Adaptive cruise control\* (p. 288)

**Limitations of the adaptive cruise control\***

The (Adaptive Cruise Control - ACC) may have limitations in certain situations.

**Steep roads and/or heavy load**

Bear in mind that the adaptive cruise control is primarily intended for use when driving on level road surfaces. The function may have difficulty in keeping the correct distance from the vehicle ahead when driving on steep downhill slopes - in which case, be extra attentive and ready to brake. Do not use the adaptive cruise control with a heavy load or with a trailer connected to the car.

**Miscellaneous**

- Drive mode **Off Road** cannot be selected when the adaptive cruise control is activated.

**i NOTE**

The function uses the car's radar unit, which has some general limitations, see the "Limitations for radar unit" section.

**Related information**



- Adaptive cruise control\* (p. 288)
- Limitations of the radar unit (p. 317)



## Change between Cruise control and adaptive cruise control\*

In a car with Adaptive Cruise Control (ACC) the driver can change between Cruise Control (CC) and ACC.



A symbol in the driver display shows which cruise control is active:

CC Cruise Control	ACC Adaptive Cruise Control
	
Cruise control	Adaptive cruise control

A WHITE symbol: Function active, GREY symbol: Standby mode

### Changing from ACC to CC

How to change from Adaptive Cruise Control (ACC) to Cruise Control (CC):

- Set adaptive cruise control in standby mode using the  steering wheel button.
- Tap on the **Cruise control** button in the function view - the button's indicator changes colour from GREY to GREEN.
  - The symbol in the driver display changes from  ACC to  CC. Adaptive Cruise Control (ACC) is now switched off and Cruise Control (CC) is set in standby mode.

- Press the steering wheel button .
  - Cruise control starts and stores the current speed.





### WARNING

The car no longer maintains the preset time interval after switching from ACC to CC - it merely follows the set speed.

If CC is active when the engine is switched off, ACC will be activated the next time the engine is started.

### Changing from CC to ACC

Proceed as follows to change from cruise control (CC) to adaptive cruise control (ACC):

- Set cruise control in standby mode using the  steering wheel button.
- Tap on the **Cruise control** button in the function view - the button's indicator changes colour from GREEN to GREY.
  - The symbol in the driver display changes from  CC to  ACC. Adaptive Cruise Control is set in standby mode.
- Press the steering wheel button .
  - Adaptive cruise control starts and stores the current speed, together with the preset time interval to the vehicle ahead.

### Related information

- Cruise control (p. 282)
- Adaptive cruise control\* (p. 288)

## Symbols and messages for the adaptive cruise control\*

A number of symbols and messages regarding the adaptive cruise control (Adaptive Cruise Control - ACC) can be shown via the driver display and/or the head-up display\*.

Here are some examples<sup>7</sup>.

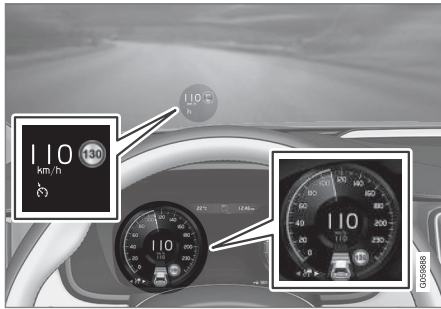

The previous illustration<sup>8</sup> shows that the adaptive cruise control is set to maintain 110 km/h and that there is no vehicle ahead to follow.

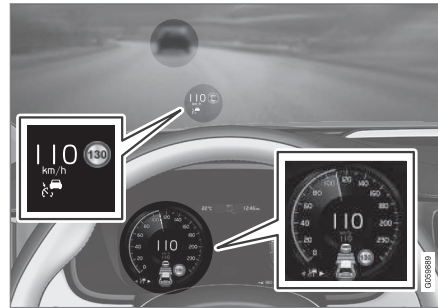



The previous illustration<sup>8</sup> shows that the adaptive cruise control is set to maintain 110 km/h and at the same time follow the vehicle ahead that is keeping the same speed.

Symbol	Message	Specification
	The symbol is WHITE	The car is maintaining the stored/selected speed.
	<b>Unavailable</b> and the symbol is GREY	Adaptive cruise control is set to standby mode.

<sup>7</sup> In the following illustrative example, the RSI (Road Sign Information) function informs that the maximum permitted speed is 130 km/h.

<sup>8</sup> NOTE: The illustration is schematic - details may vary depending on car model.

Symbol	Message	Specification
	<b>Adaptive cruise</b> <b>Service required</b>	The system does not function as it should. A workshop should be contacted - an authorised Volvo workshop is recommended.
	<b>Windscreen sensor</b> <b>Sensor blocked, see Owner's manual</b>	Clean the windscreen in front of the camera and radar unit's detectors.

### Related information

- Adaptive cruise control\* (p. 288)
- Road Sign Information\* (p. 346)

## Pilot Assist\*

Pilot Assist helps the driver to drive the car between the lane's side markings using steering assistance as well as to maintain an even speed, combined with a preselected time interval to the vehicle ahead.

The Pilot Assist function gives more comfortable driving and a more relaxed driving experience during, for example, long journeys on motorways in even traffic flows.

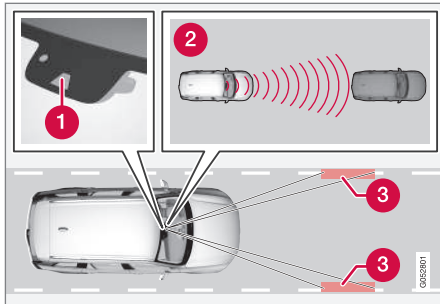

The camera and radar unit measures the distance to the vehicle ahead and detects side markings<sup>9</sup>.

- 1 Camera and radar unit
- 2 Distance readers
- 3 Readers, side markings

The driver selects the desired speed and a time interval to the vehicle ahead. Pilot Assist scans the distance to the vehicle ahead and the lane's side markings on the road surface using the camera and radar unit. The preset time interval is maintained with automatic speed adjustment whilst the steering assistance helps to position the car in the lane.

Pilot Assist steering assistance takes into account the speed of the preceding car and the lane markings. The driver can at any time ignore the Pilot Assist steering recommendation and steer in another direction, e.g. to change lane or avoid an obstruction on the road.

If Pilot Assist cannot interpret the lane unambiguously, e.g. if the camera and radar unit does not see the lane's side markings, Pilot Assist temporarily deactivates steering assistance, but resumes it if the lane can be interpreted again - although the speed and distance control functions remain active.

### **i** NOTE

Pilot Assist steering assistance is deactivated and is resumed without prior warning.

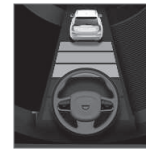

tance

The current status of steering assistance is indicated by the colour of the steering wheel's symbol:

- GREEN steering wheel indicates active steering assistance
- GREY steering wheel (as in illustration) indicates deactivated steering assistance.

<sup>9</sup> NOTE: The illustration is schematic - details may vary depending on car model.

**⚠ WARNING**

Pilot Assist is an aid which cannot handle all traffic, weather and road conditions.

The driver must always be observant with regard to the prevailing traffic conditions and intervene if Pilot Assist does not provide suitable steering assistance or maintain a suitable speed or suitable time interval.

Read all the sections about this function in the owner's manual in order to learn about its limitations, of which the driver should be aware before the function is used.

Pilot Assist must only be used if there are clear lane lines painted on the road surface on each side of the lane. All other use involves increased risk of contact with surrounding obstacles that are not detected by the function.

The driver always bears responsibility for how the car is controlled as well as for maintaining the correct distance and speed, even when Pilot Assist is being used.

Pilot Assist regulates the speed with acceleration and braking. It is normal for the brakes to emit a low sound when they are being used to adjust the speed.

Pilot Assist attempts to regulate the speed smoothly. In situations that demand sudden braking the driver must brake himself/herself. This applies in case of large speed differences or if the vehicle in front brakes suddenly. Due to the

limitations of the camera and radar unit, braking may come unexpectedly or not at all.

Pilot Assist aims to follow the vehicle ahead in the same lane at a time interval set by the driver. If the radar unit cannot see any vehicle in front then the car will instead maintain the speed set and stored by the driver. This also takes place if the speed of the vehicle ahead increases and exceeds the stored speed.

The following applies for cars with automatic gearbox:

- Pilot Assist can follow another vehicle at speeds from 0 km/h up to 200 km/h (125 mph).
- Pilot Assist can give steering assistance from almost stationary up to 140 km/h (87 mph).

The following applies for cars with manual gearbox:

- Pilot Assist can follow another vehicle at speeds from 30 km/h (20 mph) up to 200 km/h (125 mph).
- Pilot Assist can give steering assistance from 30 km/h (20 mph) up to 140 km/h (87 mph).

**⚠ WARNING**

Pilot Assist is not a collision avoidance system. The driver must intervene if the system does not detect a vehicle in front.

Pilot Assist does not brake for people, animals, objects, small vehicles (e.g. cycles and motorcycles), low trailers as well as oncoming, slow or stationary vehicles.

Do not use Pilot Assist, for example, in city traffic, at junctions, on slippery surfaces, with a lot of water or slush on the road, in heavy rain/snow, in poor visibility, on winding roads, on slip roads, or with a trailer connected to the car.

**! IMPORTANT**

Maintenance of Pilot Assist components must only be performed at a workshop - an authorised Volvo workshop is recommended.

« Overview

Controls

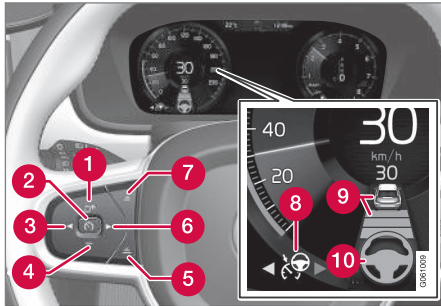

Buttons and symbols for functions<sup>9</sup>.

- 1 Increases stored speed or reactivates Pilot Assist and resumes stored speed and time interval
- 2 Activates/deactivates Pilot Assist
- 3 Switches from Pilot Assist to adaptive cruise control
- 4 Reduces stored speed
- 5 Increases the distance to vehicles ahead
- 6 Switches from adaptive cruise control to Pilot Assist
- 7 Reduces the distance to vehicles ahead

- 8 Function symbol
- 9 Symbols for target vehicle and time interval to vehicles ahead
- 10 Symbol for activated/deactivated steering assistance

Driver display

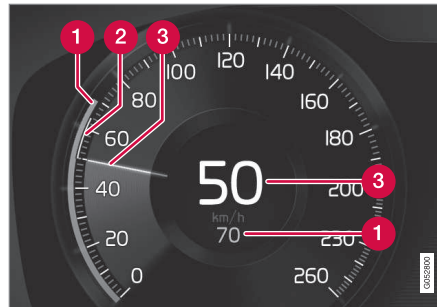

Indication of speeds<sup>9</sup>.

- 1 Stored speed
- 2 Speed of vehicle ahead.
- 3 Current speed of your car.

To see different combinations of symbols depending on traffic situation - see the heading "Symbols and messages for Pilot Assist".

Collision risk warning

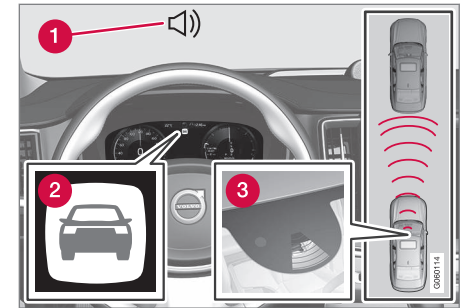

Audio and symbol for collision warning<sup>9</sup>

- 1 Acoustic warning signal in the event of a risk of collision
- 2 Warning signal in the event of a risk of collision
- 3 Distance measurement with the camera and radar unit

Pilot Assist uses approx. 40% of the foot brake's capacity. If the car needs to be braked more heavily than Pilot Assist is capable of and the driver does not brake, the warning lamp and acoustic warning are activated to alert the driver that immediate intervention is required.

<sup>9</sup> NOTE: The illustration is schematic - details may vary depending on car model.

**⚠ WARNING**

Pilot Assist only gives warning about vehicles whose camera and radar unit has been detected - therefore a warning may not occur or be delayed. Do not wait for a warning without braking when so required.

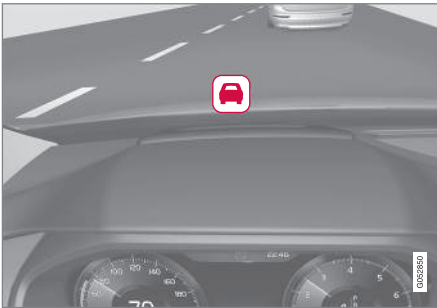
**Head-up display\***

Symbol for collision warning on the windscreen<sup>9</sup>.

In cars equipped with a head-up display, the warning is shown on the windscreen by a flashing symbol.

**i NOTE**

Information on the windscreen may be difficult to see in strong sunlight and when wearing sunglasses.

**Related information**

- Activating and starting the Pilot Assist\* (p. 305)
- Managing the speed for Pilot Assist\* (p. 307)
- Setting the time interval for Pilot Assist\* (p. 308)
- Change of target and automatic braking with Pilot Assist\* (p. 311)
- Deactivating/activating the Pilot Assist\* (p. 309)
- Overtaking assistance with the adaptive cruise control\* or Pilot Assist\* (p. 296)
- Limitations of Pilot Assist\* (p. 312)
- Symbols and messages for Pilot Assist\* (p. 314)
- Adaptive cruise control\* (p. 288)
- Distance Warning\* (p. 286)
- Head-up display\* (p. 112)
- Limitations of the radar unit (p. 317)
- Limitations of the camera unit (p. 325)

**Activating and starting the Pilot Assist\***

Pilot Assist must first be activated and then started to be able to control speed and distance and to give steering assistance.

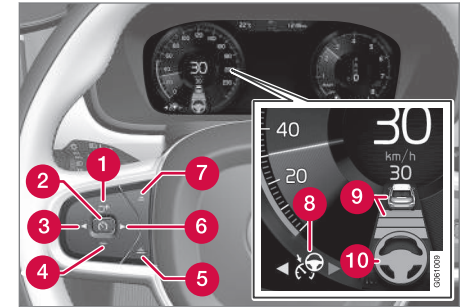



NOTE: The illustration is schematic - details may vary depending on car model.

In order to start the Pilot Assist it is required that:

- The driver's seatbelt must be buckled and the driver's door must be closed.
- There must be a vehicle (the "target vehicle") within reasonable distance in front of the car, or the current speed must be at least 15 km/h (9 mph).
- For cars with manual gearbox. Speed must be at the lowest 30 km/h (20 mph).

<sup>9</sup> NOTE: The illustration is schematic - details may vary depending on car model.

◀◀ With the adaptive cruise control in the standby mode:

1. Press ► (6).
  - > The  symbol changes to Pilot Assist in standby mode (8).
2. Press the steering wheel button  (2).
  - > Pilot Assist is started and current speed is stored, which is shown with figures in the centre of the speedometer.

...or...

With the adaptive cruise control started:

- Press ► (6).
  - > Pilot Assist is started.



Pilot Assist steering assistance is only active when the steering wheel symbol (2) has changed from GREY to GREEN.

Pilot Assist only regulates the time interval to the vehicle ahead when the distance symbol shows a vehicle (1) above the steering wheel symbol.



At the same time a speed range is marked.

The higher speed is the stored/selected speed and the lower speed is that of the vehicle ahead (target vehicle).

### Hands on the steering wheel

In order for Pilot Assist to function, the driver must have his/her hands on the steering wheel. The system continually monitors this. If hands are not detected on the steering wheel then a text message is shown, prompting the driver to actively steer the car. If this is not done, an acoustic warning signal will also be given.

If that does not prompt the driver to put his/her hands on the steering wheel either, Pilot Assist changes to standby mode. Following which, Pilot Assist must be restarted with the steering wheel button .

#### NOTE

Note that Pilot Assist only works when the driver has hands on the steering wheel.

### Related information

- Pilot Assist\* (p. 302)
- Managing the speed for Pilot Assist\* (p. 307)
- Setting the time interval for Pilot Assist\* (p. 308)
- Change of target and automatic braking with Pilot Assist\* (p. 311)
- Deactivating/activating the Pilot Assist\* (p. 309)

- Overtaking assistance with the adaptive cruise control\* or Pilot Assist\* (p. 296)
- Limitations of Pilot Assist\* (p. 312)
- Symbols and messages for Pilot Assist\* (p. 314)



## Managing the speed for Pilot Assist\*

Pilot Assist can be set to different speeds.

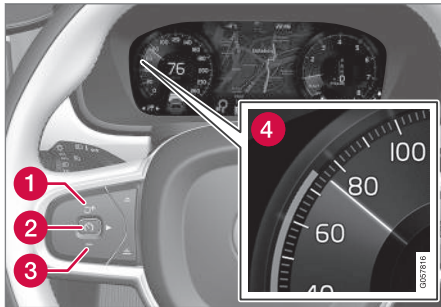

NOTE: The illustration is schematic - details may vary depending on car model.

- Change the stored speed with short or long presses on steering wheel button **+** (1) or **-** (3):
  - Use **short presses** to adjust +/- 5 km/h (+/- 5 mph) with **each press**.
  - **Hold the button depressed** to adjust +/- 1 km/h (+/- 1 mph) and **release** when the driver display's marking (4) is **at the desired speed**.
    - > The speed set after the last press is stored in the memory.

If the driver increases the car's speed using the accelerator pedal before pressing the steering

wheel button **+**, the speed stored will be the car's speed when the button is depressed, provided the driver's foot is on the accelerator pedal at the moment when the button is depressed.

A temporary increase in speed with the accelerator pedal, e.g. during overtaking, does not affect the setting - the car returns to the last stored speed when the accelerator pedal is released.

### Automatic gearbox

Pilot Assist can follow another vehicle at speeds from 0 km/h up to 200 km/h (125 mph).

Note that the lowest programmable speed for Pilot Assist is 30 km/h (20 mph) - even though it is capable of following another vehicle down to 0 km/h, a speed lower than 30 km/h (20 mph) cannot be selected/stored.

Maximum speed selectable is 200 km/h (125 mph).

### Manual gearbox

Pilot Assist can follow another vehicle at speeds from 30 km/h (20 mph) up to 200 km/h (125 mph).

The lowest programmable speed for Pilot Assist is 30 km/h (20 mph) - the maximum speed is 200 km/h (125 mph).

### Related information

- Pilot Assist\* (p. 302)
- Activating and starting the Pilot Assist\* (p. 305)
- Setting the time interval for Pilot Assist\* (p. 308)
- Change of target and automatic braking with Pilot Assist\* (p. 311)
- Deactivating/activating the Pilot Assist\* (p. 309)
- Overtaking assistance with the adaptive cruise control\* or Pilot Assist\* (p. 296)
- Limitations of Pilot Assist\* (p. 312)
- Symbols and messages for Pilot Assist\* (p. 314)

## Setting the time interval for Pilot Assist\*

Pilot Assist can be set with different time intervals.



Different time intervals to the vehicle in front can be selected and shown in the driver display as 1-5 horizontal lines - the more lines the longer the time interval. One line represents about 1 second to the vehicle

in front, 5 lines represents about 3 seconds.

### **i** NOTE

When the symbol in the driver display shows a car and a steering wheel, Pilot Assist follows a vehicle in front at a preset time gap.

When only one steering wheel is shown, there is no vehicle within a reasonable distance ahead.

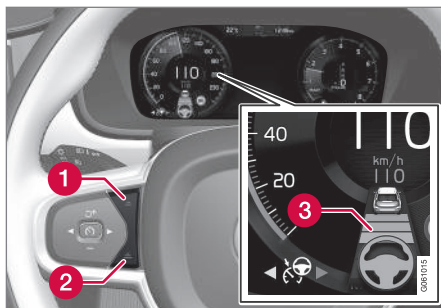

Control for time interval.

- 1** Decrease time interval
- 2** Increase time interval
- 3** Distance indicator

- Press the steering wheel button (1) or (2) to increase or decrease the time interval.
  - > The distance indicator (3) shows the current time interval.

In order to follow the vehicle ahead in a smooth and comfortable way, Pilot Assist allows the time interval to vary noticeably in certain conditions. For example, at low speed, when the distances become short, Pilot Assist increases the time interval slightly.

Note that a short time interval only allows the driver a short time to react and take action if any unforeseen problem should arise.

### **i** NOTE

Only use the time intervals permitted by local traffic regulations.

If Pilot Assist does not appear to react when activated, this may be because the time distance to the vehicle in front is preventing an increase in speed.

The higher the speed the longer the calculated distance in metres for a given time interval.

### Related information

- Pilot Assist\* (p. 302)
- Activating and starting the Pilot Assist\* (p. 305)
- Managing the speed for Pilot Assist\* (p. 307)
- Change of target and automatic braking with Pilot Assist\* (p. 311)
- Deactivating/activating the Pilot Assist\* (p. 309)
- Overtaking assistance with the adaptive cruise control\* or Pilot Assist\* (p. 296)
- Limitations of Pilot Assist\* (p. 312)
- Symbols and messages for Pilot Assist\* (p. 314)
- Distance Warning\* (p. 286)

## Deactivating/activating the Pilot Assist\*

Pilot Assist can be temporarily deactivated so that it is set in the standby mode and can be reactivated later.

### Deactivating and setting Pilot Assist in standby mode

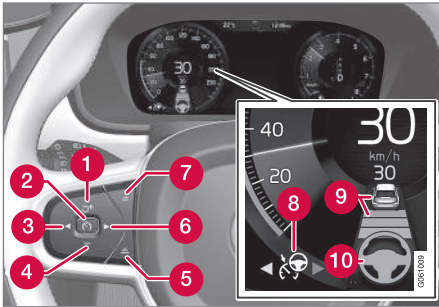

NOTE: The illustration is schematic - details may vary depending on car model.

To temporarily switch off Pilot Assist and set it in standby mode:

- Press the steering wheel button (1).
  - > Pilot Assist is set in standby mode - the symbol (8) in the driver display changes colour from WHITE to GREY and the stored speed in the centre of the speedometer changes from BEIGE to GREY.

...or...

- Press ◀ (3).
  - > Pilot Assist is switched off and changes to the adaptive cruise control in active mode.

In standby mode, the driver is no longer given any driver steering recommendations and must control both speed and distance him/herself.

When Pilot Assist is in standby mode and the car drives too close to a vehicle ahead, the driver is warned about the short distance by the Distance Warning function instead (see reference to the heading "Distance Warning" at the end of this section).

### Standby mode on driver intervention

Pilot Assist is temporarily deactivated and set in standby mode if:

- the foot brake is used
- the gear selector is moved to **N** position.
- the direction indicators are used for longer than 1 minute .
- the driver maintains a speed higher than the stored speed for longer than 1 minute.
- the clutch pedal is depressed for approx. 1 minute - applies to cars with manual gearbox.

A temporary increase in speed with the accelerator pedal, e.g. during overtaking, does not affect the setting - the car returns to the last stored speed when the accelerator pedal is released.

When the direction indicators are used, Pilot Assist steering assistance is temporarily disengaged. When this is no longer the case, steering assistance is automatically reactivated if the lane's side markings can still be detected.



#### ◀ Automatic standby mode

Pilot Assist is dependent on other systems, e.g. stability control/anti-skid ESC. If any of these other systems stops working, Pilot Assist is switched off automatically.

In the event of automatic deactivation a signal will sound and a message is shown in the driver display. The driver must then intervene and adapt the speed and distance to the vehicle ahead.

Automatic deactivation may occur if:

- the speed is below 5 km/h (3 mph) and Pilot Assist is uncertain whether the vehicle ahead is a stationary vehicle or an object, such as a speed bump.
- the speed is below 5 km/h (3 mph) and the vehicle ahead turns off so that Pilot Assist no longer has a vehicle to follow.
- speed is reduced to below 30 km/h (20 mph) - only applies to cars with manual gearbox.
- the driver's hands are not on the steering wheel
- the driver opens the door
- the driver takes off the seatbelt
- engine speed is too low/high
- wheels lose traction
- brake temperature is high
- the parking brake is applied

- the camera and radar unit is covered by e.g. snow or heavy rainfall (camera lens/radio waves are blocked).

#### Reactivating Pilot Assist from the standby mode

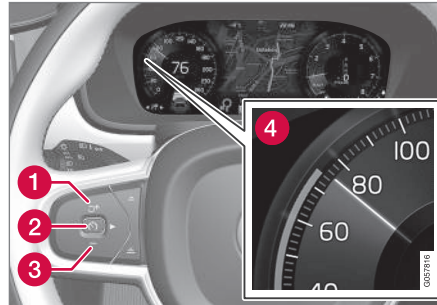

NOTE: The illustration is schematic - details may vary depending on car model.

- Press the steering wheel button  (1).
  - > The speed is then set to the most recently stored speed.

** NOTE**

A marked speed increase may occur once the speed has been resumed by pressing steering wheel button .

#### Related information

- Pilot Assist\* (p. 302)
- Activating and starting the Pilot Assist\* (p. 305)
- Managing the speed for Pilot Assist\* (p. 307)
- Setting the time interval for Pilot Assist\* (p. 308)
- Change of target and automatic braking with Pilot Assist\* (p. 311)
- Overtaking assistance with the adaptive cruise control\* or Pilot Assist\* (p. 296)
- Limitations of Pilot Assist\* (p. 312)
- Symbols and messages for Pilot Assist\* (p. 314)
- Distance Warning\* (p. 286)

## Change of target and automatic braking with Pilot Assist\*

In combination with automatic gearbox, Pilot Assist has functionality for change of target and braking at certain speeds.

### Change of target

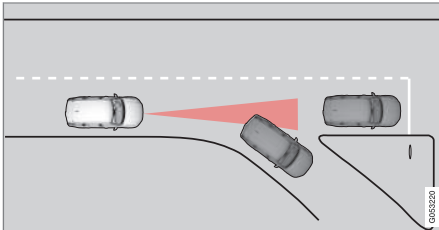

If the target vehicle in front suddenly turns then there may be stationary traffic in front.

When Pilot Assist is following another vehicle at speeds **below** 30 km/h (20 mph) and changes target from a moving to a stationary vehicle, Pilot Assist will slow down for the stationary vehicle.

### **⚠ WARNING**

When Pilot Assist is following another vehicle at speeds **in excess of** approx. 30 km/h (20 mph) and the target is changed from a moving vehicle to a stationary vehicle, Pilot Assist will ignore the stationary vehicle and instead select the stored speed.

- The driver must then intervene him/herself and brake.

### Automatic standby mode with change of target

Pilot Assist is disengaged and set in standby mode:

- when the speed is below 5 km/h (3 mph) and Pilot Assist is uncertain whether the target object is a stationary vehicle or some other object, e.g. a speed bump.
- when the speed is below 5 km/h (3 mph) and the vehicle in front turns off so the Pilot Assist no longer has a vehicle to follow.

### Automatic braking

For shorter stops in connection with inching forward in slow traffic or at traffic lights, driving is automatically resumed if the stops do not exceed about 3 seconds - if it takes longer before the car in front starts moving again then the Pilot Assist is set in standby mode with automatic braking.

- Pilot Assist is reactivated in the following way:
  - Press the steering wheel button .
  - Depress the accelerator pedal.
- > Pilot Assist resumes following the vehicle ahead if it starts moving forward within 6 seconds.

### **i NOTE**

Pilot Assist can hold the car stationary for a maximum of 5 minutes - then the parking brake is applied and the function is disengaged.

Before Pilot Assist can be reactivated, the parking brake must be released.

### ◀◀ **Cessation of automatic braking**

In some situations, automatic braking ceases on coming to a standstill and Pilot Assist is set in standby mode. This means that the brakes are released and the car may start to roll - the driver must therefore intervene and brake the car himself/herself to keep it stationary.

This may take place in the following situations:

- the driver puts his/her foot on the brake pedal
- the parking brake is applied
- the gear selector is moved to **P**, **N**, or **R** position
- the driver sets Pilot Assist in the standby mode.

### **Automatic activation of parking brake**

In certain situations the parking brake is applied to keep the car stationary.

This takes place if Pilot Assist is holding the car stationary with the foot brake and:

- the driver opens the door or takes off his/her seatbelt
- Pilot Assist has kept the car stationary for more than approx. 5 minutes
- the brakes have overheated
- the engine is switched off.

### **Related information**

- Pilot Assist\* (p. 302)
- Activating and starting the Pilot Assist\* (p. 305)
- Managing the speed for Pilot Assist\* (p. 307)
- Setting the time interval for Pilot Assist\* (p. 308)
- Deactivating/activating the Pilot Assist\* (p. 309)
- Overtaking assistance with the adaptive cruise control\* or Pilot Assist\* (p. 296)
- Limitations of Pilot Assist\* (p. 312)
- Symbols and messages for Pilot Assist\* (p. 314)

### **Limitations of Pilot Assist\***

The Pilot Assist function may have limitations in certain situations.

The Pilot Assist function is an aid which can help the driver in many situations. But the driver is at all times responsible for maintaining a safe distance to surrounding objects and a correct position in the lane.

**! IMPORTANT**

In certain situations, Pilot Assist steering assistance may have difficulty helping the driver in the right way or it may be automatically deactivated - in which case, the use of Pilot Assist is not recommended. Examples of such situations may be that:

- the lane markings are worn, missing or cross each other.
- lane division is unclear, for example, when the lanes divide or merge or at exits or in the event of multiple sets of markings.
- edges or other lines than lane markings are present on or near the road, e.g. curbs, joints or repairs to the road surface, edges of barriers, roadside edges or strong shadows.
- the lane is narrow or winding.
- the lane contains ridges or holes.
- weather conditions are poor, e.g. rain, snow or fog or slush or impaired view with poor light conditions, back-lighting, wet road surface etc.

The driver should also note that Pilot Assist has the following limitations:

- High kerbs, roadside barriers, temporary obstacles (traffic cones, safety barriers, etc.) are not detected. Alternatively, they may be detected incorrectly as lane

markings, with a subsequent risk of contact between the car and such obstacles. The driver must ensure him/herself that the car is at a suitable distance from such obstacles.

- The camera and radar sensor does not have the capacity to detect all oncoming objects and obstacles in traffic environments, e.g. potholes, stationary obstacles or objects which completely or partially block the route.
- Pilot Assist does not "see" pedestrians, animals, etc.
- The recommended steering input is force limited, which means that it cannot always help the driver to steer and keep the car within the lane.

The driver always has the possibility of correcting or adjusting a steering intervention imposed by Pilot Assist and can turn the steering wheel to the desired position.

**Steep roads and/or heavy load**

Bear in mind that Pilot Assist is primarily intended for use when driving on level road surfaces. The function may have difficulty in keeping the correct distance from the vehicle ahead when driving on steep downhill slopes - in which case, be extra attentive and ready to brake. Do not use Pilot Assist with a heavy load or with a trailer connected to the car.

**Miscellaneous**

- **Off Road** drive mode cannot be selected when Pilot Assist is activated.

**i NOTE**

The function uses the car's camera unit, which has some general limitations, see the "Limitations for camera unit" section.

**i NOTE**

The function uses the car's radar unit, which has some general limitations, see the "Limitations for radar unit" section.

**Related information**

- Pilot Assist\* (p. 302)
- Activating and starting the Pilot Assist\* (p. 305)
- Managing the speed for Pilot Assist\* (p. 307)
- Setting the time interval for Pilot Assist\* (p. 308)
- Change of target and automatic braking with Pilot Assist\* (p. 311)
- Deactivating/activating the Pilot Assist\* (p. 309)
- Overtaking assistance with the adaptive cruise control\* or Pilot Assist\* (p. 296)



- Symbols and messages for Pilot Assist\* (p. 314)
- Limitations of the camera unit (p. 325)
- Limitations of the radar unit (p. 317)

### Symbols and messages for Pilot Assist\*

A number of symbols and messages regarding Pilot Assist can be shown via the driver display and/or the head-up display\*.

Here are some examples<sup>10</sup>.

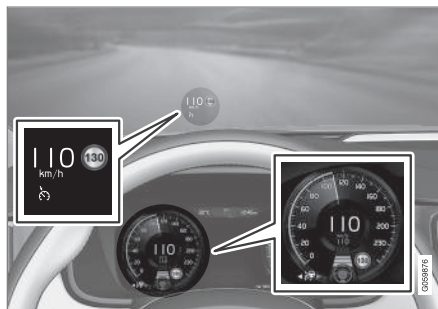

The previous illustration<sup>11</sup> shows that Pilot Assist is set to maintain 110 km/h and that there is no vehicle ahead to follow.

Pilot Assist provides no steering assistance since the lane's side markings cannot be detected.

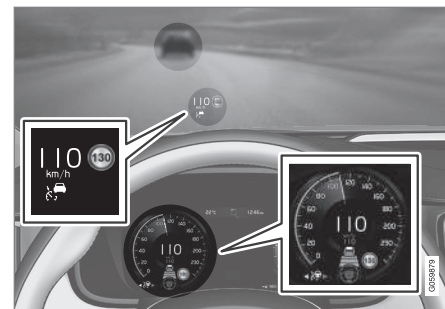

The previous illustration<sup>11</sup> shows that Pilot Assist is set to maintain 110 km/h and at the same time follow the vehicle ahead that is keeping the same speed.

Pilot Assist provides no steering assistance since the lane's side markings cannot be detected.

<sup>10</sup> In the following illustrative example, the RSI (Road Sign Information) function informs that the maximum permitted speed is 130 km/h.

<sup>11</sup> NOTE: The illustration is schematic - details may vary depending on car model.



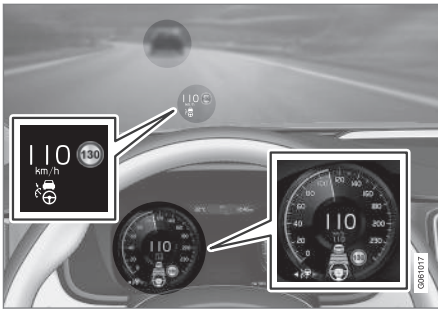

The previous illustration<sup>11</sup> shows that Pilot Assist is set to maintain 110 km/h and at the same time follow the vehicle ahead that is keeping the same speed.

Here, Pilot Assist also provides steering assistance since the lane's side markings can be detected.

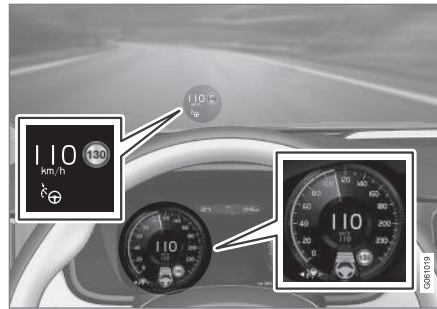

The previous illustration<sup>11</sup> shows that Pilot Assist is set to maintain 110 km/h and that there is no vehicle ahead to follow.

Here too, Pilot Assist provides steering assistance since the lane's side markings can be detected.

### Related information

- Pilot Assist\* (p. 302)
- Activating and starting the Pilot Assist\* (p. 305)
- Managing the speed for Pilot Assist\* (p. 307)
- Setting the time interval for Pilot Assist\* (p. 308)
- Change of target and automatic braking with Pilot Assist\* (p. 311)

- Deactivating/activating the Pilot Assist\* (p. 309)
- Overtaking assistance with the adaptive cruise control\* or Pilot Assist\* (p. 296)
- Limitations of Pilot Assist\* (p. 312)
- Road Sign Information\* (p. 346)

<sup>11</sup> NOTE: The illustration is schematic - details may vary depending on car model.

### Radar unit

The radar unit is used by several driver support systems and has the task of sensing other vehicles.



NOTE: The illustration is schematic - details may vary depending on car model.

The radar unit is used by the following functions:

- Distance Warning\*
- Adaptive cruise control\*
- Pilot Assist\*
- City Safety

Modification of the radar unit could result in its use being illegal.

### Related information

- Limitations of the radar unit (p. 317)
- Type approval for radar units (p. 321)

- Distance Warning\* (p. 286)
- Adaptive cruise control\* (p. 288)
- Pilot Assist\* (p. 302)
- City Safety (p. 328)

## Limitations of the radar unit

The radar unit has certain limitations - which in turn also limits those functions that use the unit.

### Blocked unit



The marked area must be kept free from stickers, objects, shade film, etc.<sup>12</sup>.

The radar unit is placed inside the upper section of the windscreen together with the car's camera unit.

### **!** IMPORTANT

Do not place, stick or mount anything on the outside or inside of the windscreen in front of or around the camera and radar unit — this can interfere with camera and radar-dependent functions.

This may mean that functions are reduced, deactivated completely or give incorrect function response.



If the driver display shows this symbol with the message **Windscreen sensor Sensor blocked**, see **Owner's manual**, it means that the camera and radar unit cannot detect other vehicles in front of the car.

The following table presents examples of possible causes for a message being shown, along with the appropriate action:

Cause	Action
The windscreen surface in front of the camera and radar unit is dirty or covered with ice or snow.	Clean dirt, ice and snow from the windscreen surface in front of the camera and radar unit.
Thick fog and heavy rain or snow block the radar signals or the camera view.	No action. Sometimes the unit does not work during heavy rain or snowfall.

<sup>12</sup> NOTE: The illustration is schematic - details may vary depending on car model.



Cause	Action
Water or snow from the road surface swirls up and blocks the radar signals or camera view.	No action. Sometimes the unit does not work on a very wet or snow-covered road surface.
Dirt has appeared between the inside of the windscreen and the camera and radar unit.	Visit a workshop to have the windscreen inside the unit's cover cleaned - an authorised Volvo workshop is recommended.

**i NOTE**

Keep the windscreen clean in front of the camera and radar unit.

**Vehicle speed**

The capacity of the radar unit to detect vehicles ahead is reduced significantly if:

- the speed of the vehicle ahead is significantly different from that of your own car

**Limited field of vision**

The radar unit has a limited field of vision. In some situations another vehicle is not detected, or the detection is made later than expected.

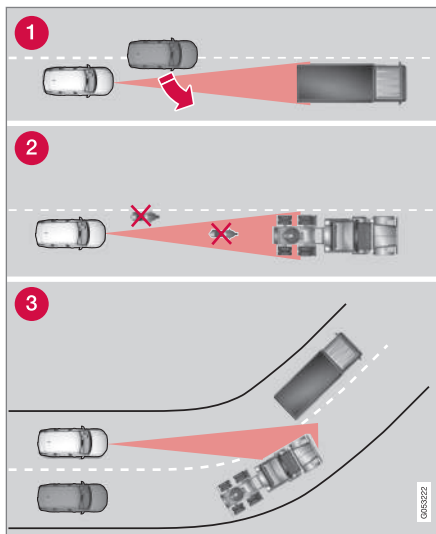

The radar unit's field of vision.

- Sometimes the radar unit is late at detecting vehicles at close distances - e.g. a vehicle

that drives in between your car and the vehicle ahead.

- Small vehicles, such as motorcycles, or vehicles not driving in the centre of the lane can remain undetected.
- In bends, the radar unit may detect the wrong vehicle or lose a detected vehicle from view.

**Low trailers**

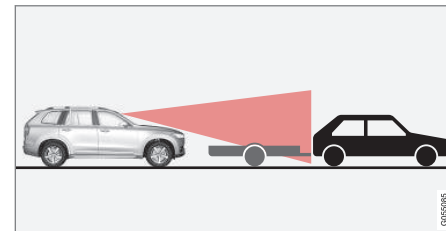

Low trailer in radar shadow.

Low trailers can also be difficult for the radar unit to detect, or are not detected at all - the driver should therefore be particularly careful when driving behind low trailers when the adaptive cruise control or Pilot Assist is activated.

## High temperature

At very high temperatures the camera and radar unit can temporarily be switched off for about 15 minutes after the engine is started so as to protect the unit's electronics. The camera and radar unit restarts automatically when the temperature has fallen sufficiently.

## Damaged windscreen

### **IMPORTANT**

If a crack, scratch or stone chip in the windscreen in front of one of the camera and radar unit "windows" covers an area of approx. 0.5 x 3.0 mm or larger, a workshop must be contacted to have the windscreen replaced. An authorised Volvo workshop is recommended.

If not rectified it can lead to reduced performance for the driver support systems that use the camera and radar unit.

This may mean that functions are reduced, deactivated completely or give incorrect function response.

To avoid the risk of failed, deficient or reduced operation of driver support systems that use the radar unit, the following also applies:

- Volvo recommends **against** repairing cracks, scratches or stone chips in the area in front of the camera and radar unit. Instead, the whole windscreen should be replaced.
- Before replacing a windscreen, contact an authorised Volvo workshop to verify that the correct windscreen is ordered and fitted.

- The same type or Volvo-approved windscreen wipers must be fitted during replacement.

### **IMPORTANT**

When the windscreen is replaced, the camera and radar unit must be recalibrated at the workshop to ensure the functionality of all the car's camera and radar-based systems. An authorised Volvo workshop is recommended.

## Maintenance

In order that the radar and camera unit shall function correctly, the windscreen in front of the unit must be kept clear of dirt, ice and snow, and be cleaned regularly with water and car shampoo.

### **NOTE**

Dirt, ice and snow covering the camera and radar unit will reduce its function and may prevent measurement.

This may mean that functions are reduced, deactivated completely or give incorrect function response.

## Related information

- Radar unit (p. 316)
- Limitations of the camera unit (p. 325)
- Limitations of Distance Warning\* (p. 288)





## DRIVER SUPPORT

- ◀◀ • Limitations of the adaptive cruise control\*  
(p. 298)
- Limitations of City Safety (p. 335)
- Pilot Assist\* (p. 302)



## Type approval for radar units

Type approval for the car's radar units can be seen in the following table.



Market	ACC <sup>A</sup>	BLIS <sup>B</sup>	Symbol	Type approval
Brazil		✓		Este equipamento opera em caráter secundário, isto é, não tem direito à proteção contra interferência prejudicial, mesmo de estações do mesmo tipo, e não pode causar interferência a sistemas operando em caráter primário.  Modelo: L2C0055TR 1500-15-8065 EAN: 07897843840978
	✓			Modelo: L2C0054TR 4122-14-8645 EAN: (01)07897843840855
Europe	✓	✓		Hereby, Delphi Electronics & Safety declares that L2C0054TR / L2C0055TR are in compliance with the essential requirements and other relevant provisions of Directive 1999/5/EC. The Declaration of Conformity may be consulted at Delphi Electronics & Safety / 2151 E. Lincoln Road / Kokomo, Indiana 46902 USA
The United Arab Emirates	✓			TRA REGISTERED No: ER37536/15 DEALER No: DA37380/15
		✓		TRA REGISTERED No: ER37357/15 DEALER No: DA37380/15

## DRIVER SUPPORT



Market	ACCA <sup>A</sup>	BLIS <sup>B</sup>	Symbol	Type approval
Indonesia	✓			37295/POSTEL/2014 4927
		✓		38806/SDPPI/2015 4927
Jordan	✓			Type Approval No.: TRC/LPD/2014/255 Equipment Type: Low Power Device (LPD)
		✓		Type Approval No.: TRC/LPD/2015/3 Equipment Type: Low Power Device (LPD)
Korea	✓			Certification No. MSIP-CMI- DPH-L2C0054TR
		✓		Certification No. MSIP-CMI-DPH-L2C0055TR
Morocco	✓	✓		AGREE PAR L'ANRT MAROC NUMÉRO D'AGRÉMENT: MR 9929 ANRT 2014 DATE D'AGRÉMENT: 26/12/2014
Moldavia	✓	✓		1024



Market	ACC <sup>A</sup>	BLIS <sup>B</sup>	Symbol	Type approval
Singapore	✓	✓		Complies with IDA Standards DA105753
South Africa	✓			TA-2014/1824 APPROVED
		✓		TA-2014/2390 APPROVED
Taiwan	✓			CCAB15LP0560T3
		✓		CCAB15LP0680T0

<sup>A</sup> ACC = Adaptive Cruise Control

<sup>B</sup> BLIS = Blind Spot Information

### Related information

- Radar unit (p. 316)
- Limitations of the radar unit (p. 317)
- Adaptive cruise control\* (p. 288)
- Blind Spot Information\* (p. 338)

## Camera unit

The camera unit is used by several driver support systems and has the task of for example detecting lane lines or traffic signs.



NOTE: The illustration is schematic - details may vary depending on car model.

The camera unit is used by the following functions:

- Adaptive cruise control\*
- Lane assistance\*
- Driver Alert Control\*
- Pilot Assist\*
- City Safety
- Run-off Mitigation
- Road Sign Information\*
- Active main beam\*

## Related information

- Limitations of the camera unit (p. 325)
- Adaptive cruise control\* (p. 288)
- Lane Keeping Aid (p. 352)
- Driver Alert Control (p. 350)
- Pilot Assist\* (p. 302)
- City Safety (p. 328)
- Run-off Mitigation (p. 358)
- Road Sign Information\* (p. 346)
- Activating/deactivating main beam (p. 138)

## Limitations of the camera unit

The camera unit has certain limitations - which in turn also limits those functions that use the unit.

### Impaired vision

The camera has limitations similar to the human eye, i.e. it can "see" worse in for example intense snowfall or rain, dense fog, heavy dust storms and snow flurries. Under such conditions, the functions of camera-dependent systems could be significantly reduced or temporarily disengaged.

Strong oncoming light, reflections in the carriageway, snow or ice on the road surface, dirty road surfaces or unclear lane markings can also significantly reduce camera function when it is used to scan the carriageway to detect pedestrians, cyclists, large animals and other vehicles.

### Blocked unit



The marked area must be kept free from stickers, objects, shade film, etc.<sup>13</sup>.

The camera unit is placed inside the upper section of the windscreen together with the car's radar unit.

### ! IMPORTANT

Do not place, stick or mount anything on the outside or inside of the windscreen in front of or around the camera and radar unit — this can interfere with camera and radar-dependent functions.

This may mean that functions are reduced, deactivated completely or give incorrect function response.



If the driver display shows this symbol with the message **Windscreen sensor Sensor blocked, see Owner's manual**, it means that the camera and radar unit cannot detect other vehicles in front of the car.

The following table presents examples of possible causes for a message being shown, along with the appropriate action:

<sup>13</sup> NOTE: The illustration is schematic - details may vary depending on car model.



Cause	Action
The windscreen surface in front of the camera and radar unit is dirty or covered with ice or snow.	Clean dirt, ice and snow from the windscreen surface in front of the camera and radar unit.
Thick fog and heavy rain or snow block the radar signals or the camera view.	No action. Sometimes the unit does not work during heavy rain or snowfall.
Water or snow from the road surface swirls up and blocks the radar signals or camera view.	No action. Sometimes the unit does not work on a very wet or snow-covered road surface.
Dirt has appeared between the inside of the windscreen and the camera and radar unit.	Visit a workshop to have the windscreen inside the unit's cover cleaned - an authorised Volvo workshop is recommended.
Strong oncoming light	No action. The camera unit is reset automatically in more favourable light conditions.

**i NOTE**

Keep the windscreen clean in front of the camera and radar unit.

**High temperature**

At very high temperatures the camera and radar unit can temporarily be switched off for about 15 minutes after the engine is started so as to protect the unit's electronics. The camera and radar unit restarts automatically when the temperature has fallen sufficiently.

**Damaged windscreen**

**! IMPORTANT**

If a crack, scratch or stone chip in the windscreen in front of one of the camera and radar unit "windows" covers an area of approx. 0.5 x 3.0 mm or larger, a workshop must be contacted to have the windscreen replaced. An authorised Volvo workshop is recommended.

If not rectified it can lead to reduced performance for the driver support systems that use the camera and radar unit.

This may mean that functions are reduced, deactivated completely or give incorrect function response.

To avoid the risk of failed, deficient or reduced operation of driver support systems that use the radar unit, the following also applies:

- Volvo recommends **against** repairing cracks, scratches or stone chips in the area in front of the camera and radar unit. Instead, the whole windscreen should be replaced.
- Before replacing a windscreen, contact an authorised Volvo workshop to verify

that the correct windscreen is ordered and fitted.

- The same type or Volvo-approved windscreen wipers must be fitted during replacement.

### **!** IMPORTANT

When the windscreen is replaced, the camera and radar unit must be recalibrated at the workshop to ensure the functionality of all the car's camera and radar-based systems. An authorised Volvo workshop is recommended.

### **Maintenance**

In order that the radar and camera unit shall function correctly, the windscreen in front of the unit must be kept clear of dirt, ice and snow, and be cleaned regularly with water and car shampoo.

### **i** NOTE

Dirt, ice and snow covering the camera and radar unit will reduce its function and may prevent measurement.

This may mean that functions are reduced, deactivated completely or give incorrect function response.

### **Related information**

- Camera unit (p. 324)
- Limitations of the radar unit (p. 317)
- Lane Keeping Aid (p. 352)
- Limitations of Driver Alert Control (p. 352)
- Limitations of Pilot Assist\* (p. 312)
- Limitations of City Safety (p. 335)
- Limitations of Road Sign Information\* (p. 350)

## City Safety

City Safety uses visual, haptic and acoustic signals to alert the driver of any pedestrians, cyclists, large animals and vehicles that appear. The car then brakes automatically unless the driver him/herself acts within a reasonable time.

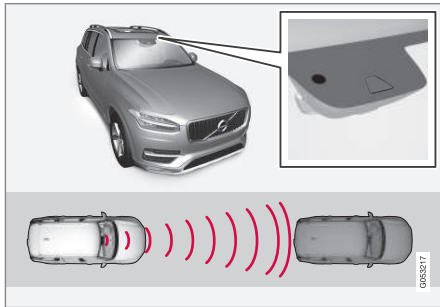

Location of the radar unit<sup>14</sup>.

City Safety can prevent a collision or reduce collision speed.

City Safety is an aid to assist a driver who is at risk of colliding with a pedestrian, large animal, cyclist or a vehicle.

The City Safety function can help the driver to avoid a collision when driving in queues, e.g. when changes in the traffic ahead, combined with a lapse in attention, could lead to an incident.

The function helps the driver by automatically braking the car in the event of an imminent risk of collision if the driver does not react in time by braking and/or swerving.

City Safety activates a short, sharp braking procedure, normally stopping the car just behind the vehicle in front. For most drivers this is well outside normal driving style and may be perceived as uncomfortable.

City Safety is activated in situations where the driver should have started braking earlier, which is why it cannot help the driver in every situation.

City Safety is designed to be activated as late as possible in order to avoid unnecessary intervention.

The driver or passengers are not normally aware of City Safety - it only intervenes in a situation where a collision is immediately imminent.

City Safety can avoid a collision with a vehicle ahead or a bicycle by reducing the speed of the car by up to 50 km/h (30 mph). For a pedestrian, City Safety can reduce speed by up to 45 km/h (28 mph).

If the speed difference is greater than 50 km/h (30 mph) or 45 km/h (28 mph) respectively, City Safety's automatic braking cannot prevent a collision but it can mitigate the consequences of a collision.

In the event of a risk of a collision with a large animal, City Safety can reduce the car's speed by up to 15 km/h (9 mph). The braking function for large animals is primarily intended to reduce the collision force at high speeds. Braking is most effective at speeds above 70 km/h (43 mph) and less effective at low speeds.

<sup>14</sup> NOTE: The illustration is schematic - details may vary depending on car model.

**⚠ WARNING**

City Safety is an aid and does not work in all driving situations, traffic, weather and road conditions.

Warning only activated in the event of a high risk for collision. This section and the section "Limitations for City Safety" inform about limitations that the driver should be aware of before using City Safety.

Warnings and brake interventions for pedestrians and cyclists are deactivated at vehicle speeds above 70 km/h (43 mph).

City Safety's auto-brake function can prevent a collision or reduce collision speed. To ensure full brake performance, the driver should always depress the brake pedal - even if the car auto-brakes.

City Safety does not activate any auto-brake functions in the event of heavy acceleration.

The driver is always responsible for maintaining the correct distance and speed - never wait for a collision warning or for City Safety to intervene.

**Market limitation**

City Safety is not available in all countries. If City Safety does not appear in the centre display's **Settings** menu, the car is not equipped with this function.

Search path in the top menu: **Settings** → **My Car** → **IntelliSafe**

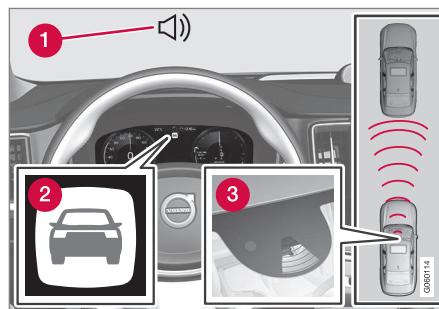
**Overview**

Function overview<sup>14</sup>.

- 1 Acoustic warning signal in the event of a risk of collision
- 2 Warning signal in the event of a risk of collision
- 3 Distance measurement with the camera and radar unit

City Safety carries out three steps in the following order:

1. Collision warning
2. Brake support
3. Auto Brake

**Collision warning**

The driver is first warned of a potentially imminent collision.

City Safety can detect pedestrians, cyclists or vehicles that are stationary or moving in the same direction as the car and are ahead. City Safety can also detect pedestrians, cyclists or large animals that are crossing the road in front of the car.

In the event of a risk of collision with a pedestrian, large animal, cyclist or vehicle (including vehicles described in the "City Safety in cross traffic" section), the driver's attention is alerted by means of a red flashing warning signal, an acoustic signal and a haptic warning in the form of a brake pulse. At lower speeds or with hard braking or acceleration there will be no haptic warning. The brake pulse frequency varies according to the car's speed.

**Brake support**

If the risk of collision has increased further after the collision warning then the brake support is activated.

Brake support reinforces the driver's braking action if the system considers that the braking is not sufficient to avoid a collision.

<sup>14</sup> NOTE: The illustration is schematic - details may vary depending on car model.

## ◀ Auto Brake

The automatic brake function is activated last.

If in this situation the driver has not yet started to take evasive action and the risk of collision is imminent then the automatic braking function is deployed - this takes place irrespective of whether or not the driver brakes. Braking then takes place with full brake force in order to reduce collision speed, or with limited brake force if it is sufficient to avoid a collision.

In connection with automatic braking the seatbelt tensioner may also be activated. For more information see the "Seatbelt tensioner" section.

In some situations, the action of Auto-brake may begin with light braking and then progress to full brake action.

When City Safety has prevented a collision with a stationary object, the car remains stationary in anticipation of positive action by the driver. If the car has been braked to avoid collision with a slower vehicle in front, its speed is reduced to match that of the vehicle in front.

### **i** NOTE

On cars with manual gearbox, the engine stops when the Auto-brake function has stopped the car, unless the driver has managed to depress the clutch pedal beforehand.

The driver can always interrupt a braking intervention by firmly depressing the accelerator pedal.

### **i** NOTE

When City Safety™ brakes, the brake lights come on.

When City Safety is activated and brakes the vehicle, the driver display shows a text message to the effect that the function is/has been active.

### **⚠** WARNING

City Safety must not be used as an excuse for the driver to change his/her driving style. If the driver relies solely on City Safety to do the braking, there might be a risk of a collision sooner or later.

## Related information

- Setting the warning distance for City Safety (p. 330)
- Detection of obstacles with City Safety™ (p. 331)
- City Safety when evasive manoeuvres are prevented (p. 334)
- City Safety in cross traffic (p. 333)
- Limitations of City Safety (p. 335)
- Messages for City Safety (p. 337)
- Seatbelt tensioner (p. 59)

## Setting the warning distance for City Safety

City Safety is always activated, but it is possible to select the warning distance for the function.

### **i** NOTE

The City Safety function cannot be deactivated. It is activated automatically when the engine/electric operation is started and remains switched on until the engine/electric operation is switched off.

The warning distance determines the sensitivity of the system and regulates the distance at which the visual, acoustic and haptic warnings shall be triggered.

1. Tap on **Settings** in top view in the centre display.
2. Press **My Car** → **IntelliSafe**.
3. Under **City Safety Warning**, select **Late**, **Normal** or **Early** to set the desired warning distance.

If the **Early** setting produces too many warnings, which could be perceived as irritating in certain situations, then use the **Normal** or **Late** warning distance.

If warnings are perceived as being too frequent or disturbing then the warning distance can be reduced. This would lead to the system warning



at a later stage, which reduces the total number of warnings.

The **Late** warning distance should only be used in exceptional cases, as in dynamic driving.

### **i** NOTE

City Safety warns the driver when there is a risk of a collision, but it cannot shorten the driver's reaction time.

With the warning distance set at **Early**, the warnings will come more in advance. This may mean that the warnings come more often than for warning distance **Normal**.

### **i** NOTE

Even if the warning distance has been set to **Early** warnings could be perceived as being late in certain situations, e.g. when there are large differences in speed or if vehicles in front brake heavily.

### **i** NOTE

The warning with direction indicators for Rear Collision Warning is deactivated if the warning distance for collision warning in the City Safety function is set at the lowest level "**Late**".

The seat belt pre-tensioning and braking functions are, however, still active.

### **!** WARNING

No automatic system can guarantee 100 % correct function in all situations. Therefore, never test City Safety by driving at people, animals or vehicles - this may cause severe damage and injury and risk lives.

### Related information

- City Safety (p. 328)

## Detection of obstacles with City Safety™

The obstructions that City Safety can detect are vehicles, cyclists, large animals and pedestrians.

### Vehicles

City Safety detects most vehicles that are either stationary or moving in the same direction as your car, as well as vehicles described in the "City Safety in cross traffic" section.

In order that City Safety shall be able to detect a vehicle in the dark, the vehicle's front and rear lights must be working and clearly illuminated.

### Cyclists

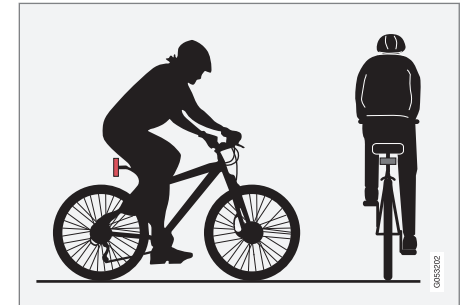

Optimal examples of what City Safety interprets as a cyclist — with clear body outline and bicycle outline.

Optimal performance requires that the system function that detects a cyclist must receive the clearest possible information about the body and



- ◀◀ bicycle outline, requiring the ability to identify the bicycle, head, arms, shoulders, legs, upper and lower body plus a normal human pattern of movement.

If large parts of the cyclist's body or bicycle are not visible to the function's camera then the system cannot detect a cyclist.

For the function to be able to detect a cyclist, he/she must be an adult and riding a bicycle designed for adults.

### WARNING

City Safety is an aid, and cannot detect all cyclists in all situations and, for example, cannot see:

- partially obscured cyclists.
- cyclists wearing clothing that obscures the body outline.
- bicycles loaded with large objects.

The driver is always responsible that the vehicle is driven correctly and with a safety distance adapted to the speed.

## Pedestrians

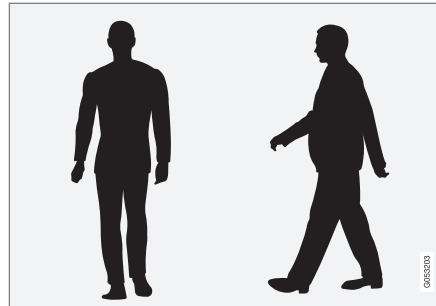

Optimal examples of what the system regards as pedestrians with clear body outlines.

For optimal performance, the system function that detects pedestrians must receive the clearest possible information about the body outline, requiring the ability to identify the head, arms, shoulders, legs, upper and lower body plus a normal human pattern of movement.

In order that it shall be possible to detect a pedestrian there must be a contrast with the background and this will be affected by such things as clothes, the background and the weather. With poor contrast the pedestrian may either be detected late or not at all, which may mean that warnings and braking are late or omitted.

City Safety can also detect pedestrians in the dark if they are illuminated by the car's headlamps.

### WARNING

City Safety is an aid and cannot detect all pedestrians in all situations and, for example, cannot see:

- partially obscured pedestrians, people in clothing that hides their body contour or pedestrians shorter than 80 cm.
- pedestrians if the background contrast of the pedestrians is poor - warning and brake interventions may then be late or not occur at all.
- pedestrians who are carrying larger objects.

The driver is always responsible that the vehicle is driven correctly and with a safety distance adapted to the speed.

## Large animals

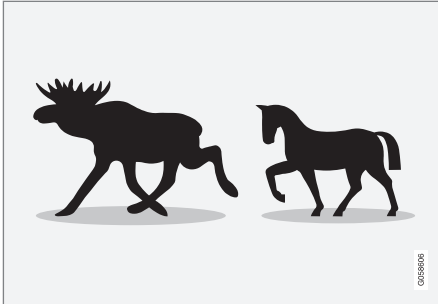

Optimum examples of what City Safety interprets as large animals - standing still or walking slowly and with clear body outline.

Optimal performance requires that the system function that detects a large animal (e.g. elk and horse) must receive the clearest possible information about the body outline, requiring the ability to identify the animal directly from the side in combination with what is a normal pattern of movement for the animal.

If parts of the animal's body are not visible to the function's camera then the system cannot detect the animal.

City Safety can also detect large animals in the dark if they are illuminated by the car's headlamps.

## WARNING

City Safety is an aid, and cannot detect all large animals in all situations and, for example, cannot see:

- partially obscured large animals.
- larger animals seen from the front or from behind.
- large animals that run or move quickly.
- large animals if the background contrast of the animals is poor - warning and brake interventions may then be late or not occur at all.
- small animals such as dogs and cats, for example.

The driver is always responsible that the vehicle is driven correctly and with a safety distance adapted to the speed.

## Related information

- City Safety (p. 328)

## City Safety in cross traffic

City Safety can help the driver when turning and crossing the path of another oncoming vehicle at an intersection.

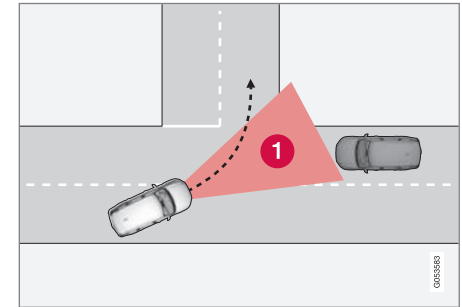

Sector in which City Safety can detect oncoming cross-traffic vehicles.

For City Safety to detect an oncoming vehicle on a collision course, the oncoming vehicle must first enter the sector (1) in which City Safety can analyse the situation.

## DRIVER SUPPORT

- ◀ The following further criteria must also be fulfilled:
  - your car must be travelling at no less than 4 km/h (3 mph)
  - your car must turn to the left in markets with right-hand traffic (or to the right in left-hand traffic)
  - the oncoming vehicle must have its headlamps switched on.

### WARNING

City Safety is an aid and does not work in all driving situations, traffic, weather and road conditions.

Warnings and brake interventions due to a collision risk with an oncoming vehicle often come very late.

The driver is always responsible for maintaining the correct distance and speed - never wait for a collision warning or for City Safety to intervene.

### Limitations in cross traffic

In some cases City Safety may have difficulty helping the driver deal with collision risks due to oncoming cross traffic. Examples are:

- stability control ESC intervenes in the event of slippery driving conditions
- if the oncoming vehicle is detected too late

- if the oncoming vehicle is obscured by something
- if the oncoming vehicle has headlamps switched off
- if the oncoming vehicle drives in an unpredictable manner, for example, abruptly changes lanes at a late stage.

### Related information

- City Safety (p. 328)

## City Safety when evasive manoeuvres are prevented

City Safety has the facility to assist the driver by automatically braking the car earlier when it is not possible to avoid a collision by only steering away.

City Safety assists the driver by continuously attempting to anticipate whether there are "escape routes" to the side in case a slow or stationary vehicle ahead is discovered at a late stage.

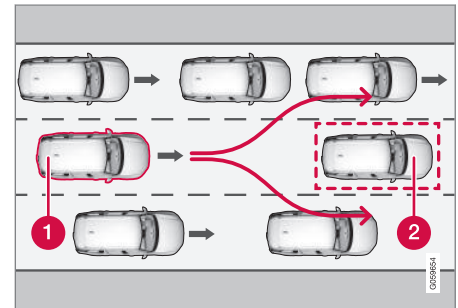

Your car (1) "sees" no options for evading the vehicle ahead (2) and can therefore auto-brake earlier.

- 1 Your car
- 2 Slow/stationary vehicle

City Safety does not intervene with the auto-brake function as long as the driver him/herself

has the opportunity to avoid a collision via a steering manoeuvre.

However, if City Safety anticipates that an evasive manoeuvre is not possible due to traffic in an adjacent lane, the function can assist the driver by automatically starting to brake at an earlier stage.

### **WARNING**

City Safety's ability to anticipate a certain situation is an aid, and does not work in all driving situations or traffic, weather and road conditions.

The driver always bears ultimate responsibility for ensuring that the vehicle is driven safely and that applicable laws and road traffic regulations are followed.

### **Related information**

- City Safety (p. 328)
- Limitations of City Safety (p. 335)

## **Limitations of City Safety**

The City Safety function may have limitations in certain situations.

### **Surroundings**

#### **Low objects**

Low-hanging objects, e.g. a flag/pennant for projecting load, or accessories such as auxiliary lamps and bull bars that are higher than the bonnet limit the function.

#### **Skidding**

On slippery road surfaces the braking distance is extended, which may reduce the capacity of City Safety to avoid a collision. In such situations, the anti-lock brakes and the stability control ESC will give the best possible braking force with maintained stability.

#### **Oncoming light**

The visual warning signal in the windscreen may be difficult to notice in the event of strong sunlight, reflections, when sunglasses are being worn or if the driver is not looking straight ahead.

#### **Heat**

In the event of high passenger compartment temperature caused by e.g. strong sunlight, the visual warning signal in the windscreen may be temporarily disengaged.

#### **The camera and radar unit's field of view**

The camera's field of vision is limited, which is why pedestrians, large animals, cyclists and vehi-

cles in some situations cannot be detected, or they are detected later than anticipated.

Dirty vehicles may be detected later than others and if it is dark, motorcycles may be detected late or not at all.

If a text message in the driver display indicates that the camera and radar unit is obstructed, City Safety may be unable to detect pedestrians, large animals, cyclists, vehicles or road lines ahead of the car. This means that the functionality of City Safety may be reduced.

However, an error message is not shown in all situations where the windscreen sensors are obstructed. The driver must therefore take care to keep the area of windscreen in front of the camera and radar unit clear.

### **IMPORTANT**

Maintenance and replacement of City Safety components must only be performed by a workshop - an authorised Volvo workshop is recommended.

### **Driver intervention**

#### **Reversing**

When your own car is reversing, City Safety is temporarily deactivated.



◀ **Low speed**

City Safety is not activated at very low speeds - below 4 km/h (3 mph) - and the system therefore does not intervene in situations where your car is approaching a vehicle ahead very slowly, e.g. when parking.

**Active driver**

Driver commands are always prioritised, which is why City Safety does not intervene or postpone warning/intervention in situations where the driver is steering and accelerating in a decisive manner, even if a collision is unavoidable.

Active and aware driving behaviour can therefore delay a collision warning and intervention in order to minimise unnecessary warnings.

**Miscellaneous**

**⚠ WARNING**

Warnings and brake interventions could be implemented late or not at all if a traffic situation or external influences mean that the camera and radar unit cannot detect pedestrians, cyclists, large animals or vehicles correctly.

For vehicles to be detected at night, their headlamps and rear lamp cluster must be switched on and shining clearly.

The camera and radar unit has a limited range for pedestrians and cyclists. The system can provide effective warnings and brake interventions as long as the relative speed is below 50 km/h (30 mph). For stationary or slow-moving vehicles, warnings and brake interventions are effective at vehicle speeds up to 70 km/h (43 mph). Speed reduction for large animals is less than 15 km/h (9 mph) and can be achieved at vehicle speeds above 70 km/h (43 mph). The warning and brake intervention for large animals is less effective at lower speeds.

Warnings for stationary or slow-moving vehicles and large animals could be disengaged due to darkness or poor visibility.

Warnings and brake interventions for pedestrians and cyclists are deactivated at vehicle speeds exceeding 70 km/h (43 mph).

Do not place, stick or mount anything on the outside or inside of the windscreen in front of or around the camera and radar unit — this can interfere with camera-dependent functions.

Objects, snow, ice or dirt in the area of the camera sensor may reduce its function, fully deactivate it or give incorrect function response.

**i NOTE**

The function uses the car's camera unit, which has some general limitations, see the "Limitations for camera unit" section.

**i NOTE**

The function uses the car's radar unit, which has some general limitations, see the "Limitations for radar unit" section.

**Related information**

- City Safety (p. 328)
- Limitations of the camera unit (p. 325)
- Limitations of the radar unit (p. 317)

## Messages for City Safety

A number of messages regarding City Safety can be shown in the driver display.

The following table shows some examples.

Message	Specification
Automatic intervention City Safety	When City Safety brakes or has done an automatic braking, several of the driver display symbols may be illuminated in connection with a text message being shown.
City Safety Reduced functionality Service required	The system does not function as it should. A workshop should be contacted - an authorised Volvo workshop is recommended.

### Related information

- City Safety (p. 328)

## Rear Collision Warning

The Rear Collision Warning (RCW) function can help the driver to avoid being hit by a vehicle approaching from behind.

RCW is activated automatically each time the engine is started.

The RCW can warn the driver in a vehicle approaching from behind that a collision is imminent by rapidly flashing the direction indicators.

If, at a vehicle speed below 30 km/h (20 mph), the RCW function detects that the car is in danger of being hit from behind, the seatbelt tensioners may tension the front seatbelts and the Whiplash Protection System safety system is activated.

Immediately before the collision, RCW may also activate the foot brake in order to reduce the forward acceleration of the car during the collision. However, the foot brake is only activated if the car is stationary. The foot brake releases immediately if the accelerator pedal is depressed.

### Limitations

In certain cases the RCW may have difficulty helping the driver in the event of a collision risk. This can be for example:

- if the vehicle approaching from the rear is detected too late
- if the vehicle approaching from the rear changes lane at the last moment

- if the vehicle approaching from the rear has a speed exceeding 80 km/h (50 mph).

#### NOTE

In certain markets, RCW does **not** give a warning with the direction indicators due to local traffic regulations - in such cases, this part of the function is deactivated.

#### NOTE

The warning with direction indicators for Rear Collision Warning is deactivated if the warning distance for collision warning in the City Safety function is set at the lowest level "Late".

The seat belt pre-tensioning and braking functions are, however, still active.

### Related information

- City Safety (p. 328)
- Setting the warning distance for City Safety (p. 330)
- Seatbelt tensioner (p. 59)
- Whiplash Protection System (p. 57)

## Blind Spot Information\*

The Blind Spot Information (BLIS) function is designed to give a warning of vehicles diagonally behind and to the side of your car so as to give assistance in heavy traffic on roads with several lanes in the same direction.

BLIS is a driver aid intended to give a warning of:

- vehicles in the car's blind spot
- quickly approaching vehicles in the left and right lanes closest to the car.

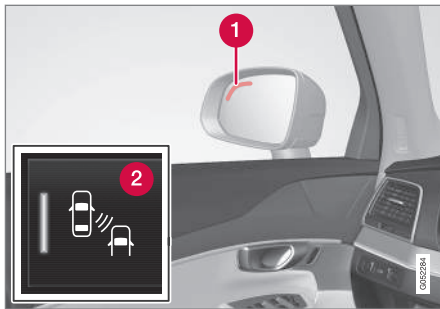

Location of BLIS lamp<sup>15</sup>.

- 1 Indicator lamp
- 2 The BLIS button in the centre display's function view activates/deactivates the function.

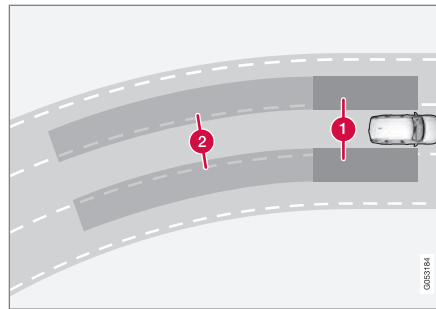

Principle of Blind Spot Information

- 1 Zone in blind spot
- 2 Zone for quickly approaching vehicle.

The BLIS function is active at speeds above 10 km/h (6 mph).

The system is designed to react when:

- your car is overtaken by other vehicles
- another vehicle is quickly approaching your car.

When BLIS detects a vehicle in Zone 1 or a quickly approaching vehicle in Zone 2, the indicator lamp on the door mirror on the affected side illuminates with a constant glow. If the driver activates the direction indicator on the same side as the warning, the indicator lamp will change over

from a constant glow to flashing with a more intense light.

#### **i NOTE**

The lamp illuminates on the side of the car where the system has detected the vehicle. If the car is overtaken on both sides at the same time then both lamps illuminate.

#### **⚠ WARNING**

Blind Spot Information does not work on sharp bends.

Blind Spot Information does not work when the car is reversing.

#### **⚠ WARNING**

Blind Spot Information is a supplementary aid and does not work in all situations.

Blind Spot Information is no substitute for a safe driving style and the use of rearview and door mirrors.

Blind Spot Information can never replace responsibility and attention by the driver. It is always the driver's responsibility to change lanes in a safe manner.

<sup>15</sup> NOTE: The illustration is schematic - details may vary depending on car model.



## ⚠ WARNING

The system is a supplement to, not a replacement for, a safe driving style and use of the rearview mirrors. It can never replace the driver's attention and responsibility. The responsibility for changing lanes safely always rests with the driver.

### Related information

- Activate/deactivate Blind Spot Information\* (p. 340)
- Limitations of Blind Spot Information\* (p. 341)
- Messages for Blind Spot Information\* and Cross Traffic Alert\* (p. 345)
- Cross Traffic Alert\* (p. 341)

## Activate/deactivate Blind Spot Information\*

The Blind Spot Information (BLIS) function can be activated/deactivated.

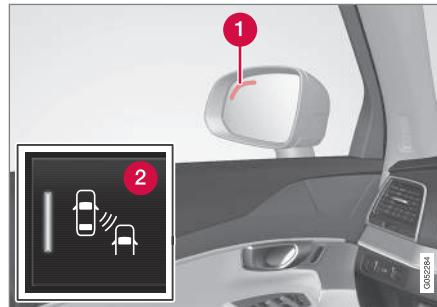

Location of Blind Spot Information lamp<sup>16</sup>.

- 1 Indicator lamp
- 2 The function is activated/deactivated using the BLIS button in the centre display's function view.
  - Tap on the **BLIS** button in function view.
    - > BLIS is activated/deactivated - a green/grey indicator is shown in the button.

If BLIS is activated when starting the engine, the function is confirmed by the door mirror indicator lamps blinking once.

If BLIS was deactivated when the engine was switched off, it will continue to be deactivated when the engine is next started and no indicator lights will then be illuminated.

## ⚠ WARNING

Blind Spot Information is a supplementary aid and does not work in all situations.

Blind Spot Information is no substitute for a safe driving style and the use of rearview and door mirrors.

Blind Spot Information can never replace responsibility and attention by the driver. It is always the driver's responsibility to change lanes in a safe manner.

### Related information

- Blind Spot Information\* (p. 338)
- Limitations of Blind Spot Information\* (p. 341)
- Messages for Blind Spot Information\* and Cross Traffic Alert\* (p. 345)

<sup>16</sup> NOTE: The illustration is schematic - details may vary depending on car model.

## Limitations of Blind Spot Information\*

The Blind Spot Information (BLIS) function may have limitations in certain situations.

Examples of limitations:

- Dirt, ice and snow covering the sensors may reduce the functions and deactivate alerts.
- BLIS is deactivated when a trailer is connected to the car's electrical system.

## Sensors

The sensors for the BLIS function are located inside each corner of the rear wing/bumper. The sensors are also used by the Cross Traffic Alert (CTA) function.

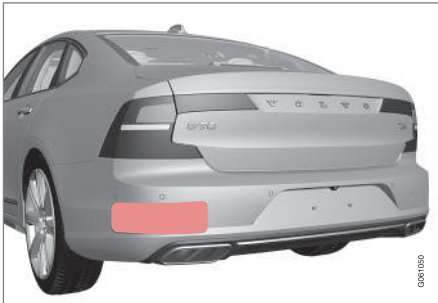

Keep the surface clean - on both the left and right-hand sides of the car<sup>17</sup>.

To ensure optimal functionality, the surfaces in front of the sensors must be kept clean.

Do not affix any objects, tape or labels in the area of the sensors.

### ! IMPORTANT

Repair of the BLIS and CTA functions' components or repainting the bumpers must only be performed by a workshop - an authorised Volvo workshop is recommended.

## Related information

- Blind Spot Information\* (p. 338)
- Activate/deactivate Blind Spot Information\* (p. 340)
- Messages for Blind Spot Information\* and Cross Traffic Alert\* (p. 345)
- Limitations of Cross Traffic Alert (p. 343)

## Cross Traffic Alert\*

Cross Traffic Alert (CTA) is a driver aid that is intended to warn of crossing traffic when the car is reversing. CTA is a supplement to Blind Spot Information (BLIS).

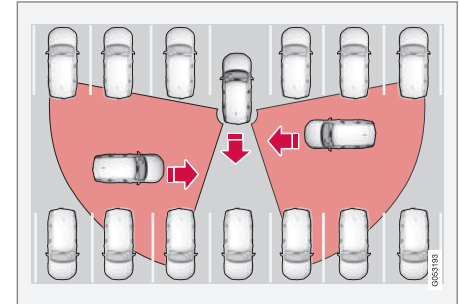

Principle of CTA.

CTA supplements the functionality of BLIS by providing the ability to see crossing traffic approaching from the side, such as while reversing out of a parking space.

CTA is primarily designed to detect vehicles. In favourable conditions it may also be able to detect smaller objects, such as cyclists and pedestrians.

CTA is only active if the car rolls backwards or if reverse gear has been selected.

<sup>17</sup> NOTE: The illustration is schematic - details may vary depending on car model.

◀◀ If CTA has sensed that something is approaching from the side, this is also indicated with:

- an acoustic signal - the sound is heard in the left-hand or right-hand speaker according to the direction from which the object approaches.
- an illuminated icon in the PAS graphics on the screen.
- an icon on the Park assist camera top view.



Illuminated CTA icon in the PAS graphic on the screen.

**⚠ WARNING**

CTA is a supplementary aid and does not work in all situations.

CTA is no substitute for a safe driving style and the use of rearview and door mirrors.

CTA can never replace the driver's responsibility and attention - it is always the driver's responsibility to reverse in a safe manner.

### Related information

- Activate/deactivate Cross Traffic Alert\* (p. 342)
- Messages for Blind Spot Information\* and Cross Traffic Alert\* (p. 345)
- Limitations of Cross Traffic Alert (p. 343)
- Blind Spot Information\* (p. 338)

## Activate/deactivate Cross Traffic Alert\*

The Cross Traffic Alert (CTA) function can be activated/deactivated.



The function is activated/deactivated in function view in the centre display.

- Tap on the **Cross Traffic Alert** button in function view.
  - > • GREEN button indication - CTA is activated.
  - GREY button indication - CTA is deactivated.

CTA is always in activated mode after the engine is started.

**⚠ WARNING**

CTA is a supplementary aid and does not work in all situations.

CTA is no substitute for a safe driving style and the use of rearview and door mirrors.

CTA can never replace the driver's responsibility and attention - it is always the driver's responsibility to reverse in a safe manner.

## Related information

- Cross Traffic Alert\* (p. 341)
- Limitations of Cross Traffic Alert (p. 343)
- Messages for Blind Spot Information\* and Cross Traffic Alert\* (p. 345)

## Limitations of Cross Traffic Alert

The Cross Traffic Alert (CTA) function may have limitations in certain situations.

CTA does not perform optimally in all situations but has some limitations. For example, the CTA sensors cannot "see" through other parked vehicles or obstructing obstacles.

Here are some examples of situations where CTA's "field of vision" may be already limited and approaching vehicles cannot therefore be detected until they are very close:

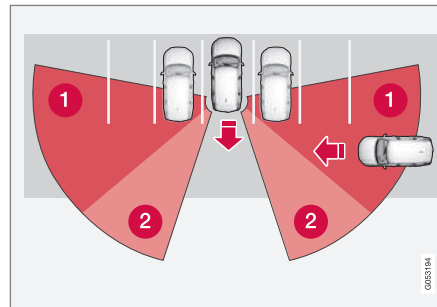

The car is parked deep inside a parking slot.

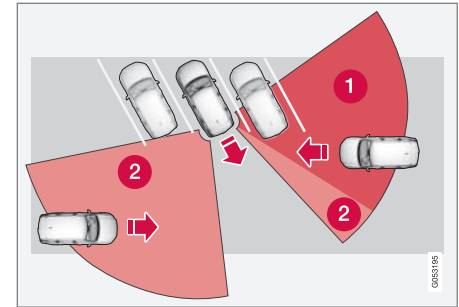

In an angled parking slot CTA may be completely "blind" on one side.

- 1 Blind CTA sector.
- 2 Sector in which CTA can detect/"see".

However, as your car slowly reverses, the angle it makes with the obstructing vehicle/object changes and the blind sector rapidly decreases.

Examples of further limitations:

- Dirt, ice and snow covering the sensors may reduce the functions and deactivate alerts.
- CTA is deactivated when a trailer is connected to the car's electrical system.

## Sensors

The sensors for the CTA function are located inside each corner of the rear wing/bumper. The sensors are also used by the Blind Spot Information (BLIS) function.



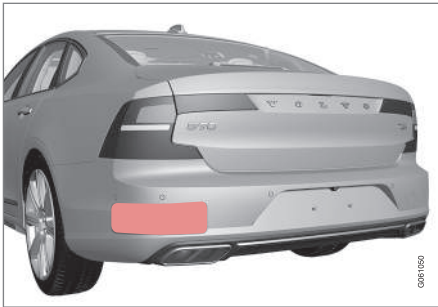

Keep the surface clean - on both the left and right-hand sides of the car<sup>18</sup>.

To ensure optimal functionality, the surfaces in front of the sensors must be kept clean.

Do not affix any objects, tape, labels or similar within the area of the sensors.

### **IMPORTANT**

Repair of the BLIS and CTA functions' components or repainting the bumpers must only be performed by a workshop - an authorised Volvo workshop is recommended.

### Related information

- Cross Traffic Alert\* (p. 341)
- Activate/deactivate Cross Traffic Alert\* (p. 342)

- Messages for Blind Spot Information\* and Cross Traffic Alert\* (p. 345)
- Limitations of Blind Spot Information\* (p. 341)

<sup>18</sup> NOTE: The illustration is schematic - details may vary depending on car model.

## Messages for Blind Spot Information\* and Cross Traffic Alert\*

The following table shows some examples.

A number of messages regarding Blind Spot Information (BLIS) and Cross Traffic Alert (CTA) can be shown in the driver display.

Message	Specification
Blind spot sensor Service required	The system does not function as it should. A workshop should be contacted - an authorised Volvo workshop is recommended.
Blind spot system off Trailer attached	BLIS and CTA have been deactivated as a trailer has been connected to the car's electrical system.

### Related information

- Blind Spot Information\* (p. 338)
- Activate/deactivate Blind Spot Information\* (p. 340)
- Limitations of Blind Spot Information\* (p. 341)
- Cross Traffic Alert\* (p. 341)
- Activate/deactivate Cross Traffic Alert\* (p. 342)
- Managing messages in the driver display and the centre display (p. 109)

## Road Sign Information\*

The Road Sign Information function (Road Sign Information – RSI) helps the driver to observe speed signs and certain prohibition signs as the car passes them.

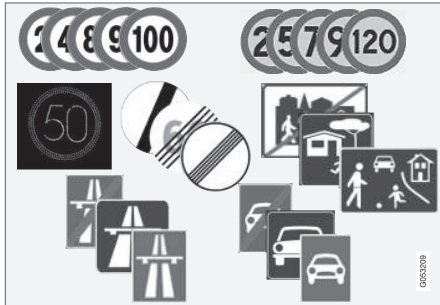

Examples of readable signs<sup>19</sup>.

RSI provides information about such things as current speed, when a motorway or road is starting/ending, when overtaking is prohibited or when the direction of travel is one-way.

In the case where both a sign for motorway/dual carriageway and a sign for the speed limit are passed, RSI selects to show a sign symbol for motorway/dual carriageway. The new speed limit is shown directly with a line in the driver display's speed scale.

<sup>19</sup> Road signs are market-dependent - illustrations in these instructions only show a few examples.

<sup>20</sup> Road signs are market-dependent - illustrations in these instructions only show a few examples.

## ⚠ WARNING

RSI does not work in all situations but is designed merely as a supplementary aid.

The driver always bears ultimate responsibility for ensuring that the vehicle is driven safely and that applicable road traffic rules and regulations are followed.

### Related information

- Sign display with Road Sign Information (p. 346)
- Speed camera information\* (p. 348)
- Activating/deactivating Road Sign Information (p. 349)
- Limitations of Road Sign Information\* (p. 350)

## Sign display with Road Sign Information

The Road Sign Information function (Road Sign Information - RSI) registers and shows road signs in different ways depending on the sign and the situation.

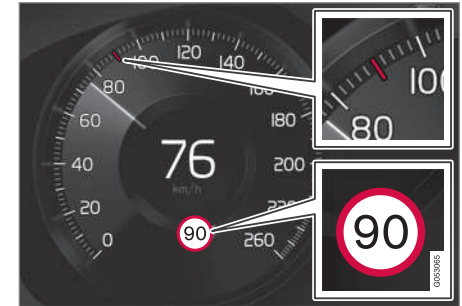

Example of detected speed information<sup>20</sup>.

When RSI detects a road sign with an imposed speed limit, the driver display shows the sign as a symbol plus an indication in red on the speedometer.





Besides the speed limit symbol an additional sign may be shown as well, such as "no overtaking".

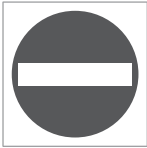

If the driver enters a road marked with a no-entry sign at the roadside, the symbol for this sign flashes on and off on the driver display as a warning.

If the car is equipped with Sensus Navigation\* then information from the map is also used to determine whether the car is being driven in the wrong direction.

The driver can also get an acoustic warning when driving towards a no-entry entrance if the **Audio Warning** function is activated - see the heading "Activating/deactivating the acoustic warning" in the section "Activating/deactivating Road Sign Information".

### End of restriction or motorway

If RSI detects a sign which may imply the end of a speed limit, such as the end of a motorway, the driver display shows the corresponding road sign for 10–30 seconds.

Examples of such signs are:

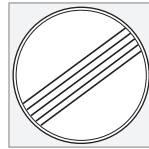

End of all restrictions.



End of motorway.

Following which, the sign information is hidden until the next speed-related sign is detected.

### Additional signs

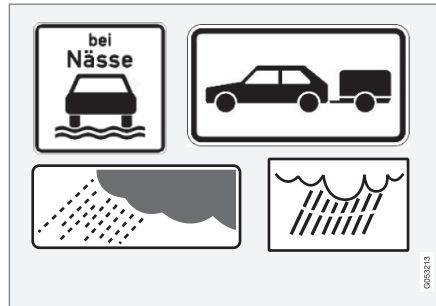

Examples of additional signs<sup>20</sup>.

Sometimes different speed limits are signed for the same road - an additional sign then indicates the circumstances under which the different speeds apply. The road section may be particularly susceptible to accidents in rain and/or fog, for example.

An additional sign relating to rain is displayed only if the windscreen wipers are in use.

If the car has a trailer attached and you pass a speed sign with the additional sign "trailer", the indicated speed will appear on the driver display.

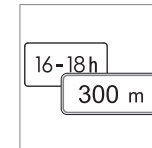

Some speed limits only apply after a certain distance or at a certain time of day. The driver's attention is drawn to this fact by means of a symbol for an additional sign below the speed symbol. The additional symbol

in the driver display will show either "DIST" or "TIME".

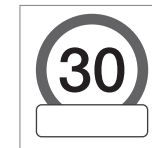

A symbol for additional sign in the form of an empty frame under the driver display's speed symbol means that the RSI has detected an additional sign with supplementary information for the current speed limit.

<sup>20</sup> Road signs are market-dependent - illustrations in these instructions only show a few examples.

## ◀ Sensus Navigation

If the car is equipped with Sensus Navigation, speed information is read from the navigation unit in the following cases:

- On detecting signs that indirectly indicate a speed limit, such as motorway, dual carriage-way and city limit signs.
- If a previously detected sign is assumed not to apply any longer, but no new sign has been detected.

**i NOTE**

If a downloaded third-party app is used for navigation then there is no support for speed-related information.

### Sign for "School" and "Children at play"



If the warning sign for "School" or "Children at play" is included in the satellite navigator's map data, the driver display shows a sign<sup>20</sup> of this type.

### Related information

- Road Sign Information\* (p. 346)
- Activating/deactivating Road Sign Information (p. 349)

## Speed camera information\*

A car equipped with Sensus Navigation can provide information on an upcoming speed camera in the driver display.



Speed camera warning in the driver display.



If the car exceeds a detected speed limit, the driver can be warned when the car approaches a speed camera, provided that the navigation maps for the market in question contain information on

speed cameras.

For more information on speed warning in connection with speed camera, see the heading "Activating/deactivating speed warnings" in the section "Activating/deactivating Road Sign Infor-

mation" as well as the section "Limitations for Road Sign Information".

**i NOTE**

Information about speed cameras in the navigation maps is not available for all markets.

### Related information

- Road Sign Information\* (p. 346)
- Activating/deactivating Road Sign Information (p. 349)
- Limitations of Road Sign Information\* (p. 350)

<sup>20</sup> Road signs are market-dependent - illustrations in these instructions only show a few examples.

## Activating/deactivating Road Sign Information

The Road Sign Information (Road Sign Information - RSI) function can be activated/deactivated.

### Activating/deactivating Road Sign Information



The function is activated/deactivated in function view in the centre display.

- Tap on the **Road Sign Information** button in function view.
  - > RSI is activated and the button shows a green indicator - a grey indicator means that RSI is deactivated.

### Activating/deactivating speed warnings

The speed warning function warns the driver when the applicable speed limit is exceeded. A speed warning is always given if the speed limit is exceeded in connection with speed camera information. The driver can choose to have the function activated or deactivated.



The speed warning is given by the driver display symbol showing the applicable maximum permitted speed temporarily flashing when this speed is exceeded.

1. Press **Settings** in the centre display's top view.
2. Press **My Car** → **IntelliSafe** → **Road Sign Information**.
3. Select **Speed Limit Warning** to activate/deactivate speed warnings.
  - > A speed selector is shown if the function is activated.
4. Adjust the limit for when a speed warning is to be given, either up or down, by pressing the up/down arrows.

Note that no consideration is given to any boundary adjustment made when the driver display shows the speed camera symbol.

### Activating/deactivating the acoustic warning.

It is also possible to have an acoustic warning in connection with a speed warning:

1. Press **Settings** in the centre display's top view.

2. Press **My Car** → **IntelliSafe** → **Road Sign Information**.
3. Select **Audio Warning** to activate/deactivate the acoustic warning.

With the **Audio Warning** function activated, the driver is also warned when driving towards a no-entry entrance.

### Related information

- Road Sign Information\* (p. 346)
- Speed camera information\* (p. 348)
- Sign display with Road Sign Information (p. 346)

## Limitations of Road Sign Information\*

The Road Sign Information Road Sign Information - RSI function may have limitations in certain situations.

Examples of things that can reduce the RSI function are as follows:

- Faded signs
- Signs positioned on bends
- Rotated or damaged signs
- Signs positioned high above the roadway
- Fully/partially obscured or poorly positioned signs
- signs completely or partly covered with frost, snow and/or dirt
- digital road maps<sup>21</sup> are out-of-date, inaccurate or have no speed information<sup>22</sup>.

### **i** NOTE

The RSI function can interpret some types of bicycle rack (connected to the electrical socket for trailers) as a connected trailer. In such cases the driver may be shown incorrect speed information.

<sup>21</sup> In cars equipped with Sensus Navigation.

<sup>22</sup> Map data with speed information is not available in all markets.

### **i** NOTE

The function uses the car's camera unit, which has some general limitations, see the "Limitations for camera unit" section.

### Related information

- Road Sign Information\* (p. 346)
- Activating/deactivating Road Sign Information (p. 349)
- Sign display with Road Sign Information (p. 346)
- Limitations of the camera unit (p. 325)

## Driver Alert Control

The Driver Alert Control function is intended to attract the driver's attention when he/she starts to drive less consistently, e.g. if he/she becomes distracted or starts to fall asleep.

The objective for DAC is to detect slowly deteriorating driving ability and it is primarily intended for major roads. The function is not intended for city traffic.

The function is activated when speed exceeds 65 km/h (40 mph) and remains active as long as the speed is over 60 km/h (37 mph).

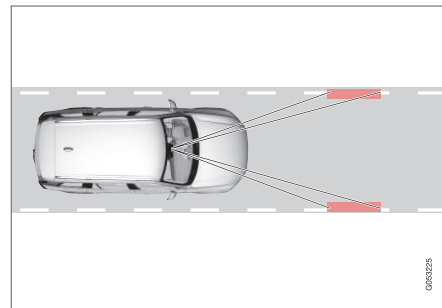

A camera detects the edge markings painted on the carriageway and compares the alignment of the road with the driver's steering wheel movements.

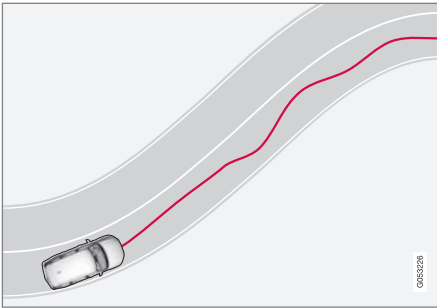

If driving behaviour becomes seriously erratic, the driver is alerted by means of an acoustic signal combined with a symbol in the driver display and the message **Time for a break soon?**

The warning is repeated after a time if driving ability does not improve.

### **i** NOTE

The function must not be used to extend a period of driving. Always plan breaks at regular intervals, and make sure you are well rested.

### **!** WARNING

An alarm should be taken very seriously, as a sleepy driver is often not aware of his/her own condition.

In the event of an alarm or a feeling of tiredness; stop the car in a safe manner as soon as possible and rest.

Studies have shown that it is equally as dangerous to drive while tired as it is under the influence of alcohol.

### **!** WARNING

Driver Alert Control does not work in all situations but is designed merely as a supplementary aid.

The driver always bears ultimate responsibility for ensuring that the vehicle is driven safely.

### Related information

- Activate/deactivate Driver Alert Control (p. 351)
- Limitations of Driver Alert Control (p. 352)

## Activate/deactivate Driver Alert Control

The Driver Alert Control (DAC) function can be activated/deactivated.

### Activate/deactivate Driver Alert Control

1. Tap on **Settings** in top view in the centre display.
2. Press **My Car** → **IntelliSafe** → **Driver Alert Control**.
3. Select **Alertness Warning** to activate/deactivate the DAC.

### **!** WARNING

Driver Alert Control does not work in all situations but is designed merely as a supplementary aid.

The driver always bears ultimate responsibility for ensuring that the vehicle is driven safely.

## Activating/deactivating the rest place guide in the event of a warning

It is possible to select whether the rest place guide shall be activated or deactivated. With the guide activated a proposal for a suitable rest place is presented at the same time as DAC gives a warning.

1. Tap on **Settings** in top view in the centre display.



2. Press **My Car** → **IntelliSafe** → **Driver Alert Control**.
3. Select **Rest Stop Guidance** to activate/deactivate the rest place guide.

### Related information

- Driver Alert Control (p. 350)
- Limitations of Driver Alert Control (p. 352)

## Limitations of Driver Alert Control

The Driver Alert Control (DAC) function may have limitations in certain situations.

In some cases, driving behaviour may not be affected, despite the driver being tired - e.g. when using the Pilot Assist function - with the result that the driver is then not given a warning from DAC. For this reason, it is always very important to stop and take a break in the event of the slightest sign of driver fatigue, regardless of whether DAC has given a warning.

In some cases the system may issue a warning despite driving ability not deteriorating, for example:

- in strong side winds
- on rutted road surfaces.

### NOTE

The function uses the car's camera unit, which has some general limitations, see the "Limitations for camera unit" section.

### Related information

- Driver Alert Control (p. 350)
- Activate/deactivate Driver Alert Control (p. 351)
- Limitations of the camera unit (p. 325)
- Pilot Assist\* (p. 302)

## Lane Keeping Aid

The function of lane assistance is to help the driver to reduce the risk of the car accidentally leaving its own lane on motorways and similar major routes.

Lane assistance steers the car back into its lane and/or warns the driver with an acoustic signal or steering wheel vibration.

Lane Keeping Aid is active within the speed range 65-200 km/h (40-125 mph) on roads with clearly visible side lines.

On narrow roads the function may be unavailable, in which case it goes into standby mode. The function becomes available again when the road is wide enough.

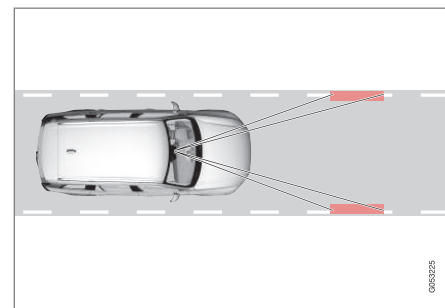

A camera reads the side lines of the road/lane.

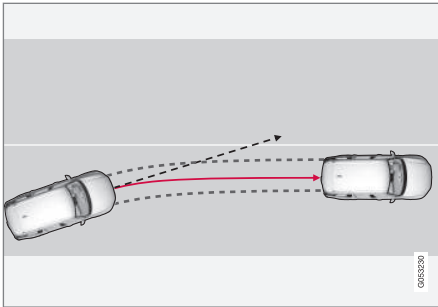

Lane assistance steers the car back into its lane.

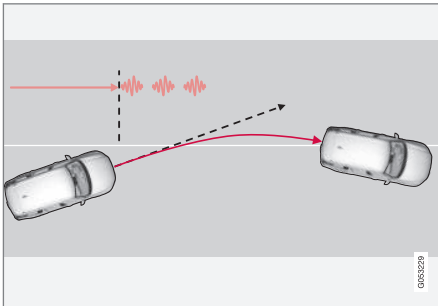

Lane assistance warns with steering wheel vibrations<sup>23</sup>.

Depending on settings, lane assistance acts in accordance with the following:

1. Steering assistance activated: When the car is approaching a lane line, LKA will actively

steer the car back into its lane by applying a slight torque to the steering wheel.

2. Warning activated: If the car is about to cross a lane line, the driver is warned by means of an acoustic signal or vibration in the steering wheel.

### **i** NOTE

When a direction indicator is switched on, there are no steering corrections or alerts from Lane assistance.

### **⚠** WARNING

Lane assistance is merely a driver aid and does not engage in all driving situations or traffic, weather or road conditions.

The driver always bears ultimate responsibility for ensuring that the vehicle is driven safely and that applicable laws and road traffic regulations are followed.

### Steering assistance

A precondition for the functioning of the LKA steering assistance is that the driver's hands are holding the steering wheel. The system monitors this continuously.

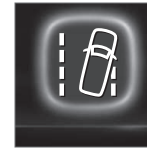

If the driver does not keep his/her hands on the steering wheel, the driver display shows this symbol and the following message, to prompt the driver to actively steer the car:

- **Lane Keeping Aid Apply steering**

If the driver does not then start to steer, the symbol is shown again, combined with a warning sound and this message:

- **Lane Keeping Aid Standby until steering applied**

If the driver then still does not follow the prompt to start steering, LKA is set in standby mode - the function will then be unavailable until the driver starts to steer the car again.

<sup>23</sup> The steering wheel vibration varies - the longer the car remains outside the lane lines, the longer the vibration.

## ◀ Lane assistance does not intervene

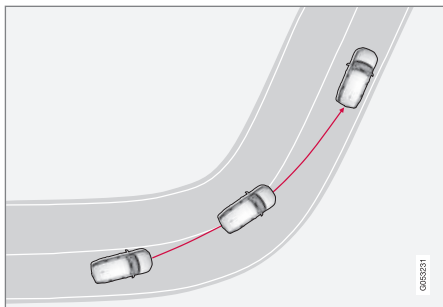

Lane assistance does not engage on sharp inside curves.

In some situations, lane assistance allows lane lines to be crossed without intervening with either steering assistance or a warning - e.g. when using the direction indicators or cutting bends.

### Limitations

In certain demanding conditions lane assistance may have difficulty helping the driver correctly. In such cases it is recommended to switch off this function.

Examples of such conditions are:

- road works
- winter road conditions
- poor road surface
- a very "sporty" driving style

- poor weather with reduced visibility
- sharp edges or lines other than the lane lines
- roads with unclear or non-existent line markings.

### **i** NOTE

The function uses the car's camera unit, which has some general limitations, see the "Limitations for camera unit" section.

### Related information

- Activate/deactivate Lane Keeping Aid (p. 354)
- Run-off Mitigation (p. 358)
- Symbols and messages for lane assistance (p. 356)
- Limitations of the camera unit (p. 325)

## Activate/deactivate Lane Keeping Aid

Lane assistance Lane Keeping Aid (LKA) can be activated/deactivated and some subfunctions can be selected.



The function is activated/deactivated in function view in the centre display.

- Tap on the **Lane Keeping Aid** button in function view.
  - > LKA is activated (GREEN button indication is shown) or deactivated (GREY button indication is shown).

### Select the type of warning for the Lane Keeping Aid

It is possible to select how LKA shall warn the driver if the car leaves its lane.

1. Press **Settings** in the centre display's top view.
2. Press **My Car** → **IntelliSafe** → **Lane Assistance**.



3. Under **Lane Keeping Aid Warning Feedback**, select type of warning:
  - **Sound** - the driver is warned by an acoustic signal.
  - **Vibration** — the driver is warned with steering wheel vibrations.

### Assistance options for Lane Keeping Aid

It is possible to select how LKA shall react if the driver if the car leaves its lane.

1. Press **Settings** in the centre display's top view.
2. Press **My Car → IntelliSafe → Lane Assistance**.
3. Under **Lane Keeping Aid Mode**, select how LKA shall react
  - **Assist** - the driver is given steering assistance without a warning.
  - **Both** - the driver is given both a warning and steering assistance.
  - **Warning** — warning to driver only.

### Related information

- Lane Keeping Aid (p. 352)
- Symbols and messages for lane assistance (p. 356)

## Symbols and messages for lane assistance

A number of symbols and messages regarding lane assistance can be shown on the driver display.

### Symbol in the driver display



Lane assistance is visualised by symbols in the driver display depending on the situation.

Here are some examples of symbols and the situations in which they are shown:

### Available



Available — the lane lines in the symbol are white.

Lane assistance is scanning one or both lane lines.

### Unavailable



Unavailable — the lane lines in the symbol are grey.

The lane assistance cannot detect the lane lines, the speed is too low or the road is too narrow.

### Indication of steering assistance/warning







Steering assistance/warning - the lane lines in the symbol are in colour.

Lane assistance indicates that the system is giving a warning and/or attempting to steer the car back into the lane.

### Symbols and messages

The following table shows some examples.

Symbol	Message	Specification
	<b>Driver support system</b> <b>Reduced functionality Service required</b>	The system does not function as it should. A workshop should be contacted - an authorised Volvo workshop is recommended.
	<b>Windscreen sensor</b> <b>Sensor blocked, see Owner's manual</b>	The ability of the camera to scan the roadway in front of the car is reduced.
	<b>Lane Keeping Aid</b> <b>Apply steering</b>	The LKA steering assistance does not function if the driver does not hold the wheel. Follow the instruction and steer the car.
	<b>Lane Keeping Aid</b> <b>Standby until steering applied</b>	LKA is set in standby mode until the driver starts to steer the car again.

### Related information

- Lane Keeping Aid (p. 352)
- Activate/deactivate Lane Keeping Aid (p. 354)

## Run-off Mitigation

The function of Run-off Mitigation is to assist the driver to reduce the risk of the car accidentally leaving the road by means of actively steering the car back onto the road.

The function is active within the speed range 65-140 km/h (40-87 mph) on roads with clearly visible side markings/lane lines.

A camera scans the edges of the road and the painted side markings. If the car is about to cross the edge of the road, Run-off Mitigation will actively steer the car back onto the road. In addition, if steering intervention is considered insufficient to avoid run-off, brake intervention may also be activated.

Run-off Mitigation does not intervene with either steering assistance or brake intervention if the direction indicators are used. If the function detects that the driver is driving the car in an active way, activation of Run-off Mitigation will be suppressed for a short time.

The function has two activation levels:

- Steering assistance only
- Steering assistance with brake intervention

### Run-off Mitigation with steering assistance

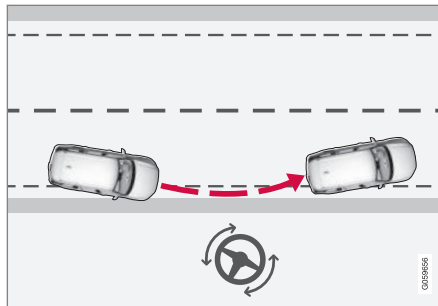

Run-off Mitigation intervenes with steering assistance.

### Run-off Mitigation with steering assistance and brake intervention

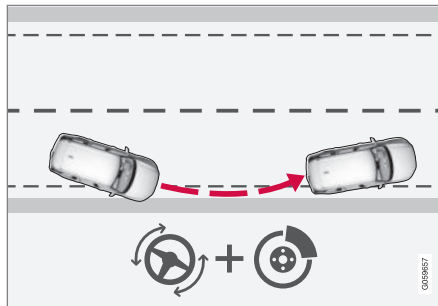

Run-off Mitigation intervenes with steering assistance and braking.

Brake intervention helps in situations where steering assistance alone is not sufficient. The brake force is adapted automatically depending on the situation at the time of run-off.

### Settings for Run-off Mitigation

The Run-off Mitigation function is selectable - the driver can select On or Off by dragging down the centre display's top view and there searching for the following:

**Settings → My Car → IntelliSafe → Lane Assistance**

To activate Run-off Mitigation:

- Select the box at **Collision Avoidance Assistance, Steering aid during increased collision risk** - the function is then activated.

The current setting for Run-off Mitigation when the engine is switched off remains the next time the engine is started.

### Limitations of Run-off Mitigation

In certain demanding conditions, Run-off Mitigation may have difficulty helping the driver correctly. In such cases, it is recommended that the function be switched off.

Examples of such conditions are:

- road works
- winter road conditions

- narrow roads
  - poor road surface
  - a very "sporty" driving style
  - poor weather with reduced visibility
  - roads with unclear or non-existent side markings
  - sharp edges or lines other than the lane's side markings.
- Limitations of the camera unit (p. 325)

** WARNING**

The road run-off protection function is only a driver aid and does not work in all driving situations, traffic, weather and road conditions.

The function cannot detect barriers, rails or similar obstacles at the side of the road.

The driver always bears ultimate responsibility for ensuring that the vehicle is driven safely and that applicable laws and road traffic regulations are followed.

** NOTE**

The function uses the car's camera unit, which has some general limitations, see the "Limitations for camera unit" section.



**Related information**

- Symbols and messages for Run-off Mitigation (p. 360)
- Lane Keeping Aid (p. 352)

## Symbols and messages for Run-off Mitigation

A number of symbols and messages regarding the Run-off Mitigation Run-off Mitigation can be shown in the driver display.

The following table shows some examples.

Symbol	Message	Specification
	<b>Automatic intervention</b> <b>City Safety</b>	When Run-off Mitigation is activated, a message is shown to the driver informing that the system has been activated.
	<b>Driver support system</b> <b>Reduced functionality Service required</b>	The system does not function as it should. A workshop should be contacted - an authorised Volvo workshop is recommended.
	<b>Windscreen sensor</b> <b>Sensor blocked, see Owner's manual</b>	The ability of the camera to scan the roadway in front of the car is reduced.

### Related information

- Run-off Mitigation (p. 358)

## Park Assist\*

Parking assistance assists the driver when manoeuvring in tight spaces by indicating the distance to obstacles by acoustic signals combined with graphics on the centre display.

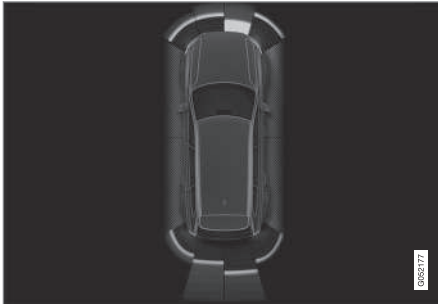

Screen view showing obstacle zones and sensor sectors.

The centre display shows an overview of the relationship between the car and detected obstacles.

The highlighted sector indicates the location of the obstacle. The closer the car symbol is to a highlighted sector box, the shorter the distance between the car and detected obstacle.

The shorter the distance to the obstacle, the faster the signal sounds. Other sound from the audio system is muted automatically.

The acoustic signal for obstacles ahead and to the sides is active when the car is moving but stops after the car has been stationary for

approx. 2 seconds. The acoustic signal for obstacles behind is also active when the car is stationary.

At a distance within 30 cm from an obstacle behind or in front of the car, the tone is constant and the active sensor's field closest to the car symbol is filled.

The volume of the parking assistance signal can be adjusted while the signal is sounding by means of the **[>||]** knob on the centre console. Adjustment can also be performed in the top view's **Settings** menu option.

### **i** NOTE

- Acoustic warnings are only given for objects directly on the vehicle's route.

### **⚠** WARNING

- Parking assistance does not relinquish the driver's own responsibility during parking.
- The sensors have blind spots where obstacles cannot be detected.
- Be aware of e.g. people or animals near the car.

## Backwards

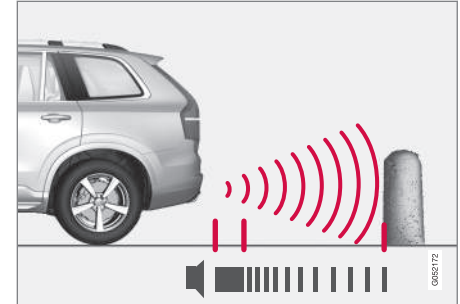

NOTE: The illustration is schematic - details may vary depending on car model.

The sensors for reverse are activated if the car rolls backward without a gear engaged or when the gear lever is moved to reverse position.

The measuring range starts approx. 1.5 metres behind the car.

When reversing with a hitched trailer, parking assistance backward is deactivated automatically.

### **i** NOTE

When reversing with e.g. a trailer or bike carrier on the towbar - without Volvo genuine trailer wiring - parking assistance may need to be switched off manually in order that the sensors do not react to them.



◀ Along the sides

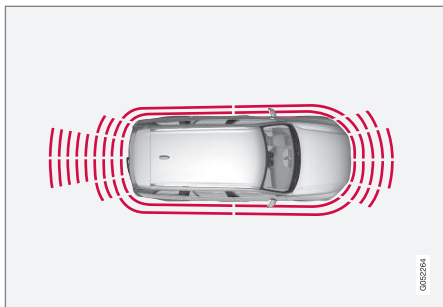

Parking assistance side sensors are activated automatically when the engine is started. They are active at speeds below 10 km/h (6 mph).

The measuring range starts approx. 30 cm from the sides. The acoustic signal for obstacles on the sides comes from the side loudspeakers.

Forwards

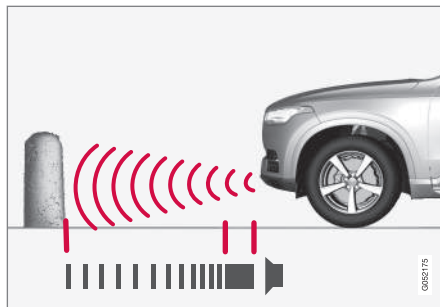

NOTE: The illustration is schematic - details may vary depending on car model.

The front parking assistance sensors are activated automatically when the engine is started. The front sensors are active at speeds below 10 km/h (6 mph).

The measuring range starts approx. 0.8 metres in front of the car.

**i NOTE**

Parking assistance is deactivated when the parking brake is applied or **P** mode is selected in a car with an automatic gearbox.

**! IMPORTANT**

When auxiliary lamps are fitted: Remember that these must not obscure the sensors - the auxiliary lamps may then be perceived as an obstacle.

**Related information**

- Activating/deactivating Parking assistance\* (p. 363)
- Limitations of Parking assistance\* (p. 363)
- Messages for Park Assist\* (p. 365)
- Park Assist Camera\* (p. 366)
- Park Assist Pilot\* (p. 372)



## Activating/deactivating Parking assistance\*

The Parking assistance function can be activated/deactivated.

The front and side parking assistance sensors are activated automatically when the engine is started. The rear sensors activate if the car rolls backwards or if reverse gear is engaged.



The function is activated/deactivated in function view in the centre display.

Parking assistance can also be activated/deactivated from the camera views.

- Tap on the **Park Assist** button in function view.
- > Parking assistance is activated/deactivated, a green/grey indicator is displayed in the button.

### Related information

- Park Assist\* (p. 361)
- Cross Traffic Alert\* (p. 341)

## Limitations of Parking assistance\*

The Parking assistance function may have limitations in certain situations.

### **i** NOTE

Since a towbar is configured with the car's electrical system, towbar protrusion is included when the function measures the distance to an object behind the car.

### **!** IMPORTANT

Objects e.g. chains, thin glossy poles or low barriers may be in the "signal shadow" and are then temporarily not detected by the sensors - the pulsating tone may then unexpectedly stop instead of changing over to the expected constant tone.

The sensors cannot detect high objects, such as projecting loading docks.

- In such situations, pay extra attention and manoeuvre/reposition the car particularly slowly or stop the current parking manoeuvre - there may be a high risk of damage to vehicles or other objects since information from the sensors is not always reliable in such situations.

### **!** IMPORTANT

In certain conditions the parking assistance system may produce incorrect warning signals that are caused by external sound sources that emit the same ultrasonic frequencies that the system works with.

Examples of such sources include horns, wet tyres on asphalt, pneumatic brakes and exhaust noises from motorcycles, etc.

## Maintenance

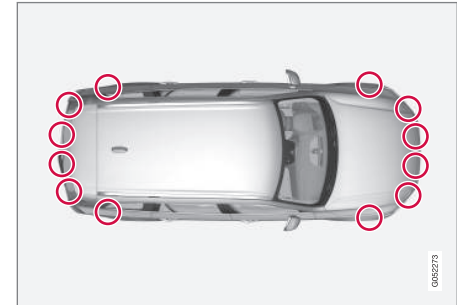

Location of the parking sensors<sup>24</sup>.

For parking assistance to work optimally, the parking assistance sensors must be cleaned regularly with water and car shampoo.

<sup>24</sup> NOTE: The illustration is schematic - details may vary depending on car model.



**i NOTE**

Dirt, ice and snow covering the sensors may cause incorrect warning signals, reduced or no function.

**Related information**

- Park Assist\* (p. 361)
- Activating/deactivating Parking assistance\* (p. 363)
- Messages for Park Assist\* (p. 365)

## Messages for Park Assist\*

A number of messages regarding Park Assist can be shown in the driver display.

The following table shows some examples.

Message	Specification
<b>Park Assist System Unavailable Service required</b>	The system does not function as it should. A workshop should be contacted - an authorised Volvo workshop is recommended.
<b>Park Assist System Sensors blocked, cleaning needed</b>	One or more of the system's sensors are blocked - check and correct as soon as possible.

### Related information

- Park Assist\* (p. 361)
- Activating/deactivating Parking assistance\* (p. 363)
- Limitations of Parking assistance\* (p. 363)

## Park Assist Camera\*

The Park Assist Camera helps the driver when manoeuvring in tight spaces by indicating obstacles with a camera image and graphics in the centre display.

### Overview

The Park Assist Camera is activated either automatically, when reverse gear is selected or manually via the centre display - depending on the selected setting.



- 1 **Lines** - activates/deactivates park assist lines
- 2 **Towbar\*** - activates/deactivates the towbar assist line\*<sup>25</sup>
- 3 **PAS\*** - activates/deactivates Parking assistance

<sup>25</sup> Not available in all markets.

<sup>26</sup> The park assist lines are switched off when zooming in.

- 4 **CTA\*** - activate/deactivate Cross Traffic Alert
- 5 **Zoom<sup>26</sup>** - zoom in/out

### WARNING

- The parking camera serves as an aid. It does not relieve the driver of responsibility when reversing.
- The camera has blind spots, where obstacles cannot be detected.
- Be aware of people and animals in the vicinity of the car.

### Camera views

The function can display a composite 360° view and separate views for each of the four cameras: rear, front, left or right camera view. The uppermost in the selected view denotes which camera is active.

### 360° view camera\*

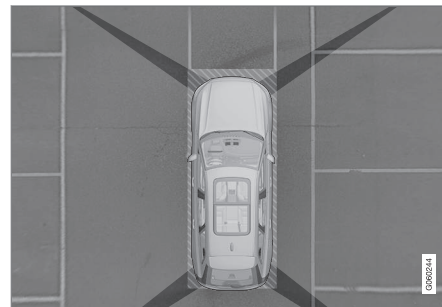

The approximate coverage area of the Park Assist Cameras.

The four sides of the car are shown simultaneously in the centre display, which helps the driver to observe what is around the car when manoeuvring at slow speeds.

Every camera view can be activated separately by tapping on the screen on the desired camera's "field of vision" - e.g. in front of or above the front camera.

If the car is also equipped with Parking assistance\* then distance to detected obstacles is illustrated with fields in different colours.

## Backwards



The backwards-facing camera<sup>27</sup> is fitted above the registration plate.

The backward-facing camera shows a wide area behind the car. For certain models, part of the bumper can be seen as well as the towbar in some cases.

Objects shown in the centre display may appear slightly tilted — this is normal.

### **i** NOTE

Objects on the centre display may be closer to the car than they appear to be on the screen.

## Forwards



The forwards parking camera<sup>27</sup> is located in the grille.

The front camera can be helpful on an exit road with limited visibility to the sides, e.g. when there are high hedges. It is active at speeds up to 25 km/h (16 mph) - following which, the front camera is switched off.

If the car does not reach 50 km/h (30 mph), and the speed falls below 22 km/h (14 mph) within 60 seconds after the forward-facing camera has been switched off, the camera is reactivated.

### **i** NOTE

Automatic reactivation of the front camera on speed reduction requires that **Auto Camera Reverse Activation** is selected in **Settings** → **My Car** → **Park Assist**.

## The sides



The side cameras<sup>27</sup> are positioned in each door mirror.

The side cameras show what is along each side of the car.

### Related information

- Starting the Park Assist Camera\* (p. 370)
- Park assist lines and fields for the Park Assist Camera\* (p. 368)
- Limitations of the Park Assist Camera\* (p. 371)
- Park Assist\* (p. 361)
- Cross Traffic Alert\* (p. 341)
- Park Assist Pilot\* (p. 372)

<sup>27</sup> The illustration is schematic - details may vary depending on car model.

## Park assist lines and fields for the Park Assist Camera\*

The Park Assist Camera indicates the position of the car in relation to its surroundings by displaying lines on the camera image.

### Park assist lines

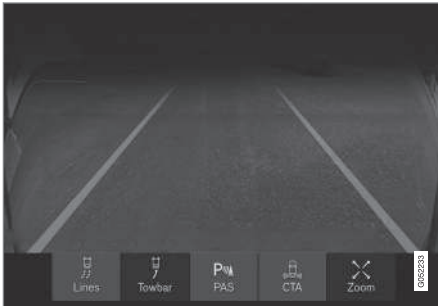

Examples of how the park assist lines can be displayed for the driver.

Park assist lines show the intended route for the car's external dimensions with the current steering wheel angle - this facilitates parallel parking, reversing into tight spaces and when connecting a trailer.

The lines on the screen are projected as if they were at ground level behind the car and respond directly to steering wheel movements, showing the driver the path the car will take - also when the car is turning.

These park assist lines include the car's most protruding parts, e.g. towbar, door mirrors and corners.

#### **i** NOTE

Park assist lines are not shown when zooming in.

#### **i** NOTE

- When reversing with a trailer which is not connected electrically to the car, the lines on the display show the route the **car** will take - not the trailer.
- The screen shows no lines when a trailer is connected electrically to the car's electrical system.

#### **i** IMPORTANT

Remember that when rear camera view is selected, the centre display only shows the area behind the car. Keep an eye on the sides and front of the car when turning the steering wheel while reversing.

The same applies vice versa - note what happens to the rear parts of the car when the front camera view is selected.

Note that the guide lines show the **shortest** route. Therefore, pay extra attention to the car's sides so that they do not go against/over something when the steering wheel is turned when driving forward or that the front sweeps against/over something when the steering wheel is turned when reversing.

### Park assist lines in 360° view\*

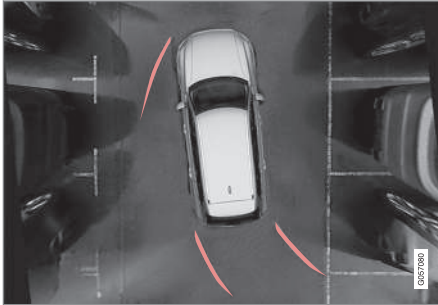

360° view with park assist lines.

With the 360° view, park assist lines are shown behind, in front of and at the side of the car (depending on the direction of travel):

- When driving forwards: Front lines
- When reversing: Side lines and reversing lines.

If front camera or reversing camera has been selected, park assist lines are displayed without regard to the car's direction of travel. The selected side camera is used to show the park assist lines only while reversing.

### Towbar assist line

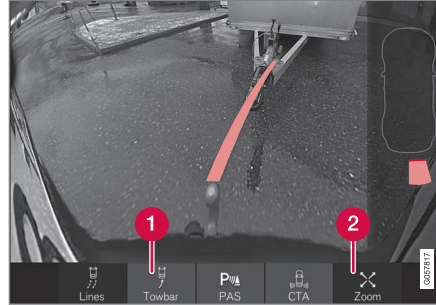

Towbar with assist line.

- 1 Towbar** - activates the towbar assist line\*.
- 2 Zoom** - zoom in/out.

The camera can facilitate connecting up to a trailer by showing an assist line representing the towbar's intended "path" to the trailer.

1. Press **Towbar** (1).
  - > The assist line for the intended "path" of the towbar is shown. At the same time the car's park assist lines are extinguished.
2. Press **Zoom** (2) when a more precise manoeuvring is required.
  - > The camera view zooms in.

Park assist lines for both car and towbar cannot be shown at the same time.

### Sensor field from Parking assistance\*

If the car is equipped with Parking assistance\* then the distance is shown in the 360° view with coloured fields for each sensor that registers an obstacle.

### Sensor fields backwards and forwards



The screen can show coloured sensor fields on the car symbol to the right.

The fields for the front and reversing sensors change colour as the distance to the obstacle decreases — from yellow through orange to red.

Colours of front and reversing fields	Distance (metres)
Yellow	0,6–1,5
Orange	0,4–0,6
Red	0–0,4



#### ◀ Sensor field to the sides

The side fields are only shown in orange.

Colour of side fields	Distance (metres)
Orange	0-0.3

#### Related information

- Park Assist Camera\* (p. 366)
- Starting the Park Assist Camera\* (p. 370)
- Limitations of the Park Assist Camera\* (p. 371)

#### Starting the Park Assist Camera\*

The Park Assist Camera can be made to start automatically when reverse gear is selected or manually via the centre display.

#### Starting the Park Assist Camera

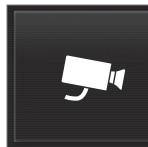

To start the park assist camera manually:

- Press the **Camera** button in the centre display's function view.
  - > The Park Assist Camera is started.

#### Camera start in different situations

When the button is tapped, the vehicle's speed and direction determine whether the camera starts in top view or front view:

- Top view: When stationary and moving forward - 0-15 km/h (0-9 mph).
- Top view: When stationary and moving backward - independent of speed.
- Front view: When moving forward 15-22 km/h (9-14 mph).

#### Activating/deactivating automatic start of the Park Assist Camera

It is possible to activate/deactivate the automatic starting of the Park Assist Camera when reverse gear is selected.

1. Press **Settings** in the centre display's top view.
2. Press **My Car** → **Park Assist**.
3. Select **Auto Camera Reverse Activation** to activate/deactivate automatic start.

#### Automatic deactivation of camera

The front view is extinguished at 25 km/h (16 mph) to avoid distracting the driver. If the **Auto Camera Reverse Activation** setting is selected, the camera is reactivated automatically at 22 km/h (14 mph) within 60 seconds. If speed exceeds 50 km/h (31 mph) then the front view is not reactivated.

Other camera views are extinguished at 15 km/h (9 mph) and not reactivated.

#### Select basic view for Park Assist Camera backward

With the **Auto Camera Reverse Activation** function selected, the driver can also select which camera function should be activated for reversing - the rearward-facing camera or the 360° view\*.

1. Press **Settings** in the centre display's top view.



2. Press **My Car** → **Park Assist**.
3. Select **Rear View Instead of 360°** to activate/deactivate the rear camera view as basic view.

### Related information

- Park assist lines and fields for the Park Assist Camera\* (p. 368)
- Limitations of the Park Assist Camera\* (p. 371)
- Ignition positions (p. 383)

## Limitations of the Park Assist Camera\*

The Park Assist Camera function may have limitations in certain situations.

The Park Assist Camera cannot see all objects in every situation - a driver should be aware of the following limitations:

### NOTE

A bike carrier or other accessory mounted on the rear of the car could obscure the camera's view.

### Blind sectors

Pay attention to the possibility that, even if it only looks like a relatively small part of the image is obscured, it could be a relatively large sector that is hidden from view. Obstacles could thereby go undetected until the car is very close to the obstacle.

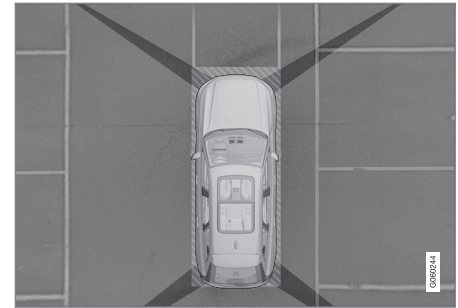

There are "blind" sectors between the cameras' fields of vision.

In 360° view obstacles/objects can "vanish" in the gaps between the individual cameras.

### Defective camera

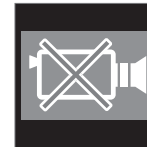

If a camera sector is black and contains this symbol then it means that the camera is out of order. The following illustration shows an example.

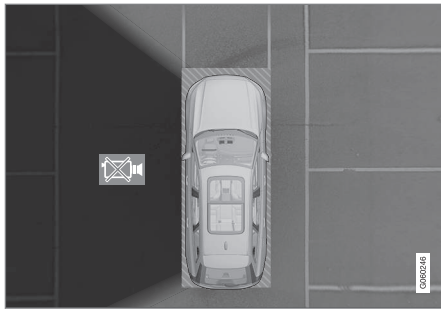

The car's left-hand camera is out of order.

### Black camera sector

A black camera sector is also shown in the following instances, but then **without** the symbol for defective camera:

- open door
- open tailgate
- folded-in door mirror.

### Light conditions

The camera image is adjusted automatically according to prevailing light conditions. Because of this, the image may vary slightly in brightness and quality. Poor light conditions can result in reduced image quality.

### Maintenance

Clean camera lenses regularly with lukewarm water and car shampoo - be careful not to scratch the lenses.

#### NOTE

Keep the camera lens clear of dirt, snow and ice to ensure optimum function. This is particularly important in poor light.

### Related information

- Park Assist Camera\* (p. 366)
- Starting the Park Assist Camera\* (p. 370)
- Park assist lines and fields for the Park Assist Camera\* (p. 368)

### Park Assist Pilot\*

Active parking assistance (Park Assist Pilot - PAP) helps the driver to park in or leave a parking space.

PAP checks first if a space is sufficiently big and thereafter helps the driver to turn the steering wheel and manoeuvre the car into the space.

The centre display indicates with symbols, graphics and text the various operations to be carried out and when to do so.

#### NOTE

The PAP function measures the space and steers the car - the driver's task is to:

- keep a close watch around the car
- follow the instructions in the centre display
- change gear (reverse/forward)
- control and maintain a safe speed
- brake and stop.

**⚠ WARNING**

PAP does not work in all situations but is designed merely as a supplementary aid.

The driver always has the final responsibility for driving the car in a safe manner and for paying attention to the surroundings and other road users approaching or passing while parking.

**Types of parking situations**

PAP can be used for the following different parking situations.

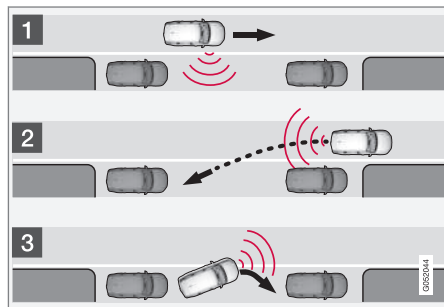
**Parallel parking**

The principal of parallel parking.

The PAP function parks the car using the following steps:

1. A parking space is identified and measured.
2. The car is reversed into the space.

3. The car is positioned in the space by means of driving forward/backward.

Using the **Park Out** function, a parallel-parked car can also be assisted by PAP to leave the parking space - see the heading "Leaving a parking space" in the section "Parking with Active parking assistance".

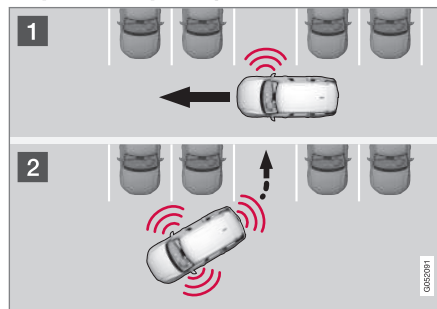
**Perpendicular parking**

Principle for perpendicular parking.

The PAP function parks the car using the following steps:

1. A parking space is identified and measured.
2. The car is reversed into the space and then positioned in the space by means of driving forward/backward.

**ⓘ NOTE**

A perpendicular-parked car **cannot** be assisted by the PAP **Park Out** function to leave a parking space - the function must only be used for a parallel-parked car.

**Related information**

- Parking with Active parking assistance\* (p. 374)
- Limitations of Park Assist Pilot\* (p. 377)
- Messages for Park Assist Pilot\* (p. 379)

## Parking with Active parking assistance\*

The Active parking assistance (Park Assist Pilot - PAP) helps the driver park in three steps. The function can also help the driver to leave a parking space.

### **i** NOTE

The PAP function measures the space and steers the car - the driver's task is to:

- keep a close watch around the car
- follow the instructions in the centre display
- change gear (reverse/forward)
- control and maintain a safe speed
- brake and stop.

PAP can be activated if the following criteria are met once the engine has been started:

- No trailer is attached to the car.
- Speed must be lower than 30 km/h (20 mph).

### **i** NOTE

The distance between the car and parking spaces should be 0.5-1.5 metres while PAP is searching for a parking space.

## Parking

The PAP function parks the car using the following steps:

1. A parking space is identified and measured.
2. The car is reversed into the space.
3. The car is positioned into the space - the system may then request that the driver changes gear.

### Finding and measuring parking spaces



The function can be activated in the centre display's function view.

It can also be accessed from the camera views.

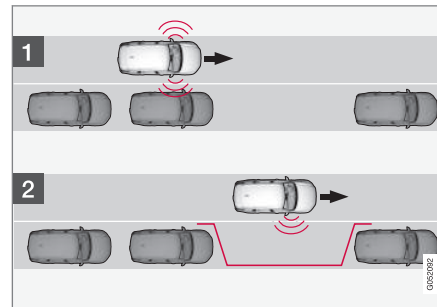

Principle for parallel parking.

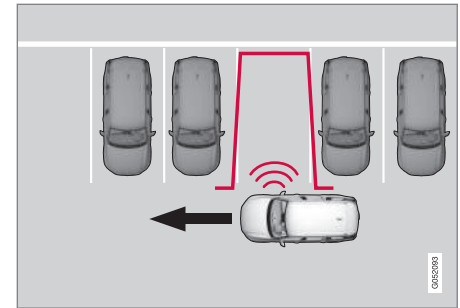

Principle for perpendicular parking.

1. Drive no faster than 30 km/h (20 mph) for parallel parking or 20 km/h (12 mph) for perpendicular parking.
2. Tap on the **Park In** button in function view.
  - > PAP searches for a parking space and checks whether it is big enough.
3. Keep an eye on the centre display - be ready to stop the car when the graphic and message indicate that a suitable parking space has been found.
  - > A pop-up window is shown.
4. Select **Parallel parking** or **Perpendicular parking** and select reverse gear.

**i NOTE**

PAP searches the area for parking, displays instructions and guides the car in on its passenger side. But if required the car can also be parked on the driver's side of the street:

- Activate the direction indicator to the driver's side - then the system searches for a parking space on that side of the car instead.

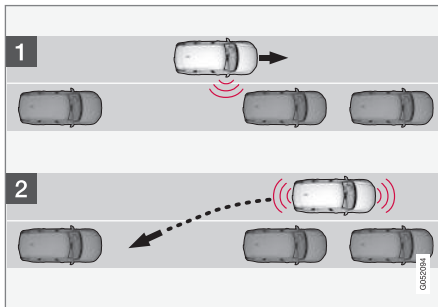
**Reversing in to the parking space**

Parallel.

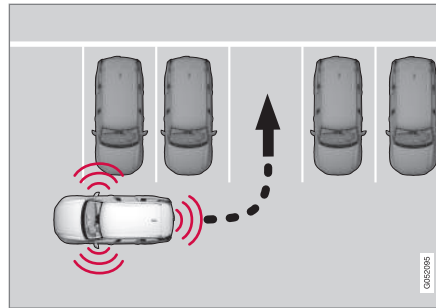

Perpendicular.

1. Check that there is nothing behind.
2. Reverse slowly and carefully without touching the steering wheel - and no faster than 7 km/h (4 mph).  
> PAP will then steer the car into the parking space.
3. Keep an eye on the centre display - be prepared to stop the car when the graphics and message so request.

**i NOTE**

- Keep your hands away from the steering wheel when the PAP function is activated.
- Make sure that the steering wheel is not hindered in any way and can rotate freely.
- To achieve optimum results - wait until the steering wheel is fully turned before starting to drive backward/forward.

◀◀ **Positioning the car in the parking space**

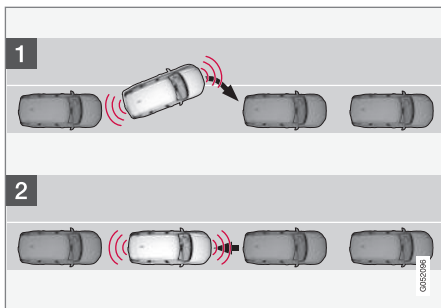

Parallel.

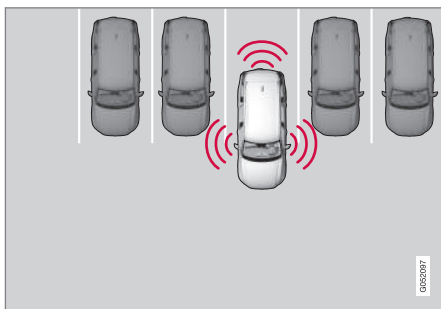

Perpendicular.

1. Move the gear selector into the **D** position, wait until the steering wheel has been turned and drive slowly forward

2. Keep an eye on the centre display - be prepared to stop the car when the graphics and message so request.
3. Select reverse gear and drive slowly backwards.
4. Keep an eye on the centre display - be prepared to stop the car when the graphics and message so request.

The function is deactivated automatically and the graphics and message show that parking is complete. It may be necessary for the driver to correct the car's position. Only the driver can determine whether the car is properly parked.

**!** **IMPORTANT**

The warning distance is shorter when the sensors are used by PAP compared with when Park Assist uses the sensors.

**Leaving a parking space**

**i** **NOTE**

When leaving a parking space, the **Park Out** function must only be used for a parallel-parked car - it does not work for a perpendicular-parked car.



The **Park Out** function is activated in the centre display's function view.

1. Tap on the **Park Out** button in function view.
2. Use the direction indicator to select the direction in which the car should leave the parking space.
3. Keep an eye the centre display, follow the instructions in the same way as during parking.

Note the steering wheel can "spring" back when the function is completed - the driver may then need to turn the steering wheel back to the maximum steering angle in order to leave the parking space.

If PAP considers that the driver can leave the parking space without any extra manoeuvring then the function will be stopped, even if the driver may consider that the car is still in the parking space.

**Related information**

- Park Assist Pilot\* (p. 372)
- Limitations of Park Assist Pilot\* (p. 377)
- Messages for Park Assist Pilot\* (p. 379)

## Limitations of Park Assist Pilot\*

The Active parking assistance (Park Assist Pilot – PAP) function may have limitations in certain situations.

### Parking is discontinued

A parking sequence will be discontinued:

- if the driver moves the steering wheel
- if the car is driven too quickly - above 7 km/h (4 mph)
- if the driver presses **Cancel** in the centre display
- when the anti-lock brakes or the Electronic stability control are engaged - e.g. when a wheel loses grip on a slippery road.

Where applicable, a message in the centre display states the reason for a parking sequence being discontinued.

### **i** NOTE

Dirt, ice and snow covering the sensors will reduce their function and may prevent measurement.

### **!** IMPORTANT

Under certain circumstances, PAP is unable to find parking spaces - one reason for this may be the fact that there is interference with the sensors from external sound sources which emit the same ultrasound frequencies as those with which the system works.

Examples of such sources include horns, wet tyres on asphalt, pneumatic brakes and exhaust noises from motorcycles etc.

### Driver responsibility

The driver should bear in mind that the PAP is an aid – not an infallible, fully-automatic function. The driver must therefore be prepared to interrupt a parking step.

There are also a few details to bear in mind while parking, e.g.:

- PAP bases itself on the locations of vehicles already parked nearby - if they are inappropriately parked, your own car's tyres and wheel rims may be damaged by contact with the kerb.
- PAP is designed for parking on straight streets - not sharp curves or bends. For this reason, make sure the car is parallel to the parking space when PAP measures the space.
- Parking spaces on narrow streets are not always feasible, since the space required for manoeuvring may not be sufficient.
- Bear in mind that the front of the car may swing out towards oncoming traffic while being parked.
- Objects situated higher than the detection areas of the sensors are not taken into account when calculating the parking manoeuvre. This may cause PAP to turn into the parking space too early, and hence such parking spaces should be avoided.
- The driver is responsible for determining whether the space selected by PAP is suitable for parking.
- Use approved tyres<sup>28</sup> with the correct tyre pressure - this affects the ability of PAP to park the car.
- Heavy rain or snow may cause the system to measure the parking space incorrectly.
- Do not use PAP if snow chains or a spare wheel are fitted.
- Do not use PAP if cargo items are protruding from the car.
- Perpendicular parking spaces may be missed or offered unnecessarily if one parked car is protruding more than other parked cars.

<sup>28</sup> "Approved tyres" refers to tyres of the same type and make as those fitted new on delivery from the factory.



**! IMPORTANT**

Changing to another approved wheel rim and/or tyre dimension may involve a changed tyre circumference, which means that the PAP system's parameters may then need to be updated. Consult a workshop - an authorised Volvo workshop is recommended.

### Related information

- Park Assist Pilot\* (p. 372)
- Parking with Active parking assistance\* (p. 374)

### Maintenance

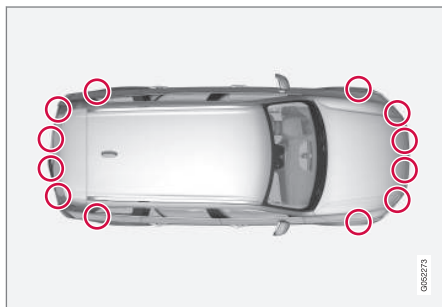

PAP sensor locations<sup>29</sup>.

For the PAP function to work correctly, its sensors must be cleaned regularly with water and car shampoo.

<sup>29</sup> NOTE: The illustration is schematic - details may vary depending on car model.



## Messages for Park Assist Pilot\*

A number of messages regarding Park Assist Pilot – PAP can be shown in the driver display.

The following table shows some examples.

Message	Specification
<b>Park Assist System Sensors blocked, cleaning needed</b>	One or more of the systems' sensors are blocked - check and correct as soon as possible.
<b>Park Assist System Unavailable Service required</b>	The system does not function as it should. A workshop should be contacted - an authorised Volvo workshop is recommended.

### Related information

- Park Assist Pilot\* (p. 372)
- Parking with Active parking assistance\* (p. 374)
- Limitations of Park Assist Pilot\* (p. 377)



STARTING AND DRIVING

## Alcohol lock\*

The function of the alcohol lock is to prevent the car from being driven by individuals under the influence of alcohol. Before the engine can be started the driver must take a breath test that verifies that he/she is not under the influence of alcohol. Alcohol lock calibration takes place in accordance with each market's limit value in force for driving legally.

The car has an interface for the electrical connection of the different makes and models of alcohol lock recommended by Volvo. The interface facilitates alcohol lock connection, and gives the option of an integrated function including messages related to the alcohol lock in the car's main display. For information about a specific alcohol lock, please refer to its owner's manual.

### WARNING

The alcohol lock is an aid and does not exempt the driver from responsibility. It is always the responsibility of the driver to be sober and to drive the car safely.

## Bypass of the alcohol lock\*

In the event of an emergency situation or the alcohol lock is out of order, it is possible to bypass the alcohol lock in order to drive the car.

For deactivation via the alcohol lock, see the separate instructions for that specific lock.

### Activating the bypass function (Bypass)

#### NOTE

All bypass activation is logged and saved in the memory in the alcohol lock's control unit. It is not possible to undo a bypass.

The message, **Blow into alcolock Bypass instead?**, is shown in the screen:

- Select Bypass by pressing once on the **O** button on the steering wheel's right-hand keypad.
  - > The alcohol lock is now bypassed and the car can be started.

The number of bypasses possible before service is required is selected during alcohol lock installation.

### Related information

- Before starting the engine with the alcohol lock (p. 382)
- Starting the car (p. 384)

## Before starting the engine with the alcohol lock

The alcohol lock is activated automatically and is then ready for use when the car is opened.

### To bear in mind

In order to obtain correct function and as accurate a measurement result as possible:

- Avoid eating or drinking approx. 5 minutes before the breath test.
- Avoid excess windscreen washing - the alcohol in the washer fluid may result in an incorrect measurement result.

#### NOTE

After a completed period of driving, the engine can be restarted within 30 minutes without a new breath test.

### Related information

- Bypass of the alcohol lock\* (p. 382)
- Starting the car (p. 384)

## Ignition positions

The car's electrical system can be set in different levels/positions and in this way make the different functions available.

In order to facilitate the use of a limited number of functions with the engine switched off, the car's electrical system can be set in 3 different levels - **0**, **I** and **II**. These levels are described with the denomination "ignition position" throughout the owner's manual.

The following table shows the functions available in each ignition position/level:

Level	Functions
<b>0</b>	<ul style="list-style-type: none"> <li>• Odometer, clock and temperature gauge are illuminated.</li> <li>• Power seats can be adjusted.</li> <li>• The power windows can be used.</li> <li>• The centre display is started and can be used.</li> <li>• It is possible to start the audio.</li> </ul> <p>The functions are time-controlled in this ignition position and are switched off automatically after a period of time.</p>
<b>I</b>	<ul style="list-style-type: none"> <li>• Panorama roof, power windows, 12V socket in the passenger compartment, navigation, phone, ventilation fan and windscreen wipers can be used.</li> <li>• Power seats can be adjusted.</li> <li>• 12 V sockets in the cargo area can be used.</li> <li>• The audio is started automatically if it was running when the car was left.</li> </ul> <p><b>Power is taken from the battery in this ignition position.</b></p>

Level	Functions
<b>II</b>	<ul style="list-style-type: none"> <li>• The headlamps come on.</li> <li>• Warning/indicator lamps illuminate for 5 seconds.</li> <li>• Several other systems are activated. However, heating in seat cushions and the rear window can only be activated after the car has been started.</li> </ul> <p><b>This ignition position consumes a lot of current from the battery and should therefore be avoided!</b></p>

### Selecting ignition position



Start knob in the tunnel console.

- **Ignition position 0** - Unlock the car and store the remote control key inside the car.



**i NOTE**

To reach level **I** or **II** **without** starting the engine - do **not** depress the brake pedal, or the clutch pedal for cars with manual gear changing, when these ignition positions are to be selected.

- **Ignition position I** - Turn the ignition dial to **START** and release it. The control automatically returns to its starting position.
- **Ignition position II** - Turn the ignition dial to **START** and hold it in the **START** position for approx. 4 seconds. Then release the knob, which automatically returns to its starting position.
- **Back to ignition position 0** - To return to ignition position **0** from position **I** and **II** - Turn the ignition dial to **STOP** and release it. The control automatically returns to its starting position.

**Related information**

- Starting the car (p. 384)
- Switching off the car (p. 385)
- Driver display (p. 90)

**Starting the car**

The car is started using the remote control key and the start knob in the tunnel console.



Start knob in the tunnel console.

The remote control key is not physically used when starting the car since the car is equipped with support for keyless starting (Passive Start).

To start the car:

1. The remote control key must be inside the car. For cars with Passive Start, the key needs to be located in the front part of the passenger compartment. With the keyless locking/unlocking option (Passive Entry\*), the key can be anywhere in the car.

2. For cars with automatic gear changing, make sure that gear position **P** or **N** is selected. For cars with manual gear changing, make sure that the gear lever is in neutral position and that either the clutch pedal or the brake pedal is depressed.
3. Depress the brake pedal fully<sup>1</sup>.
4. Turn the start knob to **START** and release it. The control automatically returns to its starting position.

**i NOTE**

For diesel-engined cars, there may be a slight delay before starting is initiated.

When the engine is started the starter motor works until the engine is started or until its overheating protection triggers.



Backup reader's location in the tunnel console.

<sup>1</sup> If the car is moving, then you simply need to turn the start knob towards **START** to start the engine.

If the message **Car key not found** is shown in the driver display when starting, place the remote control key on the backup reader in the cup holder. Then try to start again.

### **i** NOTE

When the remote control key is placed in the cup holder, make sure that no other car keys, metal objects or electronic apparatus (e.g. mobile phones, tablets, laptops or chargers) are in the cup holder. Several car keys close to each other in the cup holder can cause interference with each other.

### **!** IMPORTANT

If the engine fails to start after 3 attempts - wait for 3 minutes before making a further attempt. Starting capacity increases if the battery is allowed to recover.

### **!** WARNING

**Never** remove the remote control key from the car while driving or during towing.

### **!** WARNING

Always take the remote control key out from the car when leaving the car and make sure the car's electrical system is in ignition position **0** - especially if there are children in the car.

### **i** NOTE

The idling speed can be noticeably higher than normal for certain engine types during cold starting. This is done in order that the emissions system can reach normal operating temperature as quickly as possible, which minimises exhaust emissions and protects the environment.

### Related information

- Ignition positions (p. 383)
- Switching off the car (p. 385)
- Remote control key (p. 234)
- Replacing the battery in the remote control key (p. 255)

## Switching off the car

The car is switched off using the ignition dial in the tunnel console.



Start knob in the tunnel console.

To switch off the car:

- Turn the ignition dial to **STOP** and release it - the car is switched off. The control automatically returns to its starting position.

If the gear selector is not in **P** position or if the car is moving:

- Hold the dial in the **STOP** position until the car switches off.

### Related information

- Starting the car (p. 384)

## Steering lock

The steering lock makes steering difficult if the car is e.g. taken unlawfully. A mechanical noise can be perceived when the steering lock locks or unlocks.

### Activating the steering lock

The steering lock is activated when the car is locked from the outside and the engine is switched off. If the car is left unlocked then the steering lock will lock automatically after a while.

### Deactivating the steering lock

The steering lock is deactivated when the car is unlocked from outside. If the car is not locked, it is sufficient that the remote control key is inside the passenger compartment and the engine is started by turning the start knob towards **START** in order to unlock the steering lock.

### Related information

- Starting the car (p. 384)
- Switching off the car (p. 385)
- Steering wheel (p. 131)

## Using jump starting with another battery

If the starter battery is discharged then the car can be started with current from another battery.

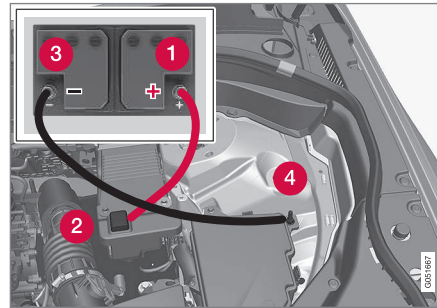

When jump starting the car, the following steps are recommended to avoid short circuits or other damage:

1. Set the car's electrical system in ignition position **0**.
2. Check that the donor battery has a voltage of 12 V.
3. If the donor battery is installed in another car - switch off the donor car's engine and make sure that the two cars do not touch each other.

4. Connect one of the red jump lead's clamps to the donor battery's positive terminal (1).

### **!** IMPORTANT

Connect the start cable carefully to avoid short circuits with other components in the engine compartment.

5. Open the positive jump-starting point's cover (2).
6. Connect the red jump lead's other clamp onto the car's positive jump-starting point (2).
7. Connect one of the black jump lead's clamps to the donor battery's negative terminal (3).
8. Connect the black jump lead's other clamp onto the car's negative jump-starting point (4).
9. Check that the jump lead clamps are affixed securely so that there are no sparks during the starting attempt.
10. Start the engine of the "donor car" and allow it to run a few minutes at a speed slightly higher than idle approx. 1500 rpm.



11. Start the engine in the car with the discharged battery.

### **IMPORTANT**

Do not touch the connections between cable and car during the starting attempt. There is a risk of sparks forming.

12. Remove the jump leads in reverse order - first the black and then the red.

Make sure that none of the black jump lead's clamps comes into contact with the car's positive jump-starting point/donor battery's positive terminal or the clamp connected to the red jump lead.

### **WARNING**

- The battery can generate oxyhydrogen gas, which is highly explosive. A spark can be formed if a jump lead is connected incorrectly, and this can be enough for the battery to explode.
- The battery contains sulphuric acid, which can cause serious burns.
- If sulphuric acid comes into contact with eyes, skin or clothing, flush with large quantities of water. If acid splashes into the eyes - seek medical attention immediately.

### Related information

- Starter battery (p. 530)
- Ignition positions (p. 383)
- Starting the car (p. 384)
- Opening and closing the bonnet (p. 514)

### Gearbox

The gearbox is part of the car's driveline (power transmission) between engine and drive wheels. The function of the gearbox is to change the gear ratio depending on speed and power requirements.

There are two main types of gearbox, manual and automatic.

The manual gearbox has six gears. The automatic gearbox can have either eight gears or six gears depending on which engine the car is equipped with. The number of gear changes means that the engine's torque and power range can be used effectively.

It is also possible to select gears manually with the automatic gearbox. The driver display respectively shows which gear or gear position is currently in use.

### **IMPORTANT**

To prevent damage to any drive system components, the working temperature of the gearbox is checked. If there is a risk of overheating, a warning symbol illuminates in the driver display and a text message is shown - follow the recommendation given.

### Symbols in the driver display

If a fault should occur in the gearbox, the driver display shows a symbol and a message.





Symbol	Specification
	Information or error message for gearbox. Follow the recommendation given.
	Hot or overheated gearbox. Follow the recommendation given.

**Related information**

- Gear positions for automatic gearbox (p. 388)
- Manual gearbox (p. 390)
- Gear shift indicator\* (p. 390)

**Gear positions for automatic gearbox**

With an automatic gearbox, the system chooses the gear so that driving is optimal. The gearbox also has a manual gearshift mode.

**Gear positions in the driver display**



The driver display shows the gear selector's position:

**P, R, N, D** or **M**.

In manual gearshift mode, the gear being used is also shown.

**Gear positions**

**Park position - P**

Select the **P** position when the car is parked or when starting the engine. The car must be stationary when the park position is selected.

To be able to move the gear selector from the park position, the brake pedal must be depressed and the ignition position must be **II**.

The gearbox is mechanically blocked when the **P** position is engaged. Apply the parking brake first when the car is parked.

**WARNING**

Always use the parking brake when parking on an inclined surface. Engaging a gear or the automatic transmission's **P** position is not sufficient to hold the car stationary in all situations.

**NOTE**

The gear selector must be in **P** position to allow the car to be locked and alarmed.

**Reverse position - R**

Select position **R** to reverse. The car must be stationary when reverse position is selected.

**Neutral position - N**

No gear is engaged and the engine can be started. Apply the parking brake if the car is stationary with the gear selector in **N** position.

To be able to change from the neutral position to another gear position, the brake pedal must be depressed and the ignition position must be **II**.

**Drive position - D**

**D** is the normal driving position. Shifting up and down takes place automatically based on the level of acceleration and speed. The car must be stationary when changing gear from **R** position to **D** position.

**Manual gearshift mode - M**

The manual gearshift mode can be selected at any time while driving. The car engine-brakes when the accelerator pedal is released.

Select manual gearshift mode by moving the gear selector sideways from position **D** to the end position at "**±**". The driver display shows which gear is engaged at the time.

- Press the gear selector forwards to "+" (plus) to change up one step and release it.
- Press the gear selector backwards to "-" (minus) to change down one step and release it.

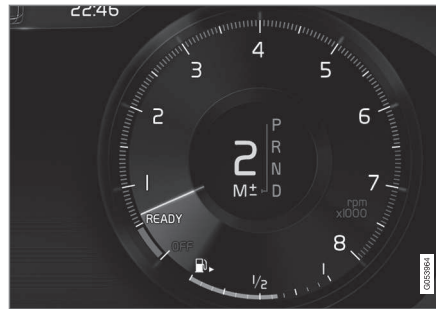

manual gearshift mode in the driver display<sup>2</sup>.

The gearbox automatically shifts down if the speed decreases to a level lower than appropriate for the selected gear, in order to avoid jerking and stalling.

To return to automatic gear changing, press the gear selector sideways to the end position at **D**.

**Kick-down**

When the accelerator pedal is pressed all the way to the floor (beyond the position normally regarded as full acceleration) a lower gear is immediately engaged. This is known as kick-down.

If the accelerator is released from the kick-down position, the gearbox automatically changes up.

Kick-down is used when maximum acceleration is needed, such as for overtaking.

**Safety function**

To prevent over-revving of the engine, the gearbox control program has a protective downshift inhibitor.

The gearbox does not permit downshifting/kick-down which would result in an engine speed high enough to damage the engine. Nothing happens if the driver still tries to shift down in this way at high engine speed – the original gear remains engaged.

When kick-down is activated the car can change one or more gears at a time depending on engine speed. The car changes up when the engine reaches its maximum speed in order to prevent damage to the engine.

**Related information**

- Gearbox (p. 387)
- Changing gear with steering wheel paddles\* (p. 393)
- Gear shift indicator\* (p. 390)
- Gear selector inhibitor (p. 392)
- Ignition positions (p. 383)

<sup>2</sup> The figure is schematic, the layout may vary depending on the car's equipment.

## Manual gearbox

With a manual gearbox, the driver selects a suitable gear manually, according to speed and power requirements at the time.

### Changing gear

The manual gearbox has six gears, the shifting pattern is imprinted on the gear lever.

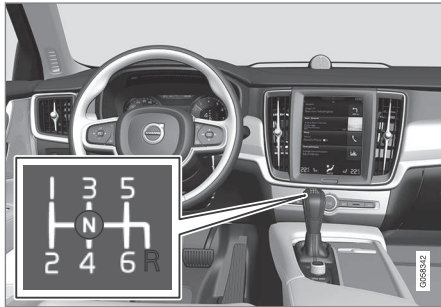

Gearing pattern.

- Depress the clutch pedal fully during each gear change.
- Take your foot off the clutch pedal between gear changes.

### Reverse gear inhibitor

The reverse gear inhibitor hinders the possibility of mistakenly attempting to engage reverse gear during normal forward travel.

- Follow the gearing pattern printed on the gear lever and start from neutral position, **N** before moving it to **R** position.
- Engage reverse gear only when the car is stationary.

### During parking

#### **WARNING**

Always apply the parking brake when parking on a slope - leaving the car in gear is not sufficient to hold the car in all situations.

### Related information

- Gearbox (p. 387)
- Gear shift indicator\* (p. 390)

### Gear shift indicator\*

The gear shift indicator in the driver display shows the current gear during manual gearshifting and when it is appropriate to engage the next gear for optimum fuel economy.

For eco-driving during manual gear changing, it is important to drive in the right gear and to change gear in good time.

### With automatic gearbox

The gear shift indicator shows the current gear in the driver display and uses an up arrow to indicate when shifting to a higher gear is recommended.



Gear shift indicator in the 12-inch driver display.

### With manual gearbox

An up-arrow indicates a recommended change to a higher gear, and a down-arrow a recommended change to a lower gear.



Gear shift indicator in the 12-inch driver display.



Gear shift indicator in the 8-inch driver display.

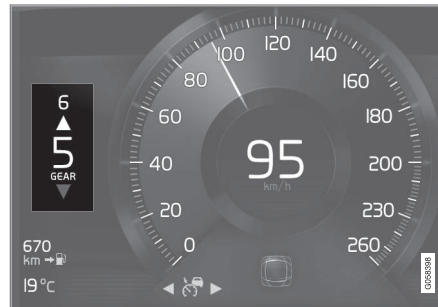

Gear shift indicator in the 8-inch driver display.

### Related information

- Gearbox (p. 387)
- Gear positions for automatic gearbox (p. 388)
- Manual gearbox (p. 390)

## Gear selector inhibitor

The gear selector inhibitor prevents accidental changing between different gear positions in an automatic gearbox.

There are two different types of gear selector inhibitor - mechanical and automatic.

### Mechanical gear selector inhibitor

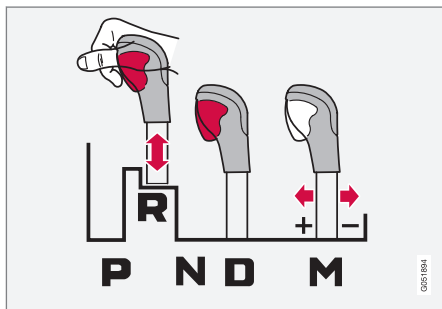

The gear selector can be moved forward and back freely between **N** and **D**. Other positions are locked with a latch that is released with the inhibitor button on the gear selector.

With the inhibitor button depressed the lever can be moved forwards or backwards between **P**, **R**, **N** and **D**.

### Automatic gear selector inhibitor

The automatic gear selector inhibitor has special safety systems.

### From park position - P

To be able to move the gear selector from the **P** position, the brake pedal must be depressed and the ignition position must be **II**.

### From neutral position - N

If the gear selector is in the **N** position and the car has been stationary for at least 3 seconds (irrespective of whether the engine is running) then the gear selector is locked.

To be able to move the gear selector from the **N** position to another gear position, the brake pedal must be depressed and the ignition position must be **II**.

### Deactivate automatic gear selector inhibitor

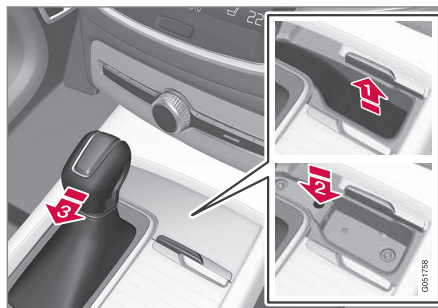

If the car cannot be driven, e.g. due to a discharged battery, the gear selector must be

moved to the **N** position so that the car can be moved.

- 1 Lift the rubber mat in the compartment in front of the gear selector. Locate the hole with a spring-loaded button in the bottom of the compartment.
- 2 Press a small screwdriver into the hole and hold.
- 3 Move the gear selector to position **N** and release the button.
- 4 Put the rubber mat back in place.

### Related information

- Gear positions for automatic gearbox (p. 388)
- Ignition positions (p. 383)

## Changing gear with steering wheel paddles\*

The steering wheel paddles are a complement to the gear selector and make it possible to change gear manually without releasing hands from the steering wheel.

### Activating the steering wheel paddles

To be able to change gear with the steering wheel paddles they must first be activated:

- Pull one of the paddles toward the steering wheel.
  - > A figure in the driver display indicates current gear.



Driver display when changing gear with steering wheel paddles.

### Manual gearshift mode

In gear position **M** the steering wheel paddles are automatically activated.

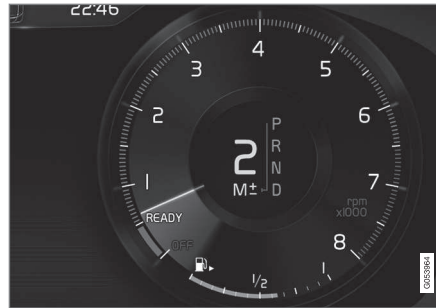

Driver display when changing gear with steering wheel paddles in manual gearshift mode.

### Changing gear

To change gear one step:

- Pull one of the paddles backwards - towards the steering wheel - and release.



1 "-": Selects the next lower gear.

2 "+": Selects the next higher gear.

A gear change occurs at each pull of the paddle provided that the engine speed does not leave the permitted range.

After each gear change the figure in the driver display changes to show the current gear.

### Deactivating the function

#### Manual deactivation in gear position D.

- Deactivate the steering wheel paddles by pulling the right-hand paddle (+) toward the steering wheel and holding in place until the figure in the driver display for the current gear extinguishes.



### ◀◀ **Automatic deactivation**

In gear position **D** the steering wheel paddles are deactivated after a short time if they are not used. This is indicated by means of the figure for the current gear extinguishing.

The exception is during engine braking - then the paddles are activated for as long as engine braking is in progress.

In gear position **M** there is no automatic deactivation.

### **Related information**

- Gear positions for automatic gearbox (p. 388)
- Gear shift indicator\* (p. 390)

### **Start/Stop**

With the **Start/Stop** function, the engine switches off temporarily when the car has stopped e.g. at traffic lights or in a traffic queue, and then starts again automatically when the journey is resumed.

Start/Stop is one of several energy-saving functions intended to reduce fuel consumption, which in turn helps to reduce exhaust emissions.

The system makes it possible to adopt an environmentally-conscious driving style by allowing the car to engine auto-stop when possible.

### **Related information**

- Using the Start/Stop function (p. 394)
- Conditions for the Start/Stop function (p. 396)

### **Using the Start/Stop function**

The **Start/Stop** function temporarily switches off the engine when stationary and then restarts it automatically when the journey is resumed.

The **Start/Stop** function is available when the engine is started and can be activated if certain conditions have been met. The driver display indicates whether the function is available, active or unavailable, see heading "Symbols in driver display" below.

All of the car's normal systems such as lighting, radio, etc. work normally, even when the engine is auto-stopped. However, some equipment may have its output temporarily reduced, e.g. the climate control system's fan speed or extremely high volume on the audio system.

### **Auto-stop**

The following is required for the engine to auto-stop:



With automatic gearbox

- Stop the car with the foot brake and then keep your foot on the brake pedal - the engine stops automatically.

With manual gearbox

- Declutch, set the gear lever in neutral position and release the clutch pedal - the engine stops automatically.

In drive mode **Eco** or **Comfort**<sup>3</sup>, the engine may auto-stop before the car is completely stationary.

With the **Adaptive cruise** or **Pilot Assist** function activated, the engine will autostop after approximately three seconds.

See the section "Conditions for Start/Stop function".

### Autostart

The following is required for the engine to auto-start:

With automatic gearbox

- Release the brake pedal - the engine will autostart and you can continue driving. On an uphill gradient hill start assist (HSA)

engages, which prevents the car from rolling backwards.

- When the **Auto hold** function is activated, auto-start is delayed until the accelerator pedal is depressed.
- When the **Adaptive cruise** or **Pilot Assist** function are activated, the engine will auto-start when the accelerator pedal is depressed, or by pressing the  button on the left keypad of the steering wheel.
- Maintain foot pressure on the brake pedal and depress the accelerator pedal - the engine auto-starts.
- On a downhill gradient: Release pressure on the brake pedal slightly so that the car begins to roll - the engine will auto-start after a slight speed increase.

With manual gearbox

- With the gear lever in neutral position: Depress the clutch pedal or depress the accelerator pedal - the engine starts.
- On a downhill gradient: Release pressure on the brake pedal slightly so that the car begins to roll - the engine will auto-start after a slight speed increase.

### Symbols in the driver display

#### With 12-inch driver display

- The text **READY** is shown in the tachometer when the function is available.
- A pointer in the tachometer points to **READY** when the function is active and the engine is auto-stopped.
- The text **READY** is greyed out when the function is not available.
- No text is shown when the function is deactivated.





The function is active and the engine is auto-stopped.

<sup>3</sup> Normal start mode.

◀◀ **With 8-inch driver display**

The symbol is shown in the lower edge of the speedometer.

Symbol	Specification
	White symbol: The function is available.
	Beige symbol: The function is active and the engine is auto-stopped.
	The function is not available, the conditions are not fulfilled.
	No symbol is shown when the function is deactivated.

**Deactivating the function**

In certain situations it may be desirable to temporarily deactivate the function.



Deactivate using the **Start/Stop** function button in the centre display's function view. The indication in the button is switched off when the function is deactivated.

The function is deactivated until

- it is reactivated
- the drive mode is changed to **Eco** or **Comfort**
- the next time the car is started.

**Related information**

- Start/Stop (p. 394)
- Conditions for the Start/Stop function (p. 396)
- Hill start assist (p. 410)
- Automatic braking when stationary (p. 410)
- Adaptive cruise control\* (p. 288)
- Activating and starting the Pilot Assist\* (p. 305)

**Conditions for the Start/Stop function**

For the Start/Stop function to work requires that a number of conditions are met.

If any condition is not met, this will be indicated in the driver display. See the section "Using the Start/Stop function".

**The engine does not auto-stop**

The engine does not auto-stop in the following cases:

- The car has not reached approx. 10 km/h (6 mph) after starting.
- After a number of repeated auto stops, speed must again exceed approx. 10 km/h (6 mph) before the next auto stop.
- The driver has unfastened the seatbelt.
- The capacity of the starter battery is below the minimum permissible level.
- The engine is not at normal operating temperature.
- The ambient temperature is under -5 °C or above approx. 30 °C.
- the windscreen's electric heating is activated.
- The environment in the passenger compartment deviates from the set values.
- the car is reversed.
- The starter battery's temperature is below or above the permitted limit values.

- The driver makes sweeping steering wheel movements.
- The road is very steep.
- The bonnet is opened.
- When driving at high altitudes when the engine has not reached operating temperature.
- The ABS system has been activated.
- In the event of heavy braking (even without the ABS system having been activated).
- Many starts during a short period of time have activated the starter motor's thermal protection.
- The exhaust system's particulate filter is full<sup>4</sup>.
- A trailer is connected electrically to the car's electrical system.

The following applies to automatic gearbox:

- The gearbox is not at normal operating temperature.
- The gear selector is in  $\pm$  position.

### The engine does not auto-start

In the following cases the engine does not auto-start after having auto-stopped:

With automatic gearbox:

- The driver is unbelted, the gear selector is in **P** position and the driver's door is open - a normal start must take place.

With manual gearbox:

- The driver is unrestrained.
- A gear is engaged without declutching.

### Involuntary stop with manual gearbox

If a start-up fails and the engine stops, proceed as follows:

1. Check that the driver side's seatbelt is locked in the seatbelt buckle.
2. Depress the clutch pedal again - the engine starts automatically.
3. In certain cases the gear lever must be set in neutral position. A message is shown in the driver display - follow the recommendation given.

### The engine auto-starts without the brake pedal having been released

In the following cases, the engine auto-starts even if the driver does not take his/her foot off the brake pedal:

- High humidity in the passenger compartment forms misting on the windows.
- The environment in the passenger compartment deviates from the set values.
- There is a temporarily high current take-off or starter battery capacity drops below the lowest permissible level.
- Repeated pumping of the brake pedal.
- The bonnet is opened.
- The car starts to roll or increase speed slightly if the car auto-stopped without being completely stationary.

The following applies to automatic gearbox:

- The driver's seatbelt buckle is opened with the gear selector in **D** or **N** position.
- The gear selector is moved from **D** to position **R** or  $\pm$ .
- The driver's door is opened with the gear selector in **D** position - a "ping" sound and text message indicate that the ignition is on.

### WARNING

Do not open the bonnet when the engine has auto-stopped. Switch off the engine normally before lifting up the bonnet.

<sup>4</sup> Applies to cars with diesel engines.

### ◀◀ Related information

- Start/Stop (p. 394)
- Using the Start/Stop function (p. 394)
- Support battery (p. 533)

### Drive modes\*

Selection of drive mode affects the car's driving characteristics in order to enhance the driving experience and facilitate driving in special situations.

Using the drive modes it is possible to quickly have access to the car's numerous functions and settings for different driving needs. The following systems are adapted to obtain the best possible driving characteristics in each respective drive mode:

- Steering
- Engine/gearbox<sup>5</sup>/all-wheel drive\*
- Brakes
- Shock absorption
- Driver display
- Start/Stop function
- Climate settings

Select the drive mode that best suits the current driving conditions. Remember that not all drive modes can be selected in all situations.

### Selecting drive mode



1. Press the drive mode control **DRIVE MODE**.
  - > A pop-up menu is opened in the centre display.
2. Roll the wheel upward or downward until the desired drive mode is highlighted.
3. Press the drive mode control or tap directly on the touch screen to confirm the selection.
  - > The selected drive mode is indicated in the driver display.

A message is shown when a drive mode is unselectable, for example:

- **Cannot be selected because gear is in manual**
- **Cannot be selected due to low battery**

<sup>5</sup> Applies to automatic gearbox.

- Cannot be selected due to low temperature
- Cannot be selected due to limitations
- Cannot be selected because speed is too high.

## Selectable drive modes

### COMFORT

- This is the car's normal mode.

When the car starts, it is in **Comfort** mode and the Start/Stop function is activated. These settings mean that the car feels comfortable, the steering is light, the shock absorption is soft and body's movement is smooth.

This drive mode is the certification mode for carbon dioxide emissions.

### ECO

- Adapt the car for more energy-efficient and environmentally-conscious driving with the **Eco** mode.

The drive mode means, for example, that the Start/Stop function is activated and the output of certain climate settings is reduced.

The driver display has an ECO gauge that facilitates fuel-efficient driving.

More information on this drive mode is found in the section "Drive mode ECO".

### DYNAMIC

- **Dynamic** mode means that the car has sportier characteristics and faster response to accelerating.

The gear changes become faster and more distinct, and the gearbox prioritises a gear with greater traction.

Steering response is faster and shock absorption is harder<sup>6</sup> which means that the body follows the roadway in order to reduce roll during cornering.

Start/Stop function is deactivated.

### INDIVIDUAL

- Adapting a drive mode according to individual preferences.

Select a drive mode to start from, and then adjust the settings according to the desired driving characteristics. These settings are saved in an individual driver profile.

An individual drive mode is only available if it is first activated in the centre display.

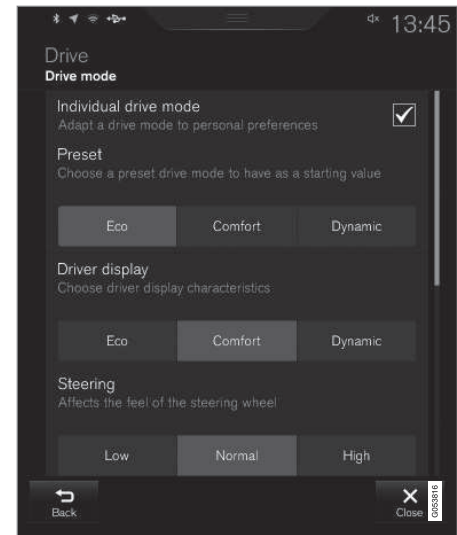

Settings view<sup>7</sup> for individual drive mode.

1. Press **Settings** in the top view.
2. Press **My Car** → **Individual Drive Mode** and select **Individual Drive Mode**.

<sup>6</sup> Applies to Four-C.

<sup>7</sup> The figure is schematic, the layout may vary depending on car model or updated software.

- ◀ 3. In **Presets**, select a drive mode to start from: **Eco**, **Comfort** or **Dynamic**.

Possible adjustments apply to settings for:

- **Driver Display**
- **Steering force**
- **Powertrain Characteristics**
- **Brake Characteristics**
- **Suspension Control**
- **ECO Climate**
- **Start/Stop**.

### Related information

- Speed-dependent steering force (p. 270)
- Level control\* and shock absorption (p. 403)
- Start/Stop (p. 394)
- Drive mode ECO (p. 400)
- All-wheel drive\* (p. 403)

## Drive mode ECO

**Driving mode ECO** mode optimises the car's driving characteristics for more fuel efficient and environmentally-conscious driving.

Use this drive mode to save fuel and the environment.

The following properties are adapted for Eco driving:

- Gearbox gearshift points<sup>8</sup>.
- Engine management and response from the accelerator pedal.
- The Eco Coast<sup>9</sup> freewheel function is activated and engine braking is deactivated when the accelerator pedal is released at speeds between 65 and 140 km/h (40 and 87 mph).
- Some of the climate control system's settings work at reduced power or are deactivated.
- The driver display shows information in an ECO gauge which facilitates environmentally-conscious and fuel-efficient driving.

### Selecting ECO mode

The Eco mode is deactivated when the engine is switched off, and it must therefore be activated after each time the engine is started. The driver

display shows ECO when the function is activated.

### With drive mode control\*



1. Press the drive mode control **DRIVE MODE**.  
> A pop-up menu is opened in the centre display.
2. Roll the wheel upward or downward until the desired drive mode is highlighted.
3. Press the drive mode control or tap directly on the touch screen to confirm the selection.

<sup>8</sup> Only cars with automatic gearbox.

<sup>9</sup> Only cars with automatic gearbox.

### In the centre display's function view



A car without drive mode control has a function button for **Driving mode ECO** in the centre display's function view.

- Press the button in order to activate the function.
  - > An indicator in the button illuminates when the function is activated.

### Freewheel function Eco Coast<sup>10</sup>

The freewheel function Eco Coast means in practice that engine braking ceases, meaning in turn that the car's kinetic energy is used to freewheel for longer distances. When the driver releases the accelerator pedal the gearbox is automatically disengaged from the engine whose speed is reduced to idling speed with reduced consumption.

The function is best used where it is possible to freewheel a long way, e.g. roads with a slight downhill gradient or when there is a predictable speed reduction to freewheel into a zone with a lower speed limit.

### Activating the freewheel function

The function is activated when the accelerator pedal is fully released, in combination with the following parameters:

- Drive mode **Eco** is activated.
- The gear selector is in **D** position.
- Speed within the range of approx. 65-140 km/h (40-87 mph).
- The road's downhill gradient is not steeper than approx. 6%.

The driver display shows **COASTING** when the freewheel function is being used.

### Limitations

The freewheel function is not available if:

- Engine and/or gearbox are not at normal operating temperature.
- The cruise control is activated.
- The gear selector is moved from the **D** position and the manual position.
- The speed is outside the range of approx. 65-140 km/h (40-87 mph).
- The road's downhill gradient is steeper than approx. 6%.
- Manual gear changing is performed with the steering wheel paddles\*.

### Deactivating and switching off the freewheel function

In certain situations it may be desirable to deactivate or switch off the function in order to use engine braking. Examples of such situations may be on steep downhill gradients or before an imminent overtaking manoeuvre - in order to be able to do it in the safest way possible.

Deactivate the freewheel function as follows:

- Actuate the accelerator or brake pedal.
- Move the gear selector to manual position.
- Changing gear with steering wheel paddles\*.

Switch off the freewheel function as follows:

- Change drive mode\*, or switch off the **Driving mode ECO** in the function view.

Even without the freewheel function, it is possible to freewheel for short distances. This, in turn, reduces consumption. However, for the best fuel economy it is better to have the freewheel function activated and be able to freewheel for longer distances.

### ECO gauge in the driver display

The ECO gauge indicates how fuel-efficient the driving is:

<sup>10</sup> Only cars with automatic gearbox.

## STARTING AND DRIVING

- ◀ • With fuel-efficient driving, the gauge shows a low value with the pointer in the green zone.
- With non-fuel-efficient driving, e.g. during heavy braking or heavy acceleration, the gauge shows a high value.

The ECO gauge also has an indicator to show how a reference driver would drive the car under the same driving conditions. This is indicated with the short pointer on the gauge.



Eco gauge in the 12-inch driver display.



Eco gauge in the 8-inch driver display.

### ECO climate control

In the **Eco** drive mode, ECO climate control is activated automatically in the passenger compartment in order to reduce energy consumption.

#### **NOTE**

When the ECO function is activated, several parameters in the climate control system's settings are changed, and several electricity consumer functions are reduced. Certain settings can be reset manually, but full functionality is only regained by switching off the ECO function or adapting **Individual\*** drive mode with full climate functionality.

In the event of difficulties due to misting, press the button for max. defroster which has normal functionality.

### Related information

- Economical driving (p. 422)
- Start/Stop (p. 394)
- Drive modes\* (p. 398)
- Activating/deactivating defrost of windows and door mirrors (p. 192)



## Level control\* and shock absorption

Level control and shock absorption are regulated automatically in the car.

With rear level control, the car maintains the same height at the rear regardless of load. Level control can also occur even after the car has been parked.

### Shock absorption (Four-C)

The shock absorption is adapted according to the selected drive mode and according to the speed of the car. Shock absorption is normally set for the best possible comfort and is regulated continuously depending on the road surface, the car's acceleration, braking and cornering.

## Settings for level control

### Deactivation of air suspension and level control

In certain cases, the function must be deactivated, e.g. before the car is raised with a jack\*. The difference in level created by raising the car with a jack can otherwise cause problems for the air suspension.

Deactivating the function via the centre display:

1. Press **Settings** in the top view.
2. Press **My Car → Suspension**.
3. Select **Disable Leveling Control**.

## Change the damping level<sup>11</sup>

Cars with active chassis (Four-C) and without the drive mode function\* can adjust the shock absorption level via the centre display:

1. Press **Settings** in the top view.
2. Tap on **My Car → Drive Mode → Suspension Control** and select the level.

## During transport

During transport of the car on a ferry, train or truck, the car must be lashed around the tyres and not around other parts of the chassis.

Changes in the air suspension may occur during transport, which could affect the lashing negatively.

## Related information

- Drive modes\* (p. 398)
- Loading (p. 225)

## All-wheel drive\*

All-wheel drive, AWD (All Wheel Drive), means that the car is driving all four wheels at the same time, which improves traction.

To achieve the best possible traction and prevent wheel spin the motive force is distributed automatically to the wheels with the best grip. The system continuously calculates the need for torque to the rear wheels, and can immediately redistribute up to half of the motor's torque to the rear wheels.

All-wheel drive also has a stabilising effect at higher speeds. Under normal driving conditions, the majority of power is transmitted to the front wheels. When stationary, the all-wheel drive is always engaged in preparation for maximum traction during acceleration.

All-wheel drive characteristics vary depending on the selected drive mode\*.

## Related information

- Drive modes\* (p. 398)

<sup>11</sup> Depends on the car's equipment.

### Brake functions

The car's brakes are used to reduce the speed or prevent the car from rolling.

Besides the foot brake and parking brake, the car is equipped with several automatic brake assist functions. These can assist the driver by not needing to keep his/her foot on the brake pedal when stationary at a traffic light, when starting on an uphill gradient or when driving on a downhill gradient.

Depending on the car's equipment, the following auto braking functions are available:

- Automatic braking when stationary (Auto Hold)
- Hill start assist (Hill Start Assist)
- Auto braking after a collision
- City Safety

### Related information

- Foot brake (p. 404)
- Parking brake (p. 407)
- Hill start assist (p. 410)
- Automatic braking when stationary (p. 410)
- Auto braking after a collision (p. 406)

### Foot brake

The foot brake is used to reduce the car's speed while driving.

### Foot brake system

The car is equipped with two brake circuits. If a brake circuit is damaged, the brake pedal will engage deeper. Higher pressure on the pedal will therefore be needed to produce the normal braking effect.

The driver's brake pedal pressure is assisted by a brake servo.

#### **WARNING**

The brake servo only works when the engine is running.

If the foot brake is used when the engine is switched off then the pedal will feel stiff and a higher pedal pressure must be used to brake the car.

In very hilly terrain or when driving with a heavy load the brakes can be relieved by using engine braking in manual gearshift mode. Engine braking is most efficiently used if the same gear is used downhill as up.

### Anti-lock braking system

The car has anti-lock brakes, Anti-lock Braking System (ABS), which prevent the wheels from locking while braking and allows maintained

steering control. Vibration may be felt in the brake pedal when this is engaged and this is normal.

A short test of the ABS system is made automatically after the engine has been started when the driver releases the brake pedal. A further automatic test of the system may be made at low speed. The test may be experienced as pulses in the brake pedal.

### Braking on wet roads

When driving for a prolonged period of time in heavy rain without braking, the braking effect may be delayed slightly when next using the brakes. This may also be the case after a car wash. It is then necessary to depress the brake pedal more forcefully. You should therefore maintain a greater distance to the vehicles in front.

Brake the car firmly after driving on wet roads or using a car wash. This warms up the brake discs, enabling them to dry faster and protecting them against corrosion. Bear in mind the current traffic situation when braking.

### Braking on salted roads

When driving on salted roads, a layer of salt may form on the brake discs and brake linings. This may extend braking distance. You should therefore maintain an extra large safety distance to vehicles in front. In addition, make sure you do the following:

- Brake now and again to remove any layer of salt. Make sure that other road users are not put at risk by the braking.
- Gently depress the brake pedal after finishing driving and before starting your next trip.

### Maintenance

To keep the car as safe and reliable as possible, follow the Volvo service intervals as specified in the Service and Warranty Booklet.



New and replaced brake linings and brake discs do not provide optimal braking effect until they have been "worn in" a few hundred kilometres. Compensate for the reduced braking effect by depressing the brake pedal harder. Volvo recommends only fitting brake linings that are approved for your Volvo.

#### IMPORTANT

The wear on the brake system's components must be checked regularly.

Contact a workshop for information about the procedure or engage a workshop to carry out the inspection - an authorised Volvo workshop is recommended.

### Symbols in the driver display

Symbol	Specification
	Check the brake fluid level. If the level is low, fill with brake fluid and check for the cause of the brake fluid loss.
	Constant glow for 2 seconds when the engine is started: Automatic function check.  Constant glow for more than 2 seconds: Fault in the ABS system. The car's normal brake system is still working, but without the ABS function.

#### WARNING

If both the warning lamps for brake fault and ABS fault illuminate at the same time, a fault has occurred in the brake system.

- If the level in the brake fluid reservoir is normal at this stage, drive carefully to the nearest workshop and have the brake system checked - an authorised Volvo workshop is recommended.
- If the brake fluid is below the **MIN** level in the brake fluid reservoir, do not drive further before topping up the brake fluid. The reason for the loss of brake fluid must be investigated.

### Related information

- Brake functions (p. 404)
- Brake assistance (p. 406)
- Brake lights (p. 143)
- Emergency brake lights (p. 406)

## Emergency brake lights

Emergency brake lights are activated to alert vehicles behind about heavy braking. The function means that the brake light flashes instead of - as in normal braking - shining with a constant glow.

The emergency brake lights are activated during heavy braking or if the ABS system is activated at high speeds. After emergency braking to a low speed, the brake lights return from flashing to the normal constant glow. The car's hazard warning flashers are activated at the same time. These flash until the driver accelerates the car to a higher speed again or switches off the hazard warning flashers.

### Related information

- Foot brake (p. 404)
- Hazard warning flashers (p. 143)
- Brake lights (p. 143)

## Brake assistance

The brake assist system, BAS (Brake Assist System), helps to increase brake force during braking, thereby shortening the braking distance.

The system detects the way in which the driver brakes and increases brake force where necessary. The brake force can be boosted up to the level when the ABS system is engaged. The function is suspended when the pressure on the brake pedal decreases.

### NOTE

When BAS is activated the brake pedal lowers slightly more than usual, depress (hold) the brake pedal as long as necessary.

When the brake pedal is released, all braking ceases.

### Related information

- Foot brake (p. 404)

## Auto braking after a collision

In the event of a collision in which the activation level is reached for the pyrotechnic seatbelt tensioners or airbags, or if a collision with a large animal is detected, the car's brakes are automatically applied. This function is to prevent or reduce the effects of any subsequent collision.

After a serious collision there is a risk that it is no longer possible to control and steer the car. In order to avoid or mitigate a possible further collision with a vehicle or an object in the vehicle's path, the auto braking system is activated automatically and brakes the car in a safe manner.

Brake lights and hazard warning lights are activated during braking. When the car has stopped, the hazard warning lights continue to flash and the parking brake is applied.

If braking is not appropriate, e.g. if there is a risk of being hit by following traffic, the system can be overridden by the driver depressing the accelerator pedal.

The function assumes that the brake system is intact after the collision.

See also the sections "Rear Collision Warning" and "Blind Spot Information".

### Related information

- Brake functions (p. 404)
- Seatbelt tensioner (p. 59)
- Airbags (p. 63)

- Rear Collision Warning (p. 338)
- Blind Spot Information\* (p. 338)

## Parking brake

The parking brake prevents the car from rolling away from stationary by means of mechanically locking/blocking two wheels.



The control for the parking brake is located in the tunnel console between the seats.

A faint electric motor noise can be heard when the electrically-operated parking brake is being applied. The noise can also be heard during the automatic function checking of the parking brake.

If the car is stationary when the parking brake is applied then it only acts on the rear wheels. If it is applied when the car is moving then the normal foot brake is used, i.e. the brake acts on all four wheels. Brake function changes over to the rear wheels when the car is almost stationary.

## Related information

- Brake functions (p. 404)
- Using the parking brake (p. 408)
- In the event of a fault in the parking brake (p. 409)

## Using the parking brake

Use the parking brake to prevent the car from rolling from stationary.

### Applying the parking brake



1. Pull the control upward.
  - > The symbol in the driver display illuminates when the parking brake is applied.
2. Check that the car is stationary.

### Symbol in the driver display

Symbol	Specification
	The symbol is illuminated when the parking brake is applied. If the symbol flashes, it indicates a fault has occurred. Read the message on the driver display.

### Automatic application

The parking brake is applied automatically:

- if the Auto Hold function (automatic braking when stationary) is activated and the car has been stationary approx. 5 minutes.
- when gear position **P** is selected on a steep hill<sup>12</sup>.
- when the car has been switched off.

### Emergency brake

In an emergency, the parking brake can be applied when the car is in motion by pulling and holding up the control. Braking stops when the control is released.

#### NOTE

An acoustic signal sounds while emergency braking is active at high speeds.

### Releasing the parking brake



### Releasing manually

1. Depress the brake pedal firmly.
2. Press the control down.
  - > The parking brake releases and the symbol in the driver display extinguishes.

<sup>12</sup> Applies to automatic gearbox.

**Releasing automatically**

1. Put the seatbelt on.
2. Start the car.
3. With automatic gearbox:

Select gear position **D** or **R** and depress the accelerator pedal.

With manual gearbox:

Engage a suitable gear, release the clutch and depress the accelerator pedal.

- > The parking brake releases and the symbol in the driver display extinguishes.

**Parking on a hill****⚠ WARNING**

Always use the parking brake when parking on an inclined surface. Engaging a gear or the automatic transmission's **P** position is not sufficient to hold the car stationary in all situations.

If the car is parked facing uphill:

- Turn the wheels **away from** the kerb.

If the car is parked facing downhill:

- Turn the wheels **towards** the kerb.

**Heavy load uphill**

A heavy load, such as a trailer, can cause the car to roll backward when the parking brake is released automatically on a steep incline. Avoid

this by pulling the control upwards while driving the car away. Release the control when the engine achieves traction.

**Settings for parking brake**

Automatic activation of the parking brake is selected via the centre display.

Automatic activation when the car is switched off:

1. Press **Settings** in the top view.
2. Press **My Car → Parking Brake and Suspension** and deselect/select the function **Auto Activate Parking Brake**.

**Related information**

- Parking brake (p. 407)
- In the event of a fault in the parking brake (p. 409)
- Automatic braking when stationary (p. 410)

**In the event of a fault in the parking brake**

Contact an authorised Volvo workshop if it is not possible to release or apply the parking brake after several attempts.

An acoustic warning signal sounds when driving with the parking brake applied.

If the car has to be parked before a possible fault is rectified then the wheels must be turned as if parking on a hill and the gear selector must be in position **P**, or engage first gear if the car has a manual gearbox.



**Low battery voltage**

If the battery voltage is too low then the parking brake can neither be released nor applied. Connect a donor battery if the battery voltage is too low.

**Replacing the brake linings**

The rear brake linings must be replaced at a workshop due to the design of the electrically-operated parking brake - an authorised Volvo workshop is recommended.

## ◀ Symbols in the driver display

Symbol	Specification
	If the symbol flashes, it indicates a fault has occurred. See the message in the driver display.
	Fault in brake system. See the message in the driver display.
	Information message in driver display.

Message examples:

- **Parking brake Service required**
- **Parking brake System overheated**
- **Parking brake Temporarily unavailable**

### Related information

- Brake functions (p. 404)
- Using the parking brake (p. 408)
- Parking brake (p. 407)
- Using jump starting with another battery (p. 386)

## Hill start assist

Hill start assist, Hill Start Assist (HSA), prevents the car from rolling backwards when starting on an uphill gradient. When reversing uphill, it prevents the car from rolling forwards.

The function means that the pedal pressure in the brake system remains for several seconds while the driver's foot is moved from brake pedal to accelerator pedal.

The temporary braking effect releases after several seconds or when the driver accelerates.

Hill start assist is available even if the function for automatic braking when stationary (Auto hold) is deactivated.

### Related information

- Brake functions (p. 404)
- Automatic braking when stationary (p. 410)

## Automatic braking when stationary

Automatic braking when stationary (Auto Hold) means that the driver can release the brake pedal while maintaining braking effect when the car has stopped at traffic lights or a junction.

### Function

When the car has stopped, the brakes are activated automatically. The function can use either foot brake or parking brake to hold the car stationary and it works on all gradients. When the accelerator pedal is depressed again, the brakes are released.

When braking to a stop on a downhill or uphill gradient - depress the brake pedal a bit harder before releasing to ensure that the car does not roll at all.

If the driver switches off the engine when the car is stationary, the parking brake is applied.

### Automatic deactivation

The function is deactivated automatically:

- when the driver's door is open and the driver's seatbelt is unfastened.
- in gear position **N**<sup>13</sup>.

<sup>13</sup> Applies to automatic gearbox.



## Switch for automatic brake



An indicator in the button illuminates when the function is activated.



Activate or deactivate Auto Hold with the switch in the tunnel console. The function remains deactivated until it is reactivated.



If the function is active and holds the car with the foot brake (A-symbol illuminated) then the brake pedal must be depressed at the same time as the button is depressed in order to deactivate.

When the function is deactivated, hill start assist (HSA) remains active to prevent the car from rolling backwards when starting on an uphill gradient.

## Symbols in the driver display

Symbol	Specification
	The symbol is illuminated when the function uses the foot brake to keep the car stationary.
	The symbol is illuminated when the function uses the parking brake to keep the car stationary.

## Related information

- Brake functions (p. 404)
- Hill start assist (p. 410)

## Driving in water

Driving in water means that the car is driven through deep water on a water-covered roadway. Driving in water must be carried out with great caution.

The car can be driven through water at a maximum depth of 25 cm at a maximum speed of walking pace. Extra caution should be exercised when passing through flowing water.

During driving in water, maintain a low speed and do not stop the car. When the water has been passed, depress the brake pedal lightly and check that full brake function is achieved. Water and mud for example can make the brake linings wet resulting in delayed brake function.

- If necessary, clean the contacts for the electric heater and trailer coupling after driving in water and mud.
- Do not let the car stand with water over the sills for any long period of time - this could cause electrical malfunctions.



### ! IMPORTANT

Engine damage can occur if water enters the air filter.

In depths greater than 25 cm, water could enter the transmission. This reduces the lubricating ability of the oils and shortens the service life of these systems.

Damage to any component, engine, transmission, turbocharger, differential or its internal components caused by flooding, hydrostatic locking or oil shortage, is not covered by the warranty.

In the event of the engine stalling in water, do not try restart - tow the car from the water to a workshop - an authorised Volvo workshop is recommended. Risk of engine breakdown.

#### Related information

- Towing (p. 431)
- Recovering the car (p. 432)

## Overheating in the engine and drive system

Under special conditions, for example hard driving in hilly terrain and hot climate, there is a risk that the engine and drive system may overheat - in particular with a heavy load.

- In the event of overheating, the engine's power may be limited temporarily.
- Remove any auxiliary lamps from in front of the grille when driving in hot climates.
- If the temperature in the engine's cooling system becomes too high then a warning symbol is illuminated and the driver display shows the message **Engine temperature High temperature Stop safely**. Stop the car in a safe way and allow the engine to run at idling speed for several minutes and cool down.
- If the message **Engine temperature High temperature Turn off engine** or **Engine coolant Level low, turn off engine** is shown, stop the car and switch off the engine.
- In the event of overheating in the gearbox, an alternative gear shift program will be selected. In addition, a built-in protection function is activated that, amongst other things, illuminates a warning symbol and the driver display shows the message **Transmission warm Reduce speed to lower temperature** or **Transmission hot**



**Stop safely, wait for cooling.** Follow the recommendation given, reduce speed or stop the car in a safe way and allow the engine to run at idling speed for several minutes to enable the gearbox to cool down.

- If the car overheats, the air conditioning may be switched off temporarily.
- Do not turn the engine off immediately you stop after a hard drive.

### i NOTE

It is normal for the engine's cooling fan to operate for a time after the engine has been switched off.

## Symbols in the driver display

Symbol	Specification
	High engine temperature. Follow the recommendation given.
	Low level, coolant. Follow the recommendation given.
	Gearbox hot/overheated/cooled. Follow the recommendation given.

### Related information

- Driving with a trailer under special conditions (p. 428)
- Preparations for a long trip (p. 413)

### Overloading the starter battery

The electrical functions in the car load the starter battery to varying degrees. Avoid using the ignition position **II** when the car is switched off. Instead, use ignition position **I** - which uses less power.

Also, be aware of different accessories that load the electrical system. Do not use functions which use a lot of power when the car is switched off. Examples of such functions are:

- ventilation fan
- headlamps
- windscreen wiper
- audio system (high volume).

If the starter battery voltage is low, the message **12 V Battery Low charge, will soon enter power save mode** is shown in the driver display. The energy-saving function then shuts down certain functions or reduces certain functions such as the ventilation fan and/or audio system.

- In which case, charge the starter battery by starting the car and then running it for at least 15 minutes - starter battery charging is more effective during driving than running the engine at idling speed while stationary.

### Related information

- Ignition positions (p. 383)
- Starter battery (p. 530)

### Preparations for a long trip

Before a driving holiday or some other type of long journey, it is important to check the car's functions and equipment particularly carefully.

Check that:

- the engine is working normally and that fuel consumption is normal
- there are no leaks (fuel, oil or other fluid)
- all bulbs are working
- the tyres have sufficient tread depth and pressure
- a warning triangle and high-visibility vest are located in the car - legally required in certain countries
- the wiper blades are in good condition.

### Related information

- Fuel consumption and CO2 emissions (p. 573)
- Checking the tyre pressures (p. 484)
- Filling washer fluid (p. 529)
- Winter driving (p. 414)
- Economical driving (p. 422)
- Settings for car modem\* (p. 468)
- Loading (p. 225)
- Pilot Assist\* (p. 302)
- Speed limiter\* (p. 275)



- Speed camera information\* (p. 348)
- Driving with a trailer (p. 426)
- Driving in water (p. 411)
- Alarm\* (p. 260)
- Level control\* and shock absorption (p. 403)
- Warning triangle (p. 500)
- Emergency puncture repair kit (p. 490)
- Spare wheel\* (p. 498)

### Winter driving

For winter driving it is important to perform certain checks of the car in order to ensure that it can be driven safely.

Check the following in particular before the cold season:

- The engine coolant must contain 50% glycol. This mixture protects the engine against frost erosion down to approximately  $-35\text{ }^{\circ}\text{C}$ . To avoid health risks, different types of glycol must not be mixed.
- The fuel tank must be kept filled to prevent condensation.
- Engine oil viscosity is important. Oils with lower viscosity (thinner oils) facilitate starting in cold weather and also reduce fuel consumption while the engine is cold. Read more about suitable oils in the section "Adverse driving conditions for engine oil".

#### IMPORTANT

Low viscosity oil must not be used for hard driving or in hot weather.

- The condition of the starter battery and charge level must be inspected. Cold weather places great demands on the starter

battery and its capacity is reduced by the cold.

- Use washer fluid with antifreeze to avoid ice forming in the washer fluid reservoir.

### Slippery driving conditions

To achieve optimum roadholding Volvo recommends using winter tyres on all wheels if there is a risk of snow or ice.

#### NOTE

The use of winter tyres is a legal requirement in certain countries. Studded tyres are not permitted in all countries.

Practise driving on slippery surfaces under controlled conditions to learn how the car reacts.

### Related information

- Topping up coolant (p. 518)
- Adverse driving conditions for engine oil (p. 569)
- Starter battery (p. 530)
- Winter wheels (p. 499)
- Filling washer fluid (p. 529)
- Replacing a wiper blade (p. 528)
- Parking climate\* (p. 204)
- Activating/deactivating defrost of windows and door mirrors (p. 192)

- Drive modes\* (p. 398)
- Foot brake (p. 404)
- All-wheel drive\* (p. 403)
- Electronic stability control (p. 271)

### Opening/closing the fuel filler flap and refuelling

The fuel tank is fitted with a coverless fuel filler system.

#### Opening/closing the fuel filler flap

The car must be unlocked for the fuel filler flap to be opened.



In the driver display, the arrow next to the tank symbol indicates which side of the car the fuel filler flap is located.

1. Open the fuel filler flap with a gentle press on the rear of the flap.
2. After refuelling is finished - close the flap with a gentle press.

### Refuelling at a petrol station

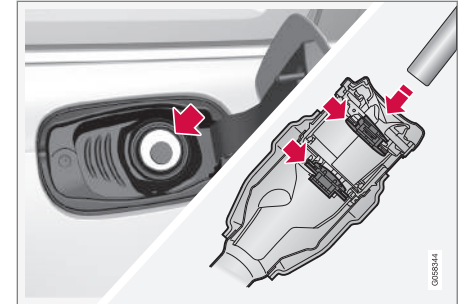

Refuelling is carried out as follows.

1. Open the fuel filler flap.
2. Choose fuel that is approved for use in the car in accordance with the identifier<sup>14</sup> on the inside of the fuel filler flap. See information on approved fuels and the identifier in the sections on "Petrol" and "Diesel" respectively.  
  
For Bi-Fuel\* cars, see also the section "Filling vehicle gas".
3. Insert the pump nozzle in the fuel filler opening. The filler pipe has two opening caps. The pump nozzle must be pushed past both caps before refuelling is started.

<sup>14</sup> The identifier, in accordance with the CEN standard prEN16942, is located on the inside of the fuel filler flap, and will soon (within two years) be on corresponding fuel pumps and their nozzles at filling stations throughout Europe.

## STARTING AND DRIVING

- ◀ 4. Do not overfill the tank but fill until the pump nozzle cuts out the first time.  
> The tank is full.

### **i** NOTE

Overfilled fuel in the tank can overflow in hot weather.

### Filling with a fuel can<sup>15</sup>

When filling with a fuel can, use the funnel located under the floor hatch in the cargo area.

1. Open the fuel filler flap.
2. Insert the funnel in the fuel filler opening. The filler pipe has two opening caps. The funnel's pipe must be pushed past both caps before filling can be started.

### Label

Never use the fuel-driven heater when the car is in a filling station area.

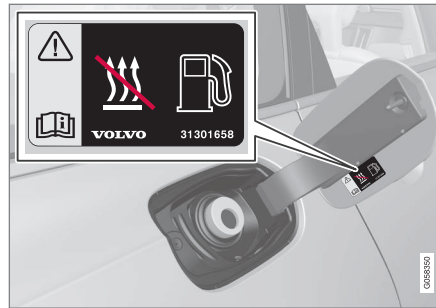

Decal on the inside of the fuel filler flap.

### Related information

- Handling of fuel (p. 418)
- Petrol (p. 418)
- Diesel (p. 419)
- Filling vehicle gas\* (p. 416)

### Filling vehicle gas\*

Refuelling with vehicle gas (CNG - Compressed Natural Gas) for cars with the Bi-Fuel engine alternative.

### Filling



Fill the vehicle gas in the gas nipple that is located behind the fuel filler flap.

1. Open the fuel filler flap and remove the gas nipple's protective cover.
2. Push the nozzle towards the gas nipple, make sure that the hose nozzle is attached by turning the handle on the nozzle a half turn.
3. Then hold the start button on the gas pump depressed for several seconds.  
> The tank is filled in a couple of minutes.

<sup>15</sup> Only applies to a car with diesel engine.

4. Remove the nozzle by turning its handle a half turn in the opposite direction.
5. Refit the gas nipple's protective cover and close the fuel filler flap.

### Identifier for vehicle gas

The identifier<sup>16</sup> is located on the inside of the fuel filler flap, and will soon (within two years) be on corresponding fuel pumps and their nozzles at filling stations throughout Europe.



This is the identifier that applies for CNG in Europe. Vehicle gas with this identifier may be used in cars that can be driven on Bi-Fuel.

### Filling stations for vehicle gas



Road sign for filling stations that offer vehicle gas.

### Related information

- Button for gas operation\* (p. 417)
- Fuel gauge for vehicle gas\* (p. 99)

### Button for gas operation\*

A car with the Bi-Fuel engine alternative has a button to change between gas operation (CNG - Compressed Natural Gas) and petrol operation.

### Operation



Press the button to change between gas operation and petrol operation.

When the switchover takes place a clicking noise can be heard in the cargo area. This is normal - the noise is created when the tank valves open.

The button has two positions:

- **BI-FUEL** illuminates in green - the car is being driven on vehicle gas
- **BI-FUEL** illuminates in amber - the car is being driven on petrol (fuel gauge for vehicle gas is extinguished).

The car always starts with petrol even if gas operation is selected. When the engine has started the system automatically changes to gas operation - normally within a few seconds of a warm start.

When starting with a cold engine it will take longer before the car changes to gas operation in order to ensure the lowest possible emissions.

### warning lamp

If the warning lamp in the button illuminates, and/or repetitive acoustic signals can be heard, then the car needs servicing. Acknowledge the warning by pressing the button, and visit the nearest workshop - an authorised Volvo workshop is recommended.

### Related information

- Filling vehicle gas\* (p. 416)
- Fuel gauge for vehicle gas\* (p. 99)

<sup>16</sup> In accordance with CEN standard prEN16942.

## Handling of fuel

Do not use fuel with a lower quality than that recommended by Volvo, as this will negatively affect engine power and fuel consumption.

### WARNING

Always avoid inhaling fuel vapour and getting fuel splashes in the eyes.

In the event of fuel in the eyes, remove any contact lenses and rinse the eyes in plenty of water for at least 15 minutes and seek medical attention.

Never swallow fuel. Fuels such as petrol, bioethanol and mixtures of them and diesel are highly toxic and could cause permanent injury or be fatal if swallowed. Seek medical attention immediately if fuel has been swallowed.

### WARNING

Fuel which spills onto the ground can be ignited.

Switch off the fuel-driven heater before starting to refuel.

Never carry an activated mobile phone when refuelling. The ring signal could cause spark build-up and ignite petrol fumes, leading to fire and injury.

### IMPORTANT

Mixtures of various fuel types or use of fuels which are not recommended will invalidate Volvo's guarantees and any supplementary service agreements; this is applicable to all engines.

### NOTE

Extreme weather conditions, driving with a trailer or driving at high altitudes in combination with fuel grade are factors that could affect the car's performance.

### Related information

- Petrol (p. 418)
- Diesel (p. 419)
- Opening/closing the fuel filler flap and refuelling (p. 415)
- Economical driving (p. 422)

## Petrol

Petrol is a type of engine fuel that is intended for cars with a petrol engine.

Only use petrol from well-known producers. Never use fuel of dubious quality. The petrol must fulfil the EN 228 standard.

### Identifier for petrol

The identifier<sup>17</sup> is located on the inside of the fuel filler flap, and will soon (within two years) be on corresponding fuel pumps and their nozzles at filling stations throughout Europe.

These are the identifiers that apply for current standard fuels in Europe. Petrol with the following identifiers may be used in cars with petrol engine:



E5 is a petrol with maximum 2.7% oxygen and maximum 5 volume % ethanol.



E10 is a petrol with maximum 3.7% oxygen and maximum 10 volume % ethanol.

<sup>17</sup> In accordance with CEN standard prEN16942.



**! IMPORTANT**

- Fuel that contains up to 10 percent by volume ethanol is permitted.
- EN 228 E10 petrol (max 10 percent by volume ethanol) is approved for use.
- Ethanol higher than E10 (max. 10 percent by volume ethanol) is not permitted, e.g. E85 is not permitted.

**Octane rating**

- 95 RON can be used for normal driving.
- 98 RON is recommended for optimum performance and minimum fuel consumption.

When driving in temperatures above +38 °C, fuel with the highest possible octane rating is recommended for optimum performance and fuel economy.

**! IMPORTANT**

- Use only unleaded petrol to avoid damaging the catalytic converter.
- Fuel containing metallic additives must not be used.
- Do not use any additives which have not been recommended by Volvo.

**Related information**

- Handling of fuel (p. 418)
- Opening/closing the fuel filler flap and refuelling (p. 415)

**Diesel**

Diesel is a type of engine fuel that is intended for cars with a diesel engine.

Only use diesel fuel from well-known producers. Never use fuel of dubious quality. Diesel fuel must fulfil the EN 590 or SS 155435 standard. Diesel engines are sensitive to contaminants in the fuel, such as excessively high volumes of sulphur and metals.

**Identifier**

The identifier<sup>18</sup> is located on the inside of the fuel filler flap, and will soon (within two years) be on corresponding fuel pumps and their nozzles at filling stations throughout Europe.

This is the identifier that applies for current standard fuel in Europe. Diesel with the following identifiers may be used in cars with diesel engine:



B7 is **diesel** with maximum 7 volume % fatty acid methyl ester (FAME).

At low temperatures (lower than 0 °C) a paraffin precipitate may form in the diesel fuel, which may lead to ignition problems. The fuel qualities that

<sup>18</sup> CEN standard prEN16942.

- ◀◀ are sold must be adapted for season and climate zone, but for extreme weather conditions, old fuel or moving between climate zones, paraffin precipitate may occur.

The risk of condensation in the fuel tank is reduced if the tank is kept well filled.

When refuelling, check that the area around the fuel filler pipe is clean. Avoid spilling fuel onto the paintwork. Wash off any spillage with detergent and water.

### **!** IMPORTANT

Diesel fuel must:

- fulfil the EN 590 and/or SS 155435 standards
- have a sulphur content not exceeding 10 mg/kg
- have a maximum of 7 vol % FAME<sup>19</sup> (B7).

### **!** IMPORTANT

Diesel type fuels that must not be used:

- Special additives
- Marine diesel fuel
- Heating oil
- FAME<sup>20</sup> and vegetable oil.

These fuels do not fulfil the requirements in accordance with Volvo recommendations and generate increased wear and engine damage that is not covered by the Volvo warranty.

### Related information

- Empty tank and diesel engine (p. 420)
- Diesel particulate filter (p. 421)

## Empty tank and diesel engine

Once the engine has stopped due to fuel starvation, the fuel system needs a few moments to carry out a check.

Before starting the engine after the fuel tank has been filled with diesel - proceed as follows:

1. The remote control key must be inside the car.
2. Set the car in ignition position **II** - turn the ignition dial to **START** without depressing the brake pedal and hold the knob in the **START** position for approx. 4 seconds. Then release the knob, which automatically returns to its starting position.
3. Wait approx. one minute.
4. To start the engine: Depress the brake pedal and turn the ignition dial to **START** again.

### **i** NOTE

Before filling with fuel in the event of fuel shortage:

- Stop the car on as flat/level ground as possible - if the car is tilting there is a risk of air pockets in the fuel supply.

<sup>19</sup> Fatty Acid Methyl Ester

<sup>20</sup> Diesel fuel with maximum 7 vol % FAME (B7) is permitted.

### Points to remember when filling with a fuel can

When filling diesel with a fuel can, use the funnel located under the floor hatch in the cargo area. Make sure you insert the funnel's pipe firmly into the filler pipe. The filler pipe has an openable cover and the funnel's pipe must be slid past the cover before filling can begin.

### Related information

- Diesel (p. 419)
- Fuel consumption and CO2 emissions (p. 573)

### Diesel particulate filter

Diesel-driven cars are equipped with a particulate filter, which results in more efficient emission control.

The particles in the exhaust gases are collected in the filter during normal driving. So-called "regeneration" is started in order to burn away the particles and empty the filter. This requires the engine to have reached normal operating temperature.

Regeneration of the particulate filter is automatic and normally takes 10-20 minutes. It may take a little longer at a low average speed. Fuel consumption may increase slightly during regeneration.

### Regeneration in cold weather

If the car is frequently driven short distances in cold weather then the engine does not reach normal operating temperature. This means that regeneration of the diesel particulate filter does not take place and the filter is not emptied.

When the filter has become approx. 80% full of particles, a yellow warning triangle illuminates, and the message **Particulate filter full** See **Owner's manual** is shown in the driver display.

Start regeneration of the filter by driving the car until the engine reaches normal operating temperature, preferably on a main road or motorway.

The car should then be driven for approximately 20 minutes more.

### NOTE

The following may arise during regeneration:

- a smaller reduction of engine power may be noticed temporarily
- fuel consumption may increase temporarily
- a smell of burning may arise.

When regeneration is complete the warning text is cleared automatically.

Use the parking heater\* in cold weather - the engine then reaches normal operating temperature more quickly.

### IMPORTANT

If the filter is completely filled with particles, it may be difficult to start the engine and the filter is non-functional. Then there is a risk that the filter will need to be replaced.

### Related information

- Diesel (p. 419)

## Economical driving

Drive economically and eco-consciously by driving smoothly, thinking ahead, and adjusting your driving style and speed to the prevailing conditions.

- For lower fuel consumption, activate ECO drive mode.
- Use the Eco Coast<sup>21</sup> freewheel function - engine braking will cease and the car's kinetic energy can be used to freewheel for longer distances.
- Drive in the highest gear<sup>22</sup> possible, adapted to the current traffic situation and road - lower engine speeds result in lower fuel consumption. Use the gear shift indicator.
- Drive at a steady speed and keep a good distance to other vehicles and objects to minimise braking.
- High speed results in increased fuel consumption - the wind resistance increases with speed.
- Do not run the engine to operating temperature at idling speed, but rather drive with a normal load right after starting - a cold engine consumes more fuel than a warm one.

<sup>21</sup> See the section "Drive mode ECO".

<sup>22</sup> Applies to driving with manual gear changing.

- Drive with the correct air pressure in the tyres and check this regularly - select ECO tyre pressure for best results.
- Choice of tyres can affect fuel consumption - seek advice on suitable tyres from a dealer.
- Remove unnecessary items from the car - the greater the load the higher the consumption.
- Use engine braking to slow down, when it can take place without risk to other road users.
- A roof load and space box increase wind resistance, leading to higher consumption - remove the load carriers when not in use.
- Avoid driving with open windows.

### WARNING

Never switch off the engine while moving, such as downhill, this deactivates important systems such as the power steering and brake servo.

### Related information

- Drive mode ECO (p. 400)
- Approved tyre pressures (p. 578)
- Fuel consumption and CO<sub>2</sub> emissions (p. 573)
- Drive-E - cleaner driving pleasure (p. 25)

## Towing bracket\*

The car can be equipped with a towing bracket that makes it possible to tow e.g. a trailer after the car.

There may be different towing bracket variants available for the car; contact a Volvo dealer for more information.

For information on towing capacity and towball load, see the section "Towing capacity and towball load".

### IMPORTANT

When the engine is switched off, the constant battery voltage to the trailer connector can be switched off automatically so as not to drain the starter battery.

### IMPORTANT

The towball needs regular cleaning and lubrication with grease in order to prevent wear.

**i NOTE**

When a hitch with a vibration damper is used, the towball must not be lubricated.

This also applies when fitting a bicycle rack that is clamped in around the towball.

**i NOTE**

If the car is equipped with a towing bracket, there is no rear mounting for a towing eye.

**Related information**

- Driving with a trailer (p. 426)
- Towing capacity and towball load (p. 564)
- Trailer Stability Assist\* (p. 428)
- Towing bracket specifications\* (p. 425)
- Extendable/retractable towing brackets\* (p. 423)

**Extendable/retractable towing brackets\***

The extendable/retractable towing hitch is always easily accessible and simple to extend or retract as needed. In the retracted position, the towing hitch is completely concealed.

**⚠ WARNING**

Follow the instructions for retracting and extending the towing bracket carefully.

**Extending the towing hitch****⚠ WARNING**

Avoid standing close to the bumper in the centre behind the car when extending the towing hitch.

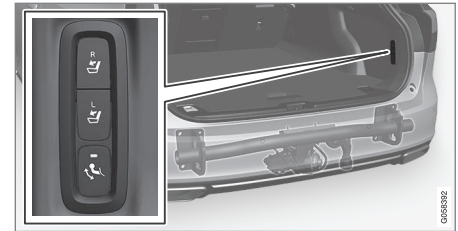

1. Open the tailgate. A button for extending/retracting the towbar is located on the right-hand side at the rear of the cargo area. An indicator lamp in the button must illuminate with a constant orange glow for the extension function to be active.



2. Press and release the button - extension might not start if the button is pressed for too long.
  - > The towbar extends out and down in an unlocked position - the indicator lamp flashes orange.

**⚠ WARNING**

Do not press the extend/retract button if a trailer is attached to the towing bracket.

**i NOTE**

The towbar must finish the extension procedure before it can then be moved to locked position. This procedure may take several seconds. If the towbar is not fixed in locked position, wait a few seconds and try again.



3. Move the towbar to its end position, where it is secured and locked in place - the indicator lamp illuminates with a constant orange glow.
  - > The towbar is ready for use.

**⚠ WARNING**

Take care to secure the trailer's safety cable in the intended bracket.

**i NOTE**

Power save mode activates after a while and the indicator lamp goes out. The system is reactivated by closing and opening the tailgate. This applies when retracting or extending the towing bracket.

If the car detects a connected trailer electrically, the indicator lamp stops illuminating with a constant glow.

**Retracting the towing hitch**

**! IMPORTANT**

Make sure that there is no plug or adapter in the electrical socket when retracting the towing bracket.

1. Open the tailgate. Press and release the button on the right-hand side at the rear of the cargo area - retraction might not start if the button is pressed for too long.
  - > The towing bracket automatically lowers in an unlocked position - the indicator lamp in the button flashes orange.

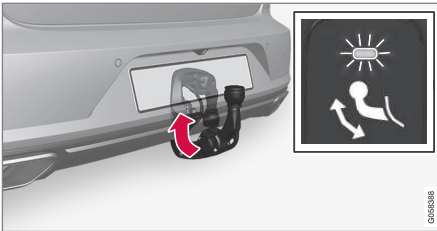

2. Lock the towing bracket by moving it back to its retracted position, where it is locked.
  - > The indicator lamp will now illuminate with a constant glow if the towing bracket is correctly retracted.

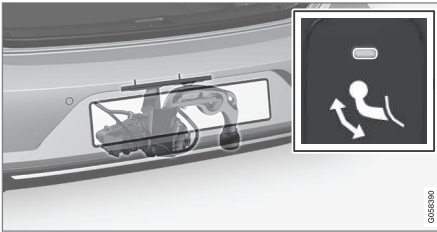

### Related information

- Towing bracket\* (p. 422)
- Towing bracket specifications\* (p. 425)

### Towing bracket specifications\*

Dimensions and mounting points for the towing bracket.

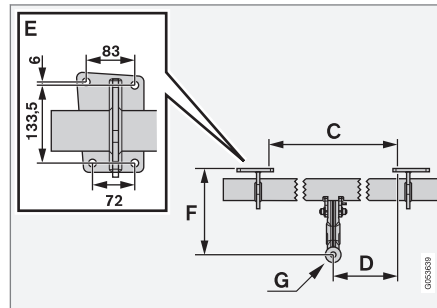
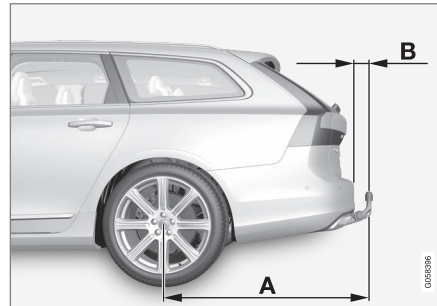

Dimensions, mounting points (mm)	
A	1229
B	111.8
C	875
D	437,5
E	See the image above
F	310.5
G	Ball centre

### Related information

- Towing bracket\* (p. 422)

## Driving with a trailer

When driving with a trailer, there are a number of points that are important to think about regarding the towing bracket, the trailer and how the load is positioned in the trailer.

Payload depends on the car's kerb weight. The total of the weight of the passengers and all accessories, e.g. towbar, reduces the car's payload by a corresponding weight.

The car is supplied with the necessary equipment for towing a trailer.

- The car's towing bracket must be of an approved type.
- Distribute the load on the trailer so that the weight on the towing bracket complies with the specified maximum towball load. Towball load is calculated as part of the car's payload.
- Increase the tyre pressure to the recommended pressure for a full load. For more information on tyre pressure, see the section "Approved tyre pressures".
- The engine is loaded more heavily than usual when driving with a trailer.
- Do not tow a heavy trailer when the car is brand new. Wait until it has been driven at least 1000 km.
- The brakes are loaded much more than usual on long and steep downhill slopes. Downshift to a lower gear and adjust your speed.

- Follow the regulations in force for the permitted speeds and weights.
- Maintain a low speed when driving with a trailer up long, steep ascents.
- The maximum trailer weights given only apply to altitudes up to 1000 metres above sea level. At higher altitudes, engine power and thus the car's climbing ability is decreased due to the reduced air density, and the maximum trailer weight must therefore be reduced. The weight of the car and trailer must be decreased by 10 % for each additional 1000 m (or part thereof).
- Avoid driving with a trailer on inclines of more than 12%.

### NOTE

Extreme weather conditions, driving with a trailer or driving at high altitudes in combination with fuel quality are factors that considerably increase the car's fuel consumption.

### Trailer connector

An adapter is required if the car's towing bracket has a 13 pin connector and the trailer has a 7 pin connector. Use an adapter approved by Volvo. Make sure the cable does not drag on the ground.

### IMPORTANT

When the engine is switched off, the constant battery voltage to the trailer connector can be switched off automatically so as not to drain the starter battery.

### Trailer weights

Information about Volvo's permitted trailer weights is available in the article "Towing capacity and towball load".

### WARNING

Follow the stated recommendations for trailer weights. Otherwise, the car and trailer may be difficult to control in the event of sudden movement and braking.

### NOTE



The stated maximum permitted trailer weights are those permitted by Volvo. National vehicle regulations can further limit trailer weights and speeds. Towbars can be certified for higher towing weights than the car can actually tow.

### Direction indicators and brake lights on the trailer

If one or more of the trailer's direction indicators or brake light bulbs is broken, the driver display



shows a symbol and a message. Other lamps on the trailer must be checked manually by the driver before departure, see the heading "Checking trailer lamps".

Symbol	Message
	<ul style="list-style-type: none"> <li>• Trailer turn indicator Right turn indicator malfunction</li> <li>• Trailer turn indicator Left turn indicator malfunction</li> </ul>
	<ul style="list-style-type: none"> <li>• Trailer brake light Malfunction</li> </ul>

If any lamp for the trailer's direction indicators is broken, the driver display symbol for direction indicators will also flash more quickly than normal.

## Checking trailer lamps\*

### Automatic checking

After a trailer is connected electrically, it is possible to check that the trailer lamps are working via an automatic lamp activation. The function helps the driver check that the trailer lamps are working before starting off.

The engine must be switched off to perform the check.

1. When a trailer is connected to the towing bracket, the **Automatic Trailer Lamp Check** message is shown in the driver display.
2. Confirm the message by pressing the right-hand steering wheel keypad's **O** button.
  - > The lamp check starts.
3. Exit the car to check lamp functionality.
  - > All trailer lamps start to flash - then the lamps are switched on one at a time.
4. Visually check that all lamps available on the trailer are operational.
5. After a moment, all lamps on the trailer flash again.
  - > The check is complete.

### Switching off automatic checking

The automatic checking function can be switched off in the centre display.

1. Press **Settings** in the top view.
2. Press **My Car → Lights and Lighting**.
3. Deselect **Automatic Trailer Lamp Check**.

### Manual checking

If the automatic checking is switched off then it is possible to start the check manually.

1. Press **Settings** in the top view.

2. Press **My Car → Lights and Lighting**.
3. Select **Manual Trailer Lamp Check**.
  - > The lamp check starts. Exit the car to check lamp functionality.

### Level control\*

The car's system for level control endeavours to maintain a constant height regardless of load (up to the maximum permissible weight). When the car is stationary the rear of the car lowers slightly, which is normal.

### Related information

- Driving with a trailer under special conditions (p. 428)
- Towing capacity and towball load (p. 564)
- Trailer Stability Assist\* (p. 428)
- Approved tyre pressures (p. 578)
- Towing bracket\* (p. 422)

### **Driving with a trailer under special conditions**

When driving with a trailer in hilly terrain in a hot climate there may be a risk of overheating.

In the event of overheating, a warning symbol illuminates in the driver display together with a message, see section "Overheating in the engine and drive system".

The following only applies to cars with automatic gearbox.

The automatic gearbox selects the optimum gear related to load and engine speed.

### **Steep inclines**

Do not lock the automatic gearbox in a higher gear than the engine "can cope with" - it is not always a good idea to drive at a high gear with low engine speed.

### **Parking on a hill**

1. Depress the brake pedal fully.
2. Activate the parking brake.
3. Select gear position **P**.
4. Release the brake pedal.

Block the wheels with chocks when parking a car with hitched trailer on a hill.

### **Starting on a hill**

1. Depress the brake pedal fully.

2. Select gear position **D**.
3. Releasing the parking brake.
4. Release the brake pedal and start driving off.

### **Related information**

- Driving with a trailer (p. 426)
- Overheating in the engine and drive system (p. 412)
- Using the parking brake (p. 408)

### **Trailer Stability Assist\***

The function of the trailer stability assist Trailer Stability Assist (TSA) is to stabilise cars with attached trailers in situations where they begin

snaking. The function is included in the stability system ESC<sup>23</sup>.

### Reasons for snaking

The snaking phenomenon can occur with any car/trailer combination. Snaking normally occurs at high speeds. But, there is a risk of it occurring at lower speeds if the trailer is overloaded or the load is improperly distributed, e.g. too far back.

In order for snaking to occur, there must be a triggering factor, e.g.:

- Car with trailer subjected to a sudden and powerful side wind.
- Car with trailer drives on an uneven road surface or in a pothole.
- Sweeping steering wheel movements.

If snaking has started, it could be difficult or even impossible to suppress. This makes the car/trailer combination difficult to control and there is a risk that you could, for example, end up in the wrong lane or leave the carriageway.

### Trailer Stability Assist function

The trailer stability assist function continually monitors car movements, particularly lateral movements. If snaking is detected, the front wheels are individually braked. This serves to stabilise the car/trailer combination. This is often enough to help the driver regain control of the car.

If snaking is not eliminated the first time that trailer stability assist comes into action, the car/trailer combination is braked with all wheels and engine power is reduced. Once snaking has been gradually suppressed and the car/trailer combination is stable once again, the system stops regulating and the driver once again has full control of the car.

#### NOTE

The stability function is deactivated if the driver selects Sport mode by deactivating **ESC** via the menu system in the centre display.

The trailer stability assist may fail to engage if the driver uses severe steering wheel movements to try to rectify the snaking because in such a situation the system cannot determine whether it is the trailer or the driver that is causing the snaking.



When trailer stability assist is operating, the **ESC** symbol flashes in the driver display.

### Related information

- Driving with a trailer (p. 426)
- Driving with a trailer under special conditions (p. 428)
- Electronic stability control (p. 271)

<sup>23</sup> Electronic Stability Control (Electronic stability control)

## Towing eye

Use the towing eye for towing. The towing eye is screwed into a threaded socket behind a cover on the right-hand side of the bumper, front or rear.

### **i** NOTE

If the car is equipped with a towing bracket, there is no rear mounting for a towing eye.

## Fitting the towing eye

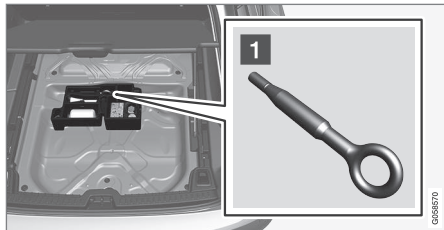

- 1 Take out the towing eye from the foam block under the floor hatch in the cargo area<sup>24</sup>.

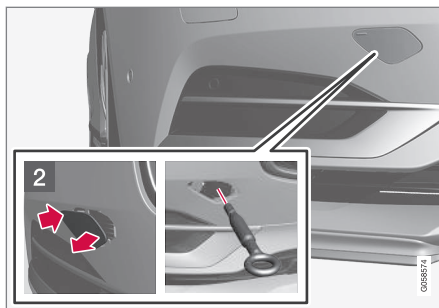

- 2 Front: Remove the cover.  
> The cover pivots around its centre line and can then be removed.

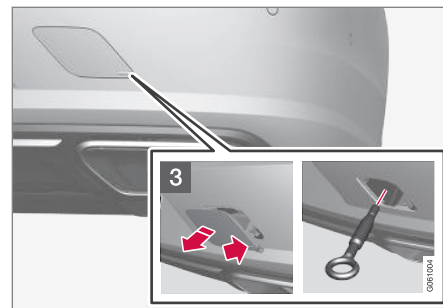

- 3 Rear: Remove the cover - press on the marking with a finger and, at the same time, fold out the opposite side/corner using a coin or similar.  
> The cover pivots around its centre line and can then be removed.
4. Screw the towing eye right in until it stops. Tighten the towing eye firmly e.g. using the wheel wrench\*.

After use, unscrew the towing eye and return it to its place.

Finish by refitting the cover onto the bumper.

<sup>24</sup> In a Bi-Fuel car the towing eye is located behind the side hatch on the left-hand side of the cargo area.

**! IMPORTANT**

It is important that the towing eye is firmly screwed into place - right in until it stops.

The towing eye may be used to pull the car up onto a recovery vehicle with a flatbed platform. The car's position and ground clearance determine whether it is possible.

If the slope of the recovery vehicle's ramp is too steep, or if the ground clearance under the car is inadequate, then the car may be damaged if you try to pull it up using the towing eye.

If necessary, raise the car by using the recovery vehicle's lifting device. Do not use the towing eye.

**! WARNING**

No one/nothing is allowed to remain behind the recovery vehicle while the car pulled up onto the flatbed platform.

**! IMPORTANT**

The towing eye is only designed for towing on roads - **not** for pulling the car unstuck or out of a ditch. Call a recovery service for recovery assistance.

**Related information**

- Towing (p. 431)
- Recovering the car (p. 432)

**Towing**

During towing, one vehicle pulls another vehicle along behind it by means of a towline.

Find out the statutory maximum speed limit for towing before the towing begins.

**Preparations and towing**

1. Activate the car's hazard warning flashers.
2. Secure the towline in the towing eye.
3. Deactivate the steering lock by unlocking the car.

**i NOTE**

In ignition position **II** the steering lock is deactivated if the car has been unlocked. See section "Ignition position" for more information.

4. Set the car in ignition position **II** by turning the ignition dial to **START** and holding the ignition dial in the **START** position for approx. 4 seconds. Then release the knob, which automatically returns to its starting position.
5. Move the gear selector to neutral position **N** and release the parking brake.
  - > The towing vehicle can now start towing.

6. Keep the towline taut when the towing vehicle reduces speed by holding your foot gently pressed on the brake pedal - thereby avoiding unnecessary jerking.
7. Be prepared to brake to stop.

**! IMPORTANT**

Note that the car must always be towed with the wheels rolling forward.

- Do not tow cars with automatic transmission at speeds higher than 80 km/h (50 mph) or for distances in excess of 80 km.

**! WARNING**

- Check that the steering lock is unlocked before towing.
- Ignition position **II** must be active - in ignition position **I** all airbags are deactivated.
- Always keep the remote control key in the car when it is being towed.

**! WARNING**

The brake servo and power steering do not work when the engine is switched off - the brake pedal needs to be depressed about 5 times more heavily and the steering is considerably heavier than normal.



## ◀◀ Jump starting

Do not tow the car to jump start the engine. Use a donor battery if the starter battery is discharged and the engine does not start.

### ! IMPORTANT

The catalytic converter may be damaged during attempts to tow-start the engine.

### Related information

- Warning triangle (p. 500)
- Towing eye (p. 430)
- Recovering the car (p. 432)
- Using jump starting with another battery (p. 386)
- Ignition positions (p. 383)

## Recovering the car

For recovery, the car is taken away with the help of another vehicle.

Call a recovery service for recovery assistance.

The towing eye can be used to pull the car up onto a recovery vehicle with a flatbed platform.

**Applies to cars with level control\***: If the car is equipped with air suspension, this must be disabled before the car is raised. Deactivating the function via the centre display.

1. Press **Settings** in the top view.
2. Press **My Car** → **Suspension**.
3. Select **Disable Leveling Control**.

The car's position and ground clearance determine whether it is possible to pull it up onto a flatbed platform. If the slope of the recovery vehicle's ramp is too steep, or if the ground clearance under the car is inadequate, then the car may be damaged if you try to pull it up. The car should then be lifted using the recovery vehicle's lifting device.

### ! WARNING

No one/nothing is allowed to remain behind the recovery vehicle while the car pulled up onto the flatbed platform.

### ! IMPORTANT

The towing eye is only designed for towing on roads - **not** for pulling the car unstuck or out of a ditch. Call a recovery service for recovery assistance.

### ! IMPORTANT

Note that the car must always be transported with the wheels rolling forward.

### i NOTE

If the car is equipped with a towing bracket, there is no rear mounting for a towing eye.

### Related information

- Towing (p. 431)
- Towing eye (p. 430)

AUDIO AND MEDIA

## Audio and media

The audio and media system consists of media player, radio and Bluetooth phone connection. With an online car it is also possible to listen to services via apps.

Functions can be controlled by voice command or via the steering wheel keypad and the centre display. The number of speakers and amplifiers depends on which audio system the car is equipped with.

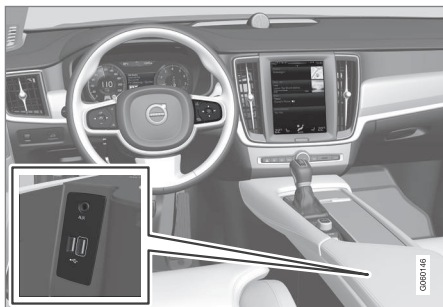

Overview of audio and media.

## System updating

The audio and media system is continuously improved. When the car is online there is the option to download updates for optimal functionality, see the section "System updates" and support.volvocars.com.

## Related information

- Media player (p. 442)
- Radio (p. 436)
- Phone (p. 456)
- Online car\* (p. 463)
- Apps (p. 434)
- Ignition positions (p. 383)
- Symbols in the centre display's status bar (p. 45)
- Voice recognition (p. 115)
- System updates (p. 510)
- License agreement for audio and media (p. 470)

## Apps

Applications (apps) facilitate access to some of the car's services.



Application view.

Some basic apps are always available. When the car is online it is possible to download more. The apps that are available to download vary, but can include Internet radio and music services.

Certain apps are only available for use if the car is connected to the Internet.



- Tap on an app in the app view to launch it.

### Related information

- Online car\* (p. 463)
- Downloading, updating and uninstalling apps (p. 468)
- Changing settings for apps (p. 178)

## Audio settings

The audio system is preset for optimal sound reproduction, but can be adapted according to needs.

The volume is normally adjusted with the volume control below the centre display or with the right-hand steering wheel keypad.

### Setting for optimal sound reproduction

The audio system is pre-calibrated for optimum sound reproduction by means of digital signal processing. This calibration takes into account loudspeakers, amplifiers, passenger compartment acoustics, listener position, etc., for each combination of car model and audio system. There is also a dynamic calibration that takes into account the setting of the volume control and vehicle speed.

Audio settings are described in the corresponding section in the owner information. To access the settings, open the top view and tap on

**Settings** → **Sound**.

### Active noise reduction\*

Certain cars are equipped with an active noise reduction function that suppresses engine noise in the passenger compartment via the audio system. Microphones in the car's roof detect disruptive noise and the audio system outputs anti-noise in order to dampen the noise.

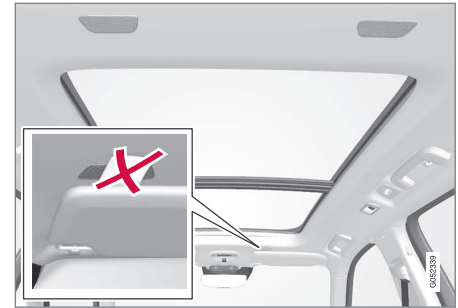

Microphones in the car's roof.

### **i** NOTE

Do not cover the car's microphones; otherwise a rumbling sound from the audio system may be produced.

### Related information

- Audio settings for media (p. 448)
- Settings for voice recognition (p. 117)
- Settings for phone (p. 462)
- Audio and media (p. 434)
- Online car\* (p. 463)

## Radio

It is possible to listen to the AM and FM bands and to digital radio (DAB)\*. When the car is online it is also possible to listen to Internet radio.

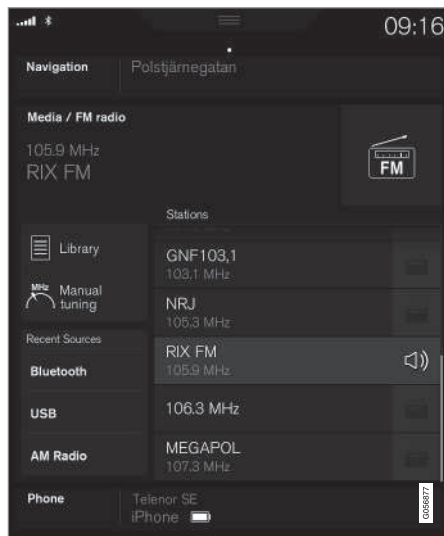

The radio can be operated using voice recognition, the steering wheel keypad or the centre display.

### Related information

- Changing and searching radio stations (p. 436)
- Digital radio (p. 440)
- RDS radio (p. 439)
- Online car\* (p. 463)
- Voice recognition control of radio and media (p. 118)
- Media player (p. 442)

## Changing and searching radio stations

The radio automatically compiles a station list of the radio stations within the area that are transmitting the strongest signals.

### Starting the radio

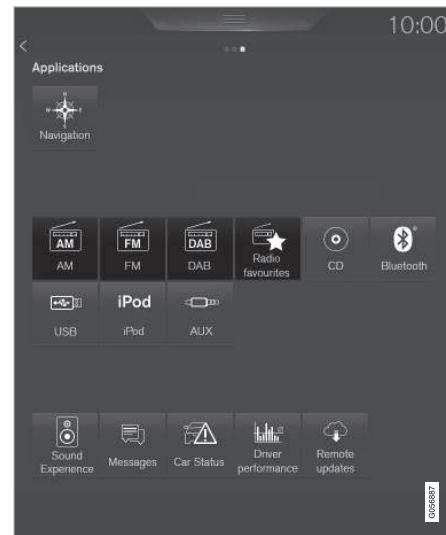

1. Open the app (e.g. **FM**) from the app view.
2. Select station.

## Changing lists within the frequency band

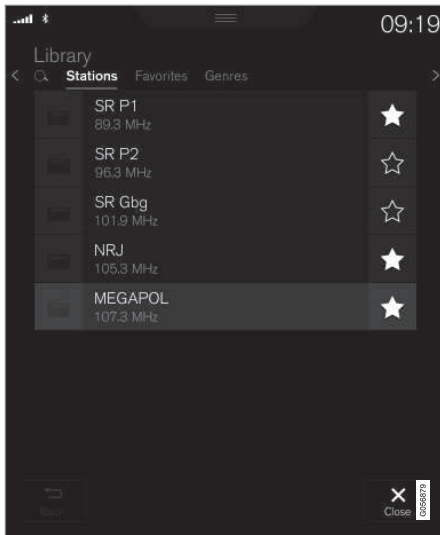

1. Press **Library**.
2. Select playback from **Stations, Favourites, Genres** or **Ensembles**<sup>1</sup>.
3. Tap on the desired station from the list.

**Favourites** — only plays back selected favourite channels, see heading “Favourites” below.

**Genres** — only plays back channels broadcasting the selected genre/programme type, e.g. pop or classical.

## Changing stations within the selected list

- Press on <> under the centre display or the steering wheel's right-hand keypad.
  - > The highlight moves up or down one place in the selected playlist.

You can also change stations from the centre display.

## Favourites

When a favourite is saved from a list, the radio will automatically search for the best frequency. But if a favourite is saved from a manual station search, the radio does not automatically change to a stronger frequency.

To choose among favourites within the frequency band, see the heading “Changing lists within the frequency band” above. To choose from among all favourites, see the heading “Radio Favourites” below.

- Tap on ☆ to add or remove a channel to or from frequency band favourites and Radio Favourites.

## Radio Favourites



Radio Favourites shows saved favourites from all frequency bands.

1. Open the app **Radio favourites** from the app view.
2. Tap on the desired station in the list to start listening.

When you remove a favourite, it will also be removed from frequency band favourites.

<sup>1</sup> Only applies to digital radio (DAB).

## ◀◀ Changing radio band

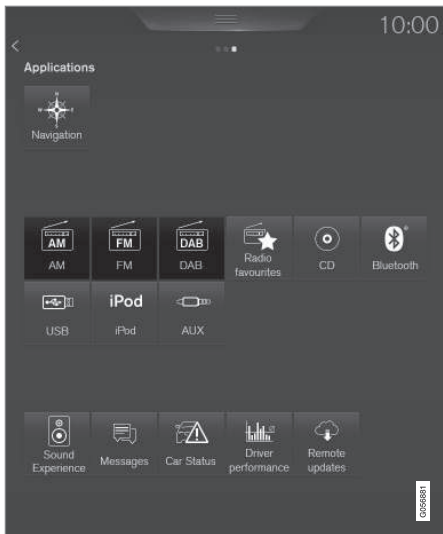

- Tap on the app (such as **FM**) from app view, or open the app menu with the right-hand steering wheel keypad and select from there.

## Searching for radio stations

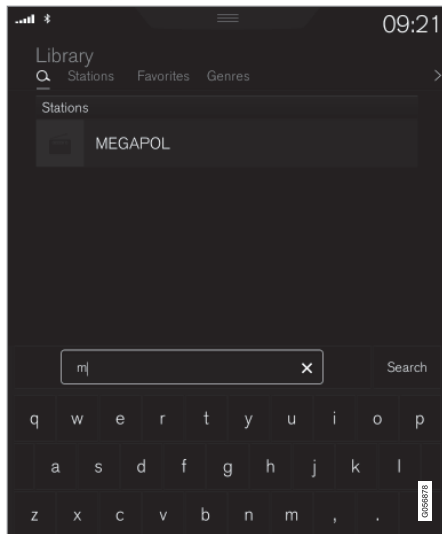

The parameters you can search on depend on the frequency band selected:

- AM — station and frequency.
  - FM — station, genre and frequency.
  - DAB - ensembles and stations.
1. Press **Library**.
  2. Press **Q**.
    - > Search view with keyboard is opened.

3. Enter the search terms.
  - > Searching takes place with each input of a character and the search results are shown by category.

## Manual tuning

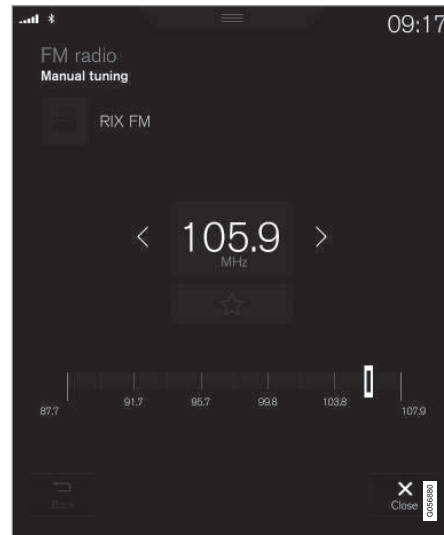

On changing over to manual tuning, the radio no longer changes frequency automatically when reception is poor.

- Tap on **Manual tuning**, pull the control or tap on <> to the desired frequency.

**Related information**

- Radio (p. 436)
- Digital radio (p. 440)
- Voice recognition control of radio and media (p. 118)

**RDS radio**

With RDS (Radio Data System) the radio can automatically change to the strongest transmitter. RDS provides the ability to receive e.g. traffic information and to search for certain programme types.

RDS links FM transmitters into a network. An FM transmitter in such a network sends information that gives an RDS radio the following functions:

- Switch automatically to a stronger transmitter if reception in the area is poor.
- Search for programme category, e.g. programme types or traffic information.
- Receive text information on current radio programme.

** NOTE**

Some radio stations do not use RDS or only selected parts of its functionality.

When broadcasting news or traffic messages, the radio can switch stations, interrupting the audio source currently in use. For example, if the CD player is in use, it is paused. The radio returns to the previous audio source and volume when the set programme type is no longer broadcast. To go back earlier, press  on the right-hand steering wheel keypad or tap **Cancel** in the centre display.

**Related information**

- Radio (p. 436)
- Settings for radio (p. 441)

## Digital radio

Digital radio (Digital Audio Broadcasting, DAB) is a digital broadcasting system for radio. The radio supports DAB, DAB+ and DMB (Digital Multimedia Broadcasting).



The radio can be operated using voice recognition, the steering wheel keypad or the centre display.



The digital radio app is launched from app view in the centre display.

Digital radio plays back in the same way as FM and AM, see section "Changing and searching for radio stations". Besides the options to select playback from **Stations**, **Favourites** and **Genres**, there is also the option to select playback from subchannels and **Ensembles**. An ensemble is a set of radio channels (a channel group) broadcasting on the same frequency.

In the cases where the radio channel transmits its logotype, it is downloaded and shown beside the station name (download time varies).

## DAB subchannel

Secondary components are usually named subchannels. These are temporary and can contain e.g. translations of the main programme into other languages. Subchannels are indicated with an arrow symbol in the channel list.

## Related information

- Changing and searching radio stations (p. 436)
- Linking between different radio bands FM and DAB (p. 440)
- Voice recognition control of radio and media (p. 118)
- Radio (p. 436)
- Settings for radio (p. 441)
- Resetting settings in the settings view (p. 173)

## Linking between different radio bands FM and DAB

The function enables the digital radio to switch from a channel with poor or no reception to the same channel in another channel group (ensemble) with better reception, within DAB and/or between DAB and FM.

## DAB to DAB and DAB to FM linking

1. Press **Settings** in top view.
2. Press **Media** → **DAB**.
3. Tick/untick **DAB To DAB Handover** and/or **DAB To FM Handover** in order to activate/deactivate the respective functions.

## Related information

- Digital radio (p. 440)
- Radio (p. 436)
- Settings for radio (p. 441)

## Settings for radio

Settings for the different radio bands.

The broadcast of traffic messages etc. can be temporarily interrupted by tapping on  in the right-hand steering wheel keypad or by tapping on **Cancel** in the centre display.

Drag down the top view and select **Settings** → **Media** and the desired radio band. Activating/deactivating functions.

### AM/FM

- **Show Broadcast Information** — shows information on programme content, artists, etc.
- **Freeze Program Name** — select to stop the programme service name from scrolling continuously. Instead it freezes after 20 seconds.
- **News** - interrupts the current media playback and broadcasts news. Playback of previous media source is resumed when the news broadcast is finished.
- **Traffic Announcements** - interrupts the current media playback and broadcasts information about traffic disruptions. Playback of previous media source is resumed when the message is finished.
- **Local Interruptions** — interrupts the current media playback and broadcasts information about traffic disruptions in the neigh-

bourhood. Playback of previous media source is resumed when the message is finished. The **Local Interruptions** function is a geographically restricted version of the **Traffic Announcements** function. The **Traffic Announcements** function must be activated at the same time.

- **Alarm** - interrupts the current media playback and sends alerts about major accidents and disasters. Playback of previous media source is resumed when the message is finished.

### DAB

- **Sort Services** - selection for how channels will be sorted. Either alphabetically or by service number.
- **DAB To DAB Handover** - starts the function for linking within DAB. If reception of a radio channel is lost, another channel is found automatically in another channel group (ensemble).
- **DAB To FM Handover** - starts the function for linking between DAB and FM. If reception of a radio channel is lost, an alternative frequency is searched for automatically.
- **Select Announcements** — select the types of messages to be received while DAB is playing. Selected messages will interrupt the current media playback to play back the message. Playback of previous media source is resumed when the message is finished.

**Alarm** - interrupts the current media playback and sends alerts about major accidents and disasters. Playback of previous media source is resumed when the message is finished.

**Traffic Flash** — receives information about traffic disruptions.

**News Flash** — receives news.

**Transport Flash** — receives information about public transport, e.g. ferry and train timetables.

**Warning/Services** — receives information about incidents of lower significance than the Alarm function, e.g. power failures.

- **Show Broadcast Information** — select to show radio text or selected types of radio text, e.g. artist.
- **Show Program Related Images** — select whether or not to show images for programmes on the screen.

### Related information

- Radio (p. 436)
- Digital radio (p. 440)
- Symbols in the centre display's status bar (p. 45)

## Media player

The media player can play back audio from CDs\* and externally connected audio sources via the AUX/USB input or wirelessly stream audio files from external devices via Bluetooth. Video can be watched from USB connected devices. In an Online connected car, it is possible to listen to Internet radio, audiobooks and music services via apps.

The media player also operates the radio, which is described in a separate section.

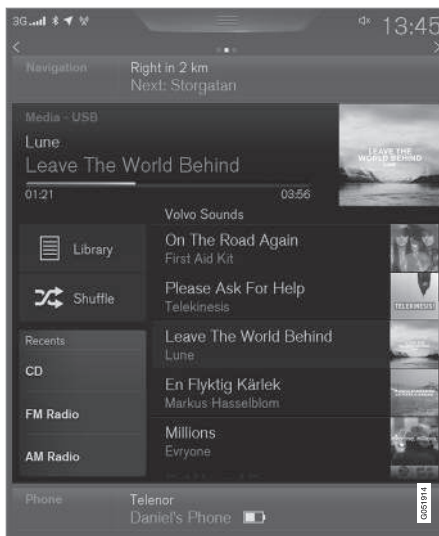

- Apps (p. 434)
- Radio (p. 436)
- CD player\* (p. 446)
- Media via Bluetooth (p. 447)
- Media via AUX/USB input (p. 447)
- video (p. 448)



The media player is controlled from the centre display, but several functions can be controlled from the steering wheel's right-hand keypad or by voice recognition control.

### Related information

- Media playback (p. 443)
- Voice recognition control of radio and media (p. 118)



## Media playback

The media player is controlled from the centre display. Several functions can also be controlled from the right keypad on the steering wheel or with voice recognition.

The media player also operates the radio, which is described in a separate section.

### Starting the media source



#### CD\*

1. Insert a CD.

2. Open the app **CD** from the app view.
3. Select what to play back.
  - > Playback begins.

#### USB memory

1. Insert the USB memory.
2. Open the app **USB** from the app view.
3. Select what to play back.
  - > Playback begins.

#### Mp3 player and iPod®

##### **i** NOTE

To start playback from iPod, use the iPod app (not USB).

When an iPod is used as audio source, the car's audio and media system has a menu structure that is similar to the iPod player's own menu structure.

1. Connect media source.
2. Start playback from the connected media source.
3. Open the app (**iPod, USB, AUX**) from the app view.
  - > Playback begins.

#### Bluetooth connected device

1. Activate Bluetooth in the media source.
2. Connect media source.

3. Start playback from the connected media source.
4. Open the app **Bluetooth** from the app view.
  - > Playback begins.

#### Internet media

1. Connecting the car.
2. Open the app from the app view.
  - > Playback begins.

#### video

1. Connect media source.
2. Open the app **USB** from the app view.
3. Tap on the title of the desired item to play back.
  - > Playback begins.

#### Apple CarPlay

Apple CarPlay is described in a separate section.

#### Controlling and changing media



The media player can be operated by voice recognition, from the steering wheel keypad or the centre display.



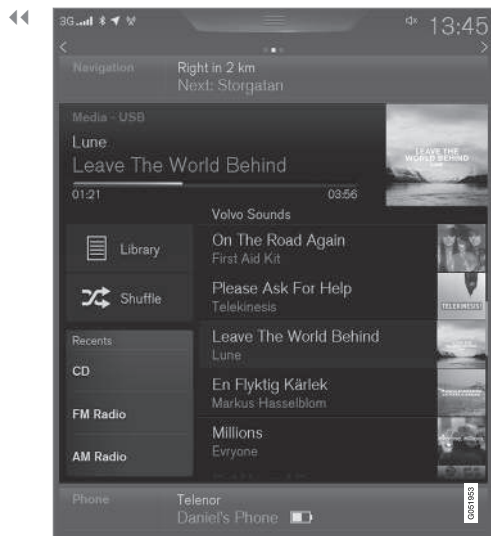

Volume - turn the control knob under the centre display or press ▲ ▼ on the steering wheel's right-hand keypad in order to increase or decrease the volume.

Play/pause - tap on the image belonging to the song being played, the button under the centre display or ⏸ on the steering wheel's right-hand keypad.

Change track/song - tap on the desired track in the centre display, press on ⏮ ⏭ under the cen-

tre display or on the steering wheel's right-hand keypad.

Fast forward/move in time - tap on the time axis in the centre display and drag sideways, or press and hold ⏮ ⏭ depressed under the centre display or on the steering wheel's right-hand keypad.

Changing media - select under **Recent sources** in the app, and in the app view, tap on the desired app, or select using the steering wheel's right-hand keypad via the app menu ☰.

**Library** - tap on the button to play back from the library.

**Shuffle** - tap on the button to shuffle the playback order.

**Similar** - tap on the button in order to use Gracenote to search for similar music on the USB device and to create a playlist from it. The playlist can contain a maximum of 50 songs.

**Change device** - tap on the button in order to switch between USB devices when several are connected.

### Settings for video

With the video player in full screen mode, or by opening the top view and pressing **Settings** → **Video**, the following can be adjusted: **Audio Language**, **Off** and **Subtitle Language**.

### Playing back DivX®

This DivX Certified® device must be registered in order to play back purchased DivX Video-on-Demand (VOD) films.

1. Press **Settings** in top view.
2. Tap **Video** → **DivX® VOD** and retrieve the registration code.
3. Go to vod.divx.com for more information and to complete the registration.

### Related information

- Using the application menu in the driver display (p. 106)
- Voice recognition control of radio and media (p. 118)
- Connecting the car (p. 464)
- Apps (p. 434)
- Searching media (p. 446)
- Connecting media via Bluetooth (p. 447)
- Connecting media via AUX/USB input (p. 448)
- CD player\* (p. 446)
- Radio (p. 436)
- Gracenote® (p. 445)
- video (p. 448)
- Audio settings for media (p. 448)
- TV\* (p. 449)

- Apple CarPlay\* (p. 450)
- Technical specifications for media (p. 455)

## Gracenote®

Gracenote identifies artist, album, song titles and associated images, which are shown during playback.

Gracenote MusicID® is a standard for music recognition.

### Activate/deactivate Gracenote

On activation, Gracenote data replace the original data.

1. Press **Settings** in top view.
2. Press **Media → Gracenote**®.
3. Activate/deactivate Gracenote by ticking/unticking the box for **Gracenote**®.
4. Select settings for activated Gracenote data:
  - **Gracenote**® **Online Search** - searches in Gracenote's online database for playing media.
  - **Gracenote**® **Multiple Results** - selects how to display Gracenote data if there are more than one search results.
    - 1 - the file's original data are used.
    - 2 - Gracenote data are used.
    - 3 - Gracenote or original data can be selected.
  - **None** - no results are shown.

## Updating Gracenote

The content of the Gracenote database is updated continuously. Download the latest update for optimal functionality. For information and download, see support.volvocars.com.

### Related information

- Media playback (p. 443)
- License agreement for audio and media (p. 470)

## Searching media

It is possible to search by artist, composer, song (titles), album, video, audiobook, playlist and, when the car is online, podcasts (digital media via Internet).

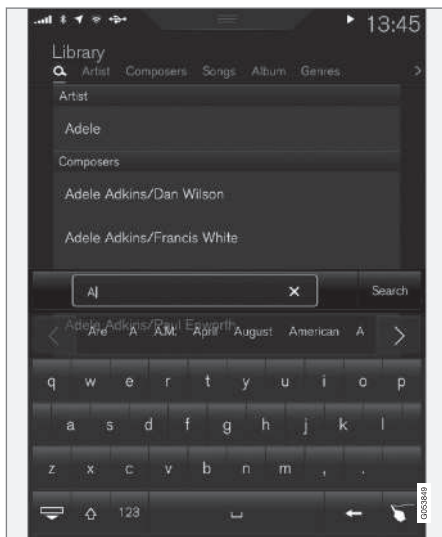

1. Press **Q**.  
> Search view with keyboard is opened.
2. Enter the search terms.

3. Press **Search**.  
> Connected devices are searched and the search results are listed by category.

Swipe sideways across the screen to show each category separately.

### Related information

- Media player (p. 442)
- Media playback (p. 443)
- Using the keyboard in the centre display (p. 49)
- Online car\* (p. 463)

## CD player\*

The media player can play back CD discs with audio files. See technical specifications for supported formats.

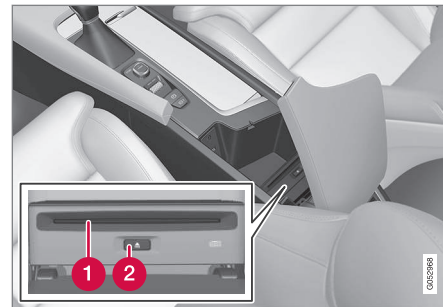

- 1 Disc insert and eject slot.
- 2 Disc eject button.

### Related information

- Media playback (p. 443)
- Voice recognition control of radio and media (p. 118)
- Media player (p. 442)
- Technical specifications for media (p. 455)

## Media via Bluetooth

The car's media player is equipped with Bluetooth and can wirelessly play streaming audio files from external devices with Bluetooth, such as mobile phones and PDAs.

### Related information

- Connecting media via Bluetooth (p. 447)
- Media playback (p. 443)
- Voice recognition control of radio and media (p. 118)
- Media player (p. 442)
- Ignition positions (p. 383)
- Technical specifications for media (p. 455)

## Connecting media via Bluetooth

Connect a Bluetooth device with the car in order to stream media and use as Internet connection if it is available.

Many phones on the market now have wireless Bluetooth technology, but not all of them are fully compatible with the car. For compatibility, see [support.volvocars.com](http://support.volvocars.com).

The procedure for connecting a media device is the same as for connecting a phone.

### Related information

- Connect phone (p. 457)
- Media via Bluetooth (p. 447)
- Media playback (p. 443)
- Media player (p. 442)

## Media via AUX/USB input

An external media source, e.g. an iPod or MP3 player, can be connected to the audio system.

A media source with rechargeable batteries is recharged when connected via USB and when the ignition is in position **I, II** or the engine is running.

To facilitate the use of a USB memory stick, only store compatible formats on it. It takes a lot longer for the system to load storage media that contains anything other than compatible formats. In addition to audio, the media player also supports video playback when the device is connected via USB.

Some MP3 players have their own file systems that are not supported by the audio system.

### Related information

- Connecting media via AUX/USB input (p. 448)
- Media playback (p. 443)
- Voice recognition control of radio and media (p. 118)
- Media player (p. 442)
- Ignition positions (p. 383)
- video (p. 448)
- Apple CarPlay\* (p. 450)
- Technical specifications for media (p. 455)

## Connecting media via AUX/USB input

An external audio source, e.g. an iPod or MP3 player, can be connected to the audio system via any of the connectors in the tunnel console. The cable must be routed out in the front to avoid being trapped when the hatch is closed.

In the cases where there are two USB ports, the one with the white frame around the port must be used for connecting a phone when it will be used for Apple CarPlay or Android Auto.

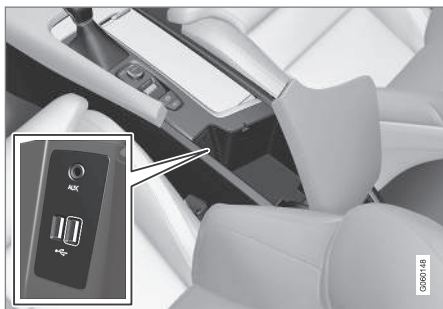

### Related information

- Media playback (p. 443)
- Media via AUX/USB input (p. 447)
- Media player (p. 442)
- Technical specifications for media (p. 455)

## video

Video from a USB-connected device can be played back with the media player.

There will be no picture when the car is moving, but the audio continues to be played back. The picture returns when the car is stationary.

See section "Technical specifications for media" for supported video formats.

### Related information

- Media playback (p. 443)
- Media player (p. 442)
- Technical specifications for media (p. 455)

## Audio settings for media

Personalisation of audio settings for media playback.



Audio mode that recreates the acoustics from Gothenburg Concert Hall.

1. Press **Settings** in top view.
2. Tap on **Sound** and select settings:
  - **Sound Experience\*** — more audio playback options, e.g. playback with concert hall feel. Settings replace any selections made in accordance with the points below for audio settings.
  - **Tone** — personal settings for bass, treble, equaliser, etc.
  - **Balance** - balance between right/left loudspeakers and balance between front/rear loudspeakers.

## System volumes for media

1. Press **Settings** in top view.
2. Press **Sound** → **System Volumes**:
  - **AUX** - If an external audio source (e.g. an MP3 player or iPod) is connected to the AUX input then the audio source that is connected can have a different volume than the audio system's internal volume (e.g. radio). Correct this by adjusting the volume of the input. If the volume is too high or too low then the quality of the sound can be impaired.
  - **Speed and Volume Compensation** - the audio system compensates for disrupting noises in the passenger compartment by increasing the volume in relation to the speed of the car. Compensation level can be set.

## Related information

- Audio settings (p. 435)
- Media player (p. 442)

## TV\*2

The TV picture is only shown when the car is stationary. There will be no picture when the car is moving, but the audio continues to be played back. The picture returns once more when the car is almost or completely stationary.

The TV is controlled from the centre display. Several functions can also be controlled from the right keypad on the steering wheel or with voice recognition.

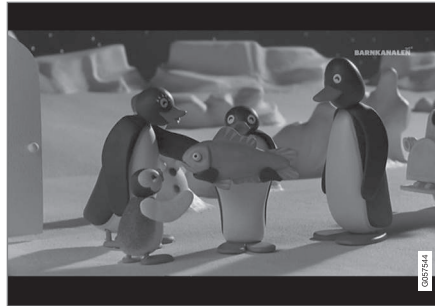

## Related information

- Using the TV\* (p. 449)

## Using the TV\*3

### Start the TV

1. Open the app **TV** from the app view.
2. Select a channel.

### Change or search for TV channels

The TV automatically searches for the channels with best reception.

### Change the list of visible channels

1. Press **Library**
2. Select playback from **TV-channels**, **Favourites** or **Genres**.
3. Select the desired channel.

### Change channel from selected list

- Press on <> under the centre display or on the steering wheel keypad.
  - > The highlight moves up or down one place in the selected playlist

You can also change stations from the centre display.

### Favourites

A TV channel can be saved as a **Favourite**:

- Tap on ☆ in order to add/remove a channel to/from the favourites list.

<sup>2</sup> Applies to certain markets.

<sup>3</sup> Applies to certain markets.

◀ **TV guide**

A programme guide is available with information about TV programmes for up to 48 hours.

- Tap on **Guide** to show information about TV programmes.

**i NOTE**

If the car is moved within the country, e.g. from city to city, it is not certain that **Favourites** are available since the frequency may have changed.

**Change the format of the TV picture**

Tapping on **Picture format** enables you to choose which format the TV picture should be shown in.

1. **Auto** - The TV picture is shown in the image format being transmitted.
2. **Auto fill** - The TV picture is maximised without cropping.

**Settings for TV**

The option to make certain settings is available, both in the top view or when TV-viewing takes place in full screen mode.

With the video player in full screen mode, or by opening the top view and pressing **Settings → Media → TV**, the following can be adjusted:

- **Subtitle Language**
- **Audio Language**

**i NOTE**

The system only supports TV broadcasts in the countries that broadcast in MPEG-2 or MPEG-4 format and follow the DVB-T/T2 standard. The system does not support analogue broadcasts.

**Related information**

- TV\* (p. 449)
- Voice recognition control of radio and media (p. 118)
- Media playback (p. 443)
- Navigating in the centre display's views (p. 40)
- License agreement for audio and media (p. 470)

**Apple CarPlay\***

Apple CarPlay gives you the option to listen to music, make phone calls, get directions, send/receive messages and use Siri, all while you stay focused on your driving. Apple CarPlay works with selected Apple devices.

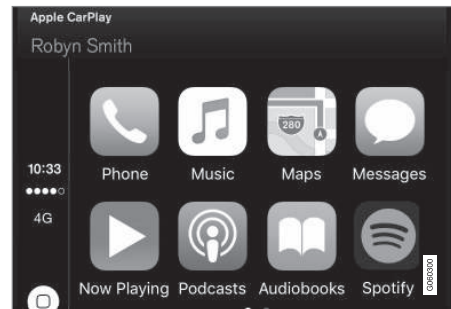



If the car is not already equipped with Apple CarPlay then it is possible to install it afterwards. Contact a Volvo dealer to install Apple CarPlay.

Information about which apps are supported and which phones are compatible is available on Apple's website: [www.apple.com/ios/carplay/](http://www.apple.com/ios/carplay/). Using apps that are not compatible with Apple CarPlay may sometimes mean that the connection between an iPhone and the car is broken. Please note that Volvo is not responsible for the content in Apple CarPlay.



When using map navigation via Apple CarPlay there is no guidance in the driver display or head-up display, but only in the centre display.

The Apple CarPlay apps can be controlled via the centre display, mobile phone or with the steering wheel's right-hand keypad (applies to certain functions). The apps can also be voice-controlled using Siri. A long press on the steering wheel button  starts voice control using Siri and a short press activates the car's own voice control. If Siri breaks off too early, hold the steering wheel button  depressed.

**By using Apple CarPlay you acknowledge the following: Apple CarPlay is a service provided by Apple Inc. under its terms and conditions. Volvo Cars is thus not responsible for Apple CarPlay or its features/applications. When using Apple CarPlay, certain information from your car (including its position) is transferred to your iPhone. In relation to Volvo Cars, you are fully responsible for your and any others person's use of Apple CarPlay.**

### Related information

- Media player (p. 442)
- Connecting the car (p. 464)
- Using Apple CarPlay\* (p. 451)

## Using Apple CarPlay\*

To use Apple CarPlay, Siri voice control must be activated in your phone.

### Connecting iPhone to Apple CarPlay

#### NOTE

Apple CarPlay can only be used if Bluetooth is deactivated. A phone or media player connected to the car via Bluetooth will therefore not be available when CarPlay is active. An alternative Internet source must be used to connect to the Internet for the car's apps. Use Wi-Fi or the car's built-in modem\*.

1. Connect the iPhone to the USB port. In the cases where there are two USB ports, the one with the white frame around the port must be used.
2. Read the information in the pop-up message and then tap on **OK**.
3. Tap on **Apple CarPlay** in the app view.
4. Read the terms and conditions and then tap on **Accept** to connect.
  - > The subview with Apple CarPlay is opened and compatible apps are shown.
5. Tap on the desired app.
  - > The app starts.

## Starting Apple CarPlay

Apple CarPlay is started according to the following, only after an iPhone has been connected.

1. Connect the iPhone to the USB port. In the cases where there are two USB ports, the one with the white frame around the port must be used.
  - > **If the setting for automatic start is selected** - the subview with Apple CarPlay is opened and compatible apps are shown.
2. If the subview with Apple CarPlay is not opened, tap on **Apple CarPlay** in the app view.
  - > The subview with Apple CarPlay is opened and compatible apps are shown.
3. Tap on the desired app.
  - > The app starts.

Apple CarPlay runs in the background if another app is started in the same subview. To show Apple CarPlay in the subview again - tap on the Apple CarPlay icon in the app view.



## ◀ Switch the connection between Apple CarPlay and iPod

### Apple CarPlay to iPod

1. Press **Settings** in top view.
2. Press **Communication → Apple CarPlay**.
3. Untick the box for the Apple device that shall no longer start Apple CarPlay automatically when the USB cable is connected.
4. Disconnect and connect the Apple device to the USB input.
5. Open the app **iPod** from the app view.

### iPod to Apple CarPlay

1. Tap on **Apple CarPlay** in the app view.
2. Read the information in the pop-up message and then tap on **OK**.
3. Disconnect and connect the Apple device to the USB input.
  - > The subview with Apple CarPlay is opened and compatible apps are shown.

### Related information

- Media player (p. 442)
- Media playback (p. 443)
- Connecting media via AUX/USB input (p. 448)
- Settings for Apple CarPlay\* (p. 452)
- Connecting the car (p. 464)

## Settings for Apple CarPlay\*

Settings for phone connected as Apple CarPlay.

### Automatic start

1. Press **Settings** in top view.
2. Press **Communication → Apple CarPlay** and select setting:
  - Tick the box - Apple CarPlay starts automatically when the USB cable is connected.
  - Untick the box - Apple CarPlay does not start automatically when the USB cable is connected.

A maximum of 20 Apple devices can be stored in the list. When the list is full and a new device is connected the oldest one is deleted.

A factory reset is required in order to delete the list, see the section "Resetting settings in the settings view".

### System volumes

1. Press **Settings** in top view.
2. Tap on **Sound → System Volumes** and make the settings for the following:
  - **Voice Control**
  - **Navi Voice Guidance**
  - **Phone Ringtone**

### Related information

- Apple CarPlay\* (p. 450)
- Resetting settings in the settings view (p. 173)

## Android Auto\*

Android Auto gives you the option to listen to music, make phone calls, get directions and use programs from an Android device. Android Auto works with selected Android devices.

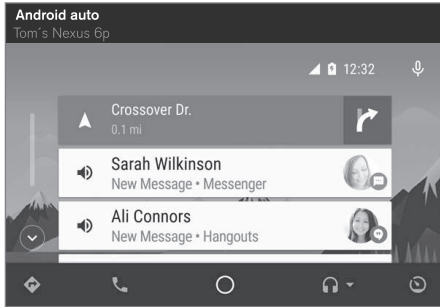

Information about which apps are supported and which phones are compatible is available on the website: [www.android.com/auto/](http://www.android.com/auto/). Please note that Volvo is not responsible for the content in Android Auto.

Android Auto is started from the app view. After Android Auto has been started once, the application will be started automatically the next time the device is connected. Automatic start can be deactivated under settings.

### NOTE

When a phone is connected to Android Auto it is possible to stream via Bluetooth to another media player. Bluetooth is active while Android Auto is being used.

When using map navigation via Android Auto there is no guidance in the driver display or head-up display, but only in the centre display.

The Android Auto apps can be controlled via the centre display, a mobile phone, or with the steering wheel's right-hand keypad (applies to certain functions). It is also possible to control Android Auto using voice control so that you can focus on the road. A long press on the steering wheel button  starts voice recognition control and a short press deactivates.

**By using Android Auto, you acknowledge the following: Android Auto is a service provided by Google Inc. under its terms and conditions. Volvo Cars is not responsible for Android Auto or its features or applications. When you use Android Auto, your car transfers certain information (including its location) to your connected Android phone. You are fully responsible for your and any other person's use of Android Auto.**

## Starting Android Auto

### The first time an Android is connected

1. Connect the Android to the USB port. In the cases where there are two USB ports, the one with the white frame around the port must be used.
2. Read the information in the pop-up message and then tap on **OK**.
3. Tap on **Android Auto** in the app view.
4. Read the terms and conditions and then tap on **Accept** to connect.
  - > The subview with Android Auto is opened and compatible apps are shown.
5. Tap on the desired app.
  - > The app starts.



## ◀◀ **Previously connected Android**

1. Connect the phone to the USB input.
  - > **If the setting for automatic start is selected** - the subview with Android Auto is opened and compatible apps are shown.
2. **If the setting for automatic start is not selected** - open the **Android Auto** app from the app view.
  - > The subview with Android Auto is opened and compatible apps are shown.
3. Tap on the desired app.
  - > The app starts.

Android Auto runs in the background if another app is started in the same subview. To show Android Auto in the subview again - tap on the Android Auto icon in the app view.

### **Related information**

- Media player (p. 442)
- Media playback (p. 443)
- Connecting media via AUX/USB input (p. 448)
- Settings for Android Auto\* (p. 454)
- Connecting the car (p. 464)
- Overview of the centre display (p. 33)

## **Settings for Android Auto\***

Settings for a phone that has been connected the first time with Android Auto.

### **Automatic start**

1. Press **Settings** in top view.
2. Press **Communication** → **Android Auto** and select setting:
  - Tick the box - Android Auto starts automatically when the USB cable is connected.
  - Untick the box - Android Auto does not start automatically when the USB cable is connected.

A maximum of 20 Android devices can be stored in the list. When the list is full and a new device is connected the oldest one is deleted.

A factory reset is required in order to delete the list, see the section "Resetting settings in the settings view".

### **System volumes**

1. Press **Settings** in top view.
2. Tap on **Sound** → **System Volumes** and make the settings for the following:
  - **Voice Control**
  - **Navi Voice Guidance**
  - **Phone Ringtone**

## **Related information**

- Android Auto\* (p. 453)
- Resetting settings in the settings view (p. 173)
- Overview of the centre display (p. 33)

## Technical specifications for media

Compatible file formats, audio specifications and USB.

### Audio files

Format	File extension	Codec
MP3	.mp3	MPEG1 Layer III, MPEG2 Layer III, MP3 Pro (mp3 compatible), MP3 HD (mp3 compatible)
AAC	.m4a, .m4b, .aac	AAC LC (MPEG-4 part III Audio), HE-AAC (aacPlus v1/v2)
WMA	.wma	WMA8/9, WMA9/10 Pro
WAV	.wav	LPCM
FLAC	.flac	FLAC

### Video files

Format	File extension
MP4	.mp4, m4v
MPEG-PS	.mpg, .mp2, .mpeg, .m1v

Format	File extension
AVI	.avi
AVI (DivX)	.avi, divx
ASF	.asf, .wmv
MKV	.mkv

### Subtitles

Format	File extension
SubViewer	.sub
SubRip	.srt
SSA	.ssa

### DivX®

DivX certified devices have been tested for high-quality DivX (.divx, .avi) video playback. When you see the DivX logo, you have the freedom to play DivX films.

Profile	DivX Home Theater
Video codec	DivX, MPEG-4
Resolution	720x576
Bit rate	4.8Mbps
Frame rate	30 fps
File extension	.divx, .avi

Max file size	4 GB
Audio codec	MP3, AC3
Subtitles	XSUB
Special functions	Multiple subtitles, multiple audio, resume play
Reference	Meets all requirements of the DivX Home Theater profile. Visit <a href="http://divx.com">divx.com</a> for more information and software tools to convert your files into DivX Home Theater video.

### Storage on USB device

In order for the system to read the USB device correctly, the following specifications must be followed. No folder structure will be shown in the centre display during playback.

	Max number
Files	15000
Folders	1000
Folder levels	8
Playlists	100
Items in a playlist	1000
Subfolders	No limit



## ◀ Technical specification for USB connector

- Type A socket
- Version 2.0
- Voltage supply 5 V
- Current supply max. 2.1 A

### Related information

- Media player (p. 442)
- Media playback (p. 443)

## Phone

A mobile phone equipped with Bluetooth can be connected wirelessly to the car's built-in hands-free system.

The audio and media system acts as a handsfree, with the facility to remotely control a selection of the mobile phone's functions. The mobile phone can still be operated with its own keys if it is connected to the car.

When a mobile phone has been connected with the car and connected, it can be used make calls, send/receive messages, stream media and provide an Internet connection.



The phone is operated from the centre display, but some operations are also available via voice recognition and the app menu, which are accessed from the right-hand steering wheel keypad.

## Overview

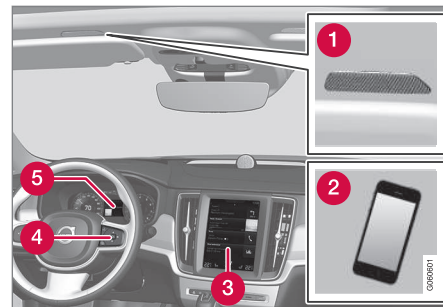

- 1 Microphone.
- 2 Mobile phone.
- 3 Phone operation from centre display.
- 4 Keypad for operating phone functions that are shown in the driver display and voice recognition.
- 5 Driver display.

### Related information

- Connect phone (p. 457)
- Connecting/disconnecting the phone (p. 458)
- Managing phone calls (p. 459)
- Managing text messages (p. 461)
- Settings for phone (p. 462)

- Settings for text messages (p. 463)
- Bluetooth settings (p. 463)
- Voice recognition (p. 115)
- Using the application menu in the driver display (p. 106)
- Media player (p. 442)

## Connect phone

Connect a Bluetooth-activated phone to the car to make calls, send/receive messages, stream media and connect the car to the Internet.

It is possible to have two Bluetooth devices connected at once, in which case one of them can only be streaming media. The most recently connected phone will automatically be connected to make calls, send/receive messages, stream media and provide an Internet connection. To change the use of the phone, see section "Bluetooth settings".

Connection is performed once per device. After connection, the Bluetooth device no longer needs to be visible/searchable but only needs to have Bluetooth activated. To connect the car to the Internet via a phone, tethering must be activated on the phone. A maximum of 20 connected Bluetooth devices can be stored in the car.

There are two options for connecting. Either search the phone from the car or search the car from the phone.

### Option 1 - search phone from car

1. Make the phone searchable/visible via Bluetooth.
2. To connect the car to the Internet via the phone's Bluetooth, activate tethering (portable/personal hotspot) via Bluetooth on the phone.

3. Open the subview for phone.
  - If there is no phone connected to the car, tap on **Add phone**.
  - If there is a phone connected to the car, tap on **Change** . In the pop-up window, tap on **Add phone**.

> Available Bluetooth devices are listed. The list is updated as new devices are detected.
4. Tap on the name of the phone to be connected.
5. Check that the specified number code in the car matches that in the phone. In which case, choose to accept in both places.
6. On the phone, choose to accept or reject any options for phone contacts and messages.

### NOTE

- The message function must be activated in some phones.
- Not all mobile phones are compatible and can show contacts and messages in the car.

## ◀ Option 2 - search car from phone

1. Open the subview for phone.
  - If there is no phone connected to the car, tap on **Add phone → Make car discoverable**.
  - If there is a phone connected to the car, tap on **Change** . In the pop-up window, tap on **Add phone → Make car discoverable**.
2. Activate Bluetooth on the phone.
3. To connect the car to the Internet via the phone's Bluetooth, activate tethering (portable/personal hotspot) via Bluetooth on the phone.
4. Search on the phone for Bluetooth devices.
  - > Available Bluetooth devices are listed.
5. Select the name of the car on the phone.
6. Check that the specified number code in the car matches that in the external device. In which case, choose to accept in both places.
7. On the phone, choose to accept or reject any options for phone contacts and messages.

**i NOTE**

- The message function must be activated in some phones.
- Not all mobile phones are compatible and can show contacts and messages in the car.

**i NOTE**

If the phone's operating system is updated then the connection may be broken. In which case, delete the phone from the car and then connect again.

### Compatible phones

Many phones on the market now have wireless Bluetooth technology, but not all of them are fully compatible with the car. For compatibility, see [support.volvocars.com](http://support.volvocars.com).

### Related information

- Phone (p. 456)
- Connecting/disconnecting the phone (p. 458)
- Bluetooth settings (p. 463)
- Managing phone calls (p. 459)
- Managing text messages (p. 461)
- Online car\* (p. 463)

## Connecting/disconnecting the phone

Connect, change or disconnect a connected phone.

### Connecting the phone automatically

It is only the two last connected phones that can be connected automatically.

1. Activate Bluetooth in the phone before setting the car in ignition position **I**.  
  
To connect the car to the Internet at the same time, tethering (portable/personal hotspot) in the phone must be activated.
2. Set the car in ignition position **I** or higher.
  - > The phone will connect.

### Connect the phone manually

1. Activate Bluetooth on the phone.  
  
To connect the car to the Internet at the same time, tethering (portable/personal hotspot) in the phone must be activated.
2. Open the subview for phone.
  - > Connected phones are listed.
3. Tap on the name of the phone to be connected.
  - > The phone will connect.

### Disconnecting the phone

- Deactivate Bluetooth on the phone.



When the phone is out of range of the car it is automatically disconnected. If disconnection occurs during an active call then the call can be continued on the phone.

### Changing phones

1. Open the subview for phone.
2. Press **Change** .
  - > Available Bluetooth devices are listed.
3. Tap on the phone to be connected.

### Removing a phone

1. Open the subview for phone.
2. Press **Settings** → **Communication** → **Bluetooth Devices**.
  - > A list of connected Bluetooth devices is displayed.
3. Tap on the phone to be removed.
4. Tap on **Remove device** and confirm your selection.
  - > The phone is no longer connected with the car.

### Related information

- Phone (p. 456)
- Connect phone (p. 457)
- Settings for phone (p. 462)
- Bluetooth settings (p. 463)
- Ignition positions (p. 383)

- Online car\* (p. 463)

## Managing phone calls

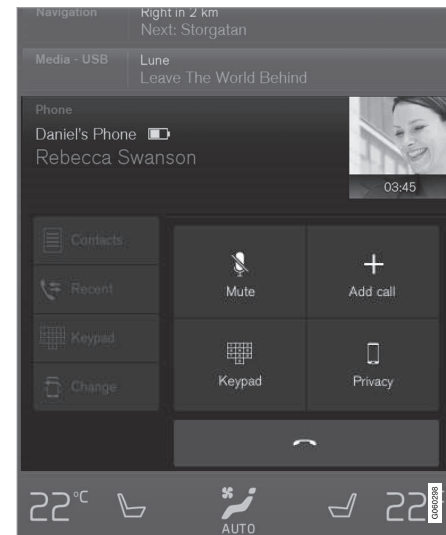

Call handling in the car for a Bluetooth-connected phone.



## Making phone calls

1. Open the subview for phone.



2. Select call from: call history, enter number using the keypad or via the contact list. It is possible to search or browse in the contact list. Tap on  in the contact list in order to add a contact under **Favourites**.
3. Tap on **Call** or .
4. Tap on **End call** to end the call.

You can also make calls from the call log via the app menu, which is accessed from the right-hand steering wheel keypad .

### Making multi-party calls

During a call:

1. Press **Add call**.
2. Choose to make a call from the call log, favourites or the contact list.
3. Tap on an entry/row in the call log, or tap on  alongside the contact in the contact list.
4. Tap on **Swap call** to switch between the parties.
5. Tap on **End call** to end the active call.

### Conference calls

During an active multi-party call:

1. Tap on **Join calls** to merge the active multi-party call.
2. Tap on **End call** to end the call.

### Incoming phone calls

Incoming phone calls are shown in the driver display and the centre display. Manage the call on the right-hand steering wheel keypad or in the centre display.

1. Tap on **Answer/Reject**.
2. Tap on **End call** to end the call.

### Incoming phone call during an active call

1. Tap on **Answer/Reject**.
2. Tap on **End call** to end the call.

### Private call

- During the current call, press **Privacy** and select setting:
  - **Switch to mobile phone** - the hands-free function is disconnected and the call continues on your mobile phone.
  - **Driver focused** - the microphone in the roof on the passenger side is switched off and the call continues with the car's handsfree function.

### Related information

- Phone (p. 456)
- Voice recognition control of the phone (p. 118)
- Using the application menu in the driver display (p. 106)
- Using the keyboard in the centre display (p. 49)

- Settings for phone (p. 462)

## Managing text messages

Message handling in the car for a Bluetooth-connected phone.

On certain phones the message function must be activated. Not all mobiles are fully compatible and capable of displaying contacts and messages in the car. For compatibility, see [support.volvocars.com](http://support.volvocars.com).

## Reading a text message in the centre display

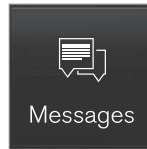
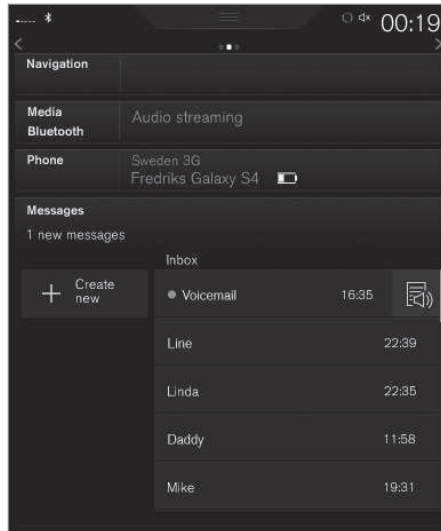

1. In app view, tap on **Messages** to open it.
2. Press **Read out** to have the message read out, or press on the message you would like read.

## Reading a new text message in the driver display

A text message is only shown in the driver display if the option is selected, see section "Settings for text messages".

- To have the message read out - select **Read out** using the steering wheel keypad.

## Send text message



1. In app view, tap on **Messages** to open it.

2.
  - Reply to message — tap on the contact whose message you wish to reply to, then tap on **Answer**.
  - Create a new message — tap on **Create new** → **+**. Select a contact or enter a number.
3. Compose the message.
4. Press **Send**.

## Message notification

For notification settings, see section "Settings for text messages".

## Related information

- Phone (p. 456)
- Settings for text messages (p. 463)
- Settings for phone (p. 462)
- Voice recognition control of the phone (p. 118)
- Using the keyboard in the centre display (p. 49)

## Managing the phone book

Contact handling in the car for a Bluetooth-connected phone.

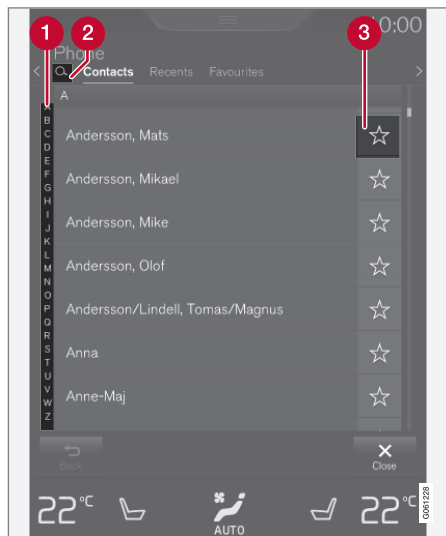

- 1 Browse between the letters and # to find a matching contact. Depending on existing

contacts in the phone book, only matching letters are shown.

- 2 **Search contacts** - tap on to search for a phone number or name in the contact list.
- 3 **Favourites** - tap on to add/remove a contact to/from the favourites list.

### NOTE

Only contacts from an active Bluetooth-connected phone are shown in the centre display. Up to 3000 contacts can be shown.

### Sorting

The contact list is sorted in alphabetical order where special characters and numbers are sorted under #. The sort order can be made by first or last name, see the section "Settings for phone" for more information.

### Related information

- Phone (p. 456)
- Voice recognition control of the phone (p. 118)
- Using the application menu in the driver display (p. 106)
- Using the keyboard in the centre display (p. 49)
- Settings for phone (p. 462)

## Settings for phone

Settings for connected phone.

### Phone

1. Press **Settings** in top view.
2. Press **Communication** → **Phone** and select settings:

- **Ringtones** - select ringtone. It is possible to use a ringtone from the phone or the car. Some phones are not fully compatible and their ringtones may therefore not be available for use in the car. For compatibility, see support.volvocars.com.
- **Sort order for contacts** - select sort order of contact list.

For call notifications in the head-up display\*, see section "Head-up display".

### Related information

- Settings for text messages (p. 463)
- Bluetooth settings (p. 463)
- Phone (p. 456)
- Connect phone (p. 457)
- Head-up display\* (p. 112)

## Settings for text messages

Settings for text messages on connected phone.

### Message

1. Press **Settings** in top view.
2. Press **Communication → Text Messages** and select settings:
  - **Notification in centre display** - shows message notifications in the centre display's status bar.
  - **Notification in driver display** - shows notifications in the driver display. When notifications in the driver display are active, it is possible to manage incoming messages with the steering wheel's right-hand keypad.
  - **Text message tone** - select tone for incoming text message.

### Related information

- Phone (p. 456)
- Connect phone (p. 457)
- Managing text messages (p. 461)
- Settings for phone (p. 462)

## Bluetooth settings

Settings for Bluetooth-connected phone.

### Bluetooth

1. Press **Settings** in top view.
2. Press **Communication → Bluetooth Devices** and select settings:
  - **Previously paired devices** - lists connected devices.
    - Remove device** - removes the connected device.
    - Allowed services for this device** - phone usage options: calling, sending/receiving messages, streaming media and as Internet connection.
  - **Internet connection** - option for connecting the car to the Internet via the device's Bluetooth connection.
  - **Add device** - starts the pairing of a new device.

### Related information

- Online car\* (p. 463)
- Phone (p. 456)
- Connect phone (p. 457)
- Media player (p. 442)

## Online car\*

An online car provides the ability to use e.g. Internet radio and music services via apps as well as contact dealers in the car and download software.

The car is connected via Bluetooth, Wi-Fi or with the car's built-in modem\*.

When the car is connected to the Internet, its Internet connection (Wi-Fi hotspot) can be shared to allow other devices to use the Internet connection<sup>4</sup>.

Connection status is indicated by the symbol in the centre display's status bar.



<sup>4</sup> This does not apply in the case of connection with Wi-Fi.

◀◀ **Related information**

- Connecting the car (p. 464)
- Apps (p. 434)
- Book service and repair (p. 506)
- System updates (p. 510)
- Volvo ID (p. 23)
- Symbols in the centre display's status bar (p. 45)
- Sharing Internet via Wi-Fi hotspot (p. 465)

**Connecting the car**

Connect the car to the phone via Bluetooth, Wi-Fi or with the car's built-in modem\*.

The mobile phone and network operator must support tethering (sharing the Internet connection) and the plan must include data.

**i NOTE**

Data is transferred when using the internet (data traffic), which can have a cost.  
Activation of data roaming can result in further charges.  
Contact your network operator about the cost for data traffic.

**i NOTE**

When using Apple CarPlay, it is only possible to connect the car to the Internet using Wi-Fi or car modem\*.

**i NOTE**

When using Android Auto, it is possible to connect the car to the Internet using Wi-Fi, Bluetooth or car modem\*.

Read **Terms and Conditions for Services** and **Customer Privacy Policy** at [support.volvocars.com](http://support.volvocars.com) before connecting.

**Connecting with Bluetooth**

See Connecting a phone.

**Connecting with Wi-Fi**



1. Activate tethering (portable/personal hotspot) on the mobile phone.
2. Press **Settings** in top view.
3. Press **Communication** → **Wi-Fi**.
4. Activate/deactivate by ticking/unticking the box for Wi-Fi.
5. Tap on the network name of the network to be connected.
6. Enter the network password.
7. If another connection source has been used in the past - confirm the option to change connection.
  - > The car connects to the network.

Note that certain phones switch off tethering after the contact with the car has been disconnected, e.g. when leaving the car and until the next time it is used. The tethering in the phone therefore needs to be reactivated the next time it is used.

When a phone is connected to the car, it is saved for future use. When the maximum number of saved phones (50) is reached, the first connected phones are deleted. To show the list of saved networks or manually delete saved networks, press **Settings → Wi-Fi → Saved networks**.

For network connection requirements, see the section "Technology and security for Wi-Fi".

### Connecting with car modem\*<sup>5</sup>

When the car is connected to the Internet via the car modem, Volvo On Call services will use this connection.

1.

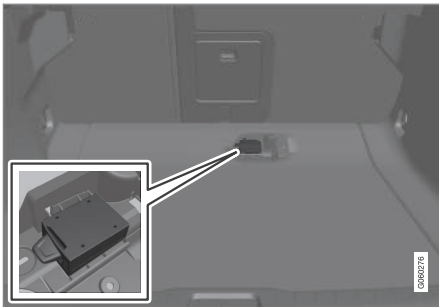

Fit a personal SIM card into the holder under the cargo area floor.

2. Press **Settings** in top view.
3. Press **Communication → Car Modem Internet**.
4. Activate/deactivate by ticking/unticking the box for **Car modem Internet**.
5. If another connection source has been used in the past - confirm the option to change connection.
6. Enter the SIM card's PIN code.  
> The car connects to the network.

### Related information

- Online car\* (p. 463)
- Connect phone (p. 457)
- Symbols in the centre display's status bar (p. 45)
- Remove Wi-Fi network (p. 467)
- Wi-Fi technologies and security (p. 467)
- No or poor connection (p. 466)
- Settings for car modem\* (p. 468)
- Bluetooth settings (p. 463)
- Apple CarPlay\* (p. 450)

### Sharing Internet via Wi-Fi hotspot

When the car is connected to the Internet, its Internet connection can be shared to allow other devices to use the Internet connection.<sup>6</sup>

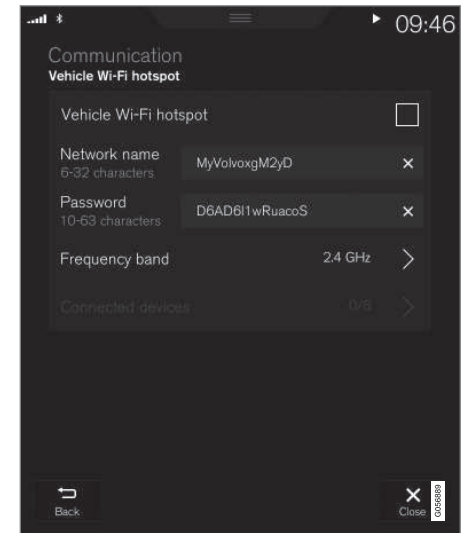

The network operator (SIM card) must support tethering (sharing of the Internet connection).

1. Press **Settings** in top view.

<sup>5</sup> Only cars with Volvo On Call.

2. Press **Communication** → **Car Wi-Fi Hotspot**.
3. Tap on **Network name** and name the shared connection.
4. Tap on **Password** and select a password to be entered on connecting devices.
5. Tap on **Frequency band** and select the frequency on which the hotspot is to transmit data. Note that selection of frequency band is not available in all markets.
6. Activate/deactivate by ticking/unticking the box for **Car Wi-Fi Hotspot**.
7. If Wi-Fi has previously been used as a connection source, confirm the option to change connection.
  - > It is now possible for external devices to connect to the car's tethering (Wi-Fi hotspot).

<b>i NOTE</b>
Activation of Wi-Fi-hotspot can result in further charges from your network operator.
Contact your network operator about the cost for data traffic.

Connection status is indicated by the symbol in the centre display's status bar.

<sup>6</sup> This does not apply in the case of connection with Wi-Fi.

Press **Connected devices** to see a list of the currently connected devices.

### Related information

- Online car\* (p. 463)
- Wi-Fi technologies and security (p. 467)
- Symbols in the centre display's status bar (p. 45)
- No or poor connection (p. 466)

## No or poor connection

### Factors affecting the network.

The amount of data transferred is dependent on the services or apps in use in the car. For example, streaming audio can require large amounts of data which requires a good connection and good signal strength.

### Mobile phone to car

The speed of the connection may vary depending on the location of the mobile phone in the car. Move the mobile phone handset closer to the centre display in order to increase the signal strength. Ensure that there is no source of interference in between.

### Mobile phone to network

The speed of the mobile network varies depending on the coverage in the present location. Poor network coverage may occur, for example in tunnels, in mountainous country, in deep valleys or indoors. The speed also depends on the agreement you have with your network.

<b>i NOTE</b>
In the event of problems with data traffic, contact your network operator.



## Restarting the phone

If there are problems with the connection then it may help to restart the phone.

### Related information

- Online car\* (p. 463)
- Connecting the car (p. 464)

## Remove Wi-Fi network

Removing a network that is not to be used.

1. Press **Settings** in top view.
2. Press **Wi-Fi** → **Saved networks**.
3. Tap on **Forget** alongside the network to be removed.
4. Confirm the selection.
  - > The car will no longer connect to the network in future.

### Remove all networks

All networks can be removed simultaneously by restoring factory settings. Please note that all user data and system settings are reset to original factory settings.

### Related information

- Online car\* (p. 463)
- Connecting the car (p. 464)
- Resetting settings in the settings view (p. 173)

## Wi-Fi technologies and security

Possible network types to connect to.

It is only possible to connect to the following types of network:

- Frequency — 2.4 or 5 GHz<sup>7</sup>.
- Standards — 802.11 a/b/g/n.
- Security type - WPA2-AES-CCMP.

The car's Wi-Fi system is designed to handle Wi-Fi devices inside the car.

If several devices operate on the frequency at the same time then it may result in reduced performance.

### Related information

- Online car\* (p. 463)
- Connecting the car (p. 464)
- Sharing Internet via Wi-Fi hotspot (p. 465)
- No or poor connection (p. 466)

<sup>7</sup> Selection of frequency is not available on all markets.

## Settings for car modem\*<sup>8</sup>

The car is equipped with a modem that can be used to connect the car to the Internet. It is also possible to share the Internet connection via Wi-Fi.

1. Press **Settings** in top view.
2. Press **Communication** → **Car Modem Internet** and select settings:
  - **Car modem Internet** - select whether to use the car modem as Internet connection.
  - **Data usage** - tap on **Reset** resets the counters for received and sent data volume.
  - **Network**

**Select network operator** - automatic or manual selection of network operator.

**Data roaming** - if the box is ticked, the car modem will attempt to connect to the Internet when the car is abroad and outside its home network. Note that this may result in heavy costs. Check your roaming agreement for data traffic abroad with your network provider in your home country.
  - **SIM card PIN**

**Change PIN** - a maximum of 4 digits can be entered.

**Disable PIN** - select whether the PIN code shall be required for access to the SIM card.

<sup>8</sup> Only cars with Volvo On Call.

- **Send request code** — used e.g. to top up or check the balance on a prepaid card. Functionality depends on the provider.

### Related information

- Online car\* (p. 463)
- Sharing Internet via Wi-Fi hotspot (p. 465)

## Downloading, updating and uninstalling apps

When the car is online there is the option to download new apps, keep existing apps updated or uninstall apps.

### NOTE

Data download may affect other services that transmit data, e.g. Internet radio. If the effect on other services is experienced as disruptive then the download can be interrupted. Alternatively, it may be appropriate to switch off or interrupt other services.



The apps are managed via **Download Centre** in application view.

To be able to download, update or uninstall apps, the car must be online.

### Downloading an app

1. Open the app **Download Centre**.
2. Select **New apps** in order to open a list of apps that are available but not installed in the car.

3. Tap anywhere on the row for an app in order to expand in the list and get more information about the app.
4. Select **Install** in order to start the download and installation of the desired app.
  - > The status of the download and installation is shown while it is in progress.

A message is shown if a download cannot be started for the moment. The app will remain in the list and it is possible to try to start a download again.

### Canceling a download

- Tap on **Abort** to cancel a download in progress.

Note that only the download can be cancelled — installation cannot be cancelled once it has begun.

### Updating apps

If an app is being used during an ongoing update, it will be restarted in order for the installation to be completed.

### Update all

1. Open the app **Download Centre**.
2. Select **Install all**.
  - > Updating is started.

### Update some

1. Open the app **Download Centre**.

2. Select **Application updates** in order to open a list of all available updates.
3. Locate the desired app and select **Install**.
  - > Updating is started.

### Uninstalling an app

An app that is being used must be closed in order for the uninstallation to be completed.

1. Open the app **Download Centre**.
2. Select **Application updates** in order to open a list of all installed apps.
3. Locate the desired app and select **Uninstall** in order to start the uninstallation of the app.
  - > When the app has been uninstalled, it disappears from the list.

### Related information

- Online car\* (p. 463)
- Radio (p. 436)
- Media player (p. 442)
- System updates (p. 510)

## License agreement for audio and media

A license is an agreement granting a right to conduct some activity or to make use of another person's right under the terms and conditions of the agreement. The following texts are Volvo's agreements with manufacturers/developers.

### Bowers & Wilkins



Bowers & Wilkins and B&W are trademarks of the B&W Group Ltd. Nautilus is a trademark of B&W Group Ltd. Kevlar is a registered trademark of DuPont.

### Dirac Unison®



Dirac Unison co-optimises the loudspeakers in frequency, time and space for the best possible bass integration and clarity. It enables a faithful reproduction of the acoustic characteristics of specific performance venues. Using advanced algorithms, Dirac Unison controls all loudspeakers digitally based on acoustic high-precision measurements. Like a conductor of an orchestra, it guarantees that the loudspeakers perform in perfect unison.

### DivX®



DivX®, DivX Certified® and associated logotypes are trademarks belonging to DivX, LLC and are used under licence.

This DivX Certified® device can play back DivX® Home Theater video files up to 576p (including .avi, .divx). Download free software on [www.divx.com](http://www.divx.com) to create, play back and stream digital video.

**ABOUT DIVX VIDEO-ON-DEMAND:** This DivX Certified® device must be registered in order to play back purchased DivX Video-on-Demand (VOD) films. Get the registration code by locating the DivX VOD section in the device's settings menu. Go to [vod.divx.com](http://vod.divx.com) for more information on how to complete the registration.

### Patent numbers

Protected by one or more of the following US patents. 7,295,673; 7,460,668; 7,515,710; 8,656,183; 8,731,369; RE45,052.

### Gracenote®



Parts of the content are copyright © of Gracenote or its suppliers.

Gracenote, Gracenote logo and logotype, "Powered by Gracenote" and Gracenote MusicID are either registered trademarks or trademarks of Gracenote, Inc. in the USA and/or other countries.

### **Gracenote® End User License Agreement**

This program or device contains software from Gracenote, Inc. of Emeryville, California, USA ("Gracenote"). The software from Gracenote ("Gracenote software") activates this program to perform disc and/or file identification and obtain music-related information, including name, artist, track and title ("Gracenote data") from online servers or embedded databases (together called "Gracenote servers") and in order to perform other actions. You may only use Gracenote data in accordance with the intended end-user functions for this program or this device.

You agree to only use Gracenote data, Gracenote software and Gracenote servers for your own personal non-commercial use. You agree not to assign, copy, transfer or transmit this Gracenote software or any Gracenote data to any third party. YOU AGREE NOT TO USE OR EXPLOIT GRACENOTE DATA, GRACENOTE SOFTWARE OR GRACENOTE SERVERS, EXCEPT AS EXPRESSLY PERMITTED IN THIS AGREEMENT.

You agree that your non-exclusive right to use Gracenote data, Gracenote software and Grace-

note servers will be terminated if you violate these restrictions. If your license is terminated you agree to cease all use of Gracenote data, Gracenote software and Gracenote servers. Gracenote holds exclusive rights to all Gracenote data, all Gracenote software and all Gracenote servers, including all ownership rights. Gracenote will under no circumstances have any obligation to pay you for any information you provide. You agree that Gracenote, Inc. may enforce the company's rights under this agreement against you directly in its own name.

The Gracenote service uses a unique identifier to track enquiries for statistical purposes. The purpose of a randomly assigned numeric identifier is to enable the Gracenote service to count enquiries without knowing anything about who you are. Additional information is available on the web page for Gracenote's privacy policy for the Gracenote service.

The Gracenote software and everything included in Gracenote data are licensed to you "as is". Gracenote provides no undertakings or warranties, express or implied, as to the accuracy of the Gracenote data contained in the Gracenote servers. Gracenote reserves the right to delete data from the Gracenote servers or to change data categories for any reason that Gracenote deems sufficient. No warranty is provided that the Gracenote software or Gracenote servers are fault-free or that the Gracenote software or Gracenote servers will operate without interruption. Grace-

note has no obligation to provide you with new, improved or additional data types or categories that Gracenote may provide in the future, and the company reserves the right to discontinue its services at any time.

GRACENOTE DISCLAIMS ALL WARRANTIES, EITHER EXPRESS OR IMPLIED, INCLUDING, BUT NOT LIMITED TO, THE IMPLIED WARRANTIES OF MERCHANTABILITY, FITNESS FOR A PARTICULAR PURPOSE, TITLE AND NON-INFRINGEMENT OF INTELLECTUAL PROPERTY RIGHTS. GRACENOTE DOES NOT GUARANTEE THE RESULTS OBTAINED THROUGH YOUR USE OF THE GRACENOTE SOFTWARE OR A GRACENOTE SERVER. GRACENOTE WILL IN NO EVENT BE LIABLE FOR ANY CONSEQUENTIAL DAMAGE OR FOR ANY LOST PROFITS OR REVENUES.

© Gracenote, Inc. 2009

### **Sensus software**

This software uses parts of sources from clib2 and Prex Embedded Real-time OS - Source (Copyright (c) 1982, 1986, 1991, 1993, 1994), and Quercus Robusta (Copyright (c) 1990, 1993), The Regents of the University of California. All or some portions are derived from material licensed to the University of California by American Telephone and Telegraph Co. or Unix System Laboratories, Inc. and are reproduced herein with the permission of UNIX System Laboratories, Inc. Redistribution and use in



◀ source and binary forms, with or without modification, are permitted provided that the following conditions are met: Redistributions of source code must retain the above copyright notice, this list of conditions and the following disclaimer. Redistributions in binary form must reproduce the above copyright notice, this list of conditions and the following disclaimer in the documentation and/or other materials provided with the distribution. Neither the name of the <ORGANIZATION> nor the names of its contributors may be used to endorse or promote products derived from this software without specific prior written permission. THIS SOFTWARE IS PROVIDED BY THE COPYRIGHT HOLDERS AND CONTRIBUTORS "AS IS" AND ANY EXPRESS OR IMPLIED WARRANTIES, INCLUDING, BUT NOT LIMITED TO, THE IMPLIED WARRANTIES OF MERCHANTABILITY AND FITNESS FOR A PARTICULAR PURPOSE ARE DISCLAIMED. IN NO EVENT SHALL THE COPYRIGHT OWNER OR CONTRIBUTORS BE LIABLE FOR ANY DIRECT, INDIRECT, INCIDENTAL, SPECIAL, EXEMPLARY, OR CONSEQUENTIAL DAMAGES (INCLUDING, BUT NOT LIMITED TO, PROCUREMENT OF SUBSTITUTE GOODS OR SERVICES; LOSS OF USE, DATA, OR PROFITS; OR BUSINESS INTERRUPTION) HOWEVER CAUSED AND ON ANY THEORY OF LIABILITY, WHETHER IN CONTRACT, STRICT LIABILITY, OR TORT (INCLUDING NEGLIGENCE OR OTHERWISE) ARISING IN ANY WAY OUT OF THE USE OF

THIS SOFTWARE, EVEN IF ADVISED OF THE POSSIBILITY OF SUCH DAMAGE.

This software is based in part on the work of the Independent JPEG Group.

This software uses parts of sources from "libtess". The Original Code is: OpenGL Sample Implementation, Version 1.2.1, released January 26, 2000, developed by Silicon Graphics, Inc. The Original Code is Copyright (c) 1991-2000 Silicon Graphics, Inc. Copyright in any portions created by third parties is as indicated elsewhere herein. All Rights Reserved. Copyright (C) [1991-2000] Silicon Graphics, Inc. All Rights Reserved. Permission is hereby granted, free of charge, to any person obtaining a copy of this software and associated documentation files (the "Software"), to deal in the Software without restriction, including without limitation the rights to use, copy, modify, merge, publish, distribute, sublicense, and/or sell copies of the Software, and to permit persons to whom the Software is furnished to do so, subject to the following conditions: The above copyright notice including the dates of first publication and either this permission notice or a reference to <http://oss.sgi.com/projects/FreeB/> shall be included in all copies or substantial portions of the Software. THE SOFTWARE IS PROVIDED "AS IS", WITHOUT WARRANTY OF ANY KIND, EXPRESS OR IMPLIED, INCLUDING BUT NOT LIMITED TO THE WARRANTIES OF MERCHANTABILITY, FITNESS FOR A

PARTICULAR PURPOSE AND NONINFRINGEMENT. IN NO EVENT SHALL SILICON GRAPHICS, INC. BE LIABLE FOR ANY CLAIM, DAMAGES OR OTHER LIABILITY, WHETHER IN AN ACTION OF CONTRACT, TORT OR OTHERWISE, ARISING FROM, OUT OF OR IN CONNECTION WITH THE SOFTWARE OR THE USE OR OTHER DEALINGS IN THE SOFTWARE. Except as contained in this notice, the name of Silicon Graphics, Inc. shall not be used in advertising or otherwise to promote the sale, use or other dealings in this Software without prior written authorization from Silicon Graphics, Inc.

This software is based in parts on the work of the FreeType Team.

This software uses parts of SSLeay Library: Copyright (C) 1995-1998 Eric Young (eay@cryptsoft.com). All rights reserved

### Linux software

This product contains software licensed under GNU General Public License (GPL) or GNU Lesser General Public License (LGPL), etc.

You have the right of acquisition, modification, and distribution of the source code of the GPL/LGPL software.

You may download Source Code from the following website at no charge: [http://www.embedded-carmultimedia.jp/linux/oss/download/TVM\\_8351\\_013](http://www.embedded-carmultimedia.jp/linux/oss/download/TVM_8351_013)

The website provides the Source Code "As Is" and without warranty of any kind.

By downloading Source Code, you expressly assume all risk and liability associated with downloading and using the Source Code and complying with the user agreements that accompany each Source Code.

Please note that we cannot respond to any inquiries regarding the source code.

### **camellia:1.2.0**

Copyright (c) 2006, 2007

NTT (Nippon Telegraph and Telephone Corporation). All rights reserved.

Redistribution and use in source and binary forms, with or without modification, are permitted provided that the following conditions are met:

1. Redistributions of source code must retain the above copyright notice, this list of conditions and the following disclaimer as the first lines of this file unmodified.
2. Redistributions in binary form must reproduce the above copyright notice, this list of conditions and the following disclaimer in the documentation and/or other materials provided with the distribution.

THIS SOFTWARE IS PROVIDED BY NTT "AS IS" AND ANY EXPRESS OR IMPLIED WARRANTIES, INCLUDING, BUT NOT LIMITED TO, THE IMPLIED WARRANTIES OF MERCHANTABILITY AND FITNESS FOR A

PARTICULAR PURPOSE ARE DISCLAIMED. IN NO EVENT SHALL NTT BE LIABLE FOR ANY DIRECT, INDIRECT, INCIDENTAL, SPECIAL, EXEMPLARY, OR CONSEQUENTIAL DAMAGES (INCLUDING, BUT NOT LIMITED TO, PROCUREMENT OF SUBSTITUTE GOODS OR SERVICES; LOSS OF USE, DATA, OR PROFITS; OR BUSINESS INTERRUPTION) HOWEVER CAUSED AND ON ANY THEORY OF LIABILITY, WHETHER IN CONTRACT, STRICT LIABILITY, OR TORT (INCLUDING NEGLIGENCE OR OTHERWISE) ARISING IN ANY WAY OUT OF THE USE OF THIS SOFTWARE, EVEN IF ADVISED OF THE POSSIBILITY OF SUCH DAMAGE.

### **Unicode: 5.1.0**

COPYRIGHT AND PERMISSION NOTICE

Copyright c 1991-2013 Unicode, Inc. All rights reserved. Distributed under the Terms of Use in <http://www.unicode.org/copyright.html>.

Permission is hereby granted, free of charge, to any person obtaining a copy of the Unicode data files and any associated documentation (the "Data Files") or Unicode software and any associated documentation (the "Software") to deal in the Data Files or Software without restriction, including without limitation the rights to use, copy, modify, merge, publish, distribute, and/or sell copies of the Data Files or Software, and to permit persons to whom the Data Files or Software are furnished to do so, provided that (a)

the above copyright notice(s) and this permission notice appear with all copies of the Data Files or Software, (b) both the above copyright notice(s) and this permission notice appear in associated documentation, and (c) there is clear notice in each modified Data File or in the Software as well as in the documentation associated with the Data File(s) or Software that the data or software has been modified.

THE DATA FILES AND SOFTWARE ARE PROVIDED "AS IS", WITHOUT WARRANTY OF ANY KIND, EXPRESS OR IMPLIED, INCLUDING BUT NOT LIMITED TO THE WARRANTIES OF MERCHANTABILITY, FITNESS FOR A PARTICULAR PURPOSE AND NONINFRINGEMENT OF THIRD PARTY RIGHTS. IN NO EVENT SHALL THE COPYRIGHT HOLDER OR HOLDERS INCLUDED IN THIS NOTICE BE LIABLE FOR ANY CLAIM, OR ANY SPECIAL INDIRECT OR CONSEQUENTIAL DAMAGES, OR ANY DAMAGES WHATSOEVER RESULTING FROM LOSS OF USE, DATA OR PROFITS, WHETHER IN AN ACTION OF CONTRACT, NEGLIGENCE OR OTHER TORTIOUS ACTION, ARISING OUT OF OR IN CONNECTION WITH THE USE OR PERFORMANCE OF THE DATA FILES OR SOFTWARE.

Except as contained in this notice, the name of a copyright holder shall not be used in advertising or otherwise to promote the sale, use or other



◀◀ dealings in these Data Files or Software without prior written authorization of the copyright holder.

### Declaration of Conformity for Bluetooth® module

**Declaration of Conformity**  
Mitsubishi Electric Corporation Sanda Works  
2-3-33, Miwa, Sanda-city, Hyogo, 669-1513 Japan

We declare, at our sole responsibility, that the following product conforms to the Essential Requirements of the Radio and Telecommunications Terminal Equipment Directive 1999/5/EC in accordance with the tests conducted to the appropriate requirements of the relevant standards, as listed herewith.

Product: Audio Navigation Unit  
Model/Type Number: NR-0V

Directive and Standards used : Radio: EN 300 328 V1.8.1 :2012-6  
EMC: EN 301 488-1 V1.9.2 :2011-09  
EN 301 488-17 V2.2.1 :2012-09  
Safety: IEC 60959-1:2005 (Second Edition) + Am 1:2009 and/or  
EN 60950-1 : 2006+A1:2010+A11:2009+A12:2011  
Health: EN 62479: 2011-09

The authorized signatory to this declaration :

Date: 13th May 2014

Signature: 

Name: **Takashi Kyomoto**  
Title: Manager,  
Mitsubishi Electric Corporation Sanda Works  
Address: 2-3-33, Miwa, Sanda-city, Hyogo, 669-1513, Japan

The responsible person based within the EC :

Date: 2014-05-14

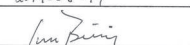
Signature: 

Name: **Jan Erik**  
Title: General Manager,  
Mitsubishi Electric Automotive Europe,B.V.  
Swedish Branch, Technical Center  
Address: Ostra Eriksbergsgatan 38, SE41878 Gothenburg, Sweden



Country/ Area	
EU:	<div data-bbox="220 208 368 353" style="border: 1px solid black; padding: 5px; text-align: center;"><b>CE 0560</b></div> <p data-bbox="220 374 440 396">Exporting country: Japan</p> <p data-bbox="220 409 620 432">Manufacturer: Mitsubishi Electric Corporation</p> <p data-bbox="220 445 592 468">Type of equipment: Audio Navigation Unit</p> <p data-bbox="220 481 1449 530">Hereby, Mitsubishi Electric Corporation declares that this Audio Navigation Unit is in compliance with the essential requirements and other relevant provisions of Directive 1999/5/EG.</p>



Country/ Area	
China:	<p>1.</p> <ul style="list-style-type: none"> <li>■ 使用频率：2.4 - 2.4835 GHz</li> <li>■ 等效全向辐射功率(EIRP)： 天线增益 &lt; 10dBi 时： ≤100 mW 或 ≤20 dBm ①</li> <li>■ 最大功率谱密度： 天线增益 &lt; 10dBi 时： ≤20 dBm / MHz(EIRP) ①</li> <li>■ 载频容限： 20 ppm</li> <li>■ 带外发射功率(在 2.4-2.4835GHz 频段以外) ≤-80 dBm / Hz (EIRP)</li> <li>■ 杂散发射(辐射)功率(对应载波±2.5 倍信道带宽以外)：           <ul style="list-style-type: none"> <li>● ≤-36 dBm / 100 kHz (30 - 1000 MHz)</li> <li>● ≤-33 dBm / 100 kHz (2.4 - 2.4835 GHz)</li> <li>● ≤-40 dBm / 1 MHz (3.4 - 3.53 GHz)</li> <li>● ≤-40 dBm / 1 MHz (5.725 - 5.85 GHz)</li> <li>● ≤-30 dBm / 1 MHz (其它 1 - 12.75 GHz)</li> </ul> </li> </ul> <p>2. 不得擅自更改发射频率、加大发射功率(包括额外加装射频功率放大器)，不得擅自外接天线或改用其它发射天线；</p> <p>3. 使用时不得对各种合法的无线电电信业务产生有害干扰；一旦发现有害干扰现象时，应立即停止使用，并采取措施消除干扰后方可继续使用；</p> <p>4. 使用微功率无线电设备，必须忍受各种无线电业务的干扰或工业、科学及医疗应用设备的辐射干扰；</p> <p>5. 不得在飞机和机场附近使用。</p>

Country/ Area	
Korea:	<p>B 급 기기 (가정용 방송통신기자재)</p> <p>이 기기는 가정용(B 급) 전자파적합기기로서 주로 가정에서 사용하는 것을 목적으로 하며, 모든 지역에서 사용할 수 있습니다.</p> <p>해당 무선설비는 전파혼신 가능성이 있으므로 인명안전과 관련된 서비스는 할 수 없습니다.</p>
Taiwan:	<p>低功率電波輻射性電機管理辦法</p> <p>第十二條</p> <p>經型式認證合格之低功率射頻電機，非經許可，公司、商號或使用者均不得擅自變更頻率、加大功率或變更原設計之特性及功能。</p> <p>第十四條</p> <p>低功率射頻電機之使用不得影響飛航安全及干擾合法通信；經發現有干擾現象時，應立時停用，改善至無干擾時方得繼續使用。前項合法通信，指依電信法規定作業之無線電通信。低功率射頻電機須忍受合法通信或工業、科學及醫療用電波輻射性電機設備之干擾。</p>

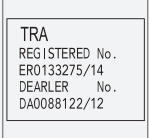

Country/ Area	
Brazil:	<div data-bbox="220 208 368 353" data-label="Image"> </div> <p data-bbox="220 374 1437 423">Este equipamento opera em caráter secundário isto e, não tem direito a proteção contra interferência prejudicial, mesmo tipo, e não pode causar interferência a sistemas operando em caráter primário.</p> <p data-bbox="220 437 576 460">Para consultas, visite: <a href="http://www.anatel.gov.br">www.anatel.gov.br</a></p>
Kazakhstan:	<div data-bbox="220 479 368 624" data-label="Image"> </div> <p data-bbox="220 645 400 667">Model name: NR 0V</p> <p data-bbox="220 682 624 704">Manufacturer: Mitsubishi Electric Corporation</p> <p data-bbox="220 719 440 741">Exporting country: Japan</p>

Country/ Area	
Mexico:	
The United Arab Emirates:	

### Related information

- Audio and media (p. 434)
- Media player (p. 442)
- Online car\* (p. 463)
- Gracenote® (p. 445)
- Sensus - connection and maintenance (p. 29)

## **Terms and conditions for services and Customer Privacy Policy**

Read the terms and conditions for services and the Customer Privacy Policy at [support.volvocars.com](http://support.volvocars.com).

### **Terms & Conditions for Services**

Volvo is committed to offering you the absolute best services to ensure that it is as safe, comfortable and pleasant as possible for you to drive your Volvo. Volvo offers a wide range of services, from assistance in emergency situations to navigation in various infotainment services.

Read these terms and conditions ("Service Terms and Conditions") carefully before using the services - [support.volvocars.com](http://support.volvocars.com).

### **Customer Privacy Policy**

This policy applies for the processing of customer data and personal data. The purpose of the policy is to provide our existing, previous and prospective customers with a general understanding of:

- The circumstances in which we gather and process your personal data.
- The types of personal data we gather.
- The reasons we gather your personal data.
- How we handle your personal data.

This policy can be read in its entirety at [support.volvocars.com](http://support.volvocars.com).

### **Related information**

- License agreement for audio and media (p. 470)
- License agreement for the driver display (p. 100)
- Type approval for radar units (p. 321)

# WHEELS AND TYRES

## Tyres

Amongst other things, the function of the tyres is to carry load, provide grip on the road surface, dampen vibration and protect the wheel from wear.

The tyres greatly affect the car's driving characteristics. The type of tyre, dimensions, tyre pressure and speed rating are important for how the car performs.

### Recommended tyres

On delivery, the car is equipped with Volvo original tyres that have the VOL<sup>1</sup> marking on the side of the tyres. These tyres are carefully adapted to the car. In the event of changing tyres, it is therefore important that the new tyres also have this marking in order for the car's driving characteristics, comfort and fuel consumption to be maintained.

### New tyres

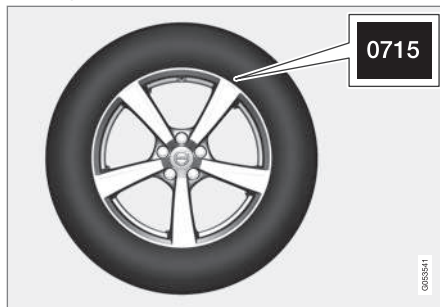

Tyres are perishable. After a few years they begin to harden at the same time as the friction capacity/characteristics gradually deteriorate. For this reason, aim to get as fresh tyres as possible when you replace them. This is especially important with regard to winter tyres. The last four digits in the sequence mean the week and year of manufacture. This is the tyre's DOT marking (Department of Transportation), and this is stated with four digits, for example 0715. The tyre in the figure was manufactured in week 07 of 2015.

### Tyre age

All tyres older than 6 years old should be checked by an expert even if they seem undamaged. Tyres age and decompose, even if they are hardly ever or never used. The function can therefore be affected. This applies to all tyres that

are stored for future use. Examples of external signs which indicate that the tyre is unsuitable for use are cracks or discoloration.

### Wear and maintenance

Correct tyre pressure results in more even wear. Driving style, tyre pressure, climate and road condition affect how quickly the tyres age and wear.

To avoid differences in tread depth and to prevent wear patterns forming on the tyres, the front and rear wheels can be switched with each other. A suitable distance for the first change is approx. 5000 km and then at 10000 km intervals.

Volvo recommends the an authorised Volvo workshop is contacted for checking if you are uncertain about tread depth. If significant differences in wear (> 1 mm difference in tread depth) between tyres have already occurred, then the least worn tyres must always be fitted on the rear. Understeer is normally easier to correct than oversteer, and leads to the car continuing forwards in a straight line rather than having the rear end skidding to one side, resulting in possible complete loss of control over the car. This is why it is important for the rear wheels never to lose grip before the front wheels.

### WARNING

A damaged tyre may lead to loss of control over the car.

<sup>1</sup> There may be deviations for certain tyre dimensions.



## Storage

Wheels with tyres fitted must be stored lying down or hanging up - never standing up.

## Related information

- Checking the tyre pressures (p. 484)
- Tyres' rotation direction (p. 483)
- Tread wear indicators on the tyres (p. 484)
- Tyre monitoring\* (p. 485)
- Emergency puncture repair kit (p. 490)
- Dimension designation for tyre (p. 502)

## Tyres' rotation direction

Tyres with a tread pattern which are designed to only turn in one direction have the direction of rotation marked with an arrow.

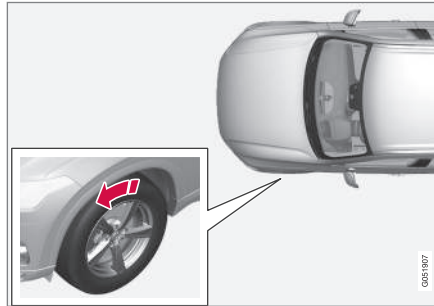

The arrow shows the tyre's direction of rotation.

The tyre must always rotate in the same direction throughout its lifespan. Tyres should only be switched between front and rear positions, never between left and right-hand sides, or vice versa. If the tyres are fitted incorrectly, the car's braking characteristics and capacity to force rain and slush out of the way are adversely affected. Tyres with the greatest tread depth should always be fitted to the rear of the car (to decrease the risk of skidding).

## **i** NOTE

Make sure that both pairs of wheels have the same type and dimension, and also the same make.

## Related information

- Tyres (p. 482)

## Tread wear indicators on the tyres

Tread wear indicators show the status of the tyre's tread depth.

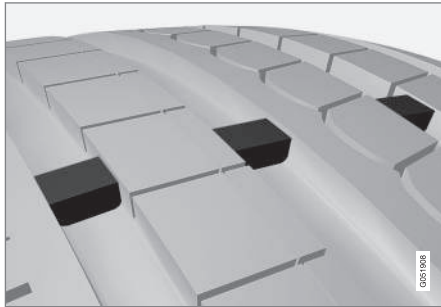

A tread wear indicator is a narrow elevation across the longitudinal grooves of the tyre's tread pattern. On the side of the tyre are the letters TWI (Tread Wear Indicator). When the tyre's tread depth is down to 1.6 mm, the tread will be level in height with the tread wear indicators. Change to new tyres as soon as possible. Remember that tyres with little tread depth provide very poor grip in rain and snow.

### Related information

- Tyres (p. 482)

## Checking the tyre pressures

Tyres with the correct air pressure increase driving safety, save fuel and extend the service life of the tyres.

Tyre pressure decreases over time, this is a natural phenomenon. Tyre pressure also varies depending on ambient temperature. Inadequate tyre pressure increases fuel consumption, shortens tyre lifespan and impairs the car's driving characteristics. Driving on tyres with tyre pressure that is too low could result in the tyres overheating and being damaged. Tyre pressure affects travelling comfort, road noise and driving characteristics.

### Recommended tyre pressure



The tyre pressure label on the driver's side door pillar (between frame and rear door) shows which

pressures the tyres should have at different loads and speed conditions.

### Improved fuel economy with ECO pressure

For a light load (max. 3 people) and a speed of up to 160 km/h (100 mph), the ECO pressures can be chosen for optimum fuel economy. However, the lower comfort pressures are recommended instead if optimum noise and travelling comfort are desired.

### Checking the air pressure

1. Check the tyre pressures monthly. Carry out the check on cold tyres, which means that the tyres should have the same temperature as the outside temperature. After several few kilometres of driving, the tyres warm up and the pressure increases.
2. If necessary, inflate so that the air pressure corresponds with the approved tyre pressure in accordance with the tyre pressure label.

### **i** NOTE

- After a tyre has been inflated, always refit the dust cap in order to avoid damage to the valve from gravel, dirt, etc.
- Only use plastic dust caps. Metal dust caps can rust and become difficult to unscrew.

**Related information**

- Tyres (p. 482)
- Checking tyre pressure with the tyre monitoring system\* (p. 487)
- Inflate tyres with the compressor from the emergency puncture repair kit (p. 494)
- Approved tyre pressures (p. 578)

**Tyre monitoring\***

The tyre monitoring system, Indirect Tyre Pressure Monitoring System (ITPMS), gives a warning with an indicator symbol in the driver display when the pressure in one or more of the car's tyres is too low.

If the symbol first flashes for approximately one minute and then changes to a constant glow, it may indicate that the system cannot detect or warn of low tyre pressure as intended.

When the tyre pressure is too low, the indicator symbol for low tyre pressure is illuminated in the display and a message is shown, see also the heading "Message in the driver display" below.

Symbol	Specification
	<ul style="list-style-type: none"> <li>• The symbol illuminates in the event of low tyre pressure.</li> <li>• The symbol flashes for approximately one minute and then changes over to illuminating with a constant glow in the event of a fault in the ITPMS system.</li> </ul>

**System description**

ITPMS measures differences in rotation speed between the different wheels via the ABS system in order to be able to determine whether they have the correct tyre pressure. If the tyre pressure is too low, the tyre's diameter is changed and, as a result, so is its rotation speed. By comparing the tyres with each other the system can determine whether one or more tyres have pressure that is too low.



### ◀ **General information on the tyre monitoring system**

In the information below, the tyre monitoring system is referred to generically as TPMS.

Each tyre, including the spare tyre\*, should be checked once a month. When checking, the tyre should be cold and have the air pressure recommended by the car manufacturer specified on the tyre pressure label or in the tyre pressure table. If the car has tyres of a different size than that recommended by the manufacturer, find out what the correct air pressure level is for these.

As an extra safety feature, the car is equipped with a tyre pressure monitoring system (TPMS), which shows when the air pressure in one or more tyres is too low. When the indicator symbol for low air pressure is lit, stop and check the tyres as soon as possible and inflate to the correct air pressure.

Driving with tyres that have tyre pressure that is too low may cause the tyre to overheat, which can cause a puncture. Low tyre pressure also reduces fuel efficiency as well as tyre service life, and can affect car handling and stopping ability. Note that TPMS does not replace regular tyre maintenance. It is the driver's responsibility to maintain correct tyre pressure, even if the limit for low tyre pressure has not been reached so that the indicator symbol illuminates.

The car is also equipped with a TPMS system fault indicator, which indicates when the system

is not functioning correctly. The TPMS system fault indicator is combined with the indicator symbol for low tyre pressure. When the system detects a fault, the symbol in the driver display will flash for about one minute and then remain illuminated. This procedure will be repeated when the car is started until the fault has been rectified. When the symbol is illuminated, the system's ability to detect or warn of low tyre pressure may be affected.

A TPMS system fault can occur for several reasons, such as after changing to a spare tyre, or changing tyres or wheels that prevent TPMS from functioning correctly.

Always check the indicator symbol for TPMS after changing one or more tyres in order to ensure the new tyre or wheel is working correctly with TPMS.

### **Messages in the driver display**

The following messages may be shown when the indicator symbol is illuminated:

- **Tyre pressure low Check tyres, calibrate after fill**
- **Tyre pressure system Temporarily unavailable**
- **Tyre pressure system Service required.**

If the system cannot determine which tyre has low pressure, all four tyres will be indicated in the centre display.

### **To bear in mind**

- Always calibrate the system after a wheel change or tyre pressure adjustment. See the tyre pressure label on the driver's side door pillar for Volvo's recommended tyre pressures.
- The system does not replace normal tyre maintenance.
- There is no option to deactivate ITPMS.

### **Related information**

- Tyres (p. 482)
- Checking tyre pressure with the tyre monitoring system\* (p. 487)
- Calibrating tyre monitoring\* (p. 489)
- Rectifying low tyre pressure with tyre monitoring\* (p. 488)

## Checking tyre pressure with the tyre monitoring system\*

With the system for tyre monitoring, Indirect Tyre Pressure Monitoring System (ITPMS), tyre pressure status can be viewed in the centre display.

### Checking status

1. Open the **Car status** app in the app view.



2. Tap on **Status** to show the status of the tyres.

### Status indication

The graphics show the status for each tyre.

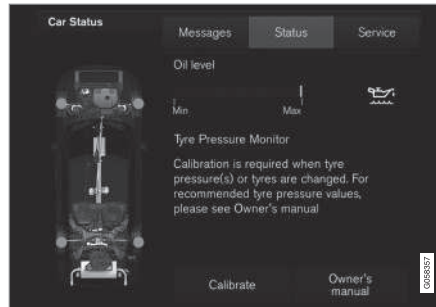

Status view<sup>2</sup>.

### Green tyre:

- The tyre pressure is above the limit value for a warning.

### Yellow tyre:

- The tyre's pressure is too low. Stop and check/rectify the tyre pressure as soon as possible. Calibrate ITPMS after the tyre pressure has been adjusted.

### All tyres yellow:

- The pressure is too low in two or more tyres. Stop and check/rectify the tyre pressures as soon as possible. Calibrate ITPMS after the tyre pressures have been adjusted.

### All tyres grey:

- Calibration in progress.
- Unknown status.

Several minutes driving above 30 km/h (20 mph) may be required for the system to become active.

### All tyres grey and a message:

- **Tyre pressure system Temporarily unavailable.** The indicator symbol flashes and changes to constant glow after approx. 1 minute. The system is currently unavailable, activated shortly.
- **Tyre pressure system Service required.** The indicator symbol flashes and changes to constant glow after approx. 1 minute. The system is not working correctly, contact an authorised Volvo workshop (recommended).

### Related information

- Tyre monitoring\* (p. 485)
- Calibrating tyre monitoring\* (p. 489)
- Rectifying low tyre pressure with tyre monitoring\* (p. 488)
- Car status (p. 506)

<sup>2</sup> The figure is schematic. Layout may vary depending on car model or updated software.

## Rectifying low tyre pressure with tyre monitoring\*

When the tyre monitoring system, Indirect Tyre Pressure Monitoring System (ITPMS), gives a warning, the tyre pressure in one or more of the car's tyres is too low.



Check and rectify the tyre pressure when the indicator symbol for ITPMS is illuminated and the message **Tyre pressure low** is shown. Calibrate ITPMS after the tyre pressure has been adjusted.

1. Check the tyre pressure in all four tyres with a tyre pressure gauge.
2. Inflate the tyres to the correct pressure as indicated on the tyre pressure label on the door pillar on the driver's side.



3. Recalibrate the ITPMS system, see the section "Calibrating tyre monitoring".
4. In some cases, it may be necessary to drive the car for a few minutes at a speed above 30 km/h (20 mph) in order to extinguish the ITPMS symbol and clear the message.

Note that the ITPMS symbol does not extinguish until the low tyre pressure has been rectified and new calibration has been performed.

### **i** NOTE

To avoid incorrect tyre pressure, the pressure should be checked on cold tyres. "Cold tyres" means the tyres are the same temperature as the ambient temperature (approx. 3 hours after the car has been driven). After a few kilometres of driving, the tyres warm up and the pressure increases.

### **i** NOTE

- After a tyre has been inflated, always refit the dust cap in order to avoid damage to the valve from gravel, dirt, etc.
- Only use plastic dust caps. Metal dust caps can rust and become difficult to unscrew.

### **⚠** WARNING

- Incorrect tyre pressure may lead to tyre failure, which could result in the driver losing control of the car.
- The system cannot indicate sudden tyre damage in advance.

### Related information

- Tyre monitoring\* (p. 485)
- Checking tyre pressure with the tyre monitoring system\* (p. 487)
- Calibrating tyre monitoring\* (p. 489)
- Approved tyre pressures (p. 578)
- Inflate tyres with the compressor from the emergency puncture repair kit (p. 494)

## Calibrating tyre monitoring\*

In order for the Indirect Tyre Pressure Monitoring System (ITPMS) to work correctly, a reference value for the tyre pressure must be determined. This must be performed each time the tyres are changed or the tyre pressure is changed.

For example, when driving with a heavy load or at high speed above 160 km/h (100 mph), the tyre pressure should be adjusted in accordance with Volvo's recommended tyre pressure values. Following which, the system must be recalibrated.

1. Stop the engine.
2. Inflate the tyres to the desired pressure in accordance with the tyre pressure label on the door pillar on the driver's side.



3. Start the engine.

4. Open the **Car status** app in the app view.

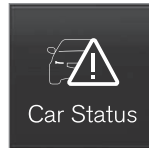

5. Tap on **Status** to view tyre monitoring.

<b>i</b> <b>NOTE</b>
The car must be stationary when calibration is started.

6. Press **Calibrate**.
7. Tap on **OK** to confirm that the tyre pressure in all four tyres has been checked and adjusted.

8. Drive the car.

Calibration is performed while the car is driving. Calibration is interrupted temporarily if the engine is switched off, but is resumed automatically when the car is driven again.

- > When sufficient data has been collected to enable the system to detect low tyre pressure, the tyres in the centre display change colour from grey to green. The system provides no additional confirmation that the calibration is complete.

If calibration fails, a message is shown: **Calibration unsuccessful. Please try again..**

<b>i</b> <b>NOTE</b>
Remember that the TPMS system must be recalibrated at each tyre change or if the tyre pressure is adjusted. New reference values must be stored for the system to work correctly.

### Related information

- Tyre monitoring\* (p. 485)
- Checking tyre pressure with the tyre monitoring system\* (p. 487)
- Rectifying low tyre pressure with tyre monitoring\* (p. 488)

## Emergency puncture repair kit

The emergency puncture repair kit, Temporary Mobility Kit (TMK), is used to seal a puncture as well as to check and adjust the air pressure.

The puncture repair kit consists of a compressor and a bottle with sealing fluid. The sealing works as a temporary repair. The sealing fluid effectively seals tyres punctured in the tread.

The puncture repair kit has limited capacity to seal tyres which have punctures in the wall. Do not use the puncture repair kit on tyres that have larger slits, cracks or similar damage.

### **i** NOTE

The emergency puncture repair kit is only intended for sealing tyres with a puncture in the tread.

### **i** NOTE

The compressor for temporary emergency puncture repair has been tested and approved by Volvo.

## Location

The puncture repair kit is located in the foam block under the floor in the cargo area.

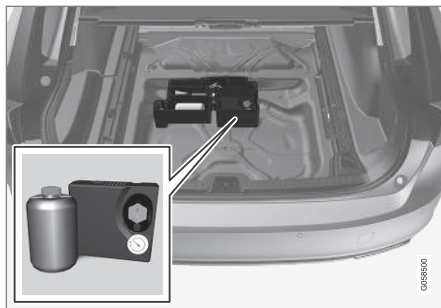

## Applies to Bi-Fuel\* cars

The puncture repair kit is located behind the side hatch on the left-hand side of the cargo area.

## Sealing fluid bottle

Replace the bottle with sealing fluid before the expiration date has passed and after use. Treat the old bottle as environmentally hazardous waste.

## **!** WARNING

The bottle contains 1,2-Ethanol and natural rubber-latex.

- Harmful if ingested.
- Could result in allergic reaction in the event of skin contact.
- Avoid contact with the skin and eyes.
- Store out of the reach of children.

## **!** WARNING

- In the event of skin contact with the sealing fluid, it must be washed off immediately with soap and plenty of water.
- Sealing fluid that makes contact with an eye must be rinsed away immediately with eye wash fluid or with plenty of water. If the discomfort persists then the eye should be examined by a doctor.

## Related information

- Using the emergency puncture repair kit (p. 491)
- Inflate tyres with the compressor from the emergency puncture repair kit (p. 494)
- Tyres (p. 482)



## Using the emergency puncture repair kit

Seal a puncture with the emergency puncture repair kit, Temporary Mobility Kit (TMK).

### Overview

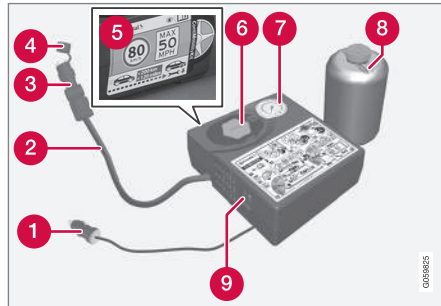

- 1 Electrical cable
- 2 Air hose
- 3 Pressure reducing valve
- 4 Protective cap
- 5 Label, maximum permitted speed
- 6 Bottle holder (orange cap)
- 7 Pressure gauge

8 Sealing fluid bottle

9 Switch

### Connecting

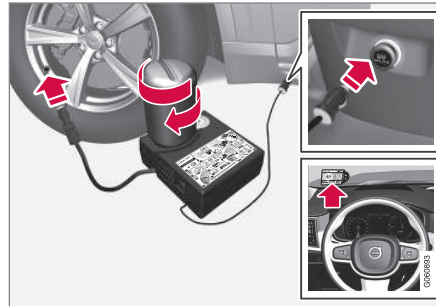

1. Set up the warning triangle and activate the hazard warning lights if a tyre is being sealed in a trafficked location.

If the puncture was caused by a nail or similar, allow this to remain in the tyre. It helps to seal the hole.

2. Detach the decal for maximum permitted speed that is affixed on one side of the compressor. Affix it visibly on the windscreen as a reminder to observe the speed limit. You should not drive faster than 80 km/h (50 mph) after the emergency tyre repair kit has been used.

3. Check that the switch is in position **0**, and locate the electrical cable and the air hose.
4. Unscrew the orange-coloured cap from the compressor, and unscrew the cork from the bottle.

### **i** NOTE

Do not break the bottle's seal before use. The seal is broken automatically when the bottle is screwed in.

## WHEELS AND TYRES

- ◀ 5. Screw in the bottle to the bottom of the bottle holder.
- > The bottle and the bottle holder are equipped with a reverse catch to prevent sealant leakage. When the bottle is screwed in it cannot be unscrewed from the bottle holder again. Bottle removal must be performed at a workshop, Volvo recommends an authorised Volvo workshop.

### **WARNING**

- In the event of skin contact with the sealing fluid, it must be washed off immediately with soap and plenty of water.
- Sealing fluid that makes contact with an eye must be rinsed away immediately with eye wash fluid or with plenty of water. If the discomfort persists then the eye should be examined by a doctor.

### **WARNING**

Do not unscrew the bottle, it is equipped with a reverse catch to prevent leakage.

6. Unscrew the tyre's dust cap.
- Check that the pressure reducing valve on the air hose is fully screwed on, and screw in the air hose's valve connection to the bottom of the tyre valve's thread.
7. Connect the electrical cable to the closest 12 V socket and start the car.

### **NOTE**

Make sure that none of the other 12 V sockets is in use when the compressor is operating.

### **WARNING**

Do not leave children in the car without supervision when the engine is running.

8. Start the compressor by flicking the switch to position I.

### **WARNING**

Never stand next to the tyre when the compressor is running. If cracks or unevenness arise then the compressor must be switched off immediately. The journey should not be continued. Contacting an authorised tyre centre is recommended.

### **NOTE**

When the compressor starts, the pressure can increase up to 6 bar but the pressure drops after approximately 30 seconds.

9. Inflate the tyre for 7 minutes.

### **IMPORTANT**

The compressor must not be operated for longer than 10 minutes - risk of overheating.

- Switch off the compressor to check the pressure on the pressure gauge. Minimum pressure is 1.8 bar and maximum 3.5 bar. (Release air with the pressure reducing valve if the tyre pressure is too high.)

 **WARNING**

If the pressure is below 1.8 bar then the hole in the tyre is too big. The journey should not be continued. Contacting an authorised tyre centre is recommended.

- Switch off the compressor and detach the electrical cable.
- Unscrew the air hose from the tyre valve and refit the dust cap on the tyre.
- Fit the protective cap on the air hose in order to avoid leakage of the remaining sealing fluid.

- As soon as possible, drive at least 3 km at a maximum speed of 80 km/h (50 mph) so that the sealing fluid can seal the tyre.

 **NOTE**

Sealant will spurt out of the puncture during the first few rotations of the tyre.

 **WARNING**

Make sure that nobody is standing near the car and gets the sealing fluid splashed onto them when the car is driven away. The distance should be at least two metres.

**15. Follow-up inspection**

Connect the air hose on the tyre valve and screw in the valve connection to the bottom of the tyre valve's thread. The compressor must be switched off.

- Read the tyre pressure on the pressure gauge.

- If it is below 1.3 bar then the tyre is insufficiently sealed. The journey should not be continued. Contact a tyre centre.
- If the tyre pressure is higher than 1.3 bar, the tyre must be inflated to the pressure specified in accordance with the tyre pressure label on the driver side door pillar (1 bar = 100 kPa). Release air using the pressure reducing valve if the tyre pressure is too high.

- If the tyre needs to be inflated:

- Connect the electrical cable to the closest 12 V socket and start the car.
- Start the compressor and inflate the tyre to the pressure specified in accordance with the tyre pressure label.
- Switch off the compressor.

- Remove the tyre sealing equipment, fit the protective cap on the air hose and fold the hose in the box.

Place TMK in the cargo area.

 **WARNING**

Do not unscrew the bottle, it is equipped with a reverse catch to prevent leakage.

- ◀ 19. Refit the dust cap on the tyre.

### NOTE

- After a tyre has been inflated, always refit the dust cap in order to avoid damage to the valve from gravel, dirt, etc.
- Only use plastic dust caps. Metal dust caps can rust and become difficult to unscrew.

### NOTE

The sealing fluid bottle and the hose must be replaced after use. Volvo recommends that this replacement is performed by an authorised Volvo workshop.

### WARNING

Check the tyre pressure regularly.

Volvo recommends that the car is driven to the nearest authorised Volvo workshop for the replacement/repair of the damaged tyre. Advise the workshop that the tyre contains sealing fluid.

### WARNING

You should not drive faster than 80 km/h (50 mph) after the emergency tyre repair kit has been used. Volvo recommends a visit to an authorised Volvo workshop for inspection of the sealed tyre (maximum driving distance is 200 km). The staff there can determine whether or not the tyre can be repaired or if it needs to be replaced.

### Related information

- Emergency puncture repair kit (p. 490)

### Inflate tyres with the compressor from the emergency puncture repair kit

The car's original tyres can be inflated using the compressor in the emergency puncture repair kit.

1. The compressor must be switched off. Make sure that the switch is in position **O** and locate the cable and air hose.
2. Unscrew the wheel's dust cap and screw in the air hose valve connection to the bottom of the thread on the tyre's air valve.
3. Connect the cable to one of the car's 12 V sockets and start the engine.

### WARNING

Inhaling car exhaust fumes could result in danger to life. Never leave the engine running in sealed areas or areas that lack sufficient ventilation.

### WARNING

Do not leave children in the car without supervision when the engine is running.

4. Start the compressor by flicking the switch to position **I**.

**! IMPORTANT**

Risk of overheating. The compressor must not run for more than 10 minutes.

- Inflate the tyre to the pressure specified on the tyre pressure label on the driver side door pillar. (Release air using the pressure reducing valve if the tyre pressure is too high.)



- Switch off the compressor. Detach the air hose and cable.
- Refit the dust cap.

**Related information**

- Emergency puncture repair kit (p. 490)
- Approved tyre pressures (p. 578)

**When changing wheels**

The car's wheels can be changed, e.g. to winter wheels or a spare wheel.

Follow the relevant instructions for removing and fitting wheels.

**When changing to another tyre dimension**

Check that the tyre dimension is approved for use on the car.

Contact an authorised Volvo workshop for updating the software at each change of tyre dimension. A software download may be necessary both when changing to larger and smaller dimensions, and also when switching between summer and winter wheels.

**Related information**

- Removing a wheel (p. 495)
- Fitting the wheels (p. 497)
- Tool kit (p. 500)
- Winter wheels (p. 499)
- Spare wheel\* (p. 498)
- Wheel bolts (p. 498)

**Removing a wheel**

Instructions for removing a wheel when changing wheels.

- Set up the warning triangle and activate the hazard warning lights if a tyre is being changed in a trafficked location.
- Apply the parking brake and engage gear position **P**, or engage first gear if the car has a manual gearbox.

Applies to cars with **Leveling Control\***: If the car is equipped with air suspension, this must be disabled before the car is raised with a jack\*.

Deactivate the function via the top view of the centre display by pressing **Settings** →

**My Car** → **Suspension** and selecting **Disable Leveling Control**.





**⚠ WARNING**

Check that the jack is not damaged, that the threads are thoroughly lubricated and that it is free from dirt.

3. Take out the jack\*, wheel wrench\* and tools for the wheel bolts' plastic caps that are fitted in the foam block.



Tool for removing the plastic caps on the wheel bolts.

**i NOTE**

The normal car jack is only designed for occasional, short-term use, such as when changing a wheel after a puncture, changing to winter/summer wheels, etc. Only the jack for the specific car model may be used to raise the car. If the car is to be jacked up more often, or for a longer time than is required just to change a wheel, use of a garage jack is recommended. In this instance, follow the instructions for use that come with the equipment.

4. Place chocks in front of and behind the wheels which will remain on the ground to prevent them from rolling. Use heavy wooden blocks or large stones for example.
5. Screw together the towing eye with the wheel wrench\* to the stop position.

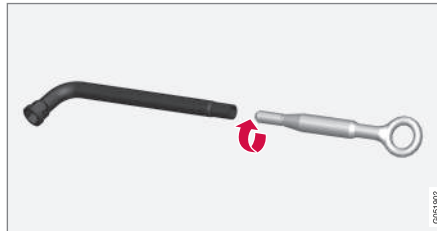

**⚠ IMPORTANT**

The towing eye must be screwed all the way into the wheel bolt wrench.

6. Remove the plastic caps from the wheel bolts with the intended tool.
7. Loosen the wheel bolts 1/2-1 turn anticlockwise with the wheel wrench\*.

**⚠ WARNING**

Never position anything between the ground and the jack, nor between the jack and the car's jacking point.

**⚠ IMPORTANT**

The ground must be firm, smooth and level.

8. When raising the car, it is important that the jack\* or lifting arms are fitted in the intended points on the car's underbody. The triangle markings in the plastic cover indicate the locations of the jacking/lifting points. There are two jacking points on each side of the car. There is a recess for the jack at each point.

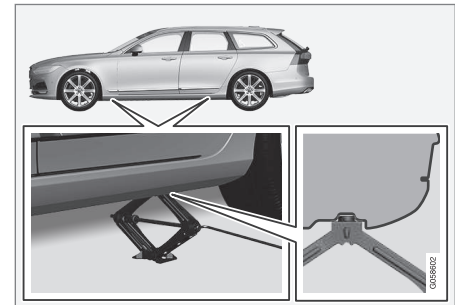

Crank up the jack\* so that it makes contact with the car's jacking point. Check that the head of the jack is correctly positioned in the jacking point so that the bump in the centre of the head fits into the jacking point hole and the base is positioned vertically below the jacking point. Also make sure you turn the jack so that the crank is as far away from the side of the car as possible, at which point the jack's arms are perpendicular to the direction of the car.

### WARNING

Never crawl under the car when it is raised on the jack.

Passengers must leave the car when it is raised on the jack. If a wheel must be changed in a trafficked environment, passengers must stand in a safe place.

- Lift the car so that the wheel is free. Remove the wheel bolts and lift off the wheel.

### Related information

- When changing wheels (p. 495)
- Raise the car (p. 512)
- Fitting the wheels (p. 497)
- Tool kit (p. 500)

## Fitting the wheels

Instructions for fitting a wheel when changing wheels.

### WARNING

Never crawl under the car when it is raised on the jack.

Passengers must leave the car when it is raised on the jack. If a wheel must be changed in a trafficked environment, passengers must stand in a safe place.

- Clean the contact surfaces between wheel and hub.
- Put on the wheel. Tighten the wheel bolts thoroughly.  
  
Do **not** use lubricant on the threads of the wheel bolts.
- Lower the car so that the wheels cannot rotate.

- Tighten the wheel bolts crosswise. It is important that the wheel bolts are tightened properly. Tighten to 140 Nm. Check the tightening torque with a torque wrench.



- Refit the plastic caps on the wheel bolts.

### NOTE

- After a tyre has been inflated, always refit the dust cap in order to avoid damage to the valve from gravel, dirt, etc.
- Only use plastic dust caps. Metal dust caps can rust and become difficult to unscrew.

### Related information

- Removing a wheel (p. 495)
- When changing wheels (p. 495)
- Spare wheel\* (p. 498)

## Wheel bolts

Wheel bolts are used to attach the wheels to the hubs.

### ! IMPORTANT

The wheel bolts must be tightened to 140 Nm. Overtightening or loose tightening may damage the nuts and the bolts.

Only use rims that are tested and approved by Volvo and which are Volvo genuine accessories.

Check the tightening torque of the wheel bolts with a torque wrench.

Do **not** use lubricant on the threads of the wheel bolts.

## Locking wheel bolts\*

In the foam block under the cargo area floor there is space for the sleeve for the lockable wheel bolts.

## Related information

- When changing wheels (p. 495)

## Spare wheel\*

The spare wheel, the Temporary spare type, can be used to temporarily replace a punctured normal wheel.

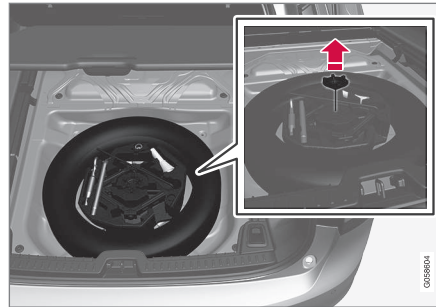

The illustration is schematic - the shape of the foam block may vary depending on car model.

The spare wheel is located in the spare wheel well with the outside down. The same bolt runs through to secure the spare wheel and the foam block. The foam block contains all tools for changing a wheel, see the section "Tool kit".

The car's handling may be altered by the use of the spare wheel. The spare wheel must be replaced by a normal wheel as soon as possible.

The spare wheel is smaller than the regular wheel, which will affect the car's ground clearance. Pay attention to high kerbs and do not machine wash the car.

- Follow the manufacturer's recommended tyre pressure for the spare wheel.
- On all-wheel drive cars the drive on the rear axle can be disconnected.
- If the spare wheel is fitted on the front axle, it is not possible to use snow chains at the same time.
- The spare wheel must not be repaired.

### ! IMPORTANT

- Never drive faster than 80 km/h (50 mph) with a spare wheel on the car.
- The car must never be driven fitted with more than one "Temporary Spare" wheel.

## Taking out the spare wheel

1. Fold up the cargo area floor, from the rear and forwards.
2. Undo the retaining screw.
3. Lift out the foam block with its tools.
4. Lift out the spare wheel.

## Storing the punctured tyre

1. Put the tools back in the foam block and lift the foam block back into the car.
2. Screw in the foam block using the mounting screws and then fold down the cargo area floor.
3. Place the punctured tyre in the cargo area.



### Related information

- Removing a wheel (p. 495)
- Fitting the wheels (p. 497)
- Tool kit (p. 500)
- Jack\* (p. 501)

### Winter wheels

Winter wheels are adapted for winter road conditions.

Volvo recommends winter tyres with particular dimensions. Tyre dimensions are dependent on engine variant. When driving on winter tyres, the correct type of tyres must be fitted to all four wheels.

#### NOTE

Contact a Volvo dealer for advice about which wheel rim and type of tyre are most suitable.

### Tips for changing to winter tyres

When summer and winter wheels are changed, mark which side of the car they were mounted on, for example **L** for left and **R** for right.

### Studded tyres

Studded winter tyres should be run in gently for 500-1000 km so the studs settle properly into the tyres. This gives the tyre, and especially the studs, a longer service life.

#### NOTE

The legal provisions for the use of studded tyres vary from country to country.

### Tread depth

Road conditions with ice, slush and low temperatures place considerably higher demands on tyres than summer conditions. Volvo therefore recommends not to drive on winter tyres that have a tread depth of less than 4 mm.

### Snow chains

Volvo recommends that snow chains are not used on wheel dimensions greater than 18 inches.

Mounting instructions are supplied with Volvo original snow chains.

Snow chains may only be used on the front wheels (also applies to all-wheel drive cars). Never drive faster than 50 km/h (30 mph) with snow chains. Avoid driving on bare ground as this wears out both the snow chains and tyres.

#### WARNING

Use Volvo genuine snow chains or equivalent chains designed for the car model, and tyre and rim dimensions. Only **single-sided** snow chains are permitted.

In the event of uncertainty about the snow chain, Volvo recommends that an authorised Volvo workshop should be contacted. The wrong snow chains may cause serious damage to the car and lead to an accident.

### Related information

- When changing wheels (p. 495)

## Tool kit

Tools that can be useful during towing, wheel changes or similar are found in the car's cargo area.

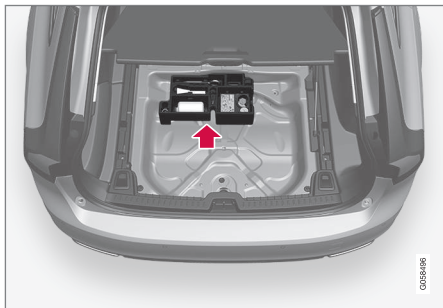

The foam block under the cargo area floor contains the car's towing eye, puncture repair kit, tool for removing the plastic caps from the wheel bolts and a socket for the lockable wheel bolts.

If the car is equipped with spare wheel\* then a jack\* and wheel wrench\* are included, as well as a package\* with disposable gloves and a bag for the damaged tyre.

### Applies to Bi-Fuel\* cars

The tools are located behind the side hatch on the left-hand side of the cargo area.

## Related information

- When changing wheels (p. 495)
- Jack\* (p. 501)
- Warning triangle (p. 500)
- First aid kit (p. 502)

## Warning triangle

Use the warning triangle to warn other road users if the car is stationary in traffic.

Also activate the hazard warning flashers.

### Storage spaces

The warning triangle is located under the panel on the inside of the tailgate.

### Folding up the warning triangle

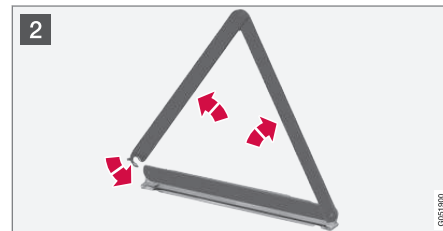
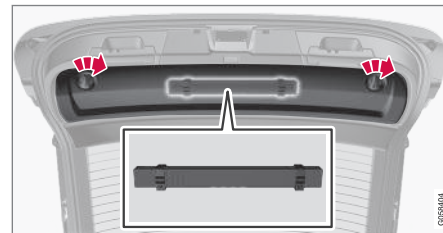

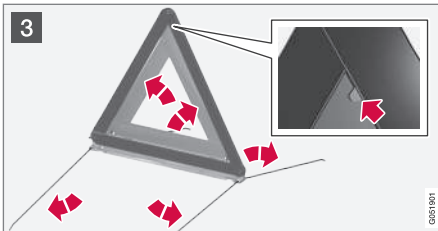

- 1 Detach the panel on the inside of the tailgate by first turning the two knobs a quarter turn and then unhooking the panel. Place the panel to one side.

Open the latch and take out the case.

- 2 Remove the warning triangle from the case, unfold it and put the ends together.

- 3 Fold out the warning triangle's support legs.

Follow the regulations for the use of a warning triangle. Position the warning triangle in a suitable place with regard to traffic.

Make sure that the warning triangle and case are properly secured in their storage space and that the hatch is fully closed after use.

### Related information

- Tool kit (p. 500)
- Hazard warning flashers (p. 143)

### Jack\*

Use the jack to raise the car when changing a wheel.

Only use the original jack when fitting a spare wheel or when changing between summer and winter wheels. The jack's thread must always be well greased.

### ! IMPORTANT

The tools and jack\* must be stored in the intended location in the car's cargo area when not in use.

The jack needs to be cranked together to the correct position in order to have space.

### i NOTE

The normal car jack is only designed for occasional, short-term use, such as when changing a wheel after a puncture, changing to winter/summer wheels, etc. Only the jack for the specific car model may be used to raise the car. If the car is to be jacked up more often, or for a longer time than is required just to change a wheel, use of a garage jack is recommended. In this instance, follow the instructions for use that come with the equipment.

### Applies to cars with level control\*

If the car is equipped with air suspension then this must be deactivated before the car is raised with the jack.

Switch off the function via the centre display:

1. Press on **Settings** in the top view:
2. Press **My Car** → **Suspension**.
3. Select **Disable Leveling Control**.

### Related information

- Tool kit (p. 500)
- Raise the car (p. 512)

### First aid kit

The first aid kit contains first aid equipment.

Store the first aid kit in the space on the right-hand side in the cargo area.

### Related information

- Tool kit (p. 500)

### Dimension designation for wheel rim

Wheel and rim dimensions are designated in accordance with the examples in the table below.

All wheel rims have a dimension designation, for example: 8.5Jx19x47.5.

8.5	Rim width in inches
J	Rim flange profile
19	Rim diameter in inches
47,5	Off-set in mm (distance from wheel centre to wheel contact surface against the hub)

The car has an approval for the complete vehicle with certain combinations of wheel rims and tyres.

### Related information

- Tyres (p. 482)
- Dimension designation for tyre (p. 502)
- Approved wheel and tyre sizes (p. 576)

### Dimension designation for tyre

Designations for tyre dimension, load index and speed rating.

The car has an approval for the complete vehicle with certain combinations of wheel rims and tyres.

### Designation of dimensions

All tyres have a dimension designation, such as: 255/40 R19 100 W.

255	Tyre width (mm)
40	Ratio between tyre wall height and tyre width (%)
R	Radial ply
19	Rim diameter in inches
100	Codes for the maximum permitted tyre load, tyre load index (LI)
W	Speed rating for maximum permitted speed, speed rating (SS). (In this case 270 km/h (168 mph).)

### Load index

Each tyre has a certain capacity to carry a load, a load index (LI). The car's weight determines the load capacity required of the tyres. The lowest permitted load index is specified in a load index table.

## Speed rating

Each tyre can withstand a certain maximum speed. Tyre speed rating, SS (Speed Symbol), must at least correspond with the car's top speed. The table below shows the maximum permitted speed for each speed rating (SS). The only exception to these regulations is winter tyres<sup>3</sup>, where a lower speed rating may be used. If such a tyre is chosen, the car must not be driven faster than the speed rating of the tyre (for example, class Q can be driven at a maximum of 160 km/h (100 mph).) The top speed at which the car can be driven depends on road conditions, not the speed rating of the tyres.

<b>i</b> <b>NOTE</b>
The maximum permitted speed is specified in the table.

Q	160 km/h (100 mph) (used only on winter tyres)
T	190 km/h (118 mph)
H	210 km/h (130 mph)
V	240 km/h (149 mph)
W	270 km/h (168 mph)
Y	300 km/h (186 mph)

<sup>3</sup> Both those with metal studs and those without.

## WARNING

The lowest permitted tyre load index (LI) and speed rating (SS) for the tyres for each respective engine variant are shown in the table, "Load index and speed rating". If a tyre with too low a load index or speed rating is used, it may overheat and be damaged.

## Related information

- Tyres (p. 482)
- Dimension designation for wheel rim (p. 502)
- Approved wheel and tyre sizes (p. 576)
- Approved tyre pressures (p. 578)
- Load index and speed rating (p. 577)



MAINTENANCE AND SERVICE

## Volvo service programme

To keep the car as safe and reliable as possible, follow the Volvo service programme as specified in the Service and Warranty Booklet.

Volvo recommends engaging an authorised Volvo workshop to perform the service and maintenance work. Volvo workshops have the personnel, special tools and service literature to guarantee the highest quality of service.

### **IMPORTANT**

For the Volvo warranty to apply, check and follow the instructions in the Service and Warranty Booklet.

### Related information

- Servicing the climate control system (p. 520)
- Book service and repair (p. 506)

## Car status

The car's general status can be shown in the centre display along with the opportunity to book service.



The **Car status** app is started from app view in the centre display and has three tabs:

- **Messages** - saved status messages
- **Status** - check of tyre pressure and engine oil level
- **Appointments** - booking of service and repair work.

### Related information

- Managing messages saved from the driver display and centre display (p. 110)
- Checking tyre pressure with the tyre monitoring system\* (p. 487)
- Checking and filling with engine oil (p. 517)
- Book service and repair (p. 506)

## Book service and repair<sup>1</sup>

Manage service, repair and booking information directly from your online car.

The information is handled in the **Car status app**, which is opened from the app view in the centre display.

This service provides, for certain markets, a convenient way to book service and workshop visits directly from your car. Vehicle data is sent to your dealer, who can prepare the workshop visit. The dealer will get back to you with a booking suggestion. For certain markets, the system will remind you of a scheduled appointment time as it approaches and the navigation system<sup>2</sup> can also guide you to the workshop when the time comes. You also have information on your dealer available in the car and can contact your workshop at any time.

### Before the service can be used

#### Volvo ID

- Create a Volvo ID, see section "Volvo ID".
- Register the Volvo ID for your car, see section "Volvo ID". If a Volvo ID already exists, use the same e-mail address that was used when the Volvo ID was created.

<sup>1</sup> Applies to certain markets.

<sup>2</sup> Applies to Sensus Navigation\*.



### Changing contact address

If you would like to change to another e-mail address, you can contact a Volvo dealer.

### Selecting a Volvo dealer

Select the Volvo dealer you would like to contact for service and repairs by going to [www.volvocars.com](http://www.volvocars.com) and navigating to My Volvo.

### Prerequisite for booking from car

For the car to send and receive booking information, it must be connected to the Internet, see section "Online car".

### Using the service

When it is time for service, and in some cases when the car is in need of repair, a message will appear in the driver display and at the top of the centre display. The service date is determined by how much time has passed, hours that the engine has been running, or distance driven since the last service.

You can also book a workshop visit later via the My Volvo owner's portal. To ensure that your dealer has the latest information on your car you can send vehicle data, see section "Sending Vehicle Data" below.

### Book service or repair

Fill in the appointment request when desired or when a message stating that service or repairs are needed is shown in the driver display and at the top of the centre display.

### Filling in and sending an appointment request.



1. Open the **Car status** app from the app view in the centre display.
2. Press the **Appointments** button.
3. Press the **Request appointment** button.
4. Make sure that the correct **Volvo ID** is filled in.
5. Make sure that the desired **Workshop** is filled in.

6. Fill in information for the workshop in the field **Tap to write information to the workshop**, e.g. if there is anything you would like done during the workshop visit or any other important information to your workshop.



Or press the button and speak the information. The information is then entered in the information field in your appointment request.

7. Press the **Send appointment request** button.
  - > You will receive an appointment suggestion to your car within a couple of days.<sup>3</sup> You will also receive the same communication via e-mail and when you visit My Volvo.

In certain markets, once you have sent the appointment request, the message that the car needs service is extinguished in the driver display.
8. Press the **Cancel request** button to cancel your request.

<sup>3</sup> This time frame may vary depending on market.

- ◀◀ The appointment request contains vehicle data when it is sent from your car to the workshop via your Internet connection. This information facilitates planning for the workshop.

### Accept the appointment suggestion

The car will retrieve appointment suggestions via your Internet connection when it is available. When the car has received an appointment suggestion, a message will be shown at the top of the centre display.

1. Tap the message.
2. If the suggested booking is acceptable, tap on the **Accept** button. Otherwise press either of the **Send new proposal** or **Decline** buttons.

When an appointment suggestion is accepted, the reply will be sent to the workshop via your Internet connection.

### Sending vehicle data

You can send vehicle data at any time from your car, e.g. if you book a workshop visit directly via the My Volvo owner's portal, and will help your workshop with better basic information.

The vehicle data sent is the last saved (last time the car was running).

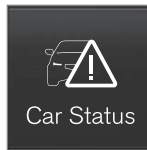

Car Status

1. Open the **Car status** app from the app view in the centre display.
2. Press the **Appointments** button.
3. Press the **Send car data** button.
  - > A message that vehicle data are being sent is shown at the top of the centre display. You can cancel data transmission by tapping the X in the activity indicator.

The vehicle data are sent via your Internet connection.

### See workshop information

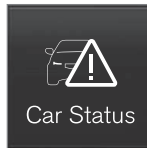

Car Status

1. Open the **Car status** app from the app view in the centre display.
2. Press the **Appointments** button.

3. Press the **Workshop information** button.
  - > A pop-up window with information on your dealer will open.
4. Call your dealer if you like, or tap on the address or GPS coordinates to start navigation to your workshop<sup>2</sup>.

### Booking information and vehicle data

When you decide to book a service or send data from your car, the booking information and vehicle data will be sent via your Internet connection. The vehicle data make it easier for your workshop to plan your next visit.

The vehicle data consists of information in the following areas:

- service requirement
- time since last service
- function status
- fluid levels
- meter reading
- the car's vehicle identification number (VIN<sup>4</sup>)
- the car's software version
- the car's diagnostics data.

<sup>2</sup> Applies to Sensus Navigation\*.

<sup>4</sup> Vehicle Identification Number.

### Related information

- Volvo ID (p. 23)
- Online car\* (p. 463)
- Car status (p. 506)

### Inspection and service of the system for vehicle gas<sup>5</sup>

The system for vehicle gas must be inspected regularly by an authorised workshop - an authorised Volvo workshop is recommended.

#### **WARNING**

The gas is compressed to high pressure. This system must only be serviced and repaired by an authorised workshop.

Never attempt to disassemble or adjust the gas system or its component parts yourself - risk of serious personal injury.

### Remote updates

Several of the car's systems can be updated from the centre display with an online car.

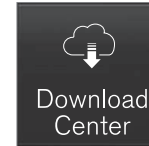

The **Download Centre** app is started from app view in the centre display and enables:

- searching for and updating system software
- updating map data for Sensus Navigation\*
- downloading, updating and uninstalling apps.

### Related information

- System updates (p. 510)
- Downloading, updating and uninstalling apps (p. 468)

<sup>5</sup> Applies to the Bi-Fuel model variant.

## System updates

System updates are intended for the Internet-connected and infotainment components of the car. If system software updates are available, the updates can be made all at once or one at a time.

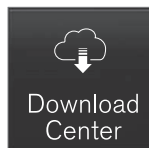

System updates are handled via the **Download Centre** app in the centre display's application view. A tap on the button starts a download application in the home view's bottom subview. If no search for available

updates has been performed since the last time the infotainment system was started, a search is performed. No search is performed if a software installation is in progress. An icon in the download application's button **System updates** shows how many updates are available. A tap on the button shows a list of updates that can be installed in the car. For more information and answers to common questions regarding function and to download certain system updates, go in to support.volvocars.com.

For system updates to be possible, the car must be connected to the Internet, see section "Online car".

Searching for software updates is activated when the car is supplied from the factory.

### NOTE

Data download may affect other services that transmit data, e.g. Internet radio. If the effect on other services is experienced as disruptive then the download can be interrupted. Alternatively, it may be appropriate to switch off or interrupt other services.

### NOTE

An update can be interrupted when the ignition is switched off and the car is left. However, the update does not have to be completed before the car is left, this is because the update is resumed the next time the car is used.

### Update all system software

- Select **Install all** at the bottom of the list.

If no list is desired, then **Install all** can be selected at the **System updates** button instead.

### Update individual system software programs

- Select **Install** for the software required.

### Cancelling the download

- Tap on X in the activity indicator that has replaced the button **Install** at the start of the download.

Note that only the download can be cancelled, when the installation phase has started, this cannot be cancelled.

### Background search for software updates

The function can be deactivated via the centre display:

1. Press **Settings** in the top view.
2. Press **System** → **Download Centre**.
3. Deselect **Auto Software Update**.

If an update is available, the message **New software updates available** is shown in the centre display's status bar. A tap on the message starts a download application in the home view's bottom subview. As soon as the download application has started, an icon in the download application's button **System updates** shows how many updates are available.

### Related information

- Online car\* (p. 463)
- Downloading, updating and uninstalling apps (p. 468)
- Remote updates (p. 509)

## Data transmission between car and workshop<sup>6</sup>

The time required for a booked visit to a Volvo workshop can be shortened by transmitting troubleshooting data as soon as the car stops at the workshop.

The data can be transmitted most conveniently by selecting the option **Automatically connect when I arrive** in settings view in the centre display.

Each time the car slows to a slow enough speed it starts searching for a Wi-Fi network. If an authorised Volvo network (at a workshop) is found, a message is displayed or a pop-up window opens in the centre display. (This does not apply when you connect manually, see the section "Connecting to a workshop manually" below).

## Connecting to a workshop automatically

### NOTE

To avoid the driver being disturbed by unwanted connection inquiries (for example, if the car is often parked in the neighbourhood of a workshop with an authorised Volvo network), the connection mode will change to manual if the driver declines connection twice within a period of 5 days.

### Without driver confirmation

This option provides the most convenient way of transmitting troubleshooting data. The car connects without the need for the driver to confirm.

If the car stops at the workshop and is switched off with the start knob, a message is shown at the top in the centre display. The car will connect automatically when the driver's door is opened unless the driver presses the **Cancel** message button.

### With driver confirmation

This option requires confirmation by the driver for the car to connect.

If the car stops at the workshop and is switched off with the start knob, a pop-up window is opened in the centre display. If the driver taps the **Connect** button in the pop-up window then the

car will automatically be connected when the driver's door is opened. If the driver does nothing, or presses the **Abort** button in the pop-up window, no connection will be made.

### Connecting to a workshop manually

Manual connection is made by the service technician.

### Changing the connection mode

The way the car connects can be changed in the settings view in the centre display.

1. Press **Settings** in the top view.
2. Press **Communication** → **Volvo Service Networks**.
3. Select **Automatically connect when I arrive**, **Ask before connecting** or **Never connect and never ask** (manual connection).

### Related information

- Online car\* (p. 463)
- Settings view (p. 169)

<sup>6</sup> This functionality will be gradually introduced in connection with the service workshops extending their services.

## Raise the car

When raising the car it is important that the car jack or the workshop/garage jack is fitted to the intended points on the car's underbody.

For cars with level control\*, air suspension, if fitted, must be switched off before the car is raised.

Switch off the function via the centre display:

1. Press **Settings** in the top view.
2. Press **My Car** → **Suspension** .
3. Select **Disable Leveling Control**.

### **NOTE**

Volvo recommends only using the jack that belongs to the car model in question. If a jack is selected other than the one recommended by Volvo, follow the instructions supplied with the equipment.



The triangles in the plastic cover indicate the locations of the lifting points (marked in red).

If the car is raised with a workshop jack, it must be positioned under one of the four lifting points. Ensure that the workshop jack is positioned so that the car cannot slide off the jack. Make sure the jack plate is equipped with a rubber pad so that the car will be stable and not be damaged. Always use axle stands or similar.

### Related information

- When changing wheels (p. 495)
- Jack\* (p. 501)

## Opening and closing the bonnet

The bonnet can be opened using the handle in the passenger compartment and a handle under the bonnet.

### Open the bonnet

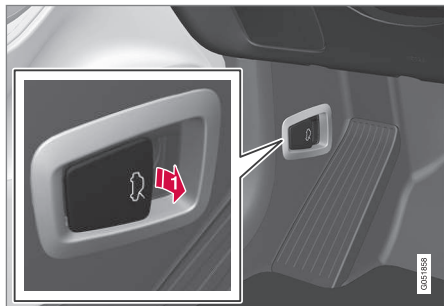

- i** Pull the handle near the foot pedals to release the bonnet from its fully closed position.



- 2** Turn the handle under the bonnet anticlockwise to release the bonnet from the lock catches and lift the bonnet.

### Warning - bonnet not closed



When the bonnet is released, the warning symbol and the graphics in the driver display will light up and an acoustic reminder will sound. If the car starts rolling, an acoustic warning signal will repeat.

For more information on graphics, see section "Door and seatbelt reminder".

### **i** NOTE

If the warning symbol is lit or the warning signal is heard despite the bonnet being closed properly, contact an authorised Volvo workshop.

### Close the bonnet

1. Push the bonnet down until it starts to fall from its own weight.
2. When the bonnet stops against the lock catch, push the bonnet to close it completely.

### **!** WARNING

Risk of crushing! Ensure that the closing path under the bonnet is not obstructed, otherwise there is a risk of personal injury.

### **!** WARNING

Check that the bonnet locks properly when closed. The bonnet must engage at both sides audibly.







Bonnet completely closed.

**⚠ WARNING**

Never drive with an open bonnet!

If there are any signs that the bonnet is not properly closed whilst driving, stop immediately and close it.

**Related information**

- Engine compartment overview (p. 515)
- Door and seatbelt reminder (p. 62)

**Engine compartment overview**

The overview shows some service-related components.

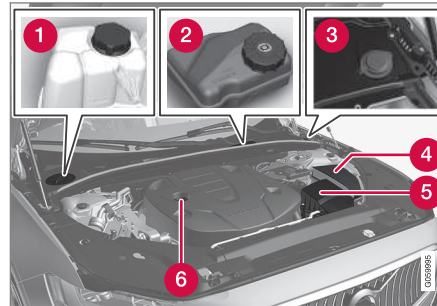

The appearance of the engine compartment may differ depending on model and engine variant.

- 1 Coolant expansion tank
- 2 Reservoir for brake and clutch fluid (located on the driver's side)
- 3 Washer fluid filler pipe<sup>7</sup>
- 4 Central electrical unit
- 5 Air filter
- 6 Engine oil filler pipe

**⚠ WARNING**

Remember that the radiator fan (located at the front of the engine compartment, behind the radiator) may start automatically some after the engine has been switched off.

Always have the engine cleaned by a workshop - an authorised Volvo workshop is recommended. There is a risk of fire if the engine is hot.

**⚠ WARNING**

The ignition system works at a very high and hazardous voltage. The car's electrical system must always be in ignition position **0** when work is being performed in the engine compartment.

Do not touch the spark plugs or ignition coil when the car's electrical system is in ignition position **II** or when the engine is hot.

**Related information**

- Opening and closing the bonnet (p. 514)
- Filling washer fluid (p. 529)
- Topping up coolant (p. 518)
- Fuses in engine compartment (p. 537)
- Checking and filling with engine oil (p. 517)
- Ignition positions (p. 383)

<sup>7</sup> Fill the washer fluid at regular intervals, e.g. when refuelling.

## Engine oil

An approved engine oil must be used in order that the recommended service intervals can be applied.

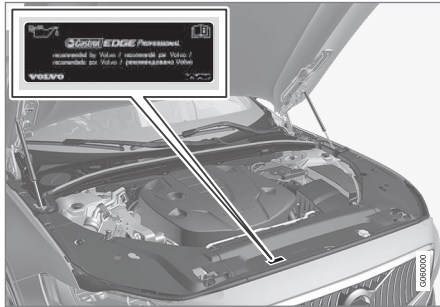

Volvo recommends:





**! IMPORTANT**

In order to fulfil the requirements for the engine's service intervals all engines are filled with a specially adapted synthetic engine oil at the factory. The choice of oil has been made very carefully with regard to service life, starting characteristics, fuel consumption and environmental impact.

An approved engine oil must be used in order that the recommended service intervals can be applied. Only use a prescribed grade of oil for both filling and oil change, otherwise there is a risk of the service life, starting characteristics, fuel consumption and environmental impact of the car being affected.

If engine oil of the prescribed grade and viscosity is not used, engine related components may become damaged. Volvo Car Corporation disclaims any liability for any such damage.

Volvo recommends that oil changes are carried out at an authorised Volvo workshop.

Volvo uses different systems for warning of low/high oil level or low oil pressure. Certain engine variants have an oil pressure sensor, and then the driver display's warning symbol for low oil pressure  is used. Other variants have an oil level sensor, when the driver is informed via the driver display's warning symbol  and display

texts. Certain variants have both systems. Contact a Volvo dealer for more information.

Change the engine oil and oil filter in accordance with the intervals specified in the Service and Warranty Booklet.

Using oil of a higher than specified grade is permitted. If the car is driven in adverse conditions, Volvo recommends using an oil of a higher grade than the one specified.

### Related information

- Checking and filling with engine oil (p. 517)
- Adverse driving conditions for engine oil (p. 569)
- Engine oil — specifications (p. 567)

## Checking and filling with engine oil

The oil level is detected with the electronic oil level sensor.

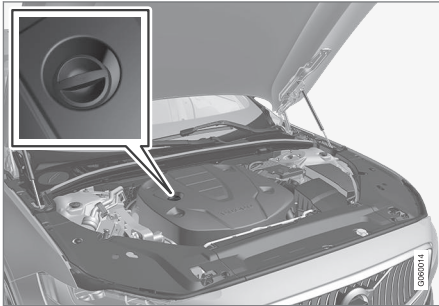

Filler pipe<sup>8</sup>.

In some cases, oil may need to be topped up between service intervals.

Action with regard to engine oil level does not need to be taken until a message is shown in the driver display.

### WARNING



If this symbol is shown together with the message **Engine oil level Service required**, visit a workshop - an authorised Volvo workshop is recommended. The oil level may be too high.

### IMPORTANT



If this symbol is shown together with a message about low oil level, such as **Engine oil level low Refill 1 litre** for example, then only fill the volume specified, e.g. 1 litre.

### WARNING

Do not spill oil onto the hot exhaust manifold due to the risk of fire.

## Check the oil level



1. Open the **Car status** app from the app view in the centre display.
2. Press the **Status** button to show the oil level.

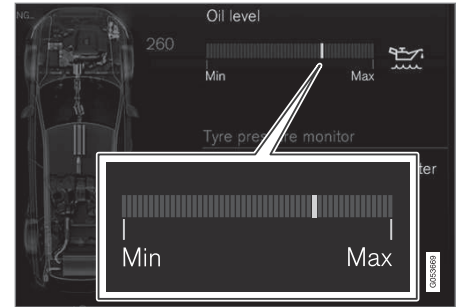

Graphics for oil level in the centre display.

The oil level is checked using the electronic oil level gauge in the centre display when the engine is switched off.

### NOTE

The system cannot directly detect changes when the oil is filled or drained. The car must have been driven approx. 30 km and have been stationary for 5 minutes with the engine switched off and on level ground before the oil level indication is correct.

<sup>8</sup> Engines with electronic oil level sensor do not have a dipstick.



**i NOTE**

If the right conditions for measuring the oil level (time after engine shutdown, the car's inclination, outside temperature, etc.) are not met, then the message **No value available** will be shown in the centre display. This does **not** mean that there is something wrong in the car's systems.

**Related information**

- Engine oil (p. 516)
- Engine oil — specifications (p. 567)
- Adverse driving conditions for engine oil (p. 569)
- Ignition positions (p. 383)
- Car status (p. 506)

**Topping up coolant**

The coolant cools the internal combustion engine to the correct operating temperature. The heat that is transferred from the engine to the coolant can be used to heat the passenger compartment.

When topping up the coolant, follow the instructions on the packaging. Never top up with water only. The risk of freezing increases with both too little and too much coolant concentrate.

**⚠ WARNING**

Coolant can be very hot. If the coolant requires topping up when the engine is at operating temperature, unscrew the expansion tank cap slowly to gently release the overpressure.



Coolant expansion tank, left-hand drive car.



- 1 Screw off the cap in the plastic cover.
- 2 Screw off the cap on the expansion tank and top up with coolant. The coolant level must not exceed the yellow **MAX** mark inside the expansion tank.

Reinstall the parts in reverse order.

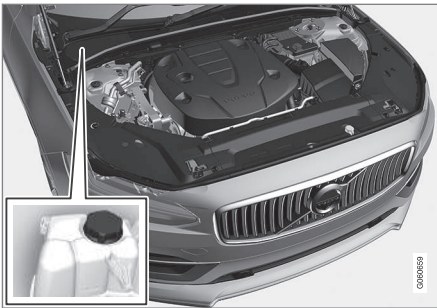

Coolant expansion tank, right-hand drive car.

- 1 Grip the hatch's handle and lift/jiggle the hatch from the plastic cover.
- 2 Screw off the cap on the expansion tank and top up with coolant. The coolant level must not exceed the yellow **MAX** mark inside the expansion tank.

Reinstall the parts in reverse order.

If there is coolant under the car, if there is coolant smoke, or if more than 2 litres have been filled, always call for recovery to avoid the risk of engine damage due to a defective cooling system when attempting to start the car.

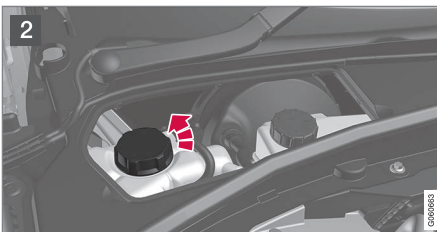
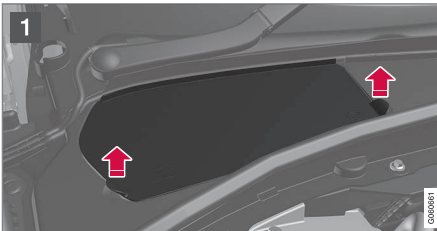

**!** **IMPORTANT**

- A high content of chlorine, chlorides and other salts may cause corrosion in the cooling system.
- Always use coolant with anti-corrosion agent as recommended by Volvo.
- Ensure that the coolant mixture is 50% water and 50% coolant.
- Mix the coolant with approved quality tap water. In the event of any doubt about water quality, used ready-mixed coolant in accordance with Volvo recommendations.
- When changing coolant/replacing cooling system components, flush the cooling system clean with approved quality tap water or flush with ready-mixed coolant.
- The engine must only be run with a well-filled cooling system. Otherwise, temperatures that are too high may occur resulting in the risk of damage (cracks) in the cylinder head.

**Related information**

- Coolant — specifications (p. 570)

## Servicing the climate control system

The air conditioning system must only be serviced and repaired by an authorised workshop.

## Troubleshooting and repair

The air conditioning system contains fluorescent tracing agents. Ultraviolet light must be used during leak detection.

Volvo recommends that you contact an authorised Volvo workshop.

## Cars with R134a refrigerant

### WARNING

The air conditioning system contains pressurised refrigerant R134a. This system must only be serviced and repaired by an authorised workshop.

## Cars with R1234yf refrigerant

### WARNING

The air conditioning system contains pressurised refrigerant R1234yf. In accordance with SAE J2845 (Technician Training for Safe Service and Containment of Refrigerants Used in Mobile A/C System), service and repair of the refrigerant system must only be performed by trained and certified technicians in order to ensure the safety of the system.

## Related information

- Volvo service programme (p. 506)

## Bulb replacement

The bulb in the halogen headlamp, reversing lamp and rear fog lamp can be replaced by the driver.

The bulb in the halogen headlamp can be replaced without the help of a workshop, but the plastic cover over the headlamp must be removed before a bulb can be replaced.

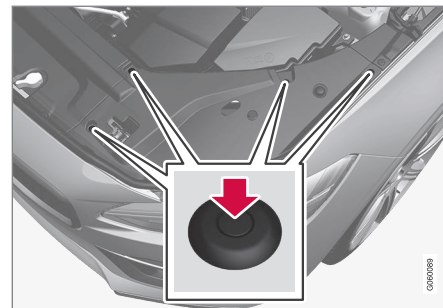

- Press down the pins into the plastic cover's four clips using a screwdriver or similar and lift away the cover.

**i NOTE**

Points to remember when the cover is refitted:

- The pin in the clip needs to be pressed back fully before the clip is refitted in the cover.
- When the cover is refitted, the pin must be pressed in until the end surface is level with the surface of the clip.

The reversing lamp bulb and the rear fog lamp bulb can be replaced without assistance from a workshop.

Contact a workshop<sup>9</sup> if there is a fault in bulbs other than the bulbs in the halogen headlamps, the reversing lamp bulb or the rear fog lamp bulb. If a fault occurs in LED<sup>10</sup> lamps, the entire lamp unit usually must be replaced.

**⚠ WARNING**

The car's electrical system must be in ignition position **0** when replacing bulbs.

**! IMPORTANT**

Never touch the glass part of the bulbs with your fingers. Grease from your fingers is vaporised by the heat, coating the reflector and then causing damage.

**i NOTE**

If an error message remains after the broken bulb has been replaced then we recommend visiting an authorised Volvo workshop.

**i NOTE**

Outside lighting such as headlamps and rear lamps may temporarily have condensation on the inside of the lens. This is normal, all exterior lighting is designed to withstand this. Condensation is normally vented out of the lamp housing when the lamp has been switched on for a time.

**Lamps, front (car with halogen headlamps)**

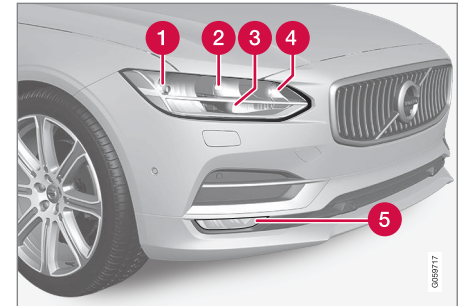

- 1 Dipped beam
- 2 Main beam
- 3 Daytime running lights/position lamps
- 4 Indicator
- 5 Front fog lamps/cornering lights\* (LED<sup>10</sup>)

<sup>9</sup> An authorised Volvo workshop is recommended.

<sup>10</sup> LED (Light Emitting Diode)

◀ **Lamps, rear**

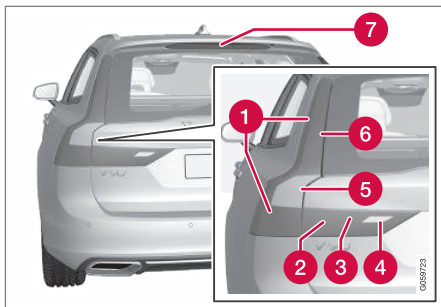

- 1 Position lamps (LED)
- 2 Position lamps (LED)
- 3 Fog lamp
- 4 Reversing lamp
- 5 Indicator<sup>11</sup>
- 6 Brake light (LED)
- 7 Brake light - central, high-level (LED)

**Related information**

- Replacing the dipped beam bulb (p. 522)
- Replacing the main beam lamp (p. 523)

- Replacing daytime running light bulb/position lamp bulb, front (p. 524)
- Replacing the front direction indicator bulb (p. 524)
- Replacing the reversing lamp bulb (p. 525)
- Replacing the rear fog lamp bulb (p. 526)
- Bulb specifications (p. 526)
- Ignition positions (p. 383)

**Replacing the dipped beam bulb**

The dipped beam bulb in halogen headlamps can be replaced by the driver.

Before the bulb can be replaced, the plastic cover over the headlamp must be removed; see the section "Bulb replacement".

**! IMPORTANT**

Never touch the glass part of the bulbs with your fingers. Grease from your fingers is vaporised by the heat, coating the reflector and then causing damage.

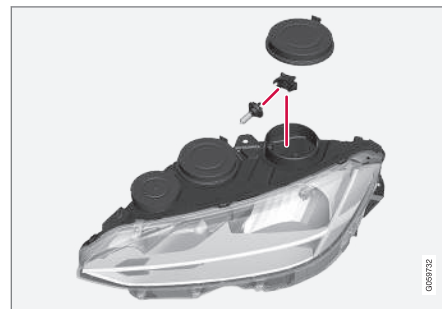

Left-hand headlamp.

1. Detach the headlamp's rubber cover for the dipped beam bulb.

<sup>11</sup> Contact a workshop for replacement - an authorised Volvo workshop is recommended.



2. Unplug the connector from the bulb.
3. Detach the bulb by pushing it gently upwards and pulling it straight out.
4. Fit a new bulb in the socket. The bulb's guide pin must be aimed straight upwards.
5. Press in the connector.
6. Refit the headlamp's rubber cover.

**Related information**

- Bulb replacement (p. 520)
- Bulb specifications (p. 526)

**Replacing the main beam lamp**

The main beam lamp in halogen headlamps can be replaced by the driver.

Before the bulb can be replaced, the plastic cover over the headlamp must be removed; see the section "Bulb replacement".

**! IMPORTANT**

Never touch the glass part of the bulbs with your fingers. Grease from your fingers is vaporized by the heat, coating the reflector and then causing damage.

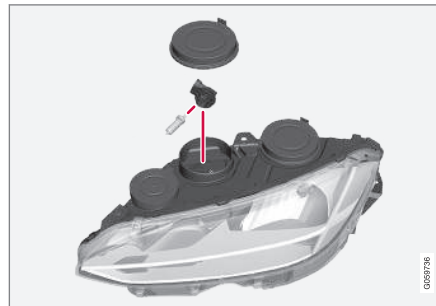

Left-hand headlamp.

1. Detach the headlamp's rubber cover for the main beam bulb.
2. Detach the bulb by turning the bulb holder upward and then pulling straight out.

3. Carefully prize the plastic cover at the connector's lock lug so that the lock lug releases.
4. Unplug the connector from the bulb.
5. Replace the bulb.
6. Fit the bulb in the socket and screw in.
7. Refit the headlamp's rubber cover.

**Related information**

- Bulb replacement (p. 520)
- Bulb specifications (p. 526)

## Replacing daytime running light bulb/position lamp bulb, front

The bulb for the daytime running light/position lamp in halogen headlamps can be replaced by the driver.

Before the bulb can be replaced, the plastic cover over the headlamp must be removed; see the section "Bulb replacement".

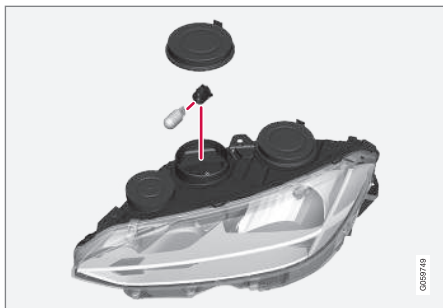

Left-hand headlamp.

1. Detach the headlamp's rubber cover for the daytime running light bulb/position lamp bulb.

### **i** NOTE

The bulb for the daytime running light/position lamp is easier to access if the main beam bulb is detached. The main beam bulb is fitted diagonally above the daytime running light bulb/position lamp bulb. Detach the main beam bulb by rotating its bulb holder upwards and then pulling straight out.

2. Pull the bulb holder for the daytime running light bulb/position lamp bulb straight out.
3. Detach the bulb by pulling it straight out.
4. Replace the bulb.
5. Fit the bulb holder into the socket and press it into place.
6. If the main beam bulb's bulb holder has been removed, fit it into the socket and screw in.
7. Refit the headlamp's rubber cover.

### Related information

- Bulb replacement (p. 520)
- Bulb specifications (p. 526)

## Replacing the front direction indicator bulb

The direction indicator bulb in halogen headlamps can be replaced by the driver.

Before the bulb can be replaced, the plastic cover over the headlamp must be removed; see the section "Bulb replacement".

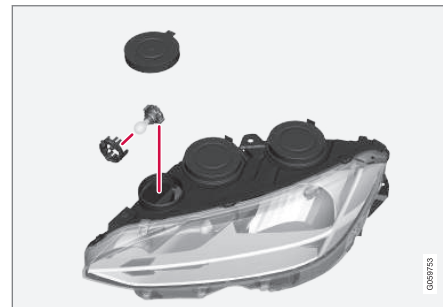

Left-hand headlamp.

1. Detach the headlamp's rubber cover for the indicator bulb.
2. Press the catches together and pull the bulb holder straight out.
3. Replace with a new bulb holder with bulb.
4. Fit the bulb holder into the socket and press it into place.
5. Refit the headlamp's rubber cover.

**Related information**

- Bulb replacement (p. 520)
- Bulb specifications (p. 526)

**Replacing the reversing lamp bulb**

The bulbs for the reversing lamp are located behind the panel in the tailgate.



1. Detach the panel on the inside of the tailgate by first turning the two knobs a quarter turn anticlockwise and then unhooking the panel. Place the panel to one side.

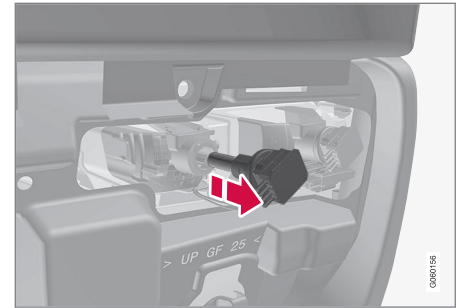

Lamp housing on left-hand side.

2. Undo the bulb holder by turning it anticlockwise and pulling it out.
3. Remove the blown bulb by pressing it in and turning anticlockwise.
4. Fit a new bulb by pressing it in and turning it clockwise.
5. Attach the bulb holder by turning it clockwise.
6. Hook on the panel and turn the knobs a quarter turn clockwise.

**Related information**

- Bulb replacement (p. 520)
- Bulb specifications (p. 526)

## Replacing the rear fog lamp bulb

The bulb for the rear fog lamp is located behind a hatch in the tailgate panel.

Left-hand drive cars have the fog lamp on the left-hand side, right-hand drive cars on the right-hand side.

The rear fog lamp bulb is replaced as follows:



The tailgate's inner panel.

1. Detach the panel on the inside of the tailgate by first turning the two knobs a quarter turn anticlockwise. Then unhook the panel and place it to one side.

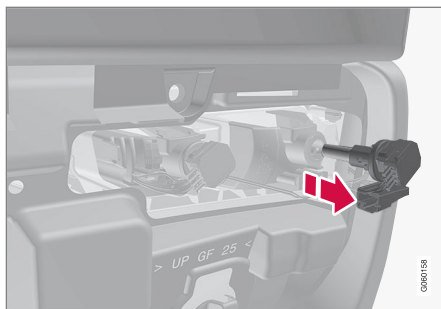

Lamp housing on left-hand side.

2. Undo the bulb holder by turning it a quarter turn anticlockwise and pulling it out.
3. Remove the blown bulb from the bulb holder by pressing it in and turning anticlockwise.
4. Fit a new bulb by pressing it in and turning it clockwise.
5. Wipe the bulb's lens clean of any dirt, grease or moisture.
6. Attach the bulb holder by turning it a quarter turn clockwise.
7. Refit the panel and lock it on by turning the knobs a quarter turn clockwise.

### Related information

- Bulb replacement (p. 520)
- Bulb specifications (p. 526)

## Bulb specifications

The specifications apply to bulbs in the halogen headlamps as well as the reversing lamp bulb and the rear fog lamp bulb. Contact a workshop<sup>12</sup> if faults occur in other lamps.

Function	W <sup>A</sup>	Type
Dipped beam	55	H7
Main beam	65	H9
Front direction indicators	24	PY24W
daytime running lights/ position lamps, front	21/5	W21/5W
Reversing lamp	21	H21W LL
Rear fog lamp	21	H21W LL

<sup>A</sup> Watt

### Related information

- Bulb replacement (p. 520)

<sup>12</sup> An authorised Volvo workshop is recommended.

## Wiper blades in service position

The windscreen wiper blades must be in service position when, for example, they are to be replaced.



Wiper blades in service position.

In order to change, clean or lift the wiper blades (e.g. for scraping off ice from the windscreen) they must be in service position.

### **!** IMPORTANT

Before placing the wiper blades in the service position, make sure that they are not frozen down.

## Activating service position

Service mode cannot be activated when the car is stationary and the windscreen wipers are not

on. Service mode can be activated in two ways via the centre display:

### Via function view



Press the **Wiper Service Position** button. The light indicator in the button illuminates when the service position is activated. Upon activation, the wipers move to standing straight up.

### Via settings

1. Press **Settings** in the top view.
2. Press **My Car → Wipers**.
3. Select **Wiper Service Position**.
  - > The wipers move up to standing straight up.

## Deactivating service position

Service mode can be deactivated in two ways via the centre display:

### Via function view



Press the **Wiper Service Position** button in the centre display. The light indicator in the button extinguishes when the service position is deactivated.

### Via settings

1. Press **Settings** in the top view in the centre display.
2. Press **My Car → Wipers**.
3. Deselect **Wiper Service Position** to deactivate service position.

The wiper blades also exit service position if:

- Windscreen wiping is activated.
- Windscreen washing is activated.
- Rain sensor activated.
- The car is driven away.

### **!** IMPORTANT

If the wiper arms in service position have been folded up from the windscreen, they must be folded back down onto the windscreen before the activation of wiping, washing or the rain sensor, as well as before driving. This is to avoid scraping the paint on the bonnet.

## Related information

- Replacing a wiper blade (p. 528)
- Filling washer fluid (p. 529)
- Overview of the centre display (p. 33)
- Windscreen and headlamp washers (p. 150)

## Replacing a wiper blade

The wiper blades sweep water away from the windscreen and rear window. Together with the washer fluid they clean the windows and ensure visibility for driving. Windscreen and rear window wiper blades can be replaced.

### Replacing a windscreen wiper blade

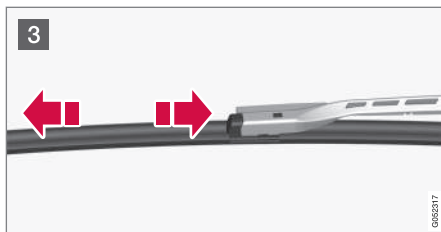
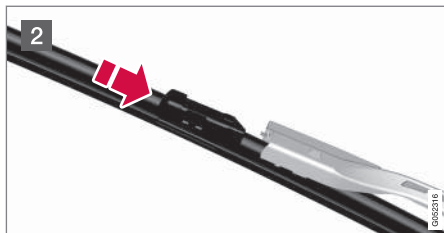
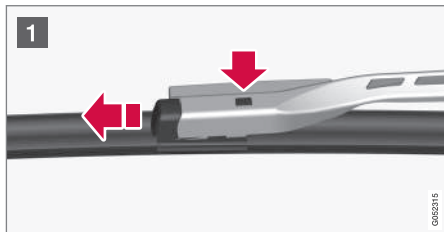

- 1 Fold up the wiper arm when it is in service position. Press the button located on the wiper blade mounting and pull straight out parallel with the wiper arm.
- 2 Slide in the new wiper blade until a "click" is heard.
- 3 Check that the blade is firmly installed.
4. Fold the wiper arm back towards the windscreen.

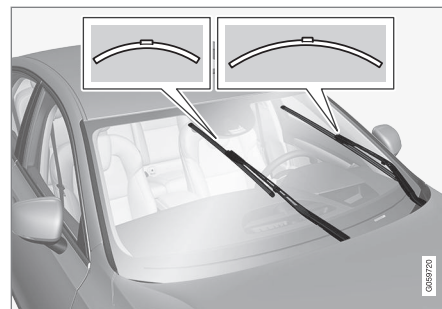

The wiper blades are different lengths.

#### **i** NOTE

The wiper blades are different lengths. The blade on the driver's side is longer than on the passenger side.

### Replacing the wiper blade, rear window

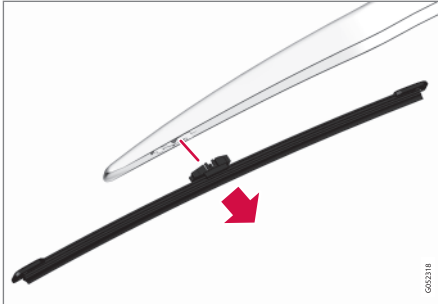

1. Fold out the wiper arm.
2. Grip the inner section of the blade (by the arrow).
3. Turn anticlockwise to use the blade's end position against the wiper arm as a lever to detach the blade more easily.
4. Press the new wiper blade into place. You should hear a click. Check that it is firmly installed.
5. Lower the wiper arm.

#### **!** IMPORTANT

Check the blades regularly. Neglected maintenance shortens the service life of the wiper blades.

### Related information

- Wiper blades in service position (p. 527)
- Cleaning the exterior (p. 549)

### Filling washer fluid

Washer fluid is used for cleaning the headlamps as well as the windscreen and rear window. Washer fluid with antifreeze must be used when the temperature is under the freezing point.

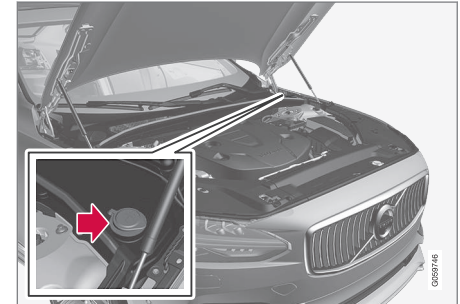

Filling of washer fluid takes place in the reservoir with a blue cap.

#### **i** NOTE

When approx. 1 litre of washer fluid remains in the reservoir the message **Washer fluid Level low, refill** is shown in the driver display together with the symbol .

**Prescribed grade:** Washer fluid recommended by Volvo - with frost protection during cold weather and below freezing point.



**! IMPORTANT**

Use Volvo genuine washer fluid or equivalent with a recommended pH of between 6 and 8, in working dilution (e.g. 1:1 with neutral water).

**! IMPORTANT**

Use washer fluid with antifreeze when the temperature is below freezing to avoid freezing in the pump, reservoir and hoses.

**Volume:**

- Cars **with** headlamp washing: 5.5 litres.
- Cars **without** headlamp washing: 3.5 litres.

**Related information**

- Windscreen and headlamp washers (p. 150)
- Opening and closing the bonnet (p. 514)

**Starter battery**

The electrical system is single-pole and uses the chassis and engine casing as a conductor.

The starter battery is used to start up the electrical system and drive the starter motor as well as other electrical equipment in the car.

The starter battery should be replaced by a workshop<sup>13</sup>.

The car has a voltage-regulated AC alternator.

The starter battery is a 12 V AGM battery, designed for the carbon dioxide reducing functions, Start/Stop and regenerative charging, and to support the functionality of the car's different systems.

The service life and function of the starter battery is influenced by factors such as the number of starts, discharging, driving style, driving conditions, climatic conditions etc.

- Never disconnect the starter battery when the engine is running.
- Check that the cables to the starter battery are correctly connected and properly tightened.

**! WARNING**

- The battery can generate oxyhydrogen gas, which is highly explosive. A spark can be formed if a jump lead is connected incorrectly, and this can be enough for the battery to explode.
- The battery contains sulphuric acid, which can cause serious burns.
- If sulphuric acid comes into contact with eyes, skin or clothing, flush with large quantities of water. If acid splashes into the eyes - seek medical attention immediately.

When connecting an external starter battery or battery charger, use the car's charging points in the engine compartment. The battery terminals on the car's starter battery in the cargo area must **not** be used.

During charging, both the starter battery and the support battery are charged.

<sup>13</sup> An authorised Volvo workshop is recommended.



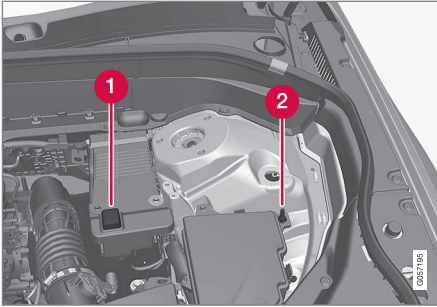

- 1 Positive charging point
- 2 Negative charging point

**!** **IMPORTANT**

When charging the starter battery and the support battery, only use a modern battery charger with controlled charging voltage. Fast charging function must not be used since it may damage the battery.

**!** **IMPORTANT**

If the following instruction is not observed then the energy saving function for infotainment may be temporarily disengaged, and/or the message in the driver display about the starter battery's state of charge may be temporarily inapplicable, following the connection of an external starter battery or battery charger:

- The negative battery terminal on the car's starter battery must **never** be used for connecting an external starter battery or battery charger - only the **car's negative charging point** may be used as the grounding point.

**i** **NOTE**

The life of the battery is shortened if it becomes discharged repeatedly.

The life of the battery is affected by several factors, including driving conditions and climate. Battery starting capacity decreases gradually with time and therefore needs to be recharged if the car is not used for a longer time or when it is only driven short distances. Extreme cold further limits starting capacity.

To maintain the battery in good condition, at least 15 minutes of driving/week is recommended or that the battery is connected to a battery charger with automatic trickle charging.

A battery that is kept fully charged has a maximum service life.

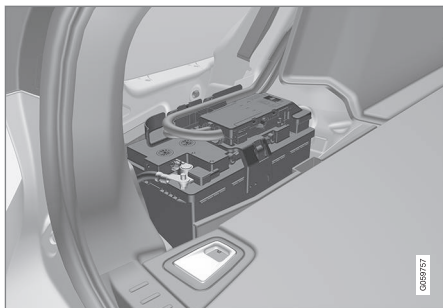

The starter battery is located in the cargo area.

The following table shows specifications for the starter battery.

	<b>Battery H7 AGM</b>
Voltage (V)	12
Cold start capacity <sup>A</sup> - CCA <sup>B</sup> (A)	800
Size , LxWxH (mm)	315x175x190
Capacity (Ah)	80

<sup>A</sup> According to EN standard.

<sup>B</sup> Cold Cranking Amperes.

**!** **IMPORTANT**

Make sure the retaining strap is properly tightened.

Volvo recommends entrusting battery replacement to an authorised Volvo workshop.

**!** **IMPORTANT**

When replacing the starter battery or support battery, a battery of AGM<sup>14</sup> type must be fitted.

**!** **IMPORTANT**

If the starter battery is replaced, make sure you replace it with a battery with the same cold starting capacity and type as the original battery (see the label on the battery).

**i** **NOTE**

The starter battery's container size must be consistent with the dimensions for the original battery.

- Using jump starting with another battery (p. 386)





**Related information**

- Symbols on the batteries (p. 533)
- Support battery (p. 533)

<sup>14</sup> Absorbed Glass Mat.

## Symbols on the batteries

There are information and warning symbols on the batteries.

	Use protective goggles.
	Further information in the owner's manual for the car.
	Store the battery out of the reach of children.
	The battery contains corrosive acid.

	Avoid sparks and naked flames.
	Risk of explosion.
	Must be taken for recycling.

### NOTE

An expended starter battery or support battery must be recycled in an environmentally safe manner since it contains lead.

### Related information

- Starter battery (p. 530)
- Support battery (p. 533)

## Support battery

Cars with Start/Stop function, in addition to the starter battery, are equipped with a support battery.

Cars with the Start/Stop function are equipped with two 12 V batteries - one extra powerful starter battery for starting and one support battery that helps during the Start/Stop function's starting sequence.



The support battery is located in a box next to the strut tower.

The following table shows specifications for the support battery.

Voltage (V)	12
Cold start capacity <sup>A</sup> - CCA <sup>B</sup> (A)	170





Size , LxWxH (mm)	150x90x130
Capacity (Ah)	10

<sup>A</sup> According to EN standard.

<sup>B</sup> Cold Cranking Amperes.

**! IMPORTANT**

When replacing the starter battery or support battery, a battery of AGM<sup>15</sup> type must be fitted.

**i NOTE**

- The higher the current take-off in the car, the more the alternator must be working and the batteries charging = Increased fuel consumption.
- When the capacity of the starter battery has fallen below the lowest permissible level then the Start/Stop function is disengaged.

Temporarily reduced Start/Stop function due to high current take-off means:

- The engine starts automatically<sup>16</sup> without the driver depressing the clutch pedal (manual gearbox).
- The engine starts automatically without the driver lifting his/her foot off the foot brake pedal (automatic gearbox).

The support battery normally requires no more service than the normal starter battery. A workshop should be contacted in the event of questions or problems - an authorised Volvo workshop is recommended.

**! IMPORTANT**

If the following instruction is not observed then the Start/Stop function may temporarily cease to work after the connection of an external starter battery or battery charger:

- The negative battery terminal on the car's starter battery must **never** be used for connecting an external starter battery or battery charger - only the **car's negative charging point** may be used as the grounding point.

**i NOTE**

If the starter battery has been discharged so much that the car has no normal electrical functions and the engine is then jump-started with an external battery or a battery charger, the Start/Stop function will continue to be activated. If the Start/Stop function then auto-stops the engine shortly after, there is a great risk that engine auto-start will fail due to insufficient battery capacity, because the battery has not had the opportunity to recharge.

If the car has been jump-started, or if there is insufficient time to charge the battery with a battery charger, the recommendation is to temporarily deactivate the Start/Stop function until the battery has been recharged by the car. In an outside temperature of +15 °C, the battery needs to be charged for at least 1 hour by the car. In a lower outside temperature, the charging time may increase to 3-4 hours. The recommendation is to charge the battery using an external battery charger.

**Related information**

- Starter battery (p. 530)
- Start/Stop (p. 394)

<sup>15</sup> Absorbed Glass Mat.

<sup>16</sup> Automatic starting can only take place if the gear lever is in neutral position.

- Using jump starting with another battery (p. 386)
- Symbols on the batteries (p. 533)

## Fuses

All electrical functions and components are protected by a number of fuses in order to protect the car's electrical system from damage by short circuiting or overloading.

If an electrical component or function does not work, it may be because the component's fuse was temporarily overloaded and failed. If the same fuse fails repeatedly then there is a fault in the circuit. Volvo recommends contacting an authorised Volvo workshop for checking.

### Location of central electrical units

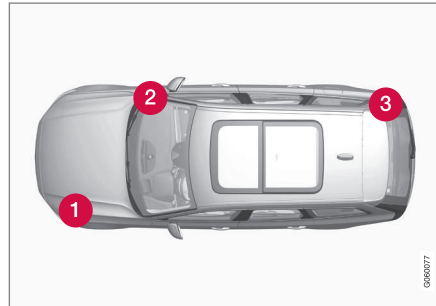

Central electrical unit locations in a left-hand drive car. In a right-hand drive car the central electrical units under the glovebox change sides.

- ① Engine compartment
- ② Under the glovebox

- ③ Cargo area

### Related information

- Replacing a fuse (p. 536)

## Replacing a fuse

All electrical functions and components are protected by a number of fuses in order to protect the car's electrical system from damage by short circuiting or overloading.

### Changing

1. Look in the fuse diagram to locate the fuse.
2. Pull out the fuse and check from the side to see whether the curved wire has blown.
3. If this is the case, replace it with a new fuse of the same colour and amperage.

### **WARNING**

Never use a foreign object or a fuse with an amperage higher than that specified when replacing a fuse. This could cause significant damage to the electrical system and possibly lead to fire.

### Related information

- Fuses (p. 535)
- Fuses in engine compartment (p. 537)
- Fuses under glovebox (p. 542)
- Fuses in cargo area (p. 546)

## Fuses in engine compartment

Fuses in the engine compartment protect engine and brake functions, amongst other things.

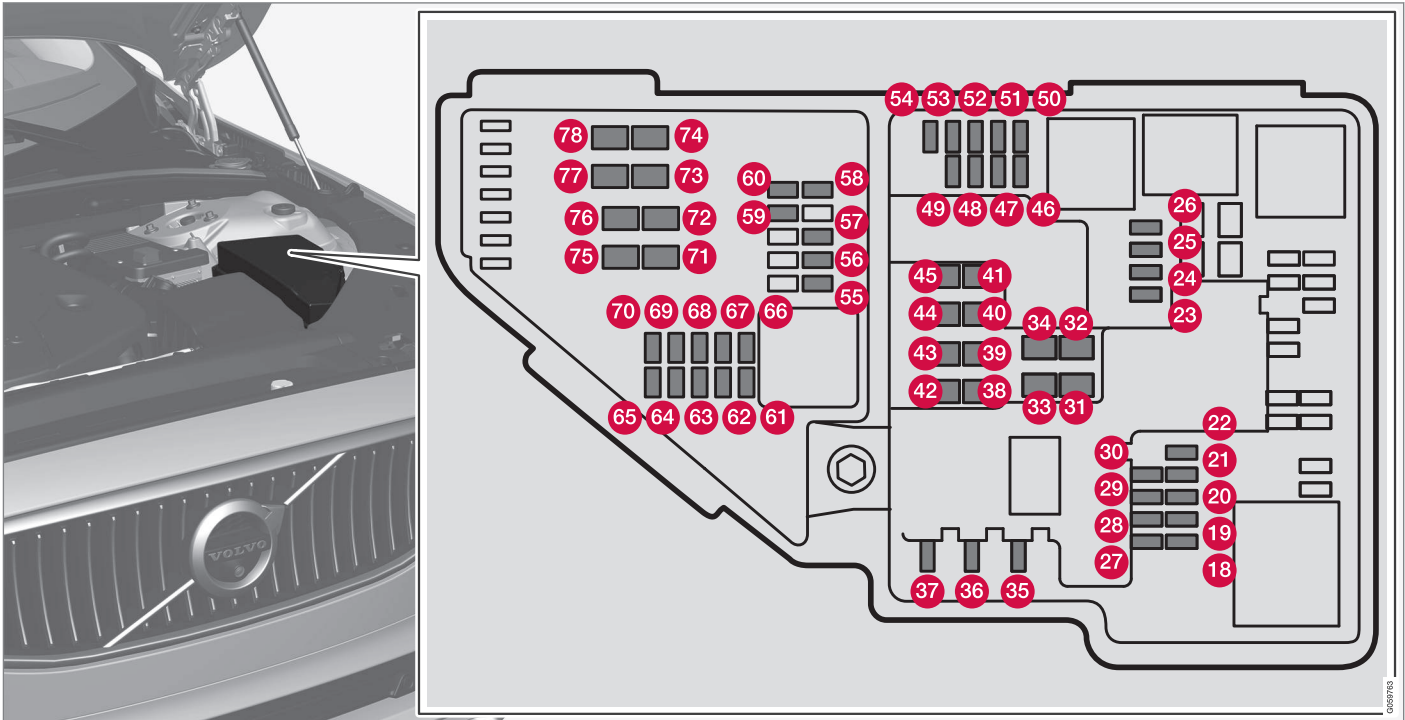

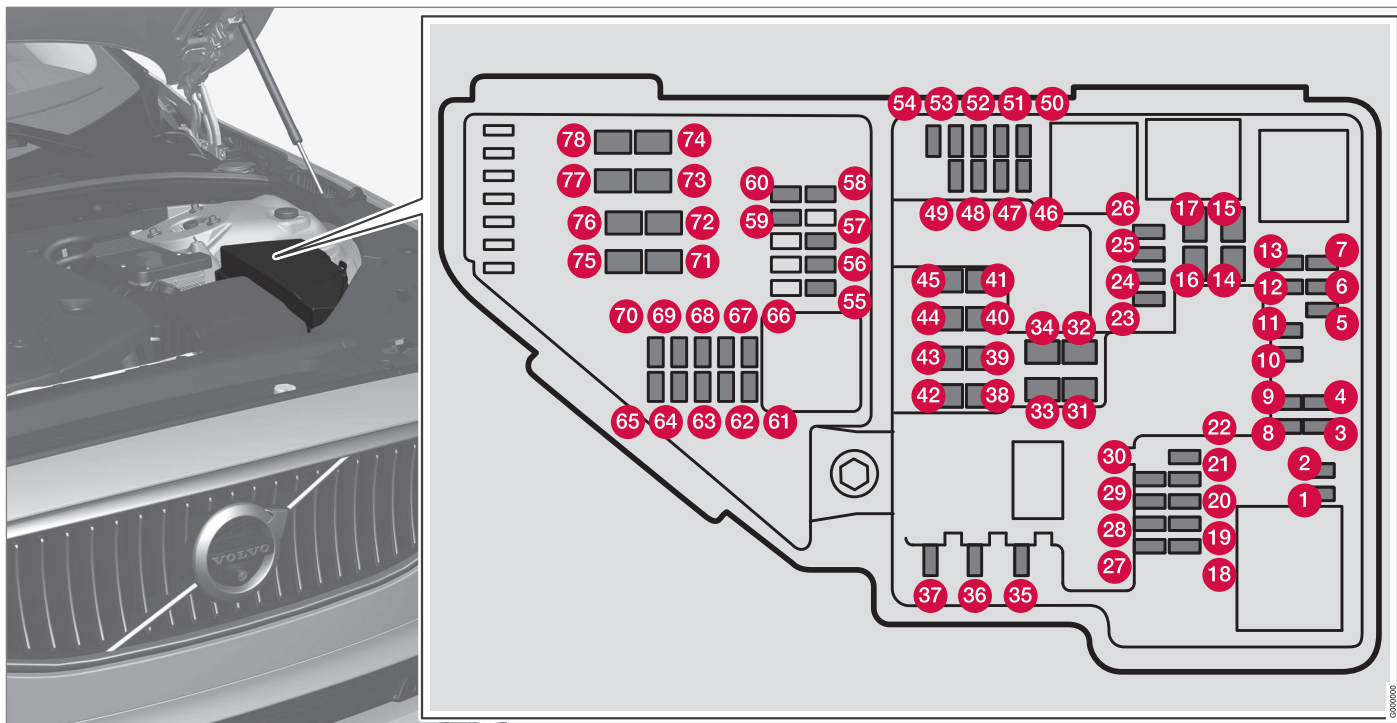

Applies to the Bi-Fuel model variant\*<sup>B</sup>

On the inside of the cover there are tweezers that facilitate the procedure for the removal and fitting of fuses.

The fuse box also provides space for several spare fuses.

**Positions**

On the inside of the cover is a label that shows the location of the fuses.



- Fuses 18-30, 35-37, 46-54 and 55-70 are of the "Micro" type.
- Fuses 31-34, 38-45 and 71-78 are of the "MCase" type and should be replaced by a workshop<sup>17</sup>.

	Function	A <sup>A</sup>
1	-	-
2	-	-
3	-	-
4	-	-
5	-	-
6	-	-
7	-	-
8	-	-
9	-	-
10	-	-
11	-	-
12	Heating of lambda probe* <sup>B</sup> ; Control module for vehicle gas* <sup>B</sup>	15* <sup>B</sup>

	Function	A <sup>A</sup>
13	-	-
14	-	-
15	-	-
16	-	-
17	-	-
18	-	-
19	-	-
20	-	-
21	-	-
22	-	-
23	USB port in tunnel console, front*	5
24	12 V socket in tunnel console, front	15
25	12 V socket in tunnel console, by legroom for second seat row	15
26	12 V socket in cargo area*	15
27	-	-

	Function	A <sup>A</sup>
28	Left-hand headlamp, certain variants of LED <sup>C</sup>	15
29	Right-hand headlamp, certain variants of LED <sup>C</sup>	15
30	-	-
31	Heated windscreen* left-hand side	Shunt
32	Heated windscreen* left-hand side	40
33	Headlamp washers*	25
34	Windscreen washers	25
35	-	-
36	Horn	20
37	Siren*	5
38	Control module for brake system (valves, parking brake)	40
39	Windscreen wipers	30
40	Rear window washer	25

<sup>17</sup> An authorised Volvo workshop is recommended.





	Function	A <sup>A</sup>
41	Heated windscreen* right-hand side	40
42	Parking heater*	20
43	Control unit for brake system (ABS pump)	40
44	-	-
45	Heated windscreen* right-hand side	Shunt
46	Supplied when the ignition is switched on: Engine control module; Transmission components; Electric steering servo; Central electronic module; Control module for brake system	5
47	-	-
48	Right-hand headlamp	7.5
	Right-hand headlamp, certain variants of LED <sup>C</sup>	15
49	-	-
50	-	-
51	Module for controlling battery engagement	5

	Function	A <sup>A</sup>
52	Airbags	5
53	Left-hand headlamp	7.5
	Left-hand headlamp, certain variants of LED <sup>C</sup>	15
54	Accelerator pedal sensor	5
55	Transmission control module	15
56	Engine Control Module (ECM)	5
57	-	-
58	-	-
59	-	-
60	-	-
61	Engine control module; Actuator; Throttle unit; EGR valve (diesel); Position sensor for turbo (diesel); Valve for turbocharger (petrol)	20
62	Solenoids (petrol); Valve; Thermostat for engine cooling system (petrol); EGR cooling pump (diesel); Glow control module (diesel)	10

	Function	A <sup>A</sup>
63	Vacuum regulators; Valve; Valve for output pulse (diesel)	7.5
64	Control module for spoiler roller cover; Control module for radiator roller cover; Relay coils for output pulse (diesel)	5
65	-	-
66	Lambda-sond, front; Lambda-sond, rear (petrol)	15
67	Solenoid for engine oil pump; Solenoid clutch A/C; Lambda sond, centre (petrol); Lambda sond, rear (diesel)	15
	-	-
68	-	-
69	Engine Control Module (ECM)	20
70	Ignition coils (petrol); Spark plugs (petrol)	15
71	Control module for vehicle gas* <sup>B</sup>	15* <sup>B</sup>
	Fuel filter heater (diesel)	30
72	-	-
73	-	-
74	-	-

	Function	A <sup>A</sup>
75	-	-
76	-	-
77	Starter motor	Shunt
78	Starter motor	40

A Ampere

B Applies to the Bi-Fuel model variant.

C LED (Light Emitting Diode)

### Related information

- Replacing a fuse (p. 536)
- Fuses under glovebox (p. 542)
- Fuses in cargo area (p. 546)

### **Fuses under glovebox**

Fuses under the glovebox protect, amongst other things, the 230 V socket, displays and door modules.

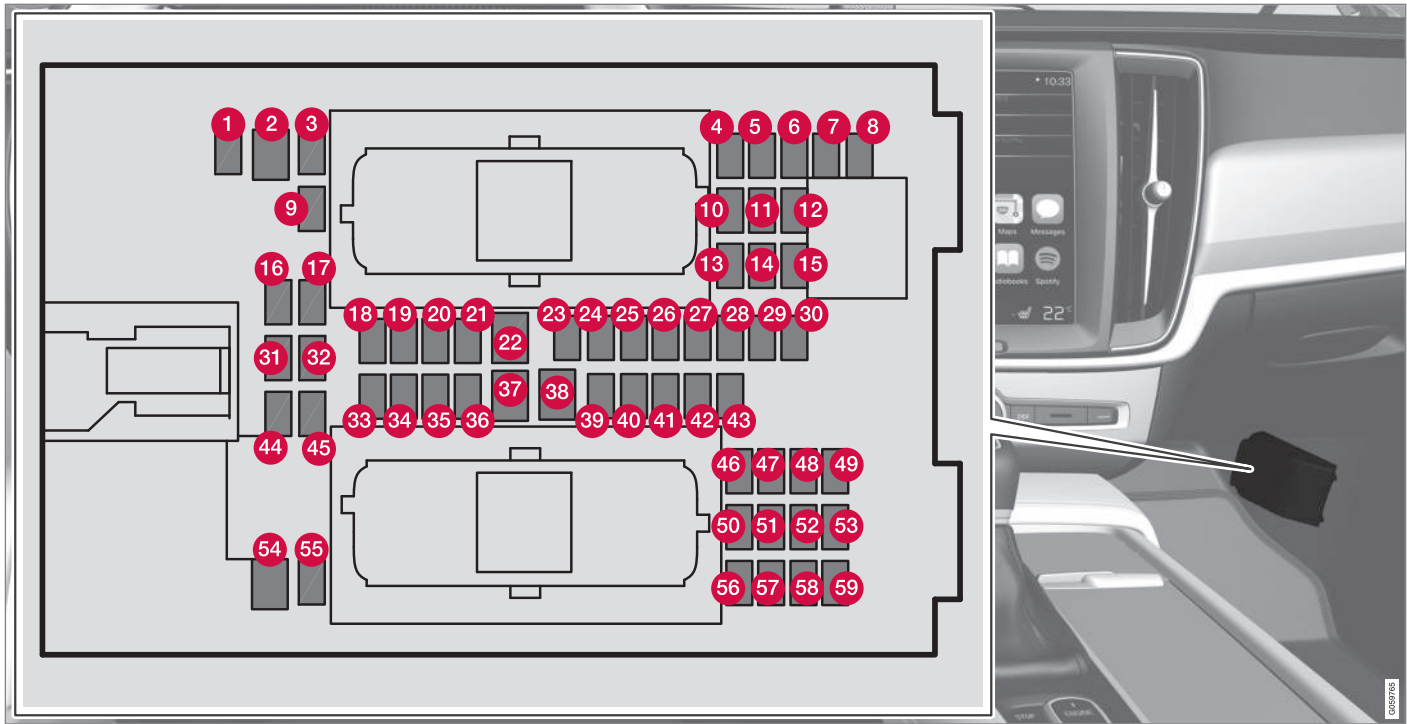

On the inside of the cover there are tweezers that facilitate the procedure for the removal and fitting of fuses.

The **fuse box in the engine compartment** also provides space for several spare fuses.



◀ **Positions**

- Fuses 1, 3-21, 23-36, 39-53 and 55-59 are of the "Micro" type.
- Fuses 2, 22, 37-38 and 54 are of the "MCCase" type and should be replaced by a workshop<sup>18</sup>.

	Function	A <sup>A</sup>
1	-	-
2	230 V socket in tunnel console, by legroom for rear seat*	30
3	-	-
4	Movement detector*	5
5	Media player	5
6	Driver display	5
7	Keypad in centre console	5
8	Sun sensor	5
9	-	-
10	-	-
11	Steering wheel module	5

	Function	A <sup>A</sup>
12	Module for start knob and for parking brake control	5
13	Steering wheel module for heated steering wheel*	15
14	-	-
15	-	-
16	-	-
17	-	-
18	Control module for climate control system	10
19	Steering lock	7.5
20	Diagnostic socket OBDII	10
21	Centre display	5
22	Fan module for climate control system, front	40
23	-	-

	Function	A <sup>A</sup>
24	Controls lighting; Interior lighting; Dimming of interior rearview mirror*; Rain and light sensor*; Keypad in tunnel console, by legroom for rear seat*; Power front seats*; Control panels in rear doors	7.5
25	Control module for driver support functions	5
26	Panorama roof with sun blind*	20
27	Head-up display*	5
28	Passenger compartment lighting	5
29	-	-
30	Display in roof console (Seatbelt reminder/Indicator for airbag on the front passenger seat)	5
31	-	-
32	Humidity sensor	5
33	Door module in right-hand rear door	20
34	Fuses in cargo area	10

<sup>18</sup> An authorised Volvo workshop is recommended.

	Function	A <sup>A</sup>
35	Control module for Internet-connected car; Control module for telematics	5
36	Door module in left-hand rear door	20
37	Audio control module (amplifier) (certain variants)	40
38	-	-
39	Module for multi-band antenna	5
40	Modules for seat comfort (massage) front*	5
41	-	-
42	Rear window wiper	15
43	Control module for fuel pump	15
44	-	-
45	-	-
46	Seat heating, driver's side front	15
47	Seat heating, passenger side front	15
48	Coolant pump	10
49	-	-

	Function	A <sup>A</sup>
50	Door module in left-hand front door	20
51	Control module for suspension (active chassis)*	20
52	-	-
53	Sensus control module	10
54	-	-
55	-	-
56	Door module in right-hand front door	20
57	-	-
58	TV* (certain markets)	5
59	Primary fuse for fuses 53 and 58	15

<sup>A</sup> Ampere

### Related information

- Replacing a fuse (p. 536)
- Fuses in engine compartment (p. 537)
- Fuses in cargo area (p. 546)

### **Fuses in cargo area**

Fuses in the cargo area protect, amongst other things, power seats\*, airbags and seatbelt tensioners.



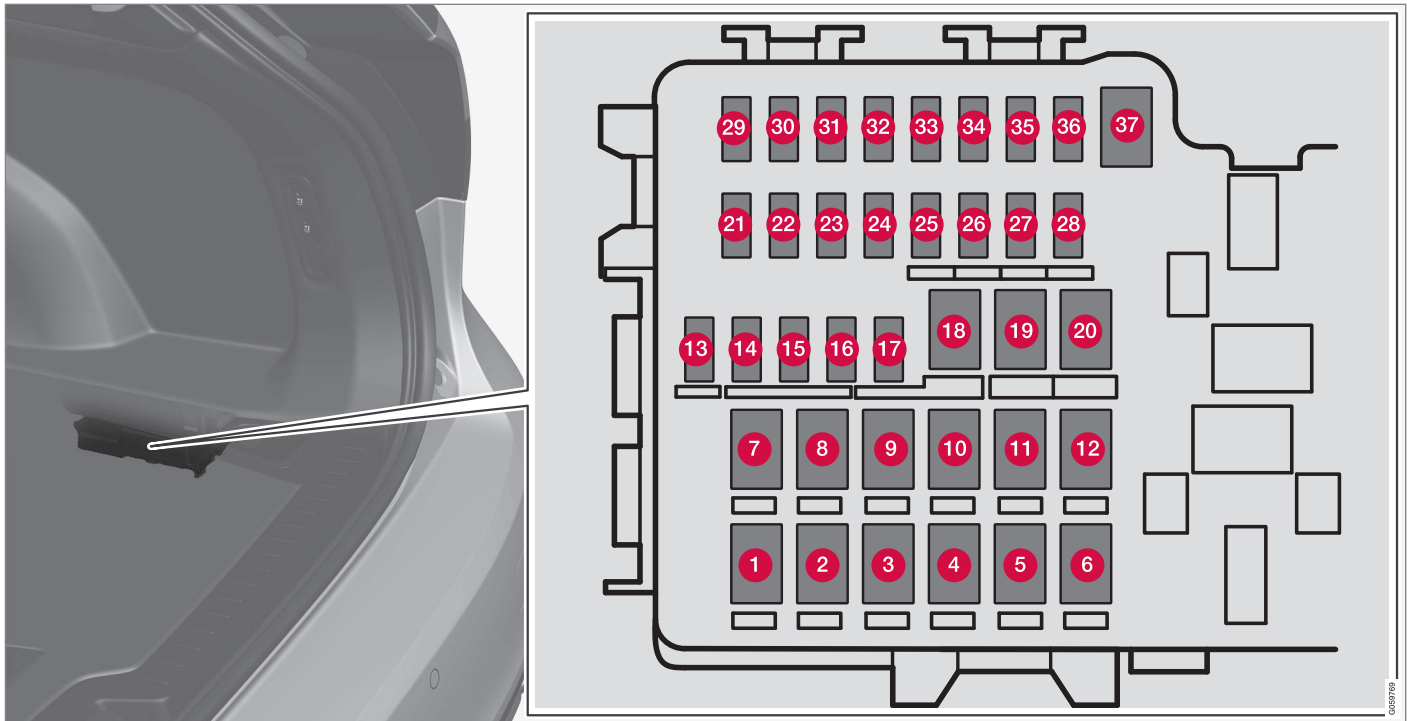

The central electrical unit is located on the right-hand side.

On the inside of the cover there are tweezers that facilitate the procedure for the removal and fitting of fuses.

The **fuse box in the engine compartment** also provides space for several spare fuses.



◀ **Positions**

- Fuses 13-17 and 21-36 are of the "Micro" type.
- Fuses 1-12, 18-20 and 37 are of the "MCCase" type and should be replaced by a workshop<sup>19</sup>.

	Function	A <sup>A</sup>
1	Rear window defroster	30
2	-	-
3	Compressor for air suspension*	40
4	Lock motor for backrest on rear right-hand side	15
5	-	-
6	Lock motor for backrest on rear left-hand side	15
7	-	-
8	-	-
9	Power operated tailgate*	25
10	Electrically operated front passenger seat*	20
11	Towbar control module*	40

	Function	A <sup>A</sup>
12	Seatbelt pretensioner module, right-hand side	40
13	Internal relay coils	5
14	-	-
15	Module for detecting foot movement* (for opening the power operated tailgate)	5
16	-	-
17	-	-
18	Towbar control module*	25
19	Power driver seat*	20
20	Seatbelt pretensioner module, left-hand side	40
21	Parking camera*	5
22	-	-
23	-	-
24	-	-
25	-	-

	Function	A <sup>A</sup>
26	Control module for airbags and seatbelt tensioners	5
27	-	-
28	Seat heating left-hand side rear*	15
29	-	-
30	Blind Spot Information (BLIS)*	5
31	-	-
32	Seatbelt pretensioner modules	5
33	Actuator for exhaust gases (petrol, certain engine variants)	5
34	-	-
35	AWD control module*	15
36	Seat heating right-hand side rear*	15
37	-	-

A Ampere

**Related information**

- Replacing a fuse (p. 536)
- Fuses under glovebox (p. 542)
- Fuses in engine compartment (p. 537)

<sup>19</sup> An authorised Volvo workshop is recommended.

## Cleaning the exterior

The car should be washed as soon as it becomes dirty. This means that the car is easier to clean since the dirt does not attach as firmly. It also reduces the risk of scratches and keeps the car fresh. Wash the car in a car wash with oil separator. Use car shampoo.

### Handwashing

- Remove bird droppings from the paintwork as soon as possible. Bird droppings contain chemicals that affect and discolour paintwork very quickly. For example, use soft paper or sponge soaked in plenty of water. An authorised Volvo workshop is recommended for the removal of any discoloration.
- Hose down the underbody.
- Rinse the entire car until the dissolved dirt has been removed so as to reduce the risk of scratches from washing. Do not spray directly onto the locks.
- If necessary, use cold degreasing agent on very dirty surfaces. Note that in this case, the surfaces must not be hot from the sun.
- Wash using a sponge, car shampoo and plenty of lukewarm water.
- Clean the wiper blades with a lukewarm soap solution or car shampoo.
- Dry the car using a clean, soft chamois or a water scraper. If you avoid allowing drops of water to dry in strong sunlight, you reduce

the risk of water drying stains which may need to be polished out.

### WARNING

Always have the engine cleaned by a workshop. There is a risk of fire if the engine is hot.

### IMPORTANT

Dirty headlamps have impaired functionality. Clean them regularly, e.g. when refuelling.

Do not use any corrosive cleaning agents but use water and a non-scratching sponge instead.

### NOTE

Outside lighting such as headlamps and rear lamps may temporarily have condensation on the inside of the lens. This is normal, all exterior lighting is designed to withstand this. Condensation is normally vented out of the lamp housing when the lamp has been switched on for a time.

### Automatic car wash

An automatic car wash is a simple and quick way of washing the car, but it cannot reach everywhere. Washing the car by hand is recommended to achieve a good result, or to supplement automatic car washes with washing by hand.

### NOTE

The car must only be washed by hand over the first few months. This is because the paint is more delicate when it is new.

### IMPORTANT

Before driving the car into an automatic car wash, deactivate the functions for Automatic braking when stationary (Auto Hold) and Automatic application of parking brake. If these functions are not deactivated, the brake system will jam when the car is stationary and the car will not be able to move.

In car washes where the car is towed through with rolling wheels, the following applies:

1. Drive into the automatic car wash.
2. Deactivate the function for automatic braking when stationary (Auto Hold) using the switch in the tunnel console.
3. Deactivate the function for automatic application of parking brake via the centre display.
4. Move the gear lever to position **N**.



- 5. Switch off the engine by turning the start knob in the tunnel console to **STOP**. Hold the knob in **STOP** position for at least 4 seconds.
  - > The car is ready for the automatic car wash.

**! IMPORTANT**

The system will automatically switch to **P** mode unless the above step is followed. The wheels are locked in **P** mode, which they should not be when putting the car through an automatic car wash.

**High-pressure washing**

When using high-pressure washing, use sweeping movements and make sure that the nozzle does not come closer than 30 cm to the surface of the car. Do not spray directly onto the locks.

**Testing the brakes**

Lightly depress the brake pedal now and then when driving long distances in rain or slush. The heat from the friction causes the brake linings to warm up and dry. Do the same thing after starting in very damp or cold weather.

**! WARNING**

Always test the brakes after washing the car, including the parking brake, to ensure that moisture and corrosion do not attack the brake linings and reduce braking performance.

**Wiper blades**

Asphalt, dust and salt residue on wiper blades, as well as insects, ice etc. on the windscreen, impair the service life of wiper blades.

When cleaning, set the wiper blades in service position.

**i NOTE**

Wash the wiper blades and windscreen regularly with lukewarm soap solution or car shampoo. Do not use any strong solvents.

**Exterior plastic, rubber and trim components**

A special cleaning agent available from Volvo dealers is recommended for the cleaning and care of coloured plastic parts, rubber and trim components, e.g. glossy trim mouldings. When using such a cleaning agent the instructions must be followed carefully.

The frames around the side windows, the car's roof rails and the door frames at the windows\* are produced in anodised aluminium. This means

that they should only be washed using a cleaning agent with a pH value between 3.5 and 11.5. This is in order to avoid discolouration.



Parts that should be washed using a cleaning agent with a pH value between 3.5 and 11.5.

**! IMPORTANT**

Avoid waxing and polishing on plastic and rubber.

When using degreasant on plastic and rubber, only rub with light pressure if it is necessary. Use a soft washing sponge.

Polishing glossy trim mouldings could wear away or damage the glossy surface layer.

Polishing agent that contains abrasive must not be used.

**! IMPORTANT**

Avoid washing the car with cleaning agent with a pH value lower than 3.5 or higher than 11.5. This may result in discolouration of anodised aluminium parts such as roof rack and around the side windows.

Never use metal polishing agent on anodised aluminium parts, this can result in discolouration and destroy the surface treatment.

**Rims**

Only use rim cleaning agent recommended by Volvo.

Strong rim cleaning agents can damage the surface and cause stains on chrome-plated aluminium rims.

**Related information**

- Polishing and waxing (p. 551)
- Wiper blades in service position (p. 527)
- Automatic braking when stationary (p. 410)
- Using the parking brake (p. 408)
- Gear positions for automatic gearbox (p. 388)

**Polishing and waxing**

Polish and wax the car if the paintwork is dull or to give the paintwork extra protection. The car does not need to be polished until it is at least one year old. However, the car can be waxed during this time. Do not polish or wax the car in direct sunlight.

Wash and dry the car thoroughly before you begin polishing or waxing. Clean off asphalt and tar stains using tar remover or white spirit. More stubborn stains can be removed using fine rubbing paste designed for car paintwork.

Polish first with a polish and then wax with liquid or solid wax. Follow the instructions on the packaging carefully. Many preparations contain both polish and wax.

**! IMPORTANT**

Avoid waxing and polishing on plastic and rubber.

When using degreasant on plastic and rubber, only rub with light pressure if it is necessary. Use a soft washing sponge.

Polishing glossy trim mouldings could wear away or damage the glossy surface layer.

Polishing agent that contains abrasive must not be used.

**! IMPORTANT**

Only paint treatment recommended by Volvo should be used. Other treatment such as preserving, sealing, protection, lustre sealing or similar could damage the paintwork. Paintwork damage caused by such treatments is not covered by Volvo warranty.

**Related information**

- Cleaning the exterior (p. 549)
- Paint damage (p. 554)

## Rustproofing

The car has effective protection against corrosion.

Anti-corrosion protection for the body consists of modern metallic protective coatings on the sheet metal, a high-quality painting process, corrosion-protected and minimised metal overlap, and shielding plastic components, abrasion protection and supplemental rust inhibitor in exposed areas. This combination guarantees that the body will remain free from corrosion problems over time. In the chassis, exposed components of the wheel suspension are made of corrosion-resistant cast aluminium.

## Inspection and maintenance

The car's anti-corrosion protection normally requires no maintenance, but a good way to further reduce the risk of corrosion is to keep the car clean. Strong alkaline or acidic cleaning solutions must always be avoided on glossy trim components. Any stone chips should be rectified as soon as they are discovered.

## Related information

- Cleaning the exterior (p. 549)
- Paint damage (p. 554)

## Cleaning the interior

Only use cleaning agents and car care products recommended by Volvo. Clean regularly and treat stains at once for best results. Vacuuming is important prior to using cleaning agents.

### IMPORTANT

- Certain items of coloured clothing (e.g. dark jeans and suede garments) may stain the upholstery. If this occurs, it is important to clean and treat these parts of the upholstery as soon as possible.
- Never use strong solvents such as washer fluid, pure petrol or white spirit to clean the interior, since this may damage the upholstery as well as other interior materials.
- Never spray the cleaning agent directly onto components that have electrical buttons and controls. Wipe them instead using a moistened cloth containing the cleaning agent.
- Sharp objects and Velcro may damage the fabric upholstery.

## Fabric upholstery and ceiling upholstery

Never scrape or rub a stain since this risks destroying the upholstery. Never use strong stain removers since this risks destroying the colour of the upholstery.

## Leather upholstery\*

Volvo's leather upholstery is treated to preserve its original appearance.

Leather upholstery is a natural product that changes and acquires a beautiful patina over time. Regular cleaning and treatment are required in order that the properties and colours of the leather shall be preserved. Volvo offers a comprehensive product, Volvo Leather Care Kit/Wipes, for the cleaning and treatment of leather upholstery which, when used in accordance with the instructions, preserves the leather's protective coating.

To achieve best results, Volvo recommends the cleaning and application of the protective cream once to four times per year (or more if required). The Volvo Leather Care Kit/Wipes is available from Volvo dealers.

## Leather steering wheel

Leather needs to breathe. Never cover the leather steering wheel with protective plastic. Volvo Leather Care Kit/Wipes is recommended for cleaning the leather steering wheel.

## Leather panel\*

Leather needs to breathe. Never cover the leather on the top of the instrument panel or at the door panel. Volvo Leather Care Kit/Wipes is recommended for cleaning the leather panels.

### Interior plastic, metal and wood parts

A fibrillated fibre or microfibre cloth, lightly moistened with water, available from Volvo dealers, is recommended for cleaning interior parts and surfaces.

Do not scrape or rub stains. Never use strong stain removers.

### Seatbelts

Use water and a synthetic detergent. A special textile cleaning agent is available from Volvo dealers. Ensure that the seatbelt is dry before allowing it to retract.

### Inlay mats and floor mat

Remove inlaid carpets for separate cleaning of the floor carpet and the inlaid carpets. Use a vacuum cleaner to remove dust and dirt. Each inlay mat is secured with pins.

Remove the inlay mat by taking hold of the inlay mat at each pin and lifting the mat straight up.

Fit the inlay mat in place by pressing it in at each pin.

### **⚠ WARNING**

Only use one inlaid mat at each seat, and check before setting off that the mat by the driver's seat is firmly affixed and secured in the pins so that it does not get caught adjacent to and under the pedals.

A special textile cleaner is recommended for stains on the floor mat after vacuuming. Floor mats should be cleaned with agents recommended by Volvo dealers.

### Related information

- Cleaning the centre display (p. 553)

### Cleaning the centre display

Dirt, stains and grease from fingers can affect the centre display's performance and readability. Clean the screen frequently with a microfibre cloth.



Home button for the centre display.

1. Turn off the centre display with a long press on the home button.
2. Wipe the screen with the microfibre cloth supplied or use another microfibre cloth of equivalent quality. The screen should be wiped with a clean and dry microfibre cloth with small circular movements. If necessary, lightly moisten the microfibre cloth with clean water.
3. Activate the display with a short press on the home button.





**! IMPORTANT**

The microfibre cloth used to clean the centre display must be free from sand and dirt.

**! IMPORTANT**

When cleaning the centre display, only use gentle pressure on the screen. Heavy pressure can damage the screen.

**! IMPORTANT**

Do not spray any liquid or caustic chemicals directly on the centre display. Do not use window cleaning agent, other cleaning agents, aerosol spray, solvents, alcohol, ammonia or cleaning agent containing abrasive.

Never use abrasive cloths, paper towels or tissue paper, these can scratch the centre display.

**Related information**

- Cleaning the interior (p. 552)
- Overview of the centre display (p. 33)

**Paint damage**

Paint is an important part of the car's rustproofing and should therefore be checked regularly. The most common types of paintwork damage are stone chips, scratches, and marks on the edges of wings, doors and bumpers.

**Colour code**

The colour code label is located on the car's door pillar and becomes visible when the right-hand rear door is opened.

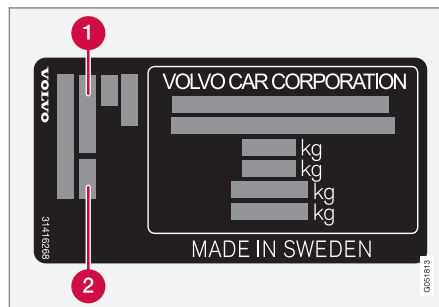

- 1** Exterior colour code
- 2** Any secondary exterior colour code

It is important that the correct colour is used.

**Touching up minor paintwork damage**

To avoid the onset of rust, damaged paintwork should be rectified immediately.

**Materials that may be needed**

- Primer<sup>20</sup> - a special adhesive primer in a spray can is available for e.g. plastic-coated bumpers.
- Basecoat and clearcoat - available in spray cans or as touch-up pens/sticks<sup>21</sup>.
- Masking tape.
- fine sand paper<sup>20</sup>.

**Related information**

- Repairing paint damage (p. 555)
- Type designations (p. 558)
- Rustproofing (p. 552)

<sup>20</sup> If required.

<sup>21</sup> Follow the instructions that are included with the package for the touch-up pen/stick.



## Repairing paint damage

When repairing paint damage, the car must be clean, dry and have a temperature of over 15 °C.

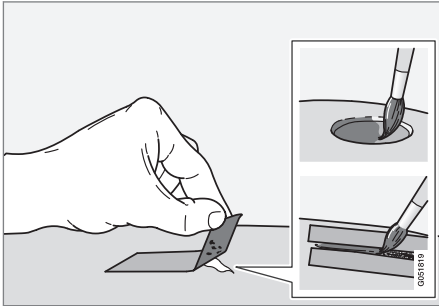

1. Apply a piece of masking tape over the damaged surface. Then remove the tape to remove any loose paint.

If the damage is down to the metal, use of a primer is appropriate. In the event of damage to a plastic surface, an adhesive primer should be used to give better results - spray into the lid of the spray can and brush on thinly.

2. Before painting, if necessary, e.g if sharp edges are found around the damage, a light sanding with a very fine sand paper can be done locally. The surface is cleaned thoroughly and left to dry.

3. Stir the primer well and apply using a fine brush, a matchstick or similar. Finish off with a basecoat and clearcoat once the primer has dried.

For scratches, proceed as described above, but mask around the damaged area to protect the undamaged paintwork.

Touch-up pens and spray paints are available from Volvo dealers.

### **i** NOTE

If the stone chip has not penetrated down to the metal and an undamaged layer of paint remains in place, fill in with base coat and clear coat as soon as the surface has been cleaned.

### Related information

- Paint damage (p. 554)
- Cleaning the exterior (p. 549)



SPECIFICATIONS

## Type designations

Type designation, vehicle identification number, etc., i.e. information unique to the car, can be read on labels in the car.

### Label location

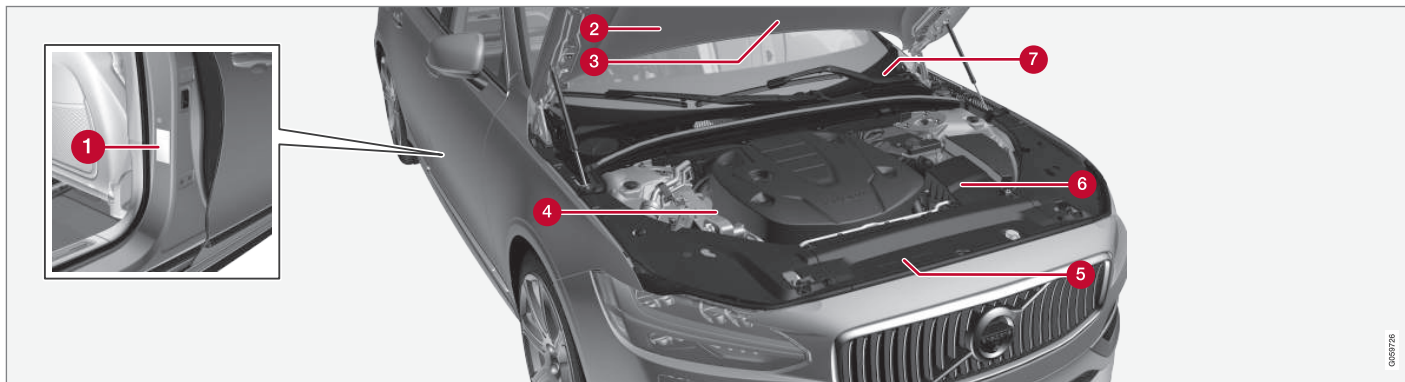

The illustration is schematic - details may vary depending on market and model.

Knowing the car's type designation, vehicle identification and engine numbers can facilitate all contact with an authorised Volvo dealer regarding the car and when ordering spare parts and accessories.

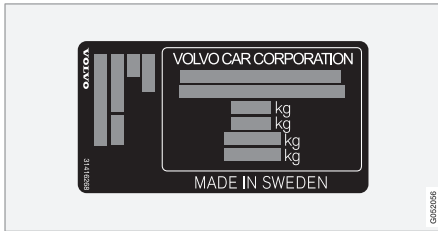

1 Decal for type designation, vehicle identification number, permissible maximum weights and code designation for exterior colour and type approval number. The decal is positioned on the door pillar, and will be visible when the right-hand rear door is opened.

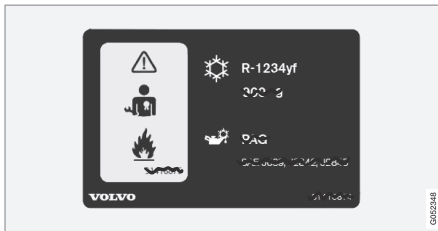

2 Decal A/C system for cars with refrigerant R1234yf.

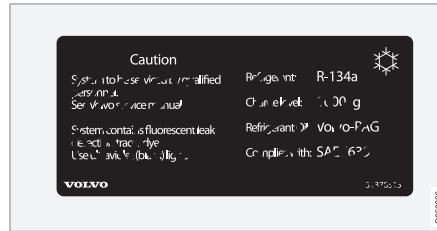

2 Decal A/C system for cars with refrigerant R134a.

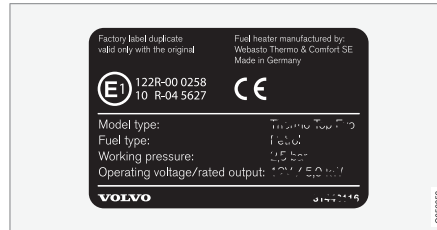

3 Label for parking heater.

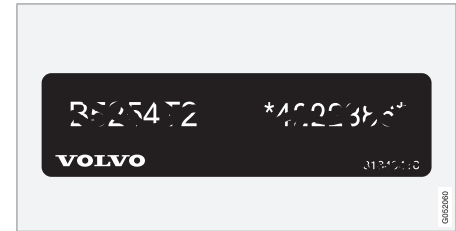

4 Decal for engine code and the engine's serial number.

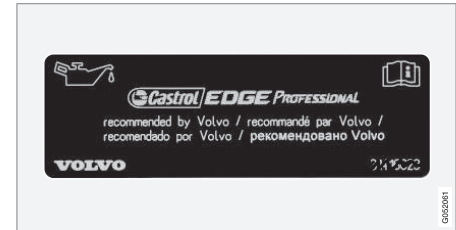

5 Label for engine oil.

## SPECIFICATIONS

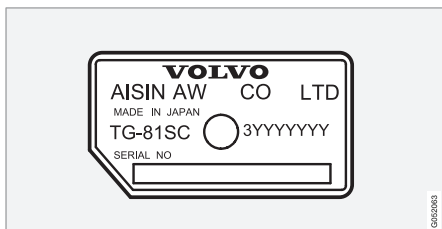

- 6** Decal for gearbox type designation and serial number.

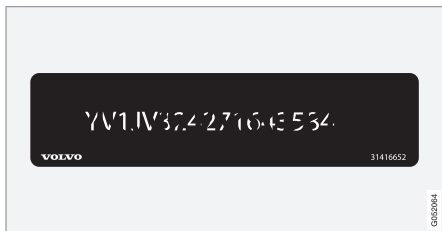

- 7** Decal for the car's identification number - VIN (Vehicle Identification Number).

Further information on the car is presented in the registration document.



### NOTE

It is not intended that the decals illustrated in the owner's manual should be exact replicas of those in the car. They are included to show their approximate appearance and locations in the car. The information that applies to your particular car can be found on the decal on the car.

### Related information

- Air conditioning — specifications (p. 571)

## Dimensions

Measurement of car length, height, etc. can be read in the table.

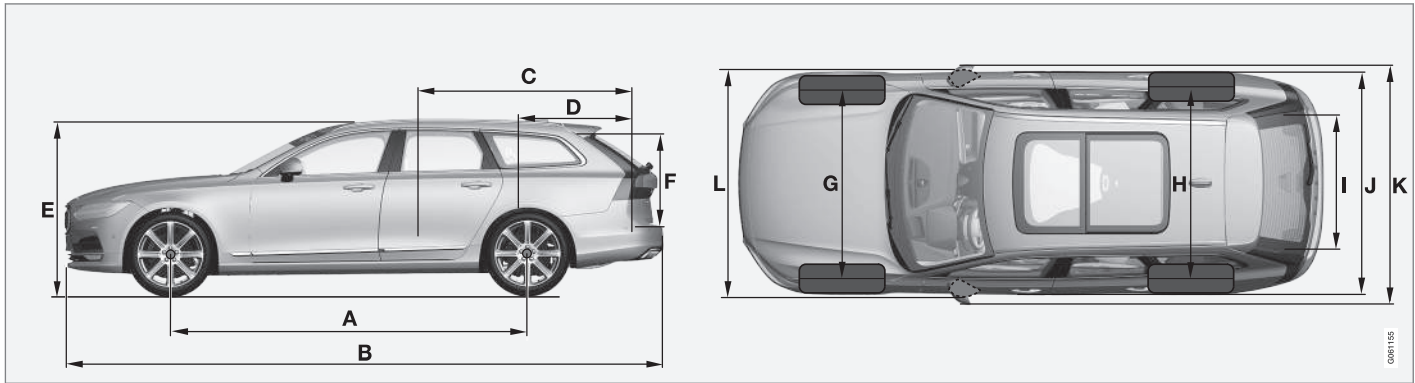

	Dimensions	mm
A	Wheelbase	2941
B	Length	4936
C	Load length, floor, folded seat	1988
D	Load length, floor	1153
E	Height	1475
F	Load height	704

	Dimensions	mm
G	Front track	1628 <sup>A</sup> 1618 <sup>B</sup> 1617 <sup>C</sup> 1623 <sup>D</sup>

	Dimensions	mm
H	Rear track	1629 <sup>A</sup> 1619 <sup>B</sup> 1618 <sup>C</sup> 1624 <sup>D</sup>
I	Load width, floor	1130
J	Width	1879 <sup>E</sup> 1890 <sup>F</sup>



## SPECIFICATIONS



	<b>Dimensions</b>	<b>mm</b>
K	Width including door mirrors	2019
L	Width including folded-in door mirrors	1895

A Applies to 17/18-inch wheels.

B Applies to 19-inch wheels.

C Applies to 20-inch wheels.

D Applies to 21-inch wheels.

E Body width.

F At door mouldings.



## Weights

Max. gross vehicle weight, etc. can be read on a label in the car.

Kerb weight includes the driver, the fuel tank 90% full and all fluids.

The weight of passengers and accessories, and towball load (when a trailer is hitched) influence the load capacity and are not included in the kerb weight.

Permitted max. load = Gross vehicle weight - Kerb weight.

### **i** NOTE

The documented kerb weight applies to cars in the standard version - i.e. a car without extra equipment or accessories. This means that for every accessory added the loading capacity of the car is reduced correspondingly by the weight of the accessory.

Examples of accessories that reduce load capacity are the different equipment levels (e.g. Kinetic, Momentum, Summum), as well as other accessories such as towbar, load carrier, space box, audio system, auxiliary lamps, GPS, fuel-driven heater, safety grille, carpets, cargo cover, power seats, etc.

Weighing the car is a certain way of ascertaining the kerb weight of your own particular car.

### **!** WARNING

The car's driving characteristics change depending on how heavily it is loaded and how the load is distributed.

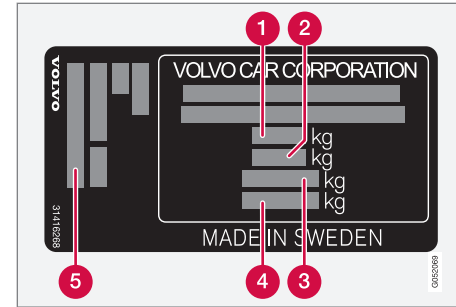

The decal is positioned on the door pillar, and will be visible when the right-hand rear door is opened.

- 1** Max. gross vehicle weight
- 2** Max. train weight (car+trailer)
- 3** Max. front axle load
- 4** Max. rear axle load
- 5** Equipment level

Max. load: See registration document.

Max. roof load: 100 kg.

### Related information

- Type designations (p. 558)
- Towing capacity and towball load (p. 564)

## Towing capacity and towball load

Towing capacity and towball load for driving with a trailer can be read in the tables.

## Max. weight braked trailer

**NOTE**  
The use of a stabiliser hitch on the towing bracket is recommended for trailers heavier than 1800 kg.

Engine	Engine code <sup>A</sup>	Gearbox	Max. weight braked trailer (kg)	Max. towball load (kg)
T5/Bi-Fuel	B4204T23	Automatic	1800	110
T6 AWD	B4204T27	Automatic	1800 <sup>B</sup> 2200 <sup>C</sup>	110
D3	D4204T9	Manual select	1800	110
D3	D4204T9	Automatic	1800	110
D3 AWD	D4204T4	Automatic	1800 <sup>B</sup> 2200 <sup>C</sup>	110
D4	D4204T14	Manual select	1800	110
D4	D4204T14	Automatic	1800	110

Engine	Engine code <sup>A</sup>	Gearbox	Max. weight braked trailer (kg)	Max. towball load (kg)
D4 AWD	D4204T14	Automatic	1800 <sup>B</sup> 2200 <sup>C</sup>	110
D5 AWD	D4204T23	Automatic	1800 <sup>B</sup> 2200 <sup>C</sup>	110

<sup>A</sup> The engine code, component number and serial number can be found on the engine.

<sup>B</sup> Applies to cars that are **not** equipped for a higher towing weight.

<sup>C</sup> Applies to cars that are equipped for a higher towing weight.

**!** **IMPORTANT**

When driving with a trailer, it is permitted to exceed the vehicle's gross vehicle weight (including towball load) by a maximum of 100 kg, provided that speed is limited to 100 km/h (62 mph). National legal requirements for the vehicle combination, such as speed, etc. must be observed.

**Max. weight unbraked trailer**

Max. weight unbraked trailer (kg)	Max. towball load (kg)
750	50

**Related information**

- Type designations (p. 558)
- Weights (p. 563)
- Driving with a trailer (p. 426)
- Trailer Stability Assist\* (p. 428)

**Engine specifications**

Engine specifications (output etc.) for each respective engine alternative can be read in the table.

<b>i NOTE</b>
Not all engines are available in all markets.

Engine	Engine code <sup>A</sup>	Output (kW/rpm)	Output (hp/rpm)	Torque (Nm/rpm)	No. of cylinders
T5/Bi-Fuel	B4204T23	187/5500	254/5500	350/1500-4800	4
T6 AWD	B4204T27	235/5700	320/5700	400/2200-5400	4
D3	D4204T9	110/3750	150/3750	320/1750-3000	4
D3 AWD	D4204T4	110/4250	150/4250	350/1500-2500	4
D4 / D4 AWD	D4204T14	140/4250	190/4250	400/1750-2500	4
D5 AWD	D4204T23	173/4000	235/4000	480/1750-2250	4

<sup>A</sup> The engine code, component number and serial number can be found on the engine.

**Related information**

- Type designations (p. 558)
- Engine oil — specifications (p. 567)
- Coolant — specifications (p. 570)

## Engine oil — specifications

Engine oil grade and volume for each respective engine alternative can be read in the table.

Volvo recommends:



Engine	Engine code <sup>A</sup>	Oil grade	Volume, incl. oil filter (litres)
T5/Bi-Fuel	B4204T23	Castrol Edge Professional V 0W-20 or VCC RBS0-2AE 0W-20	approx. 5.9
T6 AWD	B4204T27		approx. 5.9
D3	D4204T9	Castrol Edge Professional V 0W-20 or VCC RBS0-2AE 0W-20	approx. 5.2
D3 AWD	D4204T4		approx. 5.2
D4 / D4 AWD	D4204T14		approx. 5.2
D5 AWD	D4204T23		approx. 5.2

<sup>A</sup> The engine code, component number and serial number can be found on the engine.

### ◀◀ **Related information**

- Type designations (p. 558)
- Adverse driving conditions for engine oil (p. 569)
- Checking and filling with engine oil (p. 517)
- Engine oil (p. 516)

## Adverse driving conditions for engine oil

Adverse driving conditions can lead to abnormally high oil temperature or oil consumption. Below are some examples of adverse driving conditions.

Check the oil level more frequently for long journeys:

- towing a caravan or trailer
- in mountainous regions
- at high speeds
- in temperatures colder than  $-30\text{ }^{\circ}\text{C}$  or hotter than  $+40\text{ }^{\circ}\text{C}$ .

The above also apply to shorter driving distances at low temperatures.

Choose a fully synthetic engine oil for adverse driving conditions. It provides extra protection for the engine.

Volvo recommends:



### ! IMPORTANT

In order to fulfil the requirements for the engine's service intervals all engines are filled with a specially adapted synthetic engine oil at the factory. The choice of oil has been made very carefully with regard to service life, starting characteristics, fuel consumption and environmental impact.

An approved engine oil must be used in order that the recommended service intervals can be applied. Only use a prescribed grade of oil for both filling and oil change, otherwise there is a risk of the service life, starting characteristics, fuel consumption and environmental impact of the car being affected.

If engine oil of the prescribed grade and viscosity is not used, engine related components may become damaged. Volvo Car Corporation disclaims any liability for any such damage.

Volvo recommends that oil changes are carried out at an authorised Volvo workshop.

### Related information

- Engine oil — specifications (p. 567)
- Engine oil (p. 516)

### Coolant — specifications

**Prescribed grade:** Coolant recommended by Volvo mixed with 50% water<sup>1</sup>, see the packaging.

### Transmission fluid — specifications

The prescribed transmission fluid for each respective gearbox alternative can be read in the table.

#### Manual gearbox

<b>Prescribed transmission fluid:</b>	BOT 350M3
---------------------------------------	-----------

#### Automatic gearbox

<b>Prescribed transmission fluid:</b>	AW1
---------------------------------------	-----

<b> NOTE</b>
The transmission fluid does not need to be changed under normal driving conditions.

### Brake fluid — specifications

The medium in a hydraulic brake system is called brake fluid, and it is used to transfer pressure from e.g. a brake pedal via a master brake cylinder to one or more slave cylinders, which in turn act on a mechanical brake.

**Prescribed grade:** Volvo Original Dot 4 class 6 or equivalent.

<b> NOTE</b>
It is recommended that brake fluid is changed or filled by an authorised Volvo workshop.

<sup>1</sup> Water quality must fulfil the standard STD 1285.1.



## Fuel tank - volume

Fuel tank volume for each respective engine alternative can be read in the table.

Engine	Volume (litres)
AWD	approx. 60
Other engines	approx. 55

## Vehicle gas tank (CNG) - applies to Bi-Fuel

Tank volume	approx. 18 kg
-------------	---------------

### **i** NOTE

Filling stations may have different tank pressures, so fillable gas volume may differ from one refuelling to another.

## Related information

- Opening/closing the fuel filler flap and refuelling (p. 415)

## Air conditioning — specifications

The car's climate control system uses a refrigerant, either R1234yf or R134a depending on market. Information about which refrigerant the car's climate control system uses is printed on a decal located on the inside of the bonnet.

Prescribed grades and volumes of fluids and lubricants in the air conditioning system can be read in the tables below.

### A/C decal

#### Decal for R134a

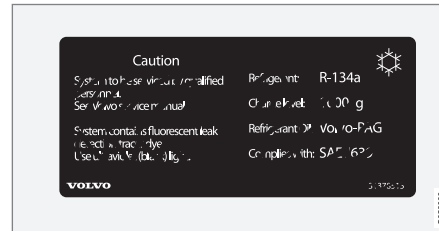

#### Decal for R1234yf



## Symbol explanation R1234yf

Symbol	Meaning
	Caution
	Mobile air conditioning system (MAC)
	Lubricant type
	A trained and certified technician is required in order to service the mobile air conditioning system (MAC)
	Flammable refrigerants

◀◀ **Refrigerant**

**Cars with refrigerant R134a**

Weight	Prescribed grade
700 g	R134a

**⚠ WARNING**

The air conditioning system contains pressurised refrigerant R134a. This system must only be serviced and repaired by an authorised workshop.

**Cars with refrigerant R1234yf**

Weight	Prescribed grade
650 g	R1234yf

**⚠ WARNING**

The air conditioning system contains pressurised refrigerant R1234yf. In accordance with SAE J2845 (Technician Training for Safe Service and Containment of Refrigerants Used in Mobile A/C System), service and repair of the refrigerant system must only be performed by trained and certified technicians in order to ensure the safety of the system.

**Compressor oil**

Volume	Prescribed grade
60 ml	PAG SP-A2

**Evaporator**

**ⓘ IMPORTANT**

The A/C system's evaporator must never be repaired or replaced with a previously used evaporator. A new evaporator must be certified and labelled in accordance with SAE J2842.

**Related information**



- Servicing the climate control system (p. 520)
- Type designations (p. 558)

## Fuel consumption and CO2 emissions







Fuel consumption in a vehicle is measured in litres per 100 km and CO2 emissions in grams CO2 per km.

### Explanation

CO <sub>2</sub>	gram CO <sub>2</sub> /km
	litre/100 km

	urban driving
	extra-urban driving
	combined driving
man	manual gearbox
aut	Automatic gearbox







 <b>NOTE</b>
If the consumption and emission data is missing then it is included in the enclosed supplement.

							
		CO <sub>2</sub>		CO <sub>2</sub>		CO <sub>2</sub>	
T5 (B4204T23)	aut	204	9.0	126	5.6	154	6.8
T6 AWD (B4204T27)	aut	220	9.6	140	6.1	169	7.4
D3 <sup>A</sup> (D4204T9)	man	142	5.4	106	4.0	119	4.5
D3 <sup>B</sup> (D4204T9)	man	139	5.3	103	3.9	116	4.4
D3 <sup>A</sup> (D4204T9)	aut	137	5.2	109	4.1	119	4.5
D3 <sup>B</sup> (D4204T9)	aut	135	5.2	105	4.0	116	4.4



## SPECIFICATIONS



							
		CO <sub>2</sub>	∅ 	CO <sub>2</sub>	∅ 	CO <sub>2</sub>	∅ 
D3 AWD (D4204T4)	aut	149	5.7	116	4.4	128	4.9
D4 (D4204T14)	man	142	5.4	106	4.0	119	4.5
D4 (D4204T14)	aut	139	5.2	108	4.1	119	4.5
D4 AWD (D4204T14)	aut	149	5.7	116	4.4	128	4.9
D5 AWD (D4204T23)	aut	150	5.7	117	4.5	129	4.9

<sup>A</sup> Does **not** apply to the low-emission variant.

<sup>B</sup> This **only** applies to the low-emissions variant.

Fuel consumption and emission values in the table above are based on specific EU driving cycles (see below), that apply to cars with kerb weight in the basic version and without extra equipment. The car's weight may increase depending on equipment. This, as well as how heavily the car is loaded, increases fuel consumption and carbon dioxide emissions.

There are several reasons for increased fuel consumption compared with the table's values. Examples of this are:

- If the car is equipped with extra equipment that affects the car's weight.
- The driver's driving style.
- If the customer chooses wheels other than those fitted as standard on the model's basic version then rolling resistance may increase.
- High speed results in increased wind resistance.
- Fuel quality, road and traffic conditions, weather and the condition of the car.

A combination of the above-mentioned examples can result in significantly increased consumption.

Large deviations in fuel consumption may arise in a comparison with the EU driving cycles (see below) which are used in the certification of the car and on which the consumption figures in the table are based. For further information, please refer to the regulations referred to.

### **NOTE**

Extreme weather conditions, driving with a trailer or driving at high altitudes in combination with fuel quality are factors that considerably increase the car's fuel consumption.

### EU driving cycles

Official fuel consumption figures are based on two standardised driving cycles in a laboratory environment ("EU driving cycles") all in accordance with EU Regulation no 692/2008 and 715/2007 (Euro 5 / Euro 6) and UN ECE Regulation no 101. Since the driving cycles are also used for quality control, there are significant requirements for repeatability of the tests. For this reason the tests are carried out under close scrutiny and only with the car's basic functions (e.g. air conditioning, radio, etc. switched off). As a consequence of this the results from the official figures are not obviously representative of what the customer sees during actual usage.

The regulations cover the driving cycles for "Urban driving" and "Extra-urban driving":

- **Urban driving** - the measurement starts with cold starting the engine. The driving is simulated.
- **Extra-urban driving** - the car is accelerated and braked at speeds between 0-120 km/h (0-75 mph). The driving is simulated.

The official value for combined driving, which is reported in the table, is a combination of the results from the "Urban driving" and "Extra-urban driving" driving cycles, in accordance with legal requirements.

The exhaust gases are collected in order to extrapolate the carbon dioxide emissions (CO<sub>2</sub> emissions) during the two driving cycles. These

are then analysed and give the value for CO<sub>2</sub> emissions.

### CO<sub>2</sub> emissions and fuel consumption (vehicle gas - CNG) - for Bi-Fuel

<b>Methane gas</b> gram CO <sub>2</sub> /km	120
<b>Biogas</b> gram CO <sub>2</sub> /km	43
<b>Combined driving</b> kg/100 km	4.5

### CNG specifications

Type designation	Bi-Fuel
Output, CNG	Power output is equivalent as for petrol.
Emission level	Euro 6

### NOTE

- There are many different qualities of gas, as well as gases with lower energy content and range.
- The fuel consumption specified above applies for combined driving. During urban driving or fast motorway driving the consumption is higher and during calm extra-urban driving it is lower.

### Related information

- Type designations (p. 558)
- Weights (p. 563)
- Economical driving (p. 422)

## Approved wheel and tyre sizes

In certain countries not all approved sizes are indicated by the registration document or other

documents. The following table shows all approved combinations of wheel rims and tyres.

✓ = Approved

Engine	man/ aut	225/55R17 <sup>A</sup> 8x17x42	245/45R18 8x18x42	255/40R19 8,5x19x47	255/35R20 8,5x20x47,5	245/35R21 <sup>B</sup> 8,5x21x44,5
T5/Bi-Fuel (B4204T23)	aut	✓	✓	✓	✓	✓
T6 AWD (B4204T27)	aut	-	✓	✓	✓	✓
D3 <sup>C</sup> (D4204T9)	man	-	✓	-	-	-
D3 <sup>D</sup> (D4204T9)	man	✓	✓	✓	✓	✓
D3 <sup>C</sup> (D4204T9)	aut	-	✓	-	-	-
D3 <sup>D</sup> (D4204T9)	aut	✓	✓	✓	✓	✓
D3 AWD (D4204T4)	aut	✓	✓	✓	✓	✓
D4 (D4204T14)	man	✓	✓	✓	✓	✓
D4 (D4204T14)	aut	✓	✓	✓	✓	✓
D4 AWD (D4204T14)	aut	✓	✓	✓	✓	✓
D5 AWD (D4204T23)	aut	✓	✓	✓	✓	✓

<sup>A</sup> 225/55 R17 is not approved when the car is equipped with active shock absorption (Four-C)\* or 18" brakes. Check with your Volvo dealer how your car is equipped.

<sup>B</sup> Cars built with standard chassis must be updated with limiters for the front suspension. Check with your Volvo dealer how your car is equipped.

<sup>C</sup> This **only** applies to the low-emissions variant.

<sup>D</sup> Does **not** apply to the low-emission variant.

## Related information

- Load index and speed rating (p. 577)
- Type designations (p. 558)
- Dimension designation for tyre (p. 502)
- Dimension designation for wheel rim (p. 502)

## Load index and speed rating

The table below shows the minimum permitted load index (LI) and speed rating (SS).

Engine		man/ aut	Minimum permitted load index (LI) <sup>A</sup>	Minimum permitted speed rating (SS) <sup>B</sup>
T5/Bi-Fuel	B4204T23	aut	96	V
T6 AWD	B4204T27	aut	96	W
D3	D4204T9	man	96	H
D3	D4204T9	aut	96	H
D3 AWD	D4204T4	aut	96	H
D4	D4204T14	man	96	V
D4	D4204T14	aut	96	V
D4 AWD	D4204T14	aut	96	V
D5 AWD	D4204T23	aut	96	V

<sup>A</sup> The tyre's load index must be at least equal to or greater than indicated in the table.

<sup>B</sup> The tyre's speed rating must be at least equal to or greater than indicated in the table.

## Related information

- Approved wheel and tyre sizes (p. 576)
- Approved tyre pressures (p. 578)
- Type designations (p. 558)
- Dimension designation for tyre (p. 502)
- Dimension designation for wheel rim (p. 502)

## Approved tyre pressures

Approved tyre pressures for each engine alternative can be found in the table.

<b>i</b> <b>NOTE</b>
All engines, tyres or combinations of these are not always available in all markets.

Engine	Tyre size	Speed (km/h)	Load, 1-3 persons		Max. load		ECO pressure <sup>A</sup>	
			Front (kPa) <sup>B</sup>	Rear (kPa)	Front (kPa)	Rear (kPa)	Front/rear (kPa)	
All engines	225/55 R17	0 - 160 <sup>C</sup>	230	230	260	260	260	
	245/45 R18		160+ <sup>D</sup>	260	260	270	270	-
	255/40 R19	0 - 160 <sup>C</sup>		240	240	260	260	260
	255/35 R20		160+ <sup>D</sup>	300	300	310	310	-
	245/35 R21			420	420	420	420	-
Temporary Spare Tyre		max. 80 <sup>E</sup>	420	420	420	420	-	

A Economical driving.

B In certain countries the "bar" unit is used alongside the SI unit "Pascal": 1 bar = 100 kPa.

C 0 - 100 mph

D 100+ mph

E max 50 mph

## Related information

- Type designations (p. 558)
- Checking the tyre pressures (p. 484)
- Approved wheel and tyre sizes (p. 576)



# ALPHABETICAL INDEX

## 1, 2, 3 ...

4WD 403

## A

A/C (Air conditioning) 188

### ABS

anti-lock brakes 404

ACC – Adaptive cruise control 288, 297

Accessories and extra equipment 23

Active bending lights 141

Active main beam 138

Active Park Assist 372

function 372

Limitations 377

operation 374

Symbols and messages 379

Active Yaw Control 271

Adaptation of headlamp beam 141

Adapting driving characteristics 270, 398

Adaptive Cruise Control 288, 297

change cruise control functionality 299

fault tracing 298

function 288

managing speed 292, 293

overtaking 296

radar sensor 316

setting the time interval 294

standby mode 295

temporary deactivation 295

Additional heater (Auxiliary heater) 213

Adjusting the steering wheel 132

Aerial

location 238

Airbag 63

Activating/deactivating 66

driver's side 64

passenger side 64, 66

Airbag, see Airbag 63

Air conditioning 188

Air conditioning, fluid

volume and grade 571

Air conditioning system 180, 184

repair 520

Air distribution 195

Air vents 195, 197

change 196

defrosting 192

Recirculation 194

table of options 199

Air quality 182, 183

allergies and asthma 183

passenger compartment filter 183

Air recirculation 194

Alarm 260

automatic re-arming 262

deactivation 262

reduced alarm level 260

Alcohol lock 382

Allergy and asthma inducing substances. 183

All Wheel Drive, (AWD) 403

All Wheel Drive (AWD) 403

Android Auto 453

Apple CarPlay 450, 451

Applications

settings 178

Approach lighting 148

Apps 434

download, update and uninstall 468

Ashtray 222

Audio and media 434

Audio settings 435, 463

media 448

phone 462

play media 443

Text message 461

Auto climate control 187

Automatic brake 410

after collision 406

## ALPHABETICAL INDEX

Automatic car washes	549
Automatic engine stop auto-stop	394
Automatic gearbox trailer	388 428
Automatic relocking	240
Automatic speed limiter	279
AUX jack for connecting media	448
Auxiliary heater	213
AWD, All Wheel Drive	403

## B

Backrest front seat, adjusting rear seat, lowering	121, 122, 124 130
Bag holder	226
Battery jump starting maintenance overload start support symbols on the battery warning symbols	386, 530 386 530 413 530 533 533 533

Bi-Fuel introduction Switch	54 417
BLIS	338, 340, 341
Bluetooth connect connect car to Internet phone settings	447 464 456 463
Bonnet, opening	514
Book service and repair	506
Brake assist after collision	406
Brake fluid grade	570
Brake functions	404
Brake light	143
Brakes Anti-lock braking system, ABS automatic when stationary brake assist system, BAS brake light brake system emergency brake lights handbrake	404 404 410 406 143 404 406 407, 408, 409
bulbs, specifications	526

## C

Camera sensor	335
Car care Leather upholstery	549 552
Car functions in centre display	47
Cargo area electrical socket lighting mounting points protective net	224 218 146 226 230
Cargo cover	228
Cargo grille	232
Car holiday	413
Car key battery low	255
Car modem connect car to Internet settings	464 468
Car status Tyre pressure	506 487
Car upholstery	552
Car washing	549
Catalytic converter Recovery	432
CD player	446
central locking	243

Centre display		seatbelts	553	Controls lighting	135
change settings	45	upholstery	552	Coolant	570
cleaning	553	Clean Zone Interior Package	183	Coolant, filling	518
climate control	185	Climate control	180, 184	Cooling system	
messages	107	auto-regulation	187	overheating	412
operation	36, 40	centre display	185	Cornering lights	142
overview	33	experienced temperature	181	Corner Traction Control	271
symbols in status bar	45	fan control	191	Cover	
Checking the engine oil level	517	Parking	204	cargo area	228
Child safety	71	rear seat	186	Crash, see Collision	56
Child safety locks	259	sensors	181	Cruise control	282
Child seat	71	temperature control	188	deactivate	285
integrated booster cushion	82	voice control	119	managing speed	282, 283
i-Size/ISOFIX mounting points	77	zones	180	temporary deactivation	284
lower mounting points	74	Clock, adjustment	99	CTA	341, 342, 343
positioning/fitting	71	CO <sub>2</sub> emissions	573	Cyclist detection	331
table for location	75	Collision	56, 59, 63, 69	CZIP (Clean Zone Interior Package)	183
table of i-Size	81	Collision warning	328		
table of ISOFIX	78	Collision warning system		<b>D</b>	
Upper mounting points	73	Pedestrian detection	331	DAB Radio	440
Cigarette lighter	222	Radar sensor	316	Data	
City Safety™	328, 330, 331, 333, 334, 335, 337	Colour code, paint	554	recording	22
Cleaning		Combined instrument panel	90	transfer between car and workshop	511
automatic car wash	549	settings	94	Data link connector	23
car washing	549	Compass	156	Daytime running lights	137
centre display	553	calibration	157		
Fabric upholstery	552	Condensation in headlamps	549		
rims	551				



filter	516
grade and volume	567
Engine oil, filling	517
Engine specifications	566
Error messages	
Adaptive Cruise Control	300
see Messages and symbols	300, 314
Error messages in BLIS	345
Ethanol content	
maximum 10 percent by volume	418
External dimensions	561
<b>F</b>	
<hr/>	
Fan	
Air distribution	196
Air vents	197
Control	191
Fault tracing for the camera sensor	325
Ferry transport	403
First aid	502
First aid kit	502
Flooded road	411
Fluids, capacities	529, 570, 571
Fluids and oils	570, 571

Fog lamp	
front	142
rear	142
Foot brake	404, 406
Four-C	403
Front seat	
Climate control	185
Fan	191
heating	201
Temperature	188
Ventilation	202
Front seat, manual	121
Front seat, power	121, 123
adjusting seat	122, 127
massage	124
memory function	122
multi-function control	123, 124
FSC, ecolabelling	32
Fuel	418, 419
fuel consumption	573
identifier	418, 419
Fuelling	
CNG	416
filling	415, 416
Fuel tank	
volume	571
Fuel vapour	418

Fuse box	535
Fuses	
changing	536
General	535
in cargo area	546
in engine compartment	537
under glovebox	542

**G**

<hr/>	
Gas tank	
capacity	571
Gearbox	387
automatic	388
manual	390
Gear positions	
automatic gearbox	388
Gear selector inhibitor	392
Gear shift indicator	390
Glass	
laminated/reinforced	32
Glovebox	223
Gracenote®	445
Gross vehicle weight	563
GSI - Gear selector assistance	390

## ALPHABETICAL INDEX

<b>H</b>		<b>Horn</b>		131	Interior lighting	145
Handbrake	407, 408	<b>I</b>			Interior rearview mirror	155
Hazard warning flashers	143	IAQS (Interior Air Quality System)	183	automatic dimming	155	
Headlamp beam		IC (Inflatable Curtain)	69	Intermittent wiping	148	
adaptation	141	Ignition position	383	Internet, see Internet-connected car	463	
height adjustment	135	Immobiliser	258	Internet-connected car		
Headlamp control	134	Indicator symbols	95	book service and repair	506	
Headlamp levelling of headlamps	135	Individual drive mode	398	system updates	510	
Headlamp pattern, adjusting	141	Inflatable curtain	69	iPod®, connection	447	
Headlamp pattern adjustment	141	Inflatable Curtain	69	ITPMS - Indirect Tyre Pressure Monitoring		
head restraint	128	Information display	90, 94	System	485, 487, 488, 489	
Heated washer nozzles	150	Infotainment system (Audio and media)	434	<b>J</b>		
Heater	211	Instrument lighting	135	Jack	501	
auxiliary heater	213	Instrument overview		Journey statistics	168	
parking heater	212	left-hand drive car	86	Jump starting	386	
Heating		right-hand drive car	87	<b>K</b>		
seats	201	Instruments and controls	86, 87	Kerb weight	563	
steering wheel	203	Integrated booster cushion	82	Key	176, 234, 237, 241	
Windows	192	lowering	84	Keyboard	49, 53	
High engine temperature	412	raising	82	Keypad in the steering wheel	131	
Hill start assist		IntelliSafe		Key tag	234	
Hill Start Assist (HSA)	410	Driver support	28			
Hill Start Assist	410	Interior Air Quality System	183			
HomeLink®	162					
Home safe light duration	148					



## ALPHABETICAL INDEX

Misting	
condensation in headlamps	549
Mobile phone, see Phone	457
Mood lighting	146

## N

Net	
cargo area	230

## O

octane rating	418
Oil, see also Engine oil	567, 569
Oil level low	517
Online car	463
book service and repair	506
connect car	464
no or poor connection	466
system updates	510
Options/accessories	19
Output	566
outside temperature gauge	98
Overheating	412, 428

Owner's manual	19
ecolabelling	32
in centre display	15, 16
Owner information	14
Owner's Manual in mobile	18

## P

PACOS (Passenger Airbag Cut Off Switch)	66
Paddle on the steering wheel	131
Paintwork	
colour code	554
damage and touch-up	554, 555
Panorama roof	
opening and closing	159
pinch protection	161
sun blind	158
ventilation position	160
PAP - Active Park Assist	372
Park Assist	361, 363, 365
function	361, 363
Park assist camera	366, 368, 371
settings	370
Parking brake	407, 408, 409
Parking climate	204
Symbols and messages	210

Parking heater	212
Passenger Airbag Cut Off Switch	66
Passenger compartment filter	183
Passenger compartment heater (Parking heater)	212
Passenger compartment interior	216
ashtray	222
cigarette lighter	222
electrical socket	218
Sun visor	224
tunnel console	217
Passenger compartment lighting	
automatic	145
Pedestrian Protection System	58
Petrol grade	418
Phone	456
Calls	459, 462
connect	457
text message	461
voice control	118
Pilot Assist	302, 305, 307, 308, 309, 311, 312, 314
overtaking	296
Pinch protection, panorama roof	161
PIN code	468
Pocket park assist - PAP	372
Polishing	551



Position lamp	136
Power operated tailgate	251, 254
Power panorama roof	158
Power save mode	413
Power seat	121, 123
Power windows	151
resetting	153
PPS (Pedestrian Protection System)	58
Preconditioning	204
start/shut-off	205
Timer	206
Protective grille	232
Pump up tyre	494
Puncture	490

## Q

---

Queue Assist	302, 307, 314
Queue assistance	302, 307, 314

## R

---

Radar sensor	288
Limitations	317
Radio	436
change and search for radio station	436
DAB	440
settings	441
voice control	118
Rain sensor	149
Raising the car	512
Rear door	
sun blind	153
Rear seat	128
Climate control	185, 186
Fan	191
head restraint	128
heating	201
lowering the backrest	130
Temperature	188
Rearview and door mirrors	
compass	156, 157
door	153
electrically retractable	155
heating	192
interior	155

rear window	
heating	192
Washers	151
Wiper	151
Recommendations during driving	413
Recovery	432
Red Key	237
Refrigerant	520
Refuelling	415
Regeneration	421
Remote control, HomeLink®	
programmable	162
Remote control immobiliser	258
Remote control key	176, 234, 237, 241
battery replacement	255
connect to driver profile	176
detachable key blade	248
loss	234
range	236
Remote control key system, type approval	263
Remote updates	509
Resetting, trip meter	166
Resetting the door mirrors	154
Resetting the power windows	153
Restore settings	178
Retractable power door mirrors	155

## ALPHABETICAL INDEX

Retractable towing bracket	423	Seatbelt reminder	62	Skidding	414
Road run-off protection	358, 360	Seatbelt tensioner	59	Ski hatch	227
Road sign information	346	Seats		slippery driving conditions	414
Limitations	350	heating	201	Soot filter	421
operation	346, 348, 349	manual front seat	121	spare wheel	498
Roll Stability Control	270	memory function front seat	122	Speed camera	348
Roof load, max. weight	563	power front seat	121, 123	Speed limiter	275, 279
RSC (Roll Stability Control)	270	rear seat	128	deactivation	278
Run out of fuel		Ventilation	202	getting started	276
diesel	420	whiplash protection	57	temporary deactivation	277
Rustproofing	552	sensors		Speed ratings, tyres	502
		Air quality	183	Spin control	271
		Climate control	181	Stabiliser	
		Sensus		trailer	428
		connection and entertainment	29	Stability and traction control system	271, 273
		Service position	527	operation	272
		Service programme	506	Stability system	271
		Set time interval	287	Stains	552
		Settings	169	Start/Stop	394, 396
		Categories	170	function and operation	394
		Resetting	173	the engine does not stop	396
		settings view	169	Starting the engine	384
		system settings	172	Start the car	384
		Side airbag	68	Steering force, speed related	270
		Side Impact Protection System	68, 69	Steering force level, see Steering force	270
		SIM card	468	Steering lock	386
		SIPS (Side Impact Protection System)	68, 69		

## S

Safety	56
pregnancy	56
Safety mode	69
start/movement	70
Sealing fluid	490
Seat, see Seats	121
Seatbelt	59
buckle/unbuckle	60
pregnancy	56
seatbelt reminder	62
seatbelt tensioner	59
Seatbelt, see Seatbelts	59

Steering wheel	131, 132	System		driving with a trailer	426, 428
heating	203	updates	510	snaking	428
keypad	131			Trailer stability assist	271, 428
paddle	131	<b>T</b>		Transmission	387
steering wheel adjustment	132	<hr/>		Transmission oil	
Steering wheel paddles	393	Tailgate		grade	570
Stone chips and scratches	554, 555	Locking/unlocking	245, 247	Tread	484
Stop/start function	394	power	251, 254	Tread depth	484, 499
Storage spaces	216	Temperature		Tread wear indicators	484
glovebox	223	Control	188	Trip computer	165, 166, 168
tunnel console	217	experienced	181	Trip meter	165
Sun blind		Temporary spare		Trip meter, resetting	166
panorama roof	158	spare wheel	498	Troubleshooting	
Rear door	153	Through-load hatch	227	Adaptive Cruise Control	298
Sun visor	224	Tools	430, 500	TSA - trailer stability assist	271, 428
Support	19	Towbar		Tunnel console	217
Support battery	533	foldable	423	Tunnel detection	137
Switching off the engine	385	Towing	431, 432	TV	449
Switch off engine	385	Towing bracket	422, 423	Type approval	
Symbols		specifications	425	radar system	321
indicator symbols	95	Towing capacity and towball load	564	remote control key system	263
Symbols and messages		Towing eye	430	Type designations	558
Adaptive Cruise Control	300	Traction control	271	Tyre dimension	495, 502
centre display status field	45	Traffic information	441	Tyre load index	502
Collision Warning with Auto Brake	337	Trailer	428	Tyre monitoring	485
parking climate	210	cable	426		

## ALPHABETICAL INDEX

Tyre pressure label	484
Tyre pressure monitoring	
Calibrate	489
low tyre pressure	488
Tyres	482
dimensions	576
direction of rotation	483
installation	497
pressure	484, 578
puncture repair	490
removal	495
specifications	576, 577, 578
storage	482
tread depth	499
tread wear indicators	484
tyre pressure monitoring	485
winter tyres	499

## U

---

Unit standard	
Trip computer	166
Unlocking	
from the outside	239
with key blade	249
USB	
connect car to Internet	464
jack for connecting media	448

## V

---

Vanity mirror	
lighting	146
Vehicle gas	99, 509
Vehicle gas tank (CNG)	
capacity	571
Ventilation	195, 196, 197
seats	202
Vibration damper	422
Video	447, 448
settings	443
Voice control	
Climate control	119
map navigation	120
phone	118
radio and media	118
settings	117
Voice recognition	115
VOL marking	482
Volvo ID	23

## W

---

Warning lamp	
Adaptive Cruise Control	288
stability and traction control system	271
Warning lamps	
Airbags – SRS	97
alternator not charging	97
Fault in brake system	97
Low oil pressure	97
Parking brake applied	97
seatbelt reminder	97
starter battery not charging	97
Warning	97
Warning sound	
Parking brake	409
Warning symbols	97
Safety	56
Warning triangle	500
Washer fluid	529
Washer nozzles, heated	150
Washers	
rear window	151
washer fluid, filling	529
windscreen	150
Waxing	551
Weights	
kerb weight	563

Wheel bolts	498	Windscreen washing	150
lockable	498	Windscreen wiper	148
Wheel change	495	rain sensor	149
Wheel rim, dimensions	502	Winter driving	414
Wheel rims		Winter tyres	499
cleaning	551	Winter wheels	499
Wheels		Wiper blades	
installation	497	changing	528
removal	495	Service position	527
snow chains	499	Wipers and washing	148
Wheels and tyres			
approved dimensions	576		
tyre load index and speed rating	502, 577		
whiplash protection	57		
Whiplash Protection System	57		
WHIPS (Whiplash Protection System)	57		
Wi-Fi			
connect car to Internet	464		
delete network	467		
share internet connection, hotspot	465		
technology and security	467		
Window			
sun blind	153		
Windows and glass	32		
Windscreen			
heating	192		
projected image	112		





