



S 80

WEB EDITION  
OWNER'S MANUAL





## **WELCOME TO THE WORLD-WIDE FAMILY OF VOLVO OWNERS.**

We trust that you will enjoy many years of safe driving in your Volvo, an automobile designed with your safety and comfort in mind. We encourage you to familiarize yourself with the equipment descriptions and operating instructions in this manual.

We also urge you and your passengers to wear seat belts at all times in this (or any other) vehicle. And, of course, please do not operate a vehicle if

you may be affected by alcohol, medication or any impairment that could hinder your ability to drive.

Your Volvo is designed to meet all applicable federal safety and emission standards. If you have any questions regarding your vehicle, please contact your Volvo retailer or see the article "Contacting Volvo" for information on getting in touch with Volvo in the United States and Canada.





## 01 Introduction

On-board owner's manual.....	11
Owner's information.....	13
Contacting Volvo.....	13
About this manual.....	14
Change of ownership.....	18
Crash event data.....	18
Volvo Structural Parts Statement.....	19
Information on the Internet.....	20
Volvo ID.....	20
Open Source Software Notice.....	21
Volvo and the environment.....	21
Important warnings.....	22
Volvo On Call Roadside Assistance.....	23
Technician certification.....	24



## 02 Safety

Occupant safety.....	26
Recall information.....	26
Reporting safety defects.....	27
Seat belts – general.....	28
Seat belts – buckling/unbuckling.....	29
Seat belt reminder.....	30
Seat belts – pregnancy.....	30
Supplemental Restraint System (SRS).....	31
Front airbags.....	32
Occupant Weight Sensor.....	36
Side impact protection (SIPS) airbags.....	39
Inflatable Curtain (IC).....	41
Whiplash Protection System (WHIPS).....	42
Crash mode – general information.....	44
Crash mode – starting the vehicle.....	45
Crash mode – moving the vehicle.....	45
Child safety.....	45
Child restraints.....	47
Infant seats.....	49
Convertible seats.....	51
Booster cushions.....	53
ISOFIX/LATCH lower anchors.....	54
Top tether anchors.....	56



Child safety locks.....	57
-------------------------	----

# 02



## 03 Instruments and controls

Instrument overview .....	59
Information displays – introduction.....	62
Eco Guide* and Power Meter*.....	65
Information displays – indicator symbols.....	66
Information displays – warning symbols.....	68
My Car – introduction.....	70
Information displays – ambient temperature sensor.....	71
Information displays – trip odometer and clock.....	72
Inserting/removing remote key.....	72
Ignition modes.....	73
Front seats.....	74
Front seats – folding backrest*.....	75
Front seats – power seat.....	75
Key memory – power driver's seat* and door mirrors.....	77
Rear seats – head restraints.....	78
Rear seats – folding backrest.....	80
Steering wheel.....	81
Electrically heated* steering wheel.....	82
Lighting panel.....	82
High/low beam headlights.....	83
Active high beams (AHB)*.....	84



Tunnel detection (models with the rain sensor* only).....	85
Active Bending Lights (ABL)*.....	85
Auxiliary lights*.....	86
Instrument and "theater" lighting.....	86
Parking lights.....	87
Rear fog lights.....	87
Hazard warning flashers.....	88
Turn signals.....	88
Front interior lighting.....	89
Rear interior lighting.....	90
Home safe lighting.....	90
Approach lighting.....	91
Windshield wipers.....	91
Rain sensor*.....	92
Windshield washer.....	92
Tailgate wiper/washer.....	93
Power windows.....	94
Sun shades*.....	95
Power door mirrors.....	96
Power door mirrors – automatic tilting/retraction.....	97
Heated windshield*, rear window and door mirror defrosters.....	98



Interior rearview mirror.....	98
Digital compass*.....	99
Power moonroof – introduction.....	100
Power moonroof – operation.....	101
HomeLink® Wireless Control System* – introduction.....	102
HomeLink® Wireless Control System* – programming.....	103
Volvo Sensus.....	105
Information display – menu controls.....	106
Information display – menu overview.....	107
Information display – messages.....	107
Trip computer – introduction .....	108
Trip computer – functions, analog instrument panel.....	110
Trip computer – functions, digital instrument panel.....	113
Trip computer – Supplementary information.....	115
Trip computer – Trip statistics.....	116



## 04 Climate

Climate – general information.....	118
Climate – sensors.....	119
Air quality.....	119
Interior Air Quality System (IAQS)*.....	120
Climate – menu settings.....	120
Air distribution – general.....	121
Electronic climate control (ECC).....	122
Heated seats.....	123
Ventilated seats.....	124
Temperature and blower control.....	124
Automatic climate control.....	125
Air conditioning.....	125
Max. defroster and electrically heated windshield*.....	126
Air distribution – function.....	127
Air distribution – recirculation.....	128
Air distribution – table.....	129



## 05 Loading and storage

Storage spaces.....	132
Tunnel console.....	134
Tunnel console – 12-volt sockets.....	134
Glove compartment.....	135
Vanity mirror.....	135
12-volt socket in the trunk*.....	135
Loading – general.....	136
Ski hatch.....	136
Loading – roof load carriers.....	137
Load anchoring eyelets.....	138
Grocery bag holder.....	138



## 06 Locks and alarm

Remote key and key blade.....	140
Remote key – loss.....	140
Key memory.....	141
Locking/unlocking confirmation.....	141
Immobilizer (start inhibitor).....	142
Remote key – functions.....	143
Remote key – range.....	144
Detachable key blade – general information.....	145
Detachable key blade – detaching/reinserting.....	145
Detachable key blade – unlocking.....	146
Valet locking.....	146
Remote key – replacing the battery.....	147
Keyless drive*– locking/unlocking.....	149
Keyless drive* – unlocking with key blade.....	150
Keyless drive* – key memory.....	150
Keyless drive* – messages.....	151
Keyless drive* – antenna locations.....	152
Locking/unlocking – from the outside.....	153
Manual locking.....	154
Locking/unlocking – from inside.....	154
Locking/unlocking – glove compartment	155



Locking/unlocking – trunk.....	156
Alarm – general information.....	157
Alarm indicator.....	158
Alarm – arming/disarming.....	158
Alarm signal.....	159
Alarm – turning off.....	159
Alarm-related functions.....	160



## 07 Driver support

Active chassis* (Four C).....	162
Stability system – introduction.....	162
Stability system – operation.....	163
Stability system – symbols and messages.....	164
Adjustable steering force*.....	166
Road Sign Information (RSI)* – introduction.....	166
Road Sign Information (RSI) – operation.....	167
Road Sign Information (RSI) – limitations.....	167
Cruise control (CC) – introduction.....	168
Cruise control (CC) – engaging and setting speed.....	168
Toggleing between ACC and CC (standard Cruise Control).....	170
Cruise control (CC) – deactivating.....	170
Adaptive Cruise Control – introduction.....	171
Adaptive Cruise Control – function.....	172
Adaptive Cruise Control – engaging.....	174
Adaptive Cruise Control – setting speed.....	175
Adaptive Cruise Control – setting time interval.....	176
Adaptive Cruise Control – deactivating.....	176
Adaptive Cruise Control – passing another vehicle.....	178



Adaptive Cruise Control (ACC) – Queue Assist.....	178
Radar sensor.....	180
Adaptive Cruise Control – limitations.....	180
Adaptive Cruise Control – symbols and messages.....	182
Adaptive Cruise Control – troubleshooting.....	184
Distance Alert – introduction.....	185
Distance Alert – operation.....	185
Distance Alert – limitations.....	186
Distance Alert – symbols and messages.....	188
City Safety – introduction.....	189
City Safety – function.....	190
City Safety – operation.....	191
City Safety – limitations.....	191
City Safety – troubleshooting.....	192
City Safety – symbols and messages.....	194
City Safety – Laser sensor.....	195
Collision warning – introduction.....	196
Collision warning* – function.....	198
Collision warning* – operation.....	199
Collision warning* – Cyclist detection.....	200
Collision warning* – Pedestrian detection.....	201



Collision warning* – limitations.....	202
The camera's limitations.....	204
Collision warning – troubleshooting.....	205
Collision warning – symbols and messages.....	207
Driver Alert System.....	209
Driver Alert Control (DAC) – introduction.....	209
Driver Alert Control (DAC) – operation.....	210
Driver Alert Control (DAC) – function.....	210
Driver Alert Control (DAC) – limitations.....	211
Driver Alert Control (DAC) – symbols and messages.....	212
Lane Departure Warning (LDW) – introduction.....	214
Lane Departure Warning (LDW) – operation.....	214
Lane Departure Warning (LDW) – limitations.....	216
Lane Departure Warning (LDW) – symbols and messages.....	217
Park assist – introduction.....	219
Park assist – function.....	219
Park assist – operation.....	221
Park assist – limitations.....	222
Park assist – troubleshooting.....	223



Rear Park Assist Camera (PAC) – introduction.....	223
Rear Park Assist Camera (PAC) – function.....	224
Rear Park Assist Camera (PAC) – operation.....	224
Rear Park Assist Camera (PAC) – guiding and marker lines.....	225
Rear Park Assist Camera (PAC) – limitations.....	227
BLIS* – introduction.....	227
BLIS* – function.....	228
BLIS* – operation.....	229
BLIS* – limitations.....	229
BLIS* – messages.....	230



## 08 Starting and driving

Starting the engine.....	233
Switching off the engine.....	235
Engine Remote Start (ERS)* – introduction.....	235
Engine Remote Start (ERS)* – starting the engine.....	236
Engine Remote Start (ERS)* – switching off the engine.....	236
Jump starting.....	237
Transmission – general information.....	238
Transmission – positions.....	238
Transmission – Geartronic.....	240
Transmission – shiftlock override.....	242
Start/Stop – Hill Start Assist (HSA).....	243
Start/Stop – introduction.....	243
Start/Stop – function.....	243
Start/Stop – Auto-stop exceptions.....	244
Start/Stop – Auto-start exceptions.....	245
Start/Stop – settings.....	246
Start/Stop – symbols and messages.....	247
ECO*.....	248
All Wheel Drive (AWD).....	250
Brakes – general.....	250
Brakes – symbols.....	252



Anti-lock braking system (ABS).....	252
Brake lights.....	253
Emergency Brake Assistance (EBA).....	253
Parking brake – general information.....	254
Parking brake – applying.....	254
Parking brake – releasing.....	255
Parking brake – symbols and messages	257
Driving through water.....	258
Engine and cooling system.....	258
Conserving electrical current.....	259
Before a long distance trip.....	259
Driving in cold weather.....	260
Refueling – fuel requirements.....	260
Refueling – octane rating.....	261
Refueling – opening/closing fuel filler door.....	263
Refueling – opening/closing fuel cap.....	264
Emission controls.....	264
Economical driving.....	265
Towing a trailer.....	266
Trailer Stability Assist (TSA).....	268
Towing the vehicle.....	268
Towing eyelet.....	269
Towing by tow truck.....	270



## 09 Wheels and tires

Tires – general information.....	273
Tires – storage and age.....	274
Tires – tread wear indicator.....	275
Tires – tire economy.....	275
Changing a wheel – direction of rotation	276
Changing a wheel – removing wheel.....	276
Changing a wheel – spare wheel.....	279
Changing a wheel – accessing the spare wheel.....	280
Changing a wheel – installing a wheel....	280
Tire inflation – general information.....	281
Tire inflation – checking pressure.....	282
Tire specifications.....	283
Tire inflation – pressure table.....	285
Loading specifications.....	286
Loading specifications – load limit.....	286
Tire specifications – terminology.....	287
Tire specifications – Uniform Tire Quality Grading.....	288
Snow chains.....	289
Snow tires/studded tires.....	290
Tire pressure monitoring - introduction..	290
Tire Pressure Monitoring System (TPMS) – general information.....	291



Tire Pressure Monitoring System (TPMS) – changing wheels.....	292
Tire Pressure Monitoring System (TPMS) – recalibrating.....	293
Tire Pressure Monitoring System (TPMS) – activating/deactivating.....	293
Tire Pressure Monitoring System (TPMS) – messages.....	294
Tire Monitor - introduction.....	295
Calibrating Tire Monitor.....	295
Tire Monitor status information.....	296
Tire Monitor – messages.....	296
Self-supporting run flat tires (SST).....	297
Tire sealing system* – general information.....	298
Tire sealing system* – overview.....	300
Tire sealing system* – sealing hole.....	301
Tire sealing system – checking inflation pressure.....	303
Tire sealing system* – inflating tires.....	303
Tire sealing system* – sealing compound container.....	304

\* Option/accessory, for more information, see Introduction.



## 10 Maintenance and servicing

Maintenance – introduction.....	306
Maintenance – owner maintenance.....	307
Maintenance – hoisting.....	308
Onboard Diagnostic System.....	309
Booking service and repairs .....	309
Maintenance – opening/closing hood.....	311
Engine compartment – overview.....	312
Engine compartment – engine oil.....	313
Engine compartment – coolant.....	315
Engine compartment – brake fluid.....	316
Engine compartment – power steering fluid.....	317
Bulbs – introduction.....	318
Bulbs – headlight housing.....	319
Bulbs – cover.....	320
Bulbs – low beam, Halogen.....	320
Bulbs – high beam, Halogen.....	321
Bulbs – extra high beam.....	321
Bulbs – front turn signals.....	322
Bulbs – front side marker lights.....	323
Bulbs – taillight housing.....	323
Bulbs – license plate lighting.....	324
Bulbs – trunk lighting.....	325
Bulbs – vanity mirror lighting.....	325



Bulbs – specifications.....	325
Wiper blades – service position.....	326
Wiper blades – windshield.....	327
Engine compartment – washer fluid.....	328
Battery – symbols.....	328
Battery – handling.....	329
Battery – maintenance.....	330
Battery – changing.....	331
Fuses – introduction.....	332
Fuses – engine compartment.....	333
Fuses – glove compartment.....	337
Fuses – cargo area/trunk.....	340
Fuses – engine compartment cold zone (Start/Stop only).....	341
Washing the car.....	343
Automatic car wash.....	344
Polishing and waxing.....	344
Cleaning the interior.....	345
Touching up paintwork.....	347



## 11 Specifications

Label information.....	350
Dimensions.....	353
Weights.....	355
Engine specifications.....	356
Oil specifications.....	358
Oil volume.....	359
Coolant – specification and volume.....	360
Transmission oil – specification and volumes.....	360
Brake fluid – specification and volume... ..	360
Power steering – specification.....	361
Washer fluid – specification and volume .....	361
Fuel tank volume – specification and volume.....	361
Air conditioning – specification and volume.....	362
Battery specifications.....	363
Symbols – general information.....	364
Warning symbols.....	364
Indicator symbols.....	365
Information symbols.....	366
Information symbols – ceiling console....	367
Information symbols – center console....	367



## 12 Index

Index.....	368
------------	-----

12

# 01



## INTRODUCTION





## On-board owner's manual

The owner's manual can be displayed on the center console screen and you can carry out searches for the information that you require.

To open the owner's manual, press the **MY CAR** button on the center console, press **OK/MENU** and select **Owner's manual**.

For basic information, see "Infotainment - operating the system." The following sections also provide more detailed information.

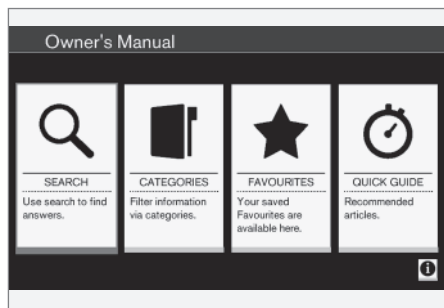

The on-board owner's manual start page

There are four ways of finding information articles in the on-board owner's manual:

- **Searching:** search for an article.
- **Categories:** All of the articles are sorted by category.
- **Favorites:** Quick access to frequently read articles.

- **Quick Guide:** A selection of articles covering commonly used functions.

Select the symbol in the lower right-hand corner for additional information about the on-board owner's manual.

### NOTE

- The on-board owner's manual cannot be accessed while the vehicle is moving.
- Specifications regarding your vehicle are not found in the on-board information. This information is listed in the printed owner's manual.

## Searching for information

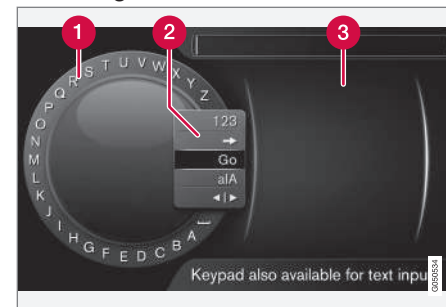

Searching using the text wheel

- 1 List of characters
- 2 Switching between character entry modes (see the following table)
- 3 Surf history

Use the text wheel to enter a web address.

1. Turn **TUNE** to the desired letter and press **OK/MENU** to confirm. The number/letter keys on the center console can also be used.
2. Continue to the next letter, etc. The results of the search will be displayed in the phone book.



- To switch from letter entry mode to the entry mode for numbers or special characters, or to go view surf history, turn **TUNE** to one of the selections (see the explanation in the following table) in the list for switching character entry mode (2) and press **OK/MENU**.

123/A BC	Toggle between letters and numbers by pressing <b>OK/MENU</b> .
=>	This leads to surf history. Turn <b>TUNE</b> to select a web address and press <b>OK/MENU</b> to go to the website.
Go	Go to the website by pressing <b>OK/MENU</b> .
a A	Toggle between upper and lower case letters by pressing <b>OK/MENU</b> .
◀▶	Switch from the text wheel to the <b>Address:</b> field. Use <b>TUNE</b> to move the cursor and erase characters by pressing <b>EXIT</b> . Press <b>OK/MENU</b> to return to the text wheel.  The number/letter keys on the center console can also be used to edit the <b>Address:</b> field.

Press **EXIT** briefly to erase a single character. Press and hold **EXIT** to erase all characters.

Pressing a number key on the center console while the text wheel is displayed (see the previous illustration) will display a list of characters. Press the desired key repeatedly to enter the desired letter and continue to the next letter, etc.

To enter a number, press and hold the button.

## Categories

The articles in the on-board owner's manual are divided into main categories and sub-categories. The same article may be listed in several applicable categories to help make searches easier.

Turn **TUNE** to navigate in the category structure and press **OK/MENU** to open a category (indicated by the symbol) or an article (indicated by the symbol). Press **EXIT** to return to the previous view.

## Favorites

Articles that have been marked as favorites can be found here. For information about marking an article as a favorite, see "Navigating in an article" below.

Turn **TUNE** to navigate in the list of favorites and press **OK/MENU** to open an article. Press **EXIT** to return to the previous view.

## Quick Guide

This is a selection of articles that will help you become familiar with some of the vehicle's most common functions. These articles can also be found in their respective categories but are listed here for quick access.

Turn **TUNE** to navigate in the Quick Guide and press **OK/MENU** to open an article. Press **EXIT** to return to the previous view.

## Navigating in an article

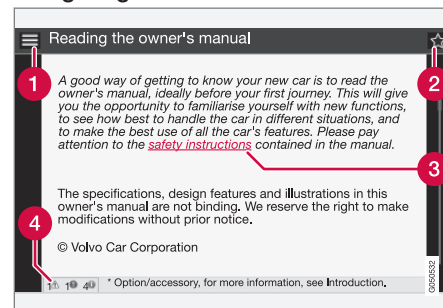

- Home:** Returns you to the owner's manual start page.
- Favorites:** Add/remove an article from the list of favorites. This can also be done by pressing the **FAV** button on the center console keypad.
- Highlighted link:** takes you to the linked article.
- Important information:** if the article contains warnings, cautions or notes, sym-

bols for these types of information and the number of such texts in the article will be displayed here.

Turn **TUNE** to navigate among the links or scroll in an article. When you have scrolled to the beginning/end of an article, you can return to the start page or a favorite by scrolling one additional step up/down. Press **OK/MENU** to activate a selection or highlighted link. Press **EXIT** to return to the previous view.

### Related information

- Information on the Internet (p. 20)

### Owner's information

*Your vehicle is equipped with a screen on which you can display information about your vehicle's features and functions. The printed owner's manual supplements the on-board information and contains important texts, the latest updates and instructions that can be useful in situations when it is not practical to read the information on the screen.*

*Changing the language used for the on-board information could mean that some of the information displayed may not comply with national or local statutes and regulations.*



### WARNING

The driver is always responsible for operating the vehicle in a safe manner and for complying with current statutes and regulations.

It is also essential to maintain and service the vehicle according to Volvo's recommendations as stated in the owner's information and the service and warranty booklet.

If the on-board information differs from the printed owner's manual, the printed information always takes precedence.

### Contacting Volvo

#### In the USA:

Volvo Cars of North America, LLC  
Customer Care Center  
1 Volvo Drive,  
P.O. Box 914  
Rockleigh, New Jersey 07647  
1-800-458-1552  
[www.volvocars.com/us](http://www.volvocars.com/us)

#### In Canada:

Volvo Cars of Canada  
National Customer Service  
9130 Leslie Street, Suite 101  
Richmond Hill, Ontario L4B 0B9  
1-800-663-8255  
[www.volvocars.com/ca](http://www.volvocars.com/ca)

#### Related information

- About this manual (p. 14)
- Important warnings (p. 22)
- Crash event data (p. 18)
- Volvo Structural Parts Statement (p. 19)

## About this manual

*Reading your owner's manual is a good way to familiarize yourself with the features and systems in your vehicle.*

- Before you operate your vehicle for the first time, we recommend that you look through the information found in the chapters "Your Driving Environment" and "During Your Trip."
- Information contained in the balance of the manual is extremely useful and should be read after operating the vehicle for the first time.
- The manual is structured so that it can be used for reference. For this reason, it should be kept in the vehicle for ready access.

## On-board owner's manual

When the printed manual refers to the on-board owner's manual, this pertains to the information displayed on the center console screen.

There are four ways of finding information articles in the on-board owner's manual:

- **Searching:** search for an article.
- **Categories:** All of the articles are sorted by category.
- **Favorites:** Quick access to frequently read articles.
- **Quick Guide:** A selection of articles covering commonly used functions.

Select the symbol in the lower right-hand corner for additional information about the on-board owner's manual.

### i NOTE

- The on-board owner's manual cannot be accessed while the vehicle is moving.
- Specifications regarding your vehicle are not found in the on-board information. This information is listed in the printed owner's manual.

## The owner's manual in mobile devices



### NOTE

The owner's manual mobile app can be downloaded at [www.volvocars.com](http://www.volvocars.com).

The mobile app also contains videos and searchable content, and provides easy navigation between the various articles.

## Footnotes

Certain pages of this manual contain information in the form of footnotes at the bottom of the page. This information supplements the text that the footnote number refers to (a letter is used if the footnote refers to text in a table).

## Display texts

There are several displays in the driver's field of vision that show messages generated by various systems and functions in the vehicle. These texts are indicated in the Owner's Manual by being in slightly larger type than the surrounding text and are printed in gray, (for example: **Change doors unlock setting**).

## Decals

There are various types of decals in the vehicle whose purpose is to provide important information in a clear and concise way. The importance of these decals is explained as follows, in descending order of importance.



### Risk of injury



Black ISO symbols on a yellow warning background, white text/image on a black background. Decals of this type are used to indicate potential danger. Ignoring a warning of this type could result in serious injury or death.

### Risk of damage to the vehicle



White ISO symbols and white text/image on a black or blue warning background and space for a message. If the information on decals of this type is ignored, damage to the vehicle could result.

### Information

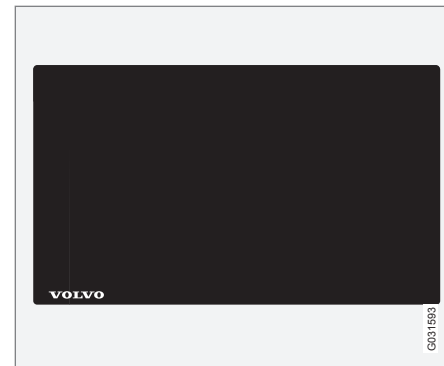

White ISO symbols and white text/image on a black background. These decals provide general information.

#### **i** NOTE

The decals shown in the Owner's Manual are examples only and are not intended to be reproductions of the decals actually used in the vehicle. The purpose is to give an indication of how they look and their approximate location in the vehicle. The applicable information for your particular vehicle can be found on the respective decals in the vehicle.



## Types of lists used in the owner's information

### Procedures

Procedures (step-by-step instructions), or actions that must be carried out in a certain order, are arranged in numbered lists in this manual.

**1** If there is a series of illustrations associated with step-by-step instructions, each step in the procedure is numbered in the same way as the corresponding illustration.

**A** Lists in which letters are used can be found with series of illustrations in cases where the order in which the instructions are carried out is not important.

**➔** Arrows with or without numbers are used to indicate the direction of a movement.

**A➔** Arrows containing letters are used to indicate movement.

If there are no illustrations associated with a step-by-step list, the steps in the procedure are indicated by ordinary numbers.

### Position lists

**1** Red circles containing a number are used in general overview illustrations in which certain components are pointed out. The corresponding number is also used in the position list's description of the various components.

### Bullet lists

Bullets are used to differentiate a number of components/functions/points of information that can be listed in random order.

For example:

- Coolant
- Engine oil

### Continues on next page

▶▶ This symbol can be found at the lower right corner to indicate that the current topic continues on the following page.

### Continuation from previous page

◀◀ This symbol can be found at the upper left corner to indicate that the current topic is a continuation from the previous page.

### Options and accessories

Optional or accessory equipment described in this manual is indicated by an asterisk.

Optional or accessory equipment may not be available in all countries or markets. Please note that some vehicles may be equipped differently, depending on special legal requirements.

Contact your Volvo retailer for additional information.



## NOTE

- Do not export your Volvo to another country before investigating that country's applicable safety and exhaust emission requirements. In some cases it may be difficult or impossible to comply with these requirements. Modifications to the emission control system(s) may render your Volvo not certifiable for legal operation in the U.S., Canada and other countries.
- All information, illustrations and specifications contained in this manual are based on the latest product information available at the time of publication. Please note that some vehicles may be equipped differently, depending on special legal requirements. Optional equipment described in this manual may not be available in all markets.
- Some of the illustrations shown are generic and may not depict the exact model for which this manual is intended.
- Volvo reserves the right to make model changes at any time, or to change specifications or design without notice and without incurring obligation.

**! WARNING**

If your vehicle is involved in an accident, unseen damage may affect its drivability and safety.

**! WARNING****CALIFORNIA proposition 65**

Engine exhaust, some of its constituents, and certain vehicle components contain or emit chemicals known to the state of California to cause cancer, and birth defects or other reproductive harm. In addition, certain fluids contained in vehicles and certain products of component wear contain or emit chemicals known to the State of California to cause cancer, and birth defects or other reproductive harm.

**! WARNING**

Certain components of this vehicle such as air bag modules, seat belt pretensioners, adaptive steering columns, and button cell batteries may contain Perchlorate material. Special handling may apply for service or vehicle end of life disposal.

See [www.dtsc.ca.gov/hazardouswaste/perchlorate](http://www.dtsc.ca.gov/hazardouswaste/perchlorate).

**Shiftlock**

When your vehicle is parked, the gear selector is locked in the **P** (Park) position. To release the selector from this position, the

ignition must be in mode **II** (p. 73) or the engine must be running. Depress the brake pedal, press the button on the front side of the gear selector and move the selector from **P** (Park).

**Anti-lock Brake System (ABS)**

The ABS system performs a brief self-diagnostic test when the engine has been started and driver releases the brake pedal. Another automatic test may be performed when the vehicle first reaches a speed of approximately 6 mph (10 km/h). The brake pedal will pulsate several times and a sound may be audible from the ABS control module. This is normal.

**Fuel filler door**

Press the button on the light switch panel (see the illustration in Refueling – opening/closing fuel filler door (p. 263)) when the vehicle is at a standstill to unlock the fuel filler door. It will relock when closed and there will be an audible click.

**Points to keep in mind**

- Do not export your Volvo to another country before investigating that country's applicable safety and exhaust emission requirements. In some cases it may be difficult or impossible to comply with these requirements. Modifications to the emission control system(s) may render your Volvo not certifiable for legal opera-

tion in the U.S., Canada and other countries.

- All information, illustrations and specifications contained in this manual are based on the latest product information available at the time of publication. Please note that some vehicles may be equipped differently, depending on special legal requirements. Optional equipment described in this manual may not be available in all markets.
- Some of the illustrations shown are generic and may not depict the exact model for which this manual is intended.
- Volvo reserves the right to make model changes at any time, or to change specifications or design without notice and without incurring obligation.

**Related information**

- Information on the Internet (p. 20)
- Volvo and the environment (p. 21)
- Important warnings (p. 22)



## Change of ownership

When the vehicle changes owners, all personal settings should be reset to the factory defaults.

To reset, press the **MY CAR** button in the center console followed by **OK/MENU** and select **Settings** → **Reset to factory settings**.

User data e.g., for apps, the web browser and for personal settings in menus such as the climate system and vehicle settings should be reset to factory defaults.

For vehicles equipped with the optional Volvo On Call with Sensus Connect (VOC), personal settings stored in the vehicle should be deleted, see Changing ownership of a vehicle with Volvo On Call.

### Related information

- Volvo ID (p. 20)

## Crash event data

*This vehicle is equipped with an event data recorder (EDR). The main purpose of an EDR is to record, in certain crash or near crash-like situations, such as an air bag deployment or hitting a road obstacle, data that will assist in understanding how a vehicle's systems performed. The EDR is designed to record data related to vehicle dynamics and safety systems for a short period of time, typically 30 seconds or less. The EDR in this vehicle is designed to record such data as:*

- How various systems in your vehicle were operating;
- Whether or not the driver and passenger safety belts were buckled/fastened;
- How far (if at all) the driver was depressing the accelerator and/or brake pedal; and,
- How fast the vehicle was traveling.

These data can help provide a better understanding of the circumstances in which crashes and injuries occur.



### NOTE

EDR data are recorded by your vehicle only if a non-trivial crash situation occurs; no data are recorded by the EDR under normal driving conditions and no personal data (e.g., name, gender, age, and crash location) are recorded. However, other parties, such as law enforcement, could combine the EDR data with the type of personally identifying data routinely acquired during a crash investigation.

To read data recorded by an EDR, special equipment is required, and access to the vehicle or the EDR is needed. In addition to the vehicle manufacturer, other parties, such as law enforcement, that have the special equipment, can read the information if they have access to the vehicle or the EDR.

Furthermore, your vehicle is equipped with a number of computers whose task is to continuously control and monitor the vehicle's operation. They can also register information during normal driving conditions if they detect a fault relating to the vehicle's operation and functionality. Some of the stored information is required by technicians when carrying out service and maintenance to enable them to diagnose and rectify any faults that have occurred in the vehicle and to enable Volvo to fulfill legal and other regulatory requirements. This information may be stored in the vehicle's computers for a certain period of time.



Volvo will not contribute to spreading the above-mentioned information to third parties without the consent of the vehicle's owner. However, due to national legal requirements and regulations, Volvo may be compelled to provide information of this type to authorities such as law enforcement agencies or others who may assert a legal right to obtain such information.

Volvo and service and repair facilities with agreements with Volvo have access to the special technical equipment required in order to read and interpret the information stored by the vehicle's computers. Volvo is responsible for ensuring that the information transmitted to Volvo during service and maintenance is stored and handled in a secure manner and that this handling is done in accordance with applicable legal requirements. For additional information, contact:

For additional information, contact:

#### **In the United States**

Volvo Cars of North America, LLC  
Customer Care Center  
1 Volvo Drive, P.O. box 914  
Rockleigh, New Jersey 07647  
1-800-458-1552  
[www.volvocars.com/us](http://www.volvocars.com/us)

#### **In Canada**

Volvo Cars of Canada  
National Customer Service  
9130 Leslie Street  
Richmond Hill, Ontario L4B 0B9  
1-800-663-8255  
[www.volvocars.com/ca](http://www.volvocars.com/ca)

#### **Related information**

- Information on the Internet (p. 20)
- Contacting Volvo (p. 13)

#### **Volvo Structural Parts Statement**

*Volvo has always been and continues to be a leader in automotive safety.*

Volvo engineers and manufactures vehicles designed to help protect vehicle occupants in the event of a collision.

Volvos are designed to absorb the impact of a collision. This energy absorption system including, but not limited to, structural components such as bumper reinforcement bars, bumper energy absorbers, frames, rails, fender aprons, A-pillars, B-pillars and body panels must work together to maintain cabin integrity and protect the vehicle occupants.

The supplemental restraint system including but not limited to air bags, side curtain air bags, and deployment sensors work together with the above components to provide proper timing for air bag deployment.

Due to the above, Volvo Cars of North America does not support the use of aftermarket, alternative or anything other than original Volvo parts for collision repair.

In addition Volvo does not support the use or re-use of structural components from an existing vehicle that has been previously damaged. Although these parts may appear equivalent, it is difficult to tell if the parts have been previously replaced with non-OE parts or if the part has been damaged as a result of a prior collision. The quality of these used



parts may also have been affected due to environmental exposure.

## Related information

- Important warnings (p. 22)
- Information on the Internet (p. 20)
- Contacting Volvo (p. 13)

## Information on the Internet

*Additional information regarding your vehicle can be found at [www.volvocars.com](http://www.volvocars.com).*

In order to read a QR code, a QR reader is necessary, which is available as an app for a number of different cell phones and can be downloaded from the App Store or Google Play.



QR code

## Related information

- About this manual (p. 14)
- Contacting Volvo (p. 13)

## Volvo ID

*This is your personal ID that can be used to access a number of services<sup>1</sup>*

## Creating a Volvo ID

To create a Volvo ID, provide your personal email address and then follow the instructions provided in the email that you will receive from Volvo. This can be done from:

- From an Internet-connected vehicle: Enter your email address in the app that requires a Volvo ID and follow the instructions provided or press the Internet connect (🌐) button on the center console and select **Apps**, **Settings** and follow the instructions provided.
- Volvo On Call (VOC\*): download the latest version of the VOC app and create a Volvo ID on the start page.

<sup>1</sup> These services vary and may be subject to change. Consult your Volvo retailer.



## Open Source Software Notice

*The systems in your Volvo contain certain free/open source and other software.*

This product uses certain free / open source and other software originating from third parties, that is subject to the GNU General Public License version 2 and 3 (GPLv2/ GPLv3), GNU Lesser General Public License version 3 (LGPLv3), The FreeType Project License ("FreeType License") and other different and/or additional copyright licenses, disclaimers and notices. The links how to access the exact terms of GPLv2, GPLv3, LGPLv3, and the other open source software licenses, disclaimers, acknowledgements and notices are provided to you below. Please refer to the exact terms of the relevant License, regarding your rights under said licenses. Volvo Car Corporation (VCC) offers to provide the source code of said free/open source software to you for a charge covering the cost of performing such distribution, such as the cost of media, shipping and handling, upon written request. Please contact your nearest Volvo retailer.

This offer is valid for a period of at least three (3) years from the date of the distribution of this product by VCC / or for as long as VCC offers spare parts or customer support.

Portions of this product uses software copyrighted © v2.4.3/2010 The

FreeTypeProject ([www.freetype.org](http://www.freetype.org)). All rights reserved.

### This product includes software under following licenses:

GPL v2 : <http://www.gnu.org/licenses/old-licenses/gpl-2.0.html>

- Linux kernel (merge between MontaVista 2.6.31 kernel and kernel from L2.6.31\_MX51\_ER\_1007 BSP)
- uBoot (based on v2009.08)
- busybox (based on version 1.13.2.)

GCC runtime library exception: <http://www.gnu.org/licenses/gcc-exception.html>

- libgcc\_s.so.1

LGPL v3: <http://www.gnu.org/licenses/lgpl.html>

- Libc.so.6, libpthread.so.0, Librt.so.1

The FreeType Project License: <http://www.freetype.org/FTL.TXT>

- libfreetype.so.6 (version 2.4.3)

### Related information

- About this manual (p. 14)

## Volvo and the environment

*Volvo is committed to the well being of its customers. As a natural part of this commitment, we care about the environment in which we all live. Concern for the environment means an everyday involvement in reducing our environmental impact.*

Volvo's environmental activities are based on a holistic view, which means we consider the overall environmental impact of a product throughout its complete life cycle. In this context, design, production, product use, and recycling are all important considerations. In production, Volvo has partly or completely phased out several chemicals including CFCs, lead chromates, asbestos, and cadmium; and reduced the number of chemicals used in our plants 50% since 1991.

Volvo was the first in the world to introduce into production a three-way catalytic converter with a Lambda sond, now called the heated oxygen sensor, in 1976. The current version of this highly efficient system reduces emissions of harmful substances (CO, HC, NOx) from the exhaust pipe by approximately 95 – 99% and the search to eliminate the remaining emissions continues. Volvo is the only automobile manufacturer to offer CFC-free retrofit kits for the air conditioning system of all models as far back as the 1975 model 240. Advanced electronic engine controls and cleaner fuels are bringing us closer to our goal. In addition to continuous environ-



mental refinement of conventional gasoline-powered internal combustion engines, Volvo is actively looking at advanced technology alternative-fuel vehicles.

When you drive a Volvo, you become our partner in the work to lessen the car's impact on the environment. To reduce your vehicle's environmental impact, you can:

- Maintain proper air pressure in your tires. Tests have shown decreased fuel economy with improperly inflated tires.
- Follow the recommended maintenance schedule in your Warranty and Service Records Information booklet.
- Drive at a constant speed whenever possible.
- See a trained and qualified Volvo service technician as soon as possible for inspection if the check engine (malfunction indicator) light illuminates, or stays on after the vehicle has started.
- Properly dispose of any vehicle-related waste such as used motor oil, used batteries, brake pads, etc.
- When cleaning your vehicle, please use genuine Volvo car care products. All Volvo car care products are formulated to be environmentally friendly.

FSC®



The FSC® (Forest Stewardship Council®) symbol indicates that the wood pulp used in this publication comes from FSC® certified forests and other responsible sources.

#### Related information

- Economical driving (p. 265)
- Tires – tire economy (p. 275)

### Important warnings

*Please keep the following warnings in mind when operating/servicing your vehicle.*

#### Driver distraction

A driver has a responsibility to do everything possible to ensure his or her own safety and the safety of passengers in the vehicle and others sharing the roadway. Avoiding distractions is part of that responsibility.

Driver distraction results from driver activities that are not directly related to controlling the vehicle in the driving environment. Your new Volvo is, or can be, equipped with many feature-rich entertainment and communication systems. These include hands-free cellular telephones, navigation systems, and multi-purpose audio systems. You may also own other portable electronic devices for your own convenience. When used properly and safely, they enrich the driving experience. Improperly used, any of these could cause a distraction.

For all of these systems, we want to provide the following warning that reflects the strong Volvo concern for your safety. Never use these devices or any feature of your vehicle in a way that distracts you from the task of driving safely. Distraction can lead to a serious accident. In addition to this general warning, we offer the following guidance regarding specific newer features that may be found in your vehicle:



- Never use a hand-held cellular telephone while driving. Some jurisdictions prohibit cellular telephone use by a driver while the vehicle is moving.
- If your vehicle is equipped with a navigation system, set and make changes to your travel itinerary only with the vehicle parked.
- Never program your audio system while the vehicle is moving. Program radio presets with the vehicle parked, and use your programmed presets to make radio use quicker and simpler.
- Never use portable computers or personal digital assistants while the vehicle is moving.
- Accessories that have not been approved by Volvo may or may not be specifically tested for compatibility with your vehicle. Additionally, an inexperienced installer may not be familiar with some of your car's systems.
- Any of your car's performance and safety systems could be adversely affected if you install accessories that Volvo has not tested, or if you allow accessories to be installed by someone unfamiliar with your vehicle.
- Damage caused by unapproved or improperly installed accessories may not be covered by your new vehicle warranty. See your Warranty and Service Records Information booklet for more warranty information. Volvo assumes no responsibility for death, injury, or expenses that may result from the installation of non-genuine accessories.

### Accessory installation

- We strongly recommend that Volvo owners install only genuine, Volvo-approved accessories, and that accessory installations be performed only by a trained and qualified Volvo service technician.
- Genuine Volvo accessories are tested to ensure compatibility with the performance, safety, and emission systems in your vehicle. Additionally, a trained and qualified Volvo service technician knows where accessories may and may not be safely installed in your Volvo. In all cases, please consult a trained and qualified Volvo service technician before installing any accessory in or on your vehicle.

### Related information

- About this manual (p. 14)
- Volvo Structural Parts Statement (p. 19)

### Volvo On Call Roadside Assistance

*Your new Volvo comes with a four year ON CALL roadside assistance.*

Additional information, features, and benefits of this program are described in a separate information package in your glove compartment.

If you require assistance, dial:

**In the U.S.** 1-800-638-6586 (1-800-63-VOLVO)

**In Canada** 1-800-263-0475



### NOTE

Some vehicles may be equipped with **Volvo On Call with Sensus Connect**, which will allow access to the call center and additional features directly from the vehicle. This is in addition to the Volvo On Call Roadside Assistance program mentioned above.

**Volvo On Call with Sensus Connect** will be a customer pay subscription offer after an initial complimentary trial period.

### Related information

- Information on the Internet (p. 20)



## **Technician certification**

*In addition to Volvo factory training, Volvo supports certification by the National Institute for Automotive Service Excellence (A.S.E.).*

Certified technicians have demonstrated a high degree of competence in specific areas.

Besides passing exams, each technician must also have worked in the field for two or more years before a certificate is issued.

These professional technicians are best able to analyze vehicle problems and perform the necessary maintenance procedures to keep your Volvo at peak operating condition.

# 02

SAFETY





## Occupant safety

*Safety is Volvo's cornerstone.*

### Volvo's concern for safety

Our concern for safety dates back to 1927 when the first Volvo rolled off the production line. Three-point seat belts (a Volvo invention), safety cages, and energy-absorbing impact zones were designed into Volvo vehicles long before it was fashionable or required by government regulation.

We will not compromise our commitment to safety. We continue to seek out new safety features and to refine those already in our vehicles. You can help. We would appreciate hearing your suggestions about improving automobile safety. We also want to know if you ever have a safety concern with your vehicle. Call us in the U.S. at: 1-800-458-1552 or in Canada at: 1-800-663-8255.

### Occupant safety reminders

How safely you drive doesn't depend on how old you are but rather on:

- How well you see.
- Your ability to concentrate.
- How quickly you make decisions under stress to avoid an accident.

The following suggestions are intended to help you cope with the ever changing traffic environment.

- Never drink and drive.
- If you are taking any medication, consult your physician about its potential effects on your driving abilities.
- Take a driver-retraining course.
- Have your eyes checked regularly.
- Keep your windshield and headlights clean.
- Replace wiper blades when they start to leave streaks.
- Take into account the traffic, road, and weather conditions, particularly with regard to stopping distance.
- Never send text messages while driving.
- Refrain from using or minimize the use of a cell phone while driving.

### Related information

- Recall information (p. 26)
- Reporting safety defects (p. 27)

## Recall information

*Information regarding recalls or other service campaigns is available on our website at [www.volvocars.com/us/](http://www.volvocars.com/us/).*

On our website, select the tab YOUR VOLVO and the heading RECALL INFORMATION will be displayed at the lower left side of the screen. Enter your Vehicle Identification Number for your vehicle (found at the base of the windshield). If your vehicle has any open Recalls, they will be displayed on this page.

### Volvo customers in Canada

For any questions regarding open recalls for your vehicle, please contact your authorized Volvo retailer. If your retailer is unable to answer your questions, please contact Volvo Customer Relations at 905 695-9626, Monday through Friday, 8:30 A.M. to 5:00 P.M. EST or by e-mail at [vlcust@volvocars.com](mailto:vlcust@volvocars.com). You may also write us at:

Volvo Cars of Canada  
National Customer Service  
9130 Leslie Street, Suite 101  
Richmond Hill, Ontario L4B 0B9

### Related information

- Occupant safety (p. 26)
- Reporting safety defects (p. 27)



### Reporting safety defects

*The following information will help you report any perceived safety-related defects in your vehicle.*

#### Reporting safety defects in the U.S.

If you believe that your vehicle has a defect which could cause a crash or could cause injury or death, you should immediately inform the National Highway Traffic Safety Administration (NHTSA) in addition to notifying Volvo Cars of North America, LLC. If NHTSA receives similar complaints, it may open an investigation, and if it finds that a safety defect exists in a group of vehicles, it may order a recall and remedy campaign. However, NHTSA cannot become involved in individual problems between you, your retailer, or Volvo Cars of North America, LLC. To contact NHTSA, you may either call the Auto Safety Hotline toll-free at

1-888-327-4236

(TTY: 1-800-424-9153) or write to: NHTSA, U.S. Department of Transportation, Washington D.C. 20590.

You can also obtain other information about motor vehicle safety from:

<http://www.safercar.gov>

Volvo strongly recommends that if your vehicle is covered under a service campaign, safety or emission recall or similar action, it should be completed as soon as possible. Please check with your local retailer or Volvo Cars of North America, LLC if your vehicle is covered under these conditions.

NHTSA can be reached at:

Internet:

<http://www.nhtsa.gov>

Telephone:

1-888-DASH-2-DOT  
(1-888-327-4236).

#### Reporting safety defects in Canada

If you believe your vehicle has a defect that could cause a crash or could cause injury or death, you should immediately inform Trans-

port Canada in addition to notifying Volvo Cars of Canada Corp.

**Transport Canada can be contacted at:**  
1-800-333-0510

Teletypewriter (TTY): 613 990-4500

Fax: 1-819-994-3372

Mailing Address: Transport Canada - Road Safety, 80 rue Noël, Gatineau, (Quebec) J8Z 0A1

#### Related information

- Occupant safety (p. 26)
- Recall information (p. 26)



## Seat belts – general

Seat belts should always be worn by all occupants of your vehicle. Children should be properly restrained, using an infant, car, or booster seat determined by age, weight and height.

Volvo also believes no child should sit in the front seat of a vehicle.

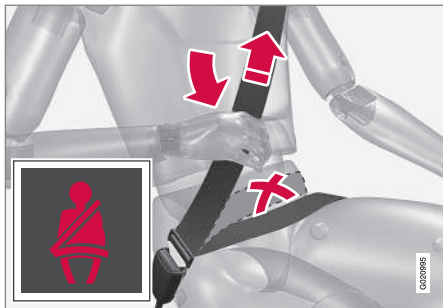

Adjusting the seat belt

Most states and provinces make it mandatory for occupants of a vehicle to use seat belts.

## Seat belt pretensioners

All seat belts are equipped with pretensioners that reduce slack in the belts. These pretensioners are triggered in situations where the front or side impact airbags deploy, and in certain impacts from the rear. The front seat belts also include a tension reducing device which, in the event of a collision, limits the

peak forces exerted by the seat belt on the occupant.

## Seat belt maintenance

Check periodically that the seat belts are in good condition. Use water and a mild detergent for cleaning. Check seat belt mechanism function as follows: attach the seat belt and pull rapidly on the strap.

### WARNING

Never use a seat belt for more than one occupant. Never wear the shoulder portion of the belt under the arm, behind the back or otherwise out of position. Such use could cause injury in the event of an accident. As seat belts lose much of their strength when exposed to violent stretching, they should be replaced after any collision, even if they appear to be undamaged.

### WARNING

- Never repair the belt yourself; have this work done by a trained and qualified Volvo service technician only.
- Any device used to induce slack into the shoulder belt portion of the three-point belt system will have a detrimental effect on the amount of protection available to you in the event of a collision.
- The seat back should not be tilted too far back. The shoulder belt must be taut in order to function properly.
- Do not use child safety seats or child booster cushions/backrests in the front passenger's seat. We also recommend that children who have outgrown these devices sit in the rear seat with the seat belt properly fastened.

## Related information

- Seat belts – buckling/unbuckling (p. 29)
- Seat belt reminder (p. 30)
- Seat belts – pregnancy (p. 30)



## Seat belts – buckling/unbuckling

*Seat belts should be used by all occupants in the vehicle when it is in motion.*

### Buckling a seat belt

Pull the belt out far enough to insert the latch plate into the receptacle until a distinct click is heard. The seat belt retractor is normally "unlocked" and you can move freely, provided that the shoulder belt is not pulled out too far.

### Seat belt retractor

**The seat belt retractor will lock up in the following situations:**

- if the belt is pulled out rapidly
- during braking and acceleration
- if the vehicle is leaning excessively
- when driving in turns
- if the Automatic Locking Retractor/Emergency Locking Retractor (ALR/ELR) is activated

### NOTE

Each seat belt (except for the driver's belt) is equipped with the ALR/ELR function, which is designed to help keep the seat belt taut. ALR/ELR activates if the seat belt is pulled out as far as possible. If this is done, a sound from the seat belt retractor will be audible, which is normal, and the seat belt will be pulled taut and locked in place. This function is automatically disabled when the seat belt is unbuckled and fully retracted.

See also Child restraints (p. 47) for information about using a seat belt's ALR/ELR function to anchor a child seat.

### When wearing the seat belt remember:

- The belt should not be twisted or turned.
- The lap section of the belt must be positioned low on the hips (not pressing against the abdomen).
- Make sure that the shoulder belt is rolled up into its retractor and that the shoulder and lap belts are taut.

### Unbuckling the seat belt

To remove the seat belt, press the red section on the seat belt receptacle. Before exiting the vehicle, check that the seat belt retracts fully after being unbuckled. If necessary, guide the belt back into the retractor slot.

### Related information

- Seat belt reminder (p. 30)
- Seat belts – pregnancy (p. 30)



## Seat belt reminder

The seat belt reminder is intended to alert all occupants of the vehicle that their seat belts should be fastened before the vehicle begins to move.



Seat belt reminder light in ceiling console

The seat belt reminder consists of an audible signal, an indicator light near the rearview mirror and a symbol in the instrument panel that alert all occupants of the vehicle to fasten their seat belts (p. 28). The audible signal and indicator light will be on for several seconds from the time the ignition is switched on, **regardless of whether or not** the seat belts are fastened.

If the front seat belts are unbuckled while the vehicle is in motion, the audible signal and warning light will be active for a several seconds.

## Rear seats

The seat belt reminder in the rear seat has two additional functions:

- It provides information about which seat belts are fastened in the rear seat. A message will appear in the information display when a belt is being used. This message will disappear after several seconds or can be erased by pressing the **OK** button on the left steering wheel lever.
- It also provides a reminder if one of the occupants of the rear seat has unbuckled his/her seat belt while the vehicle is in motion. A visual and audible signal will be given. These signals will stop when the seat belt has been re-buckled or can be stopped by pressing the **OK** button.
- The message **Unbelted in rear seat** will appear in the information display if one of the rear doors has been opened.

The message in the information display can always be accessed, even if it has been erased, by pressing the **OK** button to display stored messages.

## Related information

- Seat belts – pregnancy (p. 30)

## Seat belts – pregnancy

The seat belt should always be worn during pregnancy. However, it is crucial that it be worn correctly.



The diagonal section should wrap over the shoulder then be routed between the breasts and to the side of the belly. The lap section should lay flat over the thighs and as low as possible under the belly. It must never be allowed to ride upward. Remove all slack from the belt and ensure that it fits close to the body without any twists.

As a pregnancy progresses, pregnant drivers should adjust their seats and steering wheel such that they can easily maintain control of the vehicle as they drive (which means they must be able to easily operate the foot pedals and steering wheel). Within this context, they should strive to position the seat with as large



a distance as possible between their belly and the steering wheel.

### Related information

- Seat belts – buckling/unbuckling (p. 29)
- Seat belt reminder (p. 30)
- Child restraints (p. 47)

### Supplemental Restraint System (SRS)

As an enhancement to the three-point seat belts (p. 28), your Volvo is equipped with a Supplemental Restraint System (SRS).

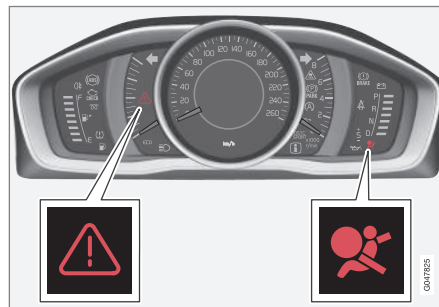

Models with an analog instrument panel

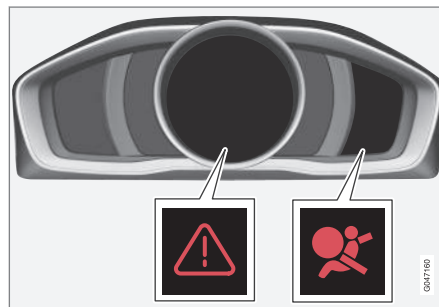

Models with a digital instrument panel\*

Volvo's SRS consists of seat belt pretensioners, front airbags (p. 32), side impact air-

bags (p. 39), a front passenger occupant weight sensor (p. 36), and inflatable curtains (p. 41). All of these systems are monitored by the SRS control module. An SRS warning light in the instrument panel (see the illustration) illuminates when the ignition is in modes **I** or **II**, and will normally go out after approximately 6 seconds if no faults are detected in the system.

Where applicable, a text message will also be displayed when the SRS warning light illuminates. If this warning symbol is not functioning properly, the general warning symbol illuminates and a text message will be displayed.

See also Information displays – indicator symbols (p. 66) and Information displays – warning symbols (p. 68) for more information about indicator and warning lights.



## WARNING

- If the SRS warning light stays on after the engine has started or if it illuminates while you are driving, have the vehicle inspected by a trained and qualified Volvo service technician as soon as possible.
- Never try to repair any component or part of the SRS yourself. Any interference in the system could cause malfunction and serious injury. All work on these systems should be performed by a trained and qualified Volvo service technician.

## WARNING

If your vehicle has become flood-damaged in any way (e.g., soaked carpeting/standing water on the floor of the vehicle), do not attempt to start the vehicle or insert the remote key into the ignition slot before disconnecting the battery (see below). This may cause airbag deployment which could result in serious injury. Have the vehicle towed to a trained and qualified Volvo service technician for repairs.

Before attempting to tow the vehicle:

1. Switch off the ignition for at least 10 minutes and disconnect the battery.
2. Follow the instructions for manually overriding the shiftlock system Trans-mission – shiftlock override (p. 242).

### Related information

- Crash mode – general information (p. 44)

## Front airbags

*The front airbags supplement the three-point seat belts (p. 28). For these airbags to provide the protection intended, seat belts must be worn at all times.*

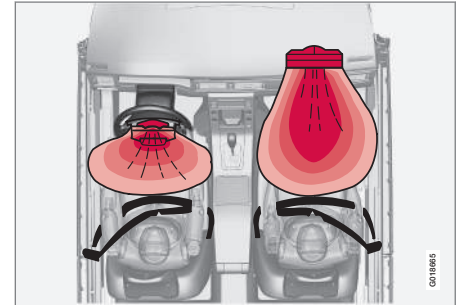

### The front airbag system

The front airbag system includes gas generators surrounded by the airbags, and deceleration sensors that activate the gas generators, causing the airbags to be inflated with nitrogen gas.

CG 11985



Location of the passenger's side front airbag

As the movement of the seats' occupants compresses the airbags, some of the gas is expelled at a controlled rate to provide better cushioning. Both seat belt pretensioners also deploy, minimizing seat belt slack. The entire process, including inflation and deflation of the airbags, takes approximately one fifth of a second.

The location of the front airbags is indicated by **SRS AIRBAG** embossed on the steering wheel pad and above the glove compartment, and by decals on both sun visors and on the front and far right side of the dash.

The driver's side front airbag is folded and located in the steering wheel hub.

The passenger's side front airbag is folded behind a panel located above the glove compartment.

**WARNING**

- The airbags in the vehicle are designed to be a SUPPLEMENT to—not a replacement for—the three-point seat belts. For maximum protection, wear seat belts at all times. Be aware that no system can prevent all possible injuries that may occur in an accident.
- Never drive with your hands on the steering wheel pad/airbag housing.
- The front airbags are designed to help prevent serious injury. Deployment occurs very quickly and with considerable force. During normal deployment and depending on variables such as seating position, one may experience abrasions, bruises, swellings, or other injuries as a result from deployment of one or both of the airbags.
- When installing any accessory equipment, make sure that the front airbag system is not damaged. Any interference in the system could cause malfunction.

**Front airbag deployment**

- The front airbags are designed to deploy during certain frontal or front-angular collisions, impacts, or decelerations, depending on the crash severity, angle, speed and object impacted. The airbags may also deploy in certain non-frontal

collisions where rapid deceleration occurs.

- The SRS (p. 31) sensors, which trigger the front airbags, are designed to react to both the impact of the collision and the inertial forces generated by it, and to determine if the intensity of the collision is sufficient for the seat belt pretensioners and/or airbags to be deployed.

However, not all frontal collisions activate the front airbags.

- If the collision involves a nonrigid object (e.g., a snow drift or bush), or a rigid, fixed object at a low speed, the front airbags will not necessarily deploy.
- Front airbags do not normally deploy in a side impact collision, in a collision from the rear or in a rollover situation.
- The amount of damage to the bodywork does not reliably indicate if the airbags should have deployed or not.

**WARNING**

If any of the airbags have deployed:

- Do not attempt to drive the vehicle. Have it towed to a qualified repair facility.
- If necessary seek medical attention.



## **WARNING**

- Do not use child safety seats or child booster cushions/backrests in the front passenger's seat. We also recommend that occupants under 4 feet 7 inches (140 cm) in height who have outgrown these devices sit in the rear seat with the seat belt fastened<sup>1</sup>.
- Never drive with the airbags deployed. The fact that they hang out can impair the steering of your vehicle. Other safety systems can also be damaged.
- The smoke and dust formed when the airbags are deployed can cause skin and eye irritation in the event of prolonged exposure.

Should you have questions about any component in the SRS system, please contact a trained and qualified Volvo service technician or Volvo customer support:

### **In the USA**

Volvo Cars of North America, LLC

Customer Care Center

1 Volvo Drive

P.O. Box 914

Rockleigh, New Jersey 07647

1-800-458-1552

[www.volvocars.com/us](http://www.volvocars.com/us)

### **In Canada**

Volvo Cars of Canada Corp.

National Customer Service

9130 Leslie Street, Suite 101

Richmond Hill, Ontario L4B 0B9

1-800-663-8255

[www.volvocars.com/ca](http://www.volvocars.com/ca)



## **NOTE**

- Deployment of front airbags occurs only one time during an accident. In a collision where deployment occurs, the airbags and seat belt pretensioners activate. Some noise occurs and a small amount of powder is released. The release of the powder may appear as smoke-like matter. This is a normal characteristic and does not indicate fire.
- Volvo's front airbags use special sensors that are integrated with the front seat buckles. The point at which the airbag deploys is determined by whether or not the seat belt is being used, as well as the severity of the collision.
- Collisions can occur where only one of the airbags deploys. If the impact is less severe, but severe enough to present a clear injury risk, the airbags are triggered at partial capacity. If the impact is more severe, the airbags are triggered at full capacity.

<sup>1</sup> See also the Occupant Weight Sensor information, (p. 36).



## Airbag decals



Airbag decal on the outside of both sun visors



Passenger's side airbag decal

## WARNING

- Children must never be allowed in the front passenger's seat.
- Occupants in the front passenger's seat must never sit on the edge of the seat, sit leaning toward the instrument panel or otherwise sit out of position.
- The occupant's back must be as upright as comfort allows and be against the seat back with the seat belt properly fastened.
- Feet must be on the floor, e.g., not on the dash, seat or out of the window.

## WARNING

- No objects or accessory equipment, e.g. dashboard covers, may be placed on, attached to, or installed near the air bag hatch (the area above the glove compartment) or the area affected by airbag deployment.
- There should be no loose articles, such as coffee cups on the floor, seat, or dashboard area.
- Never try to open the airbag cover on the steering wheel or the passenger's side dashboard. This should only be done by a trained and qualified Volvo service technician.
- Failure to follow these instructions can result in injury to the vehicle occupants.

## Related information

- Occupant Weight Sensor (p. 36)
- Side impact protection (SIPS) airbags (p. 39)
- Inflatable Curtain (IC) (p. 31)
- Supplemental Restraint System (SRS) (p. 31)



## Occupant Weight Sensor

The Occupant Weight Sensor (OWS) is designed to meet the regulatory requirements of Federal Motor Vehicle Safety Standard (FMVSS) 208 and is designed to disable (will not inflate) the passenger's side front airbag under certain conditions.



Occupant Weight Sensor (OWS) indicator light

### Disabling the passenger's side front airbag

Volvo recommends that ALL occupants (adults and children) shorter than 4 feet 7 inches (140 cm) be seated in the back seat of any vehicle with a front passenger side airbag (p. 32), and be properly restrained for their size and weight. For child safety recommendations, see Child safety (p. 45).

The OWS works with sensors that are part of the front passenger's seat and seat belt (p. 28). The sensors are designed to

detect the presence of a properly seated occupant and determine if the passenger's side front airbag should be enabled (may inflate) or disabled (will not inflate).

The OWS will disable (will not inflate) the passenger's side front airbag when:

- the front passenger's seat is unoccupied, or has small/medium objects in the front seat,
- the system determines that an infant is present in a rear-facing infant seat that is installed according to the manufacturer's instructions,
- the system determines that a small child is present in a forward-facing child restraint that is installed according to the manufacturer's instructions,
- the system determines that a small child is present in a booster seat,
- a front passenger takes his/her weight off of the seat for a period of time,
- a child or a small person occupies the front passenger's seat.

The OWS uses a PASSENGER AIRBAG OFF indicator lamp which will illuminate and stay on to remind you that the passenger's side front airbag is disabled. The PASSENGER AIRBAG OFF indicator lamp is located in the overhead console, near the base of the rear-view mirror.



## NOTE

When the ignition is switched on, the OWS indicator light will go on for up to 10 seconds while the system performs a self-diagnostic test.

However, if a fault is detected in the system:

- The OWS indicator light will stay on
- The SRS warning light (p. 31) will come on and stay on
- The message **Pass. Airbag OFF Service urgent** will be displayed in the information display.



## WARNING

If a fault in the system is detected and indicated as described, be aware that the passenger's side front airbag will not deploy in the event of a collision. In this case, the SRS system and Occupant Weight Sensor should be inspected by a trained and qualified Volvo service technician as soon as possible.



**! WARNING**

- Never try to open, remove, or repair any components in the OWS system. This could result in system malfunction. Maintenance or repairs should only be carried out by an a trained and qualified Volvo service technician.
- The front passenger's seat should not be modified in any way. This could reduce pressure on the seat cushion, which might interfere with the OWS system's function.

Passenger's seat occupancy status	OWS indicator light status	Passenger's side front air-bag status
Seat unoccupied	OWS indicator light lights up.	Passenger's side front air-bag disabled
Seat occupied by low weight occupant/object <sup>A</sup>	OWS indicator light lights up	Passenger's side front air-bag disabled
Seat occupied by heavy occupant/object	OWS indicator light is <b>not</b> lit	Passenger's side front air-bag enabled

<sup>A</sup> Volvo recommends that children always be properly restrained in appropriate child restraints in the rear seats. Do not assume that the passenger's side front airbag is disabled unless the PASSENGER AIRBAG OFF indicator lamp is lit. Make sure the child restraint is properly installed. If there is any doubt as to the status of the passenger's side front airbag, move the child restraint to the rear seat.

The OWS is designed to enable (may inflate) the passenger's side front airbag in the event of a collision anytime the system senses that a person of adult size is sitting properly in the front passenger's seat. The PASSENGER AIRBAG OFF indicator lamp will be off and remain off.

If a person of adult size is sitting in the front passenger's seat, but the PASSENGER AIRBAG OFF indicator lamp is on, it is possible that the person isn't sitting properly in the seat. If this happens:

- Turn the vehicle off and ask the person to place the seatback in an upright position.
- Have the person sit upright in the seat, centered on the seat cushion, with the person's legs comfortably extended.
- Restart the vehicle and have the person remain in this position for about two minutes. This will allow the system to detect that person and enable the passenger's frontal airbag.
- If the PASSENGER AIRBAG OFF indicator lamp remains on even after this, the person should be advised to ride in the rear seat.

This condition reflects limitations of the OWS classification capability. It does not indicate OWS malfunction.

**Modifications**

If you are considering modifying your vehicle in any way to accommodate a disability, for example by altering or adapting the driver's or front passenger's seat(s) and/or airbag systems, please contact Volvo at:

**In the USA**

Volvo Cars of North America, LLC  
Customer Care Center





1 Volvo Drive

P.O. Box 914

Rockleigh, New Jersey 07647

1-800-458-1552

### In Canada

Volvo Cars of Canada Corp.

National Customer Service

9130 Leslie Street, Suite 101

Richmond Hill, Ontario L4B 0B9

1-800-663-8255



### WARNING

- No objects that add to the total weight on the seat should be placed on the front passenger's seat. If a child is seated in the front passenger's seat with any additional weight, this extra weight could cause the OWS system to enable the airbag, which might cause it to deploy in the event of a collision, thereby injuring the child.
- The seat belt should never be wrapped around an object on the front passenger's seat. This could interfere with the OWS system's function.
- The front passenger's seat belt should never be used in a way that exerts more pressure on the passenger than normal. This could increase the pressure exerted on the weight sensor by a child, and could result in the airbag being enabled, which might cause it to deploy in the event of a collision, thereby injuring the child.



### WARNING

- Keep the following points in mind with respect to the OWS system. Failure to follow these instructions could adversely affect the system's function and result in serious injury to the occupant of the front passenger's seat:
- The full weight of the front seat passenger should always be on the seat cushion. The passenger should never lift him/herself off the seat cushion using the armrest in the door or the center console, by pressing the feet on the floor, by sitting on the edge of the seat cushion, or by pressing against the backrest in a way that reduces pressure on the seat cushion. This could cause OWS to disable the front, passenger's side airbag.



## **!** WARNING

- Do not place any type of object on the front passenger's seat in such a way that jamming, pressing, or squeezing occurs between the object and the front seat, other than as a direct result of the correct use of the Automatic Locking Retractor/Emergency Locking Retractor (ALR/ELR) seat belt (Child restraints (p. 47)).
- No objects should be placed under the front passenger's seat. This could interfere with the OWS system's function.

### Related information

- Supplemental Restraint System (SRS) (p. 31)

## Side impact protection (SIPS) airbags

As an enhancement to the structural side impact protection built into your vehicle, it is also equipped with Side Impact Protection System (SIPS) airbags.



Location of the side impact (SIPS) airbags (front seats only)

The SIPS airbag system is designed to help increase occupant protection in the event of certain side impact collisions. The SIPS airbags are designed to deploy only during certain side-impact collisions, depending on the crash severity, angle, speed and point of impact.

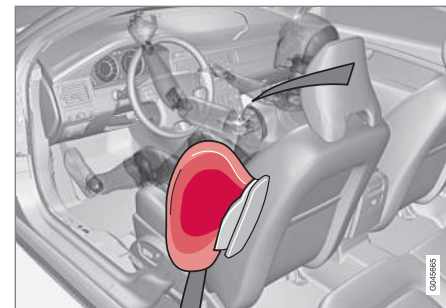

Driver's side SIPS airbag

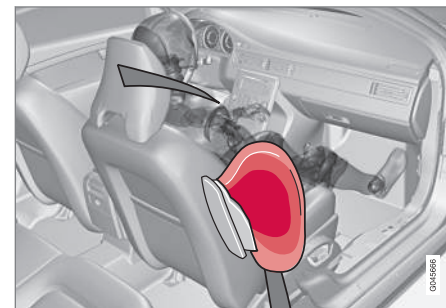

Passenger's side SIPS airbag

### **i** NOTE

SIPS airbag deployment (one airbag) occurs only on the side of the vehicle affected by the impact. The airbags are not designed to deploy in all side impact situations.



### Components in the SIPS airbag system

This SIPS airbag system consists of a gas generator, the side airbag modules built into the outboard sides of both front seat backrests, and electronic sensors/wiring.



### WARNING

- The SIPS airbag system is a supplement to the structural Side Impact Protection System and the three-point seat belt system. It is not designed to deploy during collisions from the front or rear of the vehicle or in rollover situations.
- The use of seat covers on the front seats may impede SIPS airbag deployment.
- No objects, accessory equipment or stickers may be placed on, attached to or installed near the SIPS airbag system or in the area affected by SIPS airbag deployment.
- Never try to open or repair any components of the SIPS airbag system. This should be done only by a trained and qualified Volvo service technician.
- In order for the SIPS airbag to provide its best protection, both front seat occupants should sit in an upright position with the seat belt properly fastened.
- Failure to follow these instructions can result in injury to the occupants of the vehicle in the event of an accident.

### Related information

- Supplemental Restraint System (SRS) (p. 31)
- Front airbags (p. 32)
- Inflatable Curtain (IC) (p. 41)



## Inflatable Curtain (IC)

The inflatable curtain is designed to help protect the heads of the occupants of the front seats and the occupant of the outboard rear seating positions in certain side impact collisions.

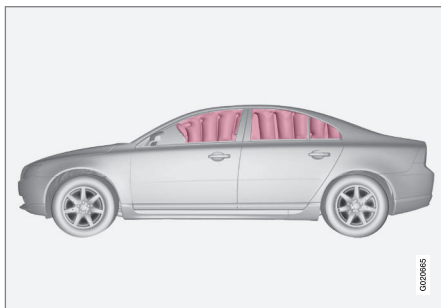

This system consists of inflatable curtains located along the sides of the roof liners, stretching from the center of both front side windows to the rear edge of the rear side door windows.

In certain side impacts, **both** the Inflatable Curtain (IC) and the Side Impact Airbag System (p. 39) (SIPS airbag) will deploy. The IC and the SIPS airbag deploy simultaneously.

### NOTE

If the inflatable curtain deploys, it remains inflated for approximately 3 seconds.

### WARNING

- The IC system is a supplement to the Side Impact Protection System. It is not designed to deploy during collisions from the rear of the vehicle or in rollover situations.
- Never try to open or repair any components of the IC system. This should be done only by a trained and qualified Volvo service technician.
- Never hang heavy items from the ceiling handles. This could impede deployment of the Inflatable Curtain.
- The rear seat should not be loaded to a level higher than 2 in. (5 cm) below the upper edge of the rear side windows. Objects placed higher than this level could impede the function of the Inflatable Curtain.

### WARNING

In order for the IC to provide its best protection, both front seat occupants and both outboard rear seat occupants should sit in an upright position with the seat belt properly fastened; adults using the seat belt and children using the proper child restraint system. Only adults should sit in the front seats. Children must never be allowed in the front passenger seat, Child safety (p. 45) for guidelines. Failure to follow these instructions can result in injury to the vehicle occupants in an accident.

### Related information

- Supplemental Restraint System (SRS) (p. 31)
- Front airbags (p. 32)
- Child safety (p. 45)



### Whiplash Protection System (WHIPS)

The WHIPS system consists of specially designed hinges and brackets on the front seat backrests designed to help absorb some of the energy generated in a collision from the rear (when the vehicle is rear-ended).

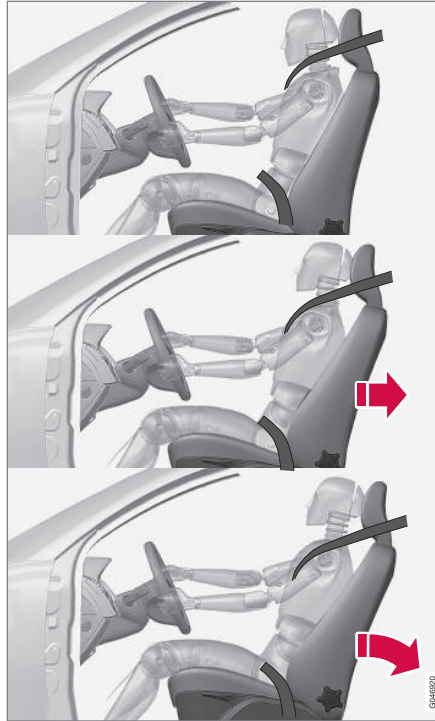

In the event of a rear-end collision, the hinges and brackets of the front seat backrests are designed to change position slightly to allow the backrest/head restraint to help support the occupant's head before moving slightly

rearward. This movement helps absorb some of the forces that could result in whiplash.



### WARNING

- The WHIPS system is designed to supplement the other safety systems in your vehicle. For this system to function properly, the three-point seat belt must be worn. Please be aware that no system can prevent all possible injuries that may occur in an accident.
- The WHIPS system is designed to function in certain collisions from the rear, depending on the crash severity, angle and speed.



### WARNING

- Occupants in the front seats must never sit out of position. The occupant's back must be as upright as comfort allows and be against the seat back with the seat belt properly fastened.
- If your vehicle has been involved in a rear-end collision, the front seat backrests must be inspected by a trained and qualified Volvo service technician, even if the seats appear to be undamaged. Certain components in the WHIPS system may need to be replaced.
- Do not attempt to service any component in the WHIPS system yourself.



### WARNING

- Boxes, suitcases, etc. wedged behind the front seats could impede the function of the WHIPS system.
- If the rear seat backrests are folded down, cargo must be secured to prevent it from sliding forward against the front seat backrests in the event of a collision from the rear. This could interfere with the action of the WHIPS system.

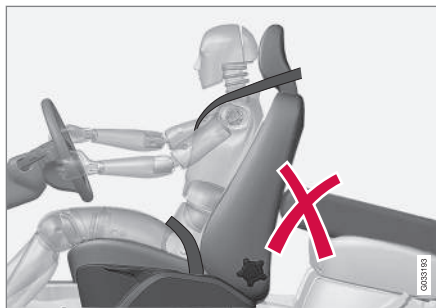

### WARNING

Any contact between the front seat backrests and the folded rear seat or a rear-facing child seat could impede the function of the WHIPS system. If the rear seat is folded down, the occupied front seats must be adjusted forward so that they do not touch the folded rear seat.

### Related information

- Seat belts – general (p. 28)



## Crash mode – general information

After a collision, the functionality of some of the vehicle's systems may be reduced as a safety precaution.

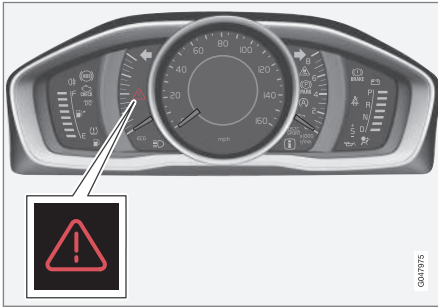

Warning symbol: analog instrument panel

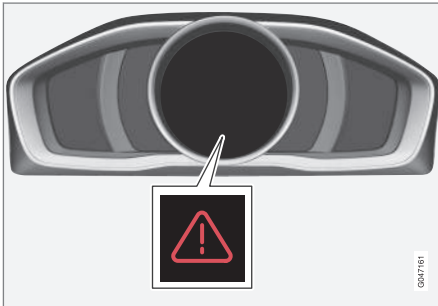

Warning symbol: digital instrument panel\*

If the vehicle has been involved in a collision, the text **Safety mode See manual** may appear in the information display.

### NOTE

This text can only be shown if the display is undamaged and the vehicle's electrical system is intact.

Crash mode is a feature that is triggered if one or more of the safety systems (e.g. front (p. 32) or side airbags (p. 39), an inflatable curtain (p. 41), or one or more of the seat belt pretensioners) has deployed. The collision may have damaged an important function in the vehicle, such as the fuel lines, sensors for one of the safety systems, the brake system, etc.

### WARNING

- Never attempt to repair the vehicle yourself or to reset the electrical system after the vehicle has displayed **Safety mode See manual**. This could result in injury or improper system function.
- Restoring the vehicle to normal operating status should only be done by a trained and qualified Volvo service technician.
- After **Safety mode See manual** has been displayed, if you detect the odor of fuel vapor, or see any signs of fuel leakage, do not attempt to start the vehicle. Leave the vehicle immediately.

### Related information

- Crash mode – starting the vehicle (p. 45)
- Crash mode – moving the vehicle (p. 45)



### Crash mode – starting the vehicle

If Crash mode has been set Crash mode (p. 44) and damage to the vehicle is minor and there is no fuel leakage, you may attempt to start the engine.

To do so:

1. Remove the remote key from the ignition slot and open the driver's door. If a message is displayed that the ignition is on, press the start button.
2. Close the driver's door and reinsert the remote key in the ignition slot.
3. Try to start the vehicle.

#### WARNING

If the message **Safety mode See manual** is still displayed, the vehicle should not be driven and must be towed. Concealed faults may make the vehicle difficult to control.

#### Related information

- Crash mode – general information (p. 44)
- Crash mode – moving the vehicle (p. 45)

### Crash mode – moving the vehicle

If the message **Normal mode** appears after an attempt has been made to start the engine, Starting the vehicle after a crash (p. 45), the vehicle may be moved carefully from its present position, if for example, it is blocking traffic. It should, however, not be moved farther than is absolutely necessary.

#### WARNING

Even if the vehicle appears to be drivable after Crash mode has been set, it should not be driven or towed (pulled by another vehicle). There may be concealed damage that could make it difficult or impossible to control. The vehicle should be transported on a flatbed tow truck to a trained and qualified Volvo service technician for inspection/repairs.

#### Related information

- Crash mode – general information (p. 44)

### Child safety

Children should always be seated safely when traveling in the vehicle.

#### General information

Volvo recommends the proper use of restraint systems (p. 47) for all occupants including children. Remember that, regardless of age and size, a child should always be properly restrained in a vehicle.

Your vehicle is also equipped with ISOFIX/LATCH attachments (p. 54), which make it more convenient to install child seats.

Some restraint systems for children are designed to be secured in the vehicle by lap belts or the lap portion of a lap-shoulder belt. Such child restraint systems can help protect children in vehicles in the event of an accident only if they are used properly. However, children could be endangered in a crash if the child restraints are not properly secured in the vehicle. Failure to follow the installation instructions for your child restraint can result in your child striking the vehicle's interior in a sudden stop.

Holding a child in your arms is NOT a suitable substitute for a child restraint system. In an accident, a child held in a person's arms can be crushed between the vehicle's interior and an unrestrained person. The child could also be injured by striking the interior, or by being ejected from the vehicle during a sudden maneuver or impact. The same can also hap-



pen if the infant or child rides unrestrained on the seat. Other occupants should also be properly restrained to help reduce the chance of injuring or increasing the injury of a child.

All states and provinces have legislation governing how and where children should be carried in a vehicle. Find out the regulations existing in your state or province. Recent accident statistics have shown that children are safer in rear seating positions than front seating positions when properly restrained. A child restraint system can help protect a child in a vehicle. Here's what to look for when selecting a child restraint system:

It should have a label certifying that it meets applicable Federal Motor Vehicle Safety Standards (FMVSS 213) – or in Canada, CMVSS 213.

Make sure the child restraint system is approved for the child's height, weight and development – the label required by the standard or regulation, or instructions for infant restraints, typically provide this information.

In using any child restraint system, we urge you to carefully look over the instructions that are provided with the restraint. Be sure you understand them and can use the device properly and safely in this vehicle. A misused child restraint system can result in increased injuries for both the infant or child and other occupants in the vehicle.

When a child has outgrown the child safety seat, you should use the rear seat with the standard seat belt fastened. The best way to help protect the child here is to place the child on a cushion so that the seat belt is properly located on the hips (see Booster cushions (p. 53) for illustration). Legislation in your state or province may mandate the use of a child seat or cushion in combination with the seat belt, depending on the child's age and/or size. Please check local regulations.

A specially designed and tested booster cushion and backrest can be obtained from your Volvo retailer.

**USA:** for children weighing 33 – 80 lbs. (15 – 36 kg) and 38 – 54 inches (97 – 137 cm) in height

**Canada:** for children weighing 40 – 80 lbs. (18 – 36 kg) and 40 – 54 inches (102 – 137 cm) in height



### WARNING

- Do not use child safety seats or child booster cushions/backrests in the front passenger's seat. We also recommend that children under 4 feet 7 inches (140 cm) in height who have outgrown these devices sit in the rear seat with the seat belt fastened.
- Keep vehicle doors and trunk locked and keep remote controls out of a child's reach. Unsupervised children could lock themselves in an open trunk and risk injury. Children should be taught not to play in vehicles.
- On hot days, the temperature in the vehicle interior can rise very quickly. Exposure to these high temperatures for even a short period of time can cause heat-related injury or death. Small children are particularly at risk.

Child seat should always be registered. See Child restraints (p. 47) for more information.

### Volvo's recommendations

Why does Volvo believe that no child should sit in the front seat of a car? It's quite simple really. A front airbag (p. 32) is a very powerful device designed, by law, to help protect an adult.

Because of the size of the airbag and its speed of inflation, a child should never be placed in the front seat, even if he or she is



properly belted or strapped into a child safety seat. Volvo has been an innovator in safety for over seventy-five years, and we'll continue to do our part. But we need your help. Please remember to put your children in the back seat, and buckle them up.

### Volvo has some very specific recommendations:

- Always wear your seat belt (p. 28).
- Airbags are a SUPPLEMENTAL safety device which, when used with a three-point seat belt can help reduce serious injuries during certain types of accidents. Volvo recommends that you do not disconnect the airbag system in your vehicle.
- Volvo strongly recommends that everyone in the vehicle be properly restrained.
- Volvo recommends that ALL occupants (adults and children) shorter than 4 feet 7 inches (140 cm) be seated in the back seat of any vehicle with a front passenger side airbag.
- Drive safely!

### Related information

- Infant seats (p. 49)
- Convertible seats (p. 51)
- Booster cushions (p. 53)
- Child safety locks (p. 57)
- Top tether anchors (p. 56)

## Child restraints

*Suitable child restraints should always be used when children travel in the vehicle.*

### Child restraint systems

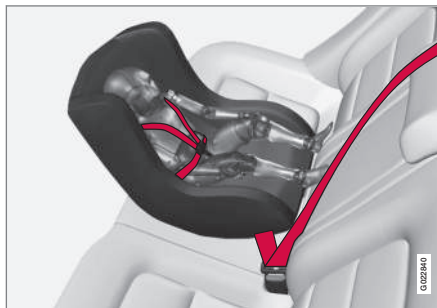

*Infant seat*

There are three main types of child restraint systems: infant seats (p. 49), convertible seats (p. 51), and booster cushions (p. 53). They are classified according to the child's age and size.

The following section provides **general information** on securing a child restraint using a three-point seat belt (p. 28). Refer to ISOFIX/LATCH lower anchors (p. 54) and Top tether anchors (p. 56) for information on securing a child restraint using ISOFIX/LATCH lower anchors and/or top tether anchorages.

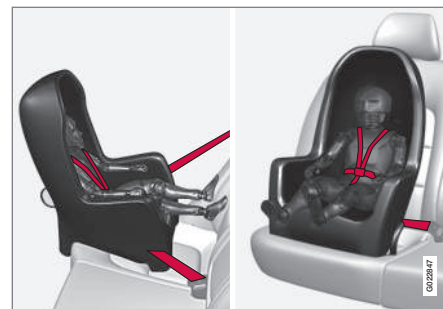

*Convertible seat*



### WARNING

A child seat should never be used in the front passenger seat of any vehicle with a front passenger airbag – not even if the "Passenger airbag off" symbol near the rear-view mirror is illuminated (on vehicles equipped with Occupant Weight Sensor). If the severity of an accident were to cause the airbag to inflate, this could lead to serious injury or death to a child seated in this position.



Booster cushion

## WARNING

Always refer to the child restraint manufacturer's instructions for detailed information on securing the restraint.

## WARNING

- When not in use, keep the child restraint system secured or remove it from the passenger compartment to help prevent it from injuring passengers in the event of a sudden stop or collision.
- A small child's head represents a considerable part of its total weight and its neck is still very weak. Volvo recommends that children up to age 4 travel, properly restrained, facing rearward. In addition, Volvo recommends that children should ride rearward facing, properly restrained, as long as possible.

### Automatic Locking Retractor/ Emergency Locking Retractor (ALR/ ELR)

To make child seat installation easier, each seat belt (except for the driver's belt) is equipped with a locking mechanism to help keep the seat belt taut.

#### When attaching the seat belt to a child seat:

1. Attach the seat belt to the child seat according to the child seat manufacturer's instructions.
2. Pull the seat belt out as far as possible.

3. Insert the seat belt latch plate into the buckle (lock) in the usual way.
4. Release the seat belt and pull it taut around the child seat.

A sound from the seat belt retractor will be audible at this time and is normal. The belt will now be locked in place. This function is automatically disabled when the seat belt is unlocked and the belt is fully retracted.

## WARNING

Do not use child safety seats or child booster cushions/backrests in the front passenger's seat. We also recommend that children who have outgrown these devices sit in the rear seat with the seat belt properly fastened.

### Child restraint registration and recalls

Child restraints could be recalled for safety reasons. You must register your child restraint to be reached in a recall. To stay informed about child safety seat recalls, be sure to fill out and return the registration card that comes with new child restraints.

Child restraint recall information is readily available in both the U.S. and Canada. For recall information in the U.S., call the U.S. Government's Auto Safety Hotline at 1-800-424-9393 or go to <http://www-odi.nhtsa.dot.gov/cars/problems/recalls/register/childseat/index.cfm>. In Canada, visit Transport Canada's Child Safety website at



<http://www.tc.gc.ca/roadsafety/childsafety/menu.htm>.

### Related information

- Child safety locks (p. 57)

### Infant seats

*Suitable child restraints should always be used when children (depending on their age/size) are seated in the vehicle.*

### Securing an infant seat with a seat belt



*Do not place the infant seat in the front passenger's seat*

### **i** NOTE

Refer to (p. 54) and (p. 56) for information on securing a child restraint using ISOFIX/LATCH lower anchors and/or top tether anchorages.

1. Place the infant seat in the rear seat of the vehicle.
2. Attach the seat belt to the infant seat according to the manufacturer's instructions.



*Positioning the seat belt through the infant seat*

### **!** WARNING

- An infant seat must be in the rear-facing position only.
- The infant seat should not be positioned behind the driver's seat unless there is adequate space for safe installation.



## WARNING

A child seat should never be used in the front passenger seat of any vehicle with a front passenger airbag – not even if the "Passenger airbag off" symbol near the rear-view mirror is illuminated (on vehicles equipped with Occupant Weight Sensor). If the severity of an accident were to cause the airbag to inflate, this could lead to serious injury or death to a child seated in this position.

3. Fasten the seat belt by inserting the latch plate into the buckle (lock) until a distinct click is audible.



Fasten the seat belt



Pull out the shoulder section of the seat belt

4. Pull the shoulder section of the seat belt out as far as possible to activate the belt's automatic locking function.

## NOTE

The locking retractor will automatically release when the seat belt is unbuckled and allowed to retract fully.

5. Press the infant seat firmly in place, let the seat belt retract and pull it taut. A sound from the seat belt retractor's automatic locking function will be audible at this time and is normal. The seat belt should now be locked in place.

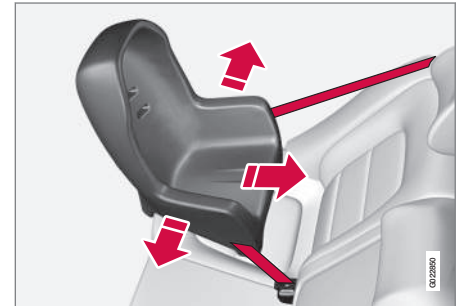

Ensure that the seat is securely in place

6. Push and pull the infant seat along the seat belt path to ensure that it is held securely in place by the seat belt.



### **!** WARNING

It should not be possible to move the child restraint (child seat) more than 1 in. (2.5 cm) in any direction along the seat belt path.

The infant seat can be removed by unbuckling the seat belt and letting it retract completely.

### Related information

- Child safety (p. 45)
- Child restraints (p. 47)
- Convertible seats (p. 51)
- ISOFIX/LATCH lower anchors (p. 54)
- Top tether anchors (p. 56)

### Convertible seats

*Suitable child restraints should always be used when children (depending on their age/size) are seated in the vehicle.*

### Securing a convertible seat with a seat belt



*Do not place the convertible seat in the front passenger's seat*

### **i** NOTE

Refer to (p. 54) and (p. 56) for information on securing a child restraint using ISOFIX/LATCH lower anchors and/or top tether anchorages.

Convertible seats can be used in either a forward or rearward-facing position, depending on the age and size of the child.

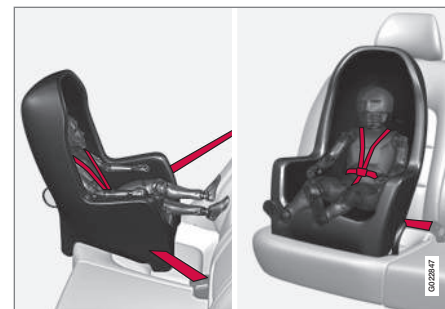

*Route the seat belt through the convertible seat*

### **!** WARNING

Always use a convertible seat that is suitable for the child's age and size. See the convertible seat manufacturer's recommendations.

1. Place the convertible seat in the rear seat of the vehicle.



## WARNING

- A small child's head represents a considerable part of its total weight and its neck is still very weak. Volvo recommends that children up to age 4 travel, properly restrained, facing rearward. In addition, Volvo recommends that children should ride rearward facing, properly restrained, as long as possible.
  - Convertible child seats should be installed in the rear seat only.
  - A rear-facing convertible seat should not be positioned behind the driver's seat unless there is adequate space for safe installation.
2. Attach the seat belt to the convertible seat according to the manufacturer's instructions.

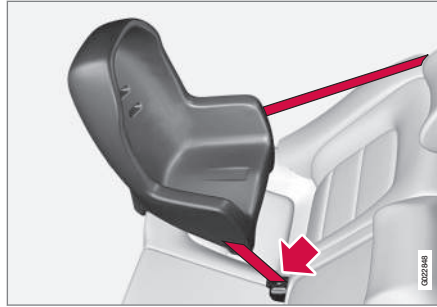

*Fasten the seat belt*

3. Fasten the seat belt by inserting the latch plate into the buckle (lock) until a distinct click is audible.
4. Pull the shoulder section of the seat belt out as far as possible to activate the belt's automatic locking function.



## NOTE

The locking retractor will automatically release when the seat belt is unbuckled and allowed to retract fully.

5. Press the convertible seat firmly in place, let the seat belt retract and pull it taut. A sound from the seat belt retractor's automatic locking function will be audible at this time and is normal. The seat belt should now be locked in place.



*Pull out the shoulder section of the seat belt*

6. Push and pull the convertible seat along the seat belt path to ensure that it is held securely in place by the seat belt.



### **!** WARNING

It should not be possible to move the child restraint (child seat) more than 1 in. (2.5 cm) in any direction along the seat belt path.

The convertible seat can be removed by unbuckling the seat belt and letting it retract completely.

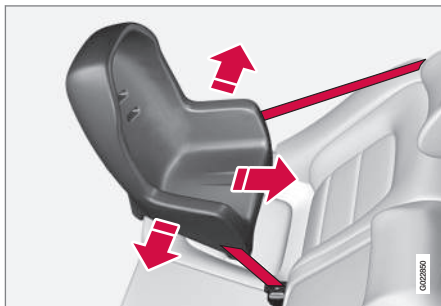

Ensure that the seat is securely in place

### **!** WARNING

A child seat should never be used in the front passenger seat of any vehicle with a front passenger airbag – not even if the "Passenger airbag off" symbol near the rear-view mirror is illuminated. If the severity of an accident were to cause the airbag to inflate, this could lead to serious injury or death to a child seated in this position.

### Related information

- Child safety (p. 45)
- Child restraints (p. 47)
- Infant seats (p. 49)
- ISOFIX/LATCH lower anchors (p. 54)
- Top tether anchors (p. 56)

### Booster cushions

*Booster cushions should be properly positioned in the vehicle.*

### Securing a booster cushion

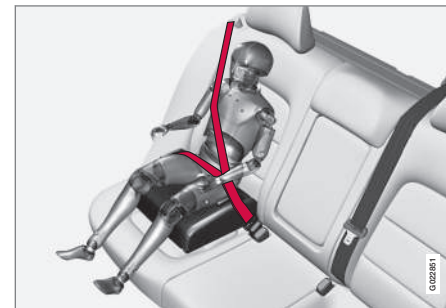

*Position the child correctly on the booster cushion*

Booster cushions are recommended for children who have outgrown convertible seats (p. 51).

1. Place the booster cushion in the rear seat of the vehicle.
2. With the child properly seated on the booster cushion, attach the seat belt to or around the cushion according to the manufacturer's instructions.



3. Fasten the seat belt by inserting the latch plate into the buckle (lock) until a distinct click is audible.

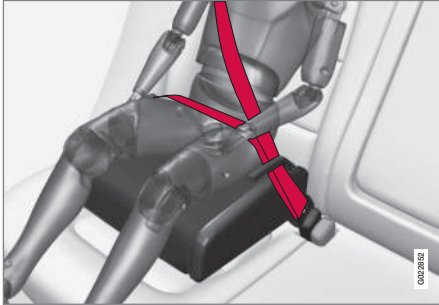

Positioning the seat belt

4. Ensure that the seat belt is pulled taut and fits snugly around the child.

### WARNING

- The hip section of the three-point seat belt must fit snugly across the child's hips, not across the stomach.
- The shoulder section of the three-point seat belt should be positioned across the chest and shoulder.
- The shoulder belt must never be placed behind the child's back or under the arm.

### Related information

- Child safety (p. 45)
- Child restraints (p. 47)
- Infant seats (p. 49)
- Convertible seats (p. 51)
- ISOFIX/LATCH lower anchors (p. 54)
- Top tether anchors (p. 56)

### ISOFIX/LATCH lower anchors

Lower anchors for ISOFIX/LATCH-equipped child seats are located in the rear, outboard seats, hidden below the backrest cushions.

### Using the ISOFIX/LATCH lower child seat anchors

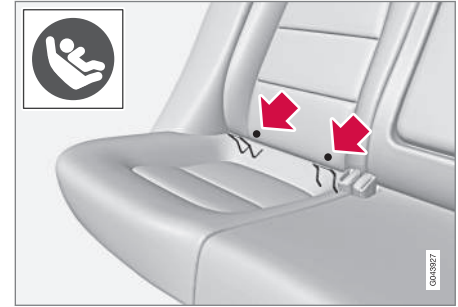

Symbols on the seat back upholstery mark the ISOFIX/LATCH anchor positions as shown. To access the anchors, kneel on the seat cushion and locate the anchors by feel. Always follow your child seat manufacturer's installation instructions, and use both ISOFIX/LATCH lower anchors and top tethers (p. 56) whenever possible.



### To access the anchors

1. Put the child restraint in position.
2. Kneel on the child restraint to press down the seat cushion and locate the anchors by feel.
3. Fasten the attachment on the child restraint's lower straps to the ISOFIX/LATCH/LATCH lower anchors.
4. Firmly tension the lower child seat straps according to the manufacturer's instructions.

### WARNING

Volvo's ISOFIX/LATCH anchors conform to FMVSS/CMVSS standards. Always refer to the child restraint system's manual for weight and size ratings.

### NOTE

- The rear seat's center position is not equipped with ISOFIX/LATCH lower anchors. When installing a child restraint in this position, attach the restraint's top tether strap (if it is so equipped) to the top tether anchorage point and secure the restraint with the vehicle's center seat belt.
- Always follow your child seat manufacturer's installation instructions, and use both ISOFIX/LATCH lower anchors and top tethers whenever possible.

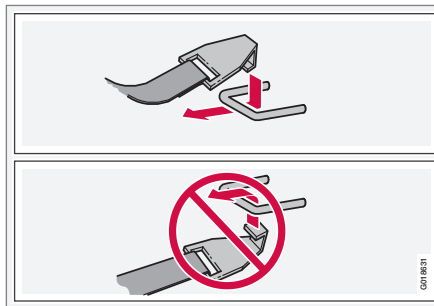

*Fasten the attachment correctly to the ISOFIX/LATCH lower anchors*

### WARNING

- Be sure to fasten the attachment correctly to the anchor (see the illustration). If the attachment is not correctly fastened, the child restraint may not be properly secured in the event of a collision.
- The ISOFIX/LATCH lower child restraint anchors are only intended for use with child seats positioned in the outboard seating positions. These anchors are not certified for use with any child restraint that is positioned in the center seating position. When securing a child restraint in the center seating position, use only the vehicle's center seat belt.

### Related information

- Child safety (p. 45)
- Infant seats (p. 49)
- Convertible seats (p. 51)



## Top tether anchors

Your Volvo is equipped with child restraint top tether anchorages in the rear seat. They are located on the rear parcel shelf.

## Child restraint anchorages

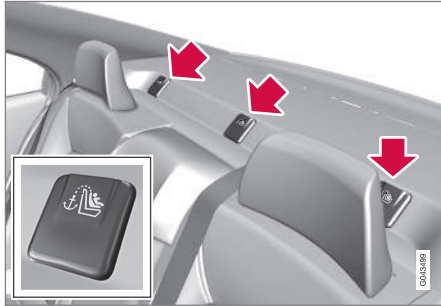

## Securing a child seat

1. Place the child restraint on the rear seat.
2. Fold up the plastic cover over the anchorage to be used.
3. Route the top tether strap under the head restraint and attach it to the anchor.
4. Fold down the outboard head restraints or lower the center head restraint for easier access to the ISOFIX/LATCH anchor.

5. Attach lower tether straps to the lower ISOFIX/LATCH anchors. If the child restraint is not equipped with lower tether straps, or the restraint is used in the center seating position, follow instructions for securing a child restraint using the Automatic Locking Retractor seat belt (see Child restraints (p. 47)).
6. Firmly tension all straps.

Refer also to the child seat manufacturer's instructions for information on securing the child seat.



## WARNING

- Always refer to the recommendations made by the child restraint manufacturer.
- Volvo recommends that the top tether anchors be used when installing a forward-facing child restraint.
- Never route a top tether strap over the top of the head restraint. The strap should be routed beneath the head restraint.
- Child restraint anchorages are designed to withstand only those loads imposed by correctly fitted child restraints. Under no circumstances are they to be used for adult seat belts or harnesses. The anchorages are not able to withstand excessive forces on them in the event of collision if full harness seat belts or adult seat belts are installed to them. An adult who uses a belt anchored in a child restraint anchorage runs a great risk of suffering severe injuries should a collision occur.
- Do not install rear speakers that require the removal of the top tether anchors or interfere with the proper use of the top tether strap.



### Related information

- Child safety (p. 45)
- Infant seats (p. 49)
- Convertible seats (p. 51)
- ISOFIX/LATCH lower anchors (p. 54)

### Child safety locks

Child safety locks help prevent children from inadvertently opening one of the rear doors from inside the vehicle.

#### Manual child safety locks

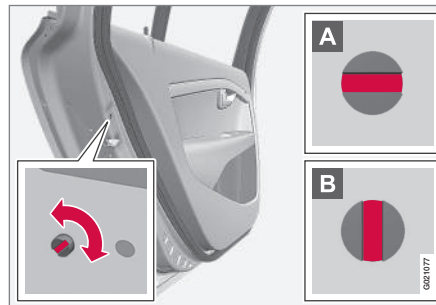

#### Child safety locks – rear doors

The controls are located on the rear door jambs. Use the remote control's key blade or a screwdriver to adjust these controls.

- A** The rear doors can only be opened from the outside when the slot is in the horizontal position.
- B** The rear doors can be opened from the inside when the slot is in the vertical position.

#### Related information

- Detachable key blade – general information (p. 145)
- Locking/unlocking – from inside (p. 154)

# 03



## INSTRUMENTS AND CONTROLS

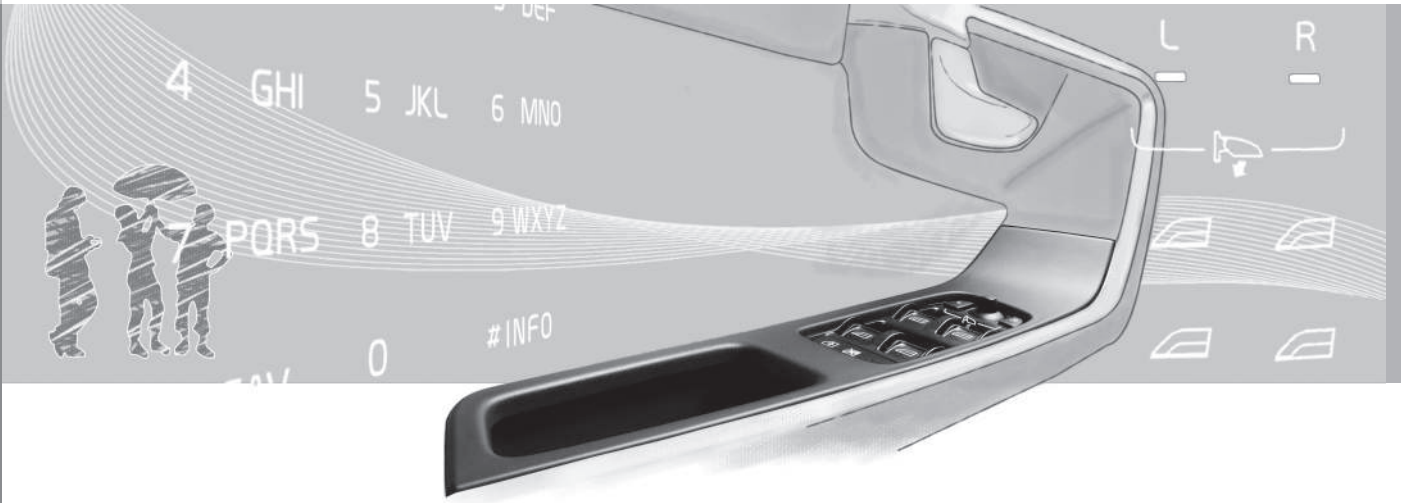



### **Instrument overview**

*This overview shows the location of the instrument panel and center console displays, and controls/buttons/switches.*



# 03 Instruments and controls



03

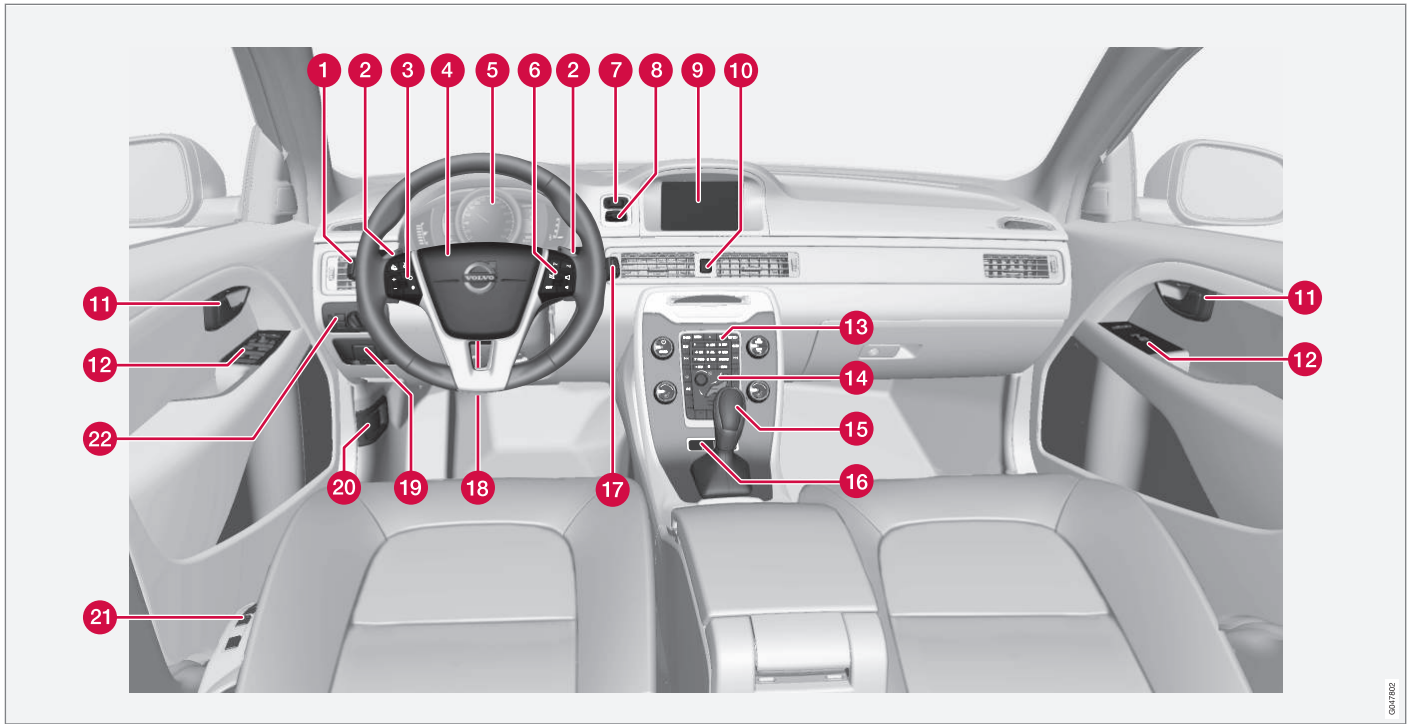

0341102



	Function	See
1	Controls for menus and messages, turn signals, high/low beams, trip computer	(p. 70), (p. 88), (p. 82), (p. 108)
2	Paddles for manually shifting gears*	(p. 240)
3	Cruise control	(p. 168)
4	Horn, airbag	(p. 81), (p. 32)
5	Main instrument panel	(p. 62)
6	Infotainment system/Bluetooth hands-free controls	SensuS Infotainment supplement
7	START/STOP ENGINE button	(p. 72)
8	Ignition slot	(p. 72)
9	Display for infotainment system functions and menus	(p. 106), SensuS Infotainment supplement
10	Hazard warning flashers	(p. 88)
11	Door handle	–

	Function	See
12	In-door control panels (power windows, mirrors, central locking button)	(p. 94), (p. 96), (p. 154)
13	Controls for the infotainment system and menus	(p. 70), SensuS Infotainment supplement
14	Climate system controls	(p. 122)
15	Gear selector	(p. 238)
16	Controls for active chassis (Four-C)*	(p. 162)
17	Wipers and washers	(p. 91), (p. 92)
18	Steering wheel adjustment	(p. 81)
19	Parking brake	(p. 254)
20	Hood opening control	(p. 311)

	Function	See
21	Power seat* adjustment controls	(p. 75)
22	Lighting panel, buttons for opening fuel filler door and unlocking and opening the trunk	(p. 82), (p. 263), (p. 156)

#### Related information

- Information displays – ambient temperature sensor (p. 71)
- Information displays – trip odometer and clock (p. 72)



# 03 Instruments and controls

## Information displays – introduction

The displays show information on some of the vehicle's functions, such as cruise control, the trip computer and messages. The information is shown with text and symbols.

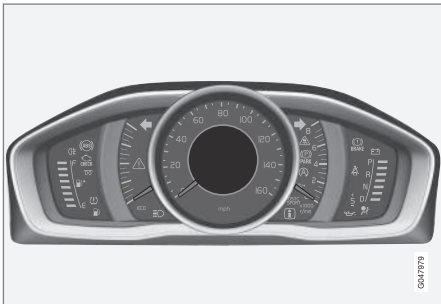

Information displays: analog instrument panel

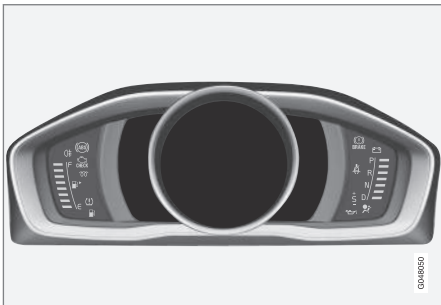

Information displays: digital instrument panel\*

More detailed information can be found in the descriptions of the functions that use the information displays.

## Gauges and indicators: analog instrument panel

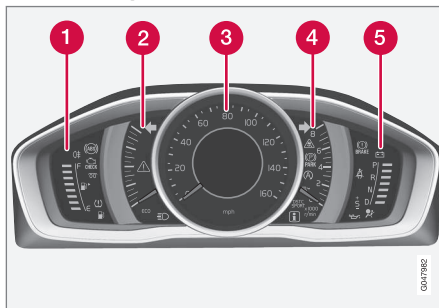

- 1 Fuel gauge: When the indicator shows one white marking<sup>1</sup>, a yellow indicator light will illuminate to indicate a low fuel level. See also Trip computer – introduction (p. 108) and Refueling – fuel requirements (p. 260) for additional information.
- 2 Eco meter: Indicates how economically the vehicle is being driven. The higher the needle moves on the scale, the more economically the vehicle is being driven.
- 3 Speedometer

- 4 Tachometer: Shows engine speed in thousands of revolutions per minute (rpm)
- 5 Gear indicator: Shows the currently selected gear

## Gauges and indicators: digital instrument panel\*

Different themes (display alternatives) can be selected for the digital instrument panel:

- Elegance
- Eco
- Performance

To change themes, press the **OK** button on the left steering wheel lever and use the thumb wheel to scroll to **Themes**. Press **OK** to confirm your choice.

<sup>1</sup> When the message Distance to empty fuel tank: shows "----", the marker turns red

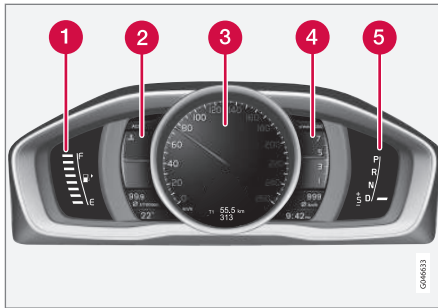

Theme **Elegance**: gauges and indicators

- 1 Fuel gauge. When the indicator shows one white marking, a yellow indicator light will illuminate to indicate a low fuel level. See also Trip computer – introduction (p. 108) and Refueling – fuel requirements (p. 260) for additional information.
- 2 Coolant temperature gauge
- 3 Speedometer
- 4 Tachometer (engine speed in thousands of revolutions per minute (rpm))
- 5 Gear indicator: Shows the currently selected gear

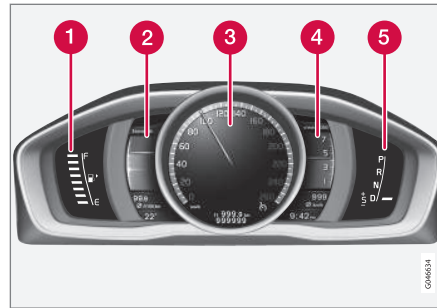

Theme **Eco**: gauges and indicators

- 1 Fuel gauge. When the indicator shows a white marking, a yellow indicator light will illuminate to indicate a low fuel level. See also Trip computer – introduction (p. 108) and Refueling – fuel requirements (p. 260) for additional information.
- 2 Eco Guide (see Eco Guide\* and Power Meter\* (p. 65))
- 3 Speedometer
- 4 Tachometer (engine speed in thousands of revolutions per minute (rpm))
- 5 Gear indicator: Shows the currently selected gear

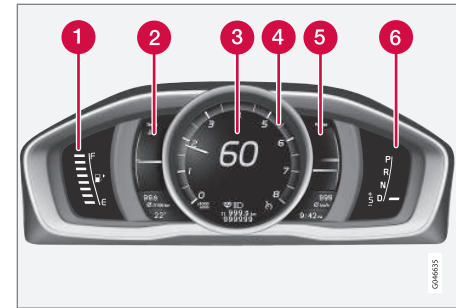

Theme **Performance**: gauges and indicators

- 1 Fuel gauge. When the indicator shows a white marking, a yellow indicator light will illuminate to indicate a low fuel level. See also Trip computer – introduction (p. 108) and Refueling – fuel requirements (p. 260) for additional information.
- 2 Coolant temperature gauge
- 3 Speedometer
- 4 Tachometer (shows engine speed in thousands of revolutions per minute (rpm))
- 5 Power Meter (see Eco Guide\* and Power Meter\* (p. 65)).
- 6 Gear indicator: Shows the currently selected gear



## Indicator and warning symbols

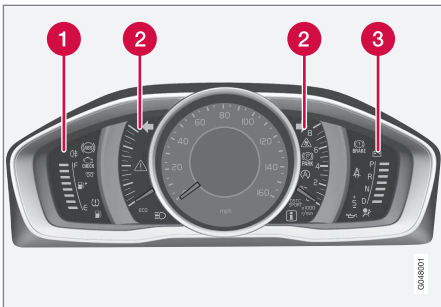

Indicator and warning symbols: analog instrument panel

- 1 Indicator symbols
- 2 Indicator and warning symbols
- 3 Warning symbols

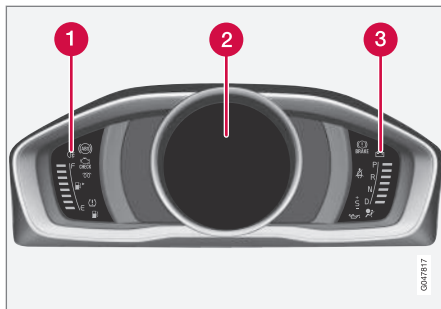

Indicator and warning symbols: digital instrument panel

- 1 Indicator symbols
- 2 Indicator and warning symbols
- 3 Warning symbols

### Function check

All indicator and warning symbols light up in ignition mode II or when the engine is started. When the engine has started, all the symbols should go out except the parking brake symbol, which only goes out when the brake is disengaged.

If the engine does not start or if the function check is carried out in ignition mode II, all symbols go out after 5 seconds except the malfunction indicator light, which may indicate a fault in the vehicle's emissions system, and the symbol for low oil pressure.

Some of the symbols shown may not be available in all markets or models.

### Related information

- Instrument overview (p. 59)
- Information displays – indicator symbols (p. 66)
- Information displays – warning symbols (p. 68)



### Eco Guide\* and Power Meter\*

*Eco guide and Power guide are two gauges in the instrument panel that help improve driving economy.*

*The vehicle also stores driving-related statistics in the form of a bar graph, see Trip computer – Trip statistics (p. 116).*

#### Introduction

To display or remove these functions from the instrument panel, select the "Eco" theme (see Information displays – introduction (p. 62)).

Driving statistics are also stored and can be displayed in the form of a bar chart (see Trip computer – Trip statistics (p. 116)).

#### Eco Guide

This gauge gives an indication of how economically the vehicle is being driven.



- ❶ Current (instantaneous) reading
- ❷ Average

#### Current (instantaneous) reading

This is the current level of economical driving; the higher the reading, the more economically the vehicle is being driven.

This value is calculated based on the vehicle's speed, engine speed (rpm), engine load and brake use.

The optimal speed range is between approximately 30–50 mph (50–80 km/h), preferably at as low rpm as possible. The markers fall when the brake or accelerator pedal is pressed.

If the current reading is very low, the red field in the gauge will illuminate after a slight delay, indicating low driving economy.

#### Average

The average reading changes gradually according to changes in the current reading to indicate how economically the vehicle has been driven recently. The higher the average reading, the more economically the vehicle has been driven.

#### Power Meter

This gauge indicates the engine power that has been utilized and the amount of power remaining.

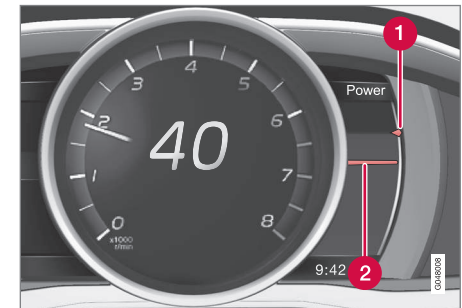

- ❶ Available power
- ❷ Utilized power



# 03 Instruments and controls



## Available power

The smaller, upper indicator shows the engine's available power<sup>2</sup>. The higher the reading on the scale, the greater the amount of power remaining in the current gear.

## Utilized power

The larger, lower indicator shows the amount of engine power that has been utilized<sup>2</sup>. The higher the reading on the scale, the greater the amount of power that is being utilized.

The larger the gap between the two indicators, the greater the amount of power remaining.

## Information displays – indicator symbols

*The indicator symbols alert the driver when certain functions are activated, that a system is actively working or that a fault may have occurred in a system or function.*

Symbol	Description
	Fault in the Active Bending Light (ABL)*system
	Malfunction indicator light
	Anti-lock brake system (ABS)
	Rear fog lights on
	Stability system
	The stability system's Sport mode is activated
	Low fuel level
	Information symbol, read the text displayed in the instrument panel
	High beam indicator

Symbol	Description
	Left turn signal indicator
	Right turn signal indicator
	Tire pressure monitoring sensor (TPMS) <sup>A</sup>
	The Eco function is on.
	The Start/Stop function is active (the engine has auto-stopped)

<sup>A</sup> Option in Canada

## Fault in the Active Bending Light (ABL) system

This symbol will illuminate if there is a fault in the ABL system. See Active Bending Lights (ABL)\* (p. 85) for more information about this system.

<sup>2</sup> Depending on rpm



### Malfunction Indicator Light

As you drive, a computer called On-Board Diagnostics II (OBDII) monitors your vehicle's engine, transmission, electrical and emission systems.

The malfunction indicator light will illuminate if the computer senses a condition that potentially may need correcting. When this happens, please have your vehicle checked by a trained and qualified Volvo service technician as soon as possible.

A malfunction indicator light may have many causes. Sometimes, you may not notice a change in your car's behavior. Even so, an uncorrected condition could hurt fuel economy, emission controls, and drivability. Extended driving without correcting the cause could even damage other components in your vehicle.

This light may illuminate if the fuel filler cap is not closed tightly or if the engine was running while the vehicle was refueled.

### Anti-lock Brake System (ABS)

If the warning light comes on, there may be a malfunction in the ABS system (the standard braking system will still function). Check the system by:

1. Stopping in a safe place and switching off the ignition.
2. Restart the engine.

3. If the warning light goes off, no further action is required.

If the indicator light remains on, the vehicle should be driven to a trained and qualified Volvo service technician for inspection, see Brakes – general (p. 250) for additional information.

### Rear fog lights

This symbol indicates that the rear fog lights are on.

### Stability system

This indicator symbol flashes when the stability system is actively working to stabilize the vehicle, see Stability system – introduction (p. 162) for more detailed information.

### Stability system - Sport mode

This symbol illuminates to indicate that the stability system's **Sport** mode has been activated to help provide maximum tractive force, for example when driving with snow chains, or driving in deep snow or loose sand.

### Low fuel level

When this light comes on, the vehicle should be refueled as soon as possible. See Refueling – fuel requirements (p. 260) for information about fuel and refueling.

### Information symbol

The information symbol lights up and a text message is displayed to provide the driver with necessary information about one of the vehicle's systems. The message can be erased and the symbol can be turned off by

pressing the **OK** button (see Information display – menu controls (p. 106) for information) or this will take place automatically after a short time (the length of time varies, depending on the function affected).

The information symbol may also illuminate together with other symbols.

### High beam indicator

This symbol illuminates when the high beam headlights are on, or if the high beam flash function is used.

### Left turn signal indicator

### Right turn signal indicator

### NOTE

- Both turn signal indicators will flash when the hazard warning flashers are used.
- If either of these indicators flash faster than normal, the direction indicators are not functioning properly.

### Tire pressure monitoring system (TPMS)\*

This symbol illuminates to indicate that tire pressure in one or more tires is low, see Tire Pressure Monitoring System (TPMS) – general information (p. 291) for detailed information.

### Eco\* function on

The symbol will illuminate when the Eco function is activated.



# 03 Instruments and controls



## Start/stop\*

The symbol illuminates when the engine has auto-stopped.

## Related information

- Information displays – introduction (p. 62)
- Information displays – warning symbols (p. 68)

## Information displays – warning symbols

The warning lights alert the driver that an important function is activated or that a serious fault has occurred.

Symbol	Description
	Low oil pressure <sup>A</sup>
	Parking brake applied <sup>B</sup>
	SRS airbags
	Seat belt reminder
	Generator not charging
	Fault in the brake system
	Warning symbol, read the text displayed in the instrument panel

<sup>A</sup> Certain engines do not use this symbol to indicate low oil pressure. On these models, a text message will be displayed on the instrument panel instead, see Engine compartment – engine oil (p. 313).

<sup>B</sup> The symbol is **Park** only on models with the optional digital instrument panel.

## Low oil pressure

If the light comes on while driving, stop the vehicle, stop the engine immediately, and check the engine oil level. Add oil if neces-

sary. If the oil level is normal and the light stays on after restart, have the vehicle towed to the nearest trained and qualified Volvo service technician.

## Parking brake applied

This symbol flashes while the brake is being applied and then glows steadily when the parking brake has been set.

See Parking brake – general information (p. 254) for more information about using the parking brake.

## Airbags – SRS

If this light comes on while the vehicle is being driven, or remains on for longer than approximately 10 seconds after the vehicle has been started, the SRS system's diagnostic functions have detected a fault in a seat belt lock or pretensioner, a front airbag, side impact airbag, and/or an inflatable curtain. Have the system(s) inspected by a trained and qualified Volvo service technician as soon as possible.

See Supplemental Restraint System (SRS) (p. 31) for more information about the airbag system.

## Seat belt reminder

This symbol comes on for approximately 6 seconds if the driver has not fastened his or her seat belt.



### Generator not charging

This symbol comes on during driving if a fault has occurred in the electrical system. Contact an authorized Volvo workshop.



### Engine temperature

Engine overheating can result from low oil or coolant levels, towing or hard driving at high heat and altitude, or mechanical malfunction. Engine overheating will be signaled with text and a red warning triangle in the middle of the instrument display. The exact text will depend on the degree of overheating. It may range from **High engine temp Reduce speed** to **High engine temp Stop engine**. If appropriate, other messages, such as **Coolant level low**, **Stop safely** will also be displayed. If your engine does overheat so that you must stop the engine, always allow the engine to cool before attempting to check oil and coolant levels.

See Engine compartment – coolant (p. 315) for more information.



### Fault in brake system

If this symbol lights, the brake fluid level may be too low. Stop the vehicle in a safe place and check the level in the brake fluid reservoir, see Engine compartment – brake fluid (p. 316). If the level in the reservoir is below **MIN**, the vehicle should be transported to an authorized Volvo workshop to have the brake system checked.

If the  and  symbols come on at the same time, there may be a fault in the brake force distribution system.

1. Stop the vehicle in a safe place and turn off the engine.
2. Restart the engine.
  - If both symbols extinguish, continue driving.
  - If the symbols remain on, check the level in the brake fluid reservoir, see Engine compartment – brake fluid (p. 316). If the brake fluid level is normal but the symbols are still lit, the vehicle can be driven, with great care, to an authorized Volvo workshop to have the brake system checked.
  - If the level in the reservoir is below **MIN**, the vehicle should be transported to an authorized Volvo workshop to have the brake system checked.

### WARNING

- If the fluid level is below the **MIN** mark in the reservoir or if a warning message is displayed in the text window: **DO NOT DRIVE**. Have the vehicle towed to a trained and qualified Volvo service technician and have the brake system inspected.
- If the  and  symbols are on at the same time, there is a risk of reduced vehicle stability.

### Warning symbol

The red warning symbol lights up to indicate a problem related to safety and/or drivability. A message will also appear in the instrument panel. The symbol remains visible until the fault has been rectified but the text message can be cleared with the **OK** button, see Information display – menu controls (p. 106). The warning symbol can also come on in conjunction with other symbols.

Action:

1. Stop in a safe place. Do not drive the vehicle further.
2. Read the information on the display. Implement the action in accordance with the message in the display. Clear the message using **OK**.



# 03 Instruments and controls



## Reminder – doors not closed

If one of the **doors** is not closed properly, the **information** or **warning** symbol illuminates (depending on the vehicle's speed), a graphic will be displayed in instrument panel and an explanatory text message<sup>3</sup> will also be displayed in the instrument panel. Stop the vehicle in a safe place as soon as possible and close the door.



If the vehicle is driven at a speed lower than approximately 5 mph (7 km/h), the information symbol illuminates.



If the vehicle is driven at a speed higher than approximately 5 mph (7 km/h), the warning symbol illuminates.

If the **hood** is not closed properly, the **warning** symbol illuminates, a graphic will be displayed in instrument panel and an explanatory text message<sup>3</sup> will also be displayed in the instrument panel. Stop the vehicle in a safe place as soon as possible and close the hood.

If the **trunk** is not closed properly, the **information** symbol illuminates and a graphic will be displayed in instrument panel. Stop the vehicle in a safe place as soon as possible and close the trunk.

## Related information

- Information displays – introduction (p. 62)
- Information displays – indicator symbols (p. 66)

## My Car – introduction

*The MY CAR menu system provides access to menus for operating many of the vehicle's functions, such as setting the clock, door mirrors, lock and alarm settings, etc.*

Some of the features or functions are standard; others are optional and vary according to model/market.

## Operation

Use the buttons on the center console or the steering wheel keypad to navigate in the menus.

<sup>3</sup> Text message applies only to models with the optional digital instrument panel

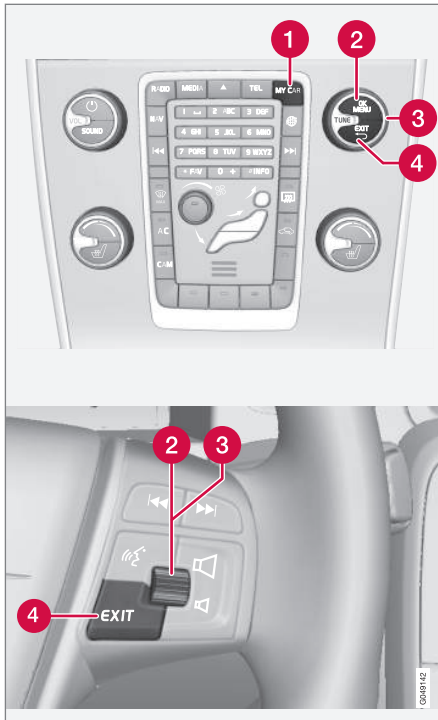

The center console control panel and the steering wheel keypad. The illustration is generic and the appearance/location of the buttons may vary.

- 1 MY CAR:** opens the MY CAR menu system.

- 2 OK/MENU:** Press the button on the center console or the thumb wheel on the steering wheel keypad to select a menu alternative or to store a selected function in the system's memory.
- 3 TUNE:** Turn this control on the center console or the thumb wheel on the steering wheel keypad to navigate up/down in a menu.
- 4 EXIT**

#### EXIT functions

Depending on which function the cursor is pointing to and the menu level, briefly pressing **EXIT** will result in:

- An in-coming phone call will be rejected
- The current function will be cancelled
- Characters entered will be erased
- The most recent selection will be cancelled
- Go back/up in the menu system

Pressing and holding **EXIT** takes you to the normal view for MY CAR. If you are already in normal view, this will take you to the main source menu.

#### Menu selections and paths

Please consult your Sensus Infotainment supplement for a description of the MY CAR menu selections and paths.

#### Information displays – ambient temperature sensor

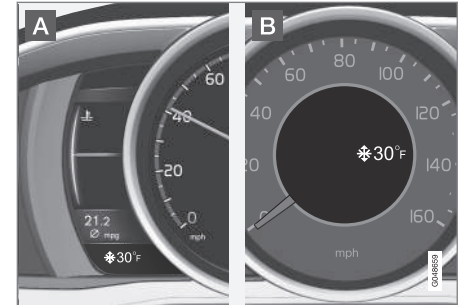

Location of the ambient temperature sensor, A: digital instrument panel<sup>1</sup>, B: analog instrument panel

#### **i** NOTE

When the ambient temperature is between 23° and 36 °F (–5° and +2 °C), a snowflake symbol will be displayed next to the temperature. This symbol serves as a warning for possible slippery road surfaces. Please note that this symbol does **not** indicate a fault with your vehicle.

At low speeds or when the vehicle is not moving, the temperature readings may be slightly higher than the actual ambient temperature.

#### Related information

- Information displays – introduction (p. 62)

<sup>1</sup> Option/accessory, for more information, see Introduction.



## Information displays – trip odometer and clock

The trip odometers **T1** and **T2** and clock are displayed in the instrument panel.

### Trip odometers



Trip odometer<sup>4</sup>

#### 1 Odometer display

Turn the thumb wheel on the left steering wheel lever to display the desired trip odometer.

Press and hold the **RESET** button on the left steering wheel lever for at least 1 second to reset the selected trip odometer<sup>5</sup>.

### Clock



Clock, digital instrument panel\*

#### 1 Display<sup>6</sup>

### Setting the clock

The clock can be set in the **MY CAR** menu system. See My Car – introduction (p. 70) for additional information about these menus.

Go to **Settings** → **System options** → **Time settings**. Set **Auto time** to ON (check the box) and select the correct time zone under **Location**.

### Related information

- Information displays – introduction (p. 62)

## Inserting/removing remote key

The remote key is used to start the engine or to use various electrical functions without starting the engine.

### Inserting and removing the remote key



Ignition slot with remote key and **START/STOP ENGINE** button.

### Inserting the remote key<sup>7</sup>

Holding the end of the remote key with the base of the key blade, insert the remote key into the ignition slot as shown in the illustration and press it in as far as possible.



### CAUTION

Foreign objects in the ignition slot can impair function or cause damage.

<sup>4</sup> The trip odometer will be displayed differently in analog and digital instrument panels

<sup>5</sup> Models with a digital information panel: press and hold **RESET** for more than approximately 4 seconds to reset all trip computer information

<sup>6</sup> Models with an analog instrument panel: the time will be displayed in the center of the instrument panel

<sup>7</sup> Not necessary in vehicles with the optional keyless drive.



### Removing the remote key

The remote key can be removed from the ignition slot by pulling it out.

### Related information

- Ignition modes (p. 73)

### Ignition modes

The vehicle's ignition has 3 modes: **0**, **I**, and **II** that can be used without starting the engine. The following table shows examples of which functions are available in the respective modes.



#### NOTE

To access ignition modes **I** or **II** without starting the engine, the brake pedal must **not** be depressed.

Mode	Function
<b>0</b>	The odometer, clock and temperature gauge are illuminated. Power seats* can be adjusted and the infotainment system can be used for a limited time (to minimize battery drain, see the Sensus Infotainment Supplement).
<b>I</b>	The Moonroof*, power windows, 12-volt sockets in the passenger compartment, navigation system*, climate system blower, windshield wipers can be used.
<b>II</b>	The headlights/taillights illuminate. Warning/indicator lights illuminate for 5 seconds. Other systems are activated. However, the heated seats* and heated rear window function can only be activated when the engine is running. <b>Mode II should only be used for very short periods to help avoid draining the battery.</b>

### Ignition modes

#### Ignition mode 0

- The vehicle is unlocked.



## 03 Instruments and controls



### Ignition mode I

- With the remote key fully pressed into the ignition slot<sup>8</sup>, press **START/STOP ENGINE** briefly.

### Ignition mode II

- With the remote key fully pressed into the ignition slot<sup>8</sup>, press **START/STOP ENGINE** for approximately 2 seconds.

### Returning to mode 0

To return to mode **0** from mode **II** or **I**, press **START/STOP ENGINE** briefly.

### Starting and stopping the engine

See Starting the engine (p. 233) and Switching off the engine (p. 235) for information on starting the engine and switching it off.

### Emergency towing

See Towing the vehicle (p. 268) for important information about the remote key when the vehicle is being towed.

### Related information

- Inserting/removing remote key (p. 72)

### Front seats

*The front seats can be adjusted in a number of ways to help provide the most comfortable seating position.*

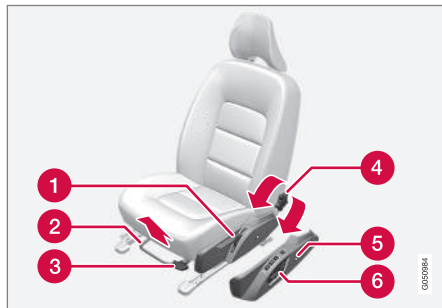

- 1 Raise/lower the seat, pump up/down.
- 2 Front-rear adjustment: lift the bar and move the seat to the position of your choice.
- 3 Raise/lower front edge of seat cushion, pump up/down.
- 4 Backrest tilt: turn the control to adjust the angle of the backrest.
- 5 Electronic lumbar support\*. Press the button to adjust.
- 6 Control panel for power seat\*, see Front seats – power seat (p. 75).



### WARNING

- Do not adjust the seat while driving. The seat should be adjusted so that the brake pedal can be depressed fully. In addition, position the seat as far rearward as comfort and control allow.
- Check that the seat is securely locked into position after adjusting.

### Related information

- Front seats – power seat (p. 75)
- Rear seats – folding backrest (p. 80)
- Rear seats – head restraints (p. 78)

<sup>8</sup> Not necessary in vehicles with the optional keyless drive.



### Front seats – folding backrest\*

The front passenger's seat backrest can be folded down to make it easier to transport long objects.

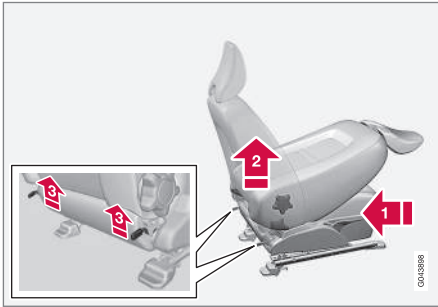

The front passenger seat backrest can be folded to a horizontal position to make room for a long load. Fold the backrest as follows:

- 1 Move the seat as far back and down as possible.
- 2 Adjust the backrest to an upright position.
- 3 Lift the catches on the rear of the backrest.
- 4 Without releasing the catches, push the backrest forward.

Move the seat as far forward as possible so that the head restraint slides under the glove compartment.

Return the seat to its upright position in the reverse order.



### WARNING

- When transporting long objects, cover sharp edges on the load to help prevent injury to occupants. Secure the load to help prevent shifting during sudden stops.
- When the seat's backrest is returned to the upright position, push and pull it to be sure that it is securely locked in this position.

### Related information

- Front seats (p. 74)
- Front seats – power seat (p. 75)
- Rear seats – folding backrest (p. 80)
- Rear seats – head restraints (p. 78)

### Front seats – power seat<sup>11</sup>

The power seat(s) can be adjusted for a short period after unlocking the door with the remote control without the key in the ignition slot. Seat adjustment is normally made when the ignition is on and can always be made when the engine is running.

### Power seat

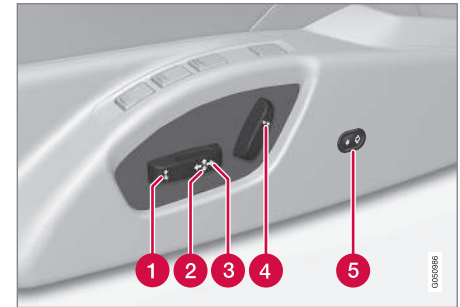

Power seat adjustment controls

- 1 Front edge of seat cushion up/down
- 2 Raise/lower the seat
- 3 Seat forward/rearward
- 4 Backrest tilt
- 5 Electronic lumbar support\*

\* Option/accessory, for more information, see Introduction.



## Operation

### **i** NOTE

- Only one of the power seat's controls can be used at the same time.
- The power seats have an overload protector that activates if a seat is blocked by any object. If this occurs, switch off the ignition (key in position 0) and wait for a short period before operating the seat again.

### Power seat memory function

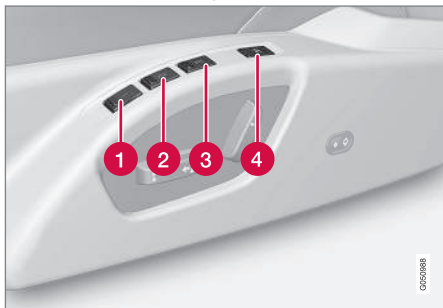

Power seat memory buttons

- 1** Button for storing a position
- 2** Button for storing a position

- 3** Button for storing a position

- 4** **M** (memory) button

### Programming the seat's memory

Three different seating and door mirror positions can be stored in the driver seat's memory.

The following example explains how button (1) can be programmed. Buttons (2) and (3) are programmed in the same way.

To program (store) a seat and door mirror position in button (1):

1. Move the seat (and door mirrors) to the desired positions using the seat and mirror adjustment controls.
2. Press and hold down the **M** (memory) button (4).
3. With the memory button depressed, press button (1) briefly to store the current position for the seat/mirrors.

### To move the seat and mirrors to the position that they were in when a button was programmed:

- Press and hold down button (1) until the seat and mirrors stop moving.

### **i** NOTE

As a safety precaution, the seat will stop automatically if the button is released before the seat has reached the preset position.

### Ventilated seats\*

See Ventilated seats (p. 124).

### Heated seats\*

See Heated seats (p. 123).

### Related information

- Front seats (p. 74)
- Rear seats – folding backrest (p. 80)
- Rear seats – head restraints (p. 78)

<sup>11</sup> Optional on certain models



### Key memory – power driver's seat\* and door mirrors

Each remote key has a memory that enables it to store (remember) the position of the power driver's seat and door mirrors when the vehicle is locked with that remote key.

#### Remote key memory and the power driver's seat\* and door mirrors<sup>12</sup>

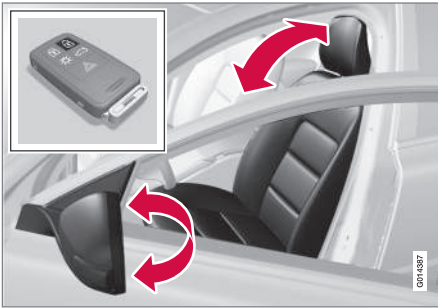

The key memory has to be activated **for each of the remote keys used in the vehicle** as follows:

1. Insert a remote key in the ignition slot.
2. Go into the **MY CAR** menu and go to **Settings → Car settings → Car key memory**

3. To activate the remote key memory feature, press **ENTER** (check the box).
  - > The remote key is now ready to store the position of the power driver's seat and door mirrors.

Repeat this procedure for each of the vehicle's remote keys.

See My Car – introduction (p. 70) for a description of the menu system.

#### Storing the positions of the power driver's seat/mirrors in the remote key

1. Move the seat and door mirrors to the desired position using the seat and mirror adjustment controls.
2. Exit the vehicle and lock the doors with the remote key (or close the driver's door and press the lock button on the door handle with the remote key in your possession on vehicles with the optional keyless drive).
  - > The positions of the power driver's seat and door mirrors are now stored in the remote key's memory.



#### NOTE

The remote key's memory feature and the power driver's seat memory function (the settings made using the buttons on the side of the seat, see the section "Power seat memory function" in Front seats – power seat (p. 75)) work independently of each other.

<sup>12</sup> This information also applies to vehicles with the optional keyless drive.



## Returning the seat/mirrors to the stored positions

To move the seat and door mirrors to the position stored in the remote key:

1. Unlock the driver's door with the **same** remote key (the one used to lock the doors). For models equipped with the optional keyless drive, you must have the same remote key in your possession.
2. Open the driver's door within 2 minutes.

The driver's seat and door mirrors will automatically move to the position in which you left them (if the vehicle has been unlocked with one of the other keys and new seat/mirror adjustments have been made).

### NOTE

- The seat will move to this position even if someone else has moved it to a different position and locked the vehicle with a **different** remote key.
- This feature will work in the same way with all of the remote keys that you use with your vehicle.

## Emergency stop



### WARNING

- Because the driver's seat can be adjusted with the ignition off, children should never be left unattended in the vehicle.
- Movement of the seat can be STOPPED at any time by pressing any button on the power seat control panel.
- Do not adjust the seat while driving. The seat should be adjusted so that the brake pedal can be depressed fully. In addition, position the seat as far rearward as comfort and control allow.
- The seat rails on the floor must not be obstructed in any way when the seat is in motion.

## Related information

- Remote key – functions (p. 143)

## Rear seats – head restraints

The rear seat head restraints can be folded down. The center head restraint can be raised/lowered according to the passenger's height.

### Rear center head restraint

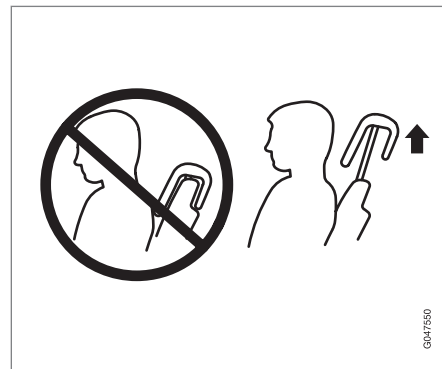
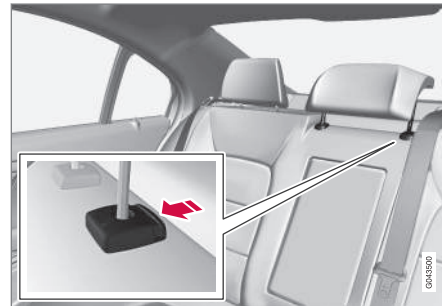

044750



The center head restraint should be adjusted according to the passenger's height. The restraint should be carefully adjusted to support the occupant's head.

- Pull the head restraint up as required.
- To lower, press the button at the base of the head restraint's left support while pressing the head restraint down carefully.

### WARNING

The center rear seat head restraint should only be in its lowest position when this seat is NOT occupied. When the center position is occupied, the head restraint should be correctly adjusted to the passenger's height. The upper edge of the head restraint should be at least on a level with the upper-most point of the seat occupant's ear.

### Automatically folding down the rear seat's outboard head restraints



1. The ignition must be in mode II.
2. Press the button to lower the rear head restraints for improved visibility.

### NOTE

- The head restraint must be returned to the upright position manually.
- The outboard head restraints cannot be folded down on models that are not equipped with this button.

### CAUTION

The rear head restraints should not be kept folded down for prolonged periods. This could result in pressure marks in leather upholstery.

### WARNING

For safety reasons, no one should be allowed to sit in the outboard rear seat positions if the head restraints are folded down. If these positions are occupied, the head restraints should be in the upright (fixed) position.

### Related information

- Front seats (p. 74)
- Front seats – power seat (p. 75)
- Rear seats – head restraints (p. 78)



## Rear seats – folding backrest

The rear seat head restraints and backrests can be folded down. The center head restraint can be raised/lowered according to the passenger's height.

### Folding down the rear seat backrests

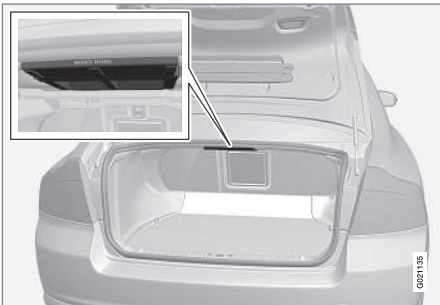

The rear seat backrests are split and can be folded down together or separately

1. Pull the release control handle(s).
2. Fold the backrest forward. Adjust the center seat head restraint if necessary.

### **i** NOTE

When the backrests are folded down, move the outboard head restraints forward slightly so that they do not catch on the seat cushion.

### **!** CAUTION

To help avoid damage to the upholstery, there should be no objects on the rear seat and the seat belt should not be buckled when the backrest is folded down.

### **!** WARNING

- Keep vehicle doors and trunk locked and keep keys out of a child's reach. Unsupervised children could lock themselves in an open trunk and risk injury. Children should be taught not to play in vehicles.
- On hot days, the temperature in the trunk or vehicle interior can rise very quickly. Exposure of people to these high temperatures for even a short period of time can cause heat-related injury or death. Small children are particularly at risk.

### **!** WARNING

- When one or more sections of the backrest is returned to the upright position, check that it is properly locked in place by pushing and pulling it.
- Return the outboard head restraints to the upright position.
- Long loads should always be securely anchored to help avoid injury in the event of a sudden stop.
- Always turn the engine off and apply the parking brake when loading/unloading the vehicle.
- Place the transmission in the Park (P) position to help prevent inadvertent movement of the gear selector.
- On hot days, the temperature in the vehicle interior can rise very quickly. Exposure of people to these high temperatures for even a short period of time can cause heat-related injury or death. Small children are particularly at risk.

### Related information

- Front seats (p. 74)
- Front seats – power seat (p. 75)
- Rear seats – head restraints (p. 78)



## Steering wheel

The steering wheel can be adjusted to various positions and has controls for the horn, cruise control\*, menus, the infotainment system and Bluetooth®-connected cell phone.

### Adjusting

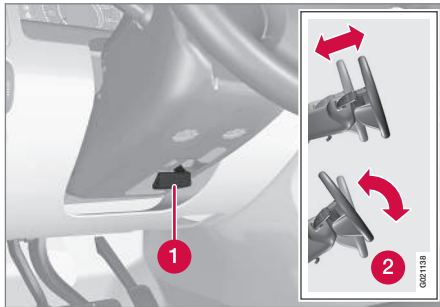

Adjusting the steering wheel

- 1 Lever for releasing/locking the steering wheel
- 2 Possible positions

To adjust the steering wheel's height and reach:

1. Pull the lever toward you to release the steering wheel.
2. Adjust the steering wheel to the position that suits you.

3. Push back the lever to lock the steering wheel in place. If the lever is difficult to push into place, press the steering wheel lightly at the same time as you push the lever.

### WARNING

Never adjust the steering wheel while driving.

With the optional speed-dependent power steering the level of steering force can be adjusted, see Active chassis\* (Four C) (p. 162).

### Keypads and steering wheel paddles\*

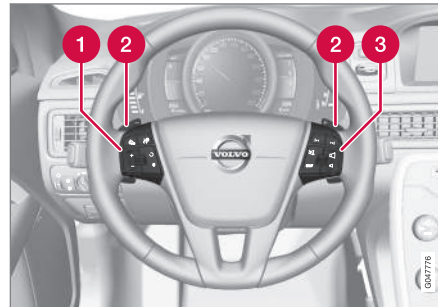

Steering wheel keypads and paddles\*

- 1 Cruise control, see Cruise control (CC) – introduction (p. 168). Adaptive cruise

control\*, see Adaptive Cruise Control – introduction (p. 171).

- 2 Paddles for manually shifting gears (Geartronic), see Transmission – Geartronic (p. 240).
- 3 Infotainment system controls, see Sensus Infotainment supplement.

### Horn



Horn

- Press the steering wheel hub to sound the horn.

### Related information

- Electrically heated\* steering wheel (p. 82)

## Electrically heated\* steering wheel

The steering wheel can be heated electrically.

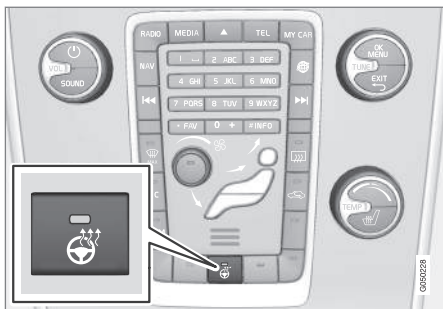

Button for steering wheel heating

With the engine running, press this button once to begin warming the steering wheel (press again to switch off). The indicator light in the button will illuminate when the function is active.

This function can also be started automatically (the setting can be activated/deactivated in the MY CAR menu) if the vehicle is cold and the ambient temperature is below approximately 50° F (10° C).

## Lighting panel

The lighting panel is used to control the daytime running lights, parking lights, etc., and to adjust the instrument panel lighting and "theater" lighting (p. 86).



Lighting panel overview

- 1 Thumb wheel for adjusting display, instrument and "theater" lighting (see Instrument and "theater" lighting (p. 86))
- 2 Rear fog lights (see Rear fog lights (p. 87))
- 3 Headlight switch

Volvo recommends using the **AUTO** position whenever possible.

### Headlight switch positions

Daytime running lights function as follows:

With the headlight switch in the **0** position:

- In the **US**: the daytime running lights will be **off**
- In **Canada**: the daytime running lights will be **on**

With the headlight switch in the **15** position and the ignition in mode II or if the engine is running (see Ignition modes (p. 73))

- In the **US**: the daytime running lights will be **off**
- In **Canada**: the daytime running lights will be **on**

With the headlight switch in the **AUTO** position:

- The daytime running lights will be **on** (the low beam headlights will automatically switch on in dark conditions)

**US models only:** The daytime running lights in **AUTO** mode can be switched on or off in the **MY CAR** menu system under **Settings** → **Car settings** → **Light settings** → **Daytime running lights**.

<sup>15</sup> The parking lights will be on in this position, even if the ignition is switched off.



### NOTE

The use of daytime running lights is recommended in the United States and is **mandatory in Canada**.

With the headlight switch in the  position:



- The daytime running lights will be **off** and the low beam headlights will be **on**

### High/low beam headlights

When the engine is started, the low beams are activated automatically if the headlight control is in position .



Headlight switch and steering wheel lever

-  High beam flash
-  Toggle between high and low beams

### Continuous high beam headlights

With the headlight switch in the **AUTO** (in dark conditions only, when the daytime running lights have automatically switched off and the low beam headlights have switched on) or

 position:

- Pull the lever toward the steering wheel to position 2 and release it to toggle between low and high beams.

### High beam flash

Pull the lever toward the steering wheel to position 1. The high beams come on until the lever is released.

### Related information

- Active Bending Lights (ABL)\* (p. 85)
- Active high beams (AHB)\* (p. 84)
- Lighting panel (p. 82)
- Tunnel detection (models with the rain sensor\* only) (p. 85)

## Active high beams (AHB)\*

AHB uses a camera at the upper edge of the windshield to detect the headlights of oncoming vehicles or the taillights of a vehicle directly ahead. When this happens, the headlights will automatically switch from high beams to low beams. When the camera no longer detects the headlights/taillights of other vehicles, your headlights will switch back to high beams after several seconds.

To activate AHB:

- Turn the headlight control to the **AUTO** position.

The feature will begin functioning if the engine has been running for at least 20 seconds and the vehicle's speed is at least 12 mph (20 km/h).

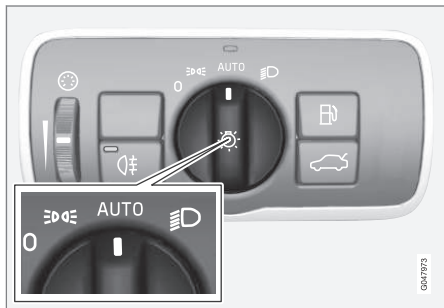

Headlight switch in the **AUTO** position

Switch AHB on or off by pulling the left steering wheel lever rearward (toward the steering wheel) as far as possible and releasing it. If AHB is switched off while the high beams are on, the headlights will change to low beams.



### Models with an analog instrument panel



When AHB is activated, the **CA** symbol will illuminate in the instrument panel. The high beam indicator (**HD**) in the instrument panel will also illuminate when the high beams are on.

### Models with a digital instrument panel

When AHB is activated, **CA** will illuminate as a **white** symbol in the instrument panel. When the high beams are on, the symbol will change to **blue**.

## NOTE

- Keep the windshield in front of the camera free of ice, snow, dirt, etc.
- Do not mount or in any way attach anything on the windshield that could obstruct the camera.

If **Active high beam Temporary unavailable** Switch manually is displayed in the instrument panel, switching between high and low beams will have to be done manually. However, the light switch can remain in the **AUTO** position. The same applies if **Windscreen Sensors blocked** is displayed and the  symbol is displayed. The  symbol will go out when these messages are displayed.

AHB may be temporarily unavailable (e.g., in heavy fog or rain). When AHB becomes active again or if the sensors in the windshield are no longer obscured, the messages will disappear and the  symbol will illuminate.

## CAUTION

In the following situations, it may be necessary to switch between high and low beams manually:

- In heavy fog or rain
- In blowing snow or slush
- In bright moonlight



- In freezing rain
- In areas with dim street lighting
- When oncoming vehicles have dim front lighting
- If there are pedestrians on or near the road
- If there are reflective objects, such as signs, near the road
- When oncoming vehicles' lights are obscured by e.g., fences, bushes, etc.
- When there are vehicles on connecting roads
- At the top of hills or in dips in the road
- In sharp curves

See The camera's limitations (p. 204) for more information about the camera's limitations.

#### Related information

- High/low beam headlights (p. 83)
- Lighting panel (p. 82)

#### Tunnel detection (models with the rain sensor\* only)

*For models without automatic low beams, tunnel detection activates the low beams when the vehicle enters a tunnel. The low beams are switched off approx. 20 seconds after the vehicle leaves the tunnel.*

The rain sensor reacts to the change in lighting conditions when, for example, the vehicle enters a tunnel and the tunnel detection feature will then activate the low beam headlights. The low beams will be switched off approx. 20 seconds after the vehicle leaves the tunnel.

The rain sensor does not have to be activated for tunnel detection to function.

#### Related information

- Lighting panel (p. 82)
- High/low beam headlights (p. 83)

#### Active Bending Lights (ABL)\*

*With ABL activated, the headlight beams adjust laterally to help light up a curve according to movements of the steering wheel (see the right-pointing beam in the following illustration).*



*Headlight pattern with the Active Bending Light function deactivated (left) and activated (right)*

ABL is activated automatically<sup>16</sup> when the engine is started.

The function can be deactivated/reactivated in the **MY CAR** menu system under **My S80** → **Active Bending Lights** or under **Settings** → **Car settings** → **Light settings** → **Active Bending Lights**.

See My Car – introduction (p. 70) for a description of the menu system.

<sup>16</sup> The factory default setting is on.



## NOTE

This function is only active in twilight or dark conditions, and only when the vehicle is in motion.

If a fault should occur in the system, the symbol will illuminate and a message will be displayed as shown in the table.

Symbol	Display	Explanation
	Headlamp failure Service required	The system is not functioning properly and should be inspected/ repaired by a trained and qualified Volvo service technician.

### Related information

- Lighting panel (p. 82)
- High/low beam headlights (p. 83)
- Active high beams (AHB)\* (p. 84)

### Auxiliary lights\*

*If the vehicle is fitted with auxiliary lights, the driver can use the **MY CAR** menu system to choose to deactivate and turn these lights on and off along with the high beam headlights.*

The auxiliary lights must be connected to the vehicle's electrical system, which should only be done by a trained and authorized Volvo service technician. See My Car – introduction (p. 70) for more information about the menu system.

### Instrument and "theater" lighting

#### Instrument lighting

Illumination of the display and instrument lights will vary, depending on ignition mode.

The display lighting is automatically subdued in darkness and the sensitivity is set with the thumb wheel.

The intensity of the instrument lighting is adjusted with the thumb wheel.

#### "Theater" lighting

When the overhead courtesy lighting has gone out and the engine is running, several LEDs located near the roof console illuminate to provide faint lighting for the occupants of the front seats. This lighting goes out just after the overhead courtesy lighting when the vehicle is locked.

#### Related information

- Lighting panel (p. 82)
- Front interior lighting (p. 89)
- Rear interior lighting (p. 90)
- Ignition modes (p. 73)



## Parking lights

Turn the headlight switch to the  position (the license plate lighting comes on at the same time).



Headlight switch in the parking light position

**Canadian models:** If the ignition is in position II or the engine is running, the daytime running lights will also be on.

With the headlight switch in this position, the parking lights will remain on even when the ignition is switched off.

In dark ambient lighting conditions, the rear parking lights also illuminate when the trunk is opened to alert anyone traveling behind your vehicle. This happens regardless of the position that the headlight control is in or which mode the ignition is in.

### Related information

- Lighting panel (p. 82)

## Rear fog lights

The rear fog lights are considerably brighter than the normal taillights and should be used only when conditions such as fog, rain, snow, smoke or dust reduce visibility for other vehicles to less than 500 ft. (150 meters).

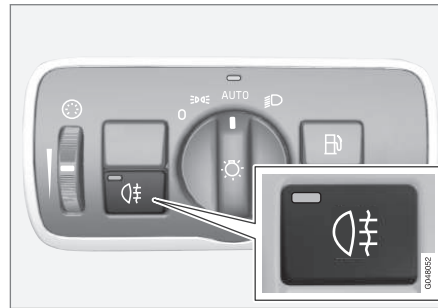

The rear fog lights will only function in combination with the high/low beam headlights.

- Press the button to switch the rear fog lights on/off.
  - > The rear fog light indicator symbol  on the instrument panel and the light in the button illuminate when the rear fog lights are switched on.



### NOTE

- The rear fog lights are considerably brighter than the normal taillights and should be used only when conditions such as fog, rain, snow, smoke or dust reduce visibility for other vehicles to less than 500 ft. (150 meters).
- Condensation may form temporarily on the inside of the lenses of exterior lights such as headlights, fog lights, or taillights. This is normal and the lights are designed to withstand moisture. Normally, condensation will dissipate after the lights have been on for a short time.

### Related information

- Lighting panel (p. 82)

## Hazard warning flashers

The hazard warning flasher should be used to indicate that the vehicle has become a traffic hazard.

When the function is activated, both turn signal indicators in the instrument panel will flash.



Location of the hazard warning flasher button

- To activate the flashers, press the button in the center dash. Press the button again to turn off the flashers.

### **i** NOTE

- Regulations regarding the use of the hazard warning flasher may vary, depending on where you live.
- The hazard warning flashers will be activated automatically if an airbag deploys.

## Related information

- Turn signals (p. 88)

## Turn signals

The turn signals are controlled by the left steering wheel lever.



Turn signals

### When changing lanes

**1** The driver can automatically flash the turn signals 3 times by moving the turn signal lever up or down to the first position and releasing it.

### When turning

**2** Move the lever as far up or down as possible to start the turn signals. The turn signals will be cancelled automatically by the movement of the steering wheel, or the lever can be returned to its initial position by hand.



## NOTE

- This automatic flashing sequence can be interrupted by immediately moving the lever in the opposite direction.
- If the turn signal indicator flashes faster than normal, check for a burned-out turn signal bulb.

## Related information

- Hazard warning flashers (p. 88)

## Front interior lighting

The lighting in the front part of the passenger compartment is controlled with the buttons in the ceiling console.



Light switches, front roof lighting

- 1 Drivers side front reading light, on/off
- 2 Passenger's side front reading light, on/off
- 3 Overhead courtesy lighting.

Switch (3) has three positions for all passenger compartment lighting:

- **Off:** right side depressed, automatic lighting off.
- **Neutral position:** automatic lighting is on.
- **On** – left side depressed, passenger compartment lighting on.

## Overhead courtesy lighting

The passenger compartment lighting is switched on and off automatically when button (3) is in the neutral position.

The lighting comes on and remains on for 30 seconds if:

- the vehicle is unlocked from the outside with the key or remote control
- the engine is switched off and the ignition is in mode **0**.

The lighting switches off when:

- the engine is started
- the vehicle is locked from the outside.

The lighting comes on and remains on for two minutes if one of the doors is open.

The passenger compartment lighting can be switched on and off manually within 30 minutes after the vehicle has been unlocked.

If the lighting is switched on manually and the vehicle is locked, the courtesy lighting will switch off automatically after one minute.

## Courtesy lights/door step lighting\*

The courtesy lights/door step lighting switch on/off automatically when one of the front doors is opened/closed.

## Glove compartment lighting

The glove compartment lighting switches on/off automatically when the lid is opened/closed.



## Related information

- Rear interior lighting (p. 90)

## Rear interior lighting

The lights are switched on or off by pressing each respective button.



Rear reading lights

## Trunk lighting

The trunk lighting comes on automatically when the trunk lid is opened.

## Related information

- Front interior lighting (p. 89)

## Home safe lighting

When you leave your vehicle at night, you can make use of the home safe lighting function to illuminate the area in front of the vehicle.

This function illuminates the headlights, parking lights, lights in the door mirrors, license plate lights, front ceiling lighting and footwell lighting. These lights will remain on for 30<sup>17</sup>, 60 or 90 seconds. The time interval can be set in **MY CAR** under **Settings → Car settings → Light settings → Home safe light duration**. See My Car – introduction (p. 70) for a description of the menu system.

1. Remove the key from the ignition slot to put the ignition in mode **0** (see Ignition modes (p. 73) for information about the ignition modes).
2. Pull the turn signal lever as far as possible towards the steering wheel and release it.
3. Exit the vehicle and lock the doors.

## Related information

- Approach lighting (p. 91)

<sup>17</sup> Factory setting



### Approach lighting

Approach lighting activates the parking lights, door mirror lights, license plate lighting, dome lighting and door step lighting when you approach the vehicle.

This function is activated by pressing the approach light button on the remote key (see the illustration in Remote key – functions (p. 143)).

The time interval for this lighting can be set by pressing **MY CAR** and going to **Car settings** → **Light settings** → **Approach light duration**. See My Car – introduction (p. 70) for a description of the menu system.

### Related information

- Home safe lighting (p. 90)

### Windshield wipers

Move the lever toward the steering wheel to start the windshield and headlight washers. After the lever is released the wipers make several extra sweeps.

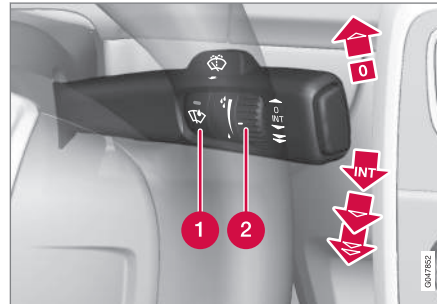

Windshield wipers and washers

- 1 Rain sensor\* on/off
- 2 Thumb wheel sensitivity/frequency



### CAUTION

- Use ample washer fluid when washing the windshield. The windshield should be thoroughly wet when the wipers are in operation.
- Before using the wipers, ice and snow should be removed from the windshield/rear window. Be sure the wiper blades are not frozen in place.

### Windshield wipers off

**0** Move the lever to position **0** to switch off the windshield wipers.

### Single sweep

 Move the lever upward from position **0** to sweep the windshield one stroke at a time for as long as the lever is held up.

### Intermittent wiping

**INT** With the lever in this position, you can set the wiper interval by twisting the thumb wheel upward to increase wiper speed or downward to decrease the speed.

### Continuous wiping

 The wipers operate at normal speed.

 The wipers operate at high speed.

### Windshield wiper service position

The windshield wipers must be in the service position before the wiper blades can be cleaned or replaced. See Wiper blades – service position (p. 326) for additional information.

### Related information

- Engine compartment – washer fluid (p. 328)
- Washer fluid – specification and volume (p. 361)

\* Option/accessory, for more information, see Introduction.

### Rain sensor\*

The rain sensor automatically regulates wiper speed according to the amount of water on the windshield.

The sensitivity of the rain sensor can be adjusted moving the thumb wheel up (the wipers will sweep the windshield more frequently) or down (the wipers will sweep the windshield less frequently).

#### **i** NOTE

The wipers will make an extra sweep each time the thumb wheel is adjusted upward.

When the rain sensor is activated, the symbol  will illuminate in the instrument panel.

### Activating and setting the sensitivity

When activating the rain sensor, the vehicle must be running or in ignition mode II and the windshield wiper lever must be in position 0 or in the single sweep position.

Activate the rain sensor by pressing the button . The windshield wipers will make one sweep.

Press the lever up for the wipers to make an extra sweep. The rain sensor returns to active mode when the stalk is released back to position 0.

### Deactivating

Deactivate the rain sensor by pressing the button  or press the lever down to another wiper position.

The rain sensor is automatically deactivated when the key is removed from the ignition slot or five minutes after the ignition has been switched off.

#### **!** CAUTION

The rain sensor should be deactivated when washing the car in an automatic car wash, etc. If the rain sensor function is left on, the wipers will start inadvertently in the car wash and could be damaged.

### Windshield washer

Move the lever toward the steering wheel to start the windshield and headlight washers. After the lever is released the wipers make several extra sweeps.



Washing function

### Heated washer nozzles\*

The washer nozzles are heated automatically in cold weather to help prevent the washer fluid from freezing.

### High-pressure headlight washing\*

High-pressure headlight washing consumes a large quantity of washer fluid. To save fluid, the headlights are washed using two alternatives:

- **Low/high beam headlights on.** The headlights will be washed the first time the windshield is washed. Thereafter, the headlights will only be washed once for



every five times the windshield is washed within a 10-minute period.

- **Parking lights on.** Optional Active Bending Lights will be washed once for every five times the windshield is washed. Normal halogen headlights will not be washed.

### CAUTION

- Use ample washer fluid when washing the windshield. The windshield should be thoroughly wet when the wipers are in operation.
- When approx. 1 US quart (1 liter) of washer fluid remains in the reservoir, the headlights will no longer be washed. A text message will also be displayed to remind the driver to fill the washer fluid reservoir.

### Related information

- Engine compartment – washer fluid (p. 328)
- Washer fluid – specification and volume (p. 361)

### Tailgate wiper/washer

*The tailgate wiper operates at two speeds: intermittent and continuous.*

#### NOTE

The rear wiper is equipped with a cut-off function, which means that it will not operate if its electric motor overheats. The wiper will function again after a cool-down period (30 seconds or longer, depending on the heat of the motor and ambient temperature conditions).

### Tailgate wiper and reverse gear

If the windshield wipers are on and the transmission is put into reverse gear, the tailgate wiper will go into intermittent wiping function<sup>18</sup>. This function is deactivated when a different gear is selected.

#### NOTE

On vehicles with the optional rain sensor, the tailgate wiper will be activated when reverse is selected, if the rain sensor is activated and it is raining.

If the tailgate wiper is in the normal (continuous) wiping mode, selecting different gears will not affect its function.

### Related information

- Engine compartment – washer fluid (p. 328)
- Washer fluid – specification and volume (p. 361)

<sup>18</sup> Consult your Volvo retailer if you would like to have this function deactivated.

## Power windows

All power windows can be operated using the control panel in the driver's door. The control panels in the other doors only operate the window in the respective doors.



Driver's door control panel

- 1 Switch for disengaging rear door power window buttons
- 2 Rear door window controls
- 3 Front door window controls.

## WARNING

- Always remove the ignition key when the vehicle is unattended to put the ignition in mode 0 (see Ignition modes (p. 73) for information about the ignition modes).
- Never leave children unattended in the vehicle.
- Make sure that the windows are completely unobstructed before they are operated.

## Operating



Operating the power windows

- 1 Manual up/down
- 2 Auto up/down.

For the power windows to function, the ignition must be in at least mode I. When the

vehicle has been running, the power windows can be operated for several minutes after the remote key has been removed from the ignition slot, or until a door has been opened.

## NOTE

- Movement of the windows will stop if they are obstructed in any way.
- To reduce buffeting wind noise if the rear windows are opened, also open the front windows slightly.

## Manual up/down

- Move one of the controls up/down slightly.
  - > The power windows move up/down as long as the control is held in position.

## Auto up/down

- Move one of the controls up/down as far as possible and release it.
  - > The window will open or close completely.

## Resetting

If the battery has been disconnected, the auto open function must be reset so that it will work properly.

1. Gently raise the front section of the button to close the window and hold it for one second.
2. Release the button briefly.



- Raise the front section of the button again for one second.

### Laminated glass



This glass is reinforced to help provide protection against break-ins and improved sound insulation in the passenger compartment.

The windshield, optional moonroof and other windows have laminated glass.

### Sun shades\*

*Sun shades can be integrated into the panels in the rear doors.*

*A sun shade can be integrated into the rear parcel shelf.*

### Sun shades\*

#### Rear window



*Integrated rear sun shade*

- Pull up the sun shade and attach its hooks to the ceiling clips.
  - > The sun shade's spring-loading will pull it taut.

When not in use, release the hooks and hold the sun shade while it retracts.

### Side rear windows

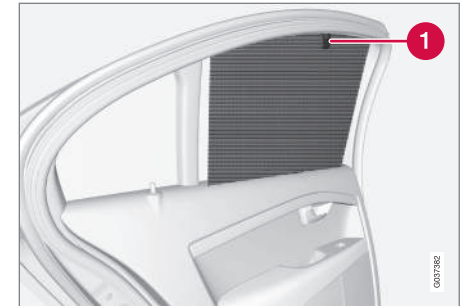

#### 1 Hook and lock tab

The sun shade is integrated into the panels on both rear doors.

- Pull up the sun shade and hook it into the upper edge of the door frame.
- Lock the sun shade in place by pulling lock tab upward.

The window can be opened and closed, even if the sun shade is in use.



## Power door mirrors

The control on the driver's door is used to adjust the position of the door mirrors.



Door mirror controls

### Adjusting

1. Press the **L** button for the left door mirror or the **R** button for the right door mirror. The light in the button comes on.
2. Adjust the position with the joystick in the center.
3. Press the **L** or **R** button again. The light should no longer be on.

### WARNING

Objects seen in the mirrors may appear further away than they actually are.

### Retractable power door mirrors\*

The mirrors can be retracted for parking/driving in narrow spaces:

1. Press down the **L** and **R** buttons at the same time.
2. Release them after approximately one second. The mirrors automatically stop in the fully retracted position.

Fold out the mirrors by pressing down the **L** and **R** buttons at the same time. The mirrors automatically stop in the fully extended position.

### Storing the position\*

The mirror positions are stored in the key memory when the vehicle has been locked with the remote key. When the vehicle is unlocked with the same remote control the mirrors and the driver's seat adopt the stored positions when the driver's door is opened.

The function can be activated/deactivated in **MY CAR** under **Settings** → **Car settings** → **Car key memory** → **Personal settings in key memory**. See My Car – introduction (p. 70) for a description of the menu system.

### Tilting the door mirrors when parking\*

The door mirrors can be tilted down to help give the driver a better view along the sides of the vehicle, for example when parallel parking.

To activate this function, select reverse gear and press the **L** or **R** mirror control button to tilt the mirror down.

The function can be activated/deactivated in **MY CAR** under **Settings** → **Car settings** → **Side mirror settings** → **Tilt left mirror** or **Tilt right mirror**. See My Car – introduction (p. 70) for a description of the menu system.

The door mirror will reset to its normal position:

- after 10 seconds when reverse is disengaged and the car remains stopped.
- immediately when reverse is disengaged and the vehicle's forward speed exceeds approximately 6 mph (10 km/h).
- immediately if you press the corresponding **L** or **R** button again.
- when the engine is turned off.
- when the side mirrors are folded in.

### NOTE

Only one mirror can be tilted down at a time.

### Home safe and approach lighting

The light on the door mirrors comes on when approach lighting or home safe lighting is selected, see Approach lighting (p. 91) and Home safe lighting (p. 90).



### Related information

- Interior rearview mirror (p. 98)
- Heated windshield\*, rear window and door mirror defrosters (p. 98)
- Power door mirrors – automatic tilting/retraction (p. 97)

### Power door mirrors – automatic tilting/retraction

*The control on the driver's door is used to adjust the position of the door mirrors.*

#### Automatically tilting the door mirrors when parking

The door mirrors can tilt down automatically to help give the driver a better view along the sides of the vehicle, for example when parallel parking. When the transmission is no longer in reverse, the mirrors will automatically return to their original position.

This function can be activated/deactivated in **MY CAR** under **Settings** → **Car settings** → **Side mirror settings** → **In reverse gear tilt left mirror** or **In reverse gear tilt right mirror**. See My Car – introduction (p. 70) for information about the **MY CAR** menu system.

#### Automatic retraction when locking

When the vehicle is locked/unlocked with the remote key the door mirrors are automatically retracted/extended.

The function can be activated/deactivated in **MY CAR** under **Settings** → **Car settings** → **Side mirror settings** → **Retract side mirrors when locking**. See My Car – introduction (p. 70) for a description of the menu system.

### Resetting to neutral

Mirrors that have been moved out of position by an external force must be electrically reset to the neutral position for electric retracting/extending to work.

- Retract the mirrors with the **L** and **R** buttons.
- Fold them out again with the **L** and **R** buttons.

The mirrors are now reset in neutral position.

### Related information

- Interior rearview mirror (p. 98)
- Heated windshield\*, rear window and door mirror defrosters (p. 98)



## Heated windshield\*, rear window and door mirror defrosters

The heating function is used to defrost/de-ice the windshield and/or the rear window and door mirrors.

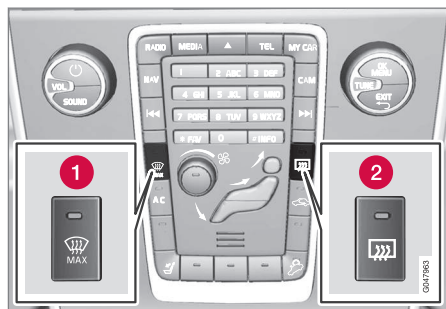

Max. defroster/heated windshield (1), rear window and door mirror defroster (2)

Press button (1) to defrost/de-ice the windshield and/or button (2) to defrost the rear window and door mirrors. The indicator lights in the respective buttons indicate that the function is active. Switch the function off when then windshield/rear window/mirrors have cleared to help avoid battery drain. The heating function will also switch off automatically after a certain amount of time.

The rear window is then defogged/de-iced (the function will switch on and off automatically until the ignition is switched off) if the

ambient temperature remains below 45 °F (7 °C).

Auto-defrosting for the rear window and door mirrors (if the vehicle is started when the ambient temperature is below 45 °F (7 °C) can be selected in **MY CAR** under **Settings**

→ **Climate settings** → **Automatic rear defroster**. See My Car – introduction (p. 70) for a description of the menu system.

## Interior rearview mirror

The interior rearview mirror has an auto-dim function that helps reduce glare from following vehicle's headlights.

### Auto-dim function

The interior rearview mirror's auto-dim function is controlled by two sensors: one pointing forward (located on the forward-facing side of the mirror, which monitors the amount of ambient light) and one pointing rearward (located on the side of the mirror facing the driver at the upper edge, which senses the strength of following vehicles' headlights), and work together to help eliminate glare.



### NOTE

Obstructing the forward sensor with e.g., parking stickers, transponders, etc., or the rear sensor by placing objects on the parcel shelf or the rear seat in such a way that light is prevented from reaching the sensor will reduce the auto-dim function in the rearview mirror.

### Related information

- Power door mirrors (p. 96)



### Digital compass\*

The rear-view mirror has an integrated display that shows the compass direction in which the vehicle is traveling.

#### Operation



Rearview mirror with compass.

Eight different directions are shown with the abbreviations: **N** (north), **NE** (north east), **E** (east), **SE** (southeast), **S** (south), **SW** (southwest), **W** (west) and **NW** (northwest).

The compass is displayed automatically when the vehicle is started or in ignition mode **II**. To switch the compass on/off use a pen, paperclip or similar object and press in the button on the rear side of the mirror.

#### Calibration

North America is divided into 15 magnetic zones and the compass will need to be calibrated if the vehicle is driven into a new one

(see the magnetic zones on the map in the following section "Selecting a magnetic zone"). To do so:

1. Stop the vehicle in a large open area, safely out of traffic and away from steel structures and high-tension electrical wires.
2. Start the vehicle.

#### **i** NOTE

- For best calibration results, switch off all electrical equipment in the vehicle (climate system, windshield wipers, audio system, etc.) and make sure that all doors are closed.
- Calibration may not succeed or be incorrect if the vehicle's electrical equipment is not switched off.

3. Using a pen, paperclip or similar object, press and hold the button on the rear side of mirror for approx. 6 seconds until **C** is displayed in the mirror.
4. Press and hold the button for 3 seconds until the number of the current magnetic zone is displayed.
5. Press the button repeatedly until the number of the desired magnetic zone (**1-15**) is displayed. See the magnetic zones on the map in the following section "Selecting a magnetic zone".

6. Wait until **C** is again displayed in the mirror.
7. Drive slowly in a circle at a speed of no more than 6 mph (10 km/h) until a direction is displayed. This indicates that calibration is complete.
8. Drive around in a circle an additional two times to fine-tune the calibration.
9. **Vehicles with an electrically heated windshield:**\* if **C** is displayed when the heating function is activated, perform step 7 with the heating function on. See also Max. defroster and electrically heated windshield\* (p. 126) for additional information about the heated windshield.

Repeat the calibration procedure if necessary.

#### Selecting a magnetic zone

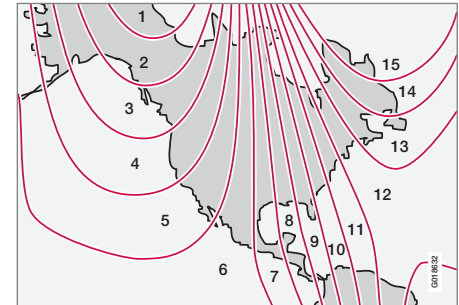

Magnetic zones.



## 03 Instruments and controls

The earth is divided into 15 magnetic zones. The correct zone must be selected for the compass to work correctly.

1. Put the ignition in mode **II**.
2. Using a pen or similar object, press and hold the button on the rear side of mirror for at least 3 seconds. The number for the current area will be shown.
3. Press the button repeatedly until the number for the required geographic area (1 – 15) is shown.
4. The display will revert to showing the compass direction after several seconds.

### Power moonroof – introduction

*The moonroof controls are located in the ceiling console near the rearview mirror.*

*The moonroof's sun visor opens automatically but has to be closed manually.*

*There is a wind blocker in the moonroof's front edge.*

The moonroof<sup>19</sup> controls are located in the ceiling console near the rearview mirror. The moonroof can be opened vertically and horizontally. The vehicle's ignition must be in mode **I** or **II** for the moonroof to be operated.



### CAUTION

- Remove ice and snow before opening the moonroof.
- Do not operate the moonroof if it is frozen closed.
- Never place heavy objects on the moonroof.

### Visor

The moonroof features a sliding visor. The visor slides open automatically when the moonroof is opened, and must be closed manually.

### Wind blocker

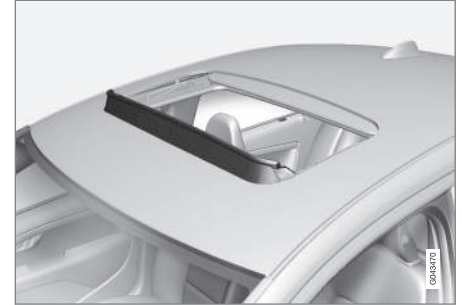

The moonroof is equipped with a wind blocker that folds up when the moonroof is open.

<sup>19</sup> Option on certain models



### Power moonroof – operation

The moonroof controls are located in the ceiling console near the rearview mirror.

The moonroof's sun visor opens automatically but has to be closed manually.

There is a wind blocker in the moonroof's front edge.

### Sliding moonroof

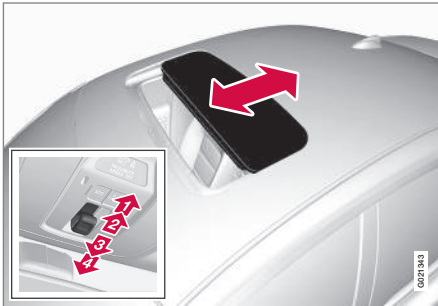

Sliding moonroof, forward/rearward

- 1 Opening, automatic
- 2 Opening, manual
- 3 Closing, manual
- 4 Closing, automatic

### Automatic opening

- Pull the switch as far back as possible (to the position for automatic opening) and release it to automatically fully slide open the moonroof.

### Manual opening

- Pull the switch back to the first stop (the position for manual opening) and hold it until the moonroof has opened to the position of your choice.

### Manual closing

- Push the switch forward to the first stop (the position for manual closing) and hold it until the moonroof has closed to the position of your choice, or has closed completely.

### Automatic closing

- Push the switch as far forward as possible (the position for automatic closing) and release it to automatically close the moonroof.



### WARNING

- During manual closing, if the moonroof is obstructed, immediately open it again.
- Never open or close the moonroof if it is obstructed in any way.
- Never allow a child to operate the moonroof.
- Never leave a child alone in a vehicle.
- When leaving the vehicle, ensure that the ignition is in mode 0 (see Ignition modes (p. 73) for information about the various ignition modes) to disable the moonroof. Never leave the remote key in the vehicle.
- Never extend any object or body part through the open moonroof, even if the vehicle's ignition is completely switched off.



## Tilt position



Tilt position, raised at the rear edge

- ➊ Open by pressing the rear edge of the control upward.
- ➋ Close by pulling the rear edge of the control downward and hold it until the moonroof has closed completely.

## HomeLink® Wireless Control System\* – introduction

The HomeLink<sup>20</sup> Wireless Control System provides a convenient way to replace up to three hand-held radio-frequency (RF) transmitters used to activate devices such as gate operators, garage door openers, entry door locks, security systems, even home lighting. Additional information can be found on the Internet at [www.homelink.com](http://www.homelink.com) or by phoning the hotline at 1-800-355-3515.



## WARNING

- If you use HomeLink to open a garage door or gate, be sure no one is near the gate or door while it is in motion.
- When programming a garage door opener, it is advised to park outside of the garage.
- Do not use HomeLink with any garage door opener that lacks safety stop and reverse features as required by U.S. federal safety standards (this includes any garage door opener model manufactured before April 1, 1982). A garage door that cannot detect an object - signaling the door to stop and reverse - does not meet current U.S. federal safety standards. For more information, contact HomeLink at: [www.homelink.com](http://www.homelink.com).

Retain the original transmitter of the RF device you are programming for use in other vehicles as well as for future HomeLink programming. It is also suggested that upon the sale of the vehicle, the programmed HomeLink buttons be erased for security purposes. Refer to “Resetting HomeLink Buttons” in HomeLink® Wireless Control System\* – programming (p. 103).

<sup>20</sup> HomeLink and the HomeLink house are registered trademarks of Johnson Controls, Inc.



## Using HomeLink

To operate, simply press and hold the programmed HomeLink button until the trained device begins to operate (this may take several seconds). Activation will now occur for the trained device (i.e., garage door opener, gate operator, security system, entry door lock, home/office lighting, etc.). For convenience, the hand-held transmitter of the device may also be used at any time. In the event that there are still programming difficulties or questions, contact HomeLink at: [www.homelink.com](http://www.homelink.com) or by phoning the hotline at 1-800-355-3515.

### NOTE

If the ignition is switched off, HomeLink will function for 30 minutes after the driver's door has been opened.

## HomeLink® Wireless Control System\* – programming

*The HomeLink<sup>21</sup> Wireless Control System provides a convenient way to replace up to three hand-held radio-frequency (RF) transmitters used to activate devices such as gate operators, garage door openers, entry door locks, security systems, even home lighting. Additional information can be found on the Internet at [www.homelink.com](http://www.homelink.com) or by phoning the hotline at 1-800-355-3515.*

### NOTE

Some vehicles may require the ignition to be switched on or be in the “accessories” position for programming and/or operation of HomeLink. It is also recommended that a new battery be placed in the hand-held transmitter of the device being programmed to HomeLink for quicker training and accurate transmission of the radio-frequency signal. The HomeLink buttons must be reset first. When this has been completed, Homelink is in learning mode so that you can perform programming.

1. Position the end of your hand-held transmitter 1–3 inches (5–14 cm) away from the HomeLink button you wish to program while keeping the indicator light in view.

2. Simultaneously press and hold both the chosen HomeLink and hand-held transmitter buttons until the HomeLink indicator light changes from a slow to a rapidly blinking light. Now you may release both the HomeLink and hand-held transmitter buttons.

### NOTE

Some devices may require you to replace this Programming Step 2 with procedures noted in the “Gate Operator / Canadian Programming” section. If the HomeLink indicator light does not change to a rapidly blinking light after performing these steps, contact HomeLink at [www.homelink.com](http://www.homelink.com) or by phoning the hotline at 1-800-355-3515.

<sup>21</sup> HomeLink and the HomeLink house are registered trademarks of Johnson Controls, Inc.



3. Firmly **press, hold for five seconds and release** the programmed HomeLink button up to two separate times to activate the door. If the door does not activate, press and hold the just-trained HomeLink button and observe the indicator light.
  - If the indicator light **stays on constantly, programming is complete** and your device should activate when the HomeLink button is pressed and released.
  - If the indicator light blinks **rapidly for two seconds and then turns to a constant light continue with “Programming” steps 4-6** to complete the programming of a rolling code equipped device (most commonly a garage door opener).
4. At the garage door opener receiver (motor-head unit) in the garage, locate the “learn” or “smart” button. This can usually be found where the hanging antenna wire is attached to the motor-head unit.
5. Firmly press and release the “learn” or “smart” button. (The name and color of the button may vary by manufacturer.) There are 30 seconds to initiate step 6.

6. Return to the vehicle and firmly press, hold for two seconds and release the programmed HomeLink button. Repeat the “press/hold/release” sequence a second time, and, depending on the brand of the garage door opener (or other rolling code equipped device), repeat this sequence a third time to complete the programming process.

HomeLink should now activate your rolling code equipped device.

**Gate Operator/Canadian Programming**  
Canadian radio-frequency laws require transmitter signals to “time-out” (or quit) after several seconds of transmission – which may not be long enough for HomeLink to pick up the signal during programming. Similar to this Canadian law, some U.S. gate operators are designed to “time-out” in the same manner.

If you live in Canada or you are having difficulties programming a gate operator or garage door opener by using the “Programming” procedures, **replace “Programming HomeLink” step 2 with the following:**

- Continue to press and hold the HomeLink button while you **press and release - every two seconds** (“cycle”) your hand-held transmitter until the HomeLink indicator light changes from a slow to a rapidly blinking light. Now you may release both the HomeLink and hand-held transmitter buttons.

Proceed with “Programming” step 3 to complete.

### Resetting HomeLink Buttons

Use the following procedure to reset (erase programming) from the three HomeLink buttons (individual buttons cannot be reset but can be “reprogrammed” as outlined in the following section):

1. Press and hold the two outer HomeLink buttons until the indicator light begins to flash.
2. Release both buttons.
  - > HomeLink is now in the training (or learning) mode and can be programmed at any time beginning with “Programming” - step 1.

### Reprogramming a Single HomeLink Button

To program a device to HomeLink using a HomeLink button previously trained, follow these steps:

1. Press and hold the desired HomeLink button. **DO NOT** release the button.
2. The indicator light will begin to flash after 20 seconds. Without releasing the HomeLink button, proceed with “Programming” - step 1.

For questions or comments, contact HomeLink at: [www.homelink.com](http://www.homelink.com) or phone 1-800-355-3515.



This device complies with FCC rules part 15 and Industry Canada (IC) RSS-210. Operation is subject to the following two conditions: (1) This device may not cause harmful interference, and (2) This device must accept any interference that may be received including interference that may cause undesired operation.

#### **i** NOTE

The transmitter has been tested and complies with FCC and IC rules. Changes or modifications not expressly approved by the party responsible for compliance could void the user's authority to operate the device.<sup>22</sup>

### Volvo Sensus

*Volvo Sensus is the core of the contact interface with your vehicle. Sensus provides information, entertainment and offers access to functions that make owning and operating a Volvo easier.*



Volvo Sensus is the operating system in your vehicle and it enables you to interact intuitively with the vehicle's various features and functions, including accessing the Internet, when it suits you.

Volvo Sensus uses the center console screen to display information and menus, and to offer a user interface that enables you to make personalized settings for e.g., vehicle, infotainment and climate system functions.

The buttons on the center console or the steering wheel keypad are used to activate/deactivate functions and change numerous settings.

Pressing the **MY CAR** button on the center console displays all of the settings related to driving and operating the vehicle, such as City Safety, lock and alarm functions, automatic blower speed, setting the clock, etc.

Pressing the source buttons on the center console (**RADIO, MEDIA, TEL.** , **NAV\*** and **CAM\***, etc.) make it possible to select e.g., AM or FM radio, play a CD or DVD, use the Bluetooth® hands-free feature, the navigation system\* or the park assist camera\*.

See your on-board owner's manual or the separate printed supplements for detailed information about the functionality offered by Volvo Sensus.

<sup>22</sup> The term "IC:" before the certification/registration number only signifies that Industry Canada technical specifications were met.

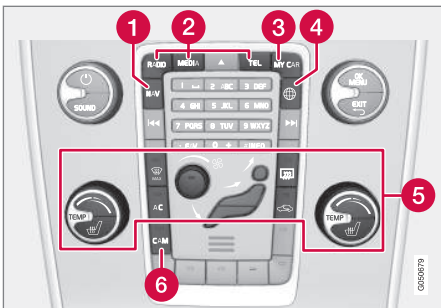

Center console control panel

- 1** Volvo Navigation System (VNS)\* – **NAV**: see the separate VNS manual for operating instructions.
- 2** Infotainment (**RADIO, MEDIA, TEL**)
- 3** Vehicle-related settings - **MY CAR**.
- 4** Internet connected vehicle.
- 5** Climate system.
- 6** Park assist camera - **CAM**\*.

### Related information

- My Car – introduction (p. 70)
- Climate – general information (p. 118)
- Rear Park Assist Camera (PAC) – introduction (p. 223)

### Information display – menu controls

The controls on the left steering wheel lever are used to access the menus (p. 107) that are displayed in the instrument panel (p. 62). The menus displayed depend on the current ignition mode (p. 73).

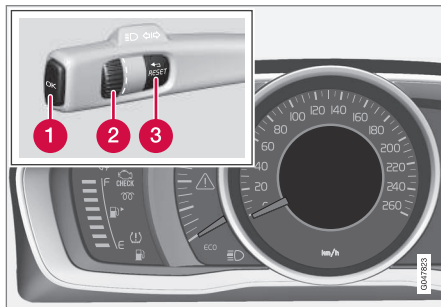

Analog Instrument panel and menu controls

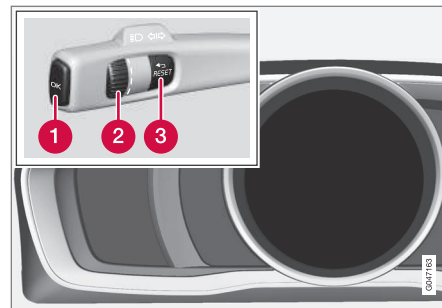

Digital Instrument panel\* and menu controls

- 1** **OK**: access to the list of messages (p. 107) and message confirmation.
- 2** Thumb wheel: browse among menus and options in the list of functions.
- 3** **RESET**: reset the active function. Used in certain cases to select/activate a function, see the explanation under each respective function.

The menus shown on the information displays in the instrument panel are controlled with the left lever. The menus displayed depend on ignition mode. Press **OK** to erase a message and return to the menus.



### Information display – menu overview

The menus displayed depend on the current ignition mode (p. 73).

The following menu alternatives may vary, depending on the equipment installed in the vehicle.

#### Analog instrument panel

##### Digital speed

##### Trip comp. opt.

##### Service status

##### Messages (##)<sup>23</sup>

#### Digital instrument panel\*

##### Settings

##### Themes

##### Contrast mode/Color mode

##### Service status

##### Messages

##### Trip computer reset

#### Related information

- Information displays – introduction (p. 62)
- Information display – menu controls (p. 106)
- Information display – messages (p. 107)

### Information display – messages

The controls on the left steering wheel lever are used to scroll among messages displayed in the instrument panel and to confirm selections.

When information, indicator or warning symbols illuminate, an explanatory message will be displayed in the instrument panel.

When a warning (p. 68), information (p. 66) or indicator symbol (p. 66) comes on, a corresponding message appears in the information panel. An error message is stored in a memory list until the fault is rectified.

Press **OK** to acknowledge and scroll among the messages.

#### NOTE

If a warning message appears while you are using the trip computer, the message must be read and confirmed by pressing **OK** before the previous activity can be resumed.

Message	Description
Stop engine <sup>A</sup>	Stop and switch off the engine as soon as possible. Serious risk of damage. Contact an authorized Volvo workshop.
Stop safely <sup>A</sup>	Stop and switch off the engine. Serious risk of damage. Contact an authorized Volvo workshop.
Service urgent <sup>A</sup>	Have the vehicle checked by an authorized Volvo workshop immediately.
Service required <sup>A</sup>	Have the vehicle checked by an authorized Volvo workshop as soon as possible.
See manual <sup>A</sup>	Read the owner's manual.
Book time for maintenance	Time to book service at an authorized Volvo retailer.

03

<sup>23</sup> Number of messages in parentheses



Message	Description
<b>Time for regular maintenance</b>	Time for regular service at an authorized Volvo workshop. The timing is determined by the number of miles driven, number of months since the last service, engine running time.
<b>Maintenance overdue</b>	If the service intervals are not followed, the warranty does not cover any damaged parts. Contact an authorized Volvo workshop for service.
<b>Temporarily OFF<sup>A</sup></b>	A function has been temporarily switched off and is reset automatically while driving or after starting again.
<b>Low battery Power save mode</b>	The audio system is switched off to save current. Charge the battery.

<sup>A</sup> There will also be a system-specific part of this message

### Related information

- Information displays – introduction (p. 62)
- Information display – menu overview (p. 107)

- Information display – menu controls (p. 106)

### Trip computer – introduction

The content and appearance of the trip computer varies depending on whether the vehicle is equipped with an **Analog** or **Digital** instrument panel.

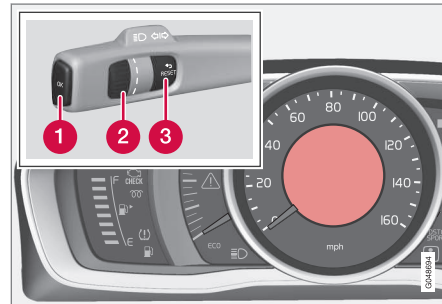

Analog information display and controls

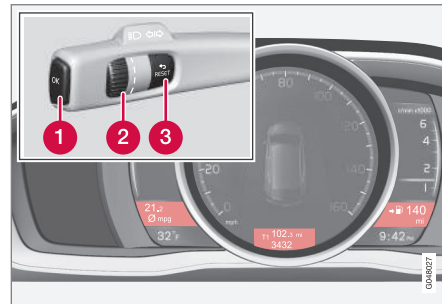

Digital information displays and controls



The instrument panel illuminates as soon as the vehicle is unlocked and trip computer settings can be made. If none of the trip computer's controls are used within 30 seconds after the driver's door has been opened, the instrument panel lighting will go out and the trip computer cannot be used again until:

- the ignition is put in mode II<sup>24</sup>
- the engine is started



#### NOTE

If a warning message appears while you are using the trip computer, this message must be acknowledged in order to return to the trip computer function. Acknowledge a message by pressing **OK**.

#### Related information

- Trip computer – functions, analog instrument panel (p. 110)
- Trip computer – functions, digital instrument panel (p. 113)
- Trip computer – Supplementary information (p. 115)
- Trip computer – Trip statistics (p. 116)

<sup>24</sup> See Ignition modes (p. 73) for information about the various ignition modes.

## Trip computer – functions, analog instrument panel

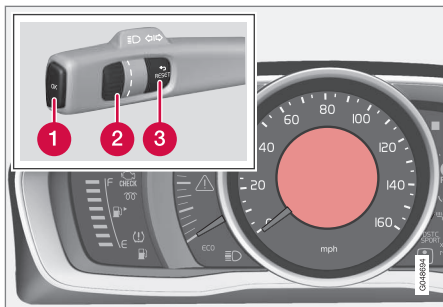

Information display and controls

- 1 **OK**—press to access the trip computer's **functions** or acknowledge/confirm/erase a message
- 2 **Thumb wheel**—turn to access the list of trip computer **information headings** and to scroll among the alternatives
- 3 **RESET**—press to cancel/reset/exit a function after a selection has been made

The trip computer has two different menu groups:

- Trip computer functions
- Trip computer information headings in the instrument panel

### Functions

To open and make settings in the trip computer functions:

1. Ensure that none of the trip computer controls are being used in a command sequence; reset them by pressing **RESET** twice.
2. Press **OK** to open the list of functions.
3. Use the **thumb wheel** to scroll among the functions and select/confirm your choice by pressing **OK**.
4. After completing your selection, exit by pressing **RESET** twice.

The following table lists the analog trip computer's functions:



Function	Description
<b>Digital speed</b> – km/h – mph – None	This displays the vehicle's speed digitally in the center of the instrument panel <ul style="list-style-type: none"> <li>Open by pressing <b>OK</b>, scroll using the <b>thumb wheel</b>, confirm by pressing <b>OK</b> and exit by pressing <b>ENTER</b>.</li> </ul>
<b>Trip comp. opt.</b> – <b>Distance to empty</b> – <b>Fuel consumption</b> – <b>Average speed</b> – Trip odometer <b>T1 and total dist.</b> – Trip odometer <b>T2 and total dist.</b>	Selections among the trip computer information headings are made here. The symbols that have already been selected have a check mark and are displayed in <b>white</b> . Those not selected are not checked and are displayed in <b>gray</b> : <ol style="list-style-type: none"> <li>Open the function by pressing <b>OK</b> and scroll to the desired heading using the <b>thumb wheel</b>.</li> <li>Confirm by pressing <b>OK</b>. The symbol will change colors from gray to white and will be checked.</li> <li>Continue this procedure or exit by pressing <b>RESET</b>.</li> </ol>
<b>Service status</b>	Shows the number of months and mileage until the next scheduled service.
<b>Messages (##)</b>	For additional information, see Information display – menu controls (p. 106).

### Information headings

Any of the information headings in the following table can be displayed. To do so:

- Ensure that none of the trip computer controls are being used in a command sequence; reset them by pressing **RESET** twice.
- Turn the **thumb wheel** to begin displaying the information headings. Stop on the desired heading.
- See the table for an explanation of the heading or the actions that can be taken.



# 03 Instruments and controls



Information headings in the instrument panel	Description
Trip odometer <b>T1</b> and total dist.	<ul style="list-style-type: none"> <li>Press and hold <b>RESET</b> to reset trip odometer T1.</li> </ul>
Trip odometer <b>T2</b> and total dist.	<ul style="list-style-type: none"> <li>Press and hold <b>RESET</b> to reset trip odometer T2.</li> </ul>
<b>Distance to empty</b>	See <b>Distance to empty</b> in Trip computer – Supplementary information (p. 115).
<b>Fuel consumption</b>	Current fuel consumption.
<b>Average speed</b>	Press and hold <b>RESET</b> to reset <b>Average speed</b> .
-	No information will be displayed. This also indicates the beginning/end of the list of information headings.

Scroll among the trip computer information headings at any time by turning the **thumb wheel** until the desired heading is displayed.

### Related information

- Trip computer – introduction (p. 108)
- Trip computer – functions, digital instrument panel (p. 113)
- Trip computer – Supplementary information (p. 115)
- Trip computer – Trip statistics (p. 116)



## Trip computer – functions, digital instrument panel

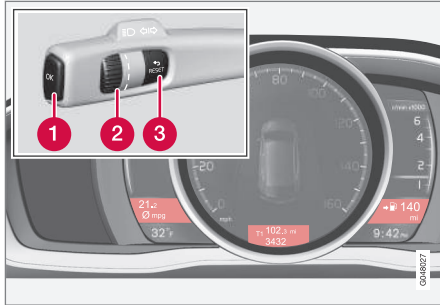

Information displays and controls

- 1 **OK**—press to access the trip computer's **functions** or to activate a selection
- 2 **Thumb wheel**—turn to access the list of trip computer **information headings** and to scroll among the alternatives
- 3 **RESET**—press to cancel/reset/exit a function after a selection has been made

The trip computer has two different menu groups:

- Trip computer functions
- Trip computer information headings in the instrument panel

### Functions

To open and make settings in the trip computer functions:

1. Ensure that none of the trip computer controls are being used in a command sequence; reset them by pressing **RESET** twice.
2. Press **OK** to open the list of functions.
3. Use the **thumb wheel** to scroll among the functions and select/confirm your choice by pressing **OK**.
4. After completing your selection, exit by pressing **RESET** twice.

The following table lists the digital trip computer's functions:

Function	Description
<b>Trip computer reset</b> – Average fuel consumption – Average speed	<b>NOTE:</b> This function does not reset the trip odometers, see Trip computer – Supplementary information (p. 115) for a description of how this is done.
<b>Messages</b>	For additional information, see Information display – menu controls (p. 106).
<b>Themes</b>	Set the way in which information is displayed in the instrument panel, see Information displays – introduction (p. 62).
<b>Settings*</b>	Select <b>Auto On</b> or <b>Off</b> .

\* Option/accessory, for more information, see Introduction.



Function	Description
<b>Contrast mode/Color mode</b>	Adjust the instrument panel's contrast and color.
<b>Service status</b>	Shows the number of months and mileage until the next scheduled service.

### Information headings

Three trip computer headings can be displayed at the same time; one in each of the displays (see the previous illustration). One of the combinations of information headings in the following table can be displayed. To do so:

1. Ensure that none of the trip computer controls are being used in a command sequence; reset them by pressing **RESET** twice.
2. Turn the **thumb wheel** to begin displaying the combinations of information headings. Stop on the desired combination.
3. See the table for an explanation of the heading or the actions that can be taken.

Scroll among the combinations of trip computer information headings at any time by turning the **thumb wheel** until the desired combination is displayed.

Heading combinations			Description
Average fuel consumption	Trip odometer T1 + mileage	Average speed	• Press and hold <b>RESET</b> to reset trip odometer T1.
Current fuel consumption	Trip odometer T2 + mileage	Distance to empty	• Press and hold <b>RESET</b> to reset trip odometer T2.
Current fuel consumption	Mileage	mph<>km/h	Change between mph<>km/h – see "Digital speed display" in Trip computer – Supplementary information (p. 115).
-	No trip computer information displayed	-	No information will be displayed. This also indicates the beginning/end of the list of information headings.

Scroll among the trip computer information headings at any time by turning the **thumb wheel** until the desired heading is displayed.

### Related information

- Trip computer – introduction (p. 108)
- Trip computer – functions, analog instrument panel (p. 110)
- Trip computer – Supplementary information (p. 115)
- Trip computer – Trip statistics (p. 116)



### Trip computer – Supplementary information

General information for both Analog and Digital trip computer functions.

#### Average fuel consumption

Fuel consumption since the last time this function was reset.

#### Average speed

The vehicle's average speed since the last time this function was reset.

#### Current fuel consumption

Current fuel consumption is calculated approximately once a second. When the vehicle is moving at low speed, fuel consumption is displayed per unit of time. At higher speeds, it is displayed in terms of distance.

Miles or kilometers can be displayed, see the heading "Changing units".

#### Distance to empty

This function shows the approximate distance that can be driven on the fuel remaining in the tank. When **Distance to empty** shows "----", there is very little useable fuel remaining in that tank; refuel as soon as possible. The calculation is based on average fuel consumption during the last 20 miles (30 km) of driving and the amount of fuel remaining in the tank (the accuracy of this figure may vary if your driving style changes). An economical

driving style will generally increase this distance.

See Economical driving (p. 265) for information about driving economically.

#### Digital speed display\*

Speed is expressed in the unit not used by the instrument panel's speedometer e.g., if the normal speedometer is in mph, the trip computer will display in the speed in km/h and vice versa.

#### Resetting an analog instrument panel

##### Trip odometer(s) and average speed

1. Display trip odometer T1 or T1, or Average speed.
2. Press and hold **RESET** until selected function is reset.

Each trip computer heading must be reset individually.

#### Resetting a digital instrument panel

##### Trip odometer

1. Turn the **thumb wheel** to select the combination of headings containing the trip odometer to be reset.
2. Press and hold **RESET** until selected trip odometer is reset.

##### Average speed and fuel consumption

1. Select **Trip computer reset** and press **OK**.

2. Select one of the following alternatives using the **thumb wheel** and press **OK**:

- mpg
- mph
- Reset both

3. Finish by pressing **RESET**.

#### Changing units

To change the unit (miles/km) used to measure distance and speed, go to **MY CAR** → **Settings** → **System options** → **Distance and fuel units**.



#### NOTE

In addition to changing units in the trip computer, this also changes the units used in the Volvo Navigation System (VNS)\*.

#### Related information

- Trip computer – introduction (p. 108)
- Trip computer – functions, analog instrument panel (p. 110)
- Trip computer – functions, digital instrument panel (p. 113)
- Trip computer – Trip statistics (p. 116)

\* Option/accessory, for more information, see Introduction.

### Trip computer – Trip statistics

Trip information from previous trips regarding average fuel consumption and average speed is stored and can be displayed in the form of a bar chart.

#### Function

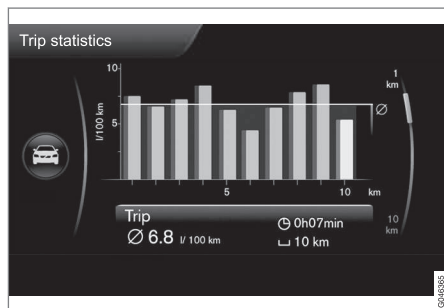

Trip statistics<sup>25</sup>

Each bar represents a driving distance of 1 mile or 10 miles, depending on the current scale; the bar at the far right shows the value for the current mile/10 miles.

Use **TUNE** to change between 1 mile and 10 miles; the marker at the right will also change according to the scale selected.

#### Settings

Settings can be made in the **MY CAR** menu system as follows:

#### MY CAR → My S80 → Trip statistics:

- **Start new trip:** press **ENTER** to erase all previous statistics. Exit the menu by pressing **EXIT**.
- **Reset for every driving cycle:** select by pressing **ENTER**. Exit the menu by pressing **EXIT**.

Selecting **Reset for every driving cycle** erases all trip statistics automatically if the ignition is switched off for at least 4 hours. When the engine is restarted, new statistics will be stored.

To get new statistics if the engine is restarted before 4 hours have elapsed, the existing ones have to be erased manually by selecting **Start new trip**.

For additional information, see Information display – menu controls (p. 106).

See also the information about Eco Guide in Eco Guide\* and Power Meter\* (p. 65).

#### Related information

- Trip computer – introduction (p. 108)
- Trip computer – functions, analog instrument panel (p. 110)
- Trip computer – functions, digital instrument panel (p. 113)
- Trip computer – Supplementary information (p. 115)

<sup>25</sup> The illustration is generic; certain details may vary from model to model

# 04

CLIMATE





### Climate – general information

The vehicle is equipped with Electronic Climate Control (ECC) (p. 122) that cools, heats or dehumidifies the air in the passenger compartment.

### Air conditioning

#### NOTE

- The air conditioning can be switched off, but to ensure the best possible climate comfort in the passenger compartment and to prevent the windows from misting, it should always be on.
- In warm weather, a small amount of water may accumulate under the car when it has been parked. This water is condensation from the A/C system and is normal.

### Side windows and moonroof

To ensure that the air conditioning works optimally, the side windows, and the optional moonroof should be closed.

### Fog on the inside of the windows

The defroster function (p. 126) should be used to remove fog or mist from the inside of the windows. Keeping the windows clean with a commercially available window washing spray will also help prevent fogging or misting.

### Vents in the parcel shelf

#### NOTE

The air vents at the rear of the parcel shelf should never be obstructed.

### Temporary shut-off of the air conditioning

The air conditioning (p. 125) is momentarily disengaged during full acceleration or when driving uphill with a trailer. This may result in a temporary increase in cabin temperature.

### Ice and snow

Always keep the air intake grille at the base of the windshield free of snow.

### Climate system maintenance

Special tools and equipment are required to maintain and carry out repairs on the climate system. Work of this type should only be done by a trained and qualified Volvo service technician.

### Refrigerant

Volvo cares about the environment. The air conditioning system in your car contains a CFC-free refrigerant – R134a. This substance will not deplete the ozone layer. The air conditioning system contains 1.76 lbs (800 g) of R134a. The systems uses PAG oil.

### Related information

- Climate – sensors (p. 119)
- Climate – menu settings (p. 120)



## Climate – sensors

The climate system utilizes a number of sensors to help regulate the temperature and humidity level in the passenger compartment.

### Sensor location

- The sunlight sensor is located on the top side of the dashboard.

#### NOTE

The sunlight sensor monitors which side of the car that is most exposed to sunlight. This can mean that the temperature may differ between the right and left-side air vents, even if the temperatures set for both sides of the passenger compartment are the same.

- The temperature sensor for the passenger compartment is located below the climate control panel.
- The outside (ambient) temperature sensor is located on the door mirror.
- The humidity sensor\* is located in the interior rearview mirror.

#### NOTE

Do not cover or block the sensors with clothing or other objects.

### Related information

- Climate – general information (p. 118)

## Air quality

The passenger compartment has been designed to be pleasant and comfortable, even for people with asthma and contact allergies.

### Passenger compartment filter

Replace the cabin air filter with a new one at the recommended intervals. Please refer to your Warranty and Service Records Information booklet, or consult a trained and qualified Volvo service technician for these intervals. The filter should be replaced more often when driving under dirty and dusty conditions. The filter cannot be cleaned and therefore should always be replaced with a new one.

#### NOTE

There are different types of cabin air filters. Ensure that the correct type is installed.

### Interior Air Quality System (IAQS)

A multifilter helps reduce gases and particles in the incoming air, thereby reducing the levels of odors and contaminants entering the vehicle. The air quality sensor detects increased levels of contaminants in the outside air. When the air quality sensor detects contaminated outside air, the air intake closes and the air inside the passenger compartment is recirculated, i.e., no outside air enters the vehicle. The filter also cleans recirculated passenger compartment air.

#### NOTE

Contact your Volvo retailer for IAQS air filter replacement intervals.

### Materials used in the cabin

The materials used in the cabin have been developed to help minimize the amount of dust and make the cabin easier to keep clean. All floor mats can be easily removed for cleaning. Use car cleaning products recommended by Volvo. See also the information in Cleaning the interior (p. 345).

### Related information

- Climate – general information (p. 118)
- Interior Air Quality System (IAQS)\* (p. 120)
- Climate – menu settings (p. 120)



### Interior Air Quality System (IAQS)\*

The Air Quality System (IAQS) consists of a multifilter and an air quality sensor. The filter helps remove gases and particles from the incoming air, thereby reducing the amounts of odors and contaminants entering the vehicle.

The air quality (p. 119) sensor detects increased levels of contaminants in the outside air. When the air quality sensor detects contaminated outside air, the air intake closes and the air inside the passenger compartment is recirculated, i.e., no outside air enters the vehicle. The filter also cleans recirculated passenger compartment air. When the **AUTO** (p. 125) button is depressed the air quality sensor is always engaged.

Activate or deactivate this function in **Climate settings** → **Interior air quality system**.



#### NOTE

- The air quality sensor should always be engaged in order to obtain the best air in the passenger compartment.
- Recirculation is limited in cold weather to avoid fogging.
- If the insides of the windows start fogging, disengage the air quality sensor. Use the defroster function to increase airflow to the front, side, and rear windows.

### Related information

- Climate – general information (p. 118)
- Max. defroster and electrically heated windshield\* (p. 126)

### Climate – menu settings

The default settings for four of the climate system's (p. 118) functions can be changed in the menu system.

- Blower speed (p. 124) in automatic mode (p. 125).
- Recirculation timer (p. 128) for passenger compartment air.
- Automatic rear window defrosting (p. 98).
- The optional Interior Air Quality System (p. 120) (IAQS).

The functions can also be returned to factory settings in the menu system.

See My Car – introduction (p. 70) for a description of the menu system.

### Related information

- Electronic climate control (ECC) (p. 122)



## Air distribution – general

The incoming air is distributed through a number of different vents in the passenger compartment.

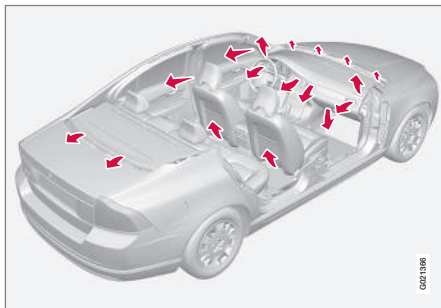

Air distribution is fully automatic in **AUTO** mode (p. 125).

If desired, air distribution can be controlled manually, see Air distribution – function (p. 127).

## Air vents in the dashboard

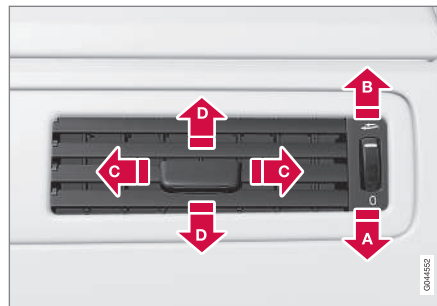

- A** Open
- B** Closed
- C** Horizontal airflow
- D** Vertical airflow

Direct the outer air vents toward the side windows to defrost.

## Air vents in the door pillars

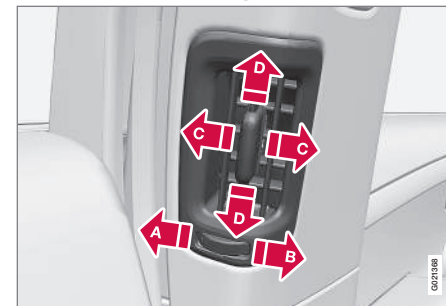

- A** Open
- B** Closed
- C** Horizontal airflow
- D** Vertical airflow

Direct the outer air vents toward the side windows to defrost.

Direct the vents into the passenger compartment to help maintain the desired temperature in the rear seat.

### Related information

- Climate – general information (p. 118)
- Air distribution – table (p. 129)
- Air distribution – recirculation (p. 128)
- Max. defroster and electrically heated windshield\* (p. 126)

\* Option/accessory, for more information, see Introduction.



## Electronic climate control (ECC)

ECC (Electronic Climate Control) helps maintain the selected temperature in the passenger compartment and the temperature can be

set separately on the driver's and passenger's sides.

The AUTO function (p. 125) automatically regulates the temperature, air conditioning, blower speed, recirculation and air distribution.

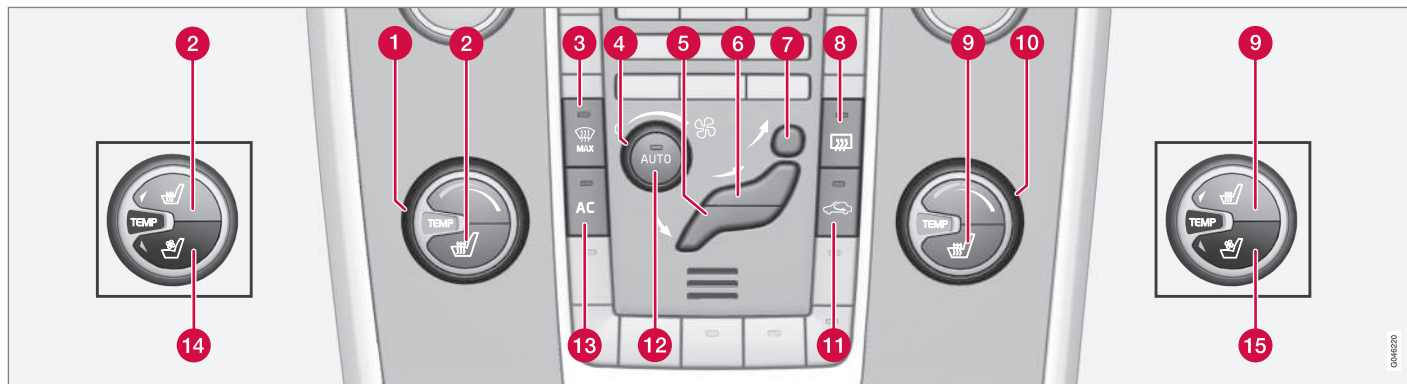

- ❶ Temperature control (p. 124), driver's side
- ❷ Heated driver's seat\* (p. 123)<sup>1</sup>
- ❸ Defroster (maximum effect), electrically heated windshield\* (p. 126)
- ❹ Blower (p. 124)
- ❺ Manual air distribution (p. 121)—floor
- ❻ Manual air distribution—dashboard air vents
- ❼ Manual air distribution—defroster
- ❽ Heated rear window and door mirrors (p. 98)
- ❾ Heated front passenger's seat\* (p. 123)
- ❿ Temperature control (p. 124), passenger's side
- ⓫ Recirculation (p. 128)
- ⓬ **AUTO** (p. 125)
- ⓭ **A/C** (p. 125) on/off
- ⓮ Ventilated driver's seat (p. 124)\*
- ⓯ Ventilated passenger's seat\* (p. 124)\*

### Related information

- Climate – general information (p. 118)

<sup>1</sup> The location of the button varies, depending on whether the vehicle is equipped with the optional ventilated front seats



## Heated seats

The front seat heating has three levels to increase comfort for the driver and passenger in cold weather.

The rear outboard seat heating has three levels to increase comfort for the passengers in cold weather.

### Heated front seats\*

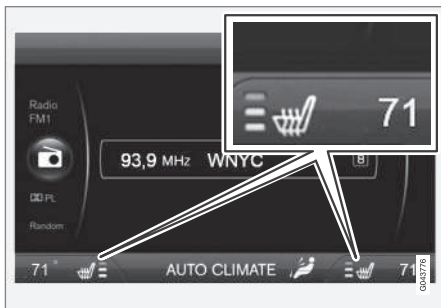

The current seat temperature setting is shown in the center console display



Press the lower section of the button repeatedly until the desired number of indicator lights illuminate:

Highest heat level – three indicator lights.

Medium heat level – two indicator lights.

Lowest heat level – one indicator light.

If no indicator lights are illuminated, the seat heating is switched off.

Seat heating will automatically switch off when the engine is switched off.

### Starting the seat heating automatically

This setting starts heating the driver's seat (at the highest level) automatically when the engine is started if the ambient temperature is below approx. 50° F (10° C).

Activate/deactivate this function in the **MY CAR** menu system, under **Settings** → **Climate settings** → **Auto start driver seat heater**.

### Heated rear seats\*



Heat control for the outboard seating positions is done in the same way as for the front seats.

## Related information

- Climate – general information (p. 118)
- Electronic climate control (ECC) (p. 122)
- Ventilated seats (p. 124)



## Ventilated seats

Seat ventilation can be used at the same time as seat heating (p. 123) to e.g., help remove dampness from the seat occupant's clothing.

## Ventilated front seats\*

The ventilation system consists of fans in the seats and backrests that draw air through the seat upholstery. The cooling effect increases as the air in the passenger compartment becomes cooler.

The ventilation is controlled by the ECC system (p. 122), which takes into account the seat temperature, sunlight in the passenger compartment, and the ambient temperature.

The ventilation can be used at the same time as seat heating.

The ventilation system can be activated when the engine is running. There are three comfort levels that produce different cooling and dehumidifying effects:

- Level three: press the button once for maximum output – three indicator lights come on.
- Level two: press the button twice for a lower output – two indicator lights come on.
- Level one: press the button three times for the lowest output – one indicator light comes on.

- Press the button a fourth time to switch off the function – the indicator light will go out.

## Related information

- Climate – general information (p. 118)

## Temperature and blower control

When the vehicle is started, the most recent setting is resumed.

The blower should always be activated to help avoid condensation and fogging on the windows.

## Temperature control



The temperatures on the driver and passenger sides can be set separately.



## NOTE

Heating or cooling cannot be speeded up by selecting a higher/lower temperature than the actual temperature required.

## Blower control



Turn the control clockwise to increase or counterclockwise to decrease the blower speed. If **AUTO** (p. 125) is selected, blower speed will be regulated automatically and this will override manual

adjustment.



### NOTE

If the blower is turned off completely, the air conditioning is disengaged, which may result in fogging on the windows.

### Related information

- Climate – general information (p. 118)
- Electronic climate control (ECC) (p. 122)
- Air conditioning (p. 125)
- Climate – sensors (p. 119)

### Automatic climate control

*The Auto function automatically controls temperature (p. 124), air conditioning (p. 125), blower speed (p. 124), recirculation (p. 128) and air distribution (p. 121).*



If you select one or more manual functions, the other functions continue to be controlled automatically. The air quality (p. 119) sensor is engaged and all manual settings are switched off when

**AUTO** is pressed. The display shows **AUTO CLIMATE**.

Blower speed in automatic mode can be set under **Climate settings** → **Automatic blower adjustment**. Choose between **Low**, **Normal** or **High**.

### NOTE

Selecting the lowest blower speed may increase the risk of fog forming on the windows.

### Related information

- Climate – general information (p. 118)

### Air conditioning

*The air conditioning function cools and dehumidifies the air in the passenger compartment.*



When the indicator light in the button is on, the air conditioning is controlled automatically. This cools/heats and dehumidifies the incoming air. When the indicator light in the button is off, the

air conditioning is disengaged. Other functions are still controlled automatically. When maximum defroster (p. 126) is selected, the air conditioning system is set for maximum blower speed and dehumidifies the cabin as quickly as possible.

### Related information

- Climate – general information (p. 118)
- Automatic climate control (p. 125)



## Max. defroster and electrically heated windshield\*

The heated windshield and max. defroster functions are used to clear the windshield and front side windows of condensation and ice as quickly as possible.



The selected settings are shown in the center console display

- 1 Electrical heating\*
- 2 Max. defroster



Models **without** an electrically heated windshield

- Press the button once to start defrosting/de-icing the windshield and front side windows. The indicator light (2) in the defroster button illuminates when the function is active.
- Press the button twice to switch off the defroster (the indicator light will switch off).

Models **with** an electrically heated windshield\*

- If this feature is switched off, press the button once to start heating the windshield<sup>2</sup>. Symbol (1) will illuminate in the center console display.
- Press the button twice to start both the defroster and the windshield heating. Symbols (1) and (2) will illuminate in the center console display.
- If these features are on, press the button to switch them off. The symbols will no longer be displayed.



### NOTE

- Triangular areas at the far sides of the windshield are not heated electrically and will take slightly longer to defrost/de-ice.
- The heated windshield may affect the performance/range of e.g., transponders used to automatically pay highway tolls or other communication equipment.

The following occurs when the defroster/windshield heating functions have been activated:

- Blower speed increases automatically and the air conditioning (p. 125) will switch on (if not already on and if the passenger compartment blower is not turned off) to dehumidify the air in the passenger compartment. Air conditioning can be switched off by pressing the **AC** button.
- Recirculation (p. 128) will not function while defrost is engaged.

The climate system will return to its previous settings when the defroster/windshield heating function is switched off.

See also Heated windshield\*, rear window and door mirror defrosters (p. 98) for additional information.

<sup>2</sup> If a "C" appears in the rear-view mirror when the button is pressed, the compass\* has to be recalibrated, see Digital compass\* (p. 99).



### Related information

- Climate – general information (p. 118)
- Automatic climate control (p. 125)

### Air distribution – function

The air distribution function consists of three buttons.

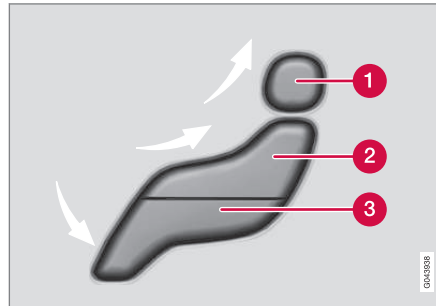

- 1 Manual air distribution—defroster
- 2 Manual air distribution—dashboard air vents
- 3 Manual air distribution—floor

When a button is pressed, the corresponding figure will appear in the display with an arrow indicating which manual air flow has been selected (see the following illustration). See also the air distribution chart (p. 129).

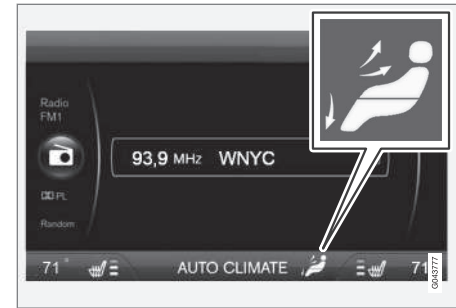

Air distribution is shown in the center console display

### Related information

- Climate – general information (p. 118)
- Air distribution – general (p. 121)
- Air distribution – recirculation (p. 128)



### Air distribution – recirculation

*Recirculation can be used to shut out exhaust fumes, smoke, etc., from the passenger compartment.*



The air in the passenger compartment is then recirculated, i.e., no air from outside the car is taken into the car when this function is activated. The indicator light in the button will illuminate

when recirculation is selected.

If the air in the car recirculates for too long, there is a risk of condensation forming on the insides of the windows, especially in winter.

### Timer

The timer function minimizes the risk of fogging, or stale air when the recirculation function is selected by automatically switching off the function after a certain length of time, depending on the ambient temperature. Activate/deactivate the function under **Climate settings** → **Recirculation timer**. See My Car – introduction (p. 70) for a description of the menu system.

### **i** NOTE

When Defroster is selected, recirculation is always deactivated.









### Related information

- Climate – general information (p. 118)
- Air distribution – general (p. 121)
- Air distribution – function (p. 127)
- Air distribution – table (p. 129)



### Air distribution – table

Air distribution (p. 121) is selected using the buttons in the center console climate panel.

	Air distribution	Use		Air distribution	Use
	Air to windows. Some air flows from the dashboard air vents. The air is not recirculated. Air conditioning is always engaged.	To remove de-fog/de-ice the front side windows and windshield quickly.		Air to the floor and windows. Some air flows from the dashboard air vents.	To ensure comfortable conditions and good de-fogging in cold or humid weather.
	Air to windshield and side windows. Some air flows from the air dashboard vents.	In cold or humid weather (blower speed should be moderate to high).		Air to floor and from dashboard air vents.	In sunny weather with cool outside temperatures.
	Airflow to windows and from dashboard air vents.	To ensure good comfort in warm, dry weather.		Air to floor. Some air flows to the dashboard air vents and windows.	To warm or cool the feet.
	Airflow to the head and chest from the dashboard air vents.	To ensure efficient cooling in warm weather.		Airflow to windows, from dashboard air vents and to the floor.	To cool the feet or provide warmer air to the upper body in cold weather or hot, dry weather.



## 04 Climate



### Related information

- Climate – general information (p. 118)
- Air distribution – function (p. 127)
- Max. defroster and electrically heated windshield\* (p. 126)

# 05

## LOADING AND STORAGE

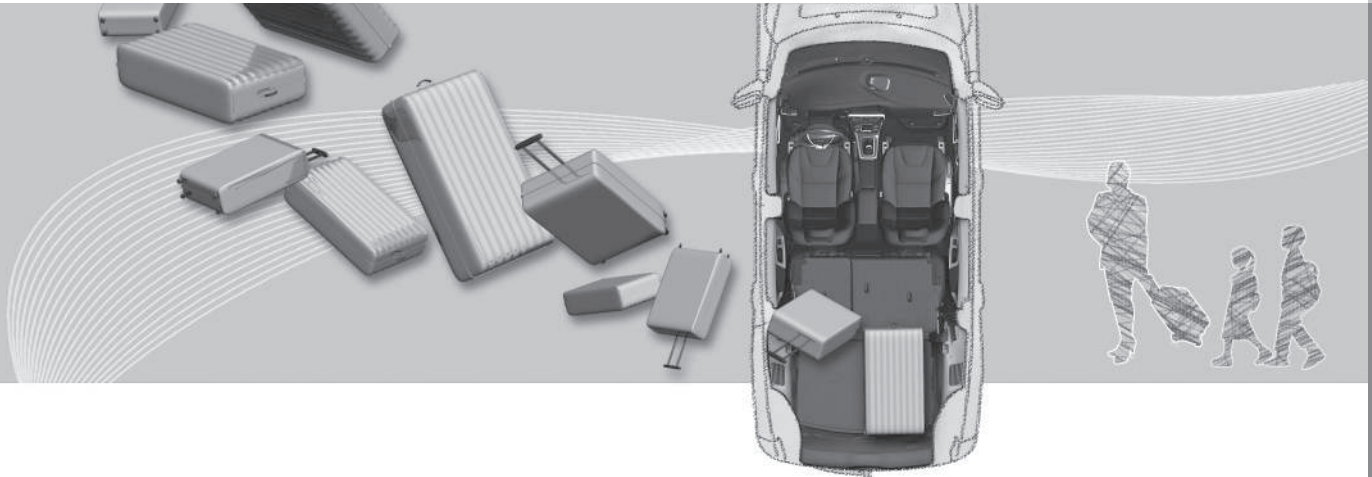



# 05 Loading and storage

## Storage spaces

The following is an overview of the storage compartments in the passenger compartment.

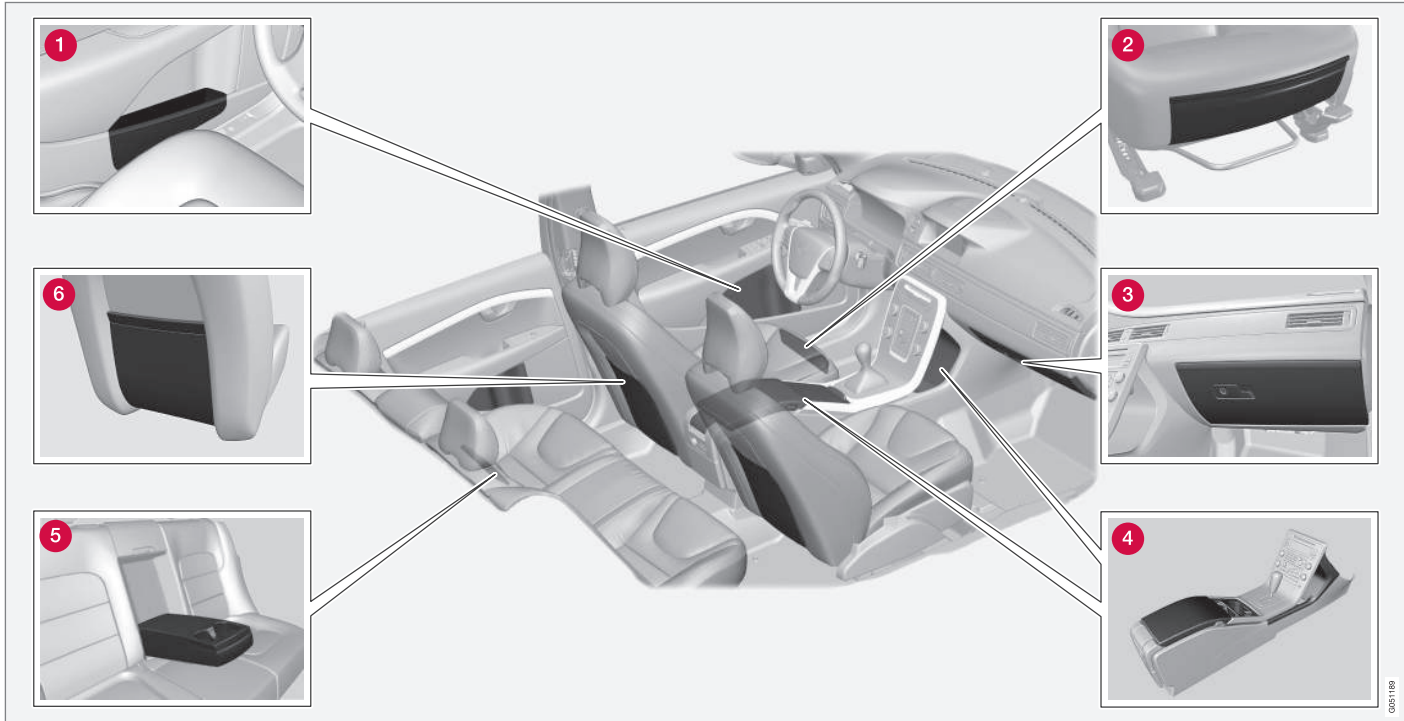



- 1 Compartment in door panel
- 2 Storage pocket on the front edge of the front seat cushions
- 3 Glove compartment (p. 135)
- 4 Storage compartment (p. 134), 12-volt socket (p. 134) and AUX input
- 5 Rear seat cup holders
- 6 Storage pocket

### Related information

- Vanity mirror (p. 135)
- 12-volt socket in the trunk\* (p. 135)

## Tunnel console

The tunnel console is located between the front seats.

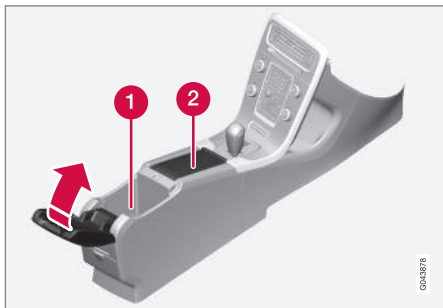

- 1 Storage compartment (for CDs, etc.) under armrest, AUX input/USB connector.
- 2 Includes cup holder for driver and passenger, 12-volt socket (p. 134) and a small storage compartment.

### Related information

- Storage spaces (p. 132)

## Tunnel console – 12-volt sockets

The electrical sockets can be used for 12-volt accessories such as cell phone chargers and coolers. For the socket to supply current, the ignition must be in at least mode I (p. 73). The sockets are located between the cup holders in the tunnel console and on the rear side of the tunnel console (p. 134) for rear seat passengers.



12-volt socket in the front tunnel console



12-volt socket in the rear center console

The maximum current consumption is 10A (120W) if only one of the 12-volt sockets in the passenger compartment is in use. If both the front and rear sockets are used at the same time, the maximum current consumption per socket is 7.5A (90W).

The auxiliary sockets can also be used to power a cigarette lighter. Accessory cigarette lighters and ashtrays can be purchased from your Volvo retailer.

### WARNING

Always keep the sockets covered when not in use.

### Related information

- Storage spaces (p. 132)
- 12-volt socket in the trunk\* (p. 135)



### Glove compartment

The glove compartment provides a lockable storage compartment for small items.



The owner's manual and maps can be kept here. There are also holders for pens and fuel cards. The glove compartment can be locked manually with the key blade, see Locking/unlocking – glove compartment (p. 155).

#### Related information

- Storage spaces (p. 132)

### Vanity mirror

The vanity mirrors are located on the upper side of the sun visors.



Vanity mirror with lighting

The light comes on automatically when the cover is lifted.

#### Related information

- Storage spaces (p. 132)
- Bulbs – vanity mirror lighting (p. 325)

### 12-volt socket in the trunk\*

This 12-volt socket can be used e.g., to connect the tire sealing system's compressor (certain models) and other 12-volt accessories.



Fold down the cover to access the electrical socket.

#### **i** NOTE

The 12-volt socket in the trunk provides electrical current even when the ignition is switched off. Using the socket while the engine is not running will drain the battery.

#### Related information

- Storage spaces (p. 132)
- Tunnel console – 12-volt sockets (p. 134)

## Loading – general

The load carrying capacity of your vehicle is determined by factors such as the number of passengers, the amount of cargo, the weight of any accessories that may be installed, etc.

To increase loading space, the rear seat backrests can be folded down, see Rear seats – folding backrest (p. 80).

When loading the trunk, keep the following in mind:



The trunk lid can be unlocked and popped open slightly via the button located on the lighting panel, see Locking/unlocking – trunk (p. 156).

- Load objects in the trunk against the backrest whenever possible.
- Unstable loads can be secured to the load anchoring eyelets with straps or web lashings to help keep them from shifting.
- Stop the engine and apply the parking brake when loading or unloading long objects. The gear selector can be knocked out of position by long loads, which could set the vehicle in motion.

**⚠ WARNING**

- Stop the engine, put the gear selector in **P**, and apply the parking brake when loading or unloading long objects.
- The vehicle's driving characteristics may change depending on the weight and distribution of the load.
- A 44-pound (20 kg) object produces a force of 2,200 pounds (1,000 kg) in a head-on collision at 30 mph (50 km/h).
- The rear seat should not be loaded to a level higher than 2 in. (5 cm) below the upper edge of the rear side windows. Objects placed higher than this level could impede the function of the Volvo Inflatable Curtain.

### Related information

- Load anchoring eyelets (p. 138)
- Loading – roof load carriers (p. 137)

## Ski hatch

There is a hatch in the right section of the rear seat backrest that can be opened for transporting long objects.

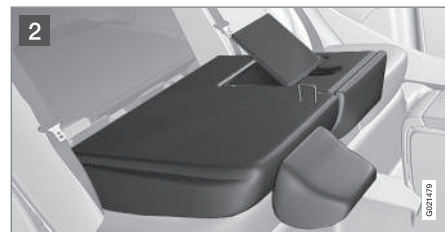



- 1 Fold the right backrest forward.
- 2 Release the hatch in the rear seat backrest by sliding the catch up while folding the hatch forward.
- 3 Return the backrest to the upright position with the hatch open.

Use the seat belt to prevent the load from moving.

### **WARNING**

- Always secure the load to help prevent it from moving in the event of sudden braking.
- Switch off the engine, apply the parking brake and put the gear selector in **P** when loading and unloading the vehicle.

The cover on the rear seat armrest/child seat has no hinge. The cover must be removed before the ski hatch is used.

#### **Removal:**

- Open the cover 30 degrees and lift straight up.

#### **Installation:**

- Insert the cover in the grooves behind the upholstery and close the cover.

#### **Related information**

- Loading – general (p. 136)

## **Loading – roof load carriers**

### **Using load carriers**

Load carriers are available as Volvo accessories. Observe the following points when in use:

- To avoid damaging your vehicle and to achieve maximum safety when driving, we recommend using the load carriers that Volvo has developed especially for your vehicle.
- Volvo-approved removable roof racks are designed to carry the maximum allowable roof load for this vehicle: 220 lbs (100 kg). For non-Volvo roof racks, check the manufacturer's weight limits for the rack.
- Never exceed the rack manufacturer's weight limits and never exceed the maximum rated roof load of 220 lbs (100 kg).
- Avoid single-point loads. Distribute loads evenly.
- Place heavier cargo at the bottom of the load.
- Secure the cargo correctly with appropriate tie-down equipment.
- Check periodically that the load carriers and load are properly secured.
- Remember that the vehicle's center of gravity and handling change when you carry a load on the roof.

- The vehicle's wind resistance and fuel consumption will increase with the size of the load.
- Drive smoothly. Avoid rapid starts, fast cornering and hard braking.

### **Related information**

- Loading – general (p. 136)
- Load anchoring eyelets (p. 138)

## Load anchoring eyelets

The load anchoring eyelets on both sides of the vehicle are used to fasten straps, etc., to help anchor items in the trunk.

### WARNING

The two upper hooks shown in the illustration are for holding grocery bags only. They are **not** intended for anchoring heavy objects.



### WARNING

- Cover sharp edges on long loads to help prevent injury to occupants. Secure the load to help prevent shifting during sudden stops.
- Always secure large and heavy objects with a seat belt or cargo retaining straps.
- Always secure the load to help prevent it from moving in the event of sudden stops.
- Switch off the engine, apply the parking brake and put the gear selector in **P** when loading and unloading the vehicle.

### Related information

- Loading – general (p. 136)

## Grocery bag holder

The grocery bag holder holds shopping bags in place.



Grocery bag holder under the floor of the trunk

The grocery bag holder holds shopping bags in place.

1. Open the hatch in the floor of the trunk.
2. Secure the shopping bags with the strap.

### Related information

- Loading – general (p. 136)

# 06

## LOCKS AND ALARM





## Remote key and key blade

Two remote keys are provided with your vehicle. They enable you to unlock the doors and trunk, and also function as ignition keys to start the vehicle or operate electrical components. The remote keys contain detachable metal key blades for manually locking or unlocking the driver's door and the glove compartment. The visible ends of these key blades are unique to make it easier to identify "your" remote key. Up to six remotes can be programmed for use on the same vehicle.

### WARNING

Never leave the remote key in the ignition slot if children are to remain in the vehicle.

For more information on the various ignition modes, see Ignition modes (p. 73).

## Related information

- Remote key – functions (p. 143)
- Remote key – functions (p. 143)
- Remote key – range (p. 144)

## Remote key – loss

If either of the remote keys (p. 140) is lost, the other should be taken with the vehicle to a Volvo retailer. As an anti-theft measure, the code of the lost remote key must be erased from the system.

### NOTE

Additional or duplicate remote control keys can be obtained from any authorized Volvo retailer.

You can also obtain additional or duplicate remote control keys from certain independent repair facilities and locksmiths that are qualified to make remote control keys. Each key must be programmed to work with your vehicle.

#### California Only:

A list of independent repair facilities and/or locksmiths known to Volvo that can cut and code replacement keys can be found:

- on the Volvo website at <http://www.volvocars.com/us/keys>
- by calling Volvo Customer Care at 1-800-458-1552

The number of registered keys for the vehicle can be found by pressing **MY CAR** and going into **Settings** → **Information** → **Number of keys**. For a description of the menu system, see My Car – introduction (p. 70).

USA-5WK49264

FCC ID:KR55WK49264 + Siemens VDO 5WK49236

FCC ID:KR55WK49236, 5WK49266

FCC ID:KR55WK49266 + Siemens VDO 5WK49233

FCC ID:KR55WK49233

This device complies with part 15 of the FCC rules and RSS-210. Operation is subject to the following conditions: (1) This device may not cause harmful interference, and (2) this device must accept any interference received, including interference that may cause undesired operation.

Canada-5WK49264

IC:267T-5WK49264 + Siemens VDO 5WK49236

IC:267T-5WK49236, 5WK49266

IC:267T-5WK49266 + Siemens VDO 5WK49233

IC:267T-5WK49233

Operation is subject to the following conditions: (1) this device may not cause interference, and (2) this device must accept any interference, including interference that may cause undesired operation of the device.

## Related information

- Remote key – functions (p. 143)



## Key memory

The memory in the remote key makes it possible to store certain personal settings.

The position of the side door mirrors, power driver's seat\* and the selected instrument panel theme<sup>1</sup> are stored in the remote keys when the vehicle **is locked**. The next time the driver's door is unlocked with the **same** remote key and the door is opened within **2 minutes**, the power driver's seat and side door mirrors will automatically move to the position that they were in when the doors were most recently locked with the same remote key. If the seat/mirrors have not been readjusted since the vehicle was locked, they will already be in the position stored in that particular remote key and will not move. For more information on this feature, see Front seats – power seat (p. 75).

This feature can be activated or deactivated in the vehicle's menu by pressing **MY CAR** and going into **Settings → Car settings → Car key memory**. For a description of the menu system, see My Car – introduction (p. 70).

<sup>1</sup> Optional digital instrument panel only

## NOTE

If the vehicle is locked with the remote key or is left unlocked for more than 30 minutes, the key memory function will be deactivated.

To reactivate the key's memory:

- Press the unlock button on the remote key.

For information regarding vehicles with the optional keyless drive, see Keyless drive\*–locking/unlocking (p. 149).

## Related information

- Locking/unlocking confirmation (p. 141)

## Locking/unlocking confirmation

Settings can be made in the menu system for audible and visual confirmation when the vehicle has been locked or unlocked. With these functions activated, the following will occur when the vehicle is locked/unlocked:

### Locking confirmation

- The turn signals flash once, an audible signal sounds and the door mirrors will fold\* in.

Confirmation will only be given when all doors and the trunk are properly closed and locked.

## NOTE

If you do not receive confirmation when locking the vehicle, check whether a door or the trunk is ajar, or if this feature has been turned off in the menu.

### Unlocking confirmation

- The turn signals will flash twice and the door mirrors will fold\* out.





## 06 Locks and alarm



### Making a setting

Different alternatives for locking/unlocking confirmation can be selected in the menus by pressing **MY CAR** on the center console control panel.

- To activate visual confirmation: go to **Settings → Car settings → Light settings** and select **Door lock confirmation light** and/or **Unlock confirmation light** by pressing **OK/MENU**.
- To activate audible confirmation: go to **Settings → Car settings → Lock settings** and select **Audible confirmation** by pressing **OK/MENU**.

For a description of the menu system, see My Car – introduction (p. 70).

### Lock indicator

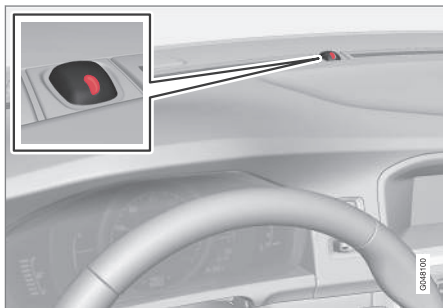

Lock/alarm indicator light

A flashing indicator light at the base of the windshield verifies that the vehicle is locked.

### Related information

- Locking/unlocking – from the outside (p. 153)
- Locking/unlocking – from inside (p. 154)
- Locking/unlocking – trunk (p. 156)

### Immobilizer (start inhibitor)

*The immobilizer is a start inhibitor that helps prevent unauthorized persons from starting the engine.*

*Each of the keys supplied with your vehicle contains a coded transponder. The code in the key is transmitted to an antenna in the ignition slot where it is compared to the code stored in the start inhibitor module. The vehicle will start only with a properly coded key. If you misplace a key, take the other keys to a trained and qualified Volvo service technician for reprogramming as an anti-theft measure. The following messages (which may appear in the instrument panel display) are related to the immobilizer:*



Message	Meaning
Insert car key	Remote key not recognized during start. Try to start the vehicle again.
Car key not found	Vehicles with keyless drive* only. Remote key not recognized during start. Try to start the vehicle again.  If the problem continues, insert the remote key into the ignition slot and try to start the vehicle again.
Immobilizer Try start again	Remote key fault during start. Contact an authorized Volvo workshop.

**! CAUTION**

Never use force when inserting the remote key in the ignition slot. The vehicle cannot be started if the transponder is damaged.

USA-FCC ID: LTQWFS 125VO

This device complies with part 15 of the FCC rules. Operation is subject to the following condition: (1) This device may not cause harmful interference, and (2) this device must accept any interference received, including

interference that may cause undesired operation.

Canada-IC: 3659A-WFS125VO

Operation is subject to the following conditions: (1) this device may not cause interference, and (2) this device must accept any interference, including interference that may cause undesired operation of the device.

For information on starting the vehicle, see Starting the engine (p. 233).

**Remote key – functions**

The remote key is used e.g., to unlock the doors and start the engine.



Remote key

- Lock
- Unlock
- Approach lighting
- Trunk unlock/open
- Panic alarm

**Buttons on the remote**

**Lock** – Press the Lock button on the remote once to lock all doors and the trunk. The turn signals will flash once to confirm locking.

**Unlock** – Press the Unlock button on the remote once to unlock the driver's door.



# 06 Locks and alarm



After a short pause, press the Unlock button a second time within 10 seconds to unlock the other doors and the trunk.

This function can be changed so that all doors unlock at the same time by pressing **My Car** and going to **Settings → Car settings → Lock settings → Change doors unlock setting**. For a description of the menu system, see My Car – introduction (p. 70).



**Approach lighting** – As you approach the vehicle, press the button on the remote key to light the interior lighting, parking lights, license plate lighting and the lights in the door mirrors\*.

These lights will switch off automatically after 30, 60 or 90 seconds. For a description of the menu system, see My Car – introduction (p. 70).



## Unlock/open trunk

**Press once:** This unlocks the trunk (but does not open it) and disarms the alarm (the alarm indicator light on the dashboard will go out). If the trunk is not opened within two minutes it will automatically relock and the alarm will be rearmed.

**Press twice:** This both unlocks the trunk and pops it open slightly.



## NOTE

Any excess weight (snow, etc.) on the trunk lid may prevent it from opening.

For information on opening the trunk from the passenger compartment, see Locking/unlocking – trunk (p. 156).

After closing, the trunk will not automatically relock. Press Lock to relock it and rearm the alarm.



**Panic alarm** – This button can be used to attract attention during emergency situations.

To activate the panic alarm, press and hold this button for at least 3 seconds or press it twice within 3 seconds. The turn signals and horn will be activated. The panic alarm will stop automatically after 2 minutes and 45 seconds.

To deactivate, wait approximately 5 seconds and press the button again.

The Panic alarm button will not unlock the vehicle.

## Related information

- Locking/unlocking – from inside (p. 154)
- Locking/unlocking – from the outside (p. 153)
- Locking/unlocking confirmation (p. 141)

## Remote key – range

*The remote key has a range of approximately 60 ft. (20 m) from the vehicle.*



## NOTE

Buildings or other obstacles may interfere with the function of the remote key. The vehicle can also be locked or unlocked with the key blade, see Alarm-related functions (p. 160).

If the remote key is removed from the vehicle while the engine is running or if the ignition is in mode **I** or **II** and all of the doors are closed, a message will appear in the instrument panel display and there will be an audible signal.

When the remote key is returned to the vehicle, the message will be erased and the audible signal will stop after one of the following has been done:

- The remote key is inserted in the ignition slot
- The vehicle's speed exceeds 20 mph (30 km/h)
- The **OK** button on the left steering wheel lever is pressed

## Related information

- Remote key – functions (p. 143)



### Detachable key blade – general information

Each remote key contains a detachable metal key blade (p. 140) for mechanically locking or unlocking the driver's door and the glove compartment, and to enable the valet locking (p. 146) function. The key blades have a unique code, which is used if new ones need to be produced. This code is available at an authorized Volvo retailer.

The visible ends of these key blades are unique to make it easier to identify "your" remote key.

### Related information

- Detachable key blade – unlocking (p. 146)
- Detachable key blade – detaching/reinserting (p. 145)

### Detachable key blade – detaching/reinserting

The detachable key blade (p. 145) can be removed or reinserted in the remote key as follows:

#### Removing the key blade



- 1 Slide the spring loaded catch to the side.
- 2 Pull the key blade straight out of the remote key.

#### Reinserting the blade

1. Hold the remote key with the slot for the key blade up.
2. Carefully slide the key blade into its groove.
3. Gently press the key blade in the groove until it clicks into place.

### Related information

- Detachable key blade – unlocking (p. 146)
- Child safety locks (p. 57)



## Detachable key blade – unlocking

Your vehicle's remote key (p. 140) contains a metal, detachable key blade that can be used to unlock the driver's door, lock the glove compartment, etc.

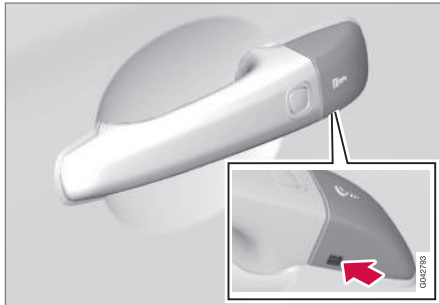

Driver's door keyhole cover

If the remote key does not function normally (weak battery, etc.), the vehicle can be unlocked with the detachable key blade.

1. Remove the detachable key blade (p. 145) from the remote key.
2. Press the key blade approx. 0.5 in. (1 cm) straight up in the hole on the underside of the keyhole cover.
  - > The cover will come off due to the pressure exerted when the key blade is pushed upward.

3. Insert the key blade as far as possible in the driver's door lock. Turn the key blade to unlock the driver's door. **This will trigger the alarm.**
4. **To turn off the alarm**, insert the remote key in the ignition slot. This also applies to vehicles equipped with the optional keyless drive.
5. Press the cover back into place after the door has been unlocked.

### Related information

- Remote key and key blade (p. 140)
- Remote key – replacing the battery (p. 147)

## Valet locking

By utilizing the remote key with the key blade removed, the valet locking feature enables you to block access to the trunk and glove compartment for e.g., valet parking or when the vehicle is brought to the retailer for service.

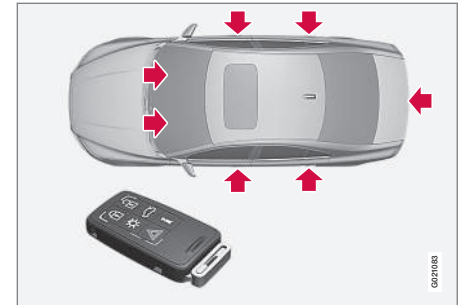

Normal locking/unlocking function

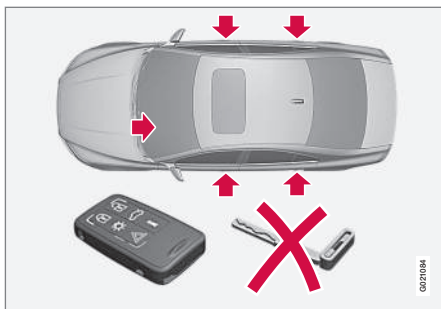

Locking/unlocking points with valet locking activated

#### With the valet locking function activated:

- The vehicle's doors can be locked or unlocked with the remote
- The engine can be started
- The glove compartment cannot be unlocked
- Access to the trunk is blocked (the trunk lid cannot be unlocked or opened with the remote, and the rear seat backrests cannot be lowered)

#### Activating the valet locking function

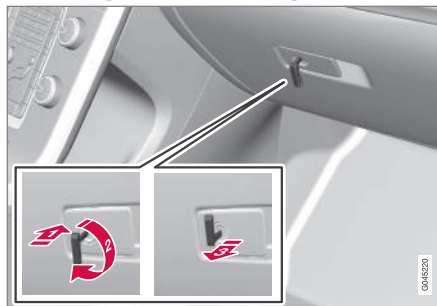

- Insert the key blade in the glove compartment lock.
- Turn the key blade 180 degrees clockwise.
- Remove the key blade from the lock. A message will appear in the instrument panel display.

#### Deactivating the valet locking function

Turn the key blade 180 degrees counter-clockwise in the glove compartment lock to deactivate valet locking.

See locking/unlocking the glove compartment (p. 155) for information on locking the glove compartment normally, without activating the valet locking function.

#### Remote key – replacing the battery

The remote key can be opened if the battery needs to be replaced.

The battery should be replaced if:

- The information symbol illuminates and **Low battery in remote control. Please change batteries.** is shown in the display and/or
- if the locks do not react after several attempts to unlock or lock the vehicle.



#### NOTE

The remote key's range is normally approximately 60 ft (20 m) from the vehicle.



## 06 Locks and alarm



### Opening the remote key

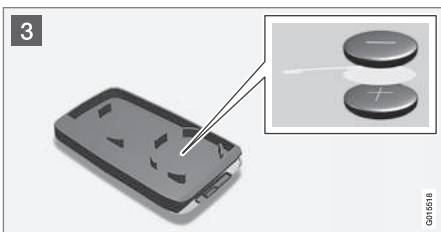
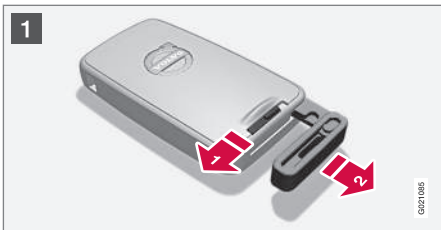

The remote key has **one** CR 2430, 3V battery only

To open the remote key

- 1 Slide the spring loaded catch to the side.
- 2 Pull the key blade straight out of the remote key.
- 2 Insert a small screwdriver in the hole behind the spring loaded catch and carefully pry up the cover. Turn the remote key with the buttons upward so that the battery does not fall out when the cover is removed.

### Inserting a new battery

#### CAUTION

When handling batteries, avoid touching their contact surfaces as this could result in poor battery function in the remote key.

Note the position of the battery's (+) or (-) sides.

1. Use a screwdriver to pry out the old battery.
2. Insert a new one with the (+) side downward.

### Closing the remote key

1. Press the remote key's cover into place.
2. Hold the remote key with the slot for the key blade up.

3. Carefully slide the key blade into its groove.
4. Gently press the key blade in the groove until it clicks into place.

#### NOTE

Volvo recommends that the batteries used in the remote control meet the UN Manual of Test and Criteria, Part III, sub-section 38.3.

Batteries installed in the key from the factory and batteries exchanged by an authorized Volvo workshop fulfill the above criteria.

Old batteries should be disposed of properly at a recycling center or at your Volvo retailer.

### Related information

- Remote key – functions (p. 143)



### Keyless drive\*– locking/unlocking

This system makes it possible to unlock and lock the vehicle without having to press any buttons on the remote key. It is only necessary to have a keyless drive remote key in your possession to operate the central locking system.

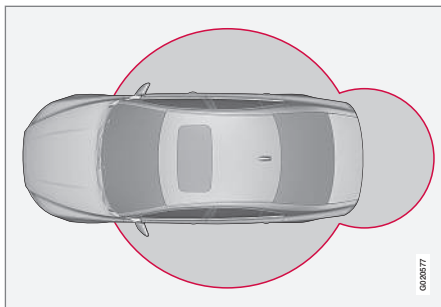

Range of the keyless drive remote key–5 ft (1.5 meters)

#### **i** NOTE

- The gear selector must be in the **P** position before the vehicle can be locked and the alarm can be armed.
- The buttons on the keyless drive remote key can also be used to lock and unlock the vehicle. For more information, see Remote key and key blade (p. 140).

Both of the remote keys provided with the vehicle have the keyless function, and additional ones can be ordered. The system can accommodate up to six remote keys.

The red rings in the illustration the area around the vehicle that is within range of the keyless drive antennas.

### Locking the vehicle



Models with keyless drive have a button on the outside door handles

The doors and the trunk can be locked by pressing the lock button in any of the outside door handles.

#### **i** NOTE

On keyless drive vehicles, the gear selector must be in the Park (**P**) position, all doors and the trunk must be closed and the ignition must be switched off before the vehicle can be locked.

### Unlocking the vehicle

- A keyless drive remote key must be on the same side of the vehicle as the door to be opened, and be within 5 feet (1.5 meters) of the door's lock or the trunk (see the shaded areas in the illustration).
- Pull a door handle to unlock and open the door or press the trunk opening control on the trunk lid.

The number of doors that are unlocked at the same time can be set in the vehicle's menu system. Press **MY CAR** and go to **Car settings** → **Lock settings** → **Keyless entry**. For a description of the menu system, see My Car – introduction (p. 70).

### Related information

- Alarm indicator (p. 158)



## 06 Locks and alarm

### Keyless drive\* – unlocking with key blade

If the remote key does not function normally (weak battery, etc.), the vehicle can be unlocked with the detachable key blade.

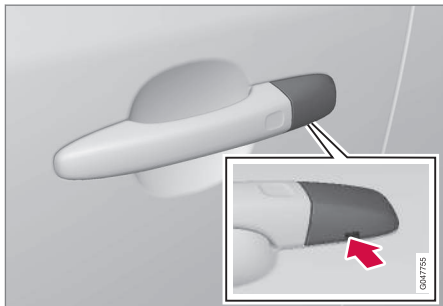

Driver's door keyhole cover

1. Remove the key blade from the remote key (see Detachable key blade – detaching/reinserting (p. 145) for instructions).
2. Press the key blade approx. 0.5 in. (1 cm) straight up in the hole on the underside of the keyhole cover.
  - > The cover will come off due to the pressure exerted when the key blade is pushed upward.
3. Insert the key blade as far as possible in the driver's door lock. Turn the key blade to unlock the driver's door. **This will trigger the alarm.**

4. **To turn off the alarm**, insert the remote key in the ignition slot. This also applies to vehicles equipped with the optional keyless drive.
5. Press the cover back into place after the door has been unlocked.

### Related information

- Keyless drive\* – locking/unlocking (p. 149)
- Alarm – general information (p. 157)

### Keyless drive\* – key memory

When you leave the vehicle with a remote key in your possession and lock any door, the



position of the driver's seat<sup>2</sup> and door mirrors will be stored in the remote key's memory.

The next time a door is opened by a person with the **same** remote key in his/her possession, the driver's seat and door mirrors will automatically move to the position that they were in when the door was most recently locked.

#### NOTE

If several people carrying remote keys approach the vehicle at the same time, the driver's seat and door mirrors will assume the positions they were in for the person who opens the driver's door.

See also power seats (p. 75) for information on adjusting and storing the seat's position in the seat memory.

<sup>2</sup> Power seats only

#### NOTE

If the vehicle is locked by pressing the button on one of the door handles or by pressing the lock button on the remote key, or if it is left unlocked for more than 30 minutes, the key memory function will be deactivated.

To reactivate the key's memory:

- Unlock the vehicle by pulling a door handle with the remote key in your possession or by pressing the unlock button on the remote key.

#### Related information

- Keyless drive\* – locking/unlocking (p. 149)
- Remote key – functions (p. 143)

#### Keyless drive\* – messages

*If all of the remote keys are removed from the vehicle while the engine is running or if the ignition modes (p. 73) is in mode II and all of the doors are closed, a message will appear in the instrument panel display and an audible signal will sound.*

When at least one remote key has been returned to the car, the message will be erased in the display and the audible signal will stop when:

- A door has been opened and closed
- The remote key has been inserted in the ignition slot
- The **OK** button has been pressed. For the location of this button, see Information display – menu controls (p. 106)



## 06 Locks and alarm

### CAUTION

- Keyless drive remote keys should never be left in the vehicle. In the event of a break-in, a remote found in the vehicle could make it possible to start the engine.
- Electromagnetic fields or metal obstructions can interfere with the keyless drive system. The remote key should never be placed closer than approximately 4-6 in. (10-15 cm) to cell phones, metallic objects or e.g., stored in a metal briefcase.

USA – FCC ID:KR55WK48952,  
KR55WK48964

### NOTE

This device complies with part 15 of the FCC Rules. Operation is subject to the following two conditions: (1) This device may not cause harmful interference, and (2) this device must accept interference received, including interference that may cause undesired operation.

### CAUTION

Changes or modifications not expressly approved by the manufacturer could void the user's authority to operate the equipment.

Siemens VDO

5WK48891

Tested To Comply With FCC Standards

For Automobile Use

Canada – IC:267T-5WK48952,  
267T-5WK48964, 267T-5WK48891

### NOTE

This device complies with RSS -210 of Industry Canada. Operation is subject to the following two conditions: (1) This device may not cause harmful interference, and (2) this device must accept interference received, including interference that may cause undesired operation.

### CAUTION

Changes or modifications not expressly approved by the manufacturer could void the user's authority to operate the equipment.

### Keyless drive\* – antenna locations

The keyless drive system has a number of antennas located at various points in the vehicle.

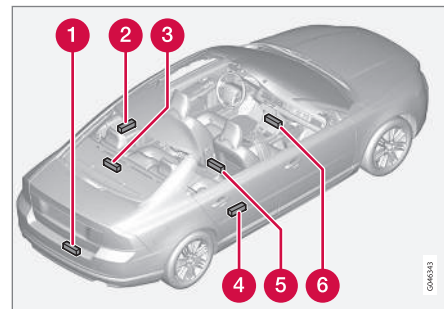

- 1 On the inside center of the rear bumper
- 2 Left rear door handle
- 3 Center of the parcel shelf, on the underside
- 4 Right rear door handle
- 5 Under the rear section of the center console
- 6 Under the front section of the center console

**WARNING**

People with implanted pacemakers should not allow the pacemaker to come closer than 9 inches (22 cm) to any of the keyless drive system's antennas. This is to help prevent interference between the pacemaker and the keyless drive system.

**Related information**

- Keyless drive\* – locking/unlocking (p. 149)

**Locking/unlocking – from the outside**

*The remote key (p. 140) is used to lock/unlock all of the doors and the trunk at the same time. Different settings for unlocking the vehicle can be selected, see Remote key – functions (p. 143).*

*Before the vehicle can be locked from the outside with the remote key, the driver's door must be closed. If the trunk or any other door is open, it will be locked and the alarm will be armed.*

**NOTE**

Be sure the remote key is outside of the vehicle before the other doors/trunk are closed to help avoid locking the remote inside the vehicle.

If the vehicle is equipped with the optional keyless drive system, all doors/trunk must be closed before the vehicle can be locked.

The first press on the unlock button unlocks the driver's door and a second press unlocks the other doors and the trunk (see also remote key and key blade (p. 140)). This setting can be changed in the menu system. See **MY CAR** (p. 70) for a description.

If the locks repeatedly do not react when the unlock button is pressed, it may be necessary to replace the battery in the remote, see Remote key – replacing the battery (p. 147).

In this case the vehicle can be unlocked with the detachable key blade (p. 146).

**Related information**

- Locking/unlocking – from inside (p. 154)



## Manual locking

In certain situations (e.g., if there is no electrical current in the vehicle), the doors can be locked manually.

The detachable key blade (p. 145) can be used in the lock cylinder in the driver's door to lock that door.

The other doors do not have lock cylinders and the slot on the rear edge of each door has to be used to lock it. This will lock the door from the outside but it can still be opened from inside the vehicle. To do so:

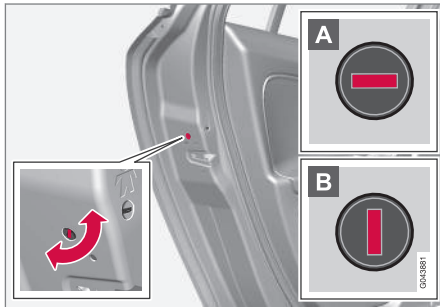

Manually locking a door

- Insert the key blade into the slot and turn it 90 degrees to lock that door (the slot in a particular door locks that door only).

- A** In the horizontal position, the door cannot be opened from the outside.
- B** In the vertical position, the door can be opened from the inside and the outside.

### **i** NOTE

If the manual child safety lock (p. 57) is activated for a rear side door and that door is also locked manually, the door cannot be opened from the outside or inside. The door can only be unlocked with the remote key or the central locking button.

### Related information

- Remote key – replacing the battery (p. 147)

## Locking/unlocking – from inside

The lock buttons on the door panel can be used to lock or unlock all doors and the trunk at the same time. Press to lock and to unlock.

### From inside the vehicle (central locking button)

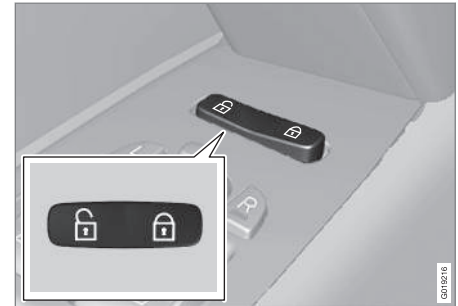

Central locking button

The lock buttons on the door panel can be used to lock or unlock all doors and the trunk at the same time. Press to lock and to unlock.

### Unlocking

The vehicle can be unlocked from inside the vehicle in two ways:

- By pressing the unlock button .
- The door can be unlocked by pulling the door handle once and opened by pulling the handle again.



## Locking

- Press the lock button  after the front doors have been closed.
- Each door can be locked individually with the lock button on the respective doors. The door must be closed first.

## Alternative locking when parking

The central locking button on the driver's door can also be used to lock the vehicle when you leave it. To do so:

1. Open the door.
2. Press the lock section of the button.
3. Close the door. This will lock the vehicle completely and arm the alarm.

### NOTE

Please be aware that locking the vehicle in this way makes it possible to lock the remote key in the passenger compartment. To help avoid this, lock the vehicle from the outside by pressing the lock button on the remote key.

If the vehicle is locked using the central locking button, be sure that the remote key is in your possession before closing the door.

## Automatic relocking

If the doors are unlocked, the locks will automatically reengage (re-lock) and the alarm will re-arm after 2 minutes unless a door or the trunk has been opened.

## Automatic locking

When the vehicle starts to move, the doors and trunk can be locked automatically. This feature can be turned on or off by pressing **MY CAR** and going to **Car settings** → **Lock settings** → **Automatic door locking**.



## Related information

- Locking/unlocking – from the outside (p. 153)
- Alarm – general information (p. 157)
- Remote key – functions (p. 143)

## Locking/unlocking – glove compartment

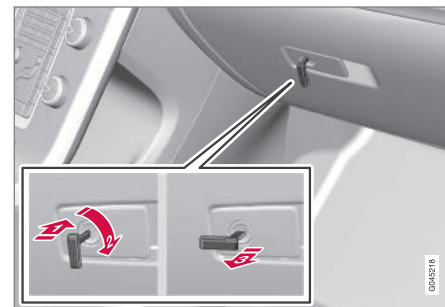
*The glove compartment can only be locked and unlocked using the detachable key blade in the remote key. For information on removing the key blade from the remote key, see Detachable key blade – detaching/reinserting (p. 145).*



-  Insert the key blade in the glove compartment lock.
-  Turn the key blade 90 degrees clockwise.
-  Remove the key blade from the lock.



## 06 Locks and alarm

### Locking/unlocking – trunk

The trunk can be locked, unlocked and opened in several ways.



Trunk unlock button on the remote key

- Press the trunk unlock button on the remote key.

**Press once:** This unlocks but does not open the trunk. The trunk can then be opened by pressing the rubber plate near the trunk lock. If the trunk is not opened within two minutes it will automatically relock and the alarm will be rearmed.

**Press twice:** This both unlocks the trunk and pops it open slightly.

#### NOTE

Any excess weight (snow, etc.) on the trunk lid may prevent it from opening.

The alarm indicator (p. 158) light on the dashboard will go out to indicate that the alarm is not monitoring the entire vehicle.

When the trunk is closed again (which has to be done manually), it will have to be relocked and the alarm rearmed by pressing the lock button on the remote key.

### Unlocking/opening the trunk from the passenger compartment

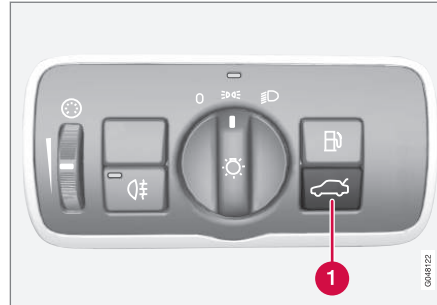

- Press the button on the lighting panel (1) to unlock and pop open the trunk

#### NOTE

The taillights will illuminate automatically for a short period when the trunk has been opened.

### Locking the trunk with the remote key

- Press the lock button on the remote key.

The alarm indicator on the dashboard will begin flashing to show that the vehicle is locked and that the alarm has been armed.

#### NOTE

- If the doors are locked while the trunk is open, the trunk will remain unlocked until the vehicle is relocked by pressing the Lock button on the remote key.
- On keyless drive vehicles, the gear selector must be in the Park (P) position, all doors and the trunk must be closed and the ignition must be switched off before the vehicle can be locked.



### Opening the trunk from the inside (U.S. models only)

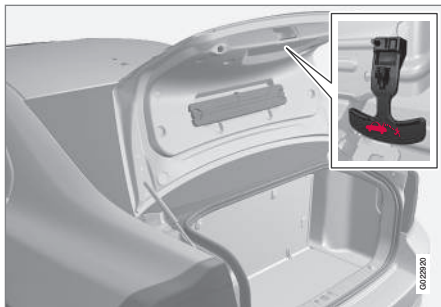

Opening the trunk from the inside

The vehicle is equipped with a fluorescent handle on the inside of the trunk lid, which can be used in an emergency situation to open the trunk from the inside. Pull the handle down to release the trunk lid. After use, the handle must be pushed back into its original position before the trunk can be closed.

This handle is not intended to be used to anchor the trunk lid when long loads are being transported.

### WARNING

- Keep vehicle doors and trunk locked and keep keys out of a child's reach. Unsupervised children could lock themselves in an open trunk and risk injury. Children should be taught not to play in vehicles.
- On hot days, the temperature in the trunk or vehicle interior can rise very quickly. Exposure of people to these high temperatures for even a short period of time can cause heat-related injury or death. Small children are particularly at risk.

### Related information

- Locking/unlocking – from inside (p. 154)
- Locking/unlocking – from the outside (p. 153)

### Alarm – general information

*The alarm system provides a warning if an attempt is made to break into the vehicle.*

*The alarm is automatically armed (p. 158) whenever the vehicle is locked with the remote key.*

*When armed, the alarm continuously monitors a number of points on the vehicle. The following conditions will trigger the alarm:*

- The hood is forced open.
- The trunk is forced open
- A door is forced open.
- The ignition slot is tampered with.
- An attempt is made to start the vehicle with a non-approved key (a key not coded to the car's ignition).
- The battery is disconnected (while the alarm is armed).
- The siren is disconnected when the alarm is disarmed.

A message will appear in the information display if a fault should occur in the alarm system. Contact a trained and qualified Volvo service technician.

### NOTE

Do not attempt to repair any of the components in the alarm system yourself. This could affect the insurance policy on the vehicle.



## Related information

- Alarm – turning off (p. 159)
- Alarm signal (p. 159)
- Alarm indicator (p. 158)

## Alarm indicator

The status of the alarm system is indicated by the red indicator light on the dashboard (see illustration):

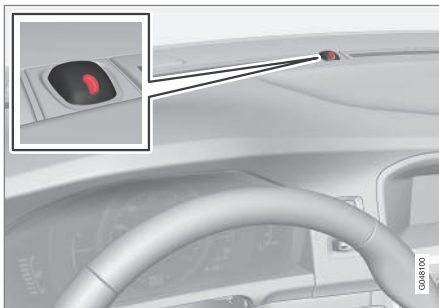

- Indicator light off: the alarm is not armed (p. 158)
- The indicator light flashes at one-second intervals: the alarm is armed
- The indicator light flashes rapidly before the remote key is inserted in the ignition slot and the ignition is put in mode I: the alarm has been triggered.

## Related information

- Alarm – general information (p. 157)
- Alarm – turning off (p. 159)
- Alarm signal (p. 159)

## Alarm – arming/disarming

The alarm system provides a warning if an attempt is made to break into the vehicle.

### Arming the alarm

- Press the Lock button on the remote key. One long flash of the turn signals will confirm that the alarm (p. 157) is armed.

Alarm confirmation settings can be changed in **MY CAR**, under **Car settings** → **Lock settings** → **Keyless entry**. For a description of the menu system, see My Car – introduction (p. 70).

### USA FCC ID: MAYDA 5823(3)

This device complies with part 15 of the FCC rules. Operation is subject to the following conditions: (1) This device may not cause harmful interference, and (2) this device must accept any interference received, including interference that may cause undesired operation.

### Canada IC: 4405A-DA 5823(3)

This device is subject to the following conditions: (1) this device may not cause interference, and (2) this device must accept any interference, including interference that may cause undesired operation of the device.



### Disarming the alarm

- Press the Unlock button on the remote key.
  - > Two short flashes from the car's direction indicators confirm that the alarm has been deactivated and that all doors are unlocked.

### Related information

- Alarm indicator (p. 158)
- Alarm signal (p. 159)
- Alarm – turning off (p. 159)
- Alarm-related functions (p. 160)

### Alarm signal

*An audible (p. 157) signal is given by a battery powered siren. The alarm cycle lasts for 30 seconds.*

The visual alarm signal is given by flashing all turn signals for approximately 5 minutes or until the alarm is turned off.

### Related information

- Alarm indicator (p. 158)
- Alarm – arming/disarming (p. 158)
- Alarm – turning off (p. 159)

### Alarm – turning off

*The alarm system provides a warning if an attempt is made to break into the vehicle.*

If the alarm is sounding, it can be stopped by pressing the Unlock button on the remote key or by inserting the remote key in the ignition slot. Two short flashes from the car's turn signals confirm that the alarm has been turned off.

### Related information

- Alarm indicator (p. 158)
- Alarm – arming/disarming (p. 158)
- Remote key – replacing the battery (p. 147)



### Alarm-related functions

The following is general information regarding the alarm system in your vehicle.

#### Automatic re-arming

If the doors are unlocked, the locks will automatically re-engage (re-lock) and the alarm will re-arm after 2 minutes unless a door or the trunk has been opened.

#### Remote key not functioning

If the remote key is not functioning properly, the alarm can be turned off and the vehicle can be started as follows:

1. Open the driver's door with the key blade.  
> **This will trigger the alarm.**



2. To turn off the alarm, insert the remote key into the ignition slot (also on vehicles with the optional keyless drive).
3. Start the engine.

### Related information

- Detachable key blade – unlocking (p. 146)
- Detachable key blade – general information (p. 145)
- Starting the engine (p. 233)

07

DRIVER SUPPORT

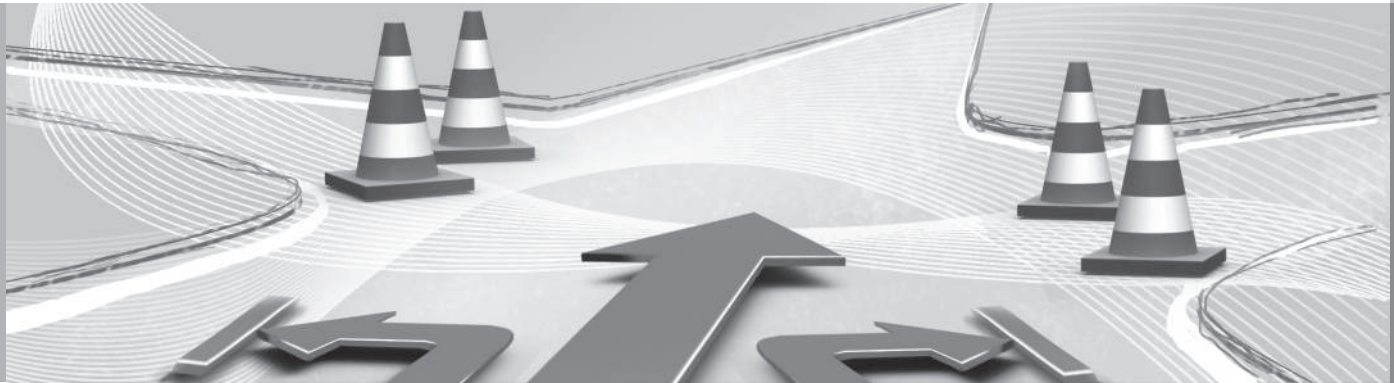



## Active chassis\* (Four C)

Active chassis, Four-C (Continuously Controlled Chassis Concept), regulates the characteristics of the shock absorbers so that the vehicle's driving characteristics can be adjusted. There are three settings: Comfort, Sport and Advanced.

### Operation



Chassis settings

Use the buttons in the center console to change setting. The setting in use when the engine is switched off is activated the next time the engine is started.

### Comfort

Comfort mode offers a somewhat softer ride and the transmission shifts gears at lower rpm. This mode is particularly suitable for long-distance highway driving. The indicator light in the button will be on when this mode is selected.

### Sport

In this mode, the vehicle's body sway is reduced during cornering and steering response is more immediate. The transmission shifts up at higher rpm for sportier driving. The indicator light in the button will be on to indicate that Sport mode has been selected.

### Advanced

In this mode, body sway in curves is minimal and steering response is very direct. Gear shifting is done at high rpm in each gear for dynamic and active driving.

### Related information

- Adjustable steering force\* (p. 166)

## Stability system – introduction

The Electronic Stability Control (ESC) system consists of a number of functions designed to help reduce wheel spin, counteract skidding and to generally help improve directional stability.



A pulsating sound will be audible when the system is actively operating and is normal. Acceleration will also be slightly slower than normal.



### WARNING

ESC is a supplementary aid and cannot deal with all situations or road conditions.

The driver is always responsible for operating the vehicle in a safe manner in accordance with current traffic regulations.

ESC consists of the following functions:

- Traction control
- Spin control
- Active Yaw Control

### Traction Control (TC)

This function is designed to help reduce wheel spin at low speeds by transferring power from a drive wheel that begins to lose traction to the wheel on the opposite side of the vehicle (on the same axle).



### Spin Control (SC)

The SC function is designed to help prevent the drive wheels from spinning while the vehicle is accelerating.

### Active Yaw Control (AYC)

This function helps maintain directional stability, for example when cornering, by braking one or more of the wheels if the vehicle shows a tendency to skid or slide laterally.

### Trailer Stability Assist (TSA)

The TSA helps stabilize a vehicle that is towing a trailer when the vehicle and trailer have begun to sway. See Trailer Stability Assist (TSA) (p. 268) for more information.

This system is automatically deactivated if the driver selects **Sport** mode.

### Related information

- Stability system – operation (p. 163)
- Stability system – symbols and messages (p. 164)
- Trailer Stability Assist (TSA) (p. 268)

## Stability system – operation

### Operation

#### Sport mode

The stability system is always activated and cannot be switched off.



However, the driver can select **Sport** mode, which offers more active driving characteristics.

**Sport** mode can be selected in the MY CAR menus, see

My Car – introduction (p. 70).

In **Sport** mode, the engine management system monitors movement of the accelerator pedal and steering wheel for sportier driving by allowing more lateral movement of the rear wheels before ESC is activated.

Under certain circumstances, such as when driving with snow chains, or driving in deep snow or loose sand, it may be advisable to temporarily use **Sport** mode for maximum tractive force.

If the driver releases pressure on the accelerator pedal, ETC will also activate to help stabilize the vehicle.

To switch to **Sport** mode:

**Sport** mode remains active until the driver switches it off in the menu or until the engine is switched off. ETC will return to normal mode when the engine is restarted.

### Related information





- Stability system – introduction (p. 162)
- Stability system – symbols and messages (p. 164)



## Stability system – symbols and messages



### Symbols and messages in the main instrument panel

A text message can be erased by pressing briefly the **OK** button on the turn signal lever.

Symbol	Message	Description
	ESC Temporarily OFF	The ESC system function has been temporarily reduced due to high brake disc temperature. The function reactivates automatically when the brakes have cooled.
	ESC Service required	The ESC system is not functioning properly. <ul style="list-style-type: none"> <li>• Stop the vehicle in a safe place, turn off the engine and restart it.</li> <li>• If the message is still displayed when the engine has restarted, drive to an authorized Volvo workshop to have the system inspected.</li> </ul>
 and 	"Message"	Read the message in the instrument panel.
	Steady glow for 2 seconds.	The system is performing a self-diagnostic test.

07



Symbol	Message	Description
	Flashing symbol.	ESC is actively functioning to help counteract wheel spin and/or a skid.
	Steady glow.	<b>Sport</b> mode has been activated. Please note that ESC is not deactivated at this time but its functionality is reduced.



### WARNING

The stability system is intended to help improve driving safety. It supplements, but can never replace, the driver's judgment and responsibility when operating the vehicle. Speed and driving style should always be adapted to traffic and road conditions.

#### Related information

- Stability system – introduction (p. 162)
- Stability system – operation (p. 163)



# 07 Driver support

## Adjustable steering force\*

Steering force increases with the speed of the vehicle to give the driver enhanced sense of control and stability. At low speed the vehicle is easy to steer in order to facilitate parking, etc.

## Adjustable steering force\*

Steering force can be changed under **MY CAR** → **Car settings** → **Steering wheel force**. Select **Low**, **Medium** or **High**. For a description of the menu system, My Car – introduction (p. 70).

### NOTE

This steering force level menu function cannot be accessed when the vehicle is in motion.

### NOTE

In certain situations, the power steering may become too warm and will have to be temporarily cooled down. While this is happening, the power steering effect will be reduced slightly and somewhat more effort may be required to turn the steering wheel.

If this occurs, a message will be displayed in the instrument panel.

## Related information

- Active chassis\* (Four C) (p. 162)

## Road Sign Information (RSI)\* – introduction

RSI is a feature that helps the driver see road signs with the posted speed limit.

### Introduction

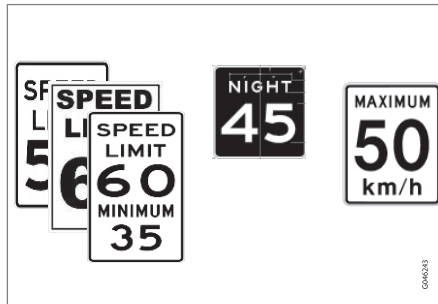

Examples of readable road signs

If the vehicle passes a sign showing the speed limit, this will be displayed in the center console.

### WARNING

RSI does not function in all situations and is only intended to provide supplementary information.

The driver is always responsible for operating the vehicle safely.

## Related information

- Road Sign Information (RSI) – operation (p. 167)
- Road Sign Information (RSI) – limitations (p. 167)



## Road Sign Information (RSI) – operation

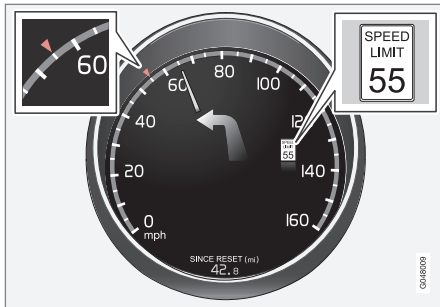

Speed limit information

When RSI registers a road sign showing the speed limit, this sign is displayed as a symbol on the instrument panel.

## Settings in MY CAR



Possible settings in MY CAR

Displaying the speed limit indication can be deactivated. To do so:

- Deselect the alternative in **MY CAR Settings** → **Car settings** → **Road Sign Information** or cancel by pressing **EXIT**.

## Speed alert

The driver can opt to be alerted if the vehicle exceeds the posted speed limit by more than 3 mph (5 km/h). The alert is given when the symbol with the posted speed limit in the instrument panel begins to flash.

To activate speed alert:

- Check the Speed alert box in **MY CAR Settings** → **Car settings** → **Speed alert** or cancel by pressing **EXIT**.

## Related information

- Road Sign Information (RSI)\* – introduction (p. 166)
- Road Sign Information (RSI) – limitations (p. 167)
- My Car – introduction (p. 70)

## Road Sign Information (RSI) – limitations

RSI's camera has the same limitations as the human eye. See The camera's limitations (p. 204) for more information about the camera's limitations.

Signs that indirectly indicate the speed limit (such as a sign with a town's name and the permitted speed limit) will not be registered by RSI.

Other factors that may interfere with RSI include:

- Faded signs
- Signs located in a curve
- Twisted or damaged signs
- Obstructed signs
- Signs that are partially covered by snow, ice, etc.

## Related information

- Road Sign Information (RSI)\* – introduction (p. 166)
- Road Sign Information (RSI) – operation (p. 167)
- The camera's limitations (p. 204)



## Cruise control (CC) – introduction

Cruise control is designed to assist the driver by maintaining a set speed. It is primarily intended for use on long straight roads in steady traffic, such as on highways and other main roads.

### Operation

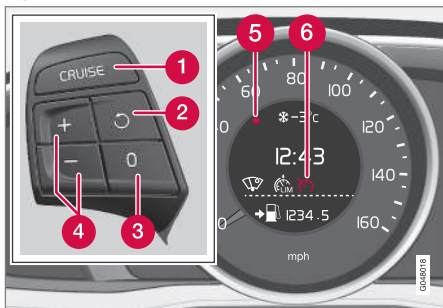

Steering wheel-mounted controls and display

- 1 Standby mode
- 2 Resume set speed
- 3 Deactivating
- 4 Activate/set speed
- 5 Selected speed (**gray** symbol indicates standby mode)
- 6 Cruise control active: **white** symbol (**gray** symbol indicates standby mode)

### Related information

- Cruise control (CC) – engaging and setting speed (p. 168)
- Cruise control (CC) – deactivating (p. 170)

## Cruise control (CC) – engaging and setting speed

Cruise control is designed to assist the driver by maintaining a set speed. It is primarily intended for use on long straight roads in steady traffic, such as on highways and other main roads.

### Engaging the cruise control function

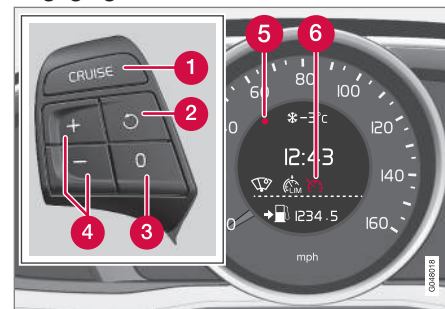

Steering wheel-mounted controls and display

- 1 Standby mode
- 2 Resume set speed
- 3 Deactivating
- 4 Activate/set speed
- 5 Selected speed (**gray** symbol indicates standby mode)
- 6 Cruise control active: **white** symbol (**gray** symbol indicates standby mode)





Before a speed can be set, the cruise control system must be engaged (put in standby mode).

- Press the **CRUISE** button (1).
  - > The symbol  illuminates and the text (---) mph (5) indicates that cruise control is in standby mode.

#### NOTE

Putting cruise control in standby mode does not set a cruising speed.



#### Setting a speed



Use the  or  buttons set the vehicle's current speed. The set speed is shown in the display.

#### NOTE

Cruise control cannot be engaged at speeds below 20 mph (30 km/h).

#### Adjusting the set speed

After a speed has been set, it can be increased or decreased by using the  or  buttons.

1. Press  or  briefly and release the button to increase or decrease vehicle speed by approximately 1 mph or 1 km/h.
  - > This will become the set speed when the button is released.
2. Press and hold one of these buttons to increase/decrease the speed in 1-mph or 1-km/h increments. Release the button when you have reached the desired speed.

#### NOTE

- A temporary increase in speed by pressing the accelerator pedal, for less than 1 minute (e.g. when passing another car), does not affect the current cruise control setting. The vehicle will automatically return to the previously set speed when the accelerator pedal is released.
- If one of the cruise control buttons is kept depressed for more than approx. 1 minute cruise control is disengaged. The engine must then be switched off in order to reset cruise control.

#### Related information

- Cruise control (CC) – introduction (p. 168)
- Cruise control (CC) – deactivating (p. 170)





## 07 Toggling between ACC and CC (standard Cruise Control)

Adaptive Cruise Control (ACC) helps the driver maintain a safe distance/time interval to the vehicle ahead.

### Switching from ACC to CC

This may be useful if, for example, the radar sensor is obstructed in some way. See Adaptive Cruise Control – limitations (p. 180) for additional information.

- Press and hold the  button; the symbol in the instrument panel will switch from  to .
- > This activates the standard cruise control function (see Cruise control (CC) – introduction (p. 168)).

### WARNING

Switching from ACC to CC means that:

- Your vehicle will **no longer** automatically maintain a set distance to a vehicle ahead.
- Only the set speed will be maintained and the driver will have to apply the brakes when needed.

### Switching from CC to ACC

Switch off cruise control by pressing  once or twice as needed according to the instructions in the previous section "Turning ACC off

completely." The next time the system is switched on, ACC will be reactivated.

### Related information

- Adaptive Cruise Control – introduction (p. 171)
- Adaptive Cruise Control – function (p. 172)

## Cruise control (CC) – deactivating

Cruise control is designed to assist the driver by maintaining a set speed. It is primarily intended for use on long straight roads in steady traffic, such as on highways and other main roads.

### Automatic deactivation

The cruise control is automatically deactivated **temporarily** if one of the following occurs:

- If the speed drops below approximately 20 mph (30 km/h).
- When the brake pedal is depressed.
- If the gear selector is moved to position N.
- During wheel spin or wheel lock-up.
- If the vehicle's speed is increased by using the accelerator pedal for more than 1 minute.

The currently set speed will be saved in the system's memory.

### Temporary deactivation

The driver can temporarily deactivate the cruise control by pressing **0**. The saved speed is shown in brackets in the information display.

### Resume set speed

If the cruise control has been deactivated temporarily, it can be reactivated by pressing



 The vehicle's speed returns to the most recently set speed.

### WARNING

There may be a significant increase in speed after the  button has been pressed.

### Deactivation

The Cruise control is disengaged by pressing  or by switching off the engine. The set speed is cleared.

### WARNING

Cruise control should not be used in heavy traffic or when driving on wet or slippery roads. Cruise control may not maintain set speed on steep downgrades.

### Related information

- Cruise control (CC) – introduction (p. 168)
- Cruise control (CC) – engaging and setting speed (p. 168)

### Adaptive Cruise Control – introduction

*ACC is an optional system designed to assist the driver by maintaining a set speed or a set time interval to the vehicle ahead. It is primarily intended for use on long straight roads in steady traffic, such as on highways and other main roads.*

When the driver has set the desired speed and the time interval to the vehicle ahead, ACC functions as follows:

- If there are no other vehicles in the lane ahead of you, your vehicle will travel at the set speed.
- If ACC's radar sensor detects a slower moving vehicle in the lane ahead, the system will adapt your vehicle's speed to help maintain the set time interval to the vehicle ahead. When there are no longer slower moving vehicles ahead, your vehicle will accelerate to resume the set speed.

If ACC is switched off completely or in standby mode and your vehicle comes too close to another vehicle ahead, the driver will be warned by the Distance Alert system (see Distance Alert – introduction (p. 185)).

### WARNING

- Adaptive Cruise Control cannot cover all driving situations and traffic, weather and road conditions. The "Function" section provides information about limitations that the driver must be aware of before using this feature.
- This system is designed to be a supplementary driving aid. It is not, however, intended to replace the driver's attention and judgement. The driver is responsible for maintaining a safe distance and speed and must intervene if Adaptive Cruise Control does not maintain a suitable speed or suitable distance to the vehicle ahead.
- Maintenance of ACC components may only be performed by a trained and qualified Volvo technician.



## Operation

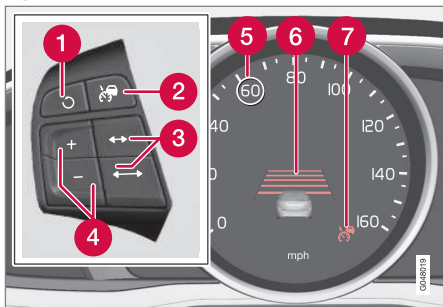

### Controls and display

- 1 Resume previous settings.
- 2 Off/On/Standby mode
- 3 Decrease/increase time interval
- 4 Put in active mode and set a speed (each additional press increases/decreases speed by 1 mph (approximately 2 km/h))
- 5 Set speed (shown in **green** when active, shown in **white** when in standby mode)
- 6 Time interval
- 7 ACC active (**green** symbol) or in standby mode (**white** symbol)

### Related information

- Toggling between ACC and CC (standard Cruise Control) (p. 170)
- Cruise control (CC) – introduction (p. 168)

- Adaptive Cruise Control – troubleshooting (p. 184)
- Adaptive Cruise Control – symbols and messages (p. 182)
- Adaptive Cruise Control – setting time interval (p. 176)
- Adaptive Cruise Control – setting speed (p. 175)
- Radar sensor (p. 180)
- Adaptive Cruise Control (ACC) – Queue Assist (p. 178)
- Adaptive Cruise Control – passing another vehicle (p. 178)
- Adaptive Cruise Control – limitations (p. 180)
- Adaptive Cruise Control – function (p. 172)
- Adaptive Cruise Control – engaging (p. 174)
- Adaptive Cruise Control – deactivating (p. 176)

## Adaptive Cruise Control – function

### Function

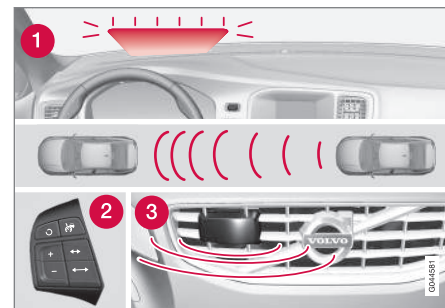

### Function overview<sup>1</sup>

- 1 Warning light, braking by driver required
- 2 Controls in steering wheel
- 3 Radar sensor in front grille

Adaptive Cruise Control consists of:

- A cruise control system to maintain a set speed
- A system to maintain a set distance to the vehicle ahead, which is expressed as a time interval. For example, you can choose to remain approximately 2 seconds behind the vehicle ahead. The actual distance required to maintain a 2-second interval will vary according to the speed of the vehicles.

**! WARNING**

- Adaptive Cruise Control is not a collision avoidance system. The driver is always responsible for applying the brakes if the system does not detect another vehicle.
- Adaptive Cruise Control does not react to people or animals, or small vehicles such as bicycles and motorcycles. It also does not react to slow moving, parked or approaching vehicles, or stationary objects.
- Do not use Adaptive Cruise Control in demanding driving conditions such as city driving or other heavy traffic situations, in slippery conditions, when there is a great deal of water or slush on the road, during heavy rain or snow, in poor visibility, on winding roads or on highway on- or off-ramps.

The distance to the vehicle ahead (in the same lane) is monitored by a radar sensor. Your vehicle's speed is regulated by accelerating and braking. The brakes may emit a sound when they are being modulated by the adaptive cruise control system. This is normal.

**! WARNING**

The brake pedal moves when the adaptive cruise control system modulates the brakes. Do not rest your foot under the brake pedal.

The ACC system is designed to smoothly regulate speed. However, the driver must apply the brakes in situations that require immediate braking. This applies when there are great differences in speed between vehicles, or if the vehicle ahead brakes suddenly.

**! WARNING**

Due to limitations in the radar sensor, braking may occur unexpectedly or not at all, see Adaptive Cruise Control – limitations (p. 180).

Adaptive Cruise Control can be put in active mode at any permitted speed. However, if the vehicle's speed falls below 18 mph (30 km/h) or if engine speed (rpm) becomes too low, ACC disengages (goes into standby mode) and will no longer modulate the brakes. The driver will then have to maintain a safe distance to the vehicle ahead.

**! WARNING**

When Adaptive Cruise Control is in standby mode or is switched off completely, the brakes will not be modulated automatically. The driver must assume full control over the vehicle.

**Warning light—driver braking required**

Adaptive Cruise Control can exert brake force that is equivalent to approximately 40% of the vehicle's total braking capacity. In situations requiring more brake force than ACC can provide and if the driver does not apply the brakes, an audible signal from the Collision Warning system will sound and warning light will illuminate (see Collision warning\* – function (p. 198)) in the windshield to alert the driver to react.

**i NOTE**

Strong sunlight, reflections, extreme light contrasts, the use of sunglasses, or if the driver is not looking straight ahead may make the visual warning signal in the windshield difficult to see.

<sup>1</sup> The illustration is generic; details will vary, depending on the model



## WARNING

Adaptive Cruise Control only warns of vehicles detected by the radar sensor, see Adaptive Cruise Control – limitations (p. 180). In some cases there may be no warning or the warning may be delayed. The driver should always apply the brakes when necessary.

### Steep inclines and/or heavy loads

ACC is primarily intended for use on fairly level roads. The system may have difficulty maintaining the correct distance to a vehicle ahead on steep inclines, if the vehicle is carrying a heavy load or is towing a trailer. In these situations, the driver should always be prepared to apply the brakes if necessary.

### Related information

- Adaptive Cruise Control – introduction (p. 171)

## Adaptive Cruise Control – engaging



### Putting ACC in standby mode

Before ACC can be used to regulate speed and/or the distance to a vehicle ahead, it must first be put in standby mode.

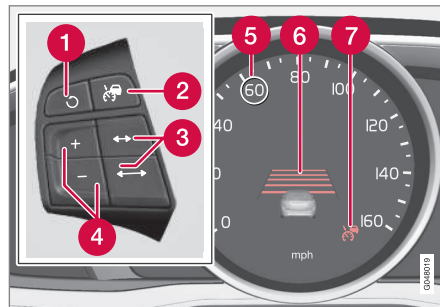
To do so:



Controls and display

-  Off/On/Standby mode
  - Press  (2).
- > The same symbol (7) appears (in **white**) in the instrument panel to indicate that ACC is in standby mode.

## NOTE

The driver's door must be closed and the driver's seat belt must be fastened before ACC can be put in active mode. If the driver's seat belt is taken off or if the driver's door is opened, ACC will return to standby mode.

### Related information

- Adaptive Cruise Control – introduction (p. 171)



## Adaptive Cruise Control – setting speed

### Setting a speed

Once ACC has been put in standby mode:

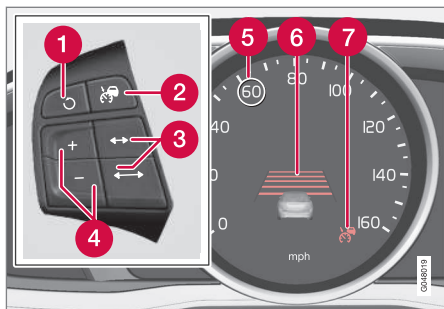

Controls and display

- 4 Put in active mode and set a speed (each additional press increases/decreases speed by 1 mph (approximately 2 km/h))
  - Press **+** or **-** (4).
- > The set speed, for example 60 mph (5), will be magnified for several seconds and the frame around the speed will change colors from **white** to **green** to indicate that this speed has been stored (set).



When this symbol has changed colors from **white** to **green**, ACC is in active mode and the vehicle will maintain the set speed.

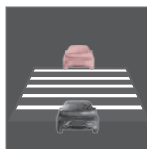

This symbol indicates that you are approaching a vehicle ahead.

ACC will switch from maintaining a **set speed** to maintaining a set **distance** from

that vehicle.

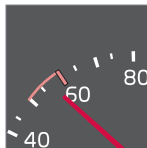

When this happens, a speed **range** will be indicated on the speedometer:

The **higher** speed (the currently set speed (5)) will be marked in **green**.

The **lower** speed in the range is the speed of the vehicle ahead.

### Changing the set speed

- After a speed has been set, it can be increased or decreased by briefly pressing the **+** or **-** buttons. Each time one of these buttons is pressed, the vehicle's speed changes by 5 mph or 5 km/h. If the speed is increased by pressing the accelerator pedal, the vehicle's speed when the button is pressed will be set.
- Press and hold one of these buttons to increase/decrease the speed in 1-mph or 1-km/h increments. Release the button when you have reached the desired speed.



### NOTE

- If one of the Adaptive Cruise Control buttons is pressed for more than approximately one minute, ACC will be deactivated. The engine must then be switched off and restarted to reset ACC.
- In some situations Adaptive Cruise Control cannot be put in active mode. **Cruise control Unavailable** is shown in the display, see Adaptive Cruise Control – symbols and messages (p. 182).

### Related information

- Adaptive Cruise Control – introduction (p. 171)



## Adaptive Cruise Control – setting time interval

### Setting a time interval

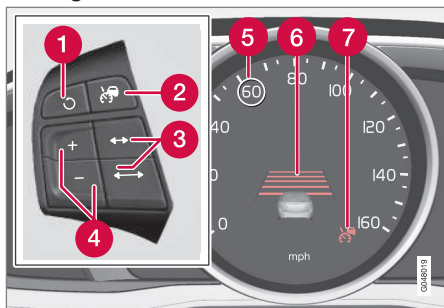

Controls and display

#### 3 Decrease/increase time interval

The set time interval to vehicles ahead can be increased by pressing and decreased by pressing . The current time interval is shown briefly in the display following adjustment.



Different time intervals can be selected and are shown in the instrument panel<sup>2</sup> as 1–5 horizontal bars. The greater the number of bars, the longer the time interval. One bar represents a time interval

of approximately 1 second; 5 bars is approximately 3 seconds.

To set/change a time interval:

- Press the / buttons (3).

At low speeds, when the distance to the vehicle ahead is short, ACC increases the time interval slightly. In order to follow the vehicle ahead as smoothly as possible, ACC allows the time interval to vary considerably in certain situations.



### WARNING

- Only use a time interval that is suitable in current traffic conditions.
- A short time interval gives the driver limited reaction time if an unexpected situation occurs in traffic.

### Related information

- Adaptive Cruise Control – introduction (p. 171)

## Adaptive Cruise Control – deactivating

### Standby mode (temporary deactivation)

To temporarily deactivate ACC (put it in standby mode):

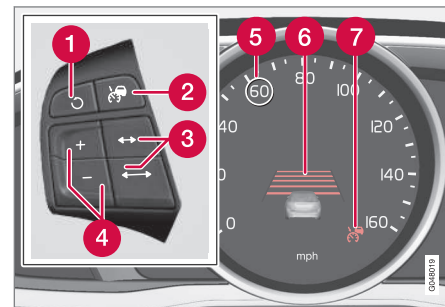

Controls and display

#### 1 Resume previous settings.

#### 2 Off/On/Standby mode

- Press (2).

This symbol and the marking for the set speed with change colors from **green** to **white**.

The previously set speed and time interval are resumed by pressing (1).

<sup>2</sup> The same symbol appears if Distance Alert (see Distance Alert – introduction (p. 185)) is activated

**WARNING**

The vehicle may accelerate quickly after  has been pressed if its current speed is considerably lower than the set speed.

**Standby mode due to action by the driver**

ACC is temporarily deactivated and put in standby mode:

- if the brakes are applied
- if the gear selector is moved to **N**
- if the driver drives faster than the set speed for more than 1 minute.

In this happens, the driver will have to regulate the vehicle's speed.

**NOTE**

If the accelerator pedal is only depressed for a short time, such as when passing another vehicle, ACC is deactivated temporarily and is reactivated when the pedal is released.

**Automatic standby mode**

ACC is linked to other systems such as the stability system. If this system is not functioning properly, ACC will switch off automatically.

In the event of automatic deactivation, an audible signal will sound and the message

**Cruise control Cancelled** is shown in the instrument panel. The driver must then intervene and adapt the vehicle's speed to the surrounding traffic and regulate the distance to the vehicle ahead.

An automatic switch to standby mode may be caused if:

- engine speed (rpm) is too high/low
- The driver's door is opened
- The driver unbuckles his/her seat belt
- the vehicle's speed goes below 18 mph (30 km/h)
- the wheels lose traction
- brake temperature is high
- the radar sensor is obstructed by, for example, wet snow or rain.

**Resuming the set speed**

If ACC is in standby mode, it can be reactivated by pressing the  button on the steering wheel keypad. The vehicle will return to the most recently set speed.

**WARNING**

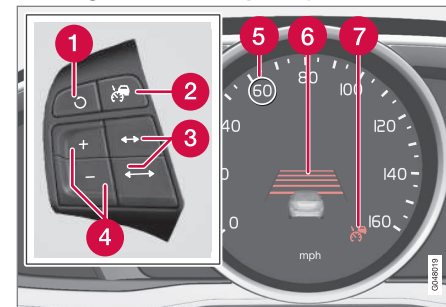

The vehicle may accelerate quickly after  has been pressed if its current speed is considerably lower than the set speed.

**Turning ACC off completely**

*Controls and display*

**1** Resume previous settings.

**2** Off/On/Standby mode

- From standby mode, press (2)  once.
- From active mode, press (2)  twice.

The set speed and time interval are then cleared from the system's memory and cannot be resumed by pressing (1) .

**Related information**

- Adaptive Cruise Control – introduction (p. 171)



## Adaptive Cruise Control – passing another vehicle

### Passing another vehicle

If your vehicle's speed is being regulated by ACC and the driver indicates that he/she would like to pass the vehicle ahead by using the **left** turn signal, ACC can assist by accelerating briefly.

This function is active at speeds above approximately 45 mph (70 km/h).

### **WARNING**

Please be aware that this function will also cause the vehicle to accelerate briefly in certain situations other than passing another vehicle, for example using the left turn signal to indicate a lane change or a turn toward a highway exit at speeds above approximately 45 mph (70 km/h).

### Related information

- Adaptive Cruise Control – introduction (p. 171)

## Adaptive Cruise Control (ACC) – Queue Assist

*Queue Assist is an added ACC feature that is linked to your vehicle's automatic transmission.*

### Introduction

Queue Assist is an added ACC feature that is linked to your vehicle's automatic transmission.

Queue Assist consists of the following functions:

- Enhanced speed interval (including when the vehicle is at a complete stop or is moving at speed below 18 mph (30 km/h))
- Automatic standby mode when ACC changes target vehicles
- No automatic braking when at a standstill
- The parking brake is applied automatically

Please note that the lowest speed that can be set is 18 mph (30 km/h), although ACC can maintain a set speed/distance to a vehicle ahead down to a standstill. Queue Assist consists of the following features:

## Enhanced speed interval

### **NOTE**

The driver's door must be closed and the driver's seat belt must be fastened before ACC can be put in active mode. If the driver's seat belt is taken off or if the driver's door is opened, ACC will return to standby mode.

Your vehicle can maintain the set time interval to the vehicle ahead at any permissible speed, including a complete stop.

In order to activate ACC at speeds below 18 mph (30 km/h):

- The vehicle ahead must be within a reasonable distance (not farther away than approx. 100 ft/30 meters)
- The lowest speed that can be selected is 18 mph (30 km/h), although ACC will also help maintain the set time interval to the vehicle ahead at lower speeds, including a complete stop.

During short stops (less than approximately 3 seconds) in slow-moving traffic, your vehicle will begin moving again automatically as soon as the vehicle ahead begins to move.

If it takes more than 3 seconds for the vehicle ahead to begin moving, ACC will be automatically go into standby mode.



The driver will then have to reactivate ACC in one of the following ways:

- By pressing 
- By accelerating up to at least 3 mph (4 km/h). ACC will then resume following the vehicle ahead.

Your vehicle will then resume following the vehicle ahead at the set time interval.

#### NOTE

ACC can remain active and keep your vehicle at a standstill for up to 4 minutes. After 4 minutes have elapsed, the parking brake will be engaged and ACC will go into standby mode.

To reactivate ACC, the driver must release the parking brake (see Parking brake – general information (p. 254)).

#### Automatic standby mode when ACC changes target vehicles

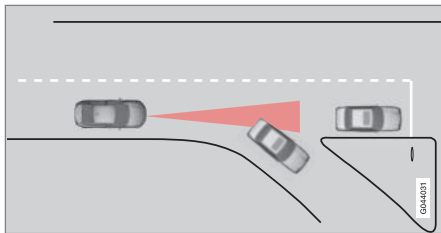

*If the vehicle ahead turns suddenly, there may be a stationary vehicle ahead*

#### The following only applies at speeds below approximately 18 mph (30 km/h):

If ACC changes target vehicles (the vehicle that the radar sensor has detected) from a moving vehicle to a stationary one, the system will apply the brakes in your vehicle.

#### WARNING

At speeds **above** 18 mph (30 km/h), ACC will not react to a stationary vehicle and apply the brakes but will instead accelerate to the previously set speed. The driver must actively apply the brakes to stop the vehicle.

ACC disengages and goes into standby mode if:

- Your vehicle's speed goes below 10 mph (15 km/h) and ACC cannot determine if the target object is a stationary vehicle or some other type of object such as e.g., a speed bump.
- Your vehicle's speed goes below 10 mph (15 km/h) and the vehicle ahead turns so that ACC no longer has a target vehicle to follow.

#### No automatic braking when at a standstill

In certain situations, ACC will no longer apply the brakes and go into standby mode while the vehicle is not moving. This means that the driver will have to apply the brakes.

This happens if:

- The driver presses the brake pedal
- The parking brake is activated
- The gear selected is moved to **P**, **N** or **R**
- The driver presses the  button to put ACC in standby mode

#### The parking brake is applied automatically

In certain situations, ACC will apply the parking brake in order to continue keeping the vehicle at a standstill.

This happens if:

- The driver opens the door or takes off his/her seat belt
- The stability system is put in Sport mode (see Stability system – operation (p. 163))
- ACC has kept the vehicle at a standstill for more than 2 minutes
- The engine has been switched off
- The brakes have overheated

#### Related information

- Adaptive Cruise Control – introduction (p. 171)



## Radar sensor

The radar sensor is designed to help detect cars or larger vehicles driving in the same direction as your vehicle, in the same lane.

### The radar sensor and its limitations

In addition to being used by the Adaptive Cruise Control (ACC), the radar sensor is also used by Distance Alert (see Distance Alert – introduction (p. 185)) and Collision Warning with Full Auto-brake and Pedestrian Detection (see Collision warning – introduction (p. 196)).

#### WARNING

- If there is visible damage to the front grille or you suspect that the radar sensor may be damaged in any way, contact a trained and qualified Volvo service technician as soon as possible. The radar sensor may only function partially (or not at all) if it is damaged or is not securely fastened in place.
- Accessories or other objects, such as extra headlights, must not be installed in front of the grille.
- Modification of the radar sensor could make its use illegal.

The radar sensor's capacity to detect vehicles ahead is impeded:

- if the radar sensor is obstructed and cannot detect other vehicles, for example in

heavy rain, or if snow or other objects are obscuring the radar sensor.

#### NOTE

Keep the area in front of the radar sensor clean.

- if the speed of vehicles ahead is significantly different from your own speed.

#### Related information

- Adaptive Cruise Control – introduction (p. 171)
- Collision warning – introduction (p. 196)
- Distance Alert – introduction (p. 185)

## Adaptive Cruise Control – limitations

The ACC cannot cover all driving situations and traffic, weather and road conditions.

### Situations where ACC may not function optimally

#### WARNING

- The radar sensor has a limited field of vision. In some situations it may detect a vehicle later than expected or not detect other vehicles at all.
- If ACC is not functioning properly, cruise control will also be disabled.

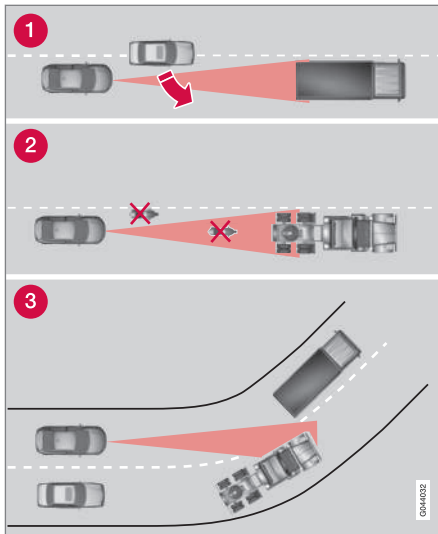

Radar sensor's field of vision (shown in pink)

- 1 In certain situations, the radar sensor cannot detect vehicles at close quarters, for example a vehicle that suddenly enters the lane between your vehicle and the target vehicle.
- 2 Small vehicles, such as motorcycles, or vehicles not driving in the center of the lane may remain undetected.
- 3 In curves, the radar sensor may detect the wrong vehicle or lose sight of the target vehicle.

### WARNING

- Adaptive Cruise Control cannot cover all driving situations and traffic, weather and road conditions. The "Function" section provides information about limitations that the driver must be aware of before using this feature.
- This system is designed to be a supplementary driving aid. It is not, however, intended to replace the driver's attention and judgement. The driver is responsible for maintaining a safe distance and speed and must intervene if Adaptive Cruise Control does not maintain a suitable speed or suitable distance to the vehicle ahead.
- Maintenance of ACC components may only be performed by a trained and qualified Volvo technician.

### WARNING

- Adaptive Cruise Control is not a collision avoidance system. The driver is always responsible for applying the brakes if the system does not detect another vehicle.
- Adaptive Cruise Control does not react to people or animals, or small vehicles such as bicycles and motorcycles. It also does not react to slow moving, parked or approaching vehicles, or stationary objects.
- Do not use Adaptive Cruise Control in demanding driving conditions such as city driving or other heavy traffic situations, in slippery conditions, when there is a great deal of water or slush on the road, during heavy rain or snow, in poor visibility, on winding roads or on highway on- or off-ramps.

### Related information

- Adaptive Cruise Control – introduction (p. 171)







## 07 Driver support

### Adaptive Cruise Control – symbols and messages

#### Symbols and messages in the display

A text message can be erased by pressing briefly on the **OK** button on the turn signal lever.

Symbol	Message	Description
	Green symbol	A speed has been set.
	White symbol	ACC is in standby mode but no speed has been set.
	-	Standard cruise control has been selected manually.
-	<b>Set ESC to Normal to enable Cruise</b>	ACC cannot be put in active mode until the stability system is switched normal operating mode, see Stability system – introduction (p. 162) for more information.
-	<b>Cruise control Cancelled</b>	ACC has been automatically switched off. The driver has to regulate the vehicle's speed/distance to the vehicle ahead.
-	<b>Cruise control Unavailable</b>	ACC cannot be put in active mode. This may be due to: <ul style="list-style-type: none"> <li>• high brake temperature</li> <li>• the radar sensor is obstructed (by heavy rain, snow, etc.)</li> </ul>
	<b>Radar blocked See manual</b>	ACC has been temporarily disconnected because the radar is obstructed in some way and cannot detect other vehicles.  In this situation, the driver can switch to standard cruise control, see Toggling between ACC and CC (standard Cruise Control) (p. 170)  See Adaptive Cruise Control – limitations (p. 180) for information on the radar sensor's limitations.



Symbol	Message	Description
-	<b>Cruise control Service required</b>	ACC is not functioning. Contact a trained and qualified Volvo service technician.
-	<b>Press Brake To hold + an audible signal</b>	The vehicle is at a standstill and ACC will release the brakes before the parking brake engages to keep the vehicle stopped but a problem with the parking brake means that the vehicle may begin to roll. The driver will have to apply the brakes. The message will remain in the display and the audible signal will continue until the driver applies the brakes or presses the accelerator pedal.
-	<b>Below 30 km/h Only following</b>	This is displayed if you try to activate ACC at speeds below approx. 18 mph (30 km/h) without a vehicle ahead within range (approx. 100 ft/30 meters).

#### Related information

- Adaptive Cruise Control – introduction (p. 171)



### Adaptive Cruise Control – troubleshooting

If the message **Radar blocked** See manual is displayed, this means that the radar signals

from the sensor have been obstructed and that a vehicle ahead cannot be detected.

This, in turn, means that the functions of the ACC, Distance Alert, and Collision Warning

System with Auto-brake and Pedestrian Detection will not function.

The table lists possible causes for this message being displayed, and suitable actions.

Cause	Action
The surface of the radar in the grille is dirty or obstructed in some way.	Clean the radar surface, or remove the object causing the obstruction.
Heavy rain or snow is interfering with the radar signals.	No action possible. Heavy precipitation may affect the function of the radar.
Swirling water or snow from the surface of the road may interfere with the radar signals.	No action possible. A very wet or snow-covered road surface may affect the function of the radar.
The surface of the radar is clean but the message remains in the display.	Wait a short time. It may take several minutes for the radar to detect that it is no longer obstructed.

#### Related information

- Adaptive Cruise Control – introduction (p. 171)



## Distance Alert – introduction

*Distance Alert is part of Adaptive Cruise Control and is a function that provides information about the time interval to the vehicle ahead.*

### Introduction

Distance Alert is active at speeds above approximately 18 mph (30 km/h). Time interval information is only given for a vehicle that is driving ahead of your vehicle in the same direction. No information is provided for vehicles driving toward you, moving very slowly, or at a standstill.

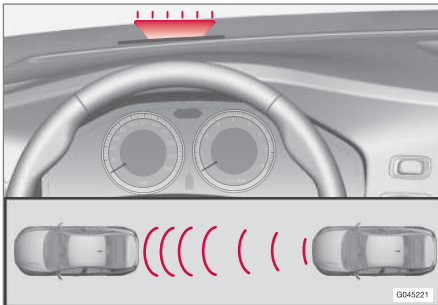

*Amber warning light<sup>3</sup>.*

An amber warning light in the windshield glows steadily if your vehicle is closer to the one ahead than the set time interval.

### NOTE

Distance Alert only monitors distance to the vehicle ahead while Adaptive Cruise Control is in standby mode or off.

### WARNING

Distance Alert only indicates the distance to the vehicle ahead. It does not affect the speed of your vehicle.

### Related information

- Distance Alert – operation (p. 185)
- Distance Alert – limitations (p. 186)
- Distance Alert – symbols and messages (p. 188)

## Distance Alert – operation

*Distance Alert is part of Adaptive Cruise Control and is a function that provides information about the time interval to the vehicle ahead.*

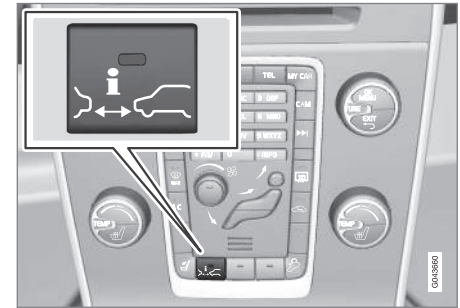

Press the button in the center instrument panel to switch this function on or off. The indicator light in the button illuminates when the function is on.

Depending on the optional equipment selected, there may not be room for a Distance Alert button in the center console. In this case, the function is controlled through the menu system. Press **MY CAR** and go to **Settings** → **Car settings** → **Distance alert** → **On/Off**.

<sup>3</sup> The illustration is generic; certain details may vary from model to model



# 07 Driver support



## Setting a time interval

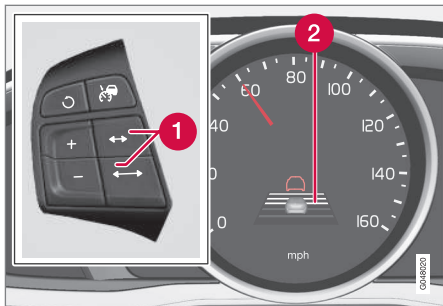

Controls and display

- 1 Time interval: Increase/decrease
- 2 Time interval On

Press to increase the interval or to decrease it.



Five different time intervals can be selected and are shown in the display as 1–5 horizontal bars. The greater the number of bars, the longer the time interval. One bar represents approximately

1 second to the vehicle ahead; 5 bars is approximately 3 seconds.

### NOTE

- The higher your vehicle's speed, the greater the distance to the vehicle ahead, measured in feet (meters), for a given time interval.
- The set time interval is also used by Adaptive Cruise Control, see Adaptive Cruise Control – setting speed (p. 175).

### WARNING

Only use a time interval that is suitable in current traffic conditions.

### Related information

- Distance Alert – introduction (p. 185)
- Distance Alert – limitations (p. 186)
- Distance Alert – symbols and messages (p. 188)

### Distance Alert – limitations

*Distance Alert is part of Adaptive Cruise Control and is a function that provides information about the time interval to the vehicle ahead.*

### Limitations

Distance Alert uses the same radar sensor used by Adaptive Cruise Control and the Collision Warning system. See Adaptive Cruise Control – limitations (p. 180) for more information on the radar sensor's limitations.

### NOTE

Strong sunlight, reflections, extreme light contrasts, the use of sunglasses, or if the driver is not looking straight ahead may make the visual warning signal in the windshield difficult to see.

### WARNING

- Bad weather or winding roads may affect the radar sensor's capacity to detect vehicles ahead.
- The size of the vehicle ahead, such as a motorcycle, may also make it difficult to detect. This may result in the warning light illuminating at a shorter distance than the one that has been set, or that the light will not come on at all.

**Related information**

- Distance Alert – introduction (p. 185)
- Distance Alert – operation (p. 185)
- Distance Alert – symbols and messages (p. 188)





### Distance Alert – symbols and messages

*Distance Alert is part of Adaptive Cruise Control and is a function that provides information about the time interval to the vehicle ahead.*

### Symbols and text messages

A text message can be erased by pressing briefly on the **OK** button on the turn signal lever.

Symbol	Message	Description
	<b>Radar blocked See manual</b>	Distance Alert has been temporarily disconnected because the radar is obstructed in some way and cannot detect other vehicles. See Adaptive Cruise Control – limitations (p. 180) for information on the radar sensor's limitations.
	<b>Collision warn. Service required</b>	Distance Alert or Collision Warning with Full Auto-brake and Pedestrian Detection is not functioning properly. Contact a trained and qualified Volvo service technician.

### Related information

- Distance Alert – introduction (p. 185)
- Distance Alert – operation (p. 185)
- Distance Alert – limitations (p. 186)



## City Safety – introduction

City Safety™<sup>4</sup> is a support system designed to help the driver avoid low speed collisions when driving in slow-moving, stop-and-go traffic.

City Safety™ is not active if your vehicle's speed is below approximately 2 mph (4 km/h). This means that City Safety™ will not react if your vehicle approaches another vehicle at very low speed, for example, when parking.

The function is active at speeds up to approximately 30 mph (50 km/h) and assists the driver by applying the brakes automatically, thereby avoiding or helping to reduce the effects of a collision.

City Safety™ is designed to intervene as late as possible to help avoid unnecessary activation.

City Safety™ triggers brief, forceful braking if a low-speed collision is imminent. However, the system will not intervene in situations where the driver actively steers the vehicle or applies the brakes, even if a collision cannot be avoided. This is done in order to always give the driver's actions highest priority.

City Safety™ activates in situations where the driver has not applied the brakes in time,

which means that the system cannot help the driver in all situations.

City Safety™ should not be used to alter the way in which the driver operates the vehicle. The driver should never rely solely on this system to safely stop the vehicle.

Normally, the occupants of the vehicle will not be aware of City Safety™ except when the system intervenes when a low-speed collision is imminent.

If the vehicle is also equipped with the optional Collision Warning with Full Auto-brake and Pedestrian Detection system, the two systems interact. For more information about the Collision Warning with Auto-brake system, see Collision warning – introduction (p. 196) .



## WARNING

- City Safety™ is a supplemental aid to the driver. It can never replace the driver's attention to traffic conditions or his/her responsibility for operating the vehicle in a safe manner.
- City Safety™ does not function in all driving situations or in all traffic, weather or road conditions.



## WARNING

- City Safety™ only reacts to vehicles traveling in the same direction as your vehicle and does not react to small vehicles or motorcycles or to people or animals.
- City Safety™ is not activated when your vehicle is backing up.
- City Safety™ functions at speeds up to 30 mph (50 km/h). This system can help prevent a collision if the **difference in speed** between your vehicle and the vehicle ahead is less than 9 mph (15 km/h). If the difference in speed is greater, a collision cannot be avoided but the speed at which the collision occurs can be reduced. The driver must apply the vehicle's brakes for full braking effect.
- City Safety™ will not intervene in a potential collision situation if the vehicle is being driven actively. The driver is always responsible for maintaining a safe distance to a vehicle or object ahead.

## Related information

- City Safety – function (p. 190)
- City Safety – operation (p. 191)
- City Safety – limitations (p. 191)

<sup>4</sup> City Safety is a registered trademark of the Volvo Car Corporation



- City Safety – troubleshooting (p. 192)
- City Safety – symbols and messages (p. 194)
- City Safety – Laser sensor (p. 195)

### City Safety – function

#### Function

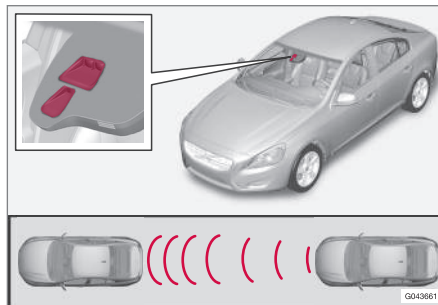

Location of the laser sensor in the windshield<sup>5</sup>

City Safety™ monitors traffic ahead of you using a laser sensor mounted in the upper section of the windshield. If a collision is imminent, City Safety™ will automatically apply the brakes, which may feel like hard braking.

If the difference in speed between your vehicle and the vehicle ahead is more than approximately 9 mph (15 km/h), City Safety™ alone cannot prevent a collision from taking place. The driver must apply the brakes to help avoid a collision or reduce its effect.

When the function activates and applies the brakes, a message will appear in the informa-

tion display to indicate that the system is/has been active.



#### NOTE

- When City Safety™ applies the brakes, the brake lights will illuminate.
- In cases where City Safety™ has stopped the vehicle, the system will then release the brakes. The driver must apply the brakes to keep the vehicle at a standstill.

#### Related information

- City Safety – introduction (p. 189)
- City Safety – operation (p. 191)
- City Safety – limitations (p. 191)
- City Safety – troubleshooting (p. 192)
- City Safety – symbols and messages (p. 194)
- City Safety – Laser sensor (p. 195)

<sup>5</sup> The illustration is generic; certain details may vary from model to model



## City Safety – operation

### Using City Safety™

#### NOTE

The City Safety™ function is activated automatically each time the engine has been switched off and restarted.

### On and Off

In certain situations, it may be desirable to switch City Safety™ off, such as when driving in close quarters where leaves, branches, etc. may obscure the hood and windshield.

When the engine is running, City Safety™ can be switched off as follows:

Press **My Car** in the center console control panel and go to **Settings → Car settings → Driver support systems → City Safety**. Select **Off**.

If the engine is switched off, City Safety™ will reactivate when the engine is restarted.

#### WARNING

The laser sensor emits light when the ignition is in mode **II** or higher, even if City Safety™ has been switched off.

To switch City Safety™ on again:

- Follow the same procedure as for switching City Safety™ off but select **On**.

### Related information

- City Safety – introduction (p. 189)
- City Safety – function (p. 190)
- City Safety – limitations (p. 191)
- City Safety – troubleshooting (p. 192)
- City Safety – symbols and messages (p. 194)
- City Safety – Laser sensor (p. 195)
- My Car – introduction (p. 70)

## City Safety – limitations

### Limitations

#### WARNING

The laser sensor has certain limitations and its function may be reduced (or it may not function at all) in conditions such as heavy rain or snowfall, or by dense fog or thick, blowing dust or snow. Condensation, dirt, ice or snow on the windshield may also interfere with the sensor's function.

The sensor used by City Safety™ is designed to detect cars and other larger motor vehicles ahead of your vehicle in both daylight and darkness.

Objects such as warning flags hanging from long objects on the roof or accessories such as auxiliary lights or protective arches on the front of the vehicle that are higher than the hood may also impede the sensor's function.

Braking distance to the vehicle ahead increases on slippery road surfaces, which may reduce City Safety's capacity to avoid a collision. In situations like this, the stability system (see Stability system – introduction (p. 162)) will help provide the best possible braking capacity and stability.

City Safety™ emits a laser beam and measures the way in which the light is reflected.



Therefore, vehicles or objects with low-reflective surfaces may not be detected. Normally, the license plate and taillight reflectors give the rear section of a vehicle ahead sufficient reflective surfaces to be detected.

## NOTE

- Keep the windshield in front of the laser sensor free of ice, snow, dirt, etc., see City Safety – function (p. 190).
- Snow or ice on the hood deeper than 2 inches (5 cm) may obstruct the sensor. Keep the hood free of ice and snow.
- Do not mount or in any way attach anything on the windshield that could obstruct the laser sensor.

## Related information

- City Safety – introduction (p. 189)
- City Safety – function (p. 190)
- City Safety – operation (p. 191)
- City Safety – troubleshooting (p. 192)
- City Safety – symbols and messages (p. 194)
- City Safety – Laser sensor (p. 195)

## City Safety – troubleshooting

### Troubleshooting

If **Windscreen Sensors blocked** appears in the information display, this indicates that the City Safety™ laser sensor is obstructed in some way and cannot detect vehicles ahead of you, which means that the system is not functioning.

However, this message will not be displayed in all situations in which the sensor is obstructed. For this reason, the driver must ensure that the area of the windshield in front of the sensor is always kept clean.

The following table shows some of the situations that can cause the message to be displayed and suggested actions.

Cause	Action
The area of the windshield in front of the sensor is dirty or covered by ice or snow.	Clean the windshield or remove the ice/snow.
The laser sensor's field of view is obstructed.	Remove the obstruction.

## NOTE

If a crack, scratch or stone chip should occur in the section of the windshield in front of the laser sensor, contact a trained and qualified Volvo service technician to repair or replace the windshield (see the illustration showing the location of the sensor in City Safety – function (p. 190)). Failing to do so may result in reduced City Safety™ functionality.

To help prevent limited or reduced functionality, please also observe the following:

- Volvo recommends that cracks, scratches or stone chips on the windshield in front of the laser sensor **should not** be repaired; in such cases, the entire windshield should be replaced.
- Before the windshield is replaced, contact a Volvo retailer to ensure that the correct windshield is ordered and installed. If the wrong type of windshield is used, this may cause City Safety™ to function improperly or not at all. Volvo recommends the use of only Genuine Volvo Replacement Windshields.
- When replacing windshield wipers, use the same type or ones approved by Volvo.

**Related information**

- City Safety – introduction (p. 189)
- City Safety – function (p. 190)
- City Safety – operation (p. 191)
- City Safety – limitations (p. 191)
- City Safety – symbols and messages (p. 194)
- City Safety – Laser sensor (p. 195)



## City Safety – symbols and messages

### Symbols and messages in the display

When City Safety™ automatically applies the brakes, one or more of the symbols in the

main instrument panel may illuminate and its associated message will be displayed.

A text message can be erased by pressing briefly on the **OK** button on the turn signal lever.

Symbol	Message	Meaning/action required
	Auto braking by City Safety	City Safety™ is applying/has applied the brakes automatically.
	Windscreen Sensors blocked	The laser sensor is temporarily not functioning due to an obstruction. <ul style="list-style-type: none"> <li>Remove the obstruction and/or clean the windshield in front of the sensor(s).</li> </ul> For more information on the sensor's limitations, see City Safety – limitations (p. 191).
	City Safety Service required	City Safety™ is not functioning. <ul style="list-style-type: none"> <li>If this message remains in the display, have the system checked by a trained and qualified Volvo service technician.</li> </ul>

### Related information

- City Safety – introduction (p. 189)
- City Safety – function (p. 190)
- City Safety – operation (p. 191)
- City Safety – limitations (p. 191)
- City Safety – troubleshooting (p. 192)
- City Safety – Laser sensor (p. 195)



## City Safety – Laser sensor

### The laser sensor

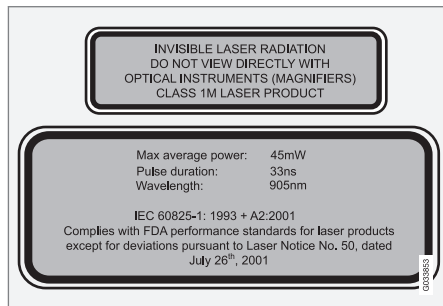

The upper decal describes the laser beam's classification and contains the following text:

Invisible Laser radiation – Do not view directly with optical instruments (magnifiers) – Class 1M laser product.

The lower decal describes the laser beam's physical data and contains the text:

IEC 60825-1:1993 + A2:2001. Complies with FDA performance standards for laser products except for deviations pursuant to Laser Notice No. 50, dated July 26th, 2001

The laser beam's physical data is listed in the following table:

Maximum pulse energy	2.64 $\mu$ J
Maximum average output	45 mW
Pulse length	33 ns
Divergence (horizontal $\times$ vertical)	28° $\times$ 12°

### NOTE

The function of aftermarket laser detectors may be affected by City Safety's laser sensor.

### WARNING

The laser sensor emits light when the ignition is in mode **II** or higher, even if City Safety™ has been switched off.

### WARNING

Eye injury may occur if any of the following points are not followed:

- It is essential that all pertinent instructions be followed when handling laser instruments. Testing, repairing, removing, adjusting and/or replacing any components in the laser sensor may only be done by a trained and qualified Volvo service technician.
- Do not remove the laser sensor (including removal of the lenses). A laser sensor that has been removed belongs to laser class 3B according to standard IEC 60825-1. Devices in laser class 3B present a risk of injury to the eyes.
- The laser sensor's connector must be disconnected before the sensor is removed from the windshield.
- The laser sensor must be mounted in place on the windshield before connecting the sensor's connector.
- Do not view the laser sensor (which emits spreading, invisible laser beams) with optical instruments from a distance of less than 4 inches (100 mm).

### Related information

- City Safety – introduction (p. 189)
- City Safety – function (p. 190)
- City Safety – operation (p. 191)



- City Safety – limitations (p. 191)
- City Safety – troubleshooting (p. 192)
- City Safety – symbols and messages (p. 194)

### Collision warning – introduction

*Pedestrian and Cyclist Detection with Full Auto Brake is designed to assist the driver if there is a risk of a collision with a pedestrian, a cyclist, a vehicle ahead that is at a standstill or one that is moving in the same direction as your vehicle.*

This system consists of the following three functions:

- **Collision Warning** warns the driver of a potential collision situation.
- **Brake Support** helps the driver brake efficiently in a critical situation.
- **Auto-brake** brakes the vehicle automatically if a collision with a pedestrian, a cyclist or another vehicle cannot be avoided and the driver does not apply the brakes in time or steer around the person/vehicle. Auto-brake can help prevent a collision or reduce the speed at which a collision occurs.

Since Pedestrian and Cyclist Detection with Full Auto Brake is activated in circumstances where the driver should have begun braking much sooner, the system will not be able to assist the driver in all situations.

This system is designed to activate as late as possible to help avoid unnecessary intervention.

The system should not be used in such a way that the driver changes his/her way of operat-

ing the vehicle. If the driver relies entirely on the system, the chances of an accident eventually occurring increase considerably.

The Pedestrian and Cyclist Detection with Full Auto Brake and City Safety™ systems supplement each other. See City Safety – introduction (p. 189) for detailed information about City Safety™.



### WARNING

No automatic system can be guaranteed to function 100% correctly in all situations. For that reason, never test the Auto-brake system by driving toward a person or object. This could result in serious injury or death.

**WARNING**

- Pedestrian and Cyclist Detection with Full Auto Brake does not work in all driving, traffic, weather and road conditions. It does not react to vehicles not traveling in the same direction as your vehicle.
- Pedestrian and Cyclist Detection with Full Auto Brake does not react to animals.
- Warnings are only provided when the risk of collision is high. The "Function" section provides information about limitations that the driver must be aware of before using Collision Warning.
- Pedestrian and Cyclist Detection with Full Auto Brake will not provide a warning or brake the vehicle for pedestrians or cyclists at speeds above 50 mph (80 km/h).

**WARNING**

- Pedestrian and Cyclist Detection with Full Auto Brake will not provide a warning or brake the vehicle for pedestrians in darkness or in tunnels, even if there is street lighting in the area.
- The auto-brake function can help prevent a collision or reduce the speed at impact but the driver should always apply the brakes for the best possible braking effect, even if auto-brake is actively applying the brakes.
- Never wait for a collision warning. This system is designed to be a supplementary driving aid. It is not, however, intended to replace the driver's attention and judgement. The driver is responsible for maintaining a safe distance and speed, even when the collision warning system is in use.
- Maintenance of the Pedestrian and Cyclist Detection with Full Auto Brake system's components must only be performed by a trained and qualified Volvo technician.

- Collision warning\* – Cyclist detection (p. 200)
- Collision warning\* – limitations (p. 202)
- The camera's limitations (p. 204)
- The camera's limitations (p. 204)
- Collision warning – troubleshooting (p. 205)
- Collision warning – symbols and messages (p. 207)

**Related information**

- Collision warning\* – function (p. 198)
- Collision warning\* – operation (p. 199)
- Collision warning\* – Pedestrian detection (p. 201)



## Collision warning\* – function

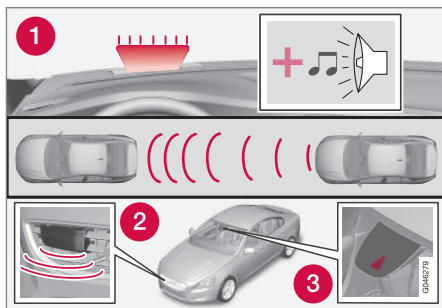

Function overview

- 1 Audio-visual warning signals, collision risk
- 2 Radar sensor
- 3 Camera

### Collision Warning

The radar sensor and the camera work together to detect a pedestrian, a cyclist, stationary vehicles and vehicles that are moving in the same direction as your vehicle. If there is a risk of collision with a vehicle, a cyclist or a pedestrian, the driver is alerted by a flashing red warning light and an audible warning signal. The system is active at speeds above 3 mph (4 km/h).

## Brake Support

If the risk of collision continues to increase after the collision warning has been given, Brake Support is activated. Brake Support prepares the brake system to react quickly, and the brakes are applied slightly. This may be experienced as a light tug.

If the brakes are applied quickly, full braking effect will be provided. Brake Support also increases brake force if the system determines that the driver has not applied adequate pressure on the brake pedal.

### Auto-brake

If a collision is imminent and the driver has not applied the brakes or begun to steer around the vehicle, pedestrian or a cyclist, the auto-brake function is activated without the driver pressing the brake pedal. Full brake force is applied to help reduce the vehicle's speed when the collision occurs or limited brake force is applied if this is sufficient to avoid the collision.

### NOTE

The auto-brake and brake support functions are always on and cannot be turned off.

### Related information

- Collision warning – introduction (p. 196)
- Collision warning\* – operation (p. 199)

- Collision warning\* – Pedestrian detection (p. 201)
- Collision warning\* – Cyclist detection (p. 200)
- Collision warning\* – limitations (p. 202)
- Collision warning – troubleshooting (p. 205)
- Collision warning – symbols and messages (p. 207)



## Collision warning\* – operation

Settings are made by pressing **MY CAR** on the center console control panel and using the menus displayed.

### Activating/deactivating both warning signals

To switch the system's **audible** and **visual** signals on or off at the same time, press **MY CAR** on the center console control panel and go to **Settings → Car settings → Driver support systems → Collision Warning**. If Pedestrian and Cyclist Detection with Full Auto Brake is on, the system will perform a self-test each time the engine is started by briefly illuminating the warning light. See My Car – introduction (p. 70) for a description of the menu system.

When the engine is switched on, the system setting that was being used when it was switched off will be the default setting.

#### NOTE

The auto-brake and pedestrian/cyclist detection features are always on, even if the audible and visual warning signals have been deactivated.

### Activating/deactivating the audible warning signal only

The audible warning signal can be activated/deactivated by pressing **MY CAR** on the cen-

ter console control panel and going to **Settings → Car settings → Driver support systems → Warning sound if risk of collision**.

### Setting a warning distance

This setting determines the distance at which the visual and audible warnings are triggered. Select **Long**, **Normal** or **Short** by pressing **MY CAR** on the center console control panel and going to **Settings → Car settings → Driver support systems → Collision Warning → Warning distance**.

The warning distance determines the level of sensitivity used by the system. The warning distance **Long** provides an earlier warning. Begin by using **Long** and if the system gives too many warnings, try changing to **Normal**.

#### WARNING

- The setting **Short** should only be used in situations where traffic is light and moving at low speeds.
- Pedestrian and Cyclist Detection with Full Auto Brake alerts the driver to the risk of a collision but this function cannot reduce the driver's reaction time.
- For the system to be as effective as possible, it is recommended that Distance Alert be set to 4 or 5, see Distance Alert – operation (p. 185).

#### NOTE

- When Adaptive Cruise Control is used, the warning light and signal will be used by that function, even if the warnings provided by Pedestrian and Cyclist Detection with Full Auto Brake have been deactivated by the driver.
- In situations where traffic is moving at considerably different speeds, or if the vehicle ahead brakes suddenly, warnings may be considered to be late, even if the setting **Long** has been selected.

### Checking settings

The current system settings can be checked by pressing **MY CAR** on the center console control panel and going to **Settings → Car settings → Driver support systems → Collision Warning**.

### Related information

- Collision warning – introduction (p. 196)
- Collision warning\* – function (p. 198)
- Collision warning\* – Pedestrian detection (p. 201)
- Collision warning\* – Cyclist detection (p. 200)
- Collision warning\* – limitations (p. 202)
- The camera's limitations (p. 204)



- Collision warning – symbols and messages (p. 207)
- Collision warning – troubleshooting (p. 205)

### Collision warning\* – Cyclist detection

The system can detect a cyclist and auto-brake if certain parameters are fulfilled.

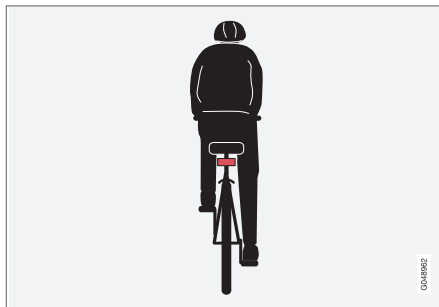

Optimal example of what the system considers to be a cyclist: clear body/bike contours, straight from behind and directly in front of the vehicle

In order to help detect a cyclist, the system has to receive clear information about the contours of the cyclist's body and the bike. It has to be able to clearly detect the bike, the cyclist's head, arms, shoulders, legs and upper and lower body combined with the person's pattern of movement when cycling.

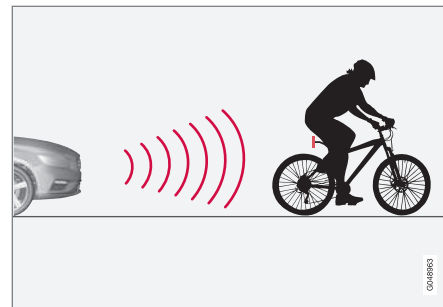

The function only detects cyclists from behind who are moving in the same direction as your vehicle

The Cyclist Detection feature requires the following in order to function:

- The cyclist must be an adult riding an "adult-size" bike
- The bike must be equipped with an approved and clearly visible rear-facing red reflector that is mounted at least 27 in. (70 cm) above the road surface
- The feature can only detect a cyclist straight from behind and who is moving in the same direction as your vehicle
- A cyclist who is to the left or right of your vehicle may be detected late or not at all.
- The camera's capacity to see a cyclist at dawn or dusk is limited, much as it is for the human eye.
- The camera's function is deactivated and will not detect a cyclist in darkness or in



tunnels, even if there is street lighting in the area.

- For optimal cyclist detection, City Safety™ must be activated.

### WARNING

Pedestrian and Cyclist Detection with Full Auto Brake is designed to be a supplementary driving aid. It is not, however, intended to replace the driver's attention and judgement. The driver is always responsible for operating the vehicle in a safe manner.

The system cannot detect a bike/cyclist if:

- He/she is wearing loose-fitting clothing that may obscure body contours
- The bike is approaching your vehicle from the side
- The bike is not equipped with a rear-facing red reflector
- The bike is carrying large objects
- Most of the cyclist's body or the bike itself cannot be "seen" by the system's camera

### Related information

- Collision warning – introduction (p. 196)
- Collision warning\* – function (p. 198)
- Collision warning\* – operation (p. 199)
- Collision warning\* – Pedestrian detection (p. 201)

- Collision warning\* – limitations (p. 202)
- Collision warning – troubleshooting (p. 205)
- Collision warning – symbols and messages (p. 207)

### Collision warning\* – Pedestrian detection

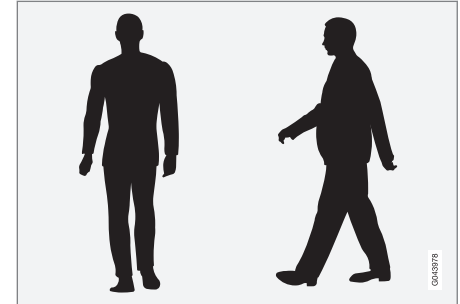

*The system cannot identify all pedestrians*

The Pedestrian and Cyclist Detection with Full Auto Brake system can only identify and detect a pedestrian who is standing upright. This person can be standing still, walking or running.

This means that the system has to be able to identify a person's head, arms, shoulders, legs, the upper and lower parts of the body and a person's pattern of movement when walking or running.

If parts of the body are not visible to the camera, the system cannot detect the pedestrian.

The following conditions apply:

- In order to detect a pedestrian, the system must have a full view of the person's



## 07 Driver support



entire body and the person must be at least 32 in. (80 cm) tall.

- The system cannot detect a pedestrian carrying a large object.
- The camera's capacity to see a pedestrian at dawn or dusk is limited, much as it is for the human eye.
- The camera's function is deactivated and will not detect a pedestrian in darkness or in tunnels, even if there is street lighting in the area.

### WARNING

- Pedestrian and Cyclist Detection with Full Auto Brake is designed to be a supplementary driving aid. It is not, however, intended to replace the driver's attention and judgement. The driver is always responsible for operating the vehicle in a safe manner.
- The system cannot detect all pedestrians in all situations, such as in darkness/at night and cannot detect partially hidden pedestrians, people who are less than approx. 32 in. (80 cm) tall, or people wearing clothing that obscures the contours of their bodies.

### Related information

- Collision warning – introduction (p. 196)
- Collision warning\* – function (p. 198)
- Collision warning\* – operation (p. 199)

- Collision warning\* – Cyclist detection (p. 200)
- Collision warning\* – limitations (p. 202)
- Collision warning – troubleshooting (p. 205)
- Collision warning – symbols and messages (p. 207)

### Collision warning\* – limitations

Strong sunlight, reflections, extreme light contrasts, the use of sunglasses, or if the driver is not looking straight ahead may make the visual warning signal in the windshield difficult to see. For this reason, always activate the audible warning signal.

Slippery driving conditions increase braking distance, which can reduce the system's capacity to avoid a collision. In these conditions, the ABS and stability systems provide the best possible braking effect while helping to maintain stability.



### NOTE

The visual warning signal may be temporarily disengaged in the event of high passenger compartment temperature due to strong sunlight, etc. If this occurs, the audible warning signal will be used, even if it has been deactivated in the menu system.

**WARNING**

- In certain situations, the system cannot provide warnings or warnings may be delayed if traffic conditions or other external factors make it impossible for the radar sensor or camera to detect a pedestrian, a cyclist or a vehicle ahead.
- Warnings may not be provided if the distance to the vehicle ahead is short, or if movements of the steering wheel/brake pedal are great, such as during active driving.
- The sensor system has a limited range for pedestrians/cyclists and provides warnings and braking effect most effectively at speeds up to 30 mph (50 km/h). For stationary or slow-moving vehicles, the system functions best if your vehicle's speed is below approximately 45 mph (70 km/h).
- Warnings for stationary or slow-moving vehicles may not be provided in dark conditions or in poor visibility.

The Pedestrian and Cyclist Detection with Full Auto Brake system uses the same radar sensors as Adaptive Cruise Control. For more information on the radar sensor and its limitations, see Adaptive Cruise Control – limitations (p. 180).

**NOTE**

If warnings are given too frequently, the warning distance can be reduced (see Collision warning\* – operation (p. 199)). This causes the system to provide later warnings, which decreases the total number of warnings provided.

**WARNING**

- The system is not activated at speeds under approx. 2 mph (4 km/h). Therefore, it will not brake your vehicle if you approach a vehicle ahead at very low speed, such as when parking.
- The driver's actions always have highest priority and override the Pedestrian and Cyclist Detection with Full Auto Brake system. This means that the system will not intervene in situations where the driver is actively steering, braking or pressing the accelerator pedal, even if a collision is imminent.
- When Auto-brake has prevented a collision with a stationary object, your vehicle will remain at a standstill for approx. 1.5 seconds. If your vehicle has been braked for a moving vehicle ahead, your vehicle's speed will be reduced to the same speed as that vehicle's.

**Related information**

- Collision warning – introduction (p. 196)
- Collision warning\* – operation (p. 199)
- Collision warning\* – function (p. 198)
- Collision warning\* – Pedestrian detection (p. 201)
- Collision warning\* – Cyclist detection (p. 200)
- The camera's limitations (p. 204)
- Collision warning – symbols and messages (p. 207)
- Collision warning – troubleshooting (p. 205)



### The camera's limitations

*The camera has the same limitations as the human eye.*

The camera is used by Pedestrian and Cyclist Detection with Full Auto Brake Collision warning – introduction (p. 196), Active High Beams (Active high beams (AHB)\* (p. 84)), Road Sign Information (Road Sign Information (RSI)\* – introduction (p. 166)) and Driver Alert System (Driver Alert System (p. 209)) with Lane Departure Warning.

#### NOTE

- To help protect the camera in very hot conditions, it may be temporarily switched off for approximately 15 minutes after the engine has been started.
- Keep the section of the windshield in front of the camera clean and free of ice, snow, or condensation.

#### WARNING

- The camera has the same limitations as the human eye. In other words, its “vision is impaired” by adverse weather conditions such as heavy snowfall, dense fog, etc. These conditions may reduce the function of systems that depend on the camera or cause these systems to temporarily stop functioning.
- Never place any objects, decals, etc., on the windshield in front of the camera. This could reduce or block the camera's function, and could cause one or more of the systems that utilize the camera to stop functioning.
- Strong sunlight, reflections from the road surface, ice or snow covering the road, a dirty road surface, or unclear lane marker lines may drastically reduce the camera's capacity to detect the side of a lane, a pedestrian, a cyclist or another vehicle.

- Collision warning\* – limitations (p. 202)
- Collision warning – troubleshooting (p. 205)
- Collision warning – symbols and messages (p. 207)
- Road Sign Information (RSI)\* – introduction (p. 166)
- Driver Alert System (p. 209)
- Active high beams (AHB)\* (p. 84)

#### Related information

- Collision warning – introduction (p. 196)
- Collision warning\* – function (p. 198)
- Collision warning\* – operation (p. 199)
- Collision warning\* – Pedestrian detection (p. 201)
- Collision warning\* – Cyclist detection (p. 200)



## Collision warning – troubleshooting

### Fault tracing and actions

If the message **Windscreen Sensors blocked** is displayed, this means that the camera is obscured and cannot detect

pedestrians, cyclists, vehicles or road marker lines in front of the vehicle.

This, in turn, means that Pedestrian and Cyclist Detection with Full Auto Brake, Driver Alert Control, Lane Departure Warning or

Lane Keeping Aid will not have full functionality.

The table lists possible causes for this message being displayed, and suitable actions.

Cause	Action
The surface of the windshield in front of the camera is dirty or covered with ice or snow.	Clean or clear the section of the windshield in front of the camera.
Fog, heavy rain or snow is interfering with the function of the camera.	No action possible. Heavy precipitation may affect the function of the camera.
The surface of the windshield is clean but the message remains in the display.	Wait a short time. It may take several minutes for the camera to register visibility.
The surface between the inside of the windshield and the camera is dirty.	Contact an authorized Volvo retailer or service technician to have this surface cleaned.



### Maintenance

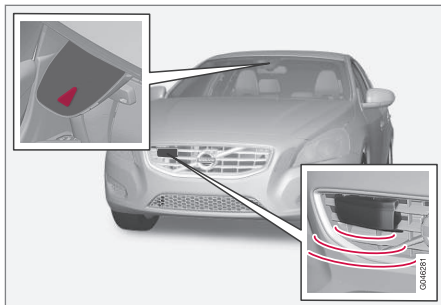

Camera and radar sensor<sup>6</sup>.

In order to function properly, the camera and radar sensor must be kept clean. Dirt, ice, snow, etc., will reduce the function of these components.

Remove ice and snow when necessary and wash these areas regularly with a suitable car washing liquid.

### Related information

- Collision warning – introduction (p. 196)
- Collision warning\* – function (p. 198)
- Collision warning\* – operation (p. 199)
- Collision warning\* – Pedestrian detection (p. 201)
- Collision warning\* – Cyclist detection (p. 200)

- Collision warning\* – limitations (p. 202)
- The camera's limitations (p. 204)
- Collision warning – symbols and messages (p. 207)







<sup>6</sup> The illustration is generic; details will vary, depending on the model



## Collision warning – symbols and messages

The table lists possible causes for collision warning-related messages being displayed, and suitable actions.

A text message can be erased by pressing briefly on the **OK** button on the turn signal lever.

Symbol	Message	Description
	<b>Collis'n warning OFF</b>	Pedestrian and Cyclist Detection with Full Auto Brake is switched off. This message is displayed when the engine is started and will disappear after approx. 5 seconds. It can also be erased by pressing the <b>OK</b> button.
	<b>Collision Warning Unavailable</b>	Pedestrian and Cyclist Detection with Full Auto Brake cannot be activated. This message is displayed when the driver attempts to activate the function. It will disappear after approx. 5 seconds or can be erased by pressing the <b>OK</b> button.
	<b>Auto braking was activated</b>	Auto-braking has been active. This message can be erased by pressing the <b>OK</b> button.
	<b>Windscreen Sensors blocked</b>	The camera is temporarily not functioning. This message is displayed if the camera is obstructed by snow, ice, dirt, etc., on the windshield. Clean the area of the windshield in front of the camera, see The camera's limitations (p. 204) for more information on the camera's limitations.
	<b>Radar blocked See manual</b>	Pedestrian and Cyclist Detection with Full Auto Brake is temporarily not functioning. The radar sensor is blocked, for example by heavy rain or snow that has accumulated in front of the sensor, and cannot detect other vehicles, see Adaptive Cruise Control – limitations (p. 180) for more information on the radar sensor's limitations.
	<b>Collision warn. Service required</b>	Pedestrian and Cyclist Detection with Full Auto Brake is partially or completely not functioning. Contact a trained and qualified Volvo service technician if the message remains in the display.



### Related information

- Collision warning – introduction (p. 196)
- Collision warning\* – function (p. 198)
- Collision warning\* – operation (p. 199)
- Collision warning\* – Pedestrian detection (p. 201)
- Collision warning\* – Cyclist detection (p. 200)
- Collision warning\* – limitations (p. 202)
- Collision warning – troubleshooting (p. 205)



## Driver Alert System

The Driver Alert System is designed to help a driver who may be becoming fatigued or who is inadvertently leaving the lane.

### Introduction

The Driver Alert System consists of two different functions that can be switched on together or separately.

- **Driver Alert Control (DAC)**, see Driver Alert Control (DAC) – introduction (p. 209)
- **Lane Departure Warning (LDW)**, see Lane Departure Warning (LDW) – introduction (p. 214)

When one or both of the functions has been switched on, it is in standby mode and is activated when the vehicle exceeds a speed of 40 mph (65 km/h).

The function deactivates if the vehicle's speed goes under 37 mph (60 km/h).

Both functions use a camera that is dependent on the road/lane being clearly marked by painted lines on each side.

### WARNING

The Driver Alert System does not function in all situations and is designed to be a supplementary aid. It is not, however, intended to replace the driver's attention and judgement.

## Driver Alert Control (DAC) – introduction

DAC is intended to alert the driver if his/her driving becomes erratic, such as if the driver is distracted or fatigued.

DAC is designed to help detect a slowly changing driving pattern. It is primarily intended to be used on main roads and is not meant for use in city traffic.

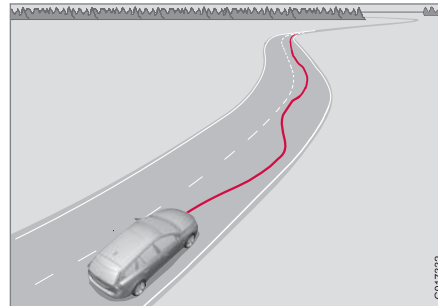

A camera monitors the painted lines marking the lane in which the vehicle is traveling and compares the direction of the road with the driver's movements of the steering wheel. The driver is alerted if the vehicle does not follow the lane smoothly.

### NOTE

The camera has certain limitations, see Adaptive Cruise Control – limitations (p. 180).

### WARNING

- DAC is not intended to extend the duration of driving. Always plan breaks at regular intervals to help remain alert.
- In certain cases, fatigue may not affect the driver's behavior. In situations of this type, no warning will be provided. Therefore, it is important to take breaks at regular intervals, regardless of whether or not DAC has given a warning.

### Related information

- Driver Alert Control (DAC) – function (p. 210)
- Driver Alert Control (DAC) – operation (p. 210)
- Driver Alert Control (DAC) – limitations (p. 211)
- Driver Alert Control (DAC) – symbols and messages (p. 212)
- Driver Alert System (p. 209)
- Lane Departure Warning (LDW) – introduction (p. 214)



## Driver Alert Control (DAC) – operation

### Operating DAC

Settings are made using menu system and the display in the center console. See My Car – introduction (p. 70) for more information on the menu system.

### On/Off

To put Driver Alert in standby mode:

- In the **MY CAR** menu, scroll to **Car settings** → **Driver support systems** → **Driver Alert** and check the box. If the box is not checked, the function is off.

### Related information

- Driver Alert Control (DAC) – introduction (p. 209)
- Driver Alert Control (DAC) – function (p. 210)
- Driver Alert Control (DAC) – limitations (p. 211)
- Driver Alert Control (DAC) – symbols and messages (p. 212)
- Driver Alert Control (DAC) – introduction (p. 209)
- Lane Departure Warning (LDW) – introduction (p. 214)

## Driver Alert Control (DAC) – function

### Function

Driver Alert is activated when the vehicle exceeds a speed of 40 mph (65 km/h) and will remain active as long as the speed is over approx. 37 mph (60 km/h).



If the vehicle is being driven erratically, the driver will be alerted by an audible signal and the message **Driver Alert Time for a break** is displayed. The warning will be repeated after a short time if the driving pattern remains the same.

Press the **OK** button to erase a message.



### WARNING

- An alert should be taken seriously since it is sometimes difficult for a driver to realize that he/she is fatigued.
- In the event of a warning or if the driver feels fatigued, stop as soon as possible in a safe place and rest.

### Related information

- Driver Alert Control (DAC) – introduction (p. 209)
- Driver Alert Control (DAC) – operation (p. 210)
- Driver Alert Control (DAC) – limitations (p. 211)

- Driver Alert Control (DAC) – symbols and messages (p. 212)
- Driver Alert System (p. 209)
- Lane Departure Warning (LDW) – introduction (p. 214)



## Driver Alert Control (DAC) – limitations

### Limitations

In certain situations, DAC may provide warnings even if the driver's driving pattern has not become erratic:

- in strong crosswinds
- on grooved road surfaces.
- if the driver is testing the LDW function, see Lane Departure Warning (LDW) – introduction (p. 214)

### Related information

- Driver Alert Control (DAC) – introduction (p. 209)
- Driver Alert Control (DAC) – function (p. 210)
- Driver Alert Control (DAC) – operation (p. 210)
- Driver Alert Control (DAC) – symbols and messages (p. 212)
- Driver Alert System (p. 209)
- Lane Departure Warning (LDW) – introduction (p. 214)





### Driver Alert Control (DAC) – symbols and messages

Depending on the situation, DAC may display certain symbols and text messages in the instrument panel or center console screen.

#### Symbols and messages

##### Instrument panel

Symbol	Message	Description
	Driver Alert Time for a break	The vehicle has been driven erratically. The driver receives an audible signal and a text message.
	Windscreen Sensors blocked	The camera is temporarily not functioning, due to snow, ice, or dirt on the windshield. Clean the area of the windshield in front of the camera. See The camera's limitations (p. 204) for information on the camera's limitations.
	Driver Alert Sys Service required	The system is not functioning. Contact a trained and qualified Volvo service technician if the message remains in the display.



### Center console display

Symbol	Message	Description
-	<b>Driver Alert OFF</b>	The function is not switched on.
-	<b>Driver Alert Available</b>	The function is active.
-	<b>Driver Alert Standby &lt;65 km/h</b>	The function has gone into standby mode because the vehicle's speed is below 40 mph (65 km/h).
-	<b>Driver Alert Unavailable</b>	The camera is temporarily not functioning, due to snow, ice, or dirt on the windshield. Clean the area of the windshield in front of the camera. See The camera's limitations (p. 204) for information on the camera's limitations.

### Related information

- Driver Alert Control (DAC) – introduction (p. 209)
- Driver Alert Control (DAC) – function (p. 210)
- Driver Alert Control (DAC) – operation (p. 210)
- Driver Alert Control (DAC) – limitations (p. 211)
- Driver Alert System (p. 209)
- Lane Departure Warning (LDW) – introduction (p. 214)



### Lane Departure Warning (LDW) – introduction

The LDW function is designed to help reduce the risk of accidents in situations where the vehicle unintentionally leaves its lane and there is a risk of driving off the road or into the opposite lane.

### Lane Departure Warning (LDW)

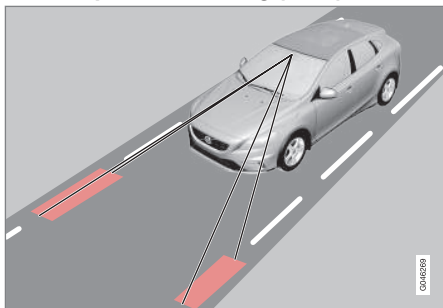

*The illustration is generic*

LDW uses the camera located at the center, upper edge of the windshield to monitor the road's/lane's side marker lines. If the vehicle crosses a side marker line or the road's center dividing line, the driver will be alerted by an audible signal.



### WARNING

This feature is only intended to assist the driver and does not function in all driving, weather, traffic or road conditions.

As the driver, you have full responsibility for operating the vehicle in a safe manner.

### Related information

- Driver Alert System (p. 209)
- Lane Departure Warning (LDW) – symbols and messages (p. 217)
- Lane Departure Warning (LDW) – operation (p. 214)
- Lane Departure Warning (LDW) - limitations (p. 216)

### Lane Departure Warning (LDW) – operation

#### Operation and function



LDW can be switched on or off by pressing the button on the center console. A light in the button illuminates when the function is on. This is supplemented by graphic displays in the instrument panel, for example:



LDW displayed in the instrument panel

- The LDW symbol has **white** side marker lines: – the function is active and "sees" one or both of the road's side marker lines.
- The LDW symbol has **gray** side marker lines: – the function is active but cannot "see" one or both of the road's side marker lines.

or

- The LDW symbol has **gray** side marker lines: – the function is in standby mode because the vehicle's speed is below 40 mph (65 km/h).
- The LDW symbol has **no** side marker lines: – the function is deactivated.

### **WARNING**

The driver will only be warned once for each time the wheels cross a marker line. No alarm will be given if a marker line is between the wheels.

### Settings

Settings for Lane Departure Warning can be made in the menu system by pressing **My**

**Car**. Go to **Settings** → **Car settings** →

**Driver support systems** → **Lane Departure Warning**.

There are two alternatives:

- **On at start-up:** This selection switches LDW on each time the engine is started. Otherwise, the system will be in the mode that it was in when the engine was switched off.
- **Increased sensitivity:** This selection increases the function's sensitivity. Warnings will be given at an earlier stage and fewer limitations apply. When this setting is being used, the system only needs to monitor lane marker lines on one side of the vehicle to change status to **Lane Depart Warn Available**.

### Related information

- Driver Alert System (p. 209)
- Lane Departure Warning (LDW) – symbols and messages (p. 217)

- Lane Departure Warning (LDW) – introduction (p. 214)
- Lane Departure Warning (LDW) - limitations (p. 216)



### Lane Departure Warning (LDW) - limitations

#### Limitations

The camera used by LDW has the same limitations as the human eye. See The camera's limitations (p. 204) for more information about the camera's limitations.

#### NOTE

**No warning signal** will be given in the certain situations, such as:

- If the turn signal is being used
- The driver's foot is on the brake pedal<sup>7</sup>
- The accelerator pedal is pressed quickly<sup>7</sup>
- If the steering wheel is moved quickly<sup>7</sup>
- In sharp turns that cause the vehicle's body to sway

#### Related information

- Driver Alert System (p. 209)
- Lane Departure Warning (LDW) – symbols and messages (p. 217)
- Lane Departure Warning (LDW) – operation (p. 214)
- Lane Departure Warning (LDW) – introduction (p. 214)



<sup>7</sup> When Increased sensitivity has been selected, a warning will be issued if a side marker line is crossed in this situation.



## Lane Departure Warning (LDW) – symbols and messages

### Symbols and messages

A text message can be erased by pressing briefly on the **OK** button on the turn signal lever.

Symbol	Message	Description
	Lane departure warning ON/ Lane departure warning OFF	The function is switched on or off. The text disappears after 5 seconds.
-	Lane Depart Warn Available	The function is monitoring the road's marker lines.
-	Lane Depart. Warning Unavailable at this speed	The function has gone into standby mode because the vehicle's speed is below 40 mph (65 km/h).
-	Lane Depart Warn Unavailable	The road lacks clear marker lines or the camera is not functioning properly. See The camera's limitations (p. 204) for information on the camera's limitations.
	Windscreen Sensors blocked	The camera is temporarily not functioning, due to snow, ice, or dirt on the windshield. Clean the area of the windshield in front of the camera. See The camera's limitations (p. 204) for information on the camera's limitations.
	Driver Alert Sys Service required	The system is not functioning. Contact a trained and qualified Volvo service technician if the message remains in the display.



### Related information

- Lane Departure Warning (LDW) – operation (p. 214)
- Driver Alert System (p. 209)
- Lane Departure Warning (LDW) – introduction (p. 214)
- Lane Departure Warning (LDW) - limitations (p. 216)



### Park assist – introduction

The park assist system is designed to assist you when driving into parking spaces, garages, etc. An audible signal and symbols in the audio system's display indicate the distance to the object.

The park assist system utilizes ultrasound sensors in the front bumper and rear bumper(s) to measure the distance to a vehicle or an object that may be close to the front or rear of your vehicle.

#### NOTE

A trailer hitch whose wiring is integrated with the vehicle's electrical system will be included in the measurement of the available space behind the vehicle.

#### WARNING

Park Assist is an information system, NOT a safety system. This system is designed to be a supplementary aid when parking the vehicle. It is not, however, intended to replace the driver's attention and judgement.

### Related information

- Park assist – limitations (p. 222)
- Park assist – function (p. 219)
- Park assist – operation (p. 221)
- Park assist – troubleshooting (p. 223)

- Rear Park Assist Camera (PAC) – function (p. 224)

### Park assist – function

#### Signals from the park assist system

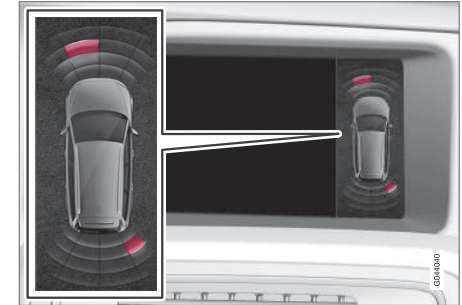

View in the display (warning for objects front left/ right rear)

#### Visual indicator

The audio system's display gives an overview of the vehicle's position in relation to a detected object.

The marked sectors in the display indicate that one or more of the sensors has detected an object. The closer the car symbol comes to a sector, the closer the vehicle is to the object.

If the infotainment system is switched off, the park assist system will not be able to provide a visual indicator. An audible signal will still be provided.



## 07 Driver support



### Audible signal

The Park Assist system uses an intermittent tone that pulses faster as you come close to an object, and becomes constant when you are within approximately 1 ft (30 cm) of an object in front of or behind the vehicle. If there are objects within this distance both behind and in front of the vehicle, the tone alternates between front and rear speakers.

#### NOTE

The level of the audible signal can be lowered/raised with the infotainment volume control. The level can also be set in the MY CAR menu system. See My Car – introduction (p. 70) for a description of the menu system.

If the volume of another source from the audio system is high, this will be automatically lowered.

### Rear park assist

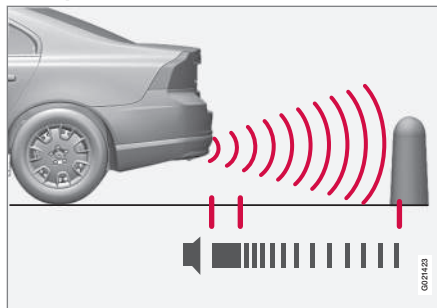

The distance monitored behind the vehicle is approximately 5 ft (1.5 m). The audible signal comes from the rear speakers.

The system must be deactivated when towing a trailer, carrying bicycles in a rear-mounted carrier, etc, which could trigger the rear park assist system's sensors.

#### NOTE

- Rear park assist is deactivated automatically when towing a trailer if Volvo genuine trailer wiring is used. If a non-Volvo trailer hitch is being used, it may be necessary to switch off the system manually, see Park assist – operation (p. 221).
- The system will not detect high objects, such as a loading dock, etc.
- Objects such as chains, thin shiny poles or low objects may temporarily not be detected by the system. This may result in the pulsing tone unexpectedly stopping instead of changing to a constant tone as the vehicle approaches the object. In such cases, use caution when backing up or stop the vehicle to help avoid damage.



### Front park assist

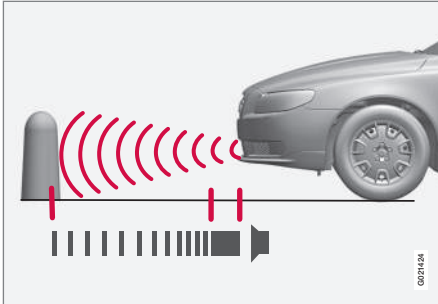

The distance monitored in front of the vehicle is approximately 2.5 ft (0.8 m). The audible signal comes from the audio system's front speakers.

It may not be possible to combine auxiliary headlights and front park assist since these lights could trigger the system's sensors.

#### **i** NOTE

Front park assist is deactivated when the parking brake is applied and or when the gear selector is in the **P** position.

### Related information

- Park assist – introduction (p. 219)
- Park assist – limitations (p. 222)
- Park assist – operation (p. 221)
- Park assist – troubleshooting (p. 223)

- Rear Park Assist Camera (PAC) – function (p. 224)

### Park assist – operation

#### Function

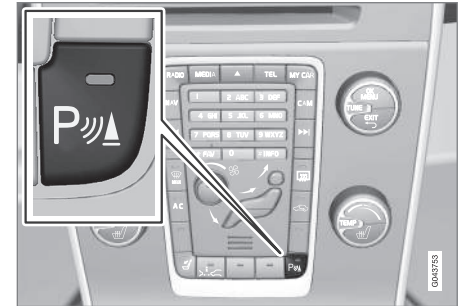

*Park assist button*

The system is activated automatically when the vehicle is started. The indicator light in the button in the center console illuminates when the system is on.

- The front park assist system is active from the time the engine is started until the vehicle exceeds a speed of approximately 6 mph (10 km/h). It is also active when the vehicle is backing up.
- Rear park assist is active when the engine is running and reverse gear has been selected.



# 07 Driver support



## Activating/deactivating

The system is activated automatically when the vehicle is started.

- Press the Park assist button on the center console to temporarily deactivate the system(s).
  - > The indicator light in the button will go out when the system has been deactivated.

Park assist will be automatically reactivated the next time the engine is started, or if the button is pressed (the indicator light in the button will illuminate).

### **i** NOTE

Park assist is disengaged automatically when the parking brake is applied.

## Related information

- Park assist – introduction (p. 219)
- Park assist – limitations (p. 222)
- Park assist – function (p. 219)
- Park assist – troubleshooting (p. 223)
- Rear Park Assist Camera (PAC) – function (p. 224)

## Park assist – limitations

### Cleaning the sensors

The sensors must be cleaned regularly to ensure that they work properly. Clean them with water and a suitable car washing detergent.

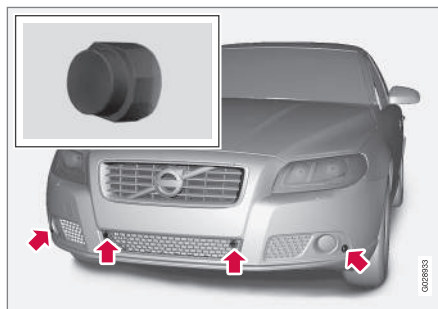

Location of the front sensors

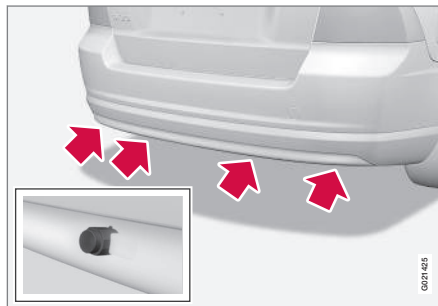

Location of the rear sensors.

Ice and snow covering the sensors may cause incorrect warning signals.

### **i** NOTE

If the sensors are obstructed by e.g., dirt, snow, or ice, this could result in false warning signals from the park assist system.

## Related information

- Park assist – introduction (p. 219)
- Park assist – function (p. 219)
- Park assist – operation (p. 221)
- Park assist – troubleshooting (p. 223)
- Rear Park Assist Camera (PAC) – function (p. 224)



## Park assist – troubleshooting

### Faults in the system

If the information symbol illuminates and **Park assist syst Service required** is shown on the information display, this indicates that the system is not functioning properly and has been disengaged. Consult a trained and qualified Volvo service technician.

#### CAUTION

In certain circumstances, the park assist system may give unexpected warning signals that can be caused by external sound sources that use the same ultrasound frequencies as the system. This may include such things as the horns of other vehicles, wet tires on asphalt, pneumatic brakes, motorcycle exhaust pipes, etc. This does not indicate a fault in the system.

### Related information

- Park assist – introduction (p. 219)
- Park assist – limitations (p. 222)
- Park assist – function (p. 219)
- Park assist – operation (p. 221)
- Rear Park Assist Camera (PAC) – function (p. 224)

## Rear Park Assist Camera (PAC) – introduction

*The Park Assist Camera is designed to provide the driver with a view of the area behind the vehicle when backing up.*

### Introduction

PAC uses the display in the center console to show the area behind the car while you are backing up.

PAC also shows guiding lines in the on-screen image to indicate the direction that the vehicle will take as it moves rearward, which helps simplify parallel parking, backing into a tight space or when attaching a trailer to the vehicle.

The images of vehicles in this section are generic and may not depict your specific model.

#### NOTE

A trailer hitch whose wiring is integrated with the vehicle's electrical system will be included in the measurement of the available space behind the vehicle.

#### WARNING

- PAC is designed to be a supplementary aid when parking the vehicle. It is not, however, intended to replace the driver's attention and judgment.
- The camera has blind spots where it cannot detect objects or people behind the vehicle.
- Pay particular attention to people or animals that are close to the vehicle.
- Objects seen on the screen may be closer than they appear to be.

### Related information

- Rear Park Assist Camera (PAC) – operation (p. 224)
- Rear Park Assist Camera (PAC) – limitations (p. 227)



## Rear Park Assist Camera (PAC) – function

### Function

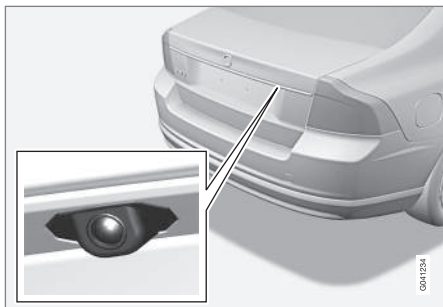

The driver sees what is behind the vehicle and if a person or animal should suddenly appear from the side.

PAC is mounted on the rear of the trunk lid, near the opening handle.

The camera has built-in electronics that help reduce the “fish-eye” effect so that the image shown on the screen is as natural as possible. This may cause some objects on the screen to “lean,” which is normal.

### Ambient lighting conditions

The camera automatically monitors the ambient lighting conditions behind the vehicle and constantly adjusts sensitivity to light. This may cause the brightness and quality of the image on the screen to vary slightly. Sensitiv-

ity to light is increased in dark conditions or in bad weather, which may affect image quality.

If the image on the screen seems too dark, brightness can be increased with the thumb wheel on the lighting panel.

### NOTE

In order to function properly, the camera lens should always be kept clean. This is particularly important in bad weather. Keep the lens free of dirt, ice or snow.

### Related information

- Rear Park Assist Camera (PAC) – introduction (p. 223)
- Rear Park Assist Camera (PAC) – operation (p. 224)
- Rear Park Assist Camera (PAC) – limitations (p. 227)

## Rear Park Assist Camera (PAC) – operation

### Activation



PAC is activated when the gear selector is moved to **R** if the system is selected in the **MY CAR** menu system or by pressing the **CAM** button in the center console. See My Car – introduction (p. 70) for a description of the menu system.

If PAC is not activated when the gear selector is moved to **R**, press the **CAM** button on the center console.

PAC will automatically override the view currently on the screen and will display the camera’s view behind the vehicle.

### Deactivation

Move the gear selector from **R** to another gear. The camera remains active for approx.



5 seconds after the gear selector has been moved from **R** or until the vehicle's forward speed exceeds 6 mph/10 km/h (21 mph/35 km/h in reverse). The screen will then revert to the view that was displayed before **R** was selected.

### NOTE

If any button on the center console control panel is pressed, the camera image will disappear from the display. Pressing **CAM** will return the camera image to the display.

### Settings

By default, PAC is set to activate when the gear selector is moved to **R**

To change PAC settings when a camera view is displayed:

1. Press **OK/MENU** when a camera view is on the screen. A menu will be displayed.
2. Turn **TUNE** to scroll to the desired setting.
3. Press **OK/MENU** to make the setting and exit the menu by pressing **EXIT**.

### Summary

- Pressing **CAM** will activate the camera even if the gear selector is not in Reverse.
- If there are two cameras installed on the vehicle\*, turn **TUNE** or press **CAM** to toggle between the cameras.

### Related information

- Park assist – introduction (p. 219)
- Park assist – function (p. 219)
- Park assist – troubleshooting (p. 223)
- Park assist – limitations (p. 222)
- Rear Park Assist Camera (PAC) – introduction (p. 223)

### Rear Park Assist Camera (PAC) – guiding and marker lines

#### Guiding lines

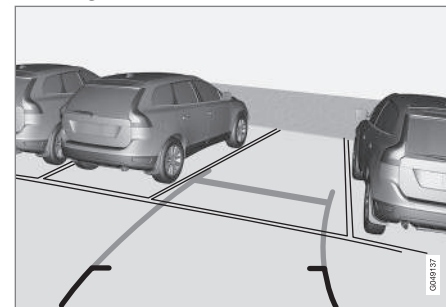

The lines on the screen are projected as if they were a path on the ground behind the vehicle and are directly affected by the way in which the steering wheel is turned. This enables the driver to see path the vehicle will take, even if he/she turns the steering wheel while backing up.

### NOTE

When backing up with a trailer, the guiding lines show the path that the **vehicle** will take, not the trailer.



# 07 Driver support



## **! WARNING**

Keep in mind that the image on the screen only shows the area behind the vehicle. The driver must always watch for people, animals, other vehicles, etc., near the sides of the vehicle when turning while backing up.

### Marker lines

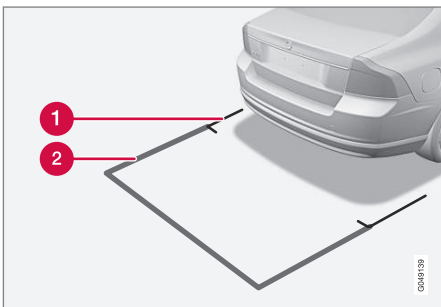

The PAC system's lines

- 1** An area approx. 1 ft (30 cm) behind the vehicle
- 2** The line marking the unobstructed area behind the vehicle

The red line (1) frames an area approx. 1 ft (30 cm) behind the vehicle from the bumper.

The yellow horizontal line (2) frames an area up to approx. 5 feet (1.5 m) behind the bumper.

These lines also indicate the outermost limits that any object (door mirrors, corners of the body, etc.) extends out from the vehicle, even when it turns.

### Vehicles equipped with Park Assist

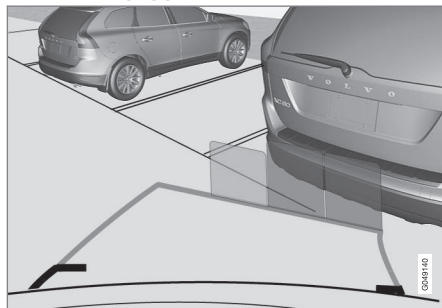

Colored markers (one for each sensor) indicate distance

If the vehicle is equipped with the optional Park Assist system (see Park assist – introduction (p. 219)), the distance to an object will be indicated more exactly and colored markers in the display indicate which of the sensor(s) has detected the object.

Color	Distance to object
Green	2.5–5 ft (0.8–1.5 m)
Yellow	1.3–2.5 ft (0.4–0.8 m)
Red	0–1.3 ft (0–0.4 m)

### Related information

- Rear Park Assist Camera (PAC) – operation (p. 224)
- Rear Park Assist Camera (PAC) – limitations (p. 227)



## Rear Park Assist Camera (PAC) – limitations

### Limitations

Even if a fairly small section of the screen image appears to be obstructed, this may mean that a relatively large area behind the vehicle is hidden and objects there may not be detected until they are very near the vehicle.

#### NOTE

Bicycle carriers or other accessories mounted on the trunk may obstruct the camera's field of view.

### Keep in mind

- Keep the camera's lens free of dirt, ice and snow. Remove ice and snow carefully to avoid scratching the lens.
- Clean the lens regularly with warm water and a suitable car washing detergent.

### Related information

- Rear Park Assist Camera (PAC) – introduction (p. 223)
- Rear Park Assist Camera (PAC) – operation (p. 224)
- Park assist – introduction (p. 219)

## BLIS\* – introduction

The *Blind Spot Information System (BLIS)* is an information system that indicates the presence of another vehicle moving in the same direction as your vehicle in the side-view mirror's "blind area."

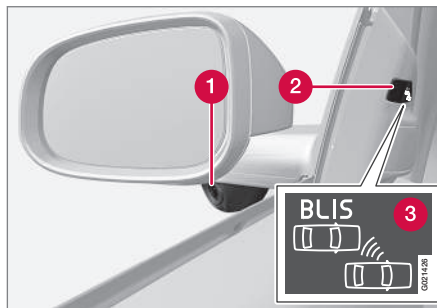

- 1 BLIS camera
- 2 Indicator light
- 3 BLIS symbol

#### CAUTION

The BLIS system should only be repaired by a trained and qualified Volvo service technician.

#### WARNING

- BLIS is an information system, NOT a warning or safety system.
- BLIS does not eliminate the need for you to visually confirm the conditions around you, and the need for you to turn your head and shoulders to make sure that you can safely change lanes.
- As the driver, you have full responsibility for changing lanes in a safe manner.

The system is based on digital camera technology. The cameras are located beneath the side-view mirrors.

When one (or both) of the cameras have detected a vehicle in the blind area (up to approximately 10 ft. (3 meters) from the side of your vehicle, and up to approximately 31 ft. (9.5 meters) behind the side-view mirror), see the illustration, the indicator light in the door panel illuminates. The light will glow continuously to alert the driver of the vehicle in the blind area.

#### NOTE

The door panel indicator light illuminates on the side of the vehicle where the system has detected another vehicle. If your vehicle is passed on both sides at the same time, both lights will illuminate.



# 07 Driver support



BLIS has an integrated function that alerts the driver if a fault should occur with the system. For example, if one or both of the system's cameras are obscured, a message (see the table in BLIS\* – messages (p. 230)) will appear in the information display in the instrument panel. If this occurs, clean the camera lenses. If necessary, the system can be temporarily switched off (for instructions, see BLIS\* – messages (p. 230)).

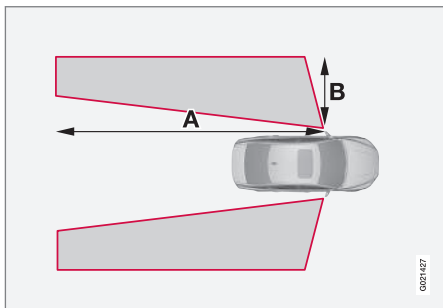

Areas monitored by BLIS Distance A = approx. 31 ft. (9.5 meters), Distance B = approx. 10 ft. (3 meters)

## Related information

- BLIS\* – function (p. 228)
- BLIS\* – operation (p. 229)
- BLIS\* – limitations (p. 229)
- BLIS\* – messages (p. 230)

## BLIS\* – function

### When does BLIS function

The system functions when your vehicle is moving at speeds above 6 mph (10 km/h).

### When you pass another vehicle:

The system reacts when you pass another vehicle at a speed of up to 6 mph (10 km/h) faster than that vehicle.

### When you are passed by another vehicle:

The system reacts if your vehicle is passed by another vehicle at a speed of up to 43 mph (70 km/h) faster than your vehicle.

## WARNING

- BLIS does not function in sharp curves.
- BLIS does not function when your vehicle is backing up.
- If you are towing a wide trailer, this may prevent the BLIS cameras from detecting other vehicles in adjacent lanes.

## How BLIS functions in daylight and darkness

### Daylight

BLIS reacts to the **shape** of surrounding vehicles. The system is designed to help detect

motor vehicles such as cars, trucks, buses, motorcycles, etc.

### Darkness

BLIS reacts to the **headlights** of surrounding vehicles. In order to be detected by BLIS, a vehicle in the blind area must have its headlights on. This means, for example, that the system will not detect a trailer without headlights that is being towed behind a car or truck.

## WARNING

- BLIS does not react to cyclists or mopeds.
- BLIS does not react to vehicles that are standing still.
- The BLIS cameras have the same limitation as the human eye. In other words, their "vision is impaired" by adverse weather conditions such as heavy snowfall, intense light directly into the camera, dense fog, etc.

## Related information

- BLIS\* – introduction (p. 227)
- BLIS\* – operation (p. 229)
- BLIS\* – limitations (p. 229)
- BLIS\* – messages (p. 230)



## BLIS\* – operation

### Switching BLIS on and off

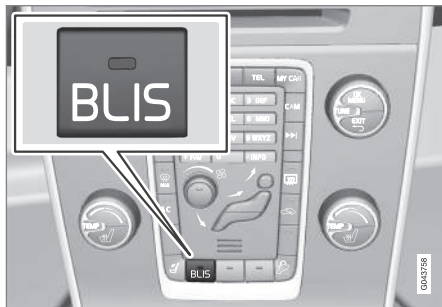

BLIS is automatically activated when the ignition is switched on. The indicator lights will provide confirmation by flashing 3 times.

- The system can be switched off by pressing the **BLIS** button in the center console (see the illustration). The indicator light in the button goes out when the system is switched off, and a text message is displayed.
- BLIS can be switched on again by pressing the button. The indicator light in the button will illuminate and a new text message will be displayed. Press the **OK** button (see Information display – menu controls (p. 106)) to erase the message.

Depending on the vehicle's optional equipment, there may not be space for the **BLIS** button in the center console. In this case,

BLIS can be switched on and off in the menu system by pressing **MY CAR** and going to **Settings** → **Car settings** → **BLIS**. See My Car – introduction (p. 70) for a description of the menu system.

### Related information

- BLIS\* – introduction (p. 227)
- BLIS\* – function (p. 228)
- BLIS\* – limitations (p. 229)
- BLIS\* – messages (p. 230)

## BLIS\* – limitations

In certain situations, the BLIS indicator light(s) may illuminate even when there are no other vehicles in the area monitored by the system.

### **i** NOTE

If the BLIS indicator lights illuminate occasionally even when there are no other vehicles in the blind area, this does not indicate a fault in the system.

In the event of a fault, **Blind spot syst. Service required** will be displayed.

The following are several examples of situations in which the BLIS indicator light(s) may illuminate even when there are no other vehicles in the area monitored by the system.

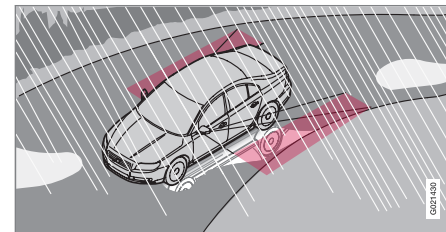

*Light reflected from a wet road surface*

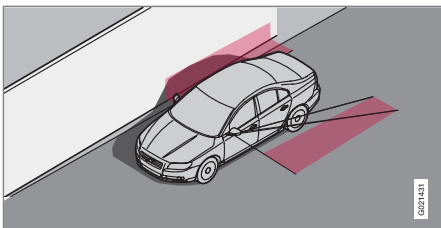

The vehicle's own shadow against a large, light, smooth surface such as barriers between lanes on a highway

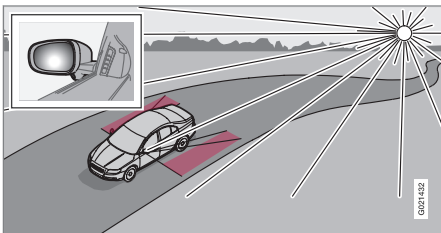

Sunlight directly in the camera when the sun is low on the horizon

## Cleaning the BLIS camera lenses

In order to function optimally, the BLIS camera lenses must be kept clean. They can be wiped clean with a soft cloth or wet sponge.

### CAUTION

- Clean the lenses carefully to avoid scratching.
- The lenses are electrically heated to help melt ice or snow. If necessary, gently brush away snow from the lenses.

### CAUTION

The BLIS system should only be repaired by a trained and qualified Volvo service technician.

### Related information

- BLIS\* – introduction (p. 227)
- BLIS\* – function (p. 228)
- BLIS\* – operation (p. 229)
- BLIS\* – messages (p. 230)

## BLIS\* – messages

### BLIS system messages

A text message can be erased by pressing briefly on the **OK** button on the turn signal lever.

Text in the display	System status
Blind spot syst. Service required	BLIS not functioning properly. Contact an authorized Volvo service technician.
Blind spot syst. Camera blocked	BLIS camera obscured. Clean the lenses.
Blind-spot info system ON	BLIS system on



Text in the display	System status
Blind-spot info system OFF	BLIS system off
Blind spot syst. Reduced function	The BLIS cameras' function has been reduced due to weak or impaired data transfer between the BLIS system's cameras and the vehicle's electrical system. The cameras will reset themselves when this data transfer has returned to normal.

#### Related information

- BLIS\* – introduction (p. 227)
- BLIS\* – function (p. 228)
- BLIS\* – operation (p. 229)
- BLIS\* – limitations (p. 229)

# 08



## STARTING AND DRIVING





## Starting the engine

The engine can be started/switched off using the remote key and the **START/STOP ENGINE** button.



Ignition slot with remote key inserted (see Ignition modes (p. 73) for more information on ignition modes)

## WARNING

Before starting the engine:

- Fasten the seat belt.
- Check that the seat, steering wheel and mirrors are adjusted properly.
- Make sure the brake pedal can be depressed completely. Adjust the seat if necessary.

## WARNING

- Never use more than one floor mat at a time on the driver's floor. Before driving, remove the original mat from the driver's seat floor before using any other type of floor mat. Any mat used in this position should be securely and properly anchored in the attaching pins. An extra mat on the driver's floor can cause the accelerator and/or brake pedal to catch. Check that the movement of these pedals is not impeded.
- Volvo's floor mats are specially manufactured for your car. They must be firmly secured in the clips on the floor so that they cannot slide and become trapped under the pedals on the driver's side.

1. Press the remote key into the ignition slot as far as possible, with the metallic key blade pointing outward (not inserted into the slot)<sup>1</sup>.
2. Depress the brake pedal<sup>2</sup>.

3. Press and release the **START/STOP ENGINE** button. The autostart function will operate the starter motor until the engine starts or until its overheating function stops it.

The starter motor operates for a maximum of 10 seconds. If the engine has not started, repeat the procedure.

## CAUTION

If the engine does not start after the third try, wait for approximately 3 minutes before trying to start it again to give the battery time to recover its starting capacity.

## NOTE

### Keyless drive\*

To start a vehicle equipped with the keyless drive feature, one of the remote keys must be in the passenger compartment. Follow the instructions in steps 2 and 3 to start the vehicle.

<sup>1</sup> On vehicles with the optional keyless drive, it is only necessary to have a remote key in the passenger's compartment.

<sup>2</sup> If the vehicle is moving, it is only necessary to press the START/STOP ENGINE button to start the vehicle.





## 08 Starting and driving



### WARNING

- Always remove the remote key from the ignition slot when leaving the vehicle and ensure that the ignition is in mode **0** (see Ignition modes (p. 73) for information about the ignition modes), especially if there are children in the vehicle.
- On vehicles with the optional keyless drive, never remove the remote key from the vehicle while it is being driven or towed.
- Always place the gear selector in Park and apply the parking brake before leaving the vehicle. Never leave the vehicle unattended with the engine running.
- Always open garage doors fully before starting the engine inside a garage to ensure adequate ventilation. The exhaust gases contain carbon monoxide, which is invisible and odorless but very poisonous.

### NOTE

- After a cold start, idle speed may be noticeably higher than normal for a short period. This is done to help bring components in the emission control system to their normal operating temperature as quickly as possible, which enables them to control emissions and help reduce the vehicle's impact on the environment<sup>3</sup>.

### CAUTION

- When starting in cold weather, the automatic transmission may shift up at slightly higher engine speeds than normal until the automatic transmission fluid reaches normal operating temperature.
- Do not race a cold engine immediately after starting. Oil flow may not reach some lubrication points fast enough to prevent engine damage.
- The engine should be idling when you move the gear selector. Never accelerate until after you feel the transmission engage. Accelerating immediately after selecting a gear will cause harsh engagement and premature transmission wear.
- Selecting **P** or **N** when idling at a standstill for prolonged periods of time will help prevent overheating of the automatic transmission fluid.

### Related information

- Switching off the engine (p. 235)

<sup>3</sup> If the gear selector is in the **D** or **R** positions and the car is not moving, engine speed (rpm) will be lower and it will take longer for the engine to reach normal operating temperature.



### Switching off the engine

Switch off the engine by pressing the **START/STOP ENGINE** button.

If the gear selector is not in the **P** position or if the vehicle is moving, press the **START/STOP ENGINE** button twice or press and hold it in until the engine switches off.

#### Related information

- Ignition modes (p. 73)

### Engine Remote Start (ERS)\* – introduction

*ERS is a feature that makes it possible to remotely start the engine using the remote key to cool or heat the passenger compartment before driving.*

The climate/ and infotainment systems will start using the same settings as when the engine was switched off.

When the engine is started using ERS, it will run for a maximum of 15 minutes before automatically switching off again. After 2 ERS starts, the engine must be started in the normal way before ERS can be used again.

#### NOTE

- Always adhere to applicable State, Province and/or Local laws regarding engine idling when using ERS.
- The service life of the remote key's battery is affected by ERS use. If this feature is used frequently, the battery should be replaced once a year, see Remote key – replacing the battery (p. 147).



#### WARNING

Keep the following in mind before using ERS:

- The vehicle should be in view.
- The vehicle should be unoccupied.
- The vehicle must not be parked indoors or in an enclosed area. Exhaust fumes are harmful to the health.

#### Related information

- Engine Remote Start (ERS)\* – starting the engine (p. 236)
- Engine Remote Start (ERS)\* – switching off the engine (p. 236)



## Engine Remote Start (ERS)\* – starting the engine



Remote key buttons used for remote engine start

- 1 Lock
- 2 Approach lighting

### Starting the engine

The maximum range for ERS is approximately 100 ft (30 meters) if the view of the vehicle is unobstructed. **The vehicle must also be locked.**

To start the engine:

1. Press the lock button (1) briefly.
2. Immediately press the approach lighting button (2) for approximately 2 seconds.

If the requirements for ERS have been met, the following will occur:

1. The turn signals will flash several times.
2. The engine will start.
3. The turn signals will illuminate for 3 seconds to indicate that the engine has started.

After the engine has started, the vehicle remains locked but the alarm is disarmed.

### Active functions

When the engine is started with ERS, the following functions are activated:

- The climate control system
- The infotainment system.

### Deactivated functions

When the engine is started with ERS, the following functions are deactivated:

- Headlights
- Parking lights
- License plate lights
- Windshield wipers

### Related information

- Engine Remote Start (ERS)\* – switching off the engine (p. 236)
- Engine Remote Start (ERS)\* – introduction (p. 235)

## Engine Remote Start (ERS)\* – switching off the engine

Any of the following will switch off the engine if it has been started with ERS:

- Pressing the lock button (1) or the unlock button (2) on the remote key
- Unlocking the vehicle
- Opening a door
- Depressing the accelerator or brake pedal
- Moving the gear selector from the **P** position
- If there are less than approx. 2.5 gallons (10 liters) of fuel in the tank
- More than 15 minutes have elapsed.

If the engine has been started with ERS and switches off, the turn signals will illuminate for 3 seconds.

### Message in the instrument panel display

If ERS is interrupted, a text message will be displayed in the instrument panel.

### Related information

- Engine Remote Start (ERS)\* – introduction (p. 235)
- Engine Remote Start (ERS)\* – starting the engine (p. 236)



## Jump starting

Follow these instructions to jump start your vehicle's dead battery or to jump start another vehicle's dead battery using your vehicle.

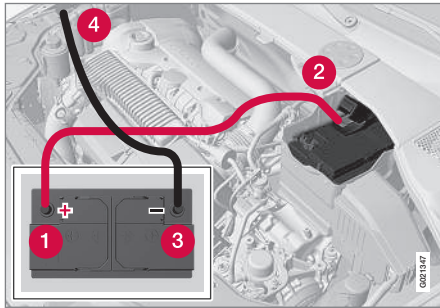

Connecting the jumper cables

If the 12-volt auxiliary battery to be used is in another vehicle, check that the vehicles are not touching to prevent premature completion of a circuit. Be sure to follow jump starting instructions provided for the other vehicle.

To jump start your vehicle:

1. Switch off the ignition (set the ignition to mode **0**, see Ignition modes (p. 73)).
2. First connect the red jumper cable to the auxiliary battery's positive (+) terminal (1).

3. Fold back the cover over the positive (+) terminal on your vehicle's battery (2), marked with a "+" sign, located under a folding cover.
4. Connect the black jumper cable to the auxiliary battery's negative (-) terminal (3) and to the ground point in your vehicle's engine compartment (right engine mount at the top, on the outer screw) (4).
5. Start the engine in the assisting vehicle, then start the engine in the vehicle with dead battery.
6. After the engine has started, first remove the negative (-) terminal jumper cable (black). Then remove the positive (+) terminal jumper cable (red).

### WARNING

#### PROPOSITION 65 WARNING!

Battery posts, terminals, and related accessories contain lead and lead compounds, chemicals known to the state of California to cause cancer and reproductive harm. Wash hands after handling.

### CAUTION

Connect the jumper cables carefully to avoid short circuits with other components in the engine compartment.

### WARNING

- Do not connect the jumper cable to any part of the fuel system or to any moving parts. Avoid touching hot manifolds.
- Batteries generate hydrogen gas, which is flammable and explosive.
- Battery fluid contains sulfuric acid. Do not allow battery fluid to contact eyes, skin, fabrics or painted surfaces. If contact occurs, flush the affected area immediately with water. Obtain medical help immediately if eyes are affected.
- Never expose the battery to open flame or electric spark.
- Do not smoke near the battery.
- Failure to follow the instructions for jump starting can lead to injury.

### Related information

- Starting the engine (p. 233)



## Transmission – general information

The transmission automatically shifts between the various forward gears, based on the level of acceleration and speed.

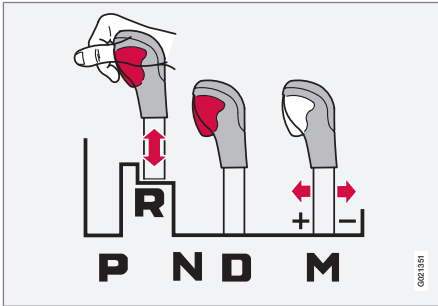

Shiftgate positions

Depress the button on the front of the gear selector knob to move the gear selector between the **R**, **N**, **D**, and **P** positions.

The gear selector can be moved freely between the Geartronic (manual shifting) and Drive (**D**) positions while driving.

## ! CAUTION

The transmission's temperature is monitored to help prevent damage to the transmission or other drivetrain components. If there is a risk of overheating, the warning symbol on the instrument panel will illuminate and a text message will be displayed. Follow the instructions provided there.

## Hill Start Assist (HSA)<sup>4</sup>

HSA makes it easier to start or back up on a hill by retaining pressure on the brake pedal for several seconds after the pedal has been released in order to keep the vehicle at a standstill.

The brakes will be released after several seconds or when the driver presses the accelerator pedal.

## Related information

- Transmission – positions (p. 238)
- Transmission – Geartronic (p. 240)
- Transmission – shiftlock override (p. 242)
- All Wheel Drive (AWD) (p. 250)
- Fuel tank volume – specification and volume (p. 361)

## Transmission – positions

### Park: position P

Select the **P** position when starting or parking.

<sup>4</sup> Certain models only



### Shiftlock

When **P** has been selected, the transmission is mechanically blocked in this position. The brake pedal must be depressed and the ignition must be in at least mode **II** (see Ignition modes (p. 73)) before the gear lever can be moved from the **P** position.

### WARNING

Always apply the parking brake when the vehicle is parked, particularly when parking on a hill. The transmission's **P** mode may not be able to keep the vehicle stationary if it is parked on an incline.

Press the control to apply the parking brake, see Parking brake – general information (p. 254).



### CAUTION

The vehicle must be stationary when position **P** is selected.

### Gear indicator

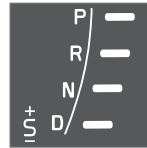

The gear currently being used is displayed on the right side of the instrument panel.

The "S" symbol turns orange if Sport mode is being used.

### Reverse: position R

The vehicle must be stationary when position **R** is selected.

### Neutral: position N

No gear is engaged and the engine can be started with the gear selector in this position. Apply the parking brake if the vehicle is stationary with the gear selector in position **N**. In order to move the gear selector from the **N** position, the brake pedal must be depressed and the ignition must be in at least mode **II**.

### Drive: position D

**D** is the normal driving position. The car automatically shifts between the various forward gears, based on the level of acceleration and speed. The car must be at a standstill when shifting from position **R** to position **D**.

### Related information

- Transmission – general information (p. 238)
- Transmission – Geartronic (p. 240)
- Transmission – shiftlock override (p. 242)
- Fuel tank volume – specification and volume (p. 361)



## 08 Starting and driving

### Transmission – Geartronic

*Geartronic allows you to manually shift among your vehicle's forward gears. The manual position (+S-) can be selected at any time.*

#### Geartronic: manual shifting (+S-)

 To shift gears manually, move the gear selector to the side from **D** toward **+S-**. The **+S-** symbol in the instrument panel will change from **white** to **orange** and the number of the gear currently being used (1, 2, 3, etc.) will be displayed (see the following illustration)<sup>5</sup>.

- To return to automatic shifting mode from **+S-**, move the gear selector to the side toward **D**.

#### Gear shift indicator\*



*Gear shift indicator in a digital instrument panel*<sup>6</sup>

This option indicates when to shift up or down to help conserve fuel. A white arrow will appear above or below the number of the current gear to prompt the driver to shift up or down.

#### While driving

- If you select the manual shifting position while driving, the gear that was being used in the Drive position will also initially be selected in the manual shifting position.
- Move the gear selector forward (toward **+**) to shift to a higher gear or rearward (toward **-**) to shift to a lower gear.
- If you hold the gear selector toward **"-"**, the transmission will downshift one gear at a time and will utilize the braking power of the engine. If the current speed is too high for using a lower gear, the downshift will not occur until the speed has decreased enough to allow the lower gear to be used.
- If you slow to a very low speed, the transmission will automatically shift down.

#### Shiftlock: Neutral (N)

If the gear selector is in the **N** position and the vehicle has been stationary for at least 3 seconds (irrespective of whether the engine is running) then the gear selector is locked.

In order to move the gear selector from **N** to another gear position, the brake pedal must be depressed and the ignition must be in at least position **II**, see Ignition modes (p. 73).

<sup>5</sup> If Sport mode is being used, the symbol will change to "S".

<sup>6</sup> Analog instrument panel: the gear shift indicator is displayed in the center of the speedometer.



### Geartronic: steering wheel paddles\*

In addition to the manual gearshift function using the gear selector, this option makes it possible to manually shift gears from the steering wheel.



Steering-wheel mounted gear shift paddles

- 1 "-": Shift down to a lower gear.
- 2 "+": Shift up to a higher gear.

In order to shift gears with the paddles, they have to first be activated. **The gear selector can be in either the D or S position.**

#### Activating the paddles:

- Pull either paddle toward the steering wheel and release it; the **D** in the instrument panel will change to the number of the gear currently being used.

#### Shifting gears:

- Pull the paddle toward the steering wheel and release it.

#### Deactivating the paddles:

- Hold the "+" paddle for approximately 3 seconds.

#### **i** NOTE

If the gear selector was in **D** when paddle shifting was activated (**D** changed to the number of the gear being used), the transmission will automatically revert to **D** after approximately 5 seconds if the paddles are not used to shift gears.

This will **not** occur:

- during active driving (e.g., on a winding road, while accelerating, etc)
- if the gear selector was in **S** when the paddles were activated

If the transmission reverts to **D**, the paddles will have to be reactivated (pull either paddle toward the steering wheel and release it) before they can be used to shift gears again.

The paddles can also be manually deactivated by pulling both paddles toward the steering wheel and holding them until the gear number shown in the instrument panel changes to **D**.

### Geartronic: Sport mode (S)<sup>7</sup>

This transmission mode provides sportier shifting characteristics and enables a more active driving style by making it possible to drive at higher rpm in each gear before shifting up. The engine also responds faster when the accelerator pedal is pressed.

To access Sport mode from Drive (**D**), move the gear selector to the left. The transmission will not switch to manual shifting mode until the gear selector is moved forward or rearward toward + or -.

Sport mode can be selected any time.

#### **i** NOTE

- On vehicles equipped with Sport mode, the transmission symbol in the main instrument panel will change from **D** to **S** when the gear selector is moved to the manual shifting mode. If the gear selector is moved toward "+" or "-", the number of the gear currently being used will be displayed, see Information displays – introduction (p. 62).
- Please be aware that using Sport mode may result in a slight decrease in fuel economy. Driving in **D** can help improve fuel economy.

<sup>7</sup> Certain models only





## Geartronic: starting on slippery surfaces

Selecting 3rd gear in Geartronic's manual shifting mode can help provide better traction when starting off on slippery surfaces. To do so:

1. Depress the brake pedal and move the gear selector to the side from **D** toward **+S-**.
2. Press the gear selector forward and release it (this selects 2nd gear). Press the selector forward again and release it to select 3rd gear. The optional steering wheel paddles can also be used; see the previous section "Geartronic: steering wheel paddles."
3. Release the brake pedal and press gently on the accelerator pedal.

## Related information

- Transmission – general information (p. 238)
- Transmission – positions (p. 238)
- Transmission – shiftlock override (p. 242)
- Fuel tank volume – specification and volume (p. 361)

## Transmission – shiftlock override

*If the vehicle cannot be driven, for example because of a dead battery, the gear selector must be moved from the **P** position before the vehicle can be moved<sup>8</sup>.*

### Shiftlock override



- 1 Lift away the rubber mat on the floor of the storage compartment behind the center console to expose the small opening for overriding the shiftlock system.
- 2 Insert the key blade into the opening. Press the key blade down as far as possible and keep it held down.
- 3 Move the gear selector from the **P** position. For information on the key blade, see Detachable key blade – general information (p. 145).

## Related information

- Transmission – general information (p. 238)
- Transmission – positions (p. 238)
- Transmission – Geartronic (p. 240)
- Fuel tank volume – specification and volume (p. 361)

<sup>8</sup> If the battery is dead, the electric parking brake cannot be applied or released. Connect an auxiliary battery if the battery voltage is too low, see Jump starting (p. 237).



## Start/Stop – Hill Start Assist (HSA)

When starting on steep hills, HSA (see Transmission – general information (p. 238)) retains pressure on the brake pedal for several seconds after the pedal has been released in order to keep the vehicle at a standstill. The brakes will be released after several seconds or when the driver presses the accelerator pedal.

### Related information

- Start/Stop – introduction (p. 243)
- Start/Stop – function (p. 243)
- Start/Stop – settings (p. 246)
- Start/Stop – Auto-stop exceptions (p. 244)
- Start/Stop – Auto-start exceptions (p. 245)
- Start/Stop – symbols and messages (p. 247)

## Start/Stop – introduction

*Start/Stop is a function that temporarily switches off the engine when the vehicle is not moving, for instance in heavy traffic or at a traffic light to help reduce fuel consumption.*

Start/Stop is available with certain engines/transmissions.

### Related information

- Start/Stop – function (p. 243)
- Start/Stop – settings (p. 246)
- Start/Stop – Auto-stop exceptions (p. 244)
- Start/Stop – Auto-start exceptions (p. 245)
- Start/Stop – Hill Start Assist (HSA) (p. 243)
- Start/Stop – symbols and messages (p. 247)

## Start/Stop – function

### Function and use



*Start/Stop symbol in the instrument panel*



*Start/Stop button on the center console*

Start/Stop is activated automatically each time the engine is started<sup>9</sup>. The symbol in the instrument panel will be displayed for several seconds when the engine starts and the indicator light in the On/Off button will remain illuminated while the function is activated.

All of the vehicle's systems will function while the engine is auto-stopped, although the function of certain systems may be reduced at this time. For example, blower speed and high infotainment system volume may be reduced to help conserve the battery's capacity.

<sup>9</sup> Not when the engine is started using the optional Engine Remote Start feature, Starting the engine (p. 233)



# 08 Starting and driving



## Auto-stopping the engine

Normally, when Start/Stop is activated and the brakes are applied until the vehicle comes to a standstill, the engine will auto-stop automatically **if the driver keeps the brake pedal depressed**.



To remind the driver that the engine has been auto-stopped, the Start/Stop symbol will illuminate in the instrument panel and remain on until the engine restarts.



If the ECO function\* (ECO\* (p. 248)) is activated, the engine may auto-stop before the vehicle comes to a complete standstill.

## Auto-starting the engine

The engine restarts as soon as the driver releases the brake pedal.

## Deactivating Start/Stop



In certain situations (e.g., driving in heavy, stop-and-go traffic), it may be preferable to deactivate Start/Stop.

This is done by pressing the button in the center console.

The indicator light in the button will go out.

Start/Stop will remain deactivated until the button is pressed again or until the engine is switched off and restarted by the driver.

## Related information

- Start/Stop – introduction (p. 243)
- Start/Stop – settings (p. 246)
- Start/Stop – Auto-stop exceptions (p. 244)
- Start/Stop – Auto-start exceptions (p. 245)
- Start/Stop – Hill Start Assist (HSA) (p. 243)
- Start/Stop – symbols and messages (p. 247)

## Start/Stop – Auto-stop exceptions

In certain situations or conditions, the engine **may not auto-stop** when the vehicle comes to a standstill, such as if:

Condition/situation
The vehicle's speed has not reached a speed of approx. 5 mph (8 km/h) after the most recent auto-start or after the driver has started the engine.
The driver unbuckles his/her seat belt.
The main battery's charge is below the minimum level.
The engine has not reached its normal operating temperature.
The ambient temperature is below approx. 25°F (-4°C) or above approx. 85°F (30°C).
The windshield's heating function* is activated.
The climate system cannot keep the desired settings in the passenger compartment; the blower will operate at high speed.
The vehicle is backing up.
The main battery's temperature is below freezing or too high.



### Condition/situation

The driver is turning the steering wheel hard.

The road's incline is very steep.

A trailer's electrical system is connected to the vehicle.

The hood has been opened<sup>A</sup>.

The transmission has not reached its normal operating temperature.

Atmospheric pressure is below a level equivalent to an altitude of approx. 4,900–8,200 ft (1500–2500 m) above sea level. The actual pressure is also affected by current weather conditions.

The Adaptive Cruise Control's\* Queue Assist feature is activated.

The gear selector is in the **S<sup>B</sup>** or "+/-" position.

<sup>A</sup> Certain engines only

<sup>B</sup> Sport mode (where applicable)

### Related information

- Start/Stop – introduction (p. 243)
- Start/Stop – function (p. 243)
- Start/Stop – settings (p. 246)
- Start/Stop – Auto-start exceptions (p. 245)

- Start/Stop – Hill Start Assist (HSA) (p. 243)
- Start/Stop – symbols and messages (p. 247)

### Start/Stop – Auto-start exceptions

In certain situations or conditions, the engine **may auto-start** even though the driver is still pressing the brake pedal, such as if:

### Condition/situation

Condensation forms on the windows.

The climate system cannot keep the desired settings in the passenger compartment.

Electrical current consumption is temporarily high or the main battery's charge is below the minimum level.

The brake pedal is pumped repeatedly.

The hood has been opened<sup>A</sup>.

The vehicle begins to move or increases speed slightly (if the engine auto-stopped before the vehicle was at a standstill (see ECO\* (p. 248))).

The driver unbuckles his/her seat belt while the gear selector is in the **D** or **N** positions.

The steering wheel is turned<sup>A</sup>.





## Condition/situation

The gear selector is moved from **D** to **S<sup>B</sup>**, **R** or "+/-".

The driver's door is opened with the gear selector in **D** – an audible signal and a text message will inform the driver that Start/Stop is active.

A Certain engines only

B Sport mode (where applicable)

## WARNING

Do not open the hood if the engine has auto-stopped. The engine could suddenly auto-start.

Before opening the hood:

- Switch off the ignition using the **START/STOP ENGINE** button.
- Be aware that if the engine has been running, components in the engine compartment will be very hot.

### If the engine does not auto-start, this could be due to:

- The driver's seat belt is not fastened
- The gear selector is in **P** and the driver's door is opened

In these cases, the driver will have to restart the engine by pressing the **START/STOP ENGINE** button.

## Related information

- Start/Stop – introduction (p. 243)
- Start/Stop – function (p. 243)
- Start/Stop – settings (p. 246)
- Start/Stop – Auto-stop exceptions (p. 244)
- Start/Stop – Hill Start Assist (HSA) (p. 243)
- Start/Stop – symbols and messages (p. 247)

## Start/Stop – settings

Settings for the Start/Stop function can be made in the **MY CAR** menu system.

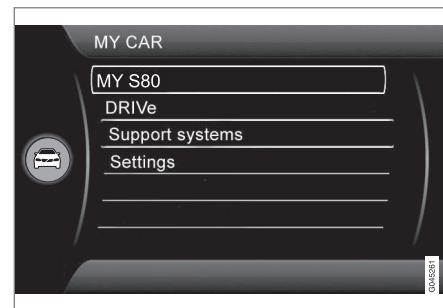

## Related information

- Start/Stop – introduction (p. 243)
- Start/Stop – function (p. 243)
- Start/Stop – Auto-stop exceptions (p. 244)
- Start/Stop – Auto-start exceptions (p. 245)
- Start/Stop – Hill Start Assist (HSA) (p. 243)
- Start/Stop – symbols and messages (p. 247)





## Start/Stop – symbols and messages

### Text messages

 Combined with the information symbol in the instrument panel, the

Start/Stop function may also display messages in certain situations. Follow the instructions provided in the message. The following table gives several examples.

Symbol	Message	Information/action
	Auto Start/Stop Service required	Start/Stop is not functioning properly. Contact a Volvo retailer or a trained and qualified Volvo service technician.
	Autostart Engine running + an audible signal	This is triggered if the driver's door is opened while the engine is auto-stopped.
-	Press Start button	The engine will not auto-start. Start the engine normally by pressing the <b>START/STOP ENGINE</b> button.
-	Select P or N to start	Start/Stop has been deactivated. Move the gear selector to <b>N</b> or <b>P</b> and start the engine normally by pressing the <b>START/STOP ENGINE</b> button.
-	Press Start button	The engine will not auto-start. Move the gear selector to <b>N</b> or <b>P</b> and start the engine normally by pressing the <b>START/STOP ENGINE</b> button.

If the message does not disappear after the suggested action has been taken, contact a Volvo retailer or a trained and qualified Volvo service technician.

### Related information

- Start/Stop – introduction (p. 243)
- Start/Stop – function (p. 243)
- Start/Stop – settings (p. 246)
- Start/Stop – Auto-stop exceptions (p. 244)
- Start/Stop – Auto-start exceptions (p. 245)
- Start/Stop – Hill Start Assist (HSA) (p. 243)



# 08 Starting and driving

## ECO\*

Eco is a function<sup>10</sup> developed by Volvo to give the driver the opportunity to actively drive more economically and to help reduce fuel consumption.

### Introduction



When Eco is activated, the following functions are modified:

- The automatic transmission's shifting points
- The engine management system and accelerator pedal response
- Stop/stop function (Start/Stop – introduction (p. 243)): the engine can auto-stop before the vehicle has come to a full stop
- Eco Coast functionality is activated: engine braking is disabled
- Climate system settings: certain functions (e.g., air conditioning) will be temporarily reduced or deactivated

### NOTE

When Eco is activated, several climate system parameters are changed and the function of certain current-consuming systems will be reduced.

Some of these functions can be restarted manually but full functionality will not be restored until Eco is deactivated.

### Function

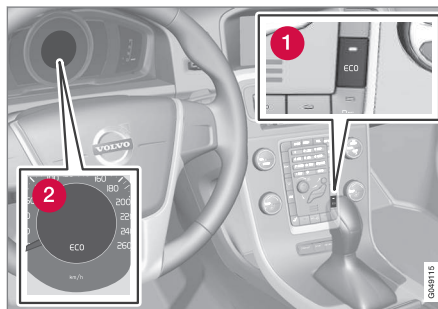

- 1 ECO On/Off button in the center console
- 2 ECO symbol in the instrument panel

When the engine is switched off, ECO is deactivated and must be reactivated each time the engine is started (with the exception of certain engines).

The **ECO** symbol will be displayed in the instrument panel and the indicator light in the **ECO** button will be **on** when Eco is activated.

### Eco on or off



When ECO is deactivated, the **ECO** symbol will **not** be displayed in the instrument panel and the indicator light in the **ECO** button will be **off**. The function will remain deactivated until the button is pressed again.

### Eco Coast

Eco Coast is an integral part of the Eco function and essentially deactivates engine braking, allowing the vehicle to roll freely.

### NOTE

To function optimally, Eco Coast should primarily be used when the vehicle can coast as far as possible.

When the driver releases the accelerator pedal, the transmission is automatically disengaged from the engine and engine rpm will be reduced to the idle level (approx. 700-800 rpm), which helps reduce fuel consumption.

<sup>10</sup> Option on models equipped with certain 4-cylinder engines

\* Option/accessory, for more information, see Introduction.



This feature is primarily intended to be used in driving situations where a decrease in speed is expected, such as when approaching an intersection or a traffic light.

Eco Coast enables proactive driving with as little braking as possible.

### Combinations of On and Off

Depending on the driving situation, Eco can be used in different ways to help reduce fuel consumption:

- **With Eco activated:** this enables Eco Coast, which allows the vehicle **to roll freely for as far as possible** when the driver releases the accelerator pedal (e.g., when approaching a traffic light or intersection).

or

- **With Eco deactivated:** engine braking can be used **when the vehicle will only roll for a short distance** (in heavy traffic, etc.) or **when driving down hills**.

To help keep fuel consumption as low as possible, Eco Coast should not be used in traffic situations where the brakes have to be used frequently.

### Activating Eco Coast

Eco Coast is activated when the accelerator pedal is released completely if:

- Eco is activated
- The gear selector is in **D**

- The vehicle's speed is between approximately 40–85 mph (65–140 km/h). Always observe posted speed limits
- The gradient of a down-slope is less than approximately 6%

### Deactivating Eco Coast

In certain situations, it may be advisable to switch off the Eco Coast function, such as:

- When driving down steep hills, in order to utilize engine braking
- Prior to passing another vehicle, in order to do so as safely as possible

Deactivating Eco Coast (and reactivating engine braking) can be done in the following ways:

- Press the **ECO** button on the center console
- Move the gear selector to the manual "**S +/-**" position
- Change gears using the steering wheel paddles\*
- Press the brake or accelerator pedal

### Eco Coast limitations

This function will not be available if:

- Cruise control is activated
- The gradient of a down-slope is more than approximately 6%
- The steering wheel paddles\* are used to manually change gears

- The engine and/or transmission have not reached their normal operating temperature
- The gear selector is moved from **D** to the manual "**S +/-**" position
- The vehicle's speed is not within the 40–85 mph (65–140 km/h). interval

### Additional information and settings

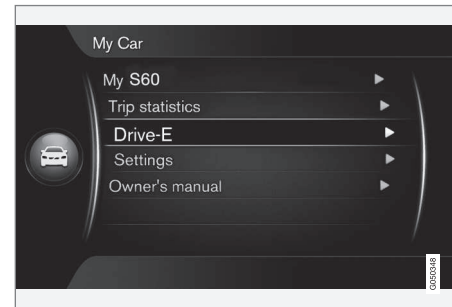

Other ECO-related settings can be made in the vehicle's **MY CAR** menu. See My Car – introduction (p. 70) for more information.

### Related information

- Climate – general information (p. 118)
- Transmission – general information (p. 238)



### All Wheel Drive (AWD)

Your Volvo can be equipped with permanent All Wheel Drive, which means that power is distributed automatically between the front and rear wheels.

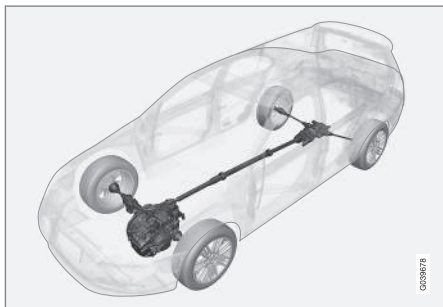

Under normal driving conditions, most of the engine's power is directed to the front wheels. However, if there is any tendency for the front wheels to spin, an electronically controlled coupling distributes power to the wheels that have the best traction.

#### NOTE

The message **AWD disabled Service required** will appear in the information display if an electrical fault should occur in the AWD system. A warning light will also illuminate in the instrument panel. If this occurs, have the system checked by a trained and qualified Volvo service technician.

#### Related information

- Transmission – general information (p. 238)

### Brakes – general

*The brake system is a hydraulic system consisting of two separate brake circuits. If a problem should occur in one of these circuits, it is still possible to stop the vehicle with the other brake circuit.*

If the brake pedal must be depressed farther than normal and requires greater foot pressure, the stopping distance will be longer.

A warning light in the instrument panel will light up to warn the driver that a fault has occurred.

If this light comes on while driving or braking, stop immediately and check the brake fluid level in the reservoir.

#### NOTE

Press the brake pedal hard and maintain pressure on the pedal – do not pump the brakes.

#### WARNING

If the fluid level is below the **MIN** mark in the reservoir or if a brake system message is shown in the information display: **DO NOT DRIVE**. Have the vehicle towed to a trained and qualified Volvo service technician and have the brake system inspected.



### Brake pad inspection

On vehicles equipped with a jack\*, the condition of the brake pads can be checked by raising the vehicle (see Changing a wheel – removing wheel (p. 276) for information about using the jack and removing a wheel) and performing a visual inspection of the brake pads.

#### WARNING

- If the vehicle has been driven immediately prior to a brake pad inspection, the wheel hub, brake components, etc., will be very hot. Allow time for these components to cool before carrying out the inspection.
- Apply the parking brake and put the gear selector in the Park (P) position.
- Block the wheels standing on the ground, use rigid wooden blocks or large stones.

#### WARNING

- Use the jack intended for the vehicle when changing a tire. For any other job, use stands to support the vehicle.
- The jack should be kept well-greased and clean, and should not be damaged.
- Be sure the jack is on a firm, level, non-slippery surface.
- No objects should be placed between the base of jack and the ground, or between the jack and the attachment bar on the vehicle.
- The jack must correctly engage the jack attachment.
- Never allow any part of your body to be extended under a vehicle supported by a jack.

### Power brakes function only when the engine is running

The power brakes utilize vacuum pressure which is only created when the engine is running. Never let the vehicle roll to a stop with the engine switched off.

If the power brakes are not working, considerably higher pressure will be required on the brake pedal to compensate for the lack of power assistance. This can happen for example when towing your vehicle or if the engine is switched off when the vehicle is rolling. The brake pedal feels harder than usual.

### Water on brake discs and brake pads affects braking

Driving in rain and slush or passing through an automatic car wash can cause water to collect on the brake discs and pads. This will cause a delay in braking effect when the pedal is depressed. To avoid such a delay when the brakes are needed, depress the pedal occasionally when driving through rain, slush, etc. This will remove the water from the brakes. Check that brake application feels normal. This should also be done after washing or starting in very damp or cold weather.

### Severe strain on the brake system

The brakes will be subject to severe strain when driving in mountains or hilly areas, or when towing a trailer. Vehicle speed is usually slower, which means that the cooling of the brakes is less efficient than when driving on level roads. To reduce the strain on the brakes, shift into a lower gear and let the engine help with the braking. Do not forget that if you are towing a trailer, the brakes will be subjected to a greater than normal load.

### Cleaning the brake discs

Coatings of dirt and water on the brake discs may result in delayed brake function. This delay is minimized by cleaning the brake linings.

Cleaning the brake pads is advisable in wet weather, prior to long-term parking, and after the vehicle has been washed. Do this by

\* Option/accessory, for more information, see Introduction.





braking gently for a short period while the vehicle is moving.

## Related information

- Parking brake – general information (p. 254)
- Emergency Brake Assistance (EBA) (p. 253)
- Brakes – general (p. 250)
- Anti-lock braking system (ABS) (p. 252)

## Brakes – symbols

### Symbols in the instrument panel

Symbol	Specification
	Steady glow – Check the brake fluid level. If the level is low, fill with brake fluid and check for the cause of the brake fluid loss.
	Automatic function check: steady glow for two seconds when the engine is started.

### WARNING

If and come on at the same time and the brake level is below the **MIN** mark in the reservoir or if a brake system-related message is shown in the information display: **DO NOT DRIVE**. Have the vehicle towed to a trained and qualified Volvo service technician and have the brake system inspected.

### Related information

- Brakes – general (p. 250)
- Parking brake – general information (p. 254)

## Anti-lock braking system (ABS)

*The ABS system helps to improve vehicle control (stopping and steering) during severe braking conditions by limiting brake lockup.*

When the system "senses" impending lockup, braking pressure is automatically modulated in order to help prevent lockup that could lead to a skid.

The system performs a brief self-diagnostic test when the engine has been started and driver releases the brake pedal. Another automatic test may be performed when the vehicle first reaches a speed of approximately 6 mph (10 km/h). The brake pedal will pulsate several times and a sound may be audible from the ABS control module, which is normal.

### Related information

- Parking brake – general information (p. 254)
- Emergency Brake Assistance (EBA) (p. 253)
- Brakes – general (p. 250)



## Brake lights

The brake lights come on automatically when the brakes are applied.

## Adaptive brake lights

The adaptive brake lights activate in the event of sudden braking or if the ABS system is activated. This function causes an additional taillight on each side of the vehicle to illuminate to help alert vehicles traveling behind.

The adaptive brake lights activate if:

- The ABS system activates for more than approximately a half second
- In the event of sudden braking while the vehicle is moving at speeds above approximately 6 mph (10 km/h).

When the vehicle has come to a stop, the brake lights and additional taillights remain on for as long as the brake pedal is depressed or until braking force on the vehicle is reduced.

## Related information

- Brakes – general (p. 250)
- Parking brake – general information (p. 254)

## Emergency Brake Assistance (EBA)

EBA is designed to provide full brake effect immediately in the event of sudden, hard braking.

## Emergency Brake Assistance

The EBA system is activated by the speed with which the brake pedal is depressed.

When the EBA system is activated, the brake pedal will go down and pressure in the brake system immediately increases to the maximum level. Maintain full pressure on the brake pedal in order to utilize the system completely. EBA is automatically deactivated when the brake pedal is released.



### NOTE

- When the EBA system is activated, the brake pedal will go down and pressure in the brake system immediately increases to the maximum level. You must maintain full pressure on the brake pedal in order to utilize the system completely. There will be no braking effect if the pedal is released. EBA is automatically deactivated when the brake pedal is released.
- When the vehicle has been parked for some time, the brake pedal may sink more than usual when the engine is started. This is normal and the pedal will return to its usual position when it is released.

## Related information

- Parking brake – general information (p. 254)
- Brakes – general (p. 250)
- Anti-lock braking system (ABS) (p. 252)



## Parking brake – general information

The electric parking brake helps to keep the vehicle stationary when it is parked.

### Electric parking brake



Parking brake control

### NOTE

- A faint sound from the parking brake's electric motor can be heard when the parking brake is being applied. This sound can also be heard during the automatic function check of the parking brake.
- The brake pedal will move slightly when the electric parking brake is applied or released.

Connect an auxiliary battery if the battery voltage is too low, see Jump starting (p. 237).

### Parking on a hill

- If the vehicle is pointing uphill, turn the front wheels so that they point away from the curb.
- If the vehicle is pointing downhill, turn the front wheels so that they point toward the curb.

The parking brake should also be applied.

### Related information

- Parking brake – applying (p. 254)
- Parking brake – releasing (p. 255)
- Parking brake – symbols and messages (p. 257)
- Brakes – general (p. 250)

## Parking brake – applying

### Applying the electric parking brake



Parking brake control

1. Press firmly on the brake pedal.
2. Push the control.
  - > The  symbol in the instrument panel flashes while the parking brake is being applied and glows steadily when the parking brake has been fully applied.
3. Release the brake pedal and ensure that the vehicle is at a standstill.
4. When the vehicle is parked, the gear selector must be in position **P**.

### Low battery voltage

If the battery voltage is too low, the parking brake cannot be applied or released.



### NOTE

- In an emergency the parking brake can be applied when the vehicle is moving by holding in the control. Braking will be interrupted when the accelerator pedal is depressed or the control is released.
- An audible signal will sound during this procedure if the vehicle is moving at speeds above 6 mph (10 km/h).

### Related information

- Parking brake – general information (p. 254)
- Parking brake – releasing (p. 255)
- Parking brake – symbols and messages (p. 257)
- Brakes – general (p. 250)

## Parking brake – releasing

### Releasing the electric parking brake



*Parking brake control*

### Manual release

1. Fasten the seat belt.
2. Insert the remote key in the ignition slot and press the **START/STOP ENGINE** button (or press the **START/STOP ENGINE** button with a valid remote key in the passenger compartment on vehicles with the optional keyless drive).
3. Press firmly on the brake pedal.
4. Pull the parking brake control.

### Automatic release

1. Start the engine.

### NOTE

- For safety reasons, the parking brake is only released automatically if the engine is running and the driver is wearing a seat belt.
- The electric parking brake will be released immediately when the accelerator pedal is pressed and the gear selector is in position **D** or **R**.

2. Fasten the seat belt.
3. Move the gear selector to position **D** or **R** and press the accelerator pedal. The parking brake will release when the vehicle begins to move.

### Heavy load uphill

A heavy load, such as a trailer, can cause the vehicle to roll backward when the parking brake is released automatically on a steep incline. To help avoid this:

1. Keep the electric parking brake lever pushed in with the left hand while shifting into Drive with the right.
2. While pressing the accelerator pedal to pull away, release the parking brake lever only after the vehicle begins to move.

### Related information

- Parking brake – general information (p. 254)
- Parking brake – applying (p. 254)



## 08 Starting and driving



- Parking brake – symbols and messages (p. 257)
- Brakes – general (p. 250)



## Parking brake – symbols and messages

A text message can be erased by pressing briefly on the **OK** button on the turn signal lever.

### Symbol and messages in the instrument panel

Symbol	Message	Description/action
	"Message"	Read the message in the information display
		A flashing symbol indicates that the parking brake is being applied. If the symbol flashes in any other situation then this means that a fault has arisen. Read the message on the information display.
-	<b>Park brake not fully released</b>	A fault is preventing the parking brake from being released. Try to apply the parking brake and release it several times. If the problem persists, contact an authorized Volvo workshop. If you drive off with this error message showing, a warning signal sounds.
-	<b>Parking brake not applied</b>	A fault is preventing the parking brake from being applied. Try to apply the parking brake and release it several times. If the problem persists, contact an authorized Volvo workshop. If you drive off with this error message showing, a warning signal sounds.
-	<b>Parking brake Service required</b>	A fault has occurred. Try to apply and release. Contact a Volvo workshop if the fault remains

### **WARNING**

If the vehicle must be parked before the fault has been corrected, always put the gear selector in **P** and turn the wheels so that they point away from the curb if the vehicle is pointing uphill or toward the curb if it is pointing downhill.

### Related information

- Parking brake – general information (p. 254)
- Parking brake – applying (p. 254)
- Parking brake – releasing (p. 255)
- Brakes – general (p. 250)



## 08 Starting and driving

### Driving through water

The vehicle can be driven through water up to a depth of approximately 10 in. (25 cm), at a maximum speed of 6 mph (10 km/h).

- Take particular care when driving through flowing water.
- Clean the electrical connections for trailer wiring after driving in mud or water.
- When driving through water, maintain low speed and do not stop in the water.

#### WARNING

- Avoid driving through standing or rushing water. Doing so can be dangerous and it may also be difficult to determine the actual depth of the water.
- If water cannot be avoided, after driving through the water, press lightly on the brake pedal to ensure that the brakes are functioning normally. Water or mud can make the brake linings slippery, resulting in delayed braking effect.

#### CAUTION

- Engine damage will occur if water is drawn into the air cleaner.
- If the vehicle is driven through water deeper than 10 in (25 cm), water may enter the differential and the transmission. This reduces the oil's lubricating capacity and may shorten the service life of these components.
- Damage to any components, the engine, transmission, turbo-charger, differential or its internal components caused by flooding, vapor lock or insufficient oil is not covered under warranty.
- Do not allow the vehicle to stand in water up to the door sills longer than absolutely necessary. This could result in electrical malfunctions.
- If the engine has been stopped while the vehicle is in water, do not attempt to restart it. Have the vehicle towed out of the water.

#### Related information

- Towing the vehicle (p. 268)
- Towing by tow truck (p. 270)

### Engine and cooling system

*Under special conditions, for example when driving in hilly terrain, extreme heat or with heavy loads, there is a risk that the engine and cooling system will overheat.*

Proceed as follows to avoid overheating the engine.

- Maintain a low speed when driving with a trailer up long, steep hills. For information, see Towing a trailer (p. 266)
- Do not turn the engine off immediately when stopping after a hard drive.

#### WARNING

The cooling fan may start or continue to operate (for up to 6 minutes) after the engine has been switched off.

- Remove any auxiliary lights from in front of the grille when driving in hot weather conditions.
- Do not exceed engine speeds of 4500 rpm if driving with a trailer in hilly terrain. The oil temperature could become too high.



### Conserving electrical current

Keep the following in mind to help minimize battery drain:

- When the engine is not running, avoid using ignition mode **II**. Many electrical systems (the audio system, the optional navigation system, power windows, etc) will function in ignition modes **0** and **I**. These modes reduce drain on the battery.
- Please keep in mind that using systems, accessories, etc., that consume a great deal of current when the engine is not running could result in the battery being completely drained. Driving or having the engine running for approximately 15 minutes will help keep the battery charged.
- The optional 12-volt socket in the trunk (p. 135) area provides electrical current even with the ignition switched off, which drains the battery.

### Before a long distance trip

*It is always worthwhile to have your vehicle checked by a trained and qualified Volvo service technician before driving long distances. Your retailer will also be able to supply you with bulbs, fuses, spark plugs and wiper blades for your use in the event that problems occur.*

As a minimum, the following items should be checked before any long trip:

- Check that engine runs smoothly and that fuel consumption is normal.
- Check for fuel, oil, and fluid leakage.
- Have the transmission oil level (p. 361) checked.
- Check condition of drive belts.
- Check state of the battery's charge.
- Examine tires carefully (the spare tire as well), and replace those that are worn (p. 275). Check tire pressure (p. 282).
- The brakes, front wheel alignment, and steering gear should be checked by a trained and qualified Volvo service technician only.
- Check all lights, including high beams.
- Reflective warning triangles are legally required in some states/provinces.
- Have a word with a trained and qualified Volvo service technician if you intend to

drive in countries where it may be difficult to obtain the correct fuel.

- Consider your destination. If you will be driving through an area where snow or ice are likely to occur, consider snow tires (p. 290).

### Related information

- Changing a wheel – removing wheel (p. 276)
- Bulbs – introduction (p. 318)



### Driving in cold weather

Check your vehicle before the approach of cold weather.

The following advice is worth noting:

- Make sure that the engine coolant (p. 315) contains 50 percent anti-freeze. Any other mixture will reduce freeze protection. This gives protection against freezing down to  $-31\text{ }^{\circ}\text{F}$  ( $-35\text{ }^{\circ}\text{C}$ ). The use of "recycled" antifreeze is not approved by Volvo. Different types of antifreeze must not be mixed.
- Volvo recommends using only genuine Volvo antifreeze in your vehicle's radiator.
- Try to keep the fuel tank well filled – this helps prevent the formation of condensation in the tank. In addition, in extremely cold weather conditions it is worthwhile to add fuel line de-icer before refueling.
- The viscosity of the engine oil is important. Oil with low viscosity (thinner oil) improves cold-weather starting as well as decreasing fuel consumption while the engine is warming up. Full synthetic 0W-30 oil is recommended for driving in areas with sustained low temperatures.
- The load placed on the battery is greater during the winter since the windshield wipers, lighting, etc., are used more often. Moreover, the capacity of the battery decreases as the temperature drops. In very cold weather, a poorly charged battery can freeze and be damaged. It is

therefore advisable to check the state of charge more frequently and spray an anti-rust oil on the battery posts.

- Volvo recommends the use of snow tires on all four wheels for winter driving, see Snow tires/studded tires (p. 290).
- To prevent the washer fluid (p. 328) reservoir from freezing, add washer solvents containing antifreeze. This is important since dirt is often splashed on the windshield during winter driving, requiring the frequent use of the washers and wipers. Volvo Washer Solvent should be diluted as follows: Down to  $14\text{ }^{\circ}\text{F}$  ( $-10\text{ }^{\circ}\text{C}$ ): 1 part washer solvent and 4 parts water Down to  $5\text{ }^{\circ}\text{F}$  ( $-15\text{ }^{\circ}\text{C}$ ): 1 part washer solvent and 3 parts water Down to  $0\text{ }^{\circ}\text{F}$  ( $-18\text{ }^{\circ}\text{C}$ ): 1 part washer solvent and 2 parts water Down to  $-18\text{ }^{\circ}\text{F}$  ( $-28\text{ }^{\circ}\text{C}$ ): 1 part washer solvent and 1 part water.
- Use Volvo Teflon Lock Spray in the locks.
- Avoid using de-icing sprays as they can cause damage to the locks.

### Refueling – fuel requirements

Volvo recommends the use of detergent gasoline to control engine deposits.

#### Deposit control gasoline (detergent additives)

Detergent gasoline is effective in keeping injectors and intake valves clean. Consistent use of deposit control gasolines will help ensure good drivability and fuel economy. If you are not sure whether the gasoline contains deposit control additives, check with the service station operator.



#### NOTE

Volvo does not recommend the use of external fuel injector cleaning systems.

#### Unleaded fuel

Each Volvo has a three-way catalytic converter and must use only unleaded gasoline. U.S. and Canadian regulations require that pumps delivering unleaded gasoline be labeled "UNLEADED". Only these pumps have nozzles which fit your vehicle's filler inlet. It is unlawful to dispense leaded fuel into a vehicle labeled "unleaded gasoline only". Leaded gasoline damages the three-way catalytic converter and the heated oxygen sensor system. Repeated use of leaded gasoline will lessen the effectiveness of the emission control system (p. 264) and could



result in loss of emission warranty coverage. State and local vehicle inspection programs will make detection of misfueling easier, possibly resulting in emission test failure for mis-fueled vehicles.

### **i** NOTE

Some U.S. and Canadian gasolines contain an octane enhancing additive called methyl-cyclopentadienyl manganese tricarbonyl (MMT). If such fuels are used, your Emission Control System performance may be affected, and the Check Engine Light (malfunction indicator light) located on your instrument panel may light. If this occurs, please return your vehicle to a trained and qualified Volvo service technician for service.

### **Gasoline containing alcohol and ethers, "Oxygenated fuels"**

Some fuel suppliers sell gasoline containing "oxygenates" which are usually alcohols or ethers. In some areas, state or local laws require that the service pump be marked indicating use of alcohols or ethers. However, there are areas in which the pumps are unmarked. If you are not sure whether there is alcohol or ethers in the gasoline you buy, check with the service station operator. To meet seasonal air quality standards, some areas require the use of "oxygenated" fuel.

Volvo allows the use of the following "oxygenated" fuels; however, the octane ratings (p. 261) listed must still be met.

#### **Alcohol – Ethanol**

Fuels containing up to 10% ethanol by volume may be used. Ethanol may also be referred to as Ethyl alcohol, or "Gasohol".

Ethers – MTBE: Fuels containing up to 15% MTBE may be used.

#### **Methanol**

Do not use gasolines containing methanol (methyl alcohol, wood alcohol). This practice can result in vehicle performance deterioration and can damage critical parts in the fuel system. Such damage may not be covered under the New Vehicle Limited Warranty.

### **Refueling – octane rating**

*Volvo recommends premium fuel for best performance, but using 87 octane<sup>11</sup> or above will not affect engine reliability.*

#### **Minimum octane**



*Typical pump octane label*

### **i** NOTE

Vehicles equipped with the high performance 4-cylinder engines (B4204T9 and B4204T10) require premium fuel<sup>12</sup>.

#### **TOP TIER Detergent Gasoline**

Volvo endorses the use of "TOP TIER Detergent Gasoline" where available to help maintain engine performance and reliability. TOP TIER Detergent Gasoline meets a new stand-

<sup>11</sup> AKI (ANTI KNOCK INDEX) is an average of the Research Octane Number (RON) and the Motor Octane Number (MON), MON+RON/2.

<sup>12</sup> Refer to your Warranty and Maintenance Records booklet for additional information.





# 08 Starting and driving



ard jointly established by leading automotive manufactures to meet the needs of today's advanced engines. Qualifying gasoline retailers (stations) will, in most cases, identify their gasoline as having met the "TOP TIER Detergent Gasoline" standards.

## NOTE

Information about TOP TIER Detergent Gasoline is available at [www.toptiergas.com](http://www.toptiergas.com).

## Demanding driving

In demanding driving conditions, such as operating the vehicle in hot weather, towing a trailer, or driving for extended periods at higher altitudes than normal, it may be advisable to switch to higher octane fuel (91 or higher) or to change gasoline brands to fully utilize your engine's capacity, and for the smoothest possible operation.

## NOTE

When switching to higher octane fuel or changing gasoline brands, it may be necessary to fill the tank more than once before a difference in engine operation is noticeable.

## Fuel Formulations

Do not use gasoline that contains lead as a knock inhibitor, and do not use lead additives. Besides damaging the exhaust emis-

sion control systems on your vehicle, lead has been strongly linked to certain forms of cancer.

Many fuels contain benzene as a solvent. Unburned benzene has been strongly linked to certain forms of cancer. If you live in an area where you must fill your own gas tank, take precautions. These may include:

- standing upwind away from the filler nozzle while refueling
- refueling only at gas stations with vapor recovery systems that fully seal the mouth of the filler neck during refueling
- wearing neoprene gloves while handling a fuel filler nozzle.

## Use of Additives

With the exception of gas line antifreeze during winter months, do not add solvents, thickeners, or other store-bought additives to your vehicle's fuel, cooling, or lubricating systems. Overuse may damage your engine, and some of these additives contain organically volatile chemicals. Do not needlessly expose yourself to these chemicals.

## WARNING

Never carry a cell phone that is **switched on** while refueling your vehicle. If the phone rings, this may cause a spark that could ignite gasoline fumes, resulting in fire and injury.

## WARNING

Carbon monoxide is a poisonous, colorless, and odorless gas. It is present in all exhaust gases. If you ever smell exhaust fumes inside the vehicle, make sure the passenger compartment is ventilated, and immediately return the vehicle to a trained and qualified Volvo service technician for correction.

## Related information

- Refueling – fuel requirements (p. 260)



## Refueling – opening/closing fuel filler door

The fuel filler door is located on the right rear fender (indicated by an arrow beside the fuel tank symbol on the information display )



With the ignition switched off, press and release the button on the lighting panel to unlock the fuel filler door. Please note that the fuel filler door will remain unlocked until the vehicle begins to move forward. An audible click will be heard when the fuel filler door relocks.

- If you intend to leave your vehicle while it is being refueled, this feature enables you to lock the doors/trunk while leaving the fuel filler door unlocked.
- You can also keep the vehicle locked if you remain inside it during refueling. The central locking button does not lock the fuel filler door.

- Be sure the fuel filler door is not obstructed and is completely closed after refueling.
- Open the fuel filler cap slowly during hot weather.

Close the fuel filler door by pressing it; a click indicates that it is closed.

### CAUTION

Avoid spilling gasoline during refueling. In addition to causing damage to the environment, gasolines containing alcohol can cause damage to painted surfaces, which may not be covered under the New Vehicle Limited Warranty.

## Manually opening the fuel filler door



1. Open the side hatch in the trunk (on the same side as the fuel filler door).
2. Grasp the handle on the green cord.

3. Gently pull the cord straight rearward until the fuel filler door clicks open.

### Related information

- Refueling – opening/closing fuel cap (p. 264)
- Refueling – fuel requirements (p. 260)
- Refueling – octane rating (p. 261)



### Refueling – opening/closing fuel cap

If necessary, the fuel filler door can be opened manually.

#### Opening/closing the fuel cap



Fuel vapor expands in hot weather. Open the filler cap slowly.

After refueling, close the fuel filler cap by turning it clockwise until it clicks into place.



### CAUTION

- Do not refuel with the engine running<sup>13</sup>. Turn the ignition off or to position **I**. If the ignition is on, an incorrect reading could occur in the fuel gauge.
- Avoid overfilling the fuel tank. Do not press the handle on the filler nozzle more than one extra time. Too much fuel in the tank in hot weather conditions can cause the fuel to overflow. Overfilling could also cause damage to the emission control systems.

#### Related information

- Refueling – fuel requirements (p. 260)
- Refueling – octane rating (p. 261)

### Emission controls

#### Three-way catalytic converter

- Keep your engine properly tuned. Certain engine malfunctions, particularly involving the electrical, fuel or distributor ignition systems, may cause unusually high three-way catalytic converter temperatures. Do not continue to operate your vehicle if you detect engine misfire, noticeable loss of power or other unusual operating conditions, such as engine overheating or backfiring. A properly tuned engine will help avoid malfunctions that could damage the three-way catalytic converter.
- Do not park your vehicle over combustible materials, such as grass or leaves, which can come into contact with the hot exhaust system and cause such materials to ignite under certain wind and weather conditions.
- Excessive starter cranking (in excess of one minute), or an intermittently firing or flooded engine can cause three-way catalytic converter or exhaust system overheating.
- Remember that tampering or unauthorized modifications to the engine, the Engine Control Module, or the vehicle may be illegal and can cause three-way catalytic converter or exhaust system overheating. This includes: altering fuel

<sup>13</sup> If the fuel filler cap is not closed tightly or if the engine is running when the vehicle is refueled, the Check Engine Light (malfunction indicator lamp) may indicate a fault. However, your vehicle's performance will not be affected. Use only Volvo original or approved fuel filler caps.



injection settings or components, altering emission system components or location or removing components, and/or repeated use of leaded fuel.

### NOTE

Unleaded fuel is required for vehicles with three-way catalytic converters.

### Heated oxygen sensors

The heated oxygen sensors monitor the oxygen content of the exhaust gases. Readings are fed into a control module that continuously monitors engine functions and controls fuel injection. The ratio of fuel to air into the engine is continuously adjusted for efficient combustion to help reduce harmful emissions.

### Related information

- Information displays – warning symbols (p. 68)
- Engine and cooling system (p. 258)

### Economical driving

*Better driving economy may be obtained by thinking ahead, avoiding rapid starts and stops and adjusting the speed of your vehicle to immediate traffic conditions.*

### Economical driving conserves natural resources

#### Observe the following rules:

- Bring the engine to normal operating temperature as soon as possible by driving with a light foot on the accelerator pedal for the first few minutes of operation. A cold engine uses more fuel and is subject to increased wear.
- Whenever possible, avoid using the vehicle for driving short distances. This does not allow the engine to reach normal operating temperature.
- Drive carefully and avoid rapid acceleration and hard braking.
- Use the transmission's Drive (D) position as often as possible and avoid using kick-down.
- Using the engine's optional Eco function<sup>14</sup> can help improve fuel economy. For additional information, see ECO\* (p. 248).
- Do not exceed posted speed limits.
- Avoid carrying unnecessary items (extra load) in the vehicle.

- Maintain correct tire pressure. Check tire pressure regularly (when tires are cold).
- Remove snow tires when threat of snow or ice has ended.
- Note that roof racks, ski racks, etc, increase air resistance and also fuel consumption.
- At highway driving speeds, fuel consumption will be lower with the air conditioning on and the windows closed than with the air conditioning off and the windows open.
- Using the onboard trip computer's fuel consumption modes can help you learn how to drive more economically.

#### Other factors that decrease gas mileage are:

- Dirty air cleaner
- Dirty engine oil and clogged oil filter
- Dragging brakes
- Incorrect front end alignment

Some of the above mentioned items and others are checked at the standard maintenance intervals.

<sup>14</sup> Available on certain 4-cyl. engines





## WARNING

**Driving with the trunk open:** Driving with the trunk open could lead to poisonous exhaust gases entering the passenger compartment. If the trunk must be kept open for any reason, proceed as follows:

- Close the windows
- Set the ventilation system control to air flow to floor, windshield and side windows and the blower control to its highest setting.

## Handling and roadholding

At the specified curb weight your vehicle has a tendency to understeer, which means that the steering wheel has to be turned more than might seem appropriate for the curvature of a bend. This ensures good stability and reduces the risk of rear wheel skid. Remember that these properties can alter with the vehicle load. The heavier the load in the trunk, the less the tendency to understeer.

- Vehicle load, tire design and inflation pressure all affect vehicle handling. Therefore, check that the tires are inflated to the recommended pressure according to the vehicle load. Loads should be distributed so that capacity weight or maximum permissible axle loads are not exceeded.
- At the specified curb weight your vehicle has a tendency to understeer, which

means that the steering wheel has to be turned more than might seem appropriate for the curvature of a bend. This ensures good stability and reduces the risk of rear wheel skid. Remember that these properties can alter with the vehicle load. The heavier the load in the trunk, the less the tendency to understeer.

## Related information

- Climate – general information (p. 118)

## Towing a trailer

*When towing a trailer, always observe the legal requirements of the state/province.*

## NOTE

For the maximum trailer and tongue weights recommended by Volvo, see Weights (p. 355).

- All Volvo models are equipped with energy-absorbing shock-mounted bumpers. Trailer hitch installation should not interfere with the proper operation of this bumper system.

Trailer towing does not normally present any particular problems, but take into consideration:

- Increase tire pressure to recommended full pressure, see Tire inflation – pressure table (p. 285).
- When your vehicle is new, avoid towing heavy trailers during the first 620 miles (1,000 km).
- Maximum speed when towing a trailer: 50 mph (80 km/h).
- Engine and transmission are subject to increased loads. Therefore, engine coolant temperature should be closely watched when driving in hot climates or hilly terrain. Use a lower gear and turn off the air conditioner if the temperature gauge needle enters the red range.



- If the automatic transmission begins to overheat, a message will be displayed in the text window.
- Avoid overload and other abusive operation.
- Hauling a trailer affects handling, durability, and economy.
- It is necessary to balance trailer brakes with the towing vehicle brakes to provide a safe stop (check and observe state/local regulations).
- Do not connect the trailer's brake system directly to the vehicle's brake system.
- More frequent vehicle maintenance is required.
- Remove the ball holder when the hitch is not being used.



### WARNING

- Bumper-attached trailer hitches must not be used on Volvos, nor should safety chains be attached to the bumper.
- Trailer hitches attaching to the vehicle rear axle must not be used.
- Never connect a trailer's hydraulic brake system directly to the vehicle brake system, nor a trailer's lighting system directly to the vehicle lighting system. Consult your nearest authorized Volvo retailer for correct installation.
- When towing a trailer, the trailer's safety chains or wire must be correctly fastened to the attachment points provided in the trailer hitch on the vehicle. The safety chain or wire must never be fastened to or wound around the towing ball.



### NOTE

- When parking the vehicle with a trailer on a hill, apply the parking brake before putting the gear selector in **P**. Always follow the trailer manufacturer's recommendations for wheel chocking.
- When starting on a hill, put the gear selector in **D** before releasing the parking brake.
- If you use the manual (Geartronic) shift positions while towing a trailer, make sure the gear you select does not put too much strain on the engine (using too high a gear).
- The drawbar assembly/trailer hitch may be rated for trailers heavier than the vehicle is designed to tow. Please adhere to Volvo's recommended trailer weights.
- Avoid driving with a trailer on inclines of more than 15%.

### Trailer cable

An adapter is required if the vehicle's trailer hitch has a 13-pin connector and the trailer has 7 pins. Use an adapter cable approved by Volvo. Make sure the cable does not drag on the ground.

### Related information

- Loading – general (p. 136)



### Trailer Stability Assist (TSA)

*Trailer Stability Assist is a system designed to help stabilize a vehicle that is towing a trailer when the vehicle and trailer have begun to sway and is part of the stability system. For information on the stability system, see Stability system – introduction (p. 162)*

#### Function

A vehicle towing a trailer may begin to sway for various reasons. Normally this only occurs at high speeds but, for example, if the trailer is overloaded or if the load is unevenly distributed in the trailer, there is risk of swaying at speeds between approximately 45-55 mph (70-90 km/h).

Swaying may be caused by factors such as:

- The vehicle and trailer are hit by a sudden, strong crosswind
- The vehicle and trailer are traveling on an uneven road surface or drive over a bump
- Sudden movements of the steering wheel

#### Facts about TSA

- TSA intervenes at speeds above approximately 40 mph (60 km/h)
- The stability system symbol in the instrument panel will flash when TSA is working
- If the driver switches off the stability system's Spin Control function, TSA will also be switched off (but will be on again the next time the engine is started)

- TSA may not intervene when the vehicle and trailer begin to sway if the driver tries to compensate for the swaying motion by moving the steering wheel rapidly

#### How TSA works

Once swaying has begun, it can be very difficult to stop, which makes it difficult to control the vehicle and trailer.

The TSA system continuously monitors the vehicle's movements, particularly lateral movement. If the system detects a tendency to sway, the brakes are applied individually on the front wheels, which has a stabilizing effect on the vehicle and trailer. This is often enough to enable the driver to regain control of the vehicle.

If this is not adequate to stop the swaying motion, the brakes are applied to all of the wheels on the vehicle and on the trailer if it is equipped with brakes, and engine power is temporarily reduced. As the swaying motion begins to decrease and the vehicle-trailer have once again become stable, TSA will now stop regulating the brakes/engine power and the driver regains control of the vehicle.

#### Related information

- Towing a trailer (p. 266)
- Loading – general (p. 136)

### Towing the vehicle

*Always check with state and local authorities before attempting to tow another vehicle because this type of towing is subject to regulations regarding maximum towing speed, length and type of towing device, lighting, etc.*



1. With the remote key fully pressed into the ignition slot<sup>15</sup>, press **START/STOP ENGINE** for approximately 2 seconds to activate ignition mode **II**.
2. The remote key must remain in the ignition slot<sup>16</sup> for the entire time that the vehicle is being towed.
3. Keep the tow rope taut when the towing vehicle slows down by applying light pressure on the brake pedal. This will help prevent jarring movements of the vehicle being towed.
4. Be prepared to apply the brakes to stop the vehicle being towed.

### **!** CAUTION

General towing precautions:

- Please check with state and local authorities before attempting this type of towing, as vehicles being towed are subject to regulations regarding maximum towing speed, length and type of towing device, lighting, etc.
- If the vehicle's battery is dead, see Jump starting (p. 237) to provide current for releasing the electric parking brake and to move the gear selector from the **P** position to **N**. If this is not possible, see Transmission – shiftlock override (p. 242) for information about manually overriding the shiftlock system to move the gear selector from **P** to **N**.
- Maximum speed: 50 mph (80 km/h). Do not exceed the maximum allowable towing speed.
- Maximum distance with front wheels on ground: 50 miles (80 km).
- The vehicle should only be towed in the forward direction.

### Related information

- Towing eyelet (p. 269)
- Remote key – functions (p. 143)

<sup>15</sup> Not necessary in vehicles with the optional keyless drive.

<sup>16</sup> For vehicles with the optional keyless drive, the remote key must be in the vehicle.

### Towing eyelet

When used, the towing eyelet should always be securing attached.

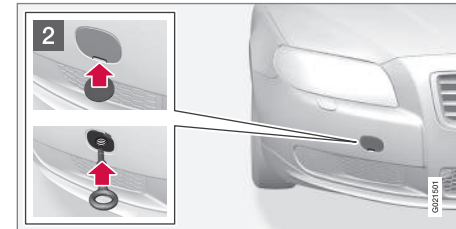
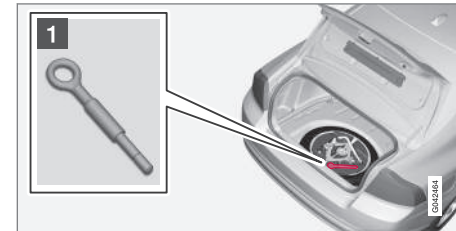

Attaching the towing eyelet

### Attaching the towing eyelet

- 1 The towing eyelet is located under the floor of the trunk, with the spare tire. This eyelet must be screwed into the positions provided on the right sides of either the front or rear bumper (see illustration).



- 2 There are two different types of covers over the openings for the towing eyelet and they have to be opened differently.
- If the cover has a notch, insert a coin, etc., into the notch and pry open the edge of the cover. Open the cover completely and remove it.
  - If the cover has a mark along one edge or in a corner, press the mark while prying out the opposite side/corner using a coin, etc. Open the cover and remove it.

Screw the towing eyelet in place, first by hand and then using the tire iron until it is securely in place.

After the vehicle has been towed, the eyelet should be removed and returned to its storage location.

Press the cover for the attachment point back into position.



### WARNING

- When the vehicle is being towed, the ignition should be in mode **II** (in mode **I**, all of the vehicle's airbags are deactivated). For more information, see Ignition modes (p. 73)
- Never remove the remote key from the ignition slot when the vehicle is being towed. For vehicles with keyless drive, the remote key must remain inside the vehicle.
- The power brakes and power steering will not function when the engine is not running. Approximately 5 times more pressure will be required on the brake pedal and the steering wheel will be considerably harder to turn.
- The towing eyelets must not be used for pulling the vehicle out of a ditch or for any similar purpose involving severe strain.

### Related information

- Towing the vehicle (p. 268)
- Towing by tow truck (p. 270)

### Towing by tow truck

*When necessary, call for professional help from an authorized towing company. Volvo recommends the use of flat bed equipment.*



### CAUTION

**In certain conditions, the towing eyelet may be used to pull the vehicle onto a flatbed tow truck.**

- The vehicle's position and ground clearance determine if it can be pulled up onto a flatbed tow truck using the towing eyelet.
- If the angle of the tow truck's ramp is too steep or the ground clearance under the vehicle is insufficient, damage could occur by attempting to pull the vehicle using the towing eyelet.
- If necessary, lift the vehicle using the tow truck's lifting device.



### WARNING

No person or object should be behind the tow truck while the vehicle is being pulled up onto the flatbed.



### CAUTION

- The vehicle should always be towed in the forward direction.
- Vehicles with All Wheel Drive (AWD)\* that are being towed with the front wheels off the ground should not be towed at a speed above approx. 45 mph (70 km/h) and should not be towed farther than 30 miles (50 km).

### Related information

- Towing eyelet (p. 269)

# 09



## WHEELS AND TIRES

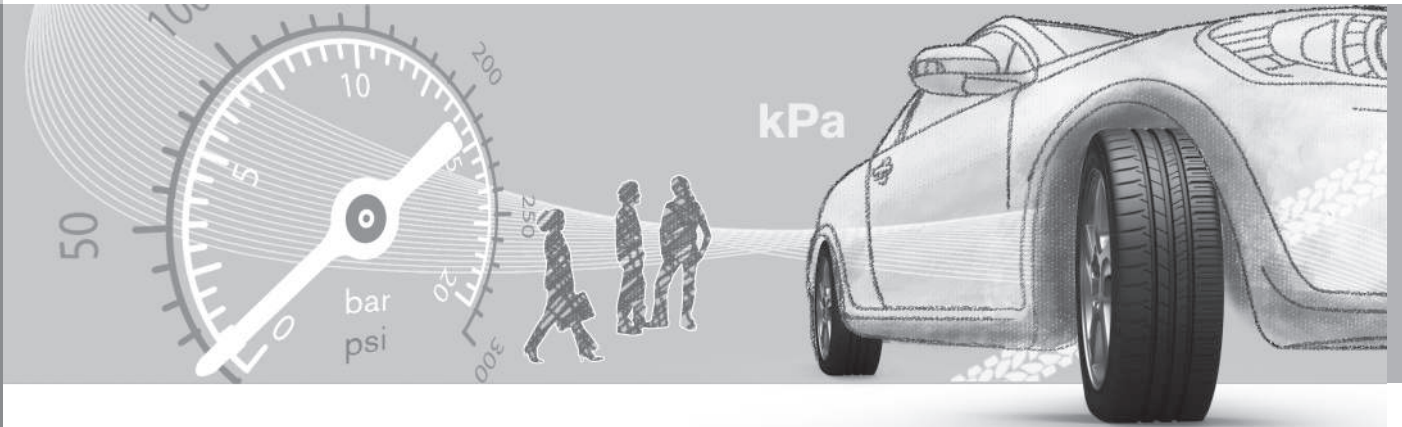



## Tires – general information

Your vehicle is equipped with tires according to the vehicle's tire information placard on the B-pillar (the structural member at the side of the vehicle, at the rear of the driver's door opening).

### Introduction

#### CAUTION

Some Volvo models are equipped with an Ultra High Performance tire and wheel combination designed to provide maximum dry pavement performance with consideration for hydroplaning resistance. They may be more susceptible to road hazard damage and, depending on driving conditions, may achieve a tread life of less than 20,000 miles (30,000 km). Even if this vehicle is equipped with Volvo's advanced AWD or stability system, these tires are not designed for winter driving, and should be replaced with winter tires when weather conditions dictate.

The tires have good road holding characteristics and offer good handling on dry and wet surfaces. It should be noted however that the tires have been developed to give these features on snow/ice-free surfaces.

Most models are equipped with "all-season" tires, which provide a somewhat higher degree of road holding on slippery surfaces than tires without the "all-season" rating.

However, for optimum road holding on icy or snow-covered roads, we recommend suitable winter tires on all four wheels.

When replacing tires, be sure that the new tires are the same size designation, type (radial) and preferably from the same manufacturer, on all four wheels. Otherwise there is a risk of altering the car's roadholding and handling characteristics.

### Tire rotation

Your vehicle has no required tire rotation. Tire wear is affected by a number of factors such as tire inflation, ambient temperature, driving style, etc.

#### NOTE

- If the tires are rotated, they should only be moved from front to rear or vice versa. They should never be rotated left to right/right to left.
- Ideally, tire rotation should be done the first time after approximately 3,000 miles (5,000 km) and thereafter at 6,000-mile (10,000-km) intervals. Some customers find that tire rotation may help to get extra mileage from tire life.
- Tire rotation should only be performed if front/rear tire wear is fairly even and tread height is above 1/16" (1.6 mm).

### Related information

- Tire inflation – pressure table (p. 285)
- Tire specifications (p. 283)
- Changing a wheel – direction of rotation (p. 276)
- Tires – tread wear indicator (p. 275)



## Tires – storage and age

When storing complete wheels (tires mounted on rims), they should be suspended off the floor or placed on their sides on the floor.

### New Tires

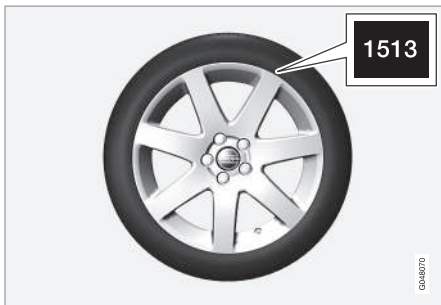

Remember that tires are perishable goods. As of 2000, the manufacturing week and year (Department of Transportation (DOT) stamp) will be indicated with 4 digits (e.g., 1513 means that the tire illustrated was manufactured during week 15 of 2013).

### Tire age

Tires degrade over time, even when they are not being used. It is recommended that tires generally be replaced after 6 years of normal service. Heat caused by hot climates, frequent high loading conditions or Ultra Violet (U.V.) exposure can accelerate the aging

process. The temporary spare<sup>1</sup> should also be replaced at 6-year intervals, even if it has never been used.

A tire's age can be determined by the DOT stamp on the sidewall (see the illustration).

A tire with e.g., visible cracks or discoloration should be replaced immediately.

### Storing wheels and tires

When storing complete wheels (tires mounted on rims), they should be suspended off the floor or placed on their sides on the floor.

Tires not mounted on rims should be stored on their sides or standing upright, but should not be suspended.



### CAUTION

Tires should preferably be stored in a cool, dry, dark place, and should never be stored in close proximity to solvents, gasoline, oils, etc.



### WARNING

- The wheel and tire sizes for your Volvo are specified to meet stringent stability and handling requirements. Unapproved wheel/tire size combinations can negatively affect your vehicle's stability and handling.
- Any damage caused by installation of unapproved wheel/tire size combinations will not be covered by your new vehicle warranty. Volvo assumes no responsibility for death, injury, or expenses that may result from such installations.

### Related information

- Tire inflation – pressure table (p. 285)
- Tire specifications (p. 283)
- Tire specifications (p. 283)
- Changing a wheel – direction of rotation (p. 276)
- Tires – tread wear indicator (p. 275)

<sup>1</sup> Option or accessory on some models



### Tires – tread wear indicator

The tires have wear indicator strips running across or parallel to the tread.

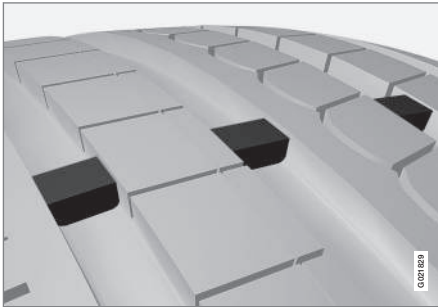

The letters **TWI** are printed on the side of the tire. When approximately 1/16" (1.6 mm) is left on the tread, these strips become visible and indicate that the tire should be replaced. Tires with less than 1/16" (1.6 mm) tread offer very poor traction.

When replacing worn tires, it is recommended that the tire be identical in type (radial) and size as the one being replaced. Using a tire of the same make (manufacturer) will prevent alteration of the driving characteristics of the vehicle.

### Related information

- Tire inflation – pressure table (p. 285)
- Tire specifications (p. 283)

- Changing a wheel – direction of rotation (p. 276)
- Tires – storage and age (p. 274)

### Tires – tire economy

A smooth driving style and correct inflation pressure can help prolong the tires' service life.

- Maintain correct tire pressure. The tire inflation table, see Tire inflation – pressure table (p. 285).
- Avoid fast starts, hard braking and tire screeching.
- Tire wear increases with speed.
- Correct front wheel alignment is very important.
- Unbalanced wheels impair tire economy and driving comfort.
- Tires must maintain the same direction of rotation throughout their lifetime.
- When replacing tires, the tires with the most tread should be mounted on the rear wheels to reduce the chance of over-steer during hard braking.
- Hitting curbs or potholes can damage the tires and/or wheels permanently.



## Changing a wheel – direction of rotation

*Incorrectly mounted tires impair the car's braking properties and ability to force aside rain, snow and slush.*

### Summer and winter tires

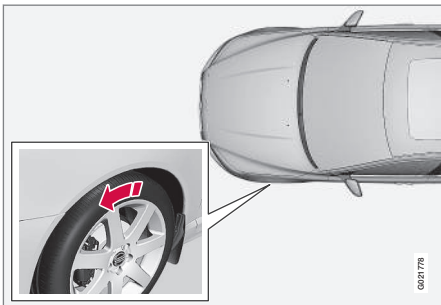

*The arrows shows the direction of rotation of the tire*

- The tires with the most tread should always be on the rear axle (to help reduce the risk of skidding).
- When switching between summer and winter tires, mark the tires to indicate where they were mounted on the car, e.g., LF = left front, RR = right rear
- Tires with tread designed to roll in only one direction are marked with an arrow on the sidewall.
- Contact a Volvo workshop if you are unsure about the tread depth.

### Related information

- Tire inflation – pressure table (p. 285)
- Tire specifications (p. 283)
- Tires – storage and age (p. 274)
- Tires – tread wear indicator (p. 275)

## Changing a wheel – removing wheel

*Wheel changes should always be carried out correctly.*

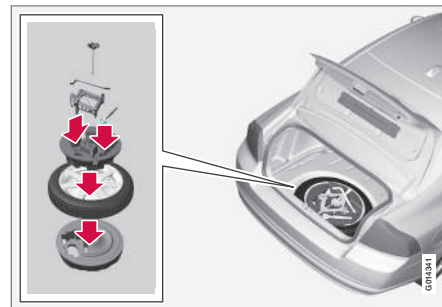

*Location of jack and tools*

### Changing a wheel

1. Apply the parking brake and put the gear selector in **P**.
2. Take out the jack\*, lug wrench\*, the tool for removing the plastic covers on the wheel nuts, the towing eyelet and the wheel cover removal tool (certain models only) stowed under the floor of the trunk.



3.



Tool for removing the plastic covers on the wheel nuts

Remove the wheel cover (where applicable) using the removal tool or remove the wheel cover by hand.

4. Block the wheels that are on the ground with wooden blocks or large stones.

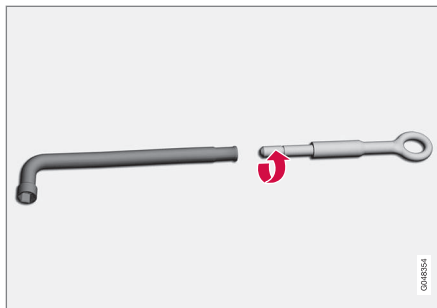

Lug wrench and towing eyelet

5. Screw the towing eyelet into the lug wrench as shown in the illustration.

**CAUTION**

The towing eyelet must be screwed into the lug wrench as far as possible.

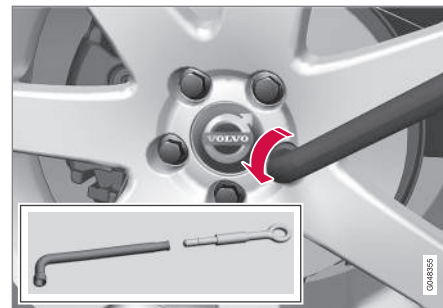

6. With the vehicle still on the ground, remove the plastic covers on the wheel nuts with the tool provided and use the lug wrench/towing eyelet to loosen the wheel nuts  $\frac{1}{2}$  - 1 turn by exerting downward (counterclockwise) pressure.

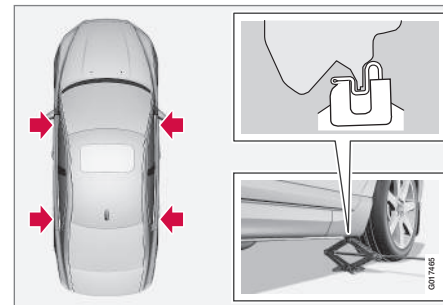

Jack attachment points



- 09
7. There are two jack attachment points on each side of the vehicle. Position the jack correctly in the attachment (see the illustration) and crank while simultaneously guiding the base of the jack to the ground. The base of the jack must be flat on a level, firm, non-slippery surface. Before raising the vehicle, check that the jack is still correctly positioned in the attachment.
  8. Raise the vehicle until the wheel to be changed is lifted off the ground.
  9. Unscrew the wheel nuts completely and remove the wheel.



### WARNING

- The jack must correctly engage the jack attachment.
- Be sure the jack is on a firm, level, non-slippery surface.
- Never allow any part of your body to be extended under a vehicle supported by a jack.
- Use the jack intended for the vehicle when changing a tire. For any other job, use stands to support the vehicle.
- Apply the parking brake and put the gear selector in the Park (P) position.
- Block the wheels standing on the ground, use rigid wooden blocks or large stones.
- The jack should be kept well-greased and clean, and should not be damaged.
- No objects should be placed between the base of jack and the ground, or between the jack and the attachment bar on the vehicle.



### NOTE

The jack provided with your vehicle is intended to be used only in temporary situations such as changing wheels in the event of a flat tire. Only the jack that came with your particular model should be used to lift the vehicle. If the vehicle needs to be lifted more frequently or for a prolonged period, using a garage jack or hoist is recommended. Always follow this device's instructions for use.

### Related information

- Changing a wheel – installing a wheel (p. 280)



## Changing a wheel – spare wheel

Wheel changes should always be carried out correctly.

## Spare tire

The spare tire in your vehicle<sup>2</sup> is called a "Temporary Spare".

Recommended tire pressure (see the placard on the B-pillar or on the fuel filler door) should be maintained irrespective of which position on the vehicle the temporary spare tire is used on.

In the event of damage to this tire, a new one can be purchased from your Volvo retailer.

### WARNING

Current legislation prohibits the use of the "Temporary Spare" tire other than as a temporary replacement for a punctured tire. It must be replaced as soon as possible by a standard tire. Road holding and handling may be affected with the "Temporary Spare" in use. Do not exceed 50 mph (80 km/h).

### CAUTION

The vehicle must not be driven with wheels of different dimensions or with a spare tire other than the one that came with the vehicle. The use of different size wheels can seriously damage your car's transmission.

## Spare wheel

The spare wheel is only intended for temporary use. Replace it with a normal wheel as soon as possible. The car's handling may be altered by the use of the spare wheel. The correct tire pressure for the spare wheel is stated in the tire pressure table, see Tire inflation – pressure table (p. 285) and in the tire inflation placard on the driver's side door jamb at the rear of the driver's door opening.

### WARNING

Current legislation prohibits the use of the "Temporary Spare" tire other than as a temporary replacement for a punctured tire. It must be replaced as soon as possible by a standard tire. Road holding and handling may be affected with the "Temporary Spare" in use.

### CAUTION

The vehicle must never be driven with more than one temporary spare wheel.

The spare wheel is located in the spare wheel well with the rim side down. There are two foam blocks, one under the spare wheel and one over/inside. The upper one contains all tools.

The same bolt runs through to secure the spare wheel and the foam blocks.

## Related information

- Changing a wheel – installing a wheel (p. 280)
- Changing a wheel – removing wheel (p. 276)

<sup>2</sup> Not on models equipped with the Tire sealing system.



## Changing a wheel – accessing the spare wheel

The following procedure explains how to access the spare wheel (where applicable).

1. Open the floor hatch.
2. Undo the retaining bolt.
3. Lift out the foam block.
4. Lift out the spare wheel.

The other two blocks can remain in the spare wheel well.

### After use

The foam block and spare wheel must be replaced in the reverse order. Note the arrow on the upper foam block. It should point forward.

## Changing a wheel – installing a wheel

It is important to re-install wheels properly.

### Re-installing the wheel

1. Clean the contact surfaces on the wheel and hub.
2. Lift the wheel and place it on the hub.



Tighten the wheel nuts

3. Install the wheel nuts and tighten hand-tight. Using the lug wrench, tighten crosswise until all nuts are snug.
4. Lower the vehicle to the ground and alternately tighten the bolts crosswise to 103 ft. lbs. (140 Nm).
5. Press the plastic covers onto the wheel nuts and Install the wheel cover (where applicable). The opening in the wheel cover for the tire's inflation valve must be positioned over the valve.

### Related information

- Changing a wheel – spare wheel (p. 279)
- Changing a wheel – removing wheel (p. 276)



## Tire inflation – general information

Check tire inflation pressure regularly.

### Inflation placard

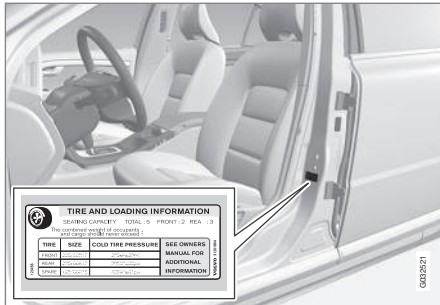

Tire inflation placard

### Tire inflation

See the tire inflation table in Tire inflation – pressure table (p. 285). A tire inflation pressure placard is also located on the driver's side B-pillar (the structural member at the side of the vehicle, at the rear of the driver's door opening). This placard indicates the designation of the factory-mounted tires on your vehicle, as well as load limits and inflation pressure.

### NOTE

- The placards shown indicate inflation pressure for the tires installed on the vehicle at the factory only.
- A certain amount of air seepage from the tires occurs naturally and tire pressure fluctuates with seasonal changes in temperature. Always check tire pressure regularly.
- Use a tire gauge to check the tire inflation pressure, including the spare, at least once a month and before long trips. You are strongly urged to buy a reliable tire pressure gauge, as automatic service station gauges may be inaccurate.
- Use the recommended cold inflation pressure for optimum tire performance and wear.
- Under-inflation or over-inflation may cause uneven treadwear patterns.

### WARNING

- Under-inflation is the most common cause of tire failure and may result in severe tire cracking, tread separation, or "blow-out," with unexpected loss of vehicle control and increased risk of injury.
- Under-inflated tires reduce the load carrying capacity of your vehicle.

When weather temperature changes occur, tire inflation pressures also change. A 10-degree temperature drop causes a corresponding drop of 1 psi (7 kPa) in inflation pressure. Check your tire pressures frequently and adjust them to the proper pressure, which can be found on the vehicle's tire information placard or certification label.

### Related information

- Tire specifications (p. 283)
- Tires – storage and age (p. 274)
- Tires – tread wear indicator (p. 275)
- Tire inflation – pressure table (p. 285)



## Tire inflation – checking pressure

*Inflation pressure should be checked when the tires are cold.*

### Cold tires

**The tires are considered to be cold when they have the same temperature as the surrounding (ambient) air.**

This temperature is normally reached after the vehicle has been parked for at least 3 hours.

After driving a distance of approximately 1 mile (1.6 km), the tires are considered to be hot. If you have to drive farther than this distance to pump your tire(s), check and record the tire pressure first and add the appropriate air pressure when you get to the pump.

If checking tire pressure when the tire is hot, never "bleed" or reduce air pressure. The tires are hot from driving and it is normal for pressures to increase above recommended cold pressures. A hot tire at or below recommended cold inflation pressure could be significantly under-inflated.

### To check inflation pressure:

1. Remove the cap from the valve on one tire, then firmly press the tire gauge onto the valve.
2. Add air to reach the recommended air pressure.

3. Replace the valve cap.



### CAUTION

- After inflating the tires, always reinstall the valve cap to help avoid damage to the valve from dirt, gravel, etc.
- Use plastic valve caps only. Metal caps could corrode and become difficult to remove.

4. Visually inspect the tires to make sure there are no nails or other objects embedded that could puncture the tire and cause an air leak.
5. Check the sidewalls to make sure there are no gouges, cuts, bulges or other irregularities.
6. Repeat this procedure for each tire, including the spare.



### NOTE

- If you overfill the tire, release air by pushing on the metal stem in the center of the valve. Then recheck the pressure with your tire gauge.
- Some spare tires require higher inflation pressure than the other tires. Consult the tire inflation pressure table, see Tire inflation – pressure table (p. 285) or see the inflation pressure placard.

### Related information

- Tire specifications (p. 283)
- Tire inflation – pressure table (p. 285)
- Tires – storage and age (p. 274)
- Tires – tread wear indicator (p. 275)



## Tire specifications

The following information can be found on a tire's sidewall.

## Tire ratings

### Speed ratings

The speed ratings in the table translate as follows:

Speed ratings	
M	81 mph (130 km/h)
Q	100 mph (160 km/h)
T	118 mph (190 km/h)
H	130 mph (210 km/h)
V	149 mph (240 km/h)
W	168 mph (270 km/h)
Y	186 mph (300 km/h)

## Information on the sidewall

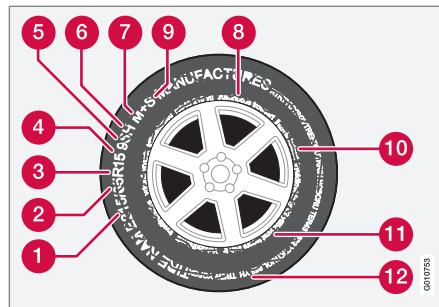

Federal law mandates that tire manufacturers place standardized information on the sidewall of all tires (see the illustration).

The following information is listed on the tire sidewall:

The tire designation:

### **i** NOTE

Please be aware that the following tire designation is an **example only** and that this particular tire may not be available on your vehicle.

- 215:** the width of the tire (in millimeters) from sidewall edge to sidewall edge. The larger the number, the wider the tire.
- 65:** The ratio of the tire's height to its width in percent.
- R:** Radial tire (the designation **RF** and the  symbol indicate that the vehicle is equipped with optional self-supporting run flat tires<sup>3</sup>. See Self-supporting run flat tires (SST) (p. 297) for more information about these tires).
- 15:** The diameter of the wheel rim (in inches).
- 95:** The tire's load index. In this example, a load index of 95 equals a maximum load of 1521 lbs (690 kg).
- H:** The tire's speed rating, or the maximum speed at which the tire is designed to be driven for extended periods of time, carrying a permissible load for the vehicle, and with correct inflation pressure. For example, H indicates a speed rating of 130 mph (210 km/h).

### **i** NOTE

The tire's load index and speed rating may not appear on the sidewall because they are not required by law.

<sup>3</sup> Self-supporting run flat tires may not be available on all models



- 09
7. **M+S or M/S** = Mud and Snow, **AT** = All Terrain, **AS** = All Season
  8. **U.S. DOT Tire Identification Number (TIN)**: This begins with the letters "DOT" and indicates that the tire meets all federal standards. The next two numbers or letters are the plant code where it was manufactured, the next two are the tire size code and the last four numbers represent the week and year the tire was built. For example, 1510 means that the tire was manufactured during week 15 of 2010. The numbers in between are marketing codes used at the manufacturer's discretion. This information helps a tire manufacturer identify a tire for safety recall purposes.
  9. **Tire Ply Composition and Material Used**: Indicates the number of plies indicated or the number of layers of rubber-coated fabric in the tire tread and sidewall. Tire manufacturers also must indicate the ply materials in the tire and the sidewall, which include steel, nylon, polyester, and others.
  10. **Maximum Load**: Indicates the maximum load in pounds and kilograms that can be carried by the tire. Refer to the vehicle's tire information placard located on the B-Pillar for the correct tire pressure for your vehicle.
  11. **Treadwear, Traction, and Temperature grades**: see Tire specifications – Uniform Tire Quality Grading (p. 288) for more information.
  12. **Maximum permissible inflation pressure**: the greatest amount of air pressure that should ever be put in the tire. This limit is set by the tire manufacturer.

**Tire inflation – pressure table**

The following tire pressures are recommended by Volvo for your vehicle. Refer to

the tire inflation placard (see Tire inflation – general information (p. 281) for its location) for

information specific to the tires installed on your vehicle at the factory.

**Some of the tire sizes listed here may not be available in all markets.**

Tire size	Cold tire pressure for up to five persons	
	Front psi (kPa)	Rear psi (kPa)
225/50 R17 Extra load	36 (250)	36 (250)
235/40 R18 Extra load 235/40 R19 Extra load	38 (260)	38 (260)
Temporary spare tire T125/80R17	61 (420)	61 (420)

**⚠ WARNING**

19" wheels may **never** be used on vehicles that are **not** equipped with the R-design or the Sport chassis options.

Using 19" wheels on vehicles equipped with the **standard chassis** presents a safety risk and the risk of damage to the vehicle, and impairs the vehicle's driving characteristics.

**i NOTE**

Please consult a Volvo retailer's Parts department for the most up-to-date specifications.



## Loading specifications

*Properly loading your vehicle will provide maximum return of vehicle design performance.*

Before loading your vehicle, familiarize yourself with the following terms for determining your vehicle's weight ratings, with or without a trailer, from the vehicle's Federal/Canadian Motor Vehicle Safety Standards (FMVSS/CMVSS) label, and the vehicle's tire information placard:

### Curb weight

The weight of the vehicle including a full tank of fuel and all standard equipment. It does not include passengers, cargo, or optional equipment.

### Capacity weight

All weight added to the curb weight, including cargo and optional equipment. When towing, trailer hitch tongue load is also part of cargo weight.

### Permissible axle weight

The maximum allowable weight that can be carried by a single axle (front or rear). These numbers are shown on the Federal/Canadian Motor Vehicle Safety Standards (FMVSS/CMVSS) label. The total load on each axle must never exceed its maximum permissible weight.

## Gross vehicle weight (GVW)

The vehicle's curb weight + cargo + passengers.

### NOTE

- The location of the various labels in your vehicle, see Label information (p. 350).
- A table listing important weight limits for your vehicle, see Weights (p. 355).

## Loading specifications – load limit

*The load limit of your vehicle is the combined weight of the occupants and cargo.*

### Steps for Determining Correct Load Limit

1. Locate the statement "the combined weight of occupants and cargo should never exceed XXX pounds" on your vehicle's placard.
2. Determine the combined weight of the driver and passengers that will be riding in your vehicle.
3. Subtract the combined weight of the driver and passengers from XXX kilograms or XXX pounds.
4. The resulting figure equals the available amount of cargo and luggage load capacity. For example, if the "XXX" amount equals 1400 lbs. and there will be five 150 lb. passengers in your vehicle, the amount of available cargo and luggage load capacity is 650 lbs. (1400 – 750 (5 × 150) = 650 lbs.)
5. Determine the combined weight of luggage and cargo being loaded on the vehicle. That weight may not safely exceed the available cargo and luggage load capacity calculated in Step 4.



6. If your vehicle will be towing a trailer, load from your trailer will be transferred to your vehicle.

### WARNING

- Exceeding the permissible axle weight, gross vehicle weight, or any other weight rating limits can cause tire overheating resulting in permanent deformation or catastrophic failure.
- Do not use replacement tires with lower load carrying capacities than the tires that were original equipment on the vehicle because this will lower the vehicle's GVW rating. Use only tires with the correct load carrying capacity. Consult your Volvo retailer for information.

### Tire specifications – terminology

*The following is a glossary of tire-related terms.*

The tire suppliers may have additional markings, notes or warnings such as standard load, radial tubeless, etc.

- **Tire information placard:** A placard showing the OE (Original Equipment) tire sizes, recommended inflation pressure, and the maximum weight the vehicle can carry.
- **Tire Identification Number (TIN):** A number on the sidewall of each tire providing information about the tire brand and manufacturing plant, tire size and date of manufacturer.
- **Inflation pressure:** A measure of the amount of air in a tire.
- **Standard load:** A class of P-metric or Metric tires designed to carry a maximum load at 35 psi [37 psi (2.5 bar) for Metric tires]. Increasing the inflation pressure beyond this pressure will not increase the tires load carrying capability.
- **Extra load:** A class of P-metric or Metric tires designed to carry a heavier maximum load at 41 psi [43 psi (2.9 bar) for Metric tires]. Increasing the inflation pressure beyond this pressure will not increase the tire's load carrying capability.
- **kPa:** Kilopascal, a metric unit of air pressure.
- **PSI:** Pounds per square inch, a standard unit of air pressure.
- **B-pillar:** The structural member at the side of the vehicle behind the front door.
- **Bead area of the tire:** Area of the tire next to the rim.
- **Sidewall of the tire:** Area between the bead area and the tread.
- **Tread area of the tire:** Area of the perimeter of the tire that contacts the road when mounted on the vehicle.
- **Rim:** The metal support (wheel) for a tire or a tire and tube assembly upon which the tire beads are seated.
- **Maximum load rating:** a figure indicating the maximum load in pounds and kilograms that can be carried by the tire. This rating is established by the tire manufacturer.
- **Maximum permissible inflation pressure:** the greatest amount of air pressure that should ever be put in the tire. This limit is set by the tire manufacturer.
- **Recommended tire inflation pressure:** inflation pressure, established by Volvo, which is based on the type of tires that are mounted on a vehicle at the factory. This information can be found on the tire inflation placard(s) located on the driver's



side B-pillar and in the tire inflation table in this chapter.

- **Cold tires:** The tires are considered to be cold when they have the same temperature as the surrounding (ambient) air. This temperature is normally reached after the vehicle has been parked for at least 3 hours.

### Tire specifications – Uniform Tire Quality Grading

**ALL PASSENGER VEHICLE TIRES MUST CONFORM TO FEDERAL SAFETY REQUIREMENTS IN ADDITION TO THESE GRADES.**

**Quality grades can be found, where applicable, on the tire sidewall between the tread shoulder and maximum section width. For example:**

**Treadwear 200 Traction AA Temperature A**

#### TREADWEAR

The treadwear grade is a comparative rating based on the wear rate of the tire when tested under controlled conditions on a specified government test course. For example, a tire graded 150 would wear one and one half (1 ½) times as well on the government course as a tire graded 100. The relative performance of tires depends upon the actual conditions of their use, however, and many depart significantly from the norm due to variation in driving habits, maintenance practices and differences in road characteristics and climate.

#### TRACTION

The traction grades, from highest to lowest, are AA, A, B, and C, as measured under controlled conditions on specified government test surfaces of asphalt and concrete. A tire marked C may have poor traction perform-

ance. The traction grade assigned to this tire is based on braking (straight-ahead) traction tests and is not a measure of cornering (turning) traction.

### WARNING

The traction grade assigned to this tire is based on braking (straight-ahead) traction tests and is not a measure of cornering (turning) traction.

#### TEMPERATURE

The temperature grades are A (the highest), B, and C, representing the tire's resistance to the generation of heat and its ability to dissipate heat when tested under controlled conditions on a specified indoor laboratory test wheel. Sustained high temperature can cause the material of the tire to degenerate and reduce tire life, and excessive temperature can lead to sudden tire failure. The grade C corresponds to a minimum level of performance that all passenger vehicle tires must meet under the Federal Motor Safety Standard No. 109. Grades B and A represent higher levels of performance on the laboratory test wheel than the minimum required by law.

**! WARNING**

The temperature grade for this tire is established for a tire that is properly inflated and not overloaded. Excessive speed, under-inflation, or excessive loading, either separately or in combination, can cause heat buildup and tire failure.

**Snow chains**

*Snow chains can be used on your Volvo with the following restrictions:*

- Snow chains should be installed on front wheels only. Use only Volvo approved snow chains.
- If accessory, aftermarket or "custom" tires and wheels are installed and are of a size different than the original tires and wheels, chains in some cases CANNOT be used. Sufficient clearances between chains and brakes, suspension and body components must be maintained.
- Some strap-on type chains will interfere with brake components and therefore CANNOT be used.
- **All Wheel Drive models:** Snow chains should only be installed on the front wheels.
- Certain size tires may not allow the assembly of snow chains/traction devices.

Consult your Volvo retailer for additional snow chain information.

**! CAUTION**

- Check local regulations regarding the use of snow chains before installing.
- Use single-sided snow chains only.
- Always follow the chain manufacturer's installation instructions carefully. Install chains as tightly as possible and retighten periodically.
- Never exceed the chain manufacturer's specified maximum speed limit. (Under no circumstances should you exceed 31 mph (50 km/h).
- Avoid bumps, holes or sharp turns when driving with snow chains.
- The handling of the vehicle can be adversely affected when driving with chains. Avoid fast or sharp turns as well as locked wheel braking.



## Snow tires/studded tires<sup>4</sup>

Owners who live in or regularly commute through areas with sustained periods of snow or icy driving conditions are strongly advised to fit suitable winter tires to help retain the highest degree of traction.

### Tires for winter use:

- It is important to install winter tires on all four wheels to help retain traction during cornering, braking, and accelerating. Failure to do so could reduce traction to an unsafe level or adversely affect handling.
- Do not mix tires of different design as this could also negatively affect overall tire road grip.
- Winter tires wear more quickly on dry roads in warm weather. They should be removed when the winter driving season has ended.
- Studded tires should be run-in 300 – 600 miles (500 – 1000 km) during which the vehicle should be driven as smoothly as possible to give the studs the opportunity to seat properly in the tires. The tires should have the same rotational direction throughout their entire lifetime.

### NOTE

Please consult state or provincial regulations restricting the use of studded winter tires before installing such tires.

<sup>4</sup> Where permitted

## Tire pressure monitoring - introduction

Volvo provides two different systems to monitor tire pressure: Tire Pressure Monitoring System (TPMS) or Tire Monitor.

### Determining which tire monitoring system is in your vehicle

To see which system is installed in your vehicle, press the **MY CAR** button on the center console. Go to **Settings** → **Car settings**.

- If your vehicle has a menu called **Tire monitoring**, see Tire Monitor - introduction (p. 295).
- If your vehicle has a menu called **Tire pressure**, see Tire Pressure Monitoring System (TPMS) – general information (p. 291).

### Introduction

Each tire, including the spare (if provided), should be checked monthly when cold and inflated to the inflation pressure recommended by the vehicle manufacturer on the vehicle placard or tire inflation pressure label. (If your vehicle has tires of a different size than the size indicated on the vehicle placard or tire inflation pressure label, you should determine the proper tire inflation pressure for those tires.)

As an added safety feature, your vehicle has been equipped with a tire pressure monitoring system that illuminates a low tire pressure telltale when one or more of your tires is significantly under-inflated. Accordingly, when the low tire pressure telltale illuminates, you should stop and check your tires as soon as possible, and inflate them to the proper pressure.

Driving on a significantly under-inflated tire causes the tire to overheat and can lead to tire failure. Under-inflation also reduces fuel efficiency and tire tread life, and may affect the vehicle's handling and stopping ability. Please note that a tire pressure monitoring system is not a substitute for proper tire maintenance, and it is the driver's responsibility to maintain correct tire pressure, even if under-inflation has not reached the level to trigger illumination of the system's low tire pressure telltale.

Your vehicle has also been equipped with a TPMS malfunction indicator to indicate when the system is not operating properly. The monitoring system's malfunction indicator is combined with the low tire pressure telltale.

When the system detects a malfunction, the telltale will flash for approximately one minute and then remain continuously illuminated. This sequence will continue upon subsequent vehicle start-ups as long as the malfunction



exists. When the malfunction indicator is illuminated, the system may not be able to detect or signal low tire pressure as intended.

System malfunctions may occur for a variety of reasons, including the installation of replacement or alternate tires or wheels on the vehicle that prevent the tire pressure monitoring system from functioning properly.

Always check the system's malfunction telltale after replacing one or more tires or wheels on your vehicle to ensure that the replacement or alternate tires and wheels allow the system to continue to function properly.

#### NOTE

The system indicates low tire pressure but does not replace normal tire maintenance. For information on correct tire pressure, please refer to the tire inflation pressure table (see Tire inflation – pressure table (p. 285)), the tire inflation pressure placard located on the driver's side B-pillar (the structural member at the side of the vehicle, at the rear of the driver's door opening) or consult your Volvo retailer.

#### WARNING

Incorrect inflation pressure could lead to tire failure, resulting in a loss of control of the vehicle.

### Tire Pressure Monitoring System (TPMS) – general information

*TPMS uses sensors mounted in the tire valves to check inflation pressure levels. When the vehicle is moving at a speed of approximately 20 mph (30 km/h) or faster, these sensors transmit inflation pressure data to a receiver located in the vehicle.*

#### NOTE

##### USA – FCC ID: KR5S180052050

This device complies with part 15 of the FCC rules. Operation is subject to the following conditions: (1) This device may not cause harmful interference, and (2) this device must accept any interference received, including interference that may cause undesired operation.

When low inflation pressure is detected or if a sensor is not functioning properly, TPMS will light up the tire pressure warning light  (also referred to as a telltale) in the instrument panel and will display one of the following messages: **Tire pressure low**, **Tire needs air now** or **Tire press. syst Service required**.

#### NOTE

If a malfunction occurs in the system, the tire pressure warning light will flash for approximately 1 minute and then remain illuminated. **Tire press. syst Service required** will be displayed.

#### Related information

- Tire Pressure Monitoring System (TPMS) – recalibrating (p. 293)
- Tire Pressure Monitoring System (TPMS) – messages (p. 294)
- Tire Pressure Monitoring System (TPMS) – activating/deactivating (p. 293)
- Tire Pressure Monitoring System (TPMS) – changing wheels (p. 292)



## Tire Pressure Monitoring System (TPMS) – changing wheels

Please keep the following in mind when changing or replacing the factory installed TPMS wheels/tires on the vehicle:

- Not all aftermarket wheels are equipped with TPMS sensors in the valves.
- If the vehicle is equipped with a temporary spare tire, this tire does not have a TPMS sensor.
- If wheels without TPMS sensors are mounted on the vehicle, a text message will be displayed in the instrument panel each time the vehicle is driven above 20 mph (30 km/h) for 10 minutes or more.
- Once TPMS sensors are properly installed, the warning message should not reappear. If the message is still displayed, drive the vehicle for several minutes at a speed of 20 mph (30 km/h) or faster to erase the message.
- Volvo recommends that TPMS sensors be fitted on all wheels used on the vehicle, including winter tires. Volvo does not recommend moving sensors back and forth between sets of wheels.

### CAUTION

When inflating tires with TPMS valves, press the pump's mouthpiece straight onto the valve to help avoid bending or otherwise damaging the valve.

### CAUTION

- After inflating the tires, always reinstall the valve cap to help avoid damage to the valve from dirt, gravel, etc.
- Use plastic valve caps only. Metal caps could corrode and become difficult to remove.

### NOTE

- If you change to tires with a different dimension than the factory-installed ones, the TPMS system must be reconfigured for these tires. This must be done by a trained and qualified Volvo service technician.
- If a tire is changed, or if the TPMS sensor is moved to another wheel, the sensor's seal, nut, and valve core should be replaced.
- When installing TPMS sensors, the vehicle must be parked for at least 15 minutes with the ignition off. If the vehicle is driven within 15 minutes, a TPMS error message will be displayed.

## Related information

- Tire Pressure Monitoring System (TPMS) – general information (p. 291)
- Tire Pressure Monitoring System (TPMS) – recalibrating (p. 293)
- Tire Pressure Monitoring System (TPMS) – messages (p. 294)
- Tire Pressure Monitoring System (TPMS) – activating/deactivating (p. 293)



## Tire Pressure Monitoring System (TPMS) – recalibrating

*In certain cases, it may be necessary to recalibrate TPMS to conform to Volvo's recommended tire inflation pressures (see the inflation pressure table in Tire inflation – pressure table (p. 285)), for example, if higher inflation pressure is necessary when transporting heavy loads, etc.*

### Recalibrating TPMS (Canadian models only)\*

This is done in the vehicle's menu system.

To recalibrate:

1. Switch off the engine.
2. Inflate the tires to the desired pressure and put the ignition in mode **I** or **II** (see Ignition modes (p. 73) for additional information).
3. Press the **MY CAR** key in the center console control panel and select **Settings** → **Car settings** → **Tire pressure**.
4. Press **OK/MENU**, select **Calibrate tire pressure** and press **OK/MENU** again.

5. Drive the vehicle at a speed above 20 mph (30 km/h) continuously for at least 10 minutes.
  - > Calibration is done automatically once initiated by the driver and the system does not give any confirmation when calibration is finished.

The new pressures are used until step 1-5 above are repeated.

### Related information

- Tire Pressure Monitoring System (TPMS) – general information (p. 291)
- Tire Pressure Monitoring System (TPMS) – messages (p. 294)
- Tire Pressure Monitoring System (TPMS) – activating/deactivating (p. 293)
- Tire Pressure Monitoring System (TPMS) – changing wheels (p. 292)
- My Car – introduction (p. 70)

## Tire Pressure Monitoring System (TPMS) – activating/deactivating

### Activating/deactivating TPMS (Canadian models only)

1. Switch off the engine.
2. Put the ignition in mode **I** or **II** (see Ignition modes (p. 73) for additional information).
3. Press the **MY CAR** key in the center console control panel and select **Settings** → **Car settings** → **Tire pressure**
4. Select **Tire monitoring** and press **OK/MENU** to turn the system on or off.

### Related information

- Tire Pressure Monitoring System (TPMS) – general information (p. 291)

\* Option/accessory, for more information, see Introduction.



## Tire Pressure Monitoring System (TPMS) – messages

### Erasing warning messages

When a low tire pressure warning message has been displayed and the tire pressure warning light in the instrument panel  has come on:

1. Use a tire pressure gauge to check the inflation pressure of all four tires.
2. Re-inflate the tire(s) to the correct pressure (consult the tire pressure placard located on the driver's side B-pillar (the structural member at the side of the vehicle, at the rear of the driver's door opening) or the inflation pressure table, see Tire inflation – pressure table (p. 285).
3. In certain cases, it may be necessary to drive the vehicle for several minutes at a speed of 20 mph (30 km/h) or faster. This will erase the warning text and the telltale will go out.



### NOTE

- Tire monitoring systems use a temperature compensated pressure value. This pressure value is dependent on tire temperature and ambient temperature, which can differ from the recommended cold tire pressure in the tire inflation table and on the tire pressure placard located on the driver's side B-pillar (the structural member at the side of the vehicle, at the rear of the driver's door opening). This means that it may sometimes be necessary to inflate them slightly above the recommended cold pressure value (approx. 3-4 psi or 0.2-0.3 bar) in order to reset a low tire pressure warning.
- To help avoid incorrect tire inflation pressure, if possible only inflate the tires when they are cold. The tires are considered to be cold when they have the same temperature as the surrounding (ambient) air. This temperature is normally reached after the vehicle has been parked for at least 3 hours. After driving a distance of approximately 1 mile (1.6 km), the tires are considered to be hot.



### CAUTION

- After inflating the tires, always reinstall the valve cap to help avoid damage to the valve from dirt, gravel, etc.
- Use plastic valve caps only. Metal caps could corrode and become difficult to remove.



### WARNING

- Incorrect inflation pressure could lead to tire failure, resulting in a loss of control of the vehicle.
- Tire monitoring systems cannot indicate sudden tire damage caused by external factors (e.g., a blowout) in advance.

### Related information

- Tire Pressure Monitoring System (TPMS) – general information (p. 291)
- Tire Pressure Monitoring System (TPMS) – recalibrating (p. 293)
- Tire Pressure Monitoring System (TPMS) – activating/deactivating (p. 293)
- Tire Pressure Monitoring System (TPMS) – changing wheels (p. 292)
- Tire pressure monitoring - introduction (p. 290)
- Tire inflation – pressure table (p. 285)



## Tire Monitor - introduction

*Tire Monitor uses the rotational speed of the tires to determine if they are properly inflated.*

When a tire is under-inflated, its diameter (and consequently also its rotational speed) changes. By comparing the individual tires with each other it is possible to determine if one or more tires are under inflated.

When low inflation pressure is detected or if the system is not functioning properly, Tire Monitor will light up the tire pressure warning light  (also referred to as a telltale) in the instrument panel and will display one of the following messages in the text window, for example: **Tire pressure low Check rear right tire<sup>5</sup>** or **Tire press. syst Service required**.

If the system cannot determine which tire has low pressure, a general text (**Tire pressure low Check tires**) will be displayed.

### NOTE

If a malfunction occurs in the system, the tire pressure warning light will flash for approximately 1 minute and then remain illuminated. **Tire press. syst Service required** will be displayed.

### NOTE

The system indicates low tire pressure but does not replace normal tire maintenance. For information on correct tire pressure, please refer to the tire inflation pressure table (see Tire inflation – pressure table (p. 285)), the tire inflation pressure placard located on the driver's side B-pillar (the structural member at the side of the vehicle, at the rear of the driver's door opening) or consult your Volvo retailer.

### Related information

- Tire pressure monitoring - introduction (p. 290)

## Calibrating Tire Monitor

*In order for Tire Monitor to work correctly, tire pressure reference values must be set. This must be done each time wheels or tire pressures are changed.*

### Calibration

1. Switch off the engine.
2. Inflate the tires to the desired pressure (consult tire pressure placard located on the driver's side B-pillar (the structural member at the side of the vehicle) and put the ignition in mode **II**, see Ignition modes (p. 73).
3. Press the **MY CAR** button on the center console control panel and select **Settings** → **Car settings** → **Tire monitoring**.
4. Press **OK/MENU**, select **Calibrate tire pressure** and press **OK/MENU** again.
5. Drive away.
  - > The calibration process will be completed while driving and will be interrupted if the vehicle is parked and the engine is switched off. Calibration continues automatically when driving resumes.

The new reference values will be used until steps 1-5 stated above are repeated.

<sup>5</sup> That last part of this message varies, depending on the tire(s) effected.



## NOTE

Always remember to calibrate Tire Monitor when the wheels have been changed or the tire pressure has been corrected according to tire pressure placard or tire pressure table. If correct reference values have not been set, the system cannot issue low tire pressure alerts correctly.

## Tire Monitor status information

*The current status of the system and the tires is indicated by color-coded graphics.*

This status can be displayed by pressing the **MY CAR** button on the center console and going to **Settings** → **Car settings** → **Tire monitoring**.

The following color-coded graphics indicate:

- **All green:** the system is operational and all tire pressures are at or above the recommended levels.
- **One yellow wheel:** the tire indicated is under-inflated.
- **All wheels yellow:** two or more tires are under-inflated
- **All wheels gray:** the system is currently unavailable. It might be necessary to drive at a speed of at least 20 mph (30 km/h) for several minutes for the system to become operational.
- **All wheels gray in combination with the message **Tire press. syst Service required** and the telltale in the instrument panel is illuminated:** the system is not functioning correctly. Have it checked by a trained and qualified Volvo service technician.

## Related information

- Tire Monitor – messages (p. 296)

## Tire Monitor – messages

*When low tire pressure has been detected, a message will be displayed and the tire pressure warning telltale in the instrument panel will illuminate.*

## Erasing warning messages

To erase a low tire pressure message and turn off the telltale:

1. Use a tire pressure gauge to check the inflation pressure of the under-inflated tire(s).
2. Re-inflate the tire(s) to the correct pressure (consult the tire pressure placard located on the driver's side B-pillar (the structural member at the side of the vehicle, at the rear of the driver's door opening) or the inflation pressure table, see Tire inflation – pressure table (p. 285).
3. Recalibrate Tire Monitor, see Calibrating Tire Monitor (p. 295).

**NOTE**

- Tire monitoring systems use a temperature compensated pressure value. This pressure value is dependent on tire temperature and ambient temperature, which can differ from the recommended cold tire pressure in the tire inflation table and on the tire pressure placard located on the driver's side B-pillar (the structural member at the side of the vehicle, at the rear of the driver's door opening). This means that it may sometimes be necessary to inflate them slightly above the recommended cold pressure value (approx. 3-4 psi or 0.2-0.3 bar) in order to reset a low tire pressure warning.
- To help avoid incorrect tire inflation pressure, if possible only inflate the tires when they are cold. The tires are considered to be cold when they have the same temperature as the surrounding (ambient) air. This temperature is normally reached after the vehicle has been parked for at least 3 hours. After driving a distance of approximately 1 mile (1.6 km), the tires are considered to be hot.

**CAUTION**

- After inflating the tires, always reinstall the valve cap to help avoid damage to the valve from dirt, gravel, etc.
- Use plastic valve caps only. Metal caps could corrode and become difficult to remove.

**WARNING**

- Incorrect inflation pressure could lead to tire failure, resulting in a loss of control of the vehicle.
- Tire monitoring systems cannot indicate sudden tire damage caused by external factors (e.g., a blowout) in advance.

**Related information**

- Tire Monitor – messages (p. 296)
- Tire inflation – checking pressure (p. 282)
- Tire inflation – pressure table (p. 285)

**Self-supporting run flat tires (SST)**

*Self-supporting run flat tires are available as optional equipment on certain models.*

The vehicle must be equipped with one of the tire pressure monitoring systems if tires of this type are installed.

Tires of this type have specially reinforced sidewalls that make it possible to continue driving to a limited extent even though the tire has lost some or all of its inflation pressure. These tires are mounted on special rims (normal tires can also be mounted on these rims).

If an SST tire loses inflation pressure, the yellow TPMS symbol illuminates in the instrument panel and a text message is also displayed. If this happens, reduce speed to not more than 50 mph (80 km/h). The tire should be replaced as soon as possible.



## WARNING

- SST tires should only be mounted by service technicians who are familiar with tires of this type.
- SST tires may only be mounted on vehicles equipped with a tire pressure monitoring system.
- Do not drive faster than 50 mph (80 km/h) if the monitoring system indicates that a tire has lost inflation pressure.
- Do not drive farther than 50 miles (80 km) before replacing a damaged SST tire.
- Drive carefully and avoid e.g., hard braking or fast turns.
- SST tires must be replaced if they are damaged. A tire of this type cannot be repaired.

### Related information

- Tire pressure monitoring - introduction (p. 290)

## Tire sealing system\* – general information

**Certain models are equipped with a tire sealing system\* that enables you to temporarily seal a hole in the tread surface and re-inflate a flat tire, or to adjust a tire's inflation pressure.**

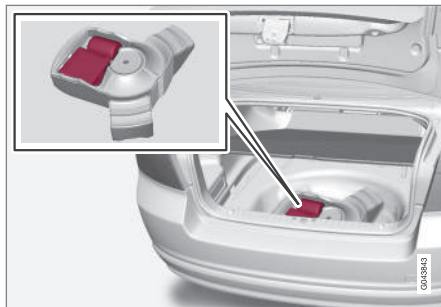

### Introduction

The tire sealing system consists of an air compressor, a container for the sealing compound, wiring to connect the system to the vehicle's electrical system via one of the 12-volt sockets, and a hose used to connect the system to the tire's inflation valve.

### NOTE

The tire sealing system's compressor has been tested and approved by Volvo.

The 12-volt sockets are located in the front tunnel console and on the rear side of the center console in the rear seat.

### Accessing the tire sealing system

The tire sealing system is stowed under the floor of the trunk. To access it:

1. Lift the floor hatch in the cargo area.
2. Lift out the tire sealing system.

### NOTE

- The tire sealing system is only intended to seal holes on the tire's tread area, not the sidewall.
- Tires with large holes or tears cannot be repaired with the tire sealing system.
- After use, stow the tire sealing system properly to help prevent rattling.



### WARNING

- After using the tire sealing system, the vehicle should not be driven farther than approximately 120 miles (200 km).
- Have the tire inspected by a trained and qualified Volvo service technician as soon as possible to determine if it can be permanently repaired or must be replaced.
- The vehicle should not be driven faster than 50 mph (80 km/h) while using a tire that has been temporarily repaired with the tire sealing system.
- After using the tire sealing system, drive carefully and avoid abrupt steering maneuvers and sudden stops.

### Tire sealing system—temporarily repairing a flat tire

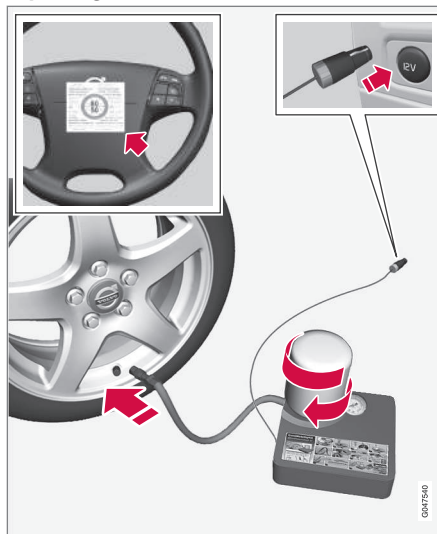

Temporarily repairing a flat tire is done in two stages:

- **Stage 1:** The hole is sealed by pumping sealing compound into the tire. The car is then driven a short distance to distribute the sealing compound in the tire.

### NOTE

Do not remove any foreign objects (nails, etc.) from the tire before using the sealing system.

- **Stage 2:** The tire's inflation pressure is checked and adjusted if necessary.

### WARNING

- Never leave the tire sealing system unattended when it is operating.
- Keep the tire sealing system away from children.
- Be sure the vehicle is parked safely off the road and away from moving traffic.
- Apply the parking brake.

### Related information

- Tire sealing system\* – overview (p. 300)
- Tire sealing system\* – inflating tires (p. 303)
- Tire sealing system\* – sealing compound container (p. 304)
- Tire sealing system\* – sealing hole (p. 301)
- Tire sealing system – checking inflation pressure (p. 303)
- Tunnel console – 12-volt sockets (p. 134)

\* Option/accessory, for more information, see Introduction.



## Tire sealing system\* – overview

**Certain models are equipped with a tire sealing system\* that enables you to temporarily seal a hole in the tread surface and re-inflate a flat tire, or to adjust a tire's inflation pressure.**

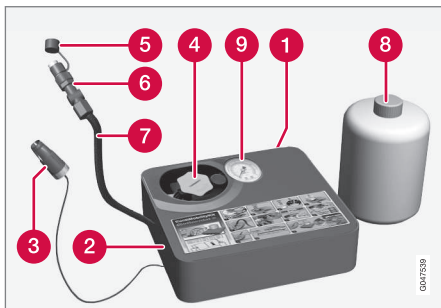

- 1 Speed limit sticker (on the rear side of the compressor)
- 2 On/Off switch
- 3 Electrical wire
- 4 Bottle holder (orange cover)
- 5 Protective hose cover
- 6 Air release knob
- 7 Hose

- 8 Bottle with sealing compound
- 9 Air pressure gauge



## WARNING

Please keep the following points in mind when using the tire sealing system:

- The sealing compound bottle (no. 8 in the illustration) contains 1) rubber latex, natural and 2) ethanediol. These substances are harmful if swallowed.
- The contents of this bottle may cause allergic skin reactions or otherwise be potentially harmful to the respiratory tract, the skin, the central nervous system, and the eyes.

### Precautions:

- Keep out of reach of children.
- Do not ingest the contents.
- Avoid prolonged or repeated contact with the skin.
- Wash thoroughly after handling.

### First aid:

- Skin: Wash affected areas of skin with soap and water. Get medical attention if symptoms occur.
- Eyes: Flush with plenty of water for least 15 minutes, occasionally lifting the upper and lower eyelids. Get medical attention if symptoms occur.
- Inhalation: Move the exposed person to fresh air. If irritation persists, get medical attention.



- Ingestion: Do **NOT** induce vomiting unless directed to do so by medical personnel. Get medical attention.
- Disposal: Dispose of this material and its container to a hazardous or special waste collection point.

 **NOTE**

Do not break the seal on the bottle. This occurs automatically when the bottle is screwed into the holder.

**Related information**

- Tire sealing system\* – general information (p. 298)
- Tire sealing system\* – inflating tires (p. 303)
- Tire sealing system – checking inflation pressure (p. 303)
- Tire sealing system\* – sealing hole (p. 301)
- Tire sealing system\* – sealing compound container (p. 304)

**Tire sealing system\* – sealing hole**

*The tire sealing system can be used to temporarily seal a hole in the tread surface of a tire.*

**Stage 1: Sealing the hole**

1. Peel off the speed limit sticker and affix it to the steering wheel hub where it will be clearly visible to the driver.
2. Ensure that the on/off switch is in position **0** (the **0** side of the switch should be pressed down).

 **WARNING**

Contact with the sealing compound may cause skin irritation. If contact occurs, wash the affected area immediately with soap and water.

3. Unscrew the orange cover over the bottle holder and unscrew the cap on the bottle of sealing compound.

 **NOTE**

Do not break the seal on the bottle. This occurs automatically when the bottle is screwed into the holder.

4. Screw the bottle into the bottle holder.

 **WARNING**

The bottle is equipped with a catch to keep it securely in place and help prevent sealing compound leakage. Once in place, the bottle cannot be unscrewed. This must be done by a trained and qualified Volvo service technician.

5. Remove the valve cap from the tire's inflation valve and screw the tire sealing system's hose connector onto the valve as tightly as possible by hand.
6. Connect the electrical wire to the nearest 12-volt socket in the vehicle.

 **NOTE**

Be sure that none of the other 12-volt sockets is being used while the compressor is in operation.

7. Start the vehicle's engine.



## WARNING

The vehicle's engine should be running when the tire sealing system is used to avoid battery drain. Therefore, be sure the vehicle is parked in a well ventilated place, or outdoors, before using the system.

8. Start the tire sealing system's compressor by pressing the on/off switch to position I.

## WARNING

- Never stand next to the tire being inflated when the compressor is in operation.
- If cracks, bubbles, etc. form on the tire, switch off the compressor immediately.
- If there is visible damage to the sidewall or the rim, the tire cannot be repaired. The vehicle should not be driven if this occurs. Contact a towing service or Volvo On Call Roadside Assistance if applicable.

## NOTE

The air pressure gauge will temporarily show an increase in pressure to approximately 88 psi (6 bar) while the sealing compound is being pumped into the tire. The pressure should return to a normal level after approximately 30 seconds.

9. Within seven minutes, inflate the tire to between 22—44 psi (1.8—3.0 bar). Switch off the compressor briefly to get a clear reading from the pressure gauge.

## CAUTION

The compressor should not be used for more than 10 minutes at a time to avoid overheating.

## WARNING

If the pressure remains below 22 psi (1.8 bar) after approximately seven minutes, turn off the compressor. In this case, the hole is too large to be sealed and the vehicle should not be driven.

10. Switch off the compressor and disconnect the electrical wire from the 12-volt socket.
11. Unscrew the hose from the tire's inflation valve and reinstall the valve cap.

## CAUTION

- After inflating the tires, always reinstall the valve cap to help avoid damage to the valve from dirt, gravel, etc.
- Use plastic valve caps only. Metal caps could corrode and become difficult to remove.

12. Immediately drive the vehicle for approximately 2 miles (3 km) at a maximum speed of 50 mph (80 km/h) to distribute the sealing compound in the tire.

**CAUTION**

If your vehicle is equipped with the Tire Pressure Monitoring System (TPMS), the use of the sealing compound may lead to incorrect tire pressure readings or in rare cases, damage to the tire pressure sensor. Use the tire sealing system to check and adjust the damaged tire's inflation pressure.

**NOTE**

- Safely stow the tire sealing system in a convenient place as it will soon be used again to check the tire's inflation pressure.
- The empty bottle of sealing compound cannot be removed from the bottle holder. Consult a trained and qualified Volvo service technician to have the bottle removed and properly disposed of.

**WARNING**

If heavy vibrations, unsteady steering behavior, or noises should occur while driving, reduce speed and park the vehicle in a safe place. Recheck the tire for bumps, cracks, or other visible damage, and recheck its inflation pressure. If the pressure is below 19 psi (1.3 bar), do not continue driving. Have the vehicle towed to a trained and qualified Volvo service technician.

**Tire sealing system – checking inflation pressure**

*The tire sealing system can also be used to check the tires' inflation pressure.*

**Stage 2: Checking inflation pressure**

1. Connect the tire sealing system as described in **stage 1**, see Tire sealing system\* – sealing hole (p. 301).
2. Refer to the inflation pressure table in this chapter for the correct inflation pressure. If the tire needs to be inflated, start the tire sealing system's compressor. If necessary, release air from the tire by turning the air release knob counterclockwise.

**CAUTION**

The compressor should not be used for more than 10 minutes at a time to avoid overheating.

**WARNING**

If you interrupt your trip for more than 1 hour, check the inflation pressure in the damaged tire again before continuing.

**Tire sealing system\* – inflating tires**

*The tire sealing system can be used to inflate the tires.*

To do so:

1. Park the car in a safe place.
2. The compressor should be switched off. Ensure that the on/off switch is in position **0** (the **0** side of the switch should be pressed down).
3. Take out the electrical wire and hose.
4. Remove the valve cap from the tire's inflation valve and screw the hose connector onto the valve as tightly as possible by hand.
5. Connect the electrical wire to the nearest 12-volt socket in the vehicle.
6. Start the vehicle's engine.



## WARNING

- The vehicle's engine should be running when the tire sealing system is used to avoid battery drain. Therefore, be sure the vehicle is parked in a well ventilated place, or outdoors, before using the system. The parking brake should be securely applied and the gear selector should be in the **P** (park) position.
- Children should never be left unattended in the vehicle when the engine is running.

7. Check the tire's inflation pressure on the gauge. Switch off the compressor briefly to get a clear reading from the pressure gauge.
8. Refer to the tire inflation table in this chapter for the correct inflation pressure. If the tire needs to be inflated, start the tire sealing system's compressor (press the on/off switch to position I). If necessary, release air from the tire by turning the air release knob counterclockwise.

## CAUTION

The compressor should not be used for more than 10 minutes at a time to avoid overheating.

9. Turn off the compressor (press the on/off switch to position **0**) when the correct inflation pressure has been reached.
10. Unscrew the hose from the tire's inflation valve and reinstall the valve cap.

## CAUTION

- After inflating the tires, always reinstall the valve cap to help avoid damage to the valve from dirt, gravel, etc.
- Use plastic valve caps only. Metal caps could corrode and become difficult to remove.

11. Disconnect the electrical wire from the 12-volt socket.

## Tire sealing system\* – sealing compound container

*The sealing compound container must be replaced if the tire sealing system has been used to repair a tire or if the container's expiration date has passed (see the date on decal).*

### Replacing the sealing compound container

## NOTE

- After use, the sealing compound bottle, the hose, and certain other system components must be replaced. Please consult your Volvo retailer for replacement parts.
- If the sealing compound bottle's expiration date has passed, please take it to a Volvo retailer or a recycling station that can properly dispose of harmful substances.

# 10

## MAINTENANCE AND SERVICING

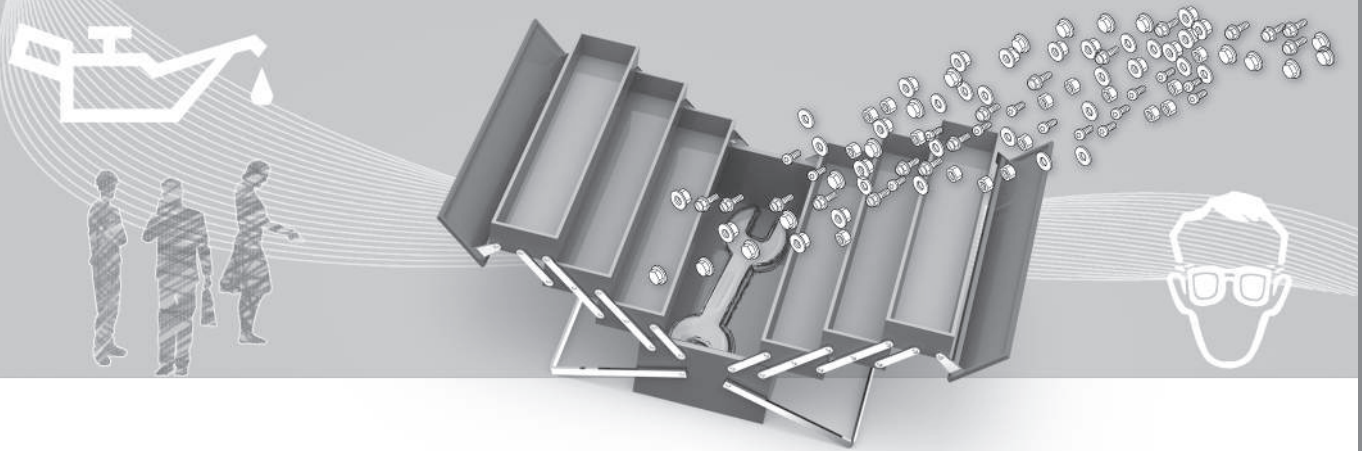



## Maintenance – introduction

*Periodic maintenance will help keep your vehicle running well.*

### Introduction

The maintenance services contain several checks that require special instruments and tools and therefore must be performed by a qualified technician. To keep your Volvo in top condition, specify time-tested and proven Genuine Volvo Parts and Accessories.

### The Federal Clean Air Act – U.S.

The Federal Clean Air Act requires vehicle manufacturers to furnish written instructions to the ultimate purchaser to assure the proper servicing and function of the components that control emissions. These services, which are listed in the "Warranty and Service Records Information" booklet, are not covered by the warranty. You will be required to pay for labor and material used.

### Maintenance

Your Volvo passed several major inspections before it was delivered to you, in accordance with Volvo specifications. The maintenance procedures outlined in the Warranty and Service Records Information booklet, many of which will positively affect your vehicle's emissions, should be performed as indicated. It is recommended that receipts for vehicle emission maintenance be retained in case questions arise concerning maintenance. Inspection and maintenance should also be

performed anytime a malfunction is observed or suspected.

### Applicable warranties – U.S./Canada

In accordance with applicable U.S. and Canadian regulations, the following list of warranties is provided.

- New Vehicle Limited Warranty
- Parts and Accessories Limited Warranty
- Corrosion Protection Limited Warranty
- Seat Belt and Supplemental Restraint Systems Limited Warranty
- Emission Design and Defect Warranty
- Emission Performance Warranty

These are the federal warranties; other warranties are provided as required by state/provincial law. Refer to your separate Warranty and Service Records Information booklet for detailed information concerning each of the warranties.

## Periodic maintenance helps minimize emissions



### NOTE

- Refer to your Warranty and Service Records Information booklet for a comprehensive service and maintenance schedule up to 150,000 miles (240,000 km). This program contains inspections and services necessary for the proper function of your vehicle and includes components that affect vehicle emissions.
- The Warranty and Service Records Information booklet also contains detailed information concerning the warranties that apply to your vehicle.

### Related information

- Climate – general information (p. 118)



## Maintenance – owner maintenance

Periodic maintenance requirements and intervals are described in your vehicle's *Warranty and Service Records Information* booklet.

The following points can be carried out between the normally scheduled maintenance services.

### Owner maintenance

#### Each time the car is refueled:

- Check the engine oil level.
- Clean the windshield, windshield wipers, headlights, and taillights.

#### Monthly:

- Check cold tire pressure in all tires. Inspect the tires for wear.
- Check that engine coolant and other fluid levels are between the indicated "min" and "max" markings.
- Clean interior glass surfaces with a glass cleaner and soft paper towels.
- Wipe driver information displays with a soft cloth.
- Visually inspect battery terminals for corrosion. Corrosion may indicate a loose terminal connector, or a battery near the end of its useful service life. Consult your Volvo retailer for additional information.

#### As needed:

Wash the car, including the undercarriage, to reduce wear that can be caused by a buildup

of dirt, and corrosion that can be caused by salt residues.

Clean leaves and twigs from air intake vents at the base of the windshield, and from other places where they may collect.

#### NOTE

Complete service information for qualified technicians is available online for purchase or subscription at [www.volvotechinfo.com](http://www.volvotechinfo.com).

### Related information

- Maintenance – opening/closing hood (p. 311)
- Engine compartment – overview (p. 312)
- Engine compartment – coolant (p. 315)
- Engine compartment – engine oil (p. 313)
- Engine compartment – power steering fluid (p. 317)
- Engine compartment – washer fluid (p. 328)
- Cleaning the interior (p. 345)
- Washing the car (p. 343)
- Tire inflation – checking pressure (p. 282)
- Tires – tread wear indicator (p. 275)



## Maintenance – hoisting

When the vehicle is hoisted, the jack or garage lift must be positioned in the correct lifting points.

### Hoisting the vehicle

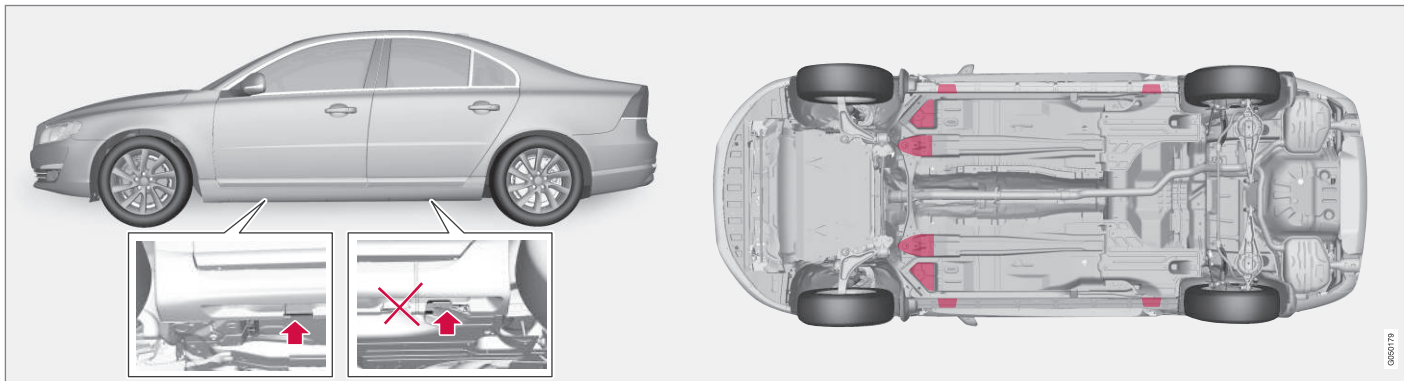

If a garage jack is used to lift the vehicle, it should be placed:

**Front:** under either of the two reinforced areas under the front section of the vehicle, **not under to jack attachment points (the outermost points shown in the illustration).**

**Rear:** Under the jack attachment points.

Ensure that the jack is positioned so that the vehicle cannot slide off it. Always use axle stands or similar structures.

### Related information

- Changing a wheel – removing wheel (p. 276)

0260719



## Onboard Diagnostic System

OBD II is part of your vehicle's computerized engine management system. It stores diagnostic information about your vehicle's emission controls. It can light the Check Engine light (MIL) if it detects an emission control "fault." A "fault" is a component or system that is not performing within an expected range. A fault may be permanent or temporary. OBD II will store a message about any fault.

## Emission inspection readiness

### How do states use OBD II for emission inspections?

Many states connect a computer directly to a vehicle's OBD II system. The inspector can then read "faults." In some states, this type of inspection has replaced the tailpipe emission test.

### How can my vehicle fail OBD II emission inspection?

Your vehicle can fail OBD II emission inspection for any of the following reasons.

- If your Check Engine (MIL) light is lit, your vehicle may fail inspection.
- If your vehicle's Check Engine light was lit, but went out without any action on your part, OBD II will still have a recorded fault. Your vehicle may pass or fail, depending on the inspection practices in your area.

- If you had recent service that required disconnecting the battery, OBD II diagnostic information may be incomplete and "not ready" for inspection. A vehicle that is not ready may fail inspection.

### How can I prepare for my next OBD II emission inspection?

- If your Check Engine (MIL) light is lit – or was lit but went out without service, have your vehicle diagnosed and, if necessary, serviced by a qualified Volvo technician.
- If you recently had service for a lit Check Engine light, or if you had service that required disconnecting the battery, a period of driving is necessary to bring the OBD II system to "ready" for inspection. Two half-hour trips of mixed stop-and-go/highway driving are typically needed to allow OBD II to reach readiness. Your Volvo retailer can provide you with more information on planning a trip.
- Maintain your vehicle in accordance with your vehicle's maintenance schedule.

## Booking service and repairs

Connected Service Booking (CSB) makes setting up a time for service, maintenance and/or repairs directly from the vehicle quick and convenient.

### Prerequisites

- The owner (primary driver) must have a valid Volvo ID. See Volvo ID (p. 20) for additional information.
- The vehicle must be connected to the Internet using a paired Bluetooth® cell phone. See your Sensus Infotainment supplement for information on pairing a cell phone. On models equipped with Volvo On Call (VOC)\*, you can connect to the Internet using your separate VOC data plan. Refer to your separate Volvo On Call manual.
- By default, the retailer where you purchased your vehicle will be your preferred (primary) retailer/Volvo authorized workshop who will perform service and repairs on your vehicle. To change the preferred retailer, go to Dealer Locator at [volvocars.com](http://volvocars.com) and select a retailer, click on Service Scheduler and book an appointment at the new preferred retailer.
- In order to be guided through the on-screen steps, the menu alternative **Display notifications** must be activated.

### CSB menu access

Once the prerequisites have been established, all CSB-related menus can be

\* Option/accessory, for more information, see Introduction.





# 10 Maintenance and servicing



accessed in **MY CAR** by pressing **OK/MENU** and then selecting **Maintenance & repair**.

## Booking information and data from the vehicle

If you request an appointment from your vehicle, with your consent, booking information and data about your vehicle<sup>1</sup> will be transmitted to your preferred retailer.

## Using the service

Once the prerequisites have been established, all CSB-related menus can be accessed in **MY CAR** by pressing **OK/MENU** and then selecting **Maintenance & repair**.

If the time for the next regularly scheduled service is approaching, if the vehicle requires certain types of repairs or if a system needs to be checked, a message will be displayed. You will then be guided through the steps required to book service or repairs.

## On-screen service messages

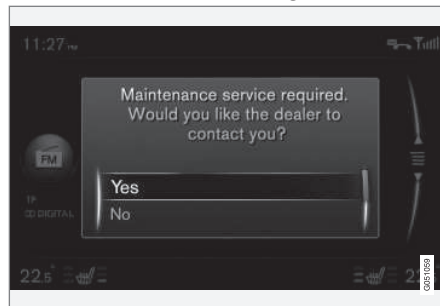

*On-screen service message*

The pop-up service alert menu offers the following alternatives:

- **Yes:** The vehicle will transmit a booking request as well as vehicle data directly to your preferred retailer. In return, you will receive an email from this retailer with a link to their booking portal. From a smartphone or a computer, you can select a day and time that suits you and specify any other service requests that you may have. When you have submitted your request, it will be entered into the retailer's booking portal and you will receive immediate confirmation online and via email. The service reminder light in the

vehicle's instrument panel will also be turned off remotely by Volvo.

- **No:** No other messages will be displayed on the Sensus screen but the Service Reminder Light on the vehicle's instrument panel will stay on. If you have answered "No", service can still be booked manually (see the following section).
- **Postpone:** The pop-up menu will be displayed that next time the engine is started.

## Booking service or repairs manually

Access your Volvo On-Line Service Scheduler portal from a smartphone or a computer to select a day and time that suits you and specify any other service requests that you may have. When you have submitted your request, it will be entered into the retailer's booking portal and you will receive immediate confirmation online and via email.

## My Appointments

This displays booking information.

- Select **Maintenance & repair** → **My Appointments**.

## Transmitting vehicle data

In order for a retailer to access vehicle data, the information is initially sent to a central Volvo database (not directly to your retailer)

<sup>1</sup> This information includes: service requirements, status of various functions, odometer reading and the vehicle's VIN number and software version.



where any retailer can access or search for this information using your vehicle's VIN number. This number can be found in your warranty booklet or on the dashboard at the lower left corner of the windshield.

- Select **Maintenance & repair** → **Send vehicle data**.

### Booking information and vehicle data

When you opt to book service from your vehicle, booking information and vehicle data will be transmitted. Vehicle data consists of a number of parameters in the following areas:

- Service requirements
- Function status
- Fluid levels
- Odometer reading (mileage)
- Vehicle Identification Number (VIN)
- The vehicle's software version

### Related information

- Volvo ID (p. 20)

### Maintenance – opening/closing hood

*The hood is opened by first releasing the lock from the passenger compartment and then pressing the release control.*

#### Opening and closing the hood

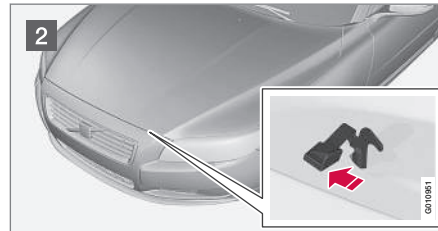

- 1 Pull the lever located under the left side of the dash to release the hood lock.
- 2 Lift the hood slightly. Press the release control (located under the right front edge of the hood) to the left, and lift the hood.

### WARNING

Check that the hood locks properly when closed.

### Related information

- Maintenance – owner maintenance (p. 307)
- Engine compartment – overview (p. 312)



## Engine compartment – overview

The overview shows the main inspection points in the engine compartment.

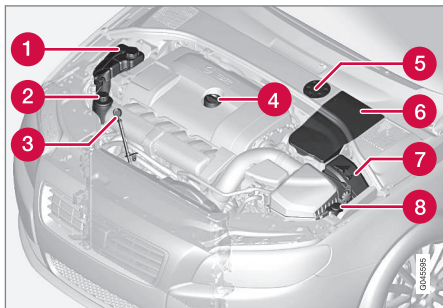

- 1 Coolant expansion tank
- 2 Power steering fluid reservoir
- 3 Dipstick-engine oil
- 4 Filler cap-engine oil
- 5 Cover over brake fluid reservoir
- 6 Battery
- 7 Relay/fuse box
- 8 Washer fluid reservoir

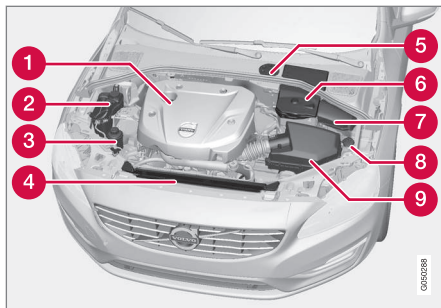

Engine compartment - 4-cylinder engines only

- 1 Filler cap-engine oil
- 2 Coolant expansion tank
- 3 Power steering fluid reservoir
- 4 Radiator
- 5 Brake fluid reservoir
- 6 Battery
- 7 Relay/fuse box
- 8 Washer fluid reservoir
- 9 Air cleaner

The appearance of the engine compartment may vary depending on engine model.

## WARNING

The cooling fan (located at the front of the engine compartment, behind the radiator) may start or continue to operate (for up to 6 minutes) after the engine has been switched off.

## WARNING

Before performing any operations in the engine compartment, the ignition should always be completely switched off (in mode **0**, see Ignition modes (p. 73)) and there should be no remote keys in the passenger compartment. The gear selector should be in the **P** (park) position. If the engine has been running, wait until it has cooled before touching any components in the engine compartment.

The distributor ignition system operates at very high voltages. Special safety precautions must be followed to prevent injury. Always turn the ignition off when:

- Replacing distributor ignition components e.g. plugs, coil, etc.
- Do not touch any part of the distributor ignition system while the engine is running. This may result in unintended movements and body injury.



### Related information

- Maintenance – opening/closing hood (p. 311)
- Maintenance – owner maintenance (p. 307)

### Engine compartment – engine oil

*The correct oil must be used for the stated oil change (service) intervals to apply.*

*The oil level on 4-cylinder engines is checked electronically and is checked using a dipstick on 5- and 6-cylinder engines.*

#### Checking the engine oil (5- and 6-cylinder engines)

The oil level should be checked at regular intervals, particularly during the period up to the first scheduled maintenance service.

- See Oil specifications (p. 358) for oil specifications.
- Also, refer to the Warranty and Service Records information booklet for information on oil change intervals and oil specifications.



### CAUTION

- Not checking the oil level regularly can result in serious engine damage if the oil level becomes too low.
- Oil that is lower than the specified quality can damage the engine.
- Volvo does not recommend the use of oil additives.
- Always add oil of the same type and viscosity as already used.
- Never fill oil above the **MAX** mark. This could cause an increase in oil consumption.
- Oil changes should be carried out by a trained and qualified Volvo service technician.



# 10 Maintenance and servicing



## Checking and adding oil

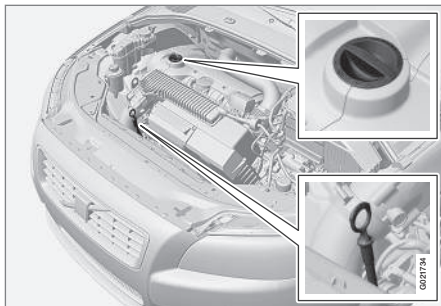

Location of the filler cap and dipstick

### **i** NOTE

Before checking the oil:

- The car should be parked on a level surface.
- **If the engine is warm**, wait for at least 10 – 15 minutes after the engine has been switched off.

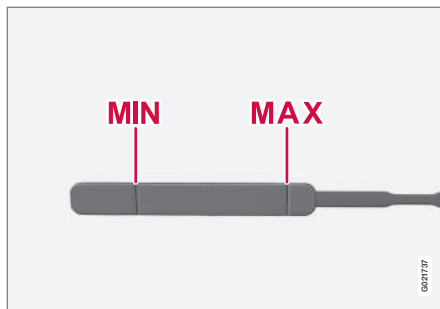

The oil level must be between the **MIN** and **MAX** marks on the dipstick

### Checking the oil

1. Pull out the dipstick and wipe it with a lint-free rag.
2. Reinsert the dipstick, pull it out, and check the oil level. The level must be between the **MIN** and **MAX** marks.
3. Add oil if necessary. If the level is close to the **MIN** mark, add approximately 0.5 US quarts (0.5 liters) of oil.
4. Recheck the level and add more oil if necessary until the level is near the **MAX** mark.

### **!** WARNING

Do not allow oil to spill onto or come into contact with hot exhaust pipe surfaces.

## Electronic oil level sensor (4-cylinder engines only)



Oil filler cap

No action is necessary until a message is displayed, see the following illustration.

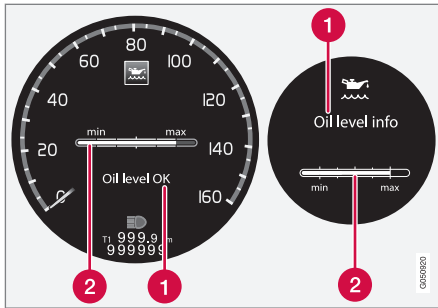

Left: digital instrument panel\*, Right: analog instrument panel

- 1 Message
- 2 Oil level

The oil level can be checked when the engine is not running by scrolling to the oil level sensor using the thumb wheel on the left steering wheel lever.

### CAUTION

- If **Oil service required** is displayed, the oil level may be too high. Take the vehicle to an authorized Volvo workshop as soon as possible.
- If the oil level sensor indicates that the level is too low, using the correct oil, top up with the amount of oil indicated as soon as possible, see oil specifications (p. 358).

### WARNING

Do not allow oil to spill onto or come into contact with hot exhaust pipe surfaces.

### Electronically checking the oil level

The oil level should be checked at regular intervals, particularly during the period up to the first scheduled maintenance service.

To check the oil level:

1. Activate ignition mode **II**, see Ignition modes (p. 73).
2. Turn the thumb wheel on the left steering wheel lever until **Oil level** is displayed.
  - > The oil level will be displayed.

### NOTE

- The system cannot detect changes in the oil level immediately. The vehicle must be driven approximately 20 miles (30 km) or have been parked on level ground with the engine off for 2 hours before the oil level reading will be correct.
- If the necessary conditions are not met for checking the oil level electronically (time interval after the engine was switched off, if the vehicle is parked on an incline, etc.), **Not available** will be displayed. This does **not** indicate a problem with the oil level sensor.

### Engine compartment – coolant

Normally, the coolant does not need to be changed. If the system must be drained, consult a trained and qualified Volvo service technician.

### Level check and filling

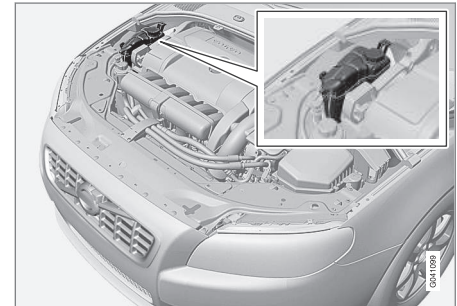

Location of the coolant reservoir

See Fuel tank volume – specification and volume (p. 361) for information on cooling system capacities.



## CAUTION

- If necessary, top up the cooling system with Volvo Genuine Coolant/Antifreeze only (a 50/50 mix of water and antifreeze).
- Different types of antifreeze/coolant may not be mixed.
- If the cooling system is drained, it should be flushed with clean water or premixed anti-freeze before it is refilled with the correct mixture of water/antifreeze.
- The cooling system must always be kept filled to the correct level, and the level must be between the **MIN** and **MAX** marks. If it is not kept filled, there can be high local temperatures in the engine which could result in damage. Check coolant regularly!
- Do not top up with water only. This reduces the rust-protective and anti-freeze qualities of the coolant and has a lower boiling point. It can also cause damage to the cooling system if it should freeze.
- Do not use chlorinated tap water in the vehicle's cooling system.

## WARNING

- Never remove the expansion tank cap while the engine is warm. Wait until the engine cools.
- If it is necessary to top off the coolant when the engine is warm, unscrew the expansion tank cap slowly so that the overpressure dissipates.

## Engine compartment – brake fluid

The brake fluid should always be between the **MIN** and **MAX** marks on the inside of the reservoir.

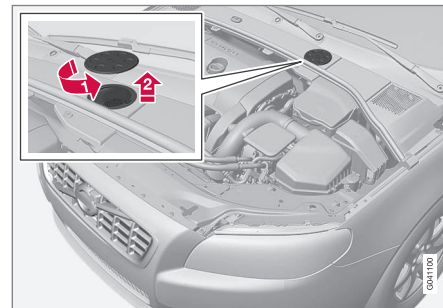

Location of the brake fluid reservoir



### Checking the level

The fluid reservoir is concealed under the round cover at the rear of the engine compartment. The round cover must be removed first before the reservoir cap can be accessed.

Check, without removing the cap, that there is sufficient fluid in the reservoir.

**Fluid type:** DOT 4 boiling point >536 °F (>280 °C).

**Replace:** The fluid should be replaced according to the intervals specified in the Warranty and Service Records Information booklet.

When driving under extremely hard conditions (mountain driving, etc), it may be necessary to replace the fluid more often. Consult a trained and qualified Volvo service technician.

Always entrust brake fluid changing to a trained and qualified Volvo service technician.

### WARNING

- If the fluid level is below the **MIN** mark in the reservoir or if a brake-related message is shown in the information display: **DO NOT DRIVE**. Have the car towed to a trained and qualified Volvo service technician and have the brake system inspected.
- Dot 4 should never be mixed with any other type of brake fluid.

### Filling

1. Turn and open the cover.
2. Unscrew the reservoir cap and fill the fluid. The level must be between the **MIN** and **MAX** marks.

### Engine compartment – power steering fluid

The fluid level must be between the **MIN** and **MAX** marks. For capacities and recommended fluid grade, see Fuel tank volume – specification and volume (p. 361).

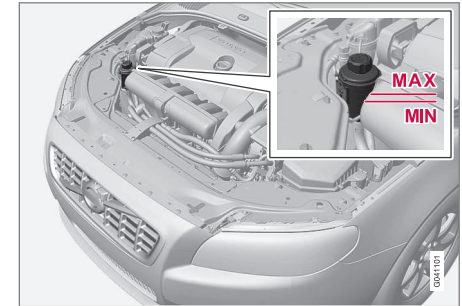

Check the level frequently. It does not normally require changing.

### WARNING

If a problem should occur in the power steering system or if the vehicle has no electrical current and must be towed, it is still possible to steer the vehicle. However, keep in mind that greater effort will be required to turn the steering wheel.



## CAUTION

Keep the area around the power steering fluid reservoir clean when checking.

## Bulbs – introduction

*Certain bulbs can be replaced by the vehicle's owner. However, the bulbs on the following list should only be replaced by a trained and qualified Volvo service technician.*

All bulb specifications are listed in Bulbs – specifications (p. 325).

- Active Bending Lights
- Front parking lights
- Daytime running lights
- Turn signals in the door mirrors
- Approach lighting in the door mirrors
- Interior lighting
- Rear parking lights
- Rear side marker lights
- Brake lights
- LED bulbs

## NOTE

- For information regarding any bulbs not mentioned in this section, please contact your Volvo retailer or a trained and authorized Volvo service technician.
- Always switch off the ignition before starting to replace a bulb.
- If an error message remains in the display after a faulty bulb has been replaced, contact an authorized Volvo workshop.
- Condensation may form temporarily on the inside of the lenses of exterior lights such as headlights, fog lights, or taillights. This is normal and the lights are designed to withstand moisture. Normally, condensation will dissipate after the lights have been on for a short time.
- The optional Active Bending Light bulbs contain trace amounts of mercury. These bulbs should always be disposed of by a trained and qualified Volvo service technician.



## ! CAUTION

Never touch the glass of bulbs with your fingers. Grease and oils from your fingers vaporize in the heat and will leave a deposit on the reflector, which will damage it.

## ! WARNING

- The engine should not be running when changing bulbs.
- If the engine has been running just prior to replacing bulbs in the headlight housing, please keep in mind that components in the engine compartment will be hot.

## ! WARNING

- Active Bending Lights\* – due to the high voltage used by these headlights, these bulbs should only be replaced by a trained and qualified Volvo service technician.
- Turn off the lights and remove the remote key from the ignition before changing any bulbs.

### Related information

- Bulbs – headlight housing (p. 319)
- Bulbs – taillight housing (p. 323)
- Bulbs – vanity mirror lighting (p. 325)
- Bulbs – license plate lighting (p. 324)

## Bulbs – headlight housing

The entire headlight housing must be lifted out when replacing all front bulbs.

### Removing the headlight housing

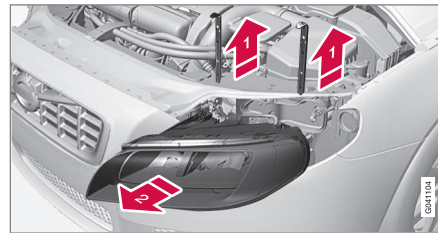

- ➔ Pull out the headlight housing's locking pins.
- ➔ Pull the headlight housing straight out.

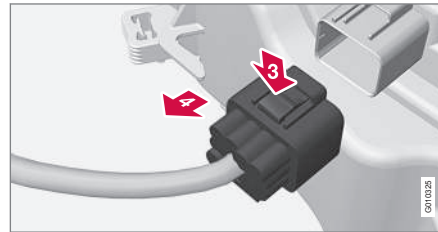

## ! CAUTION

When disconnecting the connector, pull on the connector itself and not on the wiring.

- ➔ Unplug the wiring connector by holding down the clip with your thumb.
- ➔ Pull the connector out with the other hand.
5. Lift out the headlight housing and place it on a soft surface to avoid scratching the lens.
6. Replace the defective bulb(s).

### Reinserting the headlight housing

1. Plug in the connector until it clicks into place.
2. Reinstall the headlight housing and locking pins. Check that they are correctly inserted.

The headlight housing must be properly in place and the wiring connector correctly reconnected before the lighting is switched on or the remote key is inserted into the ignition slot.

3. Check that the lights function properly.

### Related information

- Bulbs – introduction (p. 318)
- Bulbs – cover (p. 320)
- Bulbs – specifications (p. 325)



## Bulbs – cover

The larger cover has to be removed in order to change the high/low beam headlight bulbs.

### Removing the cover to access the bulbs

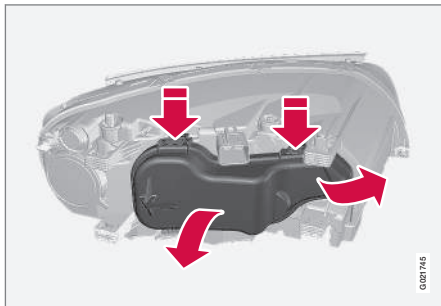

#### **i** NOTE

Before starting to replace a bulb, see Bulbs – introduction (p. 318).

1. Open the retaining clamp by pressing it upward/outward.
2. Press down the clips on the cover and remove it.

Reinstall the cover in the reverse order.

### Related information

- Bulbs – headlight housing (p. 319)
- Bulbs – low beam, Halogen (p. 320)
- Bulbs – high beam, Halogen (p. 321)

- Bulbs – extra high beam (p. 321)

## Bulbs – low beam, Halogen

The low beam bulb is concealed by the larger cover.

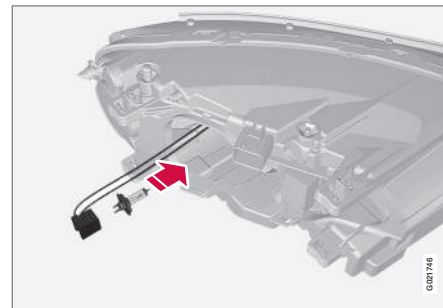

1. Remove the headlight housing from the vehicle (see Bulbs – headlight housing (p. 319)).
2. Remove the cover over the bulbs (see Bulbs – cover (p. 320)).
3. Unplug the connector from the bulb.
4. Remove the bulb by pressing the holder downward.
5. Press the new bulb into the socket until it snaps into place. It can only be secured in one position.
6. Put the cover back into position and reinstall the headlight housing.

### Related information

- Bulbs – specifications (p. 325)



### Bulbs – high beam, Halogen

The high beam bulb is concealed behind the larger cover.

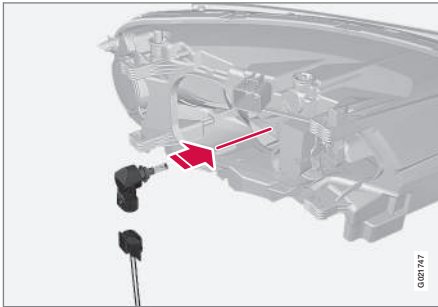

1. Remove the headlight housing from the vehicle (see Bulbs – headlight housing (p. 319)).
2. Remove the cover over the bulbs (see Bulbs – cover (p. 320)).
3. Remove the bulb by turning it counter-clockwise and pulling it straight out.
4. Remove the connector from the bulb.
5. Press the new bulb into the socket and turn it clockwise to put it in place. It can only be secured in one position.
6. Reinsert the bulb holder into the headlight housing.
7. Put the cover back into position and reinstall the headlight housing.

### Related information

- Bulbs – specifications (p. 325)

### Bulbs – extra high beam

The extra high beam bulb is concealed by the larger cover.



## Extra high beam<sup>2</sup>

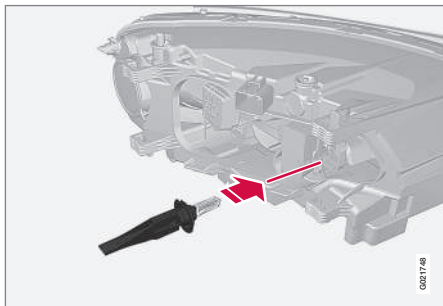

1. Remove the headlight housing from the vehicle (see Bulbs – headlight housing (p. 319)).
2. Remove the cover over the bulbs (see Bulbs – cover (p. 320)).
3. Remove the bulb by pressing the holder downward.
4. Remove the connector from the bulb.
5. Insert a new bulb in the connector until it snaps in place. It can only be inserted in one way.
6. Return the bulb holder into position in the headlight housing.
7. Put the cover back into position and reinstall the headlight housing.

## Related information

- Bulbs – specifications (p. 325)

## Bulbs – front turn signals

*The turn signal bulb is concealed behind the smaller cover.*

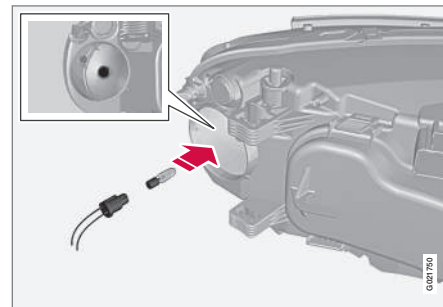

1. Remove the headlight housing from the vehicle (see Bulbs – headlight housing (p. 319)).
2. Remove the round cover by pulling the tab until the cover comes off.
3. Pull out the holder to access the bulb.
4. Pull out the burned out bulb and press a new bulb into the socket. It can only be secured in one position.
5. Press the bulb holder into the socket and press until it clicks into place.
6. Press the cover in place until it clicks into position.

<sup>2</sup> Models with optional Active Bending Lights only.



7. Reinstall the headlight housing.

## Related information

- Bulbs – specifications (p. 325)

## Bulbs – front side marker lights

The side marker bulb is concealed behind the smaller cover.

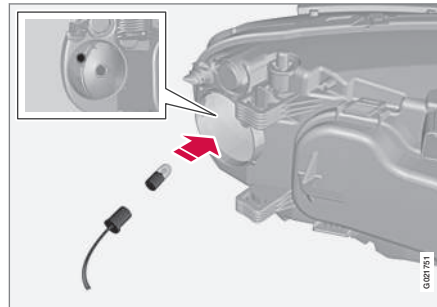

1. Remove the headlight housing from the vehicle (see Bulbs – headlight housing (p. 319)).
2. Remove the small round cover over the bulbs.
3. Pull the wire to withdraw the bulb holder.
4. Pull out the burned out bulb and press a new bulb into the socket. It can only be secured in one position.
5. Press the bulb holder into the socket and press until it clicks into place.
6. Press the cover in place until it clicks into position.

## Related information

- Bulbs – specifications (p. 325)

## Bulbs – taillight housing

The bulbs in the taillight cluster are replaced from inside the trunk (not the LED functions).

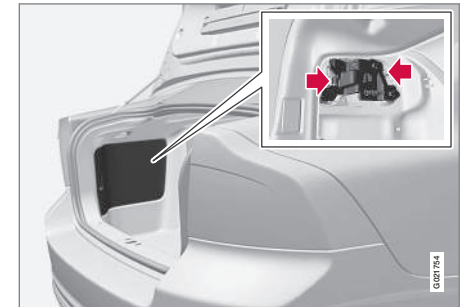

1. Remove the covers in the left/right panel to access the bulbs. The bulbs are located in separate bulb holders.
2. Press the catches together and pull out the bulb holder.
3. Remove the defective bulb by pressing it in slightly and turning it before pulling it out.
4. Insert a new bulb, press it in and turn it clockwise.
5. Plug in the connector.
6. Press the bulb holder back into place and reinstall the cover.

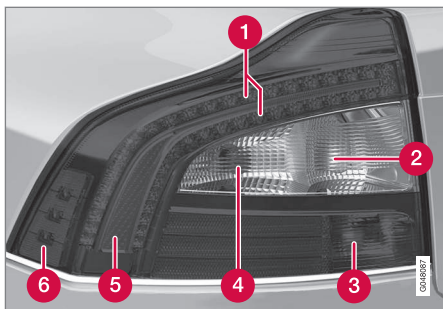

Taillight lens, right side

- 1 Brake light (LEDs)
- 2 Backup light
- 3 Rear fog light
- 4 Turn signal
- 5 Parking light (LEDs)
- 6 Side marker lights (LEDs)

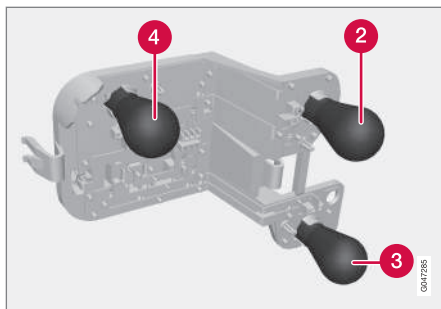

Taillight bulb holder

- 2 Backup light
- 3 Rear fog light
- 4 Turn signal

### Related information

- Bulbs – introduction (p. 318)
- Bulbs – specifications (p. 325)

### Bulbs – license plate lighting

The license plate lighting is located next to the trunk handle.



1. Remove the screws with a screwdriver.
2. Carefully detach the entire bulb housing and pull it out.
3. Replace the bulb.
4. Reinsert the entire bulb housing and tighten the screws.

### Related information

- Bulbs – specifications (p. 325)



## Bulbs – trunk lighting

The trunk lighting is located on opposite sides of the trunk.

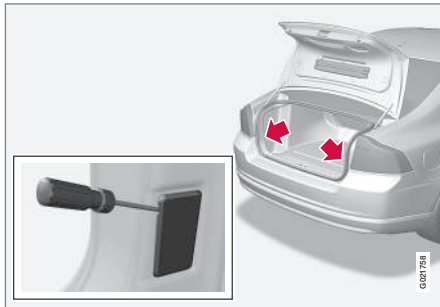

1. Insert a screwdriver and gently turn so that the bulb housing comes loose.
2. Replace the bulb.
3. Check that the bulb illuminates and press it back into the bulb housing.

### Related information

- Bulbs – specifications (p. 325)

## Bulbs – vanity mirror lighting

The vanity mirror bulbs are located behind the lens.

### Removing the lens

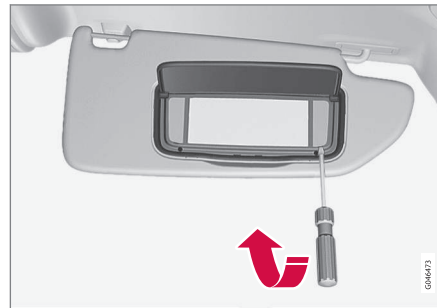

1. Insert a flat screwdriver under the lens and carefully exert upward pressure to release the retaining lugs.
2. Snap out the lens.
3. Use needle nose pliers to pull the bulb straight to the side. Replace the bulb. Do not exert too much pressure on the bulb with the pliers to help avoid damaging it.

### Reinstalling the lens

1. Put the lens back into position.
2. Press it into place.

### Related information

- Bulbs – specifications (p. 325)

## Bulbs – specifications

The following bulbs can be replaced by the vehicles owner. All other bulbs should only be replaced by a trained and qualified Volvo service technician.

Lighting function	Wattage	Bulb
Extra high beam (models with Active Bending Lights*)	55	H7 LL
Low beam (halogen)	55	H11 LL
High beam (halogen)	65	H9
Rear fog light	21	P21W LL
Brake lights	21	P21W LL
Backup lights	21	P21W LL
Rear turn signals	21	PY21W SV
Front turn signals	21	H21W LL
License plate lighting	5	C5W LL



Lighting function	Wattage	Bulb
Vanity mirror	2	W2x4.6d type T5
Front side marker lights	5	W5W LL
Glove compartment lighting	5	SV8.5 (length 43mm)
Trunk lighting	5	SV8.5 (length 38mm)

## NOTE

Please consult a Volvo retailer's Parts department for the most up-to-date bulb specifications.

## Related information

- Bulbs – introduction (p. 318)

## Wiper blades – service position

The windshield wiper blades must be in the vertical (service) position for replacement, washing or to lift them away from the windshield when e.g., removing ice or snow.



Wiper blades in service position

## CAUTION

Be sure the wiper blades are not frozen in position before attempting to move them to the service position.

To put the windshield wipers in the service position:

1. Insert the remote key into the ignition slot<sup>3</sup> and press the **START/STOP ENGINE** button briefly to put the ignition in mode **I** (see Ignition modes (p. 73) for detailed information about the ignition modes).
2. Press the **START/STOP ENGINE** button again briefly to switch the ignition off.
3. Within 3 seconds, move the right steering wheel lever up and hold it for at least 1 second.
  - > The wipers will then move to the vertical (service) position on the windshield.

The wipers can be returned to the normal position by pressing the **START/STOP ENGINE** button briefly to put the ignition in mode **I** (or by starting the engine).

## CAUTION

If the wiper arms have been folded out from the windshield while in the service position, fold them back against the windshield before returning the wipers to the normal position to help avoid scratching the paint on the hood.

<sup>3</sup> Not necessary on vehicles with the optional keyless drive.



### Related information

- Engine compartment – washer fluid (p. 328)

### Wiper blades – windshield

The wiper blades should be replaced regularly for best effect.

The windshield wiper blades must be in the vertical (service) position for replacement, washing or to lift them away from the windshield when e.g., removing ice or snow.

### Replacing the windshield wiper blades

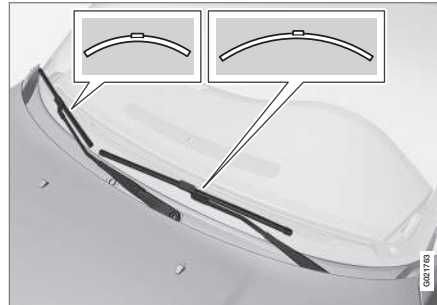

#### **i** NOTE

The windshield wiper blades are different lengths. The blade on the driver's side is longer than the one on the passenger side.

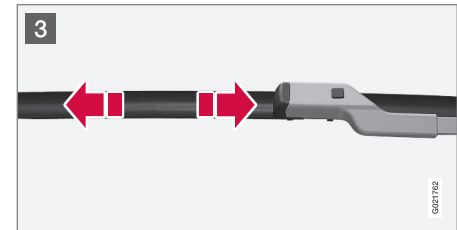
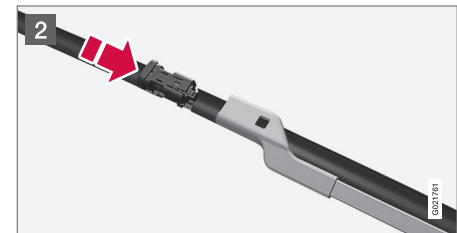
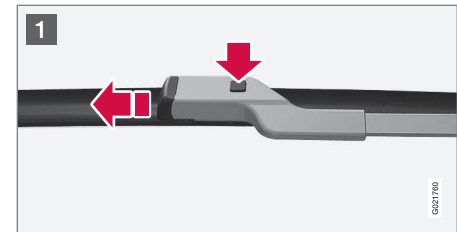



- 1 With the wipers in the service position, fold out the wiper arm from the windshield. Press the button on the wiper blade attachment and pull the wiper blade straight out, parallel with the wiper arm.
- 2 Slide in the new wiper blade until it clicks into place.
- 3 Check that the blade is securely in place.
4. Press the wipers back against the windshield.

To return the wipers from the service position to the normal position, fold the wipers back against the windshield and press the **START/STOP ENGINE** button briefly to put the ignition in mode **I** (or start the engine).

## Cleaning

Keeping the windshield and wiper blades clean helps improve visibility and prolongs the service life of the wiper blades. Clean the wiper blades with a stiff-bristle brush and lukewarm soap solution or car washing detergent.

## Related information

- Engine compartment – washer fluid (p. 328)
- Wiper blades – service position (p. 326)

## Engine compartment – washer fluid

Washer fluid helps keep the windshield and headlights clean. During cold weather, the reservoir should be filled with windshield washer solvent containing antifreeze. Use Volvo Original Washer Fluid or the equivalent with a recommended pH value between 6 and 8.

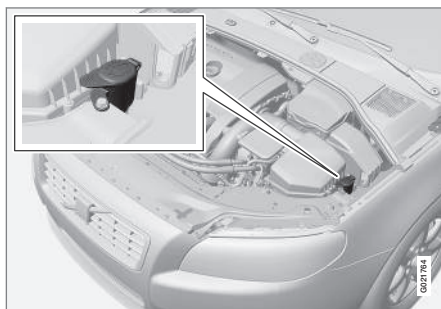

Location of the washer fluid reservoir

The windshield and headlight washers share a common reservoir.

The washer fluid reservoir is located on the driver's side of the engine compartment. For capacities, see Fuel tank volume – specification and volume (p. 361).

## Related information

- Wiper blades – service position (p. 326)

## Battery – symbols

There are information and warning symbols on the battery.

### Symbols on the battery

	Wear protective goggles.
	Keep away from children.
	Avoid smoking, open flames, and/or sparks.
	See the owner's manual.



	Contains corrosive acid.
	Risk of explosion
	Recycle properly

**i NOTE**

A used battery should be disposed of in an environmentally responsible manner. Consult your Volvo retailer or take the battery to a recycling station.

**Related information**

- Battery – changing (p. 331)
- Battery – handling (p. 329)
- Battery – maintenance (p. 330)

**Battery – handling**

*The battery's service life is affected by the number of starts, if it has been discharged, driving style, driving conditions, weather conditions, etc.*

**Handling**

- Check that the battery cables are correctly connected and tightened.
- Never disconnect the battery when the engine is running (for example, when replacing the battery).
- If the battery is fully discharged a number of times, this may shorten its service life.
- The service life of a battery is affected by factors such as the number of starts, driving conditions and climate. Extreme cold may also further decrease the battery's starting capacity.
- Because the battery's starting capacity decreases with time, it may be necessary to recharge it if the vehicle is not driven for an extended period of time or if the vehicle is usually only driven short distances.
- Never use a quick charger to charge the battery. Only traditional types of battery chargers should be used.

**! CAUTION**

The infotainment system's energy-saving feature may not function correctly or at all, and/or a message may be displayed if a battery charger or jumper cables are not connected properly.

- The negative terminal on the battery must **never** be used to connect a jumper cable or a battery charger. Only the ground point on the chassis may be used.

See Jump starting (p. 237) for an illustration and additional information.

**! WARNING**

- Never expose the battery to open flame or electric spark.
- Do not smoke near the battery.
- Battery fluid contains sulfuric acid. Do not allow battery fluid to contact eyes, skin, fabrics or painted surfaces. If contact occurs, flush the affected area immediately with water. Obtain medical help immediately if eyes are affected.

**i NOTE**

The life of the battery is shortened if it becomes discharged repeatedly.



## Related information

- Battery – changing (p. 331)
- Battery – maintenance (p. 330)
- Battery – symbols (p. 328)

## Battery – maintenance

*Proper battery maintenance can help prolong its service life.*

### Maintenance

- Use a screw driver to open the caps or cover and a flashlight to inspect the level.
- If necessary, add distilled water. The level should never be above the indicator.
- The fluid level should be checked if the battery has been recharged.
- After inspection, be sure the cap over each battery cell or the cover is securely in place.
- Check that the battery cables are correctly connected and properly tightened.
- Never disconnect the battery when the engine is running, or when the key is in the ignition. This could damage the vehicle's electrical system.
- The battery should be disconnected from the vehicle when a battery charger is used directly on the battery.
- To help keep the battery in good condition, the vehicle should be driven for at least 15 minutes a week or connected to a charger with an automatic charging function.
- If the battery is fully discharged a number of times, this may shorten its service life. Keeping the battery fully charged helps prolong its service life.

- The service life of a battery is affected by factors such as driving conditions and climate. Extreme cold may also further decrease the battery's starting capacity.
- Because the battery's starting capacity decreases with time, it may be necessary to recharge it if the vehicle is not driven for an extended period of time or if the vehicle is usually only driven short distances.



### CAUTION

- Always use distilled or deionized water (battery water).
- Never fill above the level mark in the cell.

### Related information

- Battery – changing (p. 331)
- Battery – handling (p. 329)
- Battery – symbols (p. 328)



## Battery – changing

When changing batteries, be sure to use the correct battery for your vehicle. Consult a Volvo retailer or a trained and qualified Volvo service technician.

### Changing

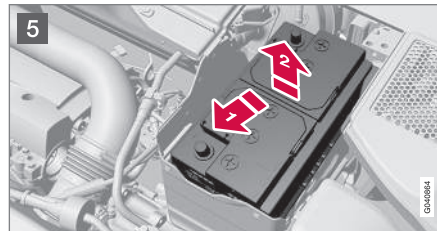
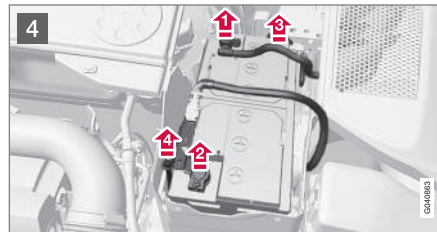
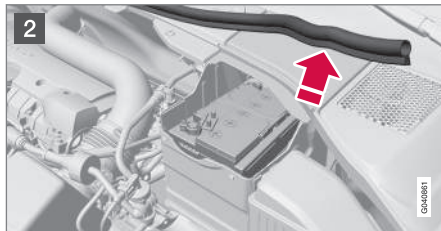
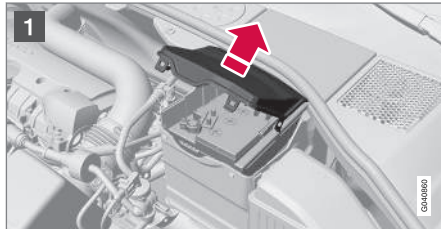





### WARNING

Connect and disconnect the positive and negative cables in the correct sequence.

### Removal

Switch off the ignition, remove the remote key from the ignition slot and wait at least 5 minutes before disconnecting the battery so that all information in the vehicle's electrical system can be stored in the control modules.

- 1 Open the clips on the front cover and remove the cover.
- 2 Release the rubber molding so that the rear cover is free.
- 3 Remove the rear cover by pulling it away.
- 4  Detach the black negative cable.
-  Detach the red positive cable
-  Detach the ventilation hose from the battery
-  Loosen the screw holding the battery clamp.
- 5 Move the battery to the side and lift it up.

### WARNING

#### PROPOSITION 65 WARNING!

Battery posts, terminals, and related accessories contain lead and lead compounds, chemicals known to the state of California to cause cancer and reproductive harm. Wash hands after handling.



# 10 Maintenance and servicing



## Installation

1. Lower the battery into the battery box.

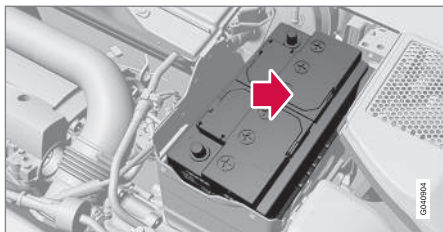

2. Move the battery inward and to the side until it reaches the rear edge of the box.
3. Tighten the clamp that secures the battery.
4. Connect the ventilation hose.
  - > Be sure that it is correctly connected to the battery and the vent in the vehicle's body.
5. Connect the red positive cable.
6. Connect the black negative cable.
7. Press in the rear cover. (See Removal).
8. Reinstall the molding. (See Removal).
9. Reinstall the front cover and secure it with the clips. (See Removal).

## Related information

- Battery – handling (p. 329)
- Battery – symbols (p. 328)

## Fuses – introduction

*The fuses help protect the vehicle's electrical components from overloading.*

There are relay/fuseboxes located in the engine compartment, the passenger compartment and the trunk.

If an electrical component fails to function, this may be due to a blown fuse. The easiest way to see if a fuse is blown is to remove it.

To do so:

1. Pull the fuse straight out. If a fuse is difficult to remove, **a special fuse removal tool is located on the inside of the engine compartment fusebox cover.**
2. From the side, examine the curved metal wire in the fuse to see if it is intact.

If the wire is broken, insert a new fuse of the same color and amperage (written on the fuse).

If fuses burn out repeatedly, have the electrical system inspected by a trained and qualified Volvo service technician.



## WARNING

Never use metal objects or fuses with higher amperage than those stated on the following pages. Doing so could seriously damage or overload the vehicle's electrical system.

## Location of the fuseboxes

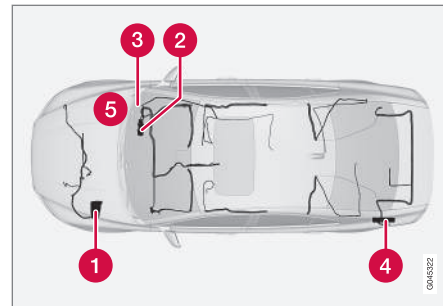

- 1 Engine compartment
- 2 Under the glove compartment
- 3 Under the glove compartment
- 4 Trunk
- 5 Engine compartment cold zone (Start/Stop only)



## Fuses – engine compartment

The fuses in the engine compartment protect e.g., engine and brake functions.

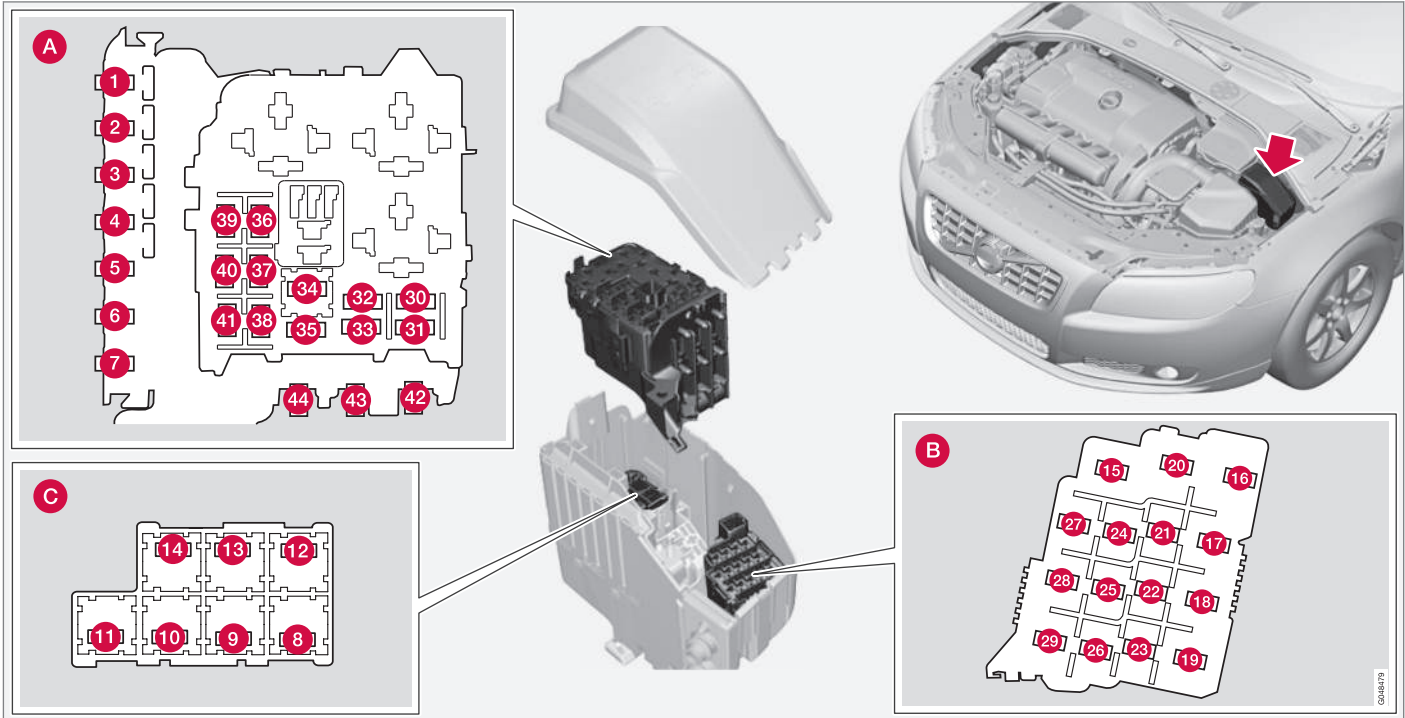



# 10 Maintenance and servicing



- A** Engine compartment, upper
- B** Engine compartment, front
- C** Engine compartment, lower

## Positions

These fuses are all located in the engine compartment box. Fuses in **C** are located under **A**.

A decal on the inside of the cover shows the positions of the fuses.

- Fuses 1 – 15, 34 and 42 – 44 are relays/circuit breakers and should only be removed or replaced by a trained and qualified Volvo service technician.
- Fuses 16 – 33 and 35 – 41 may be changed at any time when necessary.

There is a special fuse removal tool on the underside of the cover.

Pos	Function	A
<b>1</b>	Circuit breaker: central electrical module under the glove compartment <sup>A</sup>	50
<b>2</b>	Circuit breaker: central electrical module under the glove compartment	50

Pos	Function	A
<b>3</b>	Circuit breaker: central electrical module in the trunk <sup>A</sup>	60
<b>4</b>	Circuit breaker: central electrical module under the glove compartment <sup>A</sup>	60
<b>5</b>	Circuit breaker: central electrical module under the glove compartment <sup>A</sup>	60
<b>6</b>	–	
<b>7</b>	–	
<b>8</b>	Headed windshield*, driver's side	40
<b>9</b>	Windshield wipers	30
<b>10</b>	–	
<b>11</b>	Climate system blower <sup>A</sup>	40
<b>12</b>	Headed windshield*, passenger's side	40
<b>13</b>	ABS pump	40

Pos	Function	A
<b>14</b>	ABS valves	20
<b>15</b>	Headlight washers	20
<b>16</b>	Active Bending Lights-headlight leveling*	10
<b>17</b>	Central electrical module (under the glove compartment)	20
<b>18</b>	ABS	5
<b>19</b>	Adjustable steering force*	5
<b>20</b>	Engine Control Module (ECM), transmission, SRS	10
<b>21</b>	Heated washer nozzles*	10
<b>22</b>	–	
<b>23</b>	Lighting panel	5
<b>24</b>	–	
<b>25</b>	–	
<b>26</b>	–	
<b>27</b>	Relay coils	5



Pos	Function	A
28	Auxiliary lights*	20
29	Horn	15
30	Relay coils, Engine Control Module (ECM)	10
31	Control module - automatic transmission	15
32	A/C compressor (not 4-cyl. engines)	15
33	Relay-coils A/C, relay coils in engine compartment cold zone for Start/Stop	5
34	Starter motor relay <sup>A</sup>	30
35	Engine control module (4-cyl. engines) Ignition coils (5-/6-cyl. engines), condenser (6-cyl. engines)	20
36	Engine Control Module (4-cyl. engines)	20
	Engine Control Module (5-cyl. & 6-cyl. engines)	10

Pos	Function	A
37	4-cyl. engines: mass air meter, thermostat, EVAP valve	10
	5-/6-cyl. engines: Injection system, mass air meter (6-cyl. engines only), engine control module	15
38	A/C compressor (5-/6-cyl. engines), engine valves, engine control module (6-cyl. engines), solenoids (6-cyl. non-turbo only), mass air meter (6-cyl. only)	10
39	Engine valves/oil pump/center heated oxygen sensor (4-cyl. engines)	15
	Front/rear heated oxygen sensors (4-cyl. engines), EVAP valve (5-/6-cyl. engines), heated oxygen sensors (5-/6-cyl. engines)	15

Pos	Function	A
40	Oil pump/crankcase ventilation heater/coolant pump (5-cyl. engines)	10
	Ignition coils (4-cyl. engines)	15
41	Fuel leakage detection (5-/6-cyl. engines), control module for radiator shutter (5-cyl. engines)	5
	Fuel leakage detection, A/C solenoid (4-cyl. engines)	7.5
42	Coolant pump (4-cyl. engines)	50
43	Cooling fan	60 (4/5-cyl. engines)
		80 (6-cyl. engines)
44	Power steering	100

<sup>A</sup> This position is not used on vehicles with the optional Start/Stop function, refer to the table "Engine compartment cold zone" in Fuses – engine compartment cold zone (Start/Stop only) (p. 341).

10





## 10 Maintenance and servicing



### **Related information**

- Fuses – glove compartment (p. 337)
- Fuses – cargo area/trunk (p. 340)



## Fuses – glove compartment

The fuses under the glove compartment protect components such as the infotainment system and optional power seat.

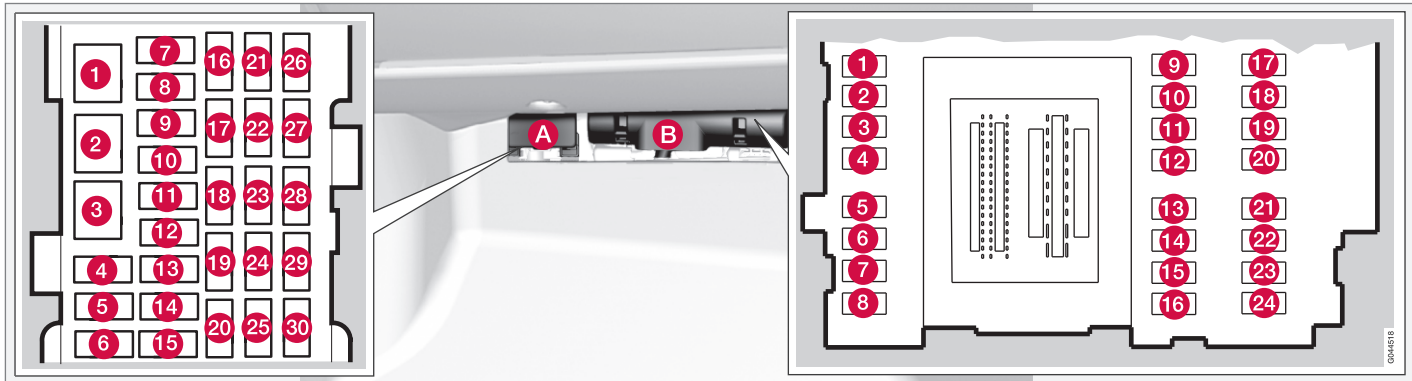

**Fusebox A:** General fuses

**Fusebox B:** Control module fuses

Fold aside the upholstery covering the fuse-boxes.

1. Press the cover's lock and fold it up.
2. The fuses are accessible.

### Positions: fusebox A

Pos	Function	A
1	Circuit breaker for the infotainment system and for fuses 16-20	40
2	-	
3	-	
4	Heated steering wheel*	10
5	Analog clock (Executive)	5

Pos	Function	A
6	-	
7	12-volt socket (trunk), refrigerator (S80 Executive only)	15
8	Controls in driver's door	20
9	Controls in front passenger's door	20
10	Controls in right rear passenger's door	20

\* Option/accessory, for more information, see Introduction.





# 10 Maintenance and servicing



Pos	Function	A
11	Controls in left rear passenger's door	20
12	Keyless drive*	20
13	Power driver's seat*	20
14	Power front passenger's seat*	20
15	-	
16	Infotainment system display	5
17	Infotainment system: amplifier, SiriusXM™ satellite radio*	10
18	Sensus control module	15
19	Bluetooth hands-free system	5
20	-	
21	Power moonroof* Courtesy lighting, climate system sensor	5
22	12-volt sockets in tunnel console	15
23	Heated rear seat* (passenger's side)	15
24	Heated rear seat* (driver's side)	15

Pos	Function	A
25	-	
26	Heated front passenger's seat*	15
27	Heated driver's seat*	15
28	Park assist*, trailer hitch control module*, park assist camera*	5
29	All Wheel Drive* control module	15
30	Active chassis system*	10

## Positions: fusebox B

Pos	Function	A
1	-	
2	-	
3	Front courtesy lighting, driver's door power window controls, power seat(s)*, Home-Link® Wireless Control System*	7.5
4	Instrument panel	5
5	Adaptive cruise control/collision warning*	10

Pos	Function	A
6	Courtesy lighting, rain sensor*	7.5
7	Steering wheel module	7.5
8	Central locking: fuel filler door	10
9	-	
10	Windshield washers	15
11	Trunk open	10
12	Electrical folding rear seat outboard head restraints*	10
13	Fuel pump	20
14	Climate system control panel	5
15	-	
16	Alarm, On-board diagnostic system	5
17	-	
18	Airbag system, occupant weight sensor	10
19	Collision warning system*	5
20	Accelerator pedal sensor, auto-dim mirror function, heated rear seats*	7.5



Pos	Function	A
21	-	
22	Brake lights	5
23	Power moonroof*	20
24	Immobilizer	5

#### Related information

- Fuses – engine compartment (p. 333)
- Fuses – cargo area/trunk (p. 340)
- Fuses – engine compartment cold zone (Start/Stop only) (p. 341)



# 10 Maintenance and servicing

## Fuses – cargo area/trunk

The fuses in the cargo area/trunk protect components such as trailer connections, the parking brake, etc.

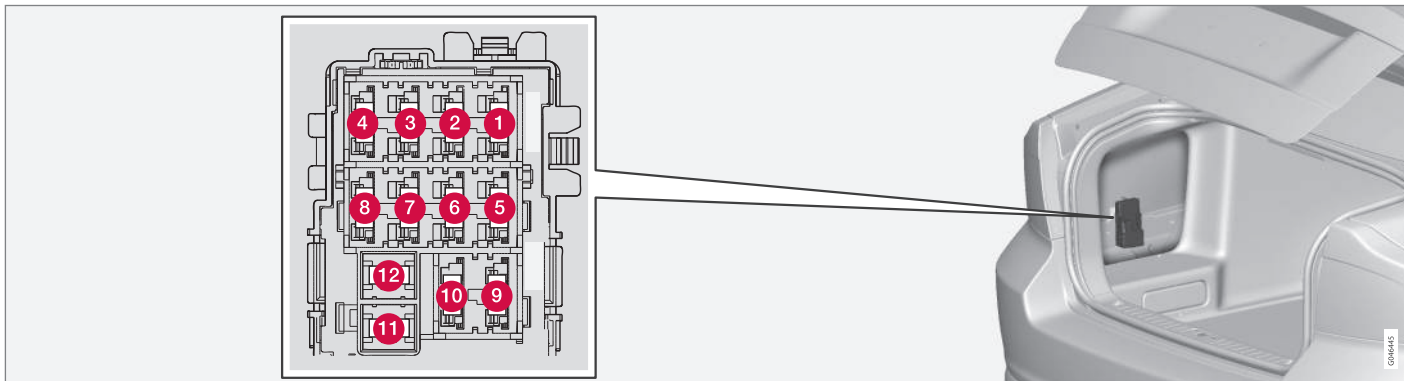

Located behind the upholstery on the left side of the trunk

### Positions

Pos	Function	A
1	Electric parking brake (left side)	30
2	Electric parking brake (right side)	30
3	Heated rear window	30
4	Trailer socket 2*	15

Pos	Function	A
5	-	
6	-	
7	-	
8	-	
9	-	
10	-	

Pos	Function	A
11	Trailer socket 1*	40
12	-	

### Related information

- Fuses – engine compartment (p. 333)
- Fuses – glove compartment (p. 337)
- Fuses – engine compartment cold zone (Start/Stop only) (p. 341)



## Fuses – engine compartment cold zone (Start/Stop only)<sup>6</sup>

There are fuses in the engine compartment cold zone on models with the Start/Stop function.

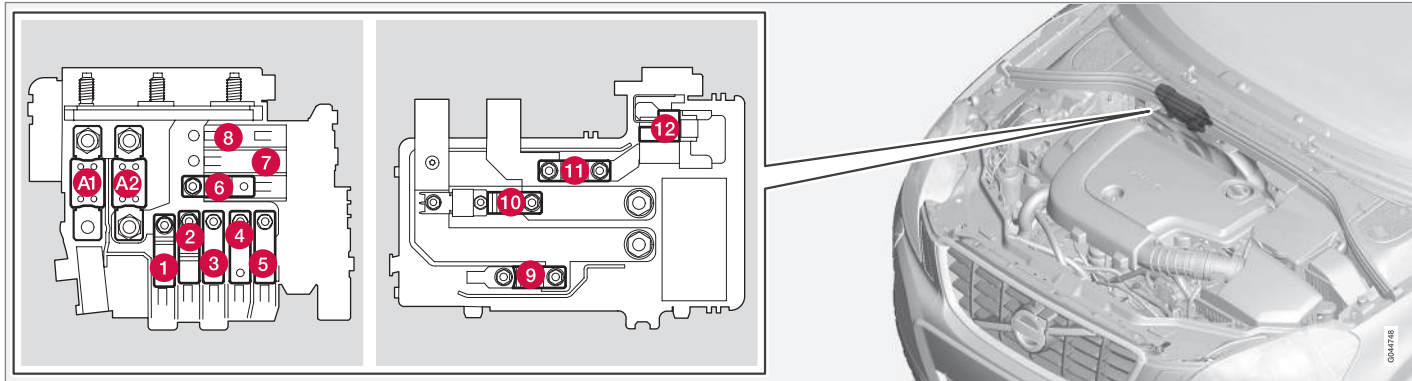

Location of Start/Stop fuses

### Positions

- Fuses A1, A2 and 1–11 are relays/circuit breakers and should only be removed or replaced by a trained and qualified Volvo service technician.
- Fuse 12 may be changed at any time when necessary.

Pos	Function	A
A1	Circuit breaker: central electrical module in the engine compartment	175
A2	Circuit breaker: fuseboxes under the glove compartment, central electrical module in the trunk	175

Pos	Function	A
1	-	
2	Circuit breaker: fusebox <b>B</b> under the glove compartment (see Fuses – glove compartment (p. 337))	50

<sup>6</sup> Option on 4-cyl. engines



# 10 Maintenance and servicing



Pos	Function	A
3	Circuit breaker: fusebox <b>A</b> under the glove compartment (see Fuses – glove compartment (p. 337))	60
4	Circuit breaker: fusebox <b>A</b> under the glove compartment (see Fuses – glove compartment (p. 337))	60
5	Circuit breaker: central electrical module in the trunk	60
6	Climate system blower	40
7	–	–
8	–	–
9	Starter motor relay	30
10	Internal diode	50
11	Auxiliary battery	70
12	Central electrical module: auxiliary battery reference voltage, auxiliary battery charging point	15

- Fuses – cargo area/trunk (p. 340)
- Start/Stop – introduction (p. 243)

## Related information

- Fuses – engine compartment (p. 333)
- Fuses – glove compartment (p. 337)



## Washing the car

*The vehicle should be washed at regular intervals since dirt, dust, insects and tar spots adhere to the paint and may cause damage. To help prevent corrosion, it is particularly important to wash the car frequently in the wintertime.*

The following points should be kept in mind when washing and cleaning the car:

- Avoid washing your car in direct sunlight. Doing so may cause detergents and wax to dry out and become abrasive. To avoid scratching, use lukewarm water to soften the dirt before you wash with a soft sponge, and plenty of sudsy water.
- **Bird droppings:** Remove from paintwork as soon as possible. Otherwise the finish may be permanently damaged.
- A detergent can be used to facilitate the softening of dirt and oil.
- Dry the car with a clean chamois and remember to clean the drain holes in the doors and rocker panels.
- Tar spots can be removed with tar remover after the car has been washed.
- A stiff-bristle brush and lukewarm soapy water can be used to clean the wiper blades. Frequent cleaning of the windshield and wiper blades improves visibility considerably and also helps prolong the service life of the wiper blades.

- Wash off the dirt from the underside (wheel housings, fenders, etc).
- In areas of high industrial fallout, more frequent washing is recommended.

### NOTE

When washing the car, remember to remove dirt from the drain holes in the doors and sills.

### CAUTION

- During high pressure washing, the spray mouthpiece must never be closer to the vehicle than 13" (30 cm). Do not spray into the locks.
- Dirt, snow, etc., on the headlights can reduce lighting capacity considerably. Clean the headlights regularly, for example when refueling.

#### Special moonroof cautions:

- Always close the moonroof and sun shade before washing your vehicle.
- Never use abrasive cleaning agents on the moonroof.
- Never use wax on the rubber seals around the moonroof.

## Exterior components

Volvo recommends the use of special cleaning products, available at your Volvo retailer,

for cleaning colored plastic, rubber, or ornamental components such as chromed strips on the exterior of your vehicle. The instructions for using these products should be followed carefully. Solvents or stain removers should not be used.

### CAUTION

- Avoid waxing or polishing plastic or rubber components
- Polishing chromed strips can wear away or damage the surface
- Polishes containing abrasive substances should not be used

## Related information

- Polishing and waxing (p. 344)
- Cleaning the interior (p. 345)



## Automatic car wash

*The vehicle should be washed at regular intervals since dirt, dust, insects and tar spots adhere to the paint and may cause damage. To help prevent corrosion, it is particularly important to wash the car frequently in the wintertime.*

- We do NOT recommend washing your car in an automatic wash during the first few months (because the paint will not have hardened sufficiently).
- An automatic wash is a simple and quick way to clean your car, but it is worth remembering that it may not be as thorough as when you yourself go over the car with sponge and water. Keeping the underbody clean is most important, especially in the winter. Some automatic washers do not have facilities for washing the underbody.

### NOTE

Condensation may form temporarily on the inside of the lenses of exterior lights such as headlights, fog lights, or taillights. This is normal and the lights are designed to withstand moisture. Normally, condensation will dissipate after the lights have been on for a short time.

### CAUTION

- Before driving into an automatic car wash, turn off the optional rain sensor to avoid damaging the windshield wipers.
- Make sure that side view mirrors, auxiliary lamps, etc, are secure, and that any antenna(s) are retracted or removed. Otherwise there is risk of the machine dislodging them.
- **Chromed wheels:** Clean chrome-plated wheels using the same detergents used for the body of the vehicle. Aggressive wheel-cleaning agents can permanently stain chrome-plated wheels.

### WARNING

- When the vehicle is driven immediately after being washed, apply the brakes, including the parking brake, several times in order to remove any moisture from the brake linings.
- Engine cleaning agents should not be used when the engine is warm. This constitutes a fire risk.

### Related information

- Polishing and waxing (p. 344)
- Cleaning the interior (p. 345)
- Washing the car (p. 343)

## Polishing and waxing

*Normally, polishing is not required during the first year after delivery, however, waxing may be beneficial.*

- Before applying polish or wax the vehicle must be washed and dried. Tar spots can be removed with kerosene or tar remover. Difficult spots may require a fine rubbing compound.
- After polishing use liquid or paste wax.
- Several commercially available products contain both polish and wax.
- Waxing alone does not substitute for polishing a dull surface.
- A wide range of polymer-based waxes can be purchased today. These waxes are easy to use and produce a long-lasting, high-gloss finish that protects the bodywork against oxidation, road dirt and fading.
- Do not polish or wax your vehicle in direct sunlight (the surface of the vehicle should not be warmer than 113 °F (45 °C)).

**CAUTION**

Volvo does not recommend the use of long-life or durable paint protection coatings, some of which may claim to prevent pitting, fading, oxidation, etc. These coatings have not been tested by Volvo for compatibility with your vehicle's clear coat. Some of them may cause the clear coat to soften, crack, or cloud. Damage caused by application of paint protection coatings may not be covered under your vehicle's paint warranty.

**Related information**

- Washing the car (p. 343)

**Cleaning the interior**

*Only use cleaning agents and car care products recommended by Volvo. Clean regularly and follow the instructions included with the car care product.*

**Cleaning the interior****Upholstery care****Fabric**

Clean with soapy water or a detergent. For more difficult spots caused by oil, ice cream, shoe polish, grease, etc., use a clothing/fabric stain remover. Consult your Volvo retailer.

**Alcantera™ suede-like material**

Suede-like upholstery can be cleaned with a soft cloth and mild soap solution.

**Leather care**

Volvo's leather upholstery is manufactured with a protectant to repel soiling. Over time, sunlight, grease and dirt can break down the protection. Staining, cracking, scuffing, and fading can result.

Volvo offers an easy-to-use, non-greasy leather care kit formulated to clean and beautify your vehicle's leather, and to renew the protective qualities of its finish. The cleaner removes dirt and oil buildup. The light cream protectant restores a barrier against soil and sunlight.

Volvo also offers a special leather softener that should be applied after the cleaner and protectant. It leaves leather soft and smooth, and reduces friction between leather and other finishes in the vehicle.

Volvo recommends cleaning, protecting and conditioning your vehicle's leather two to four times a year. Ask your Volvo retailer about Leather Care Kit 951 0251 and Leather Softener 943 7429.

**Cleaning leather upholstery**

1. Pour leather cleaner on a damp sponge and squeeze it until the cleaner foams.
2. Apply the foam to the stain by moving the sponge with circular movements.
3. Dampen the stain thoroughly with the sponge. Let the sponge absorb the stain, do not rub.
4. Dry the stain with soft paper towels or a towel, and allow the leather to dry completely.



# 10 Maintenance and servicing



## Protecting leather upholstery

1. Put a small amount of protectant cream on a cloth and apply a thin coating of cream to the upholstery with light circular movements.
2. Allow the leather to dry for 20 minutes.

This will help the leather resist staining and protect against sunlight's harmful UV rays.

### CAUTION

- Under no circumstances should gasoline, naphtha or similar cleaning agents be used on the plastic or the leather since these can cause damage.
- Take extra care when removing stains such as ink or lipstick since the coloring can spread.
- Use solvents sparingly. Too much solvent can damage the seat padding.
- Start from the outside of the stain and work toward the center.
- Sharp objects (e.g. pencils or pens in a pocket) or Velcro fasteners on clothing may damage the textile upholstery.
- Clothing that is not colorfast, such as new jeans or suede garments, may stain the upholstery.

## Cleaning a leather-covered steering wheel

- Remove soil, dust, etc., with a damp sponge and a neutral soap solution.
- Leather should be allowed to breathe. Never cover the steering wheel with a plastic protector.
- Volvo recommends cleaning, protecting and conditioning the steering wheel with Volvo's Leather Care Kit 951 0251 and Leather Softener 943 7429.

### If there are stains on the steering wheel:

#### Type 1 (ink, wine, coffee, milk, sweat or blood)

- Use a soft cloth or sponge. Wipe the wheel with a solution with 5% ammonia. For blood stains, mix approx. 1 cup (2 dl) of water and one ounce (25g) of salt and wipe the stain.

#### Type 2 (fat, oil, sauces, or chocolate)

1. Same procedure as for type 1 stains.
2. Finish by rubbing the wheel with absorbent paper or a towel.

#### Type 3 (dry soil or dust)

1. Remove the soil/dust with a soft brush.
2. Same procedure as for type 1 stains.

### CAUTION

Sharp objects, such as rings, could damage the leather on the steering wheel.

## Cleaning the seat belts

Clean only with lukewarm water and a mild soap solution.

## Cleaning floor mats

The floor mats should be vacuumed or brushed clean regularly, especially during winter when they should be taken out for drying. Spots on textile mats can be removed with a mild detergent. For best protection in winter, Volvo recommends the use of Volvo rubber floor mats. Consult your Volvo retailer.

## Spots on interior plastic, metal, or wood surfaces

Cleaning interior plastic components should be done with a cleaning agent specially designed for this purpose. Consult your Volvo retailer.



## CAUTION

- Do not use cleaning agents with high alcohol content such as washer fluid to clean instrument panel glass.
- Never spray cleaning agents or water directly onto components with electrical buttons or controls. Clean components of this type by applying the cleaning agent/water sparingly to a cloth and wiping the components so that no liquid penetrates into these components.

## Related information

- Washing the car (p. 343)

## Touching up paintwork

Paint damage requires immediate attention to avoid rusting. Make it a habit to check the finish regularly, for instance washing the vehicle. Touch-up if necessary.

Paint repairs require special equipment and skill. Contact your Volvo retailer for any extensive damage.

Minor scratches can be repaired by using Volvo touch-up paint.

## Color code

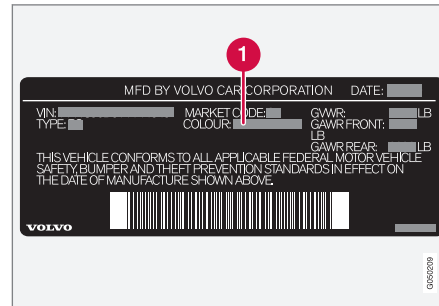

Sample color code: US models



Sample color code: Canadian models

Make sure you have the right color. See Label information (p. 350) for the location of this label (label number 4 in the illustration).

## Minor stone chips and scratches

Material:

- Primer – can
- Paint – touch-up pen
- Brush
- Masking tape

If the stone chip has not gone down to the bare metal and an undamaged color coat remains, you can add paint immediately after removing dirt.

## NOTE

When touching up the vehicle, it should be clean and dry. The surface temperature should be above 60 °F (15 °C).



## Repairing stone chips

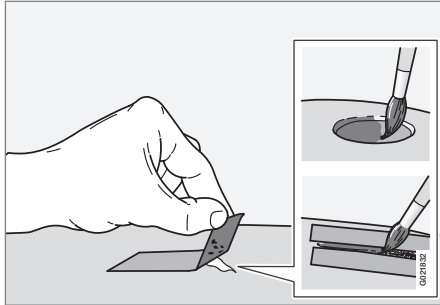

1. Place a strip of masking tape over the damaged surface. Pull the tape off so that any loose flakes of paint adhere to it.
2. Thoroughly mix the primer and apply it with a small brush.
3. When the primer surface is dry, the paint can be applied using a brush. Mix the paint thoroughly; apply several thin paint coats and let dry after each application.
4. If there is a longer scratch, you may want to protect surrounding paint by masking it off
5. After a few days, polish the touched-up areas. Use a soft rag and a small amount of polish.

### Related information

- Label information (p. 350)

# 11

## SPECIFICATIONS

01 10  
00 11

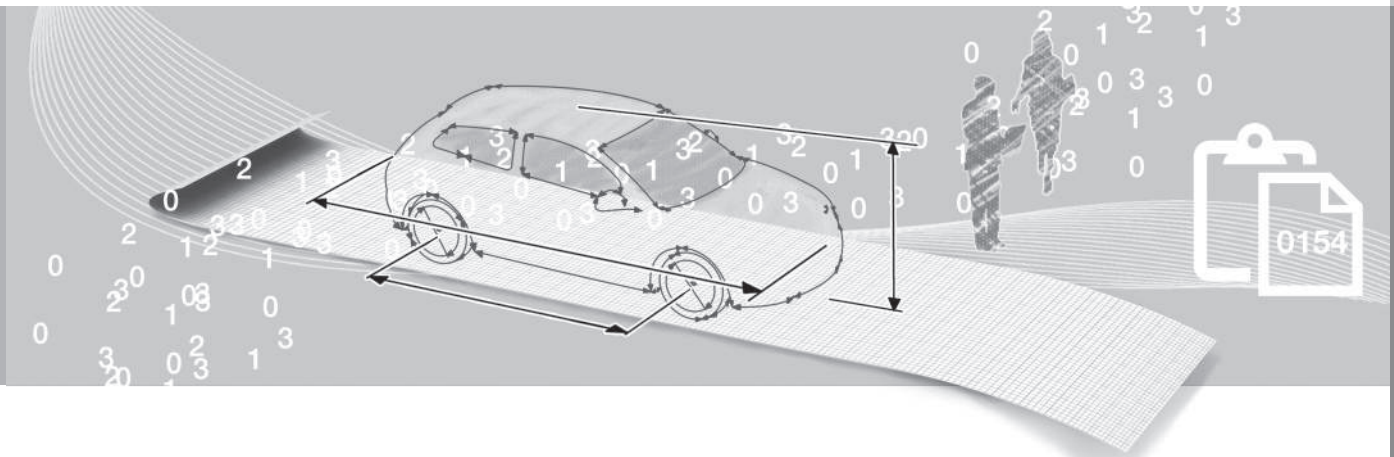

## **Label information**

*The labels in your vehicle provide information such as the chassis number, paint code, tire inflation pressure, etc.*



**List of labels****1 Vehicle Emission Control Information.**

Your Volvo is designed to meet all applicable emission standards, as evidenced by the certification label on the underside of the hood. For further information regarding these regulations, please consult your Volvo retailer.

**2 Engine oil.** This label contains the recommended engine oil specifications.**3 Vehicle Identification Number (VIN).**

The VIN plate is located on the top left surface of the dashboard. The Vehicle Identification Number (VIN) should always be quoted in all correspondence concerning your vehicle with the retailer and when ordering parts.

**4 Tire inflation pressures.** This label indicates the correct inflation pressures for the tires that were on the vehicle when it left the factory.**5 Federal Motor Vehicle Safety Standards (FMVSS) specifications (USA) and Ministry of Transport (CMVSS) standards (Canada).** Your Volvo is designed to meet all applicable safety standards, as evidenced by the certification label on the driver's side B-pillar (the structural member at the side of the vehicle, at the rear of the driver's door opening). This label also includes codes for paint color, etc. For further information regarding these regulations, please consult your Volvo retailer. U.S. models have the upper decal; Canadian models have the lower one.**Related information**

- Weights (p. 355)
- Engine specifications (p. 356)

## Dimensions

This section lists your vehicle's most important dimensions.

### Dimensions—S80

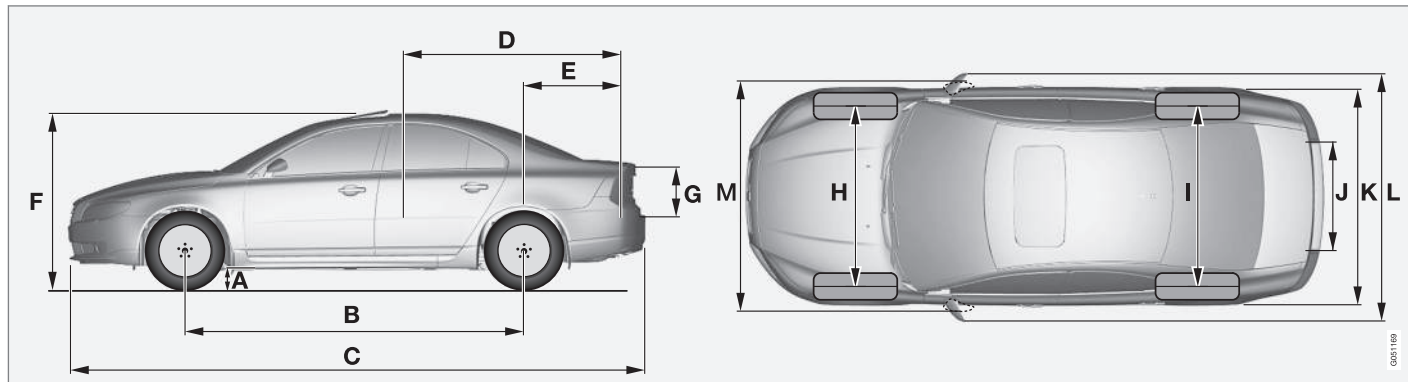

Position	Dimension	in. (mm)
A	Ground clearance (curb weight + 2 people) <sup>A</sup>	5.3 (135)
B	Wheelbase	111.6 (2835)
C	Length	191.1 (4854)
D	Load length, floor, seatback down	75.9 (1927)
E	Load length, floor	43.1 (1094)
F	Height	58.8 (1493)

# 11 Specifications



Position	Dimension	in. (mm)
G	Load height	14.5 (368)
H	Track, front	62.5 (1588) <sup>B</sup> 62.1 (1578) <sup>C</sup>
I	Track, rear	62.4 (1585) <sup>B</sup> 62 (1575) <sup>C</sup>
J	Load width, floor	44.5 (1130)
K	Width	73.3 (1861) 73.9 (1876) <sup>D</sup>
L	Width incl. door mirrors (folded out)	82.9 (2106)
M	Width incl. door mirrors (folded in)	75.1 (1907)

A Varies slightly depending on tire size, optional sport chassis, etc.

B With 16" wheels

C With 17" wheels

D Models with the optional keyless drive

## Weights

The following table lists important weight data for your vehicle.

Category	USA	Canada
Gross vehicle weight	4-cyl. FWD <sup>A</sup> : 4720 lbs 6-cyl. turbo AWD <sup>B</sup> : 5020 lbs	4-cyl. FWD <sup>A</sup> : 2140 kg 6-cyl. turbo AWD <sup>B</sup> : 2280 kg
Capacity weight	4-cyl. FWD: 905 lbs 6-cyl. Turbo AWD: 890 lbs	4-cyl. FWD: 410 kg 6-cyl. turbo AWD: 400 kg
Permissible axle weights, front	4-cyl. FWD: 2580 lbs 6-cyl. turbo AWD: 2750 lbs	4-cyl. FWD: 1170 kg 6-cyl. AWD turbo: 1250 kg
Permissible axle weights, rear	4-cyl. FWD: 2270 lbs 6-cyl. turbo AWD: 2360 lbs	4-cyl. FWD: 1030 kg 6-cyl. turbo AWD: 1070 kg
Curb weight	3650 - 3930 lbs	1650 - 1790 kg
Max. roof load	220 lbs	100 kg
Max. trailer weights	Without brakes: 1650 lbs With brakes, 1 7/8" ball: 2,000 lbs With brakes, 2" ball: 3,300 lbs	Without brakes: 750 kg With brakes, 1 7/8" ball: 900 kg With brakes, 2" ball: 1500 kg
Max. tongue weight	165 lbs	75 kg

<sup>A</sup> FWD = Front Wheel Drive

<sup>B</sup> AWD = All Wheel Drive

## Related information

- Loading specifications (p. 286)
- Loading specifications – load limit (p. 286)

# 11 Specifications

## Engine specifications

The following table provides technical data for the respective engines. Engine specifications for Special Edition vehicles may vary.

Some of the engines listed here may not be available in all markets.

### Engine specifications

Specification/Model	3.2 6-cyl.	3.2 6-cyl.	3.0T <sup>A</sup>	2.0 4-cyl. T9	2.0 4-cyl. T10	2.0 4-cyl. T11	2.0 4-cyl. T12
Engine designation	B6324S5	B6324S4	B6304T4	B4204T9	B4204T10	B4204T11	B4204T12
Output (kW/rps)	179/107	171/108	224/93	225/95	225/95	179/5600	179/5600
Output (hp/rpm)	240/6400	230/6500	300/5600	302/5700	302/5700	240/5600	240/5600
Torque (Nm/rps)	320/53	300/55	440/35 – 70	400/35–75	400/35–75	350/1500-4500	350/1500-4500
Torque (ft. lbs./rpm)	236/3200	221/3300	325/2100 – 4200	295/2100–4500	295/2100–4500	258/1500–4500	258/1500–4500
No. of cylinders	6	6	6	4	4	4	4
Bore (in/mm)	3.3/84	3.3/84	3.23/82	3.27/82	3.27/82	3.27/82	3.27/82
Stroke (in/mm)	3.78/96	3.78/96	3.67/93.2	3.63/93.2	3.63/93.2	3.63/93.2	3.63/93.2
Displacement	3.19 liters (194.8 cu. in.)	3.19 liters (194.8 cu. in.)	2.95 liters (175 cu. in.)	1.97 liters (120.2 cu. in.)	1.97 liters (120.2 cu. in.)	1.97 liters (120.2 cu. in.)	1.97 liters (120.2 cu. in.)
Compression ratio	10.8:1	10.3:1	9.3:1	10.3:1	10.3:1	10.8:1	10.8:1

<sup>A</sup> This engine may not be available on all markets

## Related information

- Coolant – specification and volume (p. 360)
- Oil specifications (p. 358)
- Oil volume (p. 359)

## Oil specifications

Full synthetic engine oil meeting the minimum ACEA A5/B5 must be used. Lower quality oils may not offer the same fuel economy, engine performance, or engine protection.

Volvo recommends:



Refer to the warranty and Service Records information booklet for information on oil change intervals and oil type requirements.

### **i** NOTE

This vehicle comes from the factory with synthetic oil.

**Oil additives must not be used.**

### Oil viscosity

Incorrect viscosity oil can shorten engine life under normal use. SAE 5W-30 will provide

good fuel economy and engine protection. See the viscosity chart.

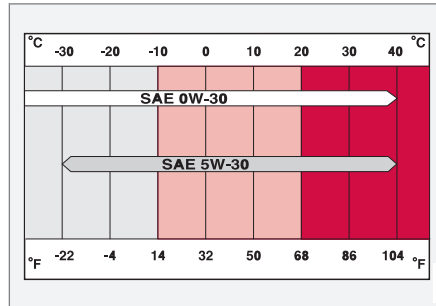

Viscosity chart

### Extreme engine operation

SAE 0W-30 oil meeting ACEA A5/B5 requirements is recommended for extreme driving conditions.

### **!** CAUTION

**4-cylinder engines only:** Volvo oil VCC RBS0-2AE/SAE 0W20 is recommended for extreme driving conditions.

This oil must **never** be used in 5- or 6-cylinder engines.

### Related information

- Oil volume (p. 359)
- Engine compartment – engine oil (p. 313)

**Oil volume**

The following table provides technical data for the respective engines. Some of these

*engines may not be available in all markets.  
Engine specifications for Special Edition vehicles may vary.*

Engine model		Approx. volume (incl. filter)
3.2 (6-cyl.)	B6324S4/S5	7.18 US qts (6.8 liters)
3.0T (6 cyl.)	B6304T4	7.18 US qts (6.8 liters)
All 4-cyl. engines		5.7 US qts (5.4 liters)

**Related information**

- Engine compartment – engine oil (p. 313)
- Oil specifications (p. 358)

# 11 Specifications

## Coolant – specification and volume

The table lists coolant volumes and specifications.

System	Volume	Specification
3.2 (6-cyl.)/3.0T	9.4 US qts. (8.9 liters)	Coolant with corrosion inhibitor mixed with water (50/50 mix), see packaging.
All 4-cyl. engines	8.8 US qts. (8.3 liters)	

### Related information

- Engine compartment – coolant (p. 315)

## Transmission oil – specification and volumes

The table lists transmission oil<sup>1</sup> volumes and specifications.

System	Volume	Specification
Automatic (TF-80SC)	7.4 US qts (7 liters)	Transmission fluid AW-1
Automatic (TG-81SC)	7 US qts ( 6.6 liters)	

### Related information

- Label information (p. 350)

## Brake fluid – specification and volume

Brake fluid transfers braking force when the brake pedal is depressed to the master cylinder and to the slave cylinders on each wheel.

**Specification:** DOT 4 boiling point >536 °F (>280 °C)

**Volume:** 0.63 US qts (0.6 liters)

### Related information

- Engine compartment – brake fluid (p. 316)

<sup>1</sup> Under normal driving conditions the transmission oil does not need changing during its service life. However, it may be necessary under adverse driving conditions.

## Power steering – specification

*This fluid is used to help reduce and regulate steering force.*

**Specification:** Power steering fluid recommended by Volvo.

### Related information

- Engine compartment – power steering fluid (p. 317)

## Washer fluid – specification and volume

*Washer fluid helps keep the windshield and tailgate window on wagon models clean and free from ice and road salt during winter driving.*

**Specification:** Use a washer antifreeze recommended by Volvo, mixed with water.

### Volume:

- 6.8 US qts (6.5 liters)
- 4.7 US qts (4.5 liters<sup>2</sup>)

### Related information

- Engine compartment – washer fluid (p. 328)
- Wiper blades – service position (p. 326)
- Wiper blades – windshield (p. 327)

## Fuel tank volume – specification and volume

*The table lists the fuel tank volume for your vehicle.*

Volume	Specification
18.5 US gallons (70 liters)	–

### Related information

- Refueling – opening/closing fuel filler door (p. 263)
- Refueling – opening/closing fuel cap (p. 264)
- Refueling – octane rating (p. 261)
- Engine specifications (p. 356)

<sup>2</sup> Models without headlight washers

## **Air conditioning – specification and volume**

*The air conditioning system in your vehicle contains the following:*

**Refrigerant:** R134a (HFC134a)

**Volume:** 1.7 lbs (770 g)

**Compressor oil:** PAG

## Battery specifications

If the battery is replaced, replace it with a battery of the same cold start capacity as the original (see the decal on the battery).

12 volt system with a voltage-regulated alternator. Single pole system in which the chassis and engine block are used as conductors. The negative terminal is connected to the chassis.

## General information

### WARNING

#### PROPOSITION 65 WARNING!

Battery posts, terminals, and related accessories contain lead and lead compounds, chemicals known to the state of California to cause cancer and reproductive harm. Wash hands after handling.

Motor	Voltage (V)	Cold start capacity CCA (Cold Cranking Amperes) (A)
Engines with Start/Stop*	12	800 <sup>A</sup>
All other engines	12	520–800

<sup>A</sup> AGM (Absorbed Glass Mat) batteries have to be used on models with Start/Stop

## Symbols – general information

The following tables list the most common warning and indicator lights and symbols and a reference to where more detailed information can be found.

### Introduction

The symbols in the vehicle's various displays are divided into three main categories:

- Warning symbols
- Indicator symbols
- Information symbols

The following tables list the most common symbols, their meaning and the pages in this manual that provide more detailed information.

### NOTE

Not all of the symbols shown in the related articles are available in all models or on all markets. Local variations may occur.

### Warning symbol

: The red warning symbol illuminates to indicate a problem related to safety and/or drivability. A message will also appear in the main instruments panel's display.

### Information symbol

: The information symbol illuminates and a text message is displayed to provide the

driver with necessary information about one of the vehicle's systems.

### Related information

- Information displays – indicator symbols (p. 66)
- Information displays – warning symbols (p. 68)
- Information display – messages (p. 107)

## Warning symbols

The following tables list the most common warning and indicator lights and symbols and a reference to where more detailed information can be found.

: The red warning symbol illuminates to indicate a problem related to safety and/or drivability. A message will also appear in the main instruments panel's display.

: The information symbol illuminates and a text message is displayed to provide the driver with necessary information about one of the vehicle's systems.

## Symbols in the main instrument panel

### Warning symbols in the instrument panel

Symbol	Description	See
	Low oil pressure	(p. 68)
	Parking brake <sup>A</sup>	(p. 68)
	SRS airbags	(p. 68)
	Seat belt reminder	(p. 68)
	Generator not charging	(p. 68)
	Fault in the brake system	(p. 68)
	Warning symbol	(p. 68)

<sup>A</sup> The symbol is **Park** only on models with the optional digital instrument panel.

### Related information

- Information displays – indicator symbols (p. 66)
- Information displays – warning symbols (p. 68)
- Information display – messages (p. 107)

## Indicator symbols

The following tables list the most common warning and indicator lights and symbols and a reference to where more detailed information can be found.

: The red warning symbol illuminates to indicate a problem related to safety and/or drivability. A message will also appear in the main instruments panel's display.

: The information symbol illuminates and a text message is displayed to provide the driver with necessary information about one of the vehicle's systems.

### Indicator symbols in the instrument panel

Symbol	Description	See
	Fault in the Active Bending Light (ABL)*system	(p. 66)
	Malfunction indicator light	(p. 66)
	Anti-lock brake system (ABS)	(p. 66)
	Rear fog lights on	(p. 66)

Symbol	Description	See
	Stability system, Hill Descent Control, Trailer Stability Assist*	(p. 66)
	Tire pressure monitoring sensor (TPMS)	(p. 66)
	Low fuel level	(p. 66)
	Information symbol, see text in information display	(p. 66)
	High beam indicator	(p. 66)
	Left turn signal indicator	(p. 66)
	Right turn signal indicator	(p. 66)
	Stability system, Sport mode	(p. 163)

### Related information

- Information displays – indicator symbols (p. 66)
- Information displays – warning symbols (p. 68)
- Information display – messages (p. 107)

# 11 Specifications





## Information symbols









The following tables list the most common warning and indicator lights and symbols and a reference to where more detailed information can be found.





: The red warning symbol illuminates to indicate a problem related to safety and/or drivability. A message will also appear in the main instruments panel's display.

: The information symbol illuminates and a text message is displayed to provide the driver with necessary information about one of the vehicle's systems.

### Information symbols in the instrument panel

Symbol	Description	See
	Adaptive Cruise Control *	(p. 171)
	Adaptive Cruise Control *	(p. 171)
	Adaptive Cruise Control *	(p. 171)
	Adaptive Cruise Control * (Distance alert)	(p. 171)
	Radar sensor*	(p. 180)

Symbol	Description	See
	Camera sensor, laser sensor	(p. 202) (p. 195)
	Collision Warning with Full Auto-brake and Pedestrian Detection*	(p. 207)
	Active Bending Lights (ABL)*	(p. 85)
	Driver Alert System*	(p. 209)
	Driver Alert System*	(p. 209)
	(P)!	(p. 254)
	Rain sensor*	(p. 92)
	Active High Beams (AHB)*	(p. 84)
	Windshield sensor*	(p. 84)

Symbol	Description	See
	Driver Alert System* (Lane Departure Warning)	(p. 214)
	Driver Alert System* (Lane Departure Warning)	(p. 214)
	Driver Alert System* (Lane Departure Warning)	(p. 214)
	Fuel tank on passenger's side of the vehicle	(p. 263)

### Related information



- Information displays – indicator symbols (p. 66)
- Information displays – warning symbols (p. 68)
- Information display – messages (p. 107)

## Information symbols – ceiling console

The following tables list the most common warning and indicator lights and symbols and a reference to where more detailed information can be found.

: The red warning symbol illuminates to indicate a problem related to safety and/or drivability. A message will also appear in the main instruments panel's display.

: The information symbol illuminates and a text message is displayed to provide the driver with necessary information about one of the vehicle's systems.

Symbol	Description	See
	Seat belt reminder	(p. 30)
	Occupant Weight Sensor	(p. 36)

### Related information





- Information displays – indicator symbols (p. 66)
- Information displays – warning symbols (p. 68)
- Information display – messages (p. 107)



## Information symbols – center console

The following tables list the most common warning and indicator lights and symbols and a reference to where more detailed information can be found.

: The red warning symbol illuminates to indicate a problem related to safety and/or drivability. A message will also appear in the main instruments panel's display.

: The information symbol illuminates and a text message is displayed to provide the driver with necessary information about one of the vehicle's systems.

Symbol	Description	See
	Audio files	Sensus Infotainment supplement
	CD folder	Sensus Infotainment supplement
	Video files	Sensus Infotainment supplement
	Bluetooth-connected cell phone	Sensus Infotainment supplement

Symbol	Description	See
	Bluetooth™ hands-free	Sensus Infotainment supplement
	HD radio	Sensus Infotainment supplement
	Park Assist*	(p. 219)

### Related information

- Information displays – indicator symbols (p. 66)
- Information displays – warning symbols (p. 68)
- Information display – messages (p. 107)

**1, 2, 3 ...**

12-volt sockets..... 134

**A**

ABS (anti-lock brake system)..... 252

Accessory installation warning..... 22

Active chassis system..... 162

Active high beams..... 84

Active yaw control..... 162, 163

Adaptive brake lights..... 253

Adaptive cruise control..... 171, 172

**Airbags**

disconnecting the front passenger's

side..... 36

front..... 32

inflatable curtain..... 41

side impact..... 39

Air conditioning..... 125

Air distribution..... 121, 127

Air distribution table..... 129

Air vents..... 121

Alarm..... 157, 158, 159, 160

All Wheel Drive..... 250

Ambient temperature sensor..... 71

Anti-freeze..... 260, 315

Anti-lock brake system  
    warning light..... 67

Anti-lock Brake System (ABS)..... 252

Approach lighting..... 91, 143

Auto-dim rearview mirror..... 98

Automatic locking retractor..... 47

**Automatic transmission**

Eco (driving function)..... 248

Geartronic..... 240

general description..... 238, 240

oil..... 360

shiftlock override..... 242

Axle weight..... 286

**B****Battery**

maintenance..... 330, 331

remote key, replacing..... 148

replacing..... 331

specifications..... 363

start/stop..... 363

warning symbols..... 328

Blind Spot Information System (BLIS)..... 227

Booster cushions..... 53

Brake lights..... 253

**Brake system**

ABS..... 252

Brake pad inspection..... 251

checking fluid level..... 316

emergency brake assistance..... 253

fluid..... 360

general information..... 250

**Bulbs**

headlights... 318, 319, 320, 321, 322, 323

introduction..... 318

license plate lights..... 324

side marker lights..... 323

specifications..... 325

trunk lighting..... 325

**C**

Camera, Park Assist..... 223

Capacity weight..... 286

Catalytic converter..... 264

Central locking system, introduction 140,  
141, 144, 147

Chains..... 289

Check Engine warning light..... 67

**Child restraints**

recalls and registration..... 47

- Child restraint systems..... 47  
 booster cushions..... 53  
 convertible seats..... 51  
 infant seats..... 49  
 ISOFIX/LATCH anchors..... 54  
 top tether anchors..... 56
- Child safety..... 45  
 booster cushions..... 53  
 child restraint systems..... 47  
 convertible seats..... 51  
 infant seats..... 49
- Child safety locks..... 57
- City safety..... 189, 190
- Climate system..... 126  
 air distribution..... 121, 127, 129  
 air vents..... 121  
 Interior Air Quality System..... 119  
 introduction..... 118  
 passenger compartment filter..... 119  
 refrigerant..... 118
- Clock, setting..... 72
- Cold weather driving..... 260
- Collision warning system.. 196, 198, 201,  
 202, 204, 205
- Compass in rearview mirror..... 99
- Connected service booking..... 309
- Conserving electrical current..... 259
- Convertible seats..... 51
- Coolant..... 315, 360
- Cooling system, general information..... 258
- Courtesy lighting..... 89
- Crash event data..... 18
- Crash mode..... 44, 45
- Cruise control..... 168, 170  
 adaptive..... 171
- Curb weight..... 286
- Current, conserving..... 259
- Cyclist detection..... 200, 204
- D**
- Daytime running lights..... 82
- Defroster..... 126
- Detachable key blade..... 145, 146
- Disconnecting the front passenger's air-  
 bag..... 36
- Distance Alert..... 185
- Dome lighting..... 89
- Door mirrors..... 96, 97
- Driver alert..... 209, 210, 211, 212  
 Lane Departure Warning..... 214, 216, 217
- Driver distraction warning..... 22
- Driving economically..... 265
- Driving in cold weather..... 260
- Driving through water..... 258
- E**
- ECC..... 123, 124, 125
- Eco (driving function)..... 248
- Eco coast..... 248
- Eco guide..... 65
- Economical driving..... 265
- Electrically heated steering wheel..... 82
- Electric parking brake..... 254, 255, 257
- Electronic Climate Control..... 122, 125  
 air distribution table..... 129  
 Interior Air Quality System..... 120  
 ventilated seats..... 124
- Electronic oil level sensor..... 314
- Electronic stability control..... 162
- Emergency locking retractor..... 47
- Emergency starting..... 237
- Emergency towing..... 268, 269, 270
- Emission inspection readiness..... 309

- Engine  
 overheating..... 69  
 specifications..... 356  
 Start/Stop..... 243, 244, 245, 246, 247  
 starting..... 233  
 switching off..... 235, 236
- Engine compartment overview..... 312
- Engine oil..... 358  
 checking..... 313  
 low pressure warning light..... 68  
 volumes..... 359
- Engine remote start (ERS)..... 235
- Environment..... 21
- F**
- 
- Federal Clean Air Act..... 306
- Flat tires  
 repairing with tire sealing system..... 298
- Floor mats  
 cleaning..... 346  
 placing correctly..... 233
- Fluid specifications..... 360, 361
- Fog lights..... 67  
 rear..... 87
- Four C (active chassis system)..... 162
- Front airbags..... 32  
 disconnecting passenger's side airbag 36
- Front park assist..... 219, 223
- Front seats..... 74  
 heated..... 123
- Fuel filler cap..... 264
- Fuel filler door, opening..... 263, 264
- Fuel level warning light..... 67
- Fuel requirements..... 260, 261
- Fuel tank volume..... 361
- Fuses..... 332, 333, 340
- G**
- 
- Garage door opener  
 HomeLink® Wireless Control  
 System..... 102, 103
- Gasoline requirements..... 261
- Gas tank volume..... 361
- Gauges..... 62
- Geartronic..... 240
- Geartronic automatic transmission..... 240
- Generator warning light..... 69
- Glossary of tire terminology..... 287
- Grocery bag holder..... 138
- Gross vehicle weight..... 286
- H**
- 
- Hazard warning flashers..... 88
- Headlights  
 Active Bending Lights..... 85  
 active high beams..... 84  
 changing bulbs... 319, 320, 321, 322, 323  
 daytime running lights..... 82  
 high/low beams..... 83  
 high beam flash..... 83  
 tunnel detection..... 85
- Headlight washers..... 92
- Head restraints, rear seat..... 78
- Heated front seats..... 123
- Heated oxygen sensors..... 264
- Heated rear seats..... 123
- Heated steering wheel..... 82
- Heated windshield..... 98, 126
- High beams..... 83  
 active..... 84
- Hill Start Assist (HSA)..... 238
- Hoisting the vehicle..... 308
- HomeLink® Wireless Control  
 System..... 102, 103

Home safe lighting.....	90
Hood, opening/closing.....	311
Horn.....	81

**I**

ID, Volvo.....	20
Ignition modes.....	72, 73
Immobilizer.....	142
Important information.....	13, 14
Indicator lights.....	62, 64, 68
Infant seats.....	49
Inflatable Curtain.....	41
Inflation pressure.....	281, 282
Inflation pressure table.....	285
Information and warning symbols, table of.....	364
Information lights.....	62, 64, 68
Inspection readiness.....	309
Instrument lighting.....	86
"theater" lighting.....	86
Instrument overview.....	59, 62
Instrument panel.....	62, 106, 107
Interior Air Quality System.....	119
Interior lighting.....	89

Internet connection	
booking service.....	309
ISOFIX/LATCH anchors.....	54

**J**

Jack	
attaching.....	276
location of.....	276
Jump starting.....	237

**K**

Key blade. 140, 141, 144, 145, 146, 147, 150	
private locking.....	146
valet locking.....	146
Keyless drive.....	149
general description.....	150, 151, 152
starting the vehicle.....	233
Keyless locking/unlocking.....	149

**L**

Labels	
list of.....	352
location of.....	351
Lane Departure Warning (LDW)	214, 216, 217
LATCH anchors.....	54
Leather care.....	345
Lighting panel.....	82
Loading the vehicle.....	136, 138, 286
roof loads.....	137
Locking.....	153, 154, 155, 156
Locking the vehicle.....	143
Locks, child safety.....	57
Low beams.....	83
Low oil pressure warning light.....	68

**M**

Main instrument panel.....	106, 107
Maintenance.....	306
hoisting the vehicle.....	308
performed by the owner.....	307
Malfunction indicator light.....	67
Messages in the instrument panel...	106, 107

Mirrors	
defroster.....	98
power door.....	96, 97
rearview, auto-dim function.....	98
retractable.....	96, 97
vanity.....	135
Moonroof.....	100, 101
Motor oil	
checking.....	313
volumes.....	359
<b>O</b>	
Occupant safety.....	26
Occupant weight sensor.....	36
Octane recommendations.....	261
Odometer, trip.....	72
Oil	
checking.....	313
volumes.....	359
Oil level sensor.....	314
Oil quality.....	358
OK button.....	106, 107
On Call Roadside Assistance.....	23
Outside temperature sensor.....	71
Overhead courtesy lighting.....	89

Overheating, engine.....	69
Ownership, changing.....	18
Oxygen sensors, heated.....	264

**P**

Paint, touching up.....	347
Park assist.....	219, 223
Park Assist Camera.....	223
Parking brake	
electric, applying/releasing.	254, 255, 257
warning light.....	68
Parking lights.....	87
Pedestrian detection.....	201, 204
Polishing.....	344
Power front seat	
memory function.....	75
Power meter.....	65
Power mirrors.....	96, 97
defroster.....	98
Power moonroof.....	100, 101
Power steering	
adjustable.....	166
fluid.....	317
Power steering fluid.....	361

Power windows.....	94
laminated glass.....	95
Pregnancy, using seat belts during.....	30
Private locking.....	146
PROPOSITION 65 WARNING..	237, 331, 363

**R**

Rain sensor.....	92
Rear fog lights.....	87
Rear park assist.....	219, 223
Rear seats	
center head restraint.....	78
folding.....	78, 80
heated.....	123
Rearview mirror	
auto-dim function.....	98
compass.....	99
Rear window defroster.....	98
Recalls, child restraints.....	47
Refrigerant.....	362
Refueling.....	260, 261
fuel filler cap.....	264
fuel filler door.....	263, 264
fuel tank volume.....	361
Registering child restraints.....	47

- Remote control
    - private locking..... 146
  - Remote key..... 140, 141, 144, 147
    - approach lighting..... 143
    - immobilizer..... 142
    - key blade.... 140, 141, 144, 145, 146, 147
    - locking the vehicle..... 143
    - replacing the battery..... 148
    - unlocking the vehicle..... 143
  - Reporting safety defects..... 27
  - Roadside Assistance..... 23
  - Road sign information (RSI)..... 166
  - Roof loads..... 137
- S**
- Safety, occupant..... 26
  - Safety defects, reporting..... 27
  - Safety mode..... 44
  - Seat belt
    - reminder..... 30
  - Seat belts
    - Automatic locking retractor/Emergency locking retractor..... 47
    - buckling..... 29
    - maintenance..... 29
    - pretensioners..... 28
  - reminder..... 30
  - reminder warning light..... 68
  - securing child restraint systems.... 49, 51, 53
    - unbuckling..... 29
    - use during pregnancy..... 30
    - using..... 28
  - Seats, front..... 74, 75
  - Sensus..... 105
  - Service
    - connected service booking..... 309
  - Shiftlock..... 14
    - override..... 242
  - Side door mirrors..... 96, 97
  - Side impact airbags..... 39
  - Side marker lights, changing bulbs..... 323
  - Sign information (RSI)..... 166
  - Snow chains..... 289
  - Snow tires..... 289, 290
  - Spare tire..... 279
  - Spin control..... 162, 163
  - SRS..... 31
  - Stability system..... 162, 163, 164
    - indicator light..... 67
  - Start/Stop (engine function).... 243, 244, 245, 246, 247
  - Starting the engine..... 233
    - remote start..... 235
    - with keyless drive..... 233
  - Starting the vehicle
    - after a crash (crash mode)..... 44, 45
  - Start inhibitor (immobilizer)..... 142
  - Steering wheel
    - adjusting..... 81
    - heated..... 82
    - horn..... 81
    - keypad..... 81
  - Steering wheel paddles..... 81
  - Stone chips, touching up..... 347
  - Storage spaces..... 132
  - Studded tires..... 289, 290
  - Sunroof (moonroof)..... 100, 101
  - Sun shade..... 94, 95
  - Supplemental restraint system..... 31
    - warning light..... 68
  - Symbols, overview..... 364

## T

Tailgate	
wiper/washer.....	93
Temperature sensor	
ambient.....	71
Temporary spare tire.....	279
Three-way catalytic converter.....	264
Tire designations.....	283
Tire inflation pressure.....	285
Tire Monitor.....	295, 296
Tire Pressure Monitoring System....	291, 294
indicator light.....	67
Tires.....	273
age.....	274
changing from summer to winter.....	276
glossing of terms.....	287
improving economy.....	275
inflation pressure.....	281, 282
inflation pressure table.....	285
rotation.....	273
Self-supporting run flat tires (SST)....	297
snow.....	289, 290
spare.....	279
specifications.....	283
speed ratings.....	283
storing.....	274
studded.....	289, 290
tire pressure monitoring system.....	291
tire sealing system.....	298
tread wear indicator.....	275
uniform tire quality grading.....	288
Tire sealing system.....	298
Top tether anchors (child restraint systems).....	56
Touching up paint.....	347
Towing a trailer.....	266, 267, 268
Towing the vehicle.....	268, 269, 270
Traction control.....	162, 163
Trailer towing.....	266, 267, 268
Transmission	
general description.....	238, 240
Hill Start Assist.....	238
oil.....	360
shiftlock override.....	242
Tread wear indicator.....	275
Trip computer.....	108
Trip odometers.....	72
Trips, long distance.....	259
Trunk	
changing bulbs.....	325
Tunnel detection.....	85

Turn signals.....	88
changing bulbs.....	322
indicator lights.....	67

## U

Uniform Tire Quality Grading.....	288
Unlocking the vehicle.....	143, 153, 154, 155, 156

## V

Valet locking.....	146
Vanity mirror.....	135
changing bulbs.....	325
Vehicle Event Data.....	18
Vehicle loading.....	136, 138, 286
roof loads.....	137
Vehicle maintenance.....	306
performed by the owner.....	307
Vehicle weights.....	355
Ventilated seats.....	124
Volvo and the environment.....	21
Volvo ID.....	20
Volvo maintenance.....	306

Volvo On Call Roadside Assistance..... 23  
 Volvo programs..... 23  
 Volvo Sensus..... 105

## W

Warning flashers, hazard..... 88  
 Warning lights..... 62, 64, 68  
 Warning symbol..... 69  
 Warning system, collision..... 196, 198, 204  
 Warranties..... 306  
 Washer fluid..... 328, 361  
 Washers  
   headlight..... 92  
   windshield..... 91  
 Water, driving through..... 258  
 Waxing..... 344  
 Weights..... 355  
 Wheels..... 273  
   changing..... 276  
   storing..... 274  
 Whiplash Protection System..... 42  
 Windows  
   power..... 94  
   sun shade..... 94

Windshield  
   heated..... 98, 126  
   rain sensor..... 92  
   washers..... 92  
   wipers/washers..... 91  
 Windshield washer fluid..... 328, 361  
 Windshield wipers..... 326  
   service position..... 326  
 Wiper blades  
   replacing..... 326





