



V40

CROSS COUNTRY

WEB EDITION
OWNER'S MANUAL



DEAR VOLVO OWNER

THANK YOU FOR CHOOSING VOLVO

We hope you will enjoy many years of driving pleasure in your Volvo. The car has been designed for the safety and comfort of you and your passengers. Volvo is one of the safest cars in the world. Your Volvo has also been designed to satisfy all current safety and environmental requirements.

In order to increase your enjoyment of the car, we recommend that you familiarise yourself with the equipment, instructions and maintenance information contained in this owner's manual.





01 Introduction

Owner information.....	13
Reading the owner's manual.....	13
Digital owner's manual in the car.....	16
Recording data.....	18
Accessories and extra equipment.....	19
Information on the Internet.....	20
Volvo ID.....	20
Volvo Cars' environmental philosophy.....	21
The owner's manual and the environment.....	23
Laminated glass.....	23



02 Safety

General information on seatbelts.....	25
Seatbelt - putting on.....	26
Seatbelt - loosening.....	27
Seatbelt - pregnancy.....	27
Seatbelt reminder.....	28
Seatbelt tensioner.....	28
Safety - warning symbol.....	29
Airbag system.....	30
Airbags on driver's side.....	31
Passenger airbag.....	31
Passenger airbag - activating/deactivating*.....	33
Side airbag (SIPS).....	35
Side airbag (SIPS) - child seat/booster cushion.....	36
Inflatable Curtain (IC).....	36
General information on WHIPS (whiplash protection).....	37
WHIPS - child seats.....	38
WHIPS - seating position.....	38
When the systems deploy.....	39
General information on safety mode.....	40
Safety mode - attempting to start the car.....	41
Safety mode - moving the car.....	42



Pedestrian airbag*.....	42
Pedestrian airbag* - moving the car.....	43
Pedestrian airbag* - folding up.....	43
General information on child safety.....	44
Child seats.....	45
Child seats - location.....	49
Child seat - ISOFIX.....	50
ISOFIX - size classes.....	50
ISOFIX - types of child seat.....	51
Child seats - upper mounting points.....	53



03 Instruments and controls

Instruments and controls, left-hand drive car - overview.....	55
Instruments and controls, right-hand drive car - overview.....	58
Combined instrument panel.....	61
Analogue combined instrument panel - overview.....	61
Digital combined instrument panel - overview.....	62
Eco guide & Power guide*.....	65
Combined instrument panel - meaning of indicator symbols.....	66
Combined instrument cluster - meaning of warning symbols.....	68
Outside temperature gauge.....	70
Trip meter.....	70
Clock.....	70
Combined instrument panel - licenses.....	71
Symbols in the display.....	72
Volvo Sensus.....	74
Key positions.....	75
Key positions - functions at different levels.....	76
Seats, front.....	77
Seats, front - electrically operated.....	79



Seats, rear.....	80
Steering wheel.....	82
Light switches.....	83
Position/parking lamps.....	85
Daytime running lights.....	85
Tunnel detection*.....	86
Main/dipped beam.....	86
Active main beam*.....	87
Active Xenon headlamps*.....	89
Rear fog lamp.....	89
Brake lights.....	90
Hazard warning flashers.....	90
direction indicators.....	91
Interior lighting.....	92
Home safe light duration.....	93
Approach light duration.....	93
Headlamps - adjusting headlamp pattern.....	94
Wipers and washing.....	97
Power windows.....	99
Door mirrors.....	101
Windows and rearview and door mirrors - heating.....	102
Rearview mirror - interior.....	103



Glass roof*.....	103
Compass.....	104
Menu navigation - combined instrument panel.....	105
Menu overview - analogue combined instrument panel.....	106
Menu overview - digital combined instrument panel.....	106
Messages.....	106
Messages - handling.....	107
MY CAR.....	108
Trip computer.....	109
Trip computer - analogue combined instrument panel.....	110
Trip computer - digital combined instrument panel.....	114
Trip computer - supplementary information.....	118
Trip computer - trip statistics*.....	119



04 Climate control

General information on climate control...	121
Actual temperature.....	122
Sensors - climate control.....	122
Air quality.....	122
Air quality - passenger compartment filter.....	123
Air quality - Clean Zone Interior Package (CZIP)*.....	123
Air quality - IAQS*.....	124
Air quality - material.....	124
Menu settings - climate control.....	124
Air distribution in the passenger compartment.....	125
Electronic climate control - ECC*.....	127
Electronic temperature control - ETC.....	128
Heated front seats*.....	129
Heated rear seat*.....	129
Fan.....	130
Auto-regulation.....	130
Temperature control in the passenger compartment.....	131
Air conditioning.....	131
Demisting and defrosting the wind-screen.....	132
Air distribution - recirculation.....	133



Air distribution - table.....	134
Engine block heater and passenger compartment heater*.....	136
Engine block heater and passenger compartment heater* - direct start.....	137
Engine block heater and passenger compartment heater* - immediate stop.....	138
Engine block heater and passenger compartment heater* - timer.....	138
Engine block heater and passenger compartment heater* - messages.....	139
Additional heater*.....	140
Fuel-driven additional heater*.....	140
Electric additional heater*.....	141



05 Loading and storage

Storage spaces.....	143
Storage compartment driver's side.....	145
Tunnel console.....	145
Tunnel console - armrest.....	145
Tunnel console - cigarette lighter and ashtray*.....	146
Glovebox.....	146
Glovebox - cooling.....	146
Inlay mats*.....	147
Vanity mirror.....	147
Tunnel console - 12 V-sockets.....	147
Loading.....	148
Loading - long load.....	149
Roof load.....	149
Load retaining eyelets.....	150
Loading - bag holder.....	150
Loading - folding bag holder*.....	150
12 V socket - cargo area.....	151
Cargo net.....	152
Hat shelf.....	154



06 Locks and alarm

Remote control key.....	156
Remote control key - losing	156
Remote control key - personalisation*....	157
Locking/unlocking - indicator.....	158
Lock indicator.....	158
Remote control key - electronic immobiliser.....	159
Remote-controlled immobiliser with tracking system*.....	159
Remote control key - functions.....	160
Remote control key - range.....	161
Remote control key with PCC* - unique functions.....	162
Remote control key with PCC* - range...	163
Detachable key blade.....	163
Detachable key blade - detaching/attaching.....	164
Detachable key blade - unlocking doors	164
Remote control key/PCC - replacing the battery.....	165
Keyless drive*.....	166
Keyless Drive* - range.....	166
Keyless Drive* - secure handling of the remote control key.....	167



Keyless Drive* - interference to remote control key function.....	167
Keyless Drive* - locking.....	168
Keyless Drive* - unlocking.....	168
Keyless Drive* - unlocking with the key blade.....	169
Keyless Drive* - lock settings.....	169
Keyless Drive* - antenna location.....	170
Locking/unlocking - from the outside ...	170
Manual locking of the door.....	171
Locking/unlocking - from the inside.....	172
Total airing function.....	173
Locking/unlocking - glovebox.....	173
Locking/unlocking - tailgate.....	173
Locking/unlocking - fuel filler flap.....	175
Deadlocks*.....	175
Child safety locks - manual activation....	176
Child safety locks - electrical activation*	177
Alarm.....	178
Alarm indicator.....	179
Alarm - automatic re-arming.....	179
Alarm - automatic arming.....	179
Alarm - remote control key not working.	180
Alarm signals.....	180



Reduced alarm level.....	180
Type approval - remote control key system.....	181

06



07 Driver support

Electronic stability control (ESC) - general.....	183
Electronic stability control (ESC) - operation.....	184
Electronic stability control (ESC) - symbols and messages.....	185
Road Sign Information (RSI).....	187
Road sign information (RSI)* - operation	187
Road sign information (RSI)* - limitations	189
Speed limiter*.....	189
Speed limiter* - getting started.....	190
Speed limiter* - changing speed.....	191
Speed limiter - temporary deactivation and standby mode*.....	191
Speed limiter* - alarm for speed exceeded.....	192
Speed limiter* - deactivation.....	193
Cruise control*.....	193
Cruise control* - managing speed.....	194
Cruise control* temporary deactivation and standby mode.....	195
Cruise control* - resume set speed.....	196
Cruise control* - deactivate.....	197
Adaptive cruise control (ACC)*.....	198
Adaptive cruise control* - function.....	199



Adaptive cruise control* - overview.....	201
Adaptive cruise control* - managing speed.....	202
Adaptive cruise control* - set time interval.....	203
Adaptive cruise control* - temporary deactivation, and standby mode.....	203
Adaptive cruise control* - overtaking another vehicle.....	204
Adaptive cruise control* - deactivate.....	205
Adaptive Cruise Control* - queue assistance.....	205
Adaptive cruise control* - switch cruise control functionality.....	207
Radar sensor.....	208
Radar sensor - limitations.....	208
Adaptive cruise control* - fault tracing and action.....	210
Adaptive cruise control* - symbols and messages.....	211
Distance Warning*.....	213
Distance Warning* - limitations.....	214
Distance Warning* - symbols and messages.....	215
City Safety™.....	216
City Safety™ - function.....	216



City Safety™ - operation.....	217
City Safety™ - limitations.....	218
City Safety™ - laser sensor.....	220
City Safety™ - symbols and messages..	222
Collision warning system*.....	223
Collision warning system* - function.....	224
Collision warning system* - detection of cyclists.....	225
Collision warning system* - detection of pedestrians.....	226
Collision warning system* - operation...	227
Collision warning system* - limitations...	228
Collision warning system* - camera sensor limitations.....	229
Collision warning system* - symbols and messages.....	231
Driver Alert System*.....	232
Driver Alert Control (DAC)*.....	232
Driver Alert Control (DAC)* - operation...	233
Driver Alert Control (DAC)* - symbols and messages.....	234
Lane Keeping Aid*.....	235
Lane Keeping Aid - function.....	235
Lane Keeping Aid - operation.....	237
Lane Keeping Aid - limitations.....	237



Lane Keeping Aid - symbols and messages.....	239
Park Assist*.....	240
Park assist syst* - function.....	240
Park assist syst* - backward.....	242
Park assist syst* - forward.....	242
Park assist syst* - fault indication.....	243
Park assist syst* - cleaning the sensors.....	243
Park assist camera.....	244
Park assist camera - settings.....	246
Park assist camera - limitations.....	248
Park Assist Pilot (PAP)*.....	248
Park Assist Pilot (PAP)* - function.....	249
Park Assist Pilot (PAP)* - operation.....	249
Park Assist Pilot (PAP)* - limitations.....	251
Active Park Assist (PAP)* - symbols and messages.....	252
BLIS.....	253
BLIS - operation.....	254
CTA*.....	255
BLIS and CTA - symbols and messages.....	257
Adjustable steering force.....	258
Type approval - radar system.....	258



08 Starting and driving

Alcohol lock*.....	260
Alcohol lock* - functions and operation..	260
Alcohol lock* - storage.....	261
Alcohol lock* - before starting the engine	261
Alcohol lock* - to bear in mind.....	263
Alcohol lock* - symbols and messages..	264
Starting the engine.....	265
Switching off the engine.....	266
Steering lock.....	266
Jump starting.....	267
Gearboxes.....	268
Manual gearbox.....	268
Gear shift indicator*.....	269
Automatic gearbox - Geartronic*.....	269
Automatic gearbox - Powershift*.....	273
Gear selector inhibitor.....	275
Hill start assist (HSA)*.....	276
Start/Stop*.....	276
Start/Stop* - function and operation.....	277
Start/Stop* - the engine does not stop..	278
Start/Stop* - the engine auto-starts.....	280
Start/Stop* - the engine does not auto-start.....	281



Start/Stop* - involuntary stop manual gearbox.....	281
Start/Stop* - settings.....	282
Start/Stop* - symbols and messages.....	283
ECO*.....	285
All Wheel Drive (AWD)*.....	287
Hill Descent Control (HDC).....	287
Foot brake.....	289
Foot brake - anti-lock braking system....	290
Foot brake - emergency brake lights and automatic hazard warning flashers.....	290
Foot brake - emergency brake assistance.....	291
Parking brake.....	291
Driving in water.....	292
Overheating.....	293
Driving with open tailgate.....	293
Overload - starter battery.....	294
Before a long journey.....	294
Winter driving.....	294
Fuel filler flap - Opening/closing.....	295
Fuel filler flap - manual opening.....	295
Filling up with fuel.....	296
Fuel - handling.....	296



Fuel - petrol.....	297
Fuel - diesel.....	298
Catalytic converters.....	299
Filling with fuel - with a fuel can.....	300
Diesel particle filter (DPF).....	300
Economical driving.....	301
Driving with a trailer.....	301
Driving with a trailer - manual gearbox...	303
Driving with a trailer - automatic gearbox	303
Towing bracket.....	304
Detachable towbar* - storage.....	304
Detachable towbar* - specifications.....	305
Detachable towbar* - attachment/ removal.....	305
Trailer Stability Assist - TSA.....	308
Towing.....	309
Towing eye.....	310
Recovery.....	311



09 Wheels and tyres

Tyres - maintenance.....	313
Tyres - direction of rotation.....	314
Tyres - tread wear indicators.....	315
Tyres - air pressure.....	315
Wheel and wheel rim dimensions.....	316
Tyres - dimensions.....	316
Tyres - load index.....	317
Tyres - speed ratings.....	317
Wheel nuts.....	318
Winter tyres.....	318
Spare wheel*.....	319
Changing wheels - taking out the spare wheel*.....	320
Changing wheels - removing wheels.....	320
Changing wheels - fitting the spare wheel*.....	322
Warning triangle.....	324
Jack.....	325
First aid kit*.....	325
Tyre pressure monitoring*.....	325
Tyre pressure monitoring system (TPMS)* - general.....	326
Tyre pressure monitoring (TPMS)* - adjust (recalibration).....	327



Tyre pressure monitoring system (TPMS)* - status.....	328
Tyre pressure monitoring (TPMS)* - acti- vate/deactivate.....	329
Tyre pressure monitoring (TPMS)* - rec- ommendations.....	329
Tyre pressure monitoring (TPMS)* - driv- eable punctured tyres*.....	330
Tyre pressure monitoring (TPMS)* - recti- fying low tyre pressure.....	330
Tyre pressure monitoring (TM)*.....	331
Emergency puncture repair*.....	333
Emergency puncture repair kit* - loca- tion.....	333
Emergency puncture repair kit* - over- view.....	334
Emergency puncture repair* - operation.	335
Emergency puncture repair* - recheck- ing.....	337
Inflating tyres with the emergency punc- ture repair kit*.....	338
Emergency puncture repair* - returning components to their places.....	339
Emergency puncture repair kit* - sealant	339
Type approval - tyre pressure monitoring (TPMS).....	340

**10 Maintenance and service**

Volvo service programme.....	347
Book service and repair*.....	347
Raising the car.....	350
Bonnet - opening and closing.....	352
Engine compartment - overview.....	352
Engine compartment - checking.....	353
Engine oil - general.....	354
Engine oil - checking and filling.....	355
Coolant - level.....	358
Brake and clutch fluid - level.....	359
Climate control system - fault tracing and repair.....	360
Lamp replacement - general.....	360
Lamp replacement - location of front lamps.....	361
Lamp replacement - headlamps.....	362
Lamp replacement - cover for main/dipped beam bulbs.....	362
Lamp replacement - dipped beam.....	363
Lamp replacement - main beam.....	363
Lamp replacement - extra main beam....	363
Lamp replacement - direction indicators front.....	364
Lamp replacement - position/parking lamps front.....	364



Lamp replacement - daytime running lights.....	364
Lamp replacement - location of rear lamps.....	365
Lamp replacement - direction indicators rear, brake lights and reversing lamp....	365
Lamp replacement - rear fog lamp.....	366
Lamp replacement - vanity mirror lighting.....	366
Lamps - specifications	367
Wiper blades.....	367
Washer fluid - filling.....	370
Starter battery - general.....	370
Battery - symbols.....	372
Starter battery - replacement.....	373
Battery - Start/Stop.....	373
Electrical system.....	375
Fuses - general.....	375
Fuses - in engine compartment.....	377
Fuses - under glovebox.....	381
Fuses - under the right-hand front seat..	384
Car wash.....	386
Polishing and waxing.....	387
Water and dirt-repellent coating.....	388
Rustproofing.....	388



Cleaning the interior.....	389
Paint damage.....	390

10



11 Specifications

Type designations.....	393
Dimensions.....	395
Weights.....	396
Towing capacity and towball load.....	397
Engine specifications.....	399
Engine oil - adverse driving conditions...	400
Engine oil - grade and volume.....	401
Coolant - grade and volume.....	403
Transmission fluid - grade and volume...	404
Brake fluid - grade and volume.....	405
Washer fluid - quality and volume.....	405
Fuel tank - volume.....	406
Air conditioning, fluid - volume and grade.....	407
Fuel consumption and CO2 emissions...	409
Tyres - approved tyre pressures.....	412



12 Alphabetical Index

Alphabetical Index.....	414
-------------------------	-----





01



INTRODUCTION



Owner information

Your car is fitted with a screen which shows information on how your car is working¹.

For cars with owner information in the screen, the printed owner's manual is a supplement and contains important text, the latest updates, as well as instructions that can be useful when, for practical reasons, you are unable to read the information on the screen.

Changing the display language may mean that some information does not correspond to national or local laws and regulations.

! IMPORTANT

The driver is always responsible that the vehicle is driven safely in traffic and that applicable laws and regulations are followed. It is also important that the car is maintained and handled in accordance with Volvo's recommendations in the owner's information.

If there should be a difference between the information on the screen and in the printed manual then it is always the printed information that applies.

Reading the owner's manual

A good way of getting to know your new car is to read the owner's manual, ideally before your first journey.

Reading the owner's manual will give you the opportunity to familiarise yourself with new functions, advice on how best to handle the car in different situations and to make the best use of all the car's features. Please pay attention to the safety instructions contained in the owner's manual.

The specifications, design features and illustrations in this owner's manual are not binding. We reserve the right to make modifications without prior notice.

© Volvo Car Corporation

Owner's Manual in mobile devices



i NOTE

The owner's manual is available for download as a mobile application (applies for certain car models and mobile devices), see www.volvocars.com.

The mobile application also includes video and searchable content and easy navigation between different sections.

Options/accessories

All types of option/accessory are marked with an asterisk*.

In addition to standard equipment, the owner's manual also describes options (factory fitted equipment) and certain accessories (retrofitted extra equipment).

The equipment described in the owner's manual is not available in all cars - they have different equipment depending on adaptations for the needs of different markets and national or local laws and regulations.

In the event of uncertainty over what is standard or an option/accessory, contact a Volvo dealer.

¹ Applies to certain car models.



Special texts

WARNING

Warning texts appear if there is a risk of injury.

IMPORTANT

"Important" texts appear if there is a risk of damage.

NOTE

NOTE texts give advice or tips that facilitate the use of features and functions for example.

Footnote

There is footnote information in the owner's manual that is located at the bottom of the page. This information is an addition to the text that it refers to via a number. If the footnote refers to text in a table then letters are used instead of numbers for referral.

Message texts

In the car there are displays that show menu texts and message texts. In the owner's manual the appearance of these texts differs from the normal text. Examples of menu texts and message texts: **Media**, **Sending location**.

Decals

The car contains different types of decal which are designed to convey important information in a simple and clear manner. The decals in the car have the following descending degree of importance for the warning/information.

Warning for personal injury

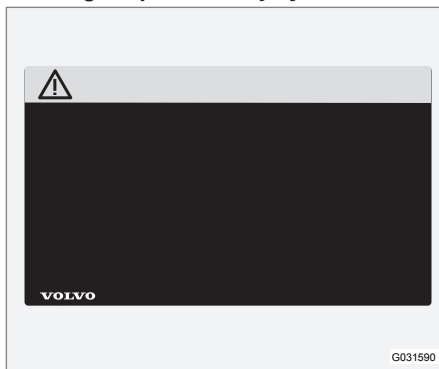

Black ISO symbols on yellow warning field, white text/image on black message field. Used to indicate the presence of danger which, if the warning is ignored, may result in serious personal injury or fatality.

Risk of property damage



White ISO symbols and white text/image on black or blue warning field and message field. Used to indicate the presence of danger which, if the warning is ignored, may result in damage to property.

Information

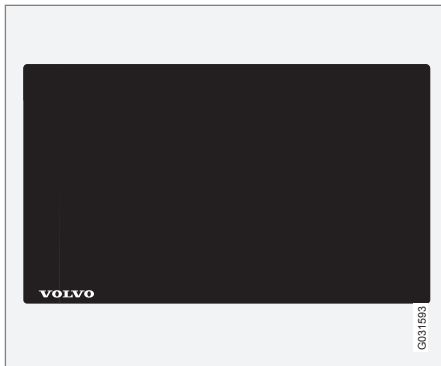

White ISO symbols and white text/image on black message field.

i NOTE

It is not intended that the decals illustrated in the owner's manual should be exact replicas of those in the car. They are included to show their approximate appearance and location in the car. The information that applies to your particular car is available on the respective decals for your car.

Procedure lists

Procedures where action must be taken in a certain sequence are numbered in the owner's manual.

1 When there is a series of illustrations for step-by-step instructions each step is numbered in the same way as the corresponding illustration.

A There are numbered lists with letters adjacent to the series of illustrations where the order of the instructions is not significant.

➔ Arrows appear numbered and unnumbered and are used to illustrate a movement.

A➔ Arrows with letters are used to clarify a movement when the reciprocal order is of no relevance.

If there is no series of illustrations for step-by-step instructions then the different steps are numbered with normal numbers.

Position lists

1 Red circles containing a number are used in overview images where different components are pointed out. The number recurs in the position list featured in connection with the illustration that describes the item.

Bulleted lists

A bulleted list is used when there is a list of points in the owner's manual.

Example:

- Coolant
- Engine oil

Related information

Related information refers to other articles containing closely-associated information.

Images

The manual's images are sometimes schematic and may deviate from the car's appearance depending on equipment level and market.

To be continued

▶▶ This symbol is located furthest down to the right when an article continues on the following page.

Continued from previous page

◀◀ This symbol is located furthest up to the left when an article continues from the previous page.

Related information

- The owner's manual and the environment (p. 23)
- Information on the Internet (p. 20)



01 Introduction

01

Digital owner's manual in the car

The owner's manual can be read on the screen in the car². The content is searchable and it is easy to navigate between different sections.

Open the digital owner's manual - press the **MY CAR** button in the centre console, press **OK/MENU** and select **Owner's manual**.

For basic navigation, see Operating the system. See below for a more detailed description.

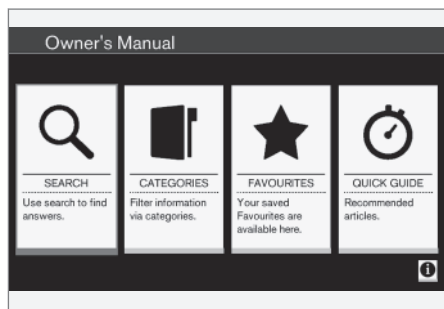

Owner's manual, start page.

There are four options for finding information in the digital owner's manual:

- **Search** - Search function for finding an article.
- **Categories** - All articles sorted into categories.
- **Favourites** - Quick access to favourite-bookmarked articles.
- **Quick Guide** - A selection of articles for common functions.

Select the information symbol in the lower right-hand corner in order to obtain information about the digital owner's manual.



NOTE

The digital owner's manual is not available while driving.

Search

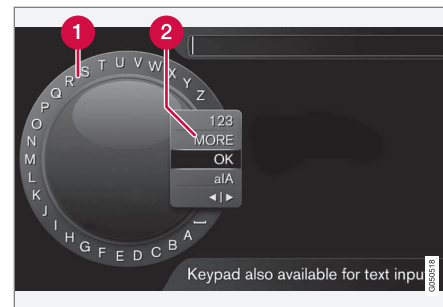

Searching using the character wheel.

- 1 Character list.
- 2 Changing the input mode (see following table).

Use the character wheel to enter a search term, e.g. "seatbelt".

1. Turn **TUNE** to the desired letter, press **OK/MENU** to confirm. The number and letter buttons on the control panel in the centre console can also be used.
2. Continue with the next letter and so on.

² Applies to certain car models.



3. To change the input mode to numbers or special characters, or to perform a search, turn **TUNE** to one of the options (see explanation in the following table) in the list for changing the input mode (2), press **OK/MENU**.

123/ABC	Change between letters and numbers with OK/MENU .
MORE	Change to special characters with OK/MENU .
OK	Perform the search. Turn TUNE to select a search result article, press OK/MENU to go to the article.
a A	Changes between lowercase and uppercase letters with OK/MENU .
◀▶	Changes from the character wheel to the search field. Move the cursor with TUNE . Delete any misspelling with EXIT . To return to the character wheel, press OK/MENU . Note that the digit and letter buttons on the control panel can be used for editing in the search field.

Enter with the numerical keyboard



Numerical keyboard.

Another way of entering characters is to use the centre console's buttons **0-9**, ***** and **#**.

When e.g. **9** is pressed, a bar appears with all characters³ under the button, e.g. **W**, **x**, **y**, **z** and **9**. Quick presses on the button move the cursor through these characters.

- Stop with the cursor on the desired character in order to select it - the character is shown on the enter line.
- Delete/undo using **EXIT**.

To enter a number, hold in the corresponding number key.

Categories

The articles in the owner's manual are structured into main categories and subcategories.

The same article can be in several appropriate categories in order to be found more easily.

Turn **TUNE** to navigate in the category tree and press **OK/MENU** to open a category - selected **▶** - or article - selected **◻**. Press **EXIT** to go back to the previous view.

Favourites

Located here are the articles that are saved as favourites. To select an article as a favourite, see the heading "Navigating in an article" below.

Turn **TUNE** to navigate in the favourite list and press **OK/MENU** to open an article. Press **EXIT** to go back to the previous view.

Quick Guide

Located here is a selection of articles for getting to know the car's most common functions. The articles can also be accessed via categories, but are collected here for quick access.

Turn **TUNE** to navigate in the Quick Guide and press **OK/MENU** to open an article. Press **EXIT** to go back to the previous view.

³ The character for each button may vary depending on market/country/language.



Navigating in an article

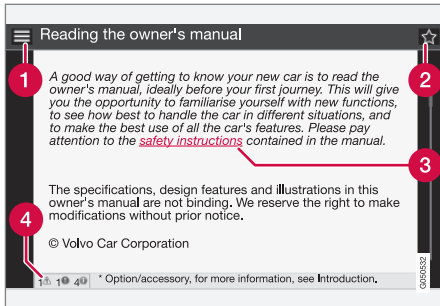

- 1 **Home** - leads to the start page for the owner's manual.
- 2 **Favourite** - adds/removes an article as a favourite. You can also press the **FAV** button in the centre console to add/remove an article as a favourite.
- 3 **Highlighted link** - leads to linked article.
- 4 **Special texts** - if the article contains warnings, important or note texts then an associated symbol is shown here as well as the number of such texts in the article.

Turn **TUNE** to navigate between the links or scroll in an article. When the screen has scrolled to the start/end of an article the home and favourite options are accessed by scrolling a further step up/down. Press **OK/MENU** to activate the selection/highlighted link. Press **EXIT** to go back to the previous view.

Related information

- Information on the Internet (p. 20)

Recording data

Certain information about the vehicle's operation and functionality, and any incidents, are recorded in the car.

Your vehicle contains a number of computers whose function is to continuously check and monitor the vehicle's operation and functionality. Some of the computers can record information during normal driving if they detect an error. In addition, information is recorded in the event of a collision or incident. Parts of the recorded information are required so that technicians can diagnose and rectify faults in the vehicle during servicing and maintenance and so that Volvo can fulfil legal requirements and other regulations. In addition to this, the information is used for research purposes by Volvo in order to continually develop quality and safety, as the information can contribute to a better understanding of the factors that cause accidents and injuries. The information includes details of the status and functionality of various systems and modules in the vehicle with regard to engine, throttle, steering and brake systems, amongst other things. This information may include details regarding the way the driver drives the vehicle, such as vehicle speed, brake and accelerator pedal use, steering wheel movement and whether or not the driver and passengers have used their seatbelts. For the reasons given this information may be stored in the vehicle's computers

for a certain length of time, but also as a result of a collision or incident. This information may be stored by Volvo as long as it can help to further develop and further enhance safety and quality and as long as there are legal requirements and other regulations that Volvo needs to consider.

Volvo will not contribute to the above-described information being disclosed to third parties without the vehicle owner's consent. However, due to national legislation and regulations Volvo may be required to disclose such information to authorities such as police authorities, or others who may assert a legal right to have access to it.

To be able to read and interpret the information recorded by the computers in the vehicle requires special technical equipment that Volvo, and workshops that have entered into agreements with Volvo, have access to. Volvo is responsible that the information, which is transferred to Volvo during servicing and maintenance, is stored and handled in a secure manner and that the handling complies with applicable legal requirements. For further information - contact a Volvo dealer.

Accessories and extra equipment

The incorrect connection and installation of accessories and extra equipment can negatively affect the car's electronic system.

Certain accessories only function when associated software is installed in the car's computer system. Volvo therefore recommends that you always contact an authorised Volvo workshop before installing accessories or extra equipment which are connected to or affect the electrical system.

Heat-reflecting windscreen*

The windscreen is equipped with a heat-reflecting film (IR) that reduces the solar heat radiation into the passenger compartment.

The positioning of electronic equipment, such as a transponder, behind a glass surface with heat-reflecting film may affect its function and performance.

For the optimal function of electronic equipment, it should be positioned on the part of the windscreen with no heat-reflecting film (see the highlighted area in the illustration).

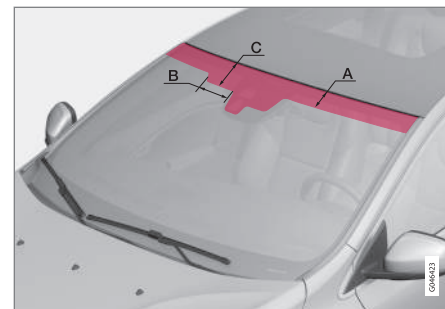

Areas where IR film is not applied.

	Dimensions
A	65 mm
B	150 mm
C	125 mm

* Option/accessory, for more information, see Introduction.



Information on the Internet

At www.volvocars.com there is further information concerning your car.

With a personal Volvo ID it is possible to log in to My Volvo which is a personal web page for you and your car.



QR code

A QR code reader is required to read the QR code, which is available as a supplemental program (app) for several mobile phones. The QR code reader can be downloaded from e.g. App Store, Windows Phone or Google Play.

Volvo ID

Volvo ID is your personal ID that provides access to various services⁴.

Examples of services:

- My Volvo - Your personal web page for you and your car.
- In an Internet-connected car* - Certain functions and services require that you have registered your car to a personal Volvo ID, for example to be able to send a new address from a map service on the Internet directly to the car.
- Volvo On Call, VOC* - Volvo ID is used when logging in to the Volvo On Call mobile app.

Advantages of Volvo ID

- One user name and one password to access online services, i.e. only one user name and one password to remember.
- When changing the username/password for a service (e.g. VOC) it will also be changed automatically for other services (e.g. My Volvo)

Create a Volvo ID

To create a Volvo ID you need to enter a personal e-mail address. Then follow the instructions in the e-mail message that is automatically sent to the specified address in order to complete the registration. It is possible to cre-

ate a Volvo ID via one of the following services:

- My Volvo - Enter your e-mail address and follow the instructions.
- For an Internet-connected car* - Enter your e-mail address in the app that requires Volvo ID and follow the instructions. Alternatively press the Connect button  in the centre console and select **Apps** → **Settings** and follow the instructions.
- Volvo On Call, VOC* - Download the latest version of the VOC app. Choose to create a Volvo ID from the start page, enter e-mail address and follow the instructions.

Related information

- Information on the Internet (p. 20)

⁴ The services available may vary over time and vary depending on equipment level and market.



Volvo Cars' environmental philosophy

Your Volvo complies with strict international environmental standards and is also manufac-

tured in one of the cleanest and most resource-efficient plants in the world.



Environmental care is one of Volvo Car Corporation's core values which influence all operations. We also believe that our customers share our consideration for the environment.

Volvo Car Corporation has global ISO certification, which includes the environmental standard ISO 14001 covering all factories and several of our other units. We also set requirements for our partners so that they work systematically with environmental issues.

Fuel consumption

Volvo cars have competitive fuel consumption in each of their respective classes. Lower fuel consumption generally results in lower emission of the greenhouse gas, carbon dioxide.

It is possible for the driver to influence fuel consumption. For more information read under the heading, **Reducing environmental impact**.

Efficient emission control

Your Volvo is manufactured following the concept "Clean inside and out" – a concept

that encompasses a clean interior environment as well as highly efficient emission control. In many cases the exhaust emissions are well below the applicable standards.

Clean air in the passenger compartment

A passenger compartment filter prevents dust and pollen from entering the passenger compartment via the air intake.

A sophisticated air quality system, IAQS* (Interior Air Quality System) ensures that the incoming air is cleaner than the air in the traffic outside.

* Option/accessory, for more information, see Introduction.



The system consists of an electronic sensor and a carbon filter. The incoming air is monitored continuously and if there is an increase in the level of certain unhealthy gases such as carbon monoxide then the air intake is closed. Such a situation may arise in heavy traffic, queues and tunnels for example.

The entry of nitrous oxides, ground-level ozone and hydrocarbons is prevented by the carbon filter.

Interior

The interior of a Volvo is designed to be pleasant and comfortable, even for people with contact allergies and for asthma sufferers. Extreme attention has been given to choosing environmentally-compatible materials.

Volvo workshops and the environment

Regular maintenance creates the conditions for a long service life and low fuel consumption for your car. In this way you contribute to a cleaner environment. When Volvo's workshops are entrusted with the service and maintenance of your car it becomes part of our system. Volvo makes clear demands regarding the way in which our workshops are designed in order to prevent spills and discharges into the environment. Our workshop staff have the knowledge and the tools required to guarantee good environmental care.

Reducing environmental impact

You can easily help reduce environmental impact - here are a few tips:

- Avoid letting the engine idle - switch off the engine when stationary for longer periods. Pay attention to local regulations.
- Drive economically - think ahead.
- Perform service and maintenance in accordance with the instructions in the owner's manual - follow the Service and Warranty Booklet's recommended intervals.
- If the car is equipped with an engine block heater*, use it before starting from cold - it improves starting capacity and reduces wear in cold weather and the engine reaches normal operating temperature more quickly, which lowers consumption and reduces emissions.
- High speed increases consumption considerably due to increased wind resistance - a doubling of speed increases wind resistance 4 times.
- Always dispose of environmentally hazardous waste, such as batteries and oils, in an environmentally safe manner. Consult a workshop in the event of uncertainty about how this type of waste should be discarded - an authorised Volvo workshop is recommended.

Following this advice can save money, the planet's resources are saved, and the car's

durability is extended. For more information and further advice, see Eco guide (p. 65), Economical driving (p. 301) and Fuel consumption (p. 409).

Recycling

As a part of Volvo's environmental work, it is important that the car is recycled in an environmentally sound manner. Almost all of the car can be recycled. The last owner of the car is therefore requested to contact a dealer for referral to a certified/approved recycling facility.

Related information

- The owner's manual and the environment (p. 23)

The owner's manual and the environment

The paper pulp in a printed owner's manual comes from FSC® certified forests or other controlled sources.

The Forest Stewardship Council® symbol shows that the paper pulp in a printed owner's manual comes from FSC® certified forests or other controlled sources.



Related information

- Volvo Cars' environmental philosophy (p. 21)

Laminated glass

Laminated glass



The glass is reinforced which provides better protection against break-ins and improved sound insulation in the passenger compartment. The windscreen and other windows* have laminated glass.

* Option/accessory, for more information, see Introduction.

02

SAFETY

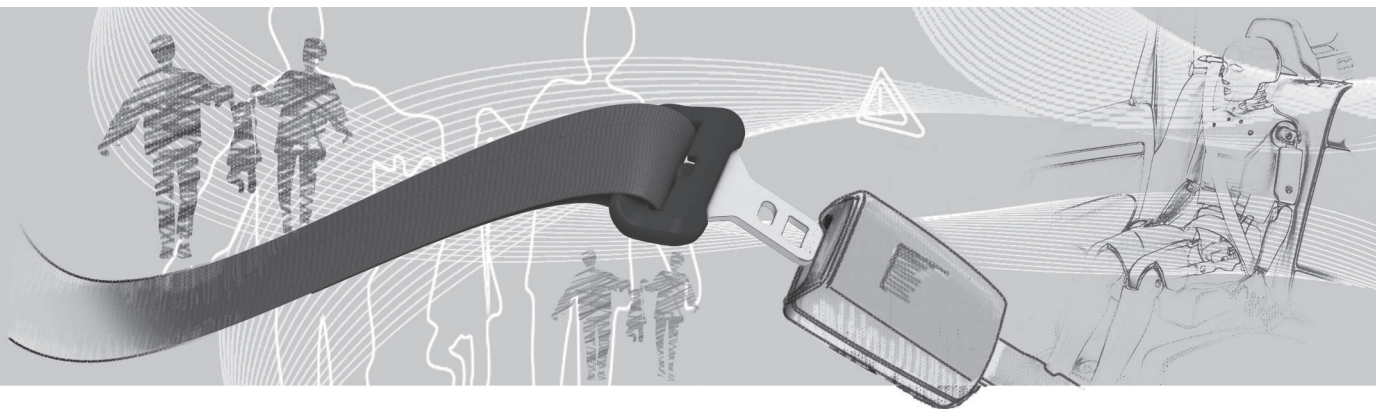



General information on seatbelts

Heavy braking can have serious consequences if the seatbelts are not used. Ensure that all passengers are using their seatbelts during the journey.

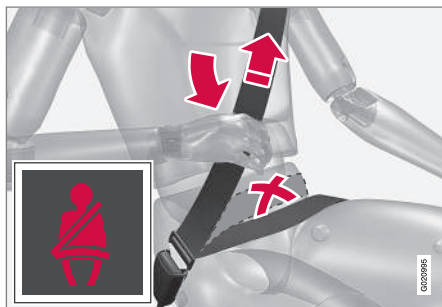

Tension the hip strap over the lap by pulling the diagonal shoulder belt up towards the shoulder. The hip strap must be positioned low down (not over the abdomen).

It is important that the seatbelt lies against the body so it can provide maximum protection. Do not lean the backrest too far back. The seatbelt is designed to protect in a normal seating position.

Unbelted occupants will be reminded to fasten their (p. 26) seatbelt by means of an audio and visual reminder (p. 28).

Remember

- Do not use clips or anything else that can prevent the seatbelt from fitting properly.
- The seatbelt must not be twisted or caught on anything.

WARNING

The seatbelts and airbags interact. If a seatbelt is not used or is used incorrectly, this may diminish the protection provided by the airbag in the event of a collision.

WARNING

Each seatbelt is designed for only one person.

WARNING

Never modify or repair the seatbelts yourself. Volvo recommends that you contact an authorised Volvo workshop.

If the seatbelt has been subjected to a major load, such as in conjunction with a collision, the entire seatbelt must be replaced. Some of the seatbelt's protective properties may have been lost even if the seatbelt does not appear damaged. The seatbelt must also be replaced if it shows signs of wear or damage. The new seatbelt must be type-approved and designed for installation at the same location as the replaced seatbelt.

Related information

- Seatbelt - pregnancy (p. 27)
- Seatbelt - loosening (p. 27)
- Seatbelt tensioner (p. 28)



Seatbelt - putting on

Put on the seatbelt (p. 25) before driving starts.

Pull the belt out slowly and secure it by pressing its locking tab into the seatbelt buckle. A loud "click" indicates that the belt has locked.

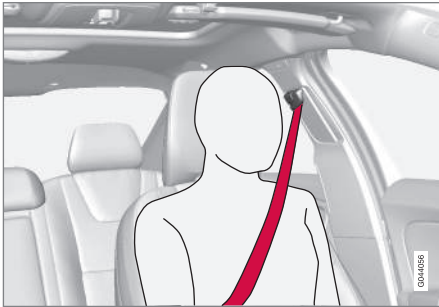

Correctly fitted seatbelt.

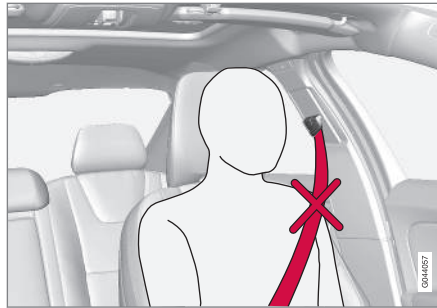

Incorrectly fitted seatbelt. The belt must rest on the shoulder.

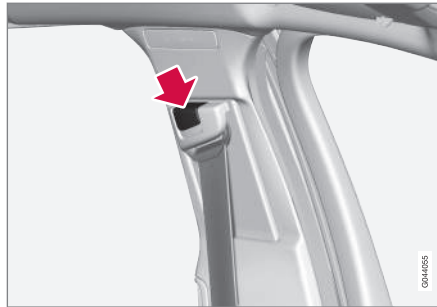

Seatbelt height adjustment. Press the button and move the belt vertically. Position the belt as high as possible without it chafing against your throat.

The locking tab at the centre rear seat only fits into the intended seatbelt buckle.

Remember

The seatbelt locks and cannot be withdrawn:

- if it is pulled out too quickly
- during braking and acceleration
- if the car leans heavily.

Related information

- Seatbelt - pregnancy (p. 27)
- Seatbelt - loosening (p. 27)
- Seatbelt tensioner (p. 28)
- Seatbelt reminder (p. 28)



Seatbelt - loosening

Loosen the seatbelt (p. 25) when the car is stationary.

Press the red button on the seatbelt buckle and then let the belt retract. If the seatbelt does not retract fully, feed it in by hand so that it does not hang loose.

Related information

- Seatbelt - putting on (p. 26)
- Seatbelt reminder (p. 28)

Seatbelt - pregnancy

Seatbelt (p. 25) must always be worn during pregnancy. But it is crucial that it be worn in the correct way.



The diagonal section should wrap over the shoulder then be routed between the breasts and to the side of the abdomen.

The lap section should lay flat over the thighs and as low as possible under the abdomen. – It must never be allowed to ride upward. Remove the slack from the seatbelt and ensure that it fits as close to the body as possible. In addition, check that there are no twists in the seatbelt.

As the pregnancy progresses, pregnant drivers must adjust the seat (p. 77) and steering wheel (p. 82) such that they can easily maintain control of the vehicle as they drive (which means that they must be able to easily operate the foot pedals and steering wheel).

The aim should be to position the seat with as large a distance as possible between abdomen and steering wheel.

Related information

- Seatbelt - putting on (p. 26)
- Seatbelt - loosening (p. 27)



Seatbelt reminder

Unbelted occupants will be reminded to fasten their (p. 26) seatbelt by means of an audio and visual reminder.



The audio reminder is speed dependent, and in some cases time dependent. The visual reminder is located in the roof console and in the combined instrument panel (p. 61).

Child seats are not covered by the seatbelt reminder system.

Rear seat

The seatbelt reminder in the rear seat has two subfunctions:

- Provides information on which seatbelts (p. 25) are being used in the rear seat. A message appears in the combined instrument panel when the seatbelts are in use, or if one of the rear doors has been opened. The message is acknowledged

automatically after approximately 30 seconds driving or after pressing the indicator stalk **OK** button (p. 105). If anyone is unbelted then the message can only be acknowledged manually by pressing the indicator stalk **OK** button.

- Provides a warning if one of the rear seatbelts is unfastened during travel. This warning takes the form of a message in the combined instrument panel along with the audio/visual signal. The warning stops when the seatbelt is re-fastened, or it can also be acknowledged manually by pressing the **OK** button.

The combined instrument panel's information display shows which seatbelts are in use. This information is always available.

Seatbelt tensioner

Seatbelts (p. 25) on the driver's side, the passenger side and at the outer rear seats are fitted with seatbelt tensioners. A mechanism in the seatbelt tensioner tightens the seatbelt in the event of a sufficiently violent collision. The seatbelt then provides more effective restraint for the occupants.



WARNING

Never insert the tongue of the passenger's seatbelt into the buckle on the driver's side. Always insert the tongue of the seatbelt into the buckle on the correct side. Do not make any damages on seatbelts nor insert any foreign objects into a buckle. The seatbelts and buckles would then possibly not function as intended in the event of a collision. There is a risk of serious injury.

Related information

- General information on seatbelts (p. 25)



Safety - warning symbol

The warning symbol is shown if a fault is detected during fault tracing or if a system has been activated. Where required, the warning symbol is shown together with a message in the combined instrument panel (p. 61) information display.

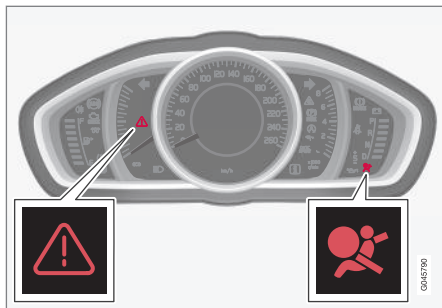

Warning triangle and warning symbol for the airbag system (p. 30) in the analogue combined instrument panel.

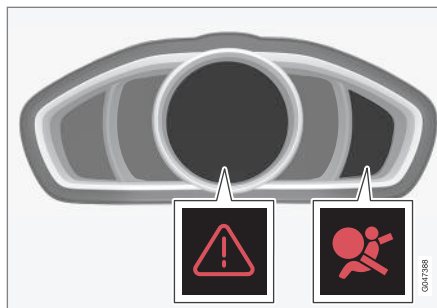

Warning triangle and warning symbol for the airbag system in the digital combined instrument panel.

The warning symbol in the combined instrument panel is switched on with the remote control key in key position II (p. 76), fault tracing is performed each time the ignition is switched on. The symbol clears after approx. 6 seconds provided the airbag system is fault-free.

The warning symbol is shown if a fault is detected during fault tracing or if a system has been activated. Where required, the warning symbol is shown together with a message in the display. If the warning symbol malfunctions, the warning triangle illuminates and **SRS airbag Service required** or **SRS airbag Service urgent** appears in the display. Volvo recommends that you contact an authorised Volvo workshop immediately.

WARNING

If the warning symbol for the airbag system remains illuminated or illuminates while driving, it means that the airbag system does not have full functionality. The symbol indicates a fault in the airbag system, the belt tensioner system, SIPS, the IC system or some other fault in the system. Volvo recommends that you contact an authorised Volvo workshop immediately.

Related information

- General information on safety mode (p. 40)



Airbag system

In the event of a frontal collision the airbag system helps to protect the head, face and chest of the driver and passenger.

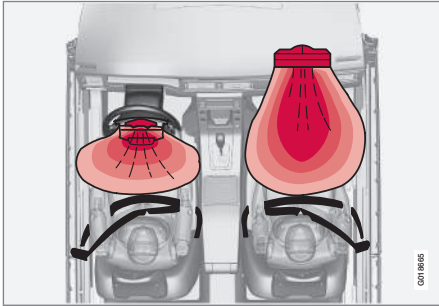

Airbag system viewed from above, left-hand-drive car.

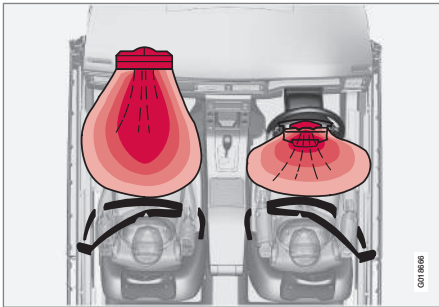

Airbag system viewed from above, right-hand-drive car.

The system consists of airbags and sensors. A sufficiently violent collision trips the sensors and the airbag(s) are inflated and become hot. The airbag cushions the initial collision impact for the occupant. The airbag deflates when compressed by the collision. When this occurs, smoke escapes into the car. This is completely normal. The entire process, including inflation and deflation of the airbag, occurs within tenths of a second.

WARNING

Volvo recommends that you contact an authorised Volvo workshop for repair. Defective work in the airbag system could cause malfunction and result in serious personal injury.

NOTE

The detectors react differently depending on the nature of the collision and whether or not the seatbelt is fastened. Applies to all seatbelt positions apart from centre seat rear.

It is therefore possible that only one (or none) of the airbags may inflate in a collision. The detectors sense the force of the collision on the vehicle and the action is adapted accordingly so that one or more airbags are deployed.

Related information

- Airbags on driver's side (p. 31)
- Passenger airbag (p. 31)
- Safety - warning symbol (p. 29)



Airbags on driver's side

To supplement the protection afforded by the seatbelt (p. 25) on the driver side, the car is equipped with two airbags (p. 30).

One of the airbags is folded up into the centre of the steering wheel. The steering wheel is marked **AIRBAG**.

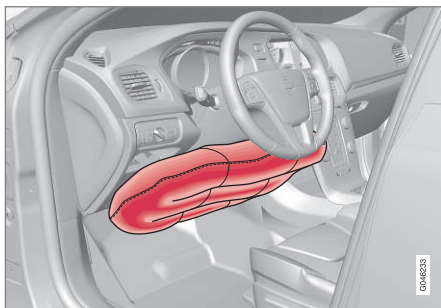

Knee airbag on the driver's side in a left-hand-drive car.

The second airbag (at knee level) is fitted in the lower part of the instrument panel on the driver's side; this panel is labelled **AIRBAG**.

WARNING

The seatbelts and airbags interact. If the belt is not used or is used incorrectly, this may diminish the protection provided by the airbags in the event of a collision.

Related information

- Passenger airbag (p. 31)

Passenger airbag

To supplement the protection afforded by the seatbelt (p. 25) on the passenger side, the car is equipped with an airbag (p. 30).

The airbag is folded up into a compartment above the glovebox. Its cover panel is marked **AIRBAG**.



Location of the front passenger airbag in a left-hand drive car.



Location of the front passenger airbag in a right-hand drive car.

The warning label for the passenger airbag is fitted in one of the following two locations in the car:



Alternative 1: Position of airbag label on passenger side sun visor.

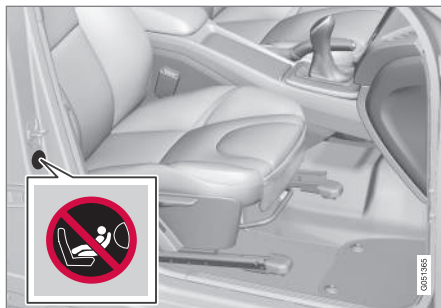

Alternative 2: Position of airbag label on passenger side door pillar. The label becomes visible when the passenger door is opened.

⚠ WARNING

Do not put objects in front of or above the dashboard where the passenger airbag is located.

⚠ WARNING

Never place a child in a child seat or on a booster cushion in the front seat if the airbag is activated.

Never allow anybody to stand or sit in front of the front passenger seat.

No one shorter than 140 cm should ever sit in the front passenger seat if the airbag is activated.

Failure to follow the advice given above can endanger life.

⚠ WARNING

Never use a rear-facing child seat on a seat protected by an activated airbag. Failure to follow this advice can lead to death or serious injury to the child.

Switch - PACOS*

The front passenger airbag can be deactivated (p. 33) if the car is equipped with a switch, PACOS (Passenger Airbag Cut Off Switch).

⚠ WARNING

The seatbelts and airbags interact. If the belt is not used or is used incorrectly, this may diminish the protection provided by the airbag in the event of a collision.

To minimise the risk of injury if the airbag deploys, passengers must sit as upright as possible with their feet on the floor and backs against the backrest. Seatbelts must be secured.

⚠ WARNING

If the car is equipped with a front passenger airbag, but does not have a PACOS switch (Passenger Airbag Cut Off Switch), then the airbag will always be activated.



Related information

- Airbags on driver's side (p. 31)
- Child seats (p. 45)

Passenger airbag - activating/deactivating*

Front passenger airbag (p. 31) can be deactivated if the car is equipped with a switch, PACOS (Passenger Airbag Cut Off Switch).

Switch - PACOS

The switch for the passenger airbag (PACOS) is located on the passenger end of the instrument panel and is accessible when the passenger door is open.

Check that the switch is in the required position. The remote control key's key blade (p. 164) should be used to change position.

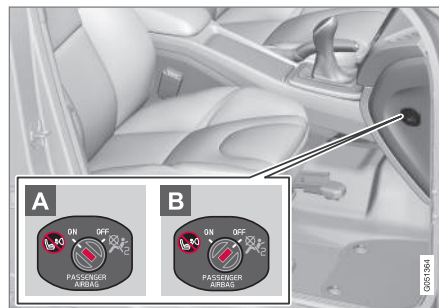

Location of airbag switch.

- A** The airbag is activated. With the switch in this position, persons taller than 140 cm can sit in the front passenger seat, but

never children in a child seat or on a booster cushion.

- B** The airbag is deactivated. With the switch in this position, children in a child seat or on a booster cushion can sit in the front passenger seat, but never persons taller than 140 cm.

WARNING

Activated airbag (passenger seat):

Never place a child in a child seat or on a booster cushion on the front passenger seat when the airbag is activated. This applies to everyone shorter than 140 cm.

Deactivated airbag (passenger seat):

No one taller than 140 cm should ever sit in the front passenger seat when the airbag is deactivated.

Failure to follow the advice given above can endanger life.

NOTE

When the remote control key is in key position II (p. 76) the warning symbol (p. 29) for the airbag is shown in the combined instrument panel for approx. 6 seconds.

Following which, the indicator in the roof console is illuminated showing the correct status for the front passenger seat airbag.



Indicator showing that the passenger airbag is activated.

A text message and a warning symbol in the roof console indicate that the airbag for the front passenger seat is activated (see preceding illustration).

WARNING

Never place a child in a child seat or on a booster cushion in the front seat if the airbag is activated and the symbol in the roof console is illuminated. Failure to follow this advice could endanger the life of the child.

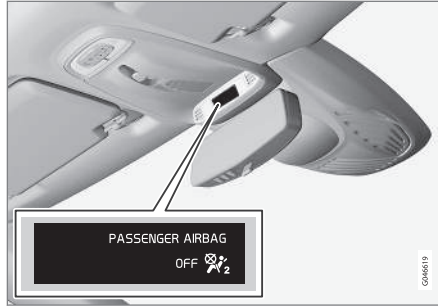

Indicator showing that the passenger airbag is deactivated.

A text message and a symbol in the roof console indicate that the airbag for the front passenger seat is deactivated (see preceding illustration).

WARNING

Do not allow anyone to sit in the front passenger seat if the message in the roof console indicates that the airbag is deactivated, and if the warning symbol (p. 29) for the airbag system is also displayed on the combined instrument panel. This indicates that there has been a severe malfunction. Visit a workshop as soon as possible. Volvo recommends that you contact an authorised Volvo workshop.

WARNING

Failure to follow the advice given above can endanger the lives of passengers in the car.

Related information

- Child seats (p. 45)



Side airbag (SIPS)

In a side impact collision a large proportion of the collision force is transferred by the SIPS (Side Impact Protection System) to beams, pillars, the floor, the roof and other structural parts of the body. The side airbags at the driver's and front passenger seats protect the chest area and the hip and are an important part of the SIPS.



The SIPS bag system consists of two main components, side airbag and sensors. The side airbags are located in the front seat's backrests.

A sufficiently violent collision trips the sensors and the side airbags are inflated. The airbag inflates between the occupant and the door panel and thereby cushions the initial impact. The airbag deflates when compressed by the collision. The side airbag is normally only deployed on the side of the collision.

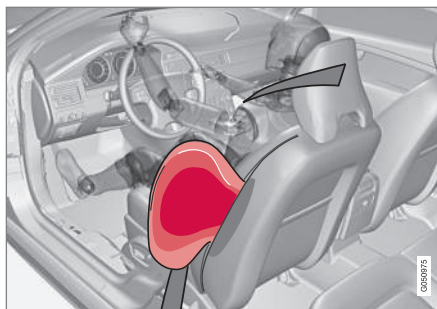

Driver's seat, left-hand drive.

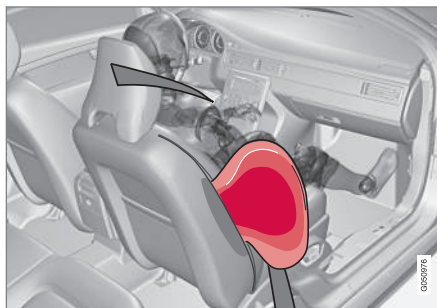

Front passenger seat, left-hand drive.

WARNING

- Volvo recommends that repairs are only carried out by an authorised Volvo workshop. Defective work in the SIPS-bag system could cause malfunction and result in serious personal injury.
- Do not put objects in the area between the outside of the seat and the door panel, since this area is required by the side airbag.
- Volvo recommends the use only of car seat covers approved by Volvo. Other seat covers may impede the operation of the side airbags.
- Side airbags are a supplement the seatbelts. Always use a seatbelt.

Related information

- Airbags on driver's side (p. 31)
- Passenger airbag (p. 31)
- Side airbag (SIPS) - child seat/booster cushion (p. 36)
- Inflatable Curtain (IC) (p. 36)



Side airbag (SIPS) - child seat/booster cushion

The protection provided by the car to children seated in a child seat or on a booster cushion is not diminished by the side airbag (p. 35).

Child seat/booster cushion (p. 45) can be placed on the front passenger seat provided that the car does not have an activated airbag (p. 33) on the front passenger side.

Related information

- Passenger airbag (p. 31)
- General information on child safety (p. 44)

Inflatable Curtain (IC)

The inflatable curtain helps to prevent the driver and passengers from striking their heads on the inside of the car during a collision.



The inflatable curtain IC (Inflatable Curtain) is a part of the SIPS system (p. 35). It is fitted in the headlining along both sides of the roof and protects the car's occupants sitting in the outer seats. A sufficiently violent collision trips the sensors and the inflatable curtain is inflated.



WARNING

Never hang or attach heavy items onto the handles in the roof. The hook is only designed for light clothing (not for solid objects such as umbrellas for example).

Do not screw or install anything onto the car's headlining, door pillars or side panels. This could compromise the intended protection. Volvo recommends that you only ever use Volvo genuine parts that are approved for placement in these areas.



WARNING

Do not load the car higher than 50 mm under the top edge of the windows in the doors. Otherwise, the intended protection of the inflatable curtain, which is concealed in the headlining, may be compromised.



WARNING

The inflatable curtain is a supplement to the seatbelts.

Always use a seatbelt.

Related information

- General information on seatbelts (p. 25)
- Airbag system (p. 30)
- Side airbag (SIPS) (p. 35)



General information on WHIPS (whiplash protection)

WHIPS (Whiplash Protection System) is a protection against whiplash injuries. The system consists of energy absorbing backrests and specially designed head restraints in the front seats.

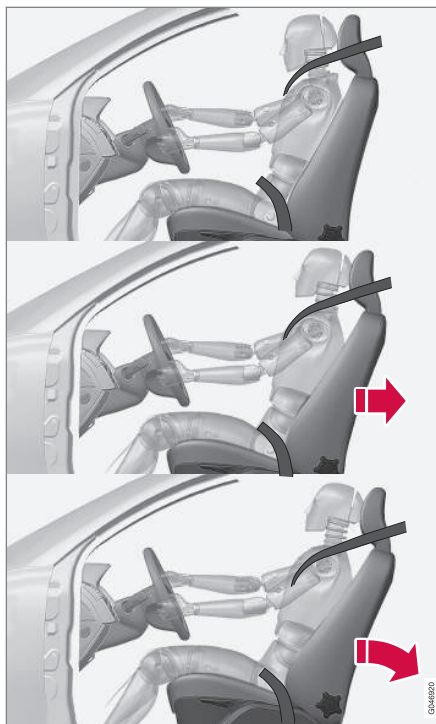

The WHIPS system is actuated by a rear-end collision, where the angle and speed of the collision, and the nature of the colliding vehicle all have an influence.

WARNING

The WHIPS system is a supplement to the seatbelts. Always use a seatbelt.

Seat properties

When the WHIPS system is deployed, the front seat backrests are lowered backward to change the seating position of the driver and front seat passenger. This reduces the risk of whiplash injury.

WARNING

Never modify or repair the seat or WHIPS system yourself. Volvo recommends that you contact an authorised Volvo workshop.

Related information

- WHIPS - child seats (p. 38)
- WHIPS - seating position (p. 38)
- General information on seatbelts (p. 25)



WHIPS - child seats

The protection provided by the car to children seated in a child seat or on a booster cushion is not diminished by the WHIPS system (p. 37).

Child seat/booster cushion (p. 45) can be placed on the front passenger seat provided that the car does not have an activated airbag (p. 33) on the front passenger side.

Related information

- General information on child safety (p. 44)

WHIPS - seating position

In order to obtain optimum protection from the WHIPS system (p. 37) the driver and passenger must have the correct seating position and make sure that the system's function is not obstructed.

Seating position

Set the correct seating position in the front seat (p. 77) before driving starts.

Driver and front seat passenger should sit in the centre of the seat with as little space as possible between the head and the head restraint.

Function



Do not leave any objects on the floor behind the driver's seat/passenger seat that may prevent the WHIPS system from functioning.



WARNING

Do not squeeze rigid objects between the rear seat cushion and the front seat's backrest. Make sure you do not obstruct the function of the WHIPS system.



Do not place objects on the rear seat that may prevent the WHIPS system from functioning.



WARNING

If a rear seat backrest is folded down, the corresponding front seat must be moved forward so that it does not touch the folded backrest.

**! WARNING**

If a seat has been subjected to extreme forces, such as due to a rear-end collision, the WHIPS system must be checked. Volvo recommends that it is checked by an authorised Volvo workshop.

Part of the WHIPS system's protective capacity may have been lost even if the seat appears to be undamaged.

Volvo recommends that you contact an authorised Volvo workshop to have the system checked even after a minor rear-end collision.

When the systems deploy

In the event of a collision Volvo's different personal safety systems work together in order to minimise injury.

System	Triggered
Seatbelt tensioner (p. 28) front seat	In the event of a frontal collision, and/or side-impact collision, and/or rear-end collision and/or overturning
Seatbelt tensioner (p. 28) rear seat ^A	In a frontal collision and/or side-impact accident and/or overturning
Airbags (Steering wheel, knee (p. 31) and passenger airbag (p. 31))	In a frontal collision ^B
Side airbags (SIPS) (p. 35)	In a side-impact accident ^B

System	Triggered
Inflatable Curtain IC (p. 36)	In the event of a side impact and/or overturning and/or some frontal collisions ^B
Whiplash protection WHIPS (p. 37)	In a rear-end collision

^A There is no seatbelt tensioner at the centre rear seat.

^B The bodywork of the car could be greatly deformed in a collision without airbag deployment. A number of factors such as the rigidity and weight of the object hit, the speed of the car, the angle of the collision etc. affects how the different safety systems of the car are activated.

If the airbags (p. 30) have deployed, the following is recommended:

- Recovering the car. Volvo recommends that you have it conveyed to an authorised Volvo workshop. Do not drive with deployed airbags.
- Volvo recommends that you engage an authorised Volvo workshop to handle the replacement of components in the car's safety systems.
- Always contact a doctor.

**NOTE**

The airbags and belt tensioner system are deployed only once during a collision.



WARNING

The airbag system's control module is located in the centre console. If the centre console is drenched with water or other liquid, disconnect the battery cables. Do not attempt to start the car since the airbags may deploy. Recovering the car. Volvo recommends that you have it conveyed to an authorised Volvo workshop.

WARNING

Never drive with deployed airbags. They can make steering difficult. Other safety systems may also be damaged. The smoke and dust created when the airbags are deployed can cause skin and eye irritation/injury after intensive exposure. In case of irritation, wash with cold water. The rapid deployment sequence and airbag fabric may cause friction and skin burns.

General information on safety mode

Safety mode is a protective state that is enforced when the collision may have damaged any of the car's vital functions, such as the fuel lines, sensors for one of the safety systems, or the brake system.

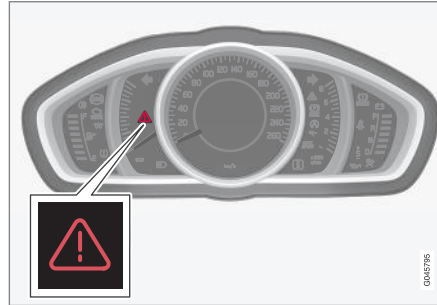

Warning triangle in the analogue combined instrument panel.

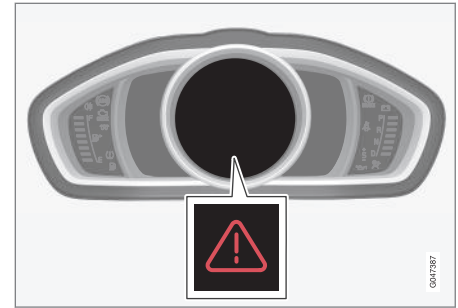

Warning triangle in the digital combined instrument panel.

If the car is involved in a collision, the text **Safety mode See manual** may appear in the combined instrument panel (p. 61) information display. This means that the car has reduced functionality.

WARNING

Never attempt to repair your car or reset the electronics yourself if the car has been in safety mode. This could result in personal injury or the car not functioning as normal. Volvo recommends that you engage an authorised Volvo workshop to check and restore the car to normal status after **Safety mode See manual** has been displayed.



Related information

- Safety mode - attempting to start the car (p. 41)
- Safety mode - moving the car (p. 42)

Safety mode - attempting to start the car

If the car is set in safety mode (p. 40) then an attempt to start the car can be made if everything seems normal and the absence of fuel leakage has been checked.

First, check that no fuel is leaking from the car. There must be no smell of fuel either.

If everything seems normal and you have checked for indications of fuel leakage, you may attempt to start the car.

Remove the remote control key and open the driver's door. If a message is now shown to the effect that the ignition is on, press the start button. Then close the door and reinsert the remote control key. The car's electronics will now try to reset themselves to normal mode. Then try to start the car.

If the message **Safety mode See manual** is still shown on the display, then the car must not be driven or towed, but a vehicle recovery service (p. 311) must be used instead. Even if the car appears to be driveable, hidden damage may make the car impossible to control once moving.

WARNING

Never, under any circumstances, attempt to restart the car if it smells of fuel when the **Safety mode See manual** message is displayed. Leave the car at once.

WARNING

If the car is in safety mode it must not be towed. It must be transported from its location. Volvo recommends that it is transported to an authorised Volvo workshop.

Related information

- Safety mode - moving the car (p. 42)



Safety mode - moving the car

If **Normal mode** is shown after **Safety mode** *See manual* has been reset after attempting to start the car (p. 41), the car can be moved carefully out of a dangerous position.

Do not move the car further than necessary.

Related information

- General information on safety mode (p. 40)

Pedestrian airbag*

The airbag for pedestrians (Pedestrian Airbag) contributes in certain frontal collisions to alleviating the collision of the pedestrian with the car.



The pedestrian airbag (Pedestrian Airbag) is fitted under the bonnet near the windscreen. In the event of certain frontal collisions with a pedestrian, the sensors in the front bumper react and the airbag inflates if required, based on the force of the impact. The sensors are active at a speed of approx. 20-50 km/h and an ambient temperature between -20 and +70°C.

The sensors are designed to detect a collision with an object that has similar properties to those of the human leg.



NOTE

There may be objects in the traffic environment that prompt a signal to the sensors that is similar to a collision with a pedestrian. It is possible that the system will be activated in the event of a collision with such an object.

If the airbag is activated (Pedestrian Airbag)

- the rear part of the bonnet is raised and locked in this position
- the hazard warning flashers are activated
- the brake system is prepared for the upcoming emergency braking.



WARNING

Do not fit any accessories or change anything in the front if the car is equipped with airbag (Pedestrian Airbag). Incorrect intervention at the front may cause incorrect function in the system and lead to serious injury and damage to the car.

Volvo recommends that genuine wiper arms are used and that you only use genuine parts for them.



WARNING

Volvo recommends contacting an authorised Volvo workshop in the event of damage to the bumper in order to ensure that the system is intact.



Related information

- Pedestrian airbag* - moving the car (p. 43)
- Pedestrian airbag* - folding up (p. 43)

Pedestrian airbag* - moving the car

The car may be moved if it has not been set in safety mode (p. 40).

If any of the other airbags in the passenger compartment were activated then the car remains in safety mode.

If only the pedestrian airbag (p. 42) (Pedestrian Airbag) has been activated:

1. Move the car to a safe location as close as possible.
2. Fold up the airbag in accordance with the instructions (p. 43).
3. Seek the nearest workshop.



WARNING

Volvo recommends that, after activation of the airbag, you contact an authorised Volvo workshop as soon as possible.

Related information

- Pedestrian airbag* (p. 42)

Pedestrian airbag* - folding up

Pedestrian airbag (p. 42) (Pedestrian Airbag) must be folded up before the car is moved.

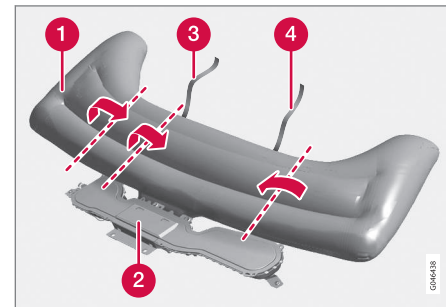

- 1 Airbag
- 2 Airbag housing
- 3 Velcro strap, right-hand side
- 4 Velcro strap, left-hand side

The airbag may feel warm and give off smoke. This is normal. Fold the airbag as follows:

1. Find the Velcro strap on the left-hand side (4).
2. Gather the airbag fabric along its length on the left-hand side. Then fold the gathered fabric towards the centre. Wind the Velcro strap (double sided) around as much fabric as possible and fasten it.



3. Press the rolled up portion of the airbag into the airbag housing (2).
4. Repeat points 1-3 for the right-hand side. It may be necessary to fold the gathered fabric twice on this side in order to wind the Velcro strap around it.
5. The airbag housing cover will be open slightly. This is completely normal.

Related information

- Pedestrian airbag* - moving the car (p. 43)

General information on child safety

Children of all ages and sizes must always sit correctly secured in the car. Never allow a child to sit on the knee of a passenger.

Volvo recommends that children travel in rear-facing child seats until as late an age as possible, at least until 3-4 years of age, and then front-facing booster cushions/child seats until up to 10 years of age.

The position of a child in the car and the choice of equipment are dictated by the child's weight and size; see Child seats (p. 45).



NOTE

Regulations regarding the placement of children in cars vary from country to country. Check what does apply.

Volvo has child safety equipment (child seats, booster cushions & attachment devices) which is designed for your particular car. Using Volvo's child safety equipment provides you with optimum conditions for your child to travel safely in the car. Furthermore, the child safety equipment fits and is easy to use.



NOTE

In the event of questions when fitting child safety products, contact the manufacturer for clearer instructions.

Child safety locks

The controls for operating the rear door power windows and the rear door opening handles can be blocked (p. 176) from opening from the inside.

Related information

- Child seats (p. 45)
- Child seats - location (p. 49)
- Child seat - ISOFIX (p. 50)
- Child seats - upper mounting points (p. 53)



Child seats

Children should sit comfortably and safely. Make sure that the child seat is being used correctly.



Child seats and airbags are not compatible.

i NOTE
When using child safety products it is important to read the installation instructions included.

! WARNING
Do not secure the straps of the child seat to the seat's horizontal adjustment bar, springs or the rails and beams under the seat. Sharp edges may damage the straps.

Look in the installation instructions for the child seat for the correct fitting.

02



Recommended child seats¹

Weight	Front seat (with deactivated airbag)	Outer rear seat	Centre rear seat
Group 0 max 10 kg Group 0+ max 13 kg		Volvo infant seat (Volvo Infant Seat) - rear-facing child seat, secured with the ISOFIX fixture system. Type approval: E1 04301146 (L)	
Group 0 max 10 kg Group 0+ max 13 kg	Volvo infant seat (Volvo Infant Seat) - rear-facing child seat, secured with the car's seatbelt. Type approval: E1 04301146 (U)	Volvo infant seat (Volvo Infant Seat) - rear-facing child seat, secured with the car's seatbelt. Type approval: E1 04301146 (U)	Volvo infant seat (Volvo Infant Seat) - rear-facing child seat, secured with the car's seatbelt. Type approval: E1 04301146 (U)
Group 0 max 10 kg Group 0+ max 13 kg	Child seats which are universally approved. ^A (U)	Child seats which are universally approved. (U)	

¹ With regard to other child seats your car should be included in the manufacturer's enclosed list of vehicles or be universally approved in accordance with the ECE R44 legal requirement.



Weight	Front seat (with deactivated airbag)	Outer rear seat	Centre rear seat
Group 1 9-18 kg	Volvo rear-facing/turnable child seat (Volvo Convertible Child Seat) - rear-facing child seat, secured with the car's seatbelt and straps. Type approval: E5 04192 (L)	Volvo rear-facing/turnable child seat (Volvo Convertible Child Seat) - rear-facing child seat, secured with the car's seatbelt and straps. Type approval: E5 04192 (L)	
Group 1 9-18 kg	Child seats which are universally approved. ^A (U)	Child seats which are universally approved. (U)	
Group 2 15-25 kg	Volvo rear-facing/turnable child seat (Volvo Convertible Child Seat) - rear-facing child seat, secured with the car's seatbelt and straps. Type approval: E5 04192 (L)	Volvo rear-facing/turnable child seat (Volvo Convertible Child Seat) - rear-facing child seat, secured with the car's seatbelt and straps. Type approval: E5 04192 (L)	
Group 2 15-25 kg	Volvo rear-facing/turnable child seat (Volvo Convertible Child Seat) - front-facing child seat, secured with the car's seatbelt. Type approval: E5 04191 (U)	Volvo rear-facing/turnable child seat (Volvo Convertible Child Seat) - front-facing child seat, secured with the car's seatbelt. Type approval: E5 04191 (U)	
Group 2/3 15-36 kg	Volvo booster seat with backrest (Volvo Booster Seat with backrest). Type approval: E1 04301169 (UF)	Volvo booster seat with backrest (Volvo Booster Seat with backrest). Type approval: E1 04301169 (UF)	



Weight	Front seat (with deactivated airbag)	Outer rear seat	Centre rear seat
Group 2/3 15-36 kg	Booster cushion with and without backrest (Booster Cushion with and without backrest). Type approval: E5 04216 (UF)	Booster cushion with and without backrest (Booster Cushion with and without backrest). Type approval: E5 04216 (UF)	

L: Suitable for specific child seats. These child seats may be intended for use in a special car model, limited or semi-universal categories.

U: Suitable for universally approved child seats in this weight class.

UF: Suitable for front-facing universally approved child seats in this weight class.

B: Built-in child seats approved for this weight class.

^A Only for rear-facing child seat. Set the seat's backrest in upright position.

Related information

- Child seats - location (p. 49)
- Child seats - upper mounting points (p. 53)
- Child seat - ISOFIX (p. 50)
- General information on child safety (p. 44)



Child seats - location

Always fit child seats/booster cushions (p. 45) in the rear seat if the passenger airbag is activated (p. 33). If a child is sitting on the front passenger seat then he/she could suffer serious injury if the airbag deploys.

The warning label for the passenger airbag is fitted in one of the following two locations in the car:



Alternative 1: Position of airbag label on passenger side sun visor.

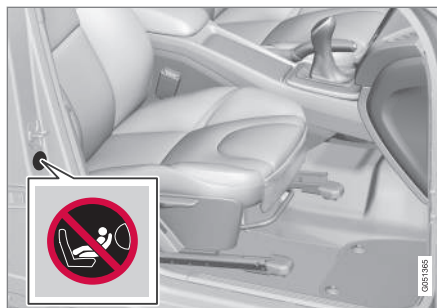

Alternative 2: Position of airbag label on passenger side door pillar. The label becomes visible when the passenger door is opened.

You may place:

- a child seat/booster cushion on the front passenger seat provided there is no activated airbag on the front passenger side.
- one or more child seats/booster cushions in the rear seat.

WARNING

Never use a rear-facing child seat on a seat protected by an activated airbag. Failure to follow this advice can lead to death or serious injury to the child.

WARNING

Never place a child in a child seat or on a booster cushion in the front seat if the airbag is activated.

Never allow anybody to stand or sit in front of the front passenger seat.

No one shorter than 140 cm should ever sit in the front passenger seat if the airbag is activated.

Failure to follow the advice given above can endanger life.

WARNING

Booster cushions/child seats with steel braces or some other design that could rest on the seatbelt buckle's opening button must not be used, as they could cause the seatbelt buckle to open accidentally.

Do not allow the upper section of the child seat to rest against the windscreen.

Related information

- General information on child safety (p. 44)
- Child seats - upper mounting points (p. 53)
- Child seat - ISOFIX (p. 50)



Child seat - ISOFIX

ISOFIX is a fixture system for car child seats (p. 45) that is based on an international standard.

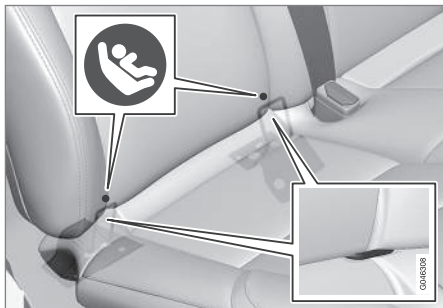

Mounting points for the ISOFIX fixture system are located at the lower section of the rear seat backrest, in the outer seats.

The location of the mounting points is indicated by symbols in the backrest upholstery (see preceding illustration).

Always follow the manufacturer's installation instructions when connecting a child seat to the ISOFIX mounting points.

Related information

- ISOFIX - size classes (p. 50)
- ISOFIX - types of child seat (p. 51)
- General information on child safety (p. 44)

ISOFIX - size classes

There is a size classification for child seats using the ISOFIX (p. 50) fixture system in order to assist users in choosing the correct type of child seat (p. 51).

Size class	Description
A	Full size, front-facing child seat
B	Reduced size (alt. 1), front-facing child seat
B1	Reduced size (alt.2), front-facing child seat
C	Full size, rear-facing child seat
D	Reduced size, rear-facing child seat
E	Rear-facing infant seat
F	Transverse infant seat, left-hand
G	Transverse infant seat, right-hand

WARNING

Never place the child in the passenger seat if the car is fitted with an activated air-bag.

NOTE

If an ISOFIX child seat has no size classification, the car model must be included on the vehicle list for the child seat.

NOTE

Volvo recommends that you contact an authorised Volvo dealer for recommendations about which ISOFIX child seats Volvo recommends.

Related information

- ISOFIX - types of child seat (p. 51)



ISOFIX - types of child seat

Child seats are in different sizes – cars are in different sizes. This means that not all child

seats are suitable for all seats in all car models.

Type of child seat	Weight	Size class	Passenger seats for ISOFIX ^A installation of child seats	
			Front seat	Outer rear seat
Infant seat transverse	max 10 kg	F	X	X
		G	X	X
Infant seat, rear-facing	max 10 kg	E	X	OK (IL)
Infant seat, rear-facing	max 13 kg	E	X	OK (IL)
		D	X	OK (IL)
		C	X	OK (IL)
Child seat, rear-facing	9-18 kg	D	X	OK (IL)
		C	X	OK (IL)



Type of child seat	Weight	Size class	Passenger seats for ISOFIX ^A installation of child seats	
			Front seat	Outer rear seat
Front-facing child seat	9-18 kg	B	X	OK ^B (IUF)
		B1	X	OK ^B (IUF)
		A	X	OK ^B (IUF)

X: The ISOFIX position is not suitable for ISOFIX child seats in this weight class and/or size class.

IL: Suitable for specific ISOFIX child seats. These child seats may be intended for use in a special car model, limited or semi-universal categories.

IUF: Suitable for front-facing ISOFIX child seats that are universally approved in this weight class.

^A ISOFIX is a fixture system for car child seats that is based on an international standard.

^B Volvo recommends rear-facing child seats for this group.

Make sure you select the right size class (p. 50) of child seat with ISOFIX fixture system.

Related information

- Child seat - ISOFIX (p. 50)



Child seats - upper mounting points

The car is equipped with upper mounting points for certain front-facing child seats (p. 45). These mounting points are located on the rear of the seat.

Upper mounting points

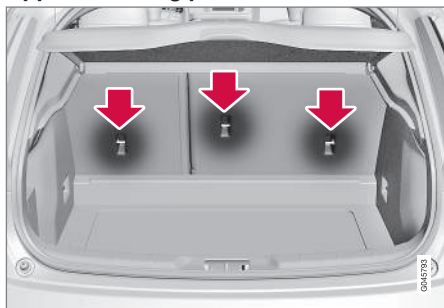

The upper mounting points are primarily intended for use with front-facing child seats. Volvo recommends that small children should sit in rear-facing child seats to as late an age as possible.

NOTE

Fold the head restraints in order to facilitate fitting this type of child seat in cars with folding head restraints on the outer seats.

NOTE

In cars with a cargo cover over the luggage compartment, this must be removed before child seats can be attached to the securing points.

For detailed information on how the child seat should be tensioned in the upper mounting points, see the seat manufacturer's instructions.

WARNING

The child seat's straps must always be drawn through the hole in the head restraint leg before they are tensioned at the attachment point.

Related information

- General information on child safety (p. 44)
- Child seats - location (p. 49)
- Child seat - ISOFIX (p. 50)

03



INSTRUMENTS AND CONTROLS

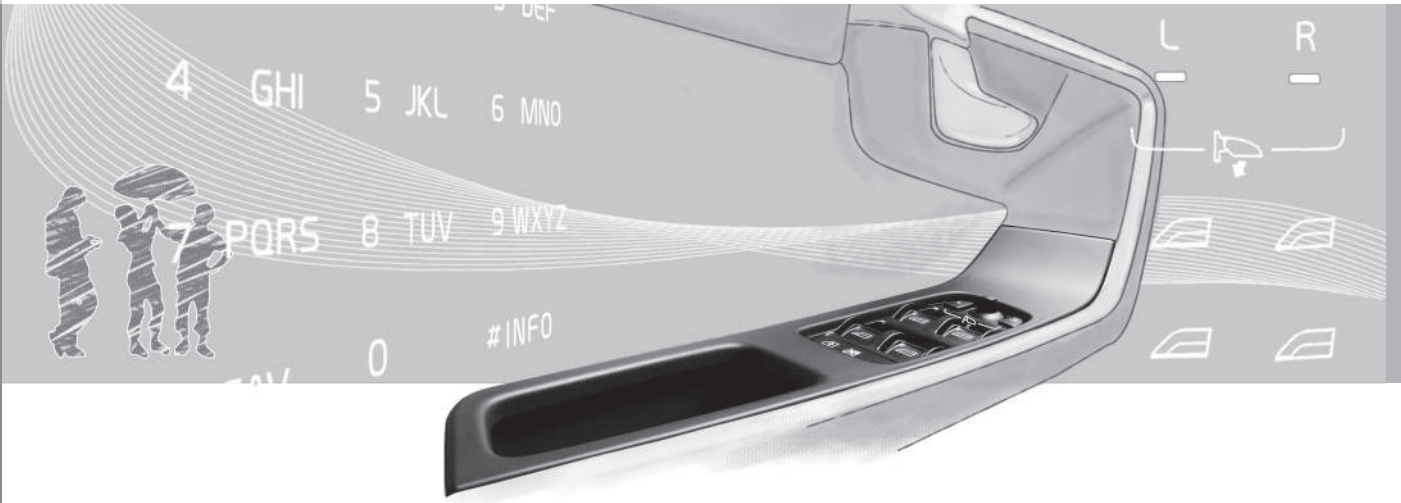



Instruments and controls, left-hand drive car - overview

The overview shows where the car's displays and controls are located.



03 Instruments and controls



Overview, left-hand drive cars

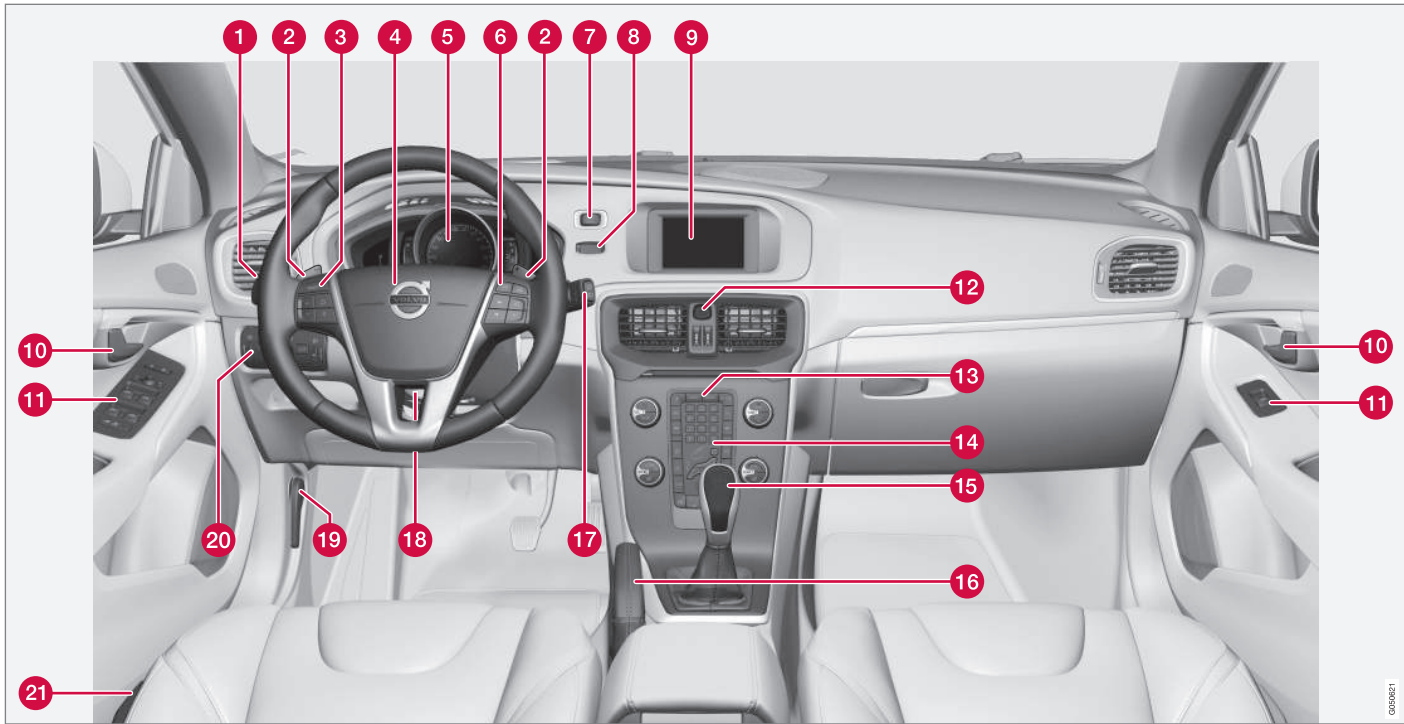

0306021



	Function	See
1	Menus and messages, direction indicators, main/dipped beam, trip computer	(p. 105), (p. 107), (p. 91), (p. 86) and (p. 118).
2	Manual gear changing in an automatic gearbox*	(p. 269).
3	Cruise control*	(p. 193) and (p. 198).
4	Horn, airbags	(p. 82) and (p. 30).
5	Combined instrument panel	(p. 61).
6	Menu navigation, audio control, phone control*	(p. 108) and the Sensus Infotainment supplement.
7	START/STOP ENGINE button	(p. 265).
8	Ignition switch	(p. 75).
9	Screen for infotainment and display of menus	(p. 108) and the Sensus Infotainment supplement.

	Function	See
10	Door handle	–
11	Control panel	(p. 172), (p. 177), (p. 99) and (p. 101).
12	Hazard warning flashers	(p. 90).
13	Control panel for infotainment system and menu navigation	(p. 108) and the Sensus Infotainment supplement.
14	Control panel for climate control	(p. 127) or (p. 128).
15	Gear selector	(p. 268), (p. 269) or (p. 273).
16	Parking brake	(p. 291).
17	Wipers and washing	(p. 97).
18	Steering wheel adjustment	(p. 82).
19	Bonnet opener	(p. 352).

	Function	See
20	Light switch, opener for tailgate	(p. 83) and (p. 173).
21	Seat adjustment*	(p. 79).

Related information

- Outside temperature gauge (p. 70)
- Trip meter (p. 70)
- Clock (p. 70)



03 Instruments and controls

Instruments and controls, right-hand drive car - overview

The overview shows where the car's displays and controls are located.

03



Overview, right-hand drive cars

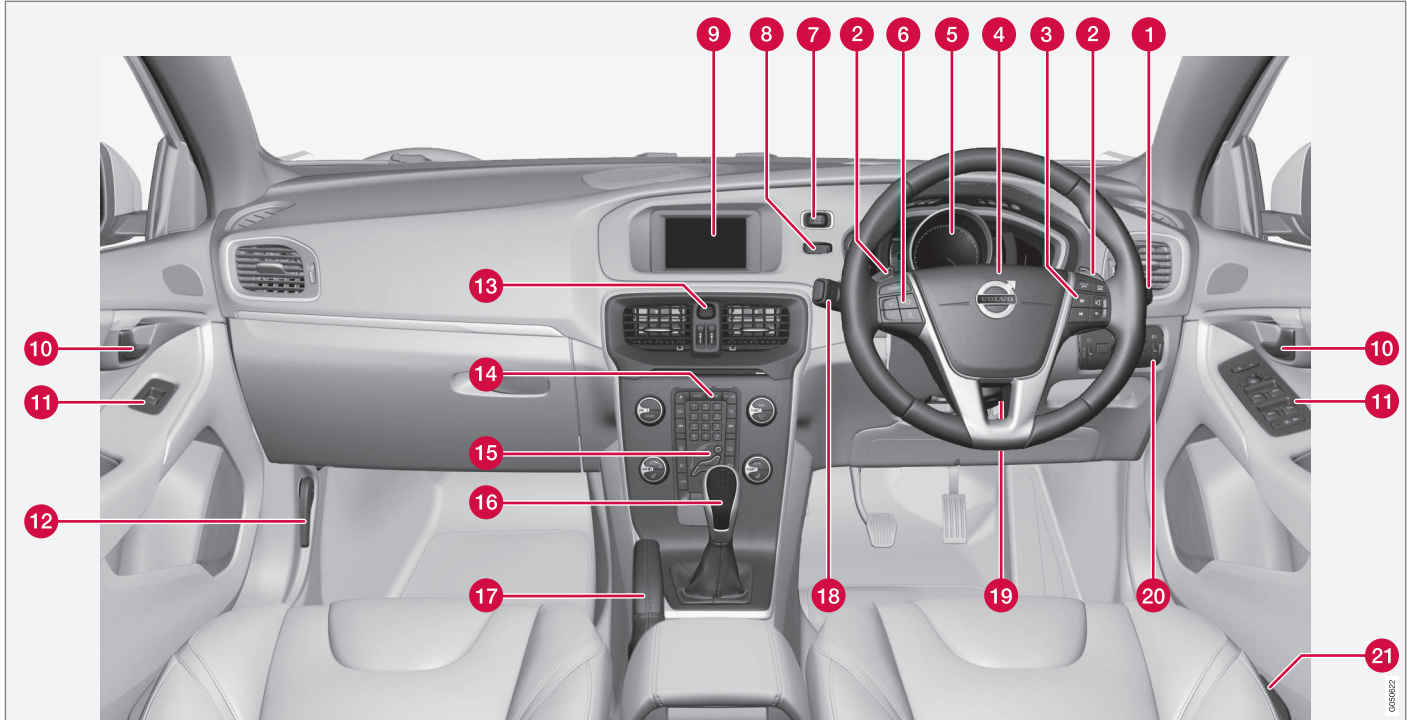



03 Instruments and controls



	Function	See
1	Wipers and washing	(p. 97).
2	Manual gear changing in an automatic gearbox*	(p. 269).
3	Menu navigation, audio control, phone control*	(p. 108) and the Sensus Infotainment supplement.
4	Horn, airbags	(p. 82) and (p. 30).
5	Combined instrument panel	(p. 61).
6	Cruise control*	(p. 193) and (p. 198).
7	START/STOP ENGINE button	(p. 265).
8	Ignition switch	(p. 75).
9	Screen for infotainment and display of menus	(p. 108) and the Sensus Infotainment supplement.
10	Door handle	–

	Function	See
11	Control panel	(p. 172), (p. 177), (p. 99) and (p. 101).
12	Bonnet opener	(p. 352).
13	Hazard warning flashers	(p. 90).
14	Control panel for infotainment system and menu navigation	(p. 108) and the Sensus Infotainment supplement.
15	Control panel for climate control	(p. 127) or (p. 128).
16	Gear selector	(p. 268), (p. 269) or (p. 273).
17	Parking brake	(p. 291).
18	Menus and messages, direction indicators, main/dipped beam, trip computer	(p. 105), (p. 107), (p. 91), (p. 86) and (p. 118).
19	Steering wheel adjustment	(p. 82).

	Function	See
20	Light switch, opener for tailgate	(p. 83) and (p. 173).
21	Seat adjustment*	(p. 79).

Related information

- Outside temperature gauge (p. 70)
- Trip meter (p. 70)
- Clock (p. 70)

03



Combined instrument panel

The combined instrument panel's information display shows information on some of the car's functions, as well as messages.

- Analogue combined instrument panel - overview (p. 61)
- Digital combined instrument panel - overview (p. 62)
- Combined instrument panel - meaning of indicator symbols (p. 66)
- Combined instrument cluster - meaning of warning symbols (p. 68)

Analogue combined instrument panel - overview

The combined instrument panel's information display shows information on some of the car's functions, as well as messages.

Information display

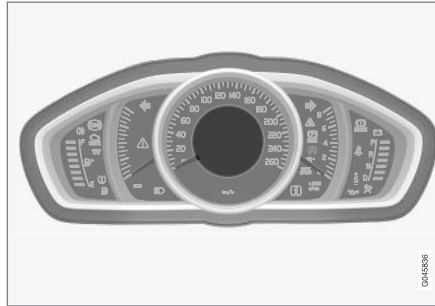

Information display, analogue instrument panel.

There are further descriptions under the functions that use the display.

Gauges and indicators

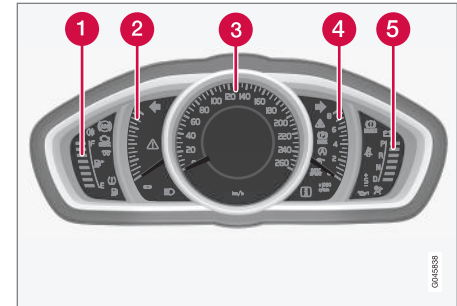

- 1 Fuel gauge. When the indicator lowers to only one white marking¹, the yellow indicator symbol for low level in the fuel tank is illuminated. See also Trip computer - supplementary information (p. 118) and Filling up with fuel (p. 296).
- 2 Eco meter The meter provides an indication of how economically the car is being driven. The higher the reading on the scale, the more economical it is.
- 3 Speedometer
- 4 Tachometer. The meter indicates engine speed in thousands of revolutions per minute (rpm).
- 5 Gear shift indicator² / Gear position indicator³. See also Gear shift indicator*

¹ When the display's message Distance to empty fuel tank: starts to show ----, the marking becomes red.

² Manual gearbox.

³ Automatic gearbox.



(p. 269), Automatic gearbox - Geartronic* (p. 269) or Automatic gearbox - Powershift* (p. 273).

Indicator and warning symbols

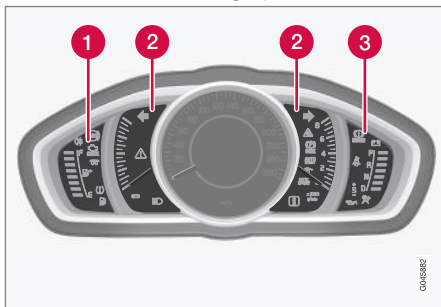

Indicator and warning symbols, analogue instrument panel.

- 1 Indicator symbols
- 2 Indicator and warning symbols
- 3 Warning symbols⁴

Functionality check

All indicator and warning symbols, apart from symbols in the centre of the information display, illuminate in key position II or when the engine is started. When the engine has started, all the symbols should go out except the parking brake symbol, which only goes out when the brake is disengaged.

If the engine does not start or if the functionality check is carried out in key position II then all symbols go out within a few seconds except the symbol for faults in the car's emissions system and the symbol for low oil pressure.

Related information

- Combined instrument panel (p. 61)
- Combined instrument panel - meaning of indicator symbols (p. 66)
- Combined instrument cluster - meaning of warning symbols (p. 68)
- Digital combined instrument panel - overview (p. 62)

Digital combined instrument panel - overview

The combined instrument panel's information display shows information on some of the car's functions, as well as messages.

Information display

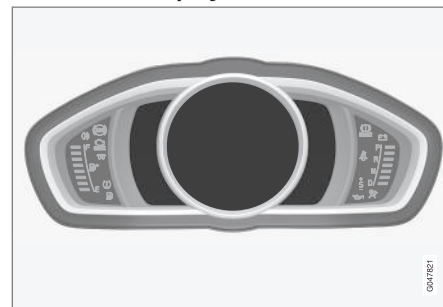

Information display, digital instrument panel*.

There are further descriptions under the functions that use the display.

Gauges and indicators

Various themes can be selected for the digital combined instrument panel. Possible themes are "Elegance", "Eco" and "Performance".

A theme can only be selected when the engine is running.

⁴ Certain engine variants do not have systems to warn of oil pressure loss. In cars with these variants the symbol for low oil pressure is not used. Warning for low oil level is via display text. For more information, see Engine oil - general (p. 354).



To select the theme, press the left-hand stalk switch's **OK** button and select the **Themes** menu option by turning the thumbwheel on the lever. Press the **OK** button. Turn the thumbwheel to select the theme and confirm the selection by pressing the **OK** button.

On certain model variants, the appearance of the centre console's screen follows the theme selected for the combined instrument panel.

The contrast mode and colour mode for the instrument can also be set using the left-hand stalk switch.

For more information on menu navigation, see Menu navigation - combined instrument panel (p. 105).

The choice of theme and setting of contrast mode and colour mode can be stored for each remote control key in the car key memory*, see Remote control key - personalisation* (p. 157).

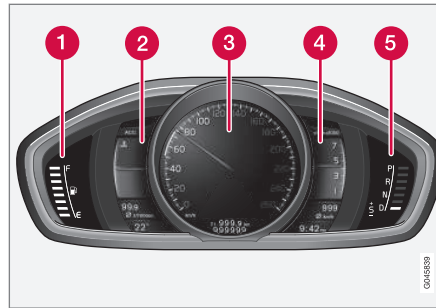

Gauges and indicators, theme "Elegance".

- 1 Fuel gauge. When the indicator lowers to only one white marking⁵, the yellow indicator symbol for low level in the fuel tank is illuminated. See also Trip computer - supplementary information (p. 118) and Filling up with fuel (p. 296).
- 2 Temperature gauge for engine coolant
- 3 Speedometer
- 4 Tachometer. The meter indicates engine speed in thousands of revolutions per minute (rpm).
- 5 Gear shift indicator⁶ / Gear position indicator⁷. See also Gear shift indicator* (p. 269), Automatic gearbox - Geartronic*

(p. 269) or Automatic gearbox - Powershift* (p. 273).

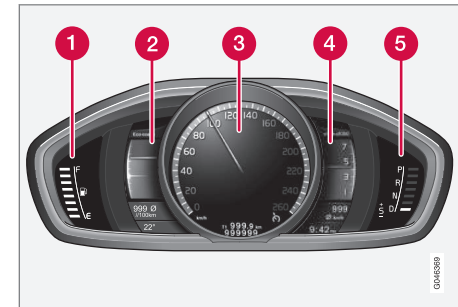

Gauges and indicators, theme "Eco".

- 1 Fuel gauge. When the indicator lowers to only one white marking⁵, the yellow indicator symbol for low level in the fuel tank is illuminated. See also Trip computer - supplementary information (p. 118) and Filling up with fuel (p. 296).
- 2 Eco guide. See also Eco guide & Power guide* (p. 65).
- 3 Speedometer
- 4 Tachometer. The meter indicates engine speed in thousands of revolutions per minute (rpm).
- 5 Gear shift indicator⁶ / Gear position indicator⁷. See also Gear shift indicator*

⁵ When the display's message Distance to empty fuel tank: starts to show ----, the marking becomes red.

⁶ Manual gearbox.

⁷ Automatic gearbox.



03 Instruments and controls



(p. 269), Automatic gearbox - Geartronic* (p. 269) or Automatic gearbox - Powershift* (p. 273).

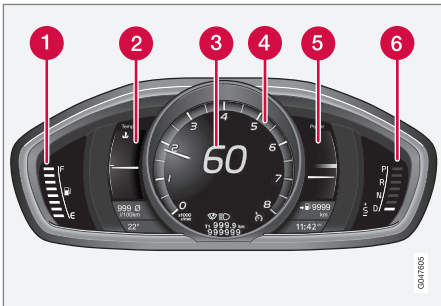

Gauges and indicators, theme "Performance".

- 1 Fuel gauge. When the indicator lowers to only one white marking⁵, the yellow indicator symbol for low level in the fuel tank is illuminated. See also Trip computer - supplementary information (p. 118) and Filling up with fuel (p. 296).
- 2 Temperature gauge for engine coolant
- 3 Speedometer
- 4 Tachometer. The meter indicates engine speed in thousands of revolutions per minute (rpm).

- 5 Power guide. See also Eco guide & Power guide* (p. 65).
- 6 Gear shift indicator⁶ / Gear position indicator⁷. See also Gear shift indicator* (p. 269), Automatic gearbox - Geartronic* (p. 269) or Automatic gearbox - Powershift* (p. 273).

Indicator and warning symbols

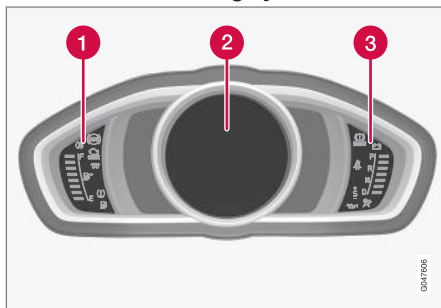

Indicator and warning symbols, digital instrument panel.

- 1 Indicator symbols
- 2 Indicator and warning symbols
- 3 Warning symbols⁸

Functionality check

All indicator and warning symbols, apart from symbols in the centre of the information display, illuminate in key position II or when the engine is started. When the engine has started, all the symbols should go out except the parking brake symbol, which only goes out when the brake is disengaged.

If the engine does not start or if the functionality check is carried out in key position II then all symbols go out within a few seconds except the symbol for faults in the car's emissions system and the symbol for low oil pressure.

Related information

- Combined instrument panel (p. 61)
- Combined instrument panel - meaning of indicator symbols (p. 66)
- Combined instrument cluster - meaning of warning symbols (p. 68)
- Analogue combined instrument panel - overview (p. 61)

⁵ When the display's message Distance to empty fuel tank: starts to show ----, the marking becomes red.

⁶ Manual gearbox.

⁷ Automatic gearbox.

⁸ Certain engine variants do not have systems to warn of oil pressure loss. In cars with these variants the symbol for low oil pressure is not used. Warning for low oil level is via display text. For more information, see Engine oil - general (p. 354).



Eco guide & Power guide*

Eco guide and Power guide are two combined instrument panel (p. 61) instruments which help the driver to drive the car with optimum driving economy.

The car also stores statistics of journeys made, which can be viewed in the form of a block diagram; see Trip computer - trip statistics (p. 119).*

Eco guide

This instrument provides an indication of how economically the car is being driven.

To view this function, select the theme "Eco"; see Digital combined instrument panel - overview (p. 62).



- 1 Instantaneous value
- 2 Average value

⁹ Power is dependent on engine speed.

Instantaneous value

The instantaneous value is shown here - the higher the reading on the scale, the better.

The instantaneous value is calculated based on speed, engine speed, engine power utilised plus use of the foot brake.

Optimum speed (50-80 km/h) and low engine speeds are encouraged. The pointers fall during acceleration and braking.

Very low instantaneous values illuminate the red zone on the meter (with a short delay), which means poor driving economy and hence should be avoided.

Average value

The average value slowly follows the instantaneous value and describes how the car has been driven most recently. The higher the pointers on the scale, the better the economy achieved by the driver.

Power guide

This instrument shows the relationship between how much power (Power) is being taken from the engine and how much power is available.

To view this function, select the theme "Performance"; see Digital combined instrument panel - overview (p. 62).

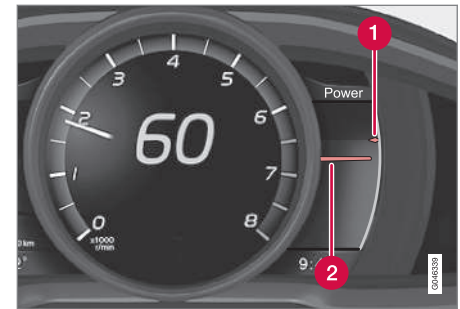

- 1 Available engine power
- 2 Engine power utilised

Available engine power

The smaller, upper pointer shows the available engine power⁹. The higher the reading on the scale, the more power is available in the current gear.

Engine power utilised

The larger, lower pointer shows the engine power utilised⁹. The higher the reading on the scale, the more power is being taken from the engine.

A large gap between the two pointers indicates a large power reserve.



Combined instrument panel - meaning of indicator symbols

The indicator symbols alert the driver that a function is activated, that the system is operating, or that an error or failure has occurred.

Indicator symbols

Symbol	Specification
	ABL fault
	Emissions system
	ABS fault
	Rear fog lamp on
	Stability system, see Electronic stability control (ESC) - general (p. 183)
	Stability system, sport mode, see Electronic stability control (ESC) - operation (p. 184)
	Engine preheater (diesel)
	Low level in fuel tank
	Information, read display text

Symbol	Specification
	Main beam On
	Left-hand direction indicator
	Right-hand direction indicator
	Eco- function on, see ECO* (p. 285)
	Start/Stop, the engine auto-stopped; see Start/Stop* - function and operation (p. 277)
	Tyre pressure system , see Tyre pressure monitoring* (p. 325)

ABL fault

The symbol illuminates if a fault has arisen in the ABL function (Active Bending Lights).

Emissions system

If the symbol illuminates after the engine has been started then it may be due to a fault in the car's emissions system. Drive to a workshop for checking. Volvo recommends that you seek assistance from an authorised Volvo workshop.

ABS fault

If this symbol illuminates then the system is not working. The car's regular brake system

continues to work, but without the ABS function.

1. Stop the car in a safe place and turn off the engine.
2. Restart the engine.
3. If the symbol remains illuminated, drive to a workshop to have the ABS system checked. Volvo recommends that you seek assistance from an authorised Volvo workshop.

Rear fog lamp on

This symbol illuminates when the rear fog lamp is switched on. There is only one rear fog lamp - it is located on the driver's side.

Stability system

A flashing symbol indicates that the stability system is operating. If the symbol illuminates with constant glow then there is a fault in the system.

Stability system, sport mode

Sport mode allows for a more active driving experience. The system then detects whether the accelerator pedal, steering wheel movements and cornering are more active than in normal driving and then allows controlled skidding of the rear section up to a certain level before it intervenes and stabilises the car. The symbol illuminates when the sport mode is activated.



Engine preheater (diesel)

This symbol illuminates during engine preheating. Preheating mostly takes place due to low temperature.

Low level in fuel tank

When the symbol illuminates the level in the fuel tank is low, refuel as soon as possible.

Information, read display text

When one of the car's systems does not behave as intended, this information symbol illuminates and a text appears on the information display. The message text is cleared with the **OK** button, see Menu navigation - combined instrument panel (p. 105), or it disappears automatically after a time (time depending on which function is indicated). The information symbol can also illuminate in conjunction with other symbols.

NOTE

When a service message is shown, the symbol and message are cleared using the **OK** button, or disappear automatically after a time.

Main beam On

The symbol illuminates when main beam is on and with main beam flash.

Left/right-hand direction indicator

Both direction indicator symbols flash when the hazard warning flashers are used.

Eco function on

This symbol illuminates when the Eco function is activated.

Start/Stop

The symbol shines when the engine is auto-stopped.

Tyre pressure system

The symbol illuminates in the event of low tyre pressure, or if a fault arises in the tyre pressure system.

Reminder – doors not closed

If one of the doors is not closed properly then the information or warning symbol illuminates together with an explanatory image in the information display. Stop the car in a safe place as soon as possible and close the door that is open.

 If the car is driven at a speed lower than approx. 7 km/h then the information symbol illuminates.

 If the car is driven at a speed higher than approx. 7 km/h then the warning symbol illuminates.

If the bonnet¹⁰ is not closed properly then the warning symbol illuminates together with an explanatory image in the information display. Stop the car in a safe place as soon as possible and close the bonnet.

If the tailgate is not closed properly then the information symbol illuminates together with an explanatory image in the information display. Stop the car in a safe place as soon as possible and close the tailgate.

Related information

- Combined instrument panel (p. 61)
- Combined instrument cluster - meaning of warning symbols (p. 68)
- Analogue combined instrument panel - overview (p. 61)
- Digital combined instrument panel - overview (p. 62)

¹⁰ Only cars with alarm*.

Combined instrument cluster - meaning of warning symbols

The warning symbols alert the driver that an important function is activated, or that a serious error or a serious failure has occurred.

Warning symbols

Symbol	Specification
	Low oil pressure ^A
	Parking brake applied, digital instrument panel
	Parking brake applied, analogue instrument panel
	Airbags – SRS
	Seatbelt reminder
	Alternator not charging
	Fault in brake system
	Warning

^A Certain engine variants do not have systems to warn of oil pressure loss. In cars with these variants the symbol for low oil pressure is not used. Warning for low oil level is via display text. For more information, see Engine oil - general (p. 354).

Low oil pressure

If this symbol illuminates during driving then the engine's oil pressure is too low. Stop the engine immediately and check the engine oil level, top up if necessary. If the symbol illuminates and the oil level is normal, contact a workshop. Volvo recommends that you seek assistance from an authorised Volvo workshop.

Parking brake applied

This symbol illuminates with a constant glow when the parking brake is applied. The symbol is illuminated during application. For more information, see Parking brake (p. 291).

Airbags – SRS

If this symbol remains illuminated or illuminates while driving, it means a fault has been detected in the seatbelt buckle, SRS, SIPS, or IC systems. Drive immediately to a workshop to have the system checked. Volvo recommends that you seek assistance from an authorised Volvo workshop.

Seatbelt reminder

This symbol flashes if someone in a front seat has not put on their seatbelt or if someone in a rear seat has taken off their seatbelt.

Alternator not charging

This symbol illuminates during driving if a fault has occurred in the electrical system. Visit a workshop. Volvo recommends that you seek assistance from an authorised Volvo workshop.

Fault in brake system

If this symbol illuminates, the brake fluid level may be too low. Stop the car in a safe place and check the level in the brake fluid reservoir; see Brake and clutch fluid - level (p. 359).

If the brake and ABS symbols illuminate at the same time, there may be a fault in the brake force distribution system.

1. Stop the car in a safe place and turn off the engine.
 - If both symbols extinguish, continue driving.
 - If the symbols remain illuminated, check the level in the brake fluid reservoir; see Brake and clutch fluid - level (p. 359). If the brake fluid level is normal but the symbols are still illuminated, the car can be driven, with great care, to a workshop to have the brake system checked. Volvo recommends that you seek assistance from an authorised Volvo workshop.
2. Restart the engine.
 - If both symbols extinguish, continue driving.
 - If the symbols remain illuminated, check the level in the brake fluid reservoir; see Brake and clutch fluid - level (p. 359). If the brake fluid level is normal but the symbols are still illuminated, the car can be driven, with great care, to a workshop to have the brake system checked. Volvo recommends that you seek assistance from an authorised Volvo workshop.



WARNING

If the brake fluid is below the **MIN** level in the brake fluid reservoir, do not drive further before topping up the brake fluid.

The loss of brake fluid must be investigated by a workshop. Volvo recommends that you contact an authorised Volvo workshop.

WARNING

If the BRAKE and ABS symbols are lit at the same time, there is a risk that the rear end will skid during heavy braking.

Warning

The red warning symbol illuminates when a fault has been indicated which could affect the safety and/or driveability of the car. An explanatory text is shown on the information display at the same time. The symbol remains visible until the fault has been rectified but the text message can be cleared with the **OK** button; see Menu navigation - combined instrument panel (p. 105). The warning symbol can also illuminate in conjunction with other symbols.

Action:

1. Stop in a safe place. Do not drive the car further.

2. Read the information on the information display. Implement the action in accordance with the message in the display. Clear the message using the **OK** button.

Reminder – doors not closed

If one of the doors is not closed properly then the information or warning symbol illuminates together with an explanatory image in the information display. Stop the car in a safe place as soon as possible and close the door that is open.

 If the car is driven at a speed lower than approx. 7 km/h then the information symbol illuminates.

 If the car is driven at a speed higher than approx. 7 km/h then the warning symbol illuminates.

If the bonnet¹¹ is not closed properly then the warning symbol illuminates together with an explanatory image in the information display. Stop the car in a safe place as soon as possible and close the bonnet.

If the tailgate is not closed properly then the information symbol illuminates together with an explanatory image in the information display. Stop the car in a safe place as soon as possible and close the tailgate.

Related information

- Combined instrument panel (p. 61)
- Combined instrument panel - meaning of indicator symbols (p. 66)
- Analogue combined instrument panel - overview (p. 61)
- Digital combined instrument panel - overview (p. 62)

¹¹ Only cars with alarm*.

Outside temperature gauge

The display for the outside temperature gauge appears in the combined instrument panel.

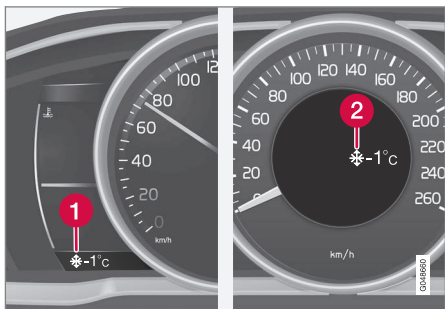

- 1 Display for outside temperature gauge, digital instrument panel
- 2 Display for outside temperature gauge, analogue instrument panel

When the temperature lies between +2 °C to -5 °C a snowflake symbol illuminates in the display. This warns of icy roads. If the car has been stationary then the gauge may show a reading that is too high.

Related information

- Combined instrument panel (p. 61)

Trip meter

The trip meter display appears in the combined instrument panel.

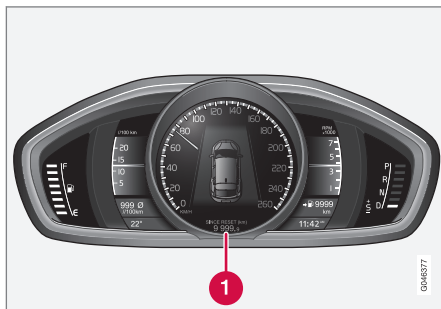

Trip meter, digital instrument.

- 1 Display for trip meter¹²

The two trip meters **T1** and **T2** are used for measuring short distances. The distance is shown in the display.

Turn the left stalk switch thumbwheel to show the required meter.

A long press (until the change occurs) on the left-hand stalk switch's **RESET** button resets the trip meter shown. For more information, see Trip computer - supplementary information (p. 118).

Related information

- Combined instrument panel (p. 61)

Clock

The clock display appears in the combined instrument panel.



Clock, digital instrument panel.

- 1 Display for showing the time¹³

Set the clock

The clock can be adjusted in the menu system **MY CAR**, see **MY CAR** (p. 108).

Related information

- Combined instrument panel (p. 61)

¹² Display appearance may differ depending on instrument variant.



Combined instrument panel - licenses

A license is an agreement for the right to operate a certain activity or the right to use someone else's entitlement according to the terms and conditions in the agreement. The following text is Volvo's agreement with the manufacturer/developer.

Combined Instrument Panel Software Open Source Software Notice

This product uses certain free / open source and other software originating from third parties, that is subject to the GNU Lesser General Public License version 2 (LGPLv2), The FreeType Project License ("FreeType License") and other different and/or additional copy right licenses, disclaimers and notices. The links to access the exact terms of LGPLv2, and the other open source software licenses, disclaimers, acknowledgements and notices are provided to you below. Please refer to the exact terms of the relevant License, regarding your rights under said licenses. Volvo Car Corporation (VCC) offers to provide the source code of said free/open source software to you for a charge covering the cost of performing such distribution, such as the cost of media, shipping and handling, upon written request. Please contact your nearest Volvo Dealer.

The offer is valid for a period of at least three (3) years from the date of the distribution of this product by VCC / or for as long as VCC offers spare parts or customer support.

Portions of this product uses software copyrighted © 2007 The FreeType Project (www.freetype.org). All rights reserved.

Portions of this product uses software with Copyright © 1994–2013 Lua.org, PUC-Rio (<http://www.lua.org/>)



This product includes software under following licenses:

LGPL v2.1: <http://www.gnu.org/licenses/old-licenses/lgpl-2.1.html>

- GNU FriBidi
- DevIL

The FreeType Project License: <http://git.savannah.gnu.org/cgit/freetype/freetype2.git/tree/docs/FTL.TXT>

- FreeType 2

MIT License: <http://opensource.org/licenses/mit-license.html>

- Lua

¹³ The time is shown in the middle of the instrument panel when an analogue instrument panel is fitted.

Symbols in the display









There are a variety of different symbols in the display in the car. The symbols are divided into warning, indicator and information symbols.

Shown below are the most common symbols with their meanings and a reference to where in the manual further information can be found.











 - Red warning symbol, illuminates when a fault has been indicated which could affect the safety and/or driveability of the car. An explanatory text is shown on the information display in the combined instrument panel at the same time.

 - When one of the car's systems does not behave as intended, this information symbol illuminates, and a text appears on the information display in the combined instrument panel. The yellow information symbol can also illuminate in conjunction with other symbols.

Warning symbols in the combined instrument panel

Symbol	Specification	See
	Low oil pressure	(p. 68)
	Parking brake applied, digital instrument panel	(p. 68), (p. 291)
	Parking brake applied, analogue instrument panel	(p. 68)
	Airbags – SRS	(p. 29), (p. 68)
	Seatbelt reminder	(p. 25), (p. 68)
	Alternator not charging	(p. 68)
	Fault in brake system	(p. 68), (p. 289)
	Warning, safety mode	(p. 29), (p. 40), (p. 68)

Control symbols in the combined instrument panel

Symbol	Specification	See
	ABL fault*	(p. 66), (p. 89)
	Emissions system	(p. 66)
	ABS fault	(p. 66), (p. 289)
	Rear fog lamp on	(p. 66), (p. 89)
	Stability system, ESC (Electronic Stability Control), Trailer stability assist*	(p. 66), (p. 185), (p. 308)
	Stability system, sport mode	(p. 66), (p. 185)
	Engine pre-heater (diesel)	(p. 66)
	Low level in fuel tank	(p. 66), (p. 139)
	Information, read display text	(p. 66)
	Main beam On	(p. 66), (p. 86)



Symbol	Specification	See
	Left-hand direction indicators	(p. 66)
	Right-hand direction indicators	(p. 66)
	Start/Stop*, engine auto-stopped	(p. 66), (p. 277)
	ECO function* on	(p. 66), (p. 285)
	Tyre pressure system*	(p. 66), Tyre pressure monitoring* (p. 325)

Information symbols in the combined instrument panel

Symbol	Specification	See
	Main beam with auto dimming - AHB*	(p. 87)
	Camera sensor*, Laser sensor*	(p. 87), (p. 222), (p. 231), (p. 234), (p. 239)

Symbol	Specification	See
	Adaptive cruise control*	(p. 211)
	Adaptive cruise control*	(p. 202), (p. 211)
	Adaptive cruise control*, Distance Warning* (Distance Alert)	(p. 211), (p. 213)
	Adaptive cruise control*	(p. 201)
	Cruise control*	(p. 193)
	Speed limiter	(p. 189)
	Radar sensor*	(p. 211), (p. 215), (p. 231)
	Start/Stop*	(p. 283)
	Start/Stop*	(p. 283)
	Start/Stop*	(p. 283)

Symbol	Specification	See
	Distance warning* (Distance Alert), City Safety™, Collision warning system*, Auto-brake*	(p. 215), (p. 222), (p. 231)
	Engine block and passenger compartment heater*	(p. 139)
	Engine block heater and passenger compartment heater* Service required	(p. 139)
	Activated timer*	(p. 139)
	Activated timer*	(p. 139)
	ABL system*	(p. 89)
	Low battery	(p. 139)

03



03 Instruments and controls



Symbol	Specification	See
	Park Assist Pilot - PAP*	(p. 248)
	Rain sensor*	(p. 97)
	Lane Keeping Aid*	(p. 237)
	Driver Alert System*, Lane Keeping Aid*	(p. 239)
	Driver Alert System*, Lane Keeping Aid*	(p. 234), (p. 239)
	Driver Alert System*, Time for a break	(p. 233)
	Driver Alert System*, Time for a break	(p. 234)
	Gear shift indicator	(p. 269)
	Gear positions	(p. 269)

Symbol	Specification	See
	Recorded speed information*	(p. 187)
	Measuring the oil level	(p. 355)

Information symbols in the roof console display

Symbol	Specification	See
	Seatbelt reminder	(p. 28)
	Airbag, passenger seat, activated	(p. 33)
	Airbag, passenger seat, deactivated	(p. 33)

Related information

- Combined instrument panel - meaning of indicator symbols (p. 66)
- Combined instrument cluster - meaning of warning symbols (p. 68)
- Messages - handling (p. 107)

Volvo Sensus

Volvo Sensus is the heart of your personal Volvo experience. It is Sensus that provides information, entertainment and functions to simplify your ownership.



When you are sitting in your car you want control, and in today's interconnected world, this includes information, communication and entertainment when it is most suitable for you. Sensus covers all our solutions that enable connection* to the outside world, at the same time providing you with intuitive control over all the car's capabilities.

Volvo Sensus combines and presents many functions in several of the car's systems on the centre console's display screen. With Volvo Sensus the car can be personalised by means of an intuitive user interface. Settings can be made in Car settings, Audio and media, Climate control, etc.

With the centre console buttons and controls or the steering wheel's right-hand keypad*



functions can be activated or deactivated and many different settings can be made.

With a press on **MY CAR** all settings related to the driving and control of the car are presented, such as City Safety, locks and alarm, automatic fan speed, setting the clock, etc.

With a press on the respective function **RADIO, MEDIA, TEL**, , **NAV*** and **CAM*** other sources, systems and functions can be activated, e.g. AM, FM, CD, DVD*, TV*, Bluetooth[®]*, navigation* and park assist camera*.

For more information about all functions/systems, see the relevant section in the owner's manual or its supplement.

Overview

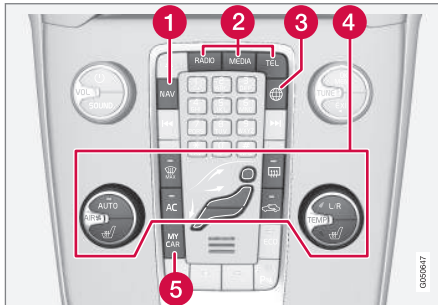

Control panel in centre console. The figure is schematic - the number of functions and layout

of the buttons both vary, depending on the equipment selected and the market.

- 1 Navigation* - **NAV**, see separate supplement (Sensus Navigation).
- 2 Audio and media - **RADIO, MEDIA, TEL***, see separate supplement (Sensus Infotainment).
- 3 Function settings - **MY CAR**, see MY CAR (p. 108).
- 4 Internet-connected car - , see separate supplement (Sensus Infotainment).
- 5 Climate control system (p. 121).

Key positions

The remote control key can be used to set the vehicle's electrical system in different modes/levels so that different functions are available; see *Key positions - functions at different levels* (p. 76).



Ignition switch with remote control key extracted/inserted.

NOTE

For cars with the Keyless* function the key does not need to be inserted into the ignition switch but can be stored in e.g. a pocket. For more information on Keyless functions, see Keyless drive* (p. 166).



03 Instruments and controls



Insert the key

1. Hold the end of the remote control key with the detachable key blade and insert the key in the ignition switch.
2. Then press the key in the lock up to its end position.

IMPORTANT

Foreign objects in the ignition switch can impair the function or destroy the lock.

Do not press in the remote control key incorrectly turned - Hold the end with the detachable key blade; see Detachable key blade - detaching/attaching (p. 164).

Withdraw the key

Push the remote control key, allow it to eject, then pull it out from the ignition switch.

Key positions - functions at different levels

To enable the use of a limited number of functions with the engine switched off, the car's electrical system can be set in 3 different levels - 0, I and II - with the remote control key. This owner's manual describes these levels throughout using the denomination "key positions".

The following table shows the functions available in each key position/level.

Level	Functions
0	<p>Odometer, clock and temperature gauge are illuminated.</p> <p>Electrically operated seats can be adjusted.</p> <p>The audio system can be used for a limited time - see the Sensus Infotainment supplement.</p>
I	<p>Sun visor for glass roof, power windows, 12 V socket in the passenger compartment, RTI, phone, ventilation fan and windscreen wipers can be used.</p>
II	<p>The headlamps come on.</p> <p>Warning/indicator lamps illuminate for 5 seconds.</p> <p>Several other systems are activated. However, electric heating in seat cushions and the rear window can only be activated after starting the engine.</p> <p>This key position consumes a lot of current from the starter battery and should therefore be avoided!</p>



Selecting key position/level

- **Key position 0** - Unlock the car - This means that the car's electrical system is at level **0**.

NOTE

To reach level **I** or **II** **without** starting the engine - do **not** depress the brake/clutch pedal when these key positions are due to be selected.

- **Key position I** - With the remote control key fully inserted into the ignition switch¹⁴ - Briefly press **START/STOP ENGINE**.
- **Key position II** - With the remote control key fully inserted into the ignition switch¹⁴ - Give a long¹⁵ press on **START/STOP ENGINE**.
- **Back to key position 0** - To return to key position **0** from position **II** and **I** - Briefly press on **START/STOP ENGINE**.

Audio system

For information on audio system functions with remote control key removed, see the Sensus Infotainment supplement.

Starting and stopping the engine

For information about starting/switching off the engine, see Starting the engine (p. 265).

¹⁴ Not required for cars with the Keyless* function.

¹⁵ Approx. 2 seconds.

¹⁶ Also applies to electrically operated seat.

Towing

For important information about the remote control key during towing, see Towing (p. 309).

Related information

- Key positions (p. 75)

Seats, front

The car's front seats have different setting options for optimum seating comfort.



- 1 To adjust lumbar support*, turn the wheel¹⁶.
- 2 Forward/backward: lift the handle to adjust the distance to the steering wheel and pedals. Check that the seat is locked after adjusting position.
- 3 To raise/lower the front edge of seat cushion*, pump up/down.
- 4 Adjust backrest rake, turn the wheel.
- 5 Raise/lower the seat*, pump up/down.
- 6 Control panel for power seat*, see Seats, front - electrically operated (p. 79).



! WARNING

Adjust the position of the driver's seat before setting off, never while driving. Make sure that the seat is in locked position in order to avoid personal injury in the event of sudden braking or an accident.

Adjusting the front seat head restraint

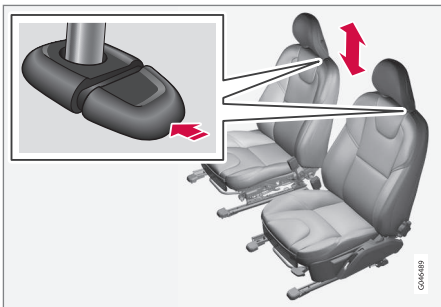

The height of the head restraint can be adjusted.

Adjust the head restraint based on the person's height so that the whole of the back of the head is covered if possible.

To adjust the height, the button (see illustration) must be pressed while the restraint is moved up or down.

The head restraint can be adjusted in three different positions.

Lowering the passenger seat backrest*

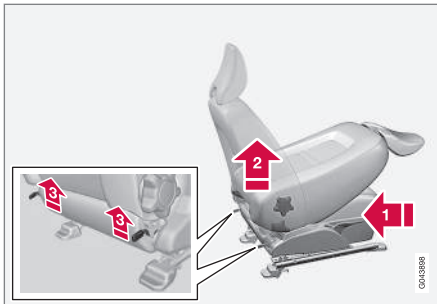

The passenger seat backrest can be folded forward to make room for long loads.

- 1** Move the seat as far back/down as possible.
- 2** Adjust the backrest to an upright position.
- 3** Lift the catches on the rear of the backrest and fold it forward.
4. Push the seat forward so that the head restraint "locks" in under the glovebox.

Raising takes place in reverse order.

! WARNING

Do not use the seat behind the passenger seat, or the rear centre seat, when the passenger seat's backrest is lowered.

! WARNING

Grasp the backrest and make sure that it is properly locked after being folded up in order to avoid personal injury in the event of sudden braking or an accident.

Related information

- Seats, front - electrically operated (p. 79)
- Seats, rear (p. 80)



Seats, front - electrically operated

The car's front seats have different setting options for optimum seating comfort. The power seat can be moved forward/backward and up/down. The front edge of the seat cushion can be raised/lowered. The backrest angle can be changed.

Electrically operated seat*

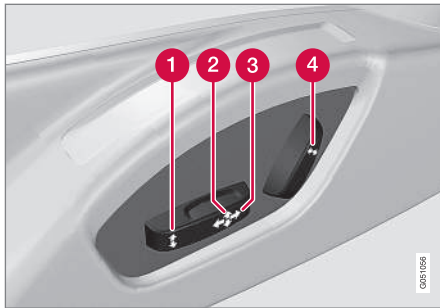

- 1 Front edge of seat cushion up/down
- 2 Raise/lower seat
- 3 Seat, forward/backward
- 4 Backrest rake

The power seats have overload protection which is tripped if a seat is blocked by an object. If this should happen, set the car's electrical system in key position **I** or **0** and

wait a short time before adjusting the seat again.

Only one movement (forward/back/up/down) can be made at a time.

Preparations

The seat can be adjusted for a certain time after unlocking the door with the remote control key without the key in the ignition position **I** and can always be made when the engine is running.

Seat with memory function*

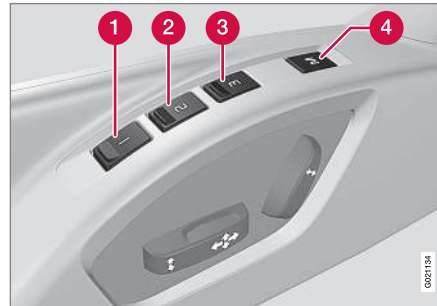

The memory function stores settings for the seat and the door mirrors.

Store setting

- 1 Memory button
- 2 Memory button
- 3 Memory button
- 4 Button for storing settings

1. Adjust the seat and the door mirrors.
2. Press and hold button **M** while pressing button **1**, **2** or **3** simultaneously. Hold the buttons depressed until the acoustic signal is heard and the text is shown the combined instrument panel.

The seat must be adjusted again before a new memory can be set.

Using a stored setting

Press one of the memory buttons **1-3** until the seat and the door mirrors stop. If the button is released, the movement of the seat and door mirrors will be interrupted.

Key memory* in remote control key

All remote control keys can be used by different drivers to store the settings for the driver's seat and door mirrors¹⁷, see Remote control key - personalisation* (p. 157).

¹⁷ Only if the car is equipped with power seat with memory and retractable power door mirrors.



Emergency stop

If the seat accidentally begins to move, press one of the setting buttons for the seat or memory buttons in order to stop the seat.

WARNING

Risk of crushing! Make sure that children do not play with the controls. Check that there are no objects in front of, behind or under the seat during adjustment. Ensure that none of the rear seat passengers is in danger of becoming trapped.

Heated seats

For heated seats, see Heated front seats* (p. 129) and Heated rear seat* (p. 129).

Related information

- Seats, front (p. 77)
- Seats, rear (p. 80)

Seats, rear

The rear seat backrest and the outer seat head restraints can be folded. The centre seat head restraint can be adjusted to suit the height of the passenger.

Head restraint, centre seat, rear

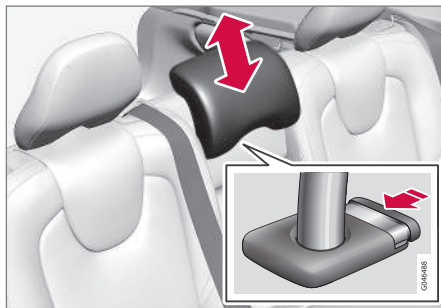

Adjust the head restraint according to passenger height so that the whole of the back of the head is covered if possible. Slide it up as required.

To lower the head restraint again, the button (see illustration) must be pressed while the restraint is carefully moved down.

The head restraint can be adjusted in five different positions.

NOTE

Do not sit in the centre seat with the head restraint in fully lowered position.

Manual lowering of the outer head restraints, rear seat

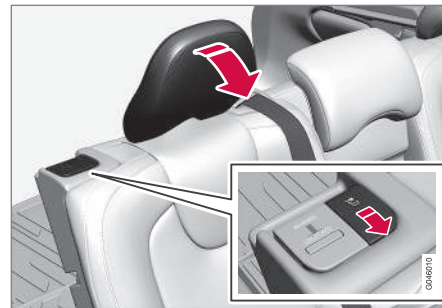

Pull the locking handle closest to the head restraint to fold the head restraint forward.

The head restraint is moved back manually.

WARNING

The head restraint must be in locked position after being folded up.

Lowering the rear seat backrest

IMPORTANT

When the backrest is to be folded, the rear seat cup holder must not be open and there must be no objects in the rear seat. Nor may the seat belts be connected. Otherwise there is a risk of damage to the rear seat upholstery.



i NOTE

The front seats may need to be pushed forwards, and/or the backrests adjusted upwards, in order that the rear backrests can be fully folded forward.

- Both sections can be folded separately.
- If the entire backrest is to be folded then the different sections should be folded separately.

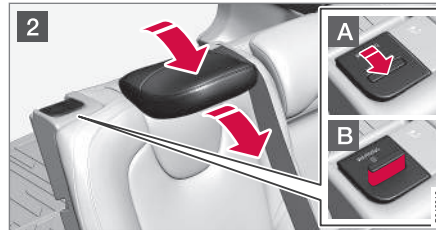
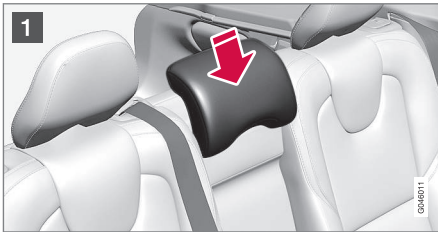

- 1 If the right-hand section is being lowered - release and adjust head restraint for the centre seat, see the earlier section "Head restraint, centre seat, rear".
- 2 The outer head restraints are lowered automatically when the backrests are lowered. Pull up the backrest's locking handle **A** while folding the backrest forward at the same time. A red indicator on the lock catch **B** shows that the backrest is no longer locked in place.

i NOTE

When the backrests have been lowered the head restraints must be moved forward slightly so as not to make contact with the seat cushion.

Raising takes place in reverse order.

i NOTE

When the backrest has been raised, the red indicator should no longer be showing. If it is still showing then the backrest is not locked in place.

! WARNING

Check that the backrests and head restraints in the rear seat are locked properly after being folded up.

Related information

- Seats, front (p. 77)
- Seats, front - electrically operated (p. 79)

Steering wheel

The steering wheel can be adjusted in different positions and has controls for horn and cruise control, as well as menu, audio and phone control.

Adjusting

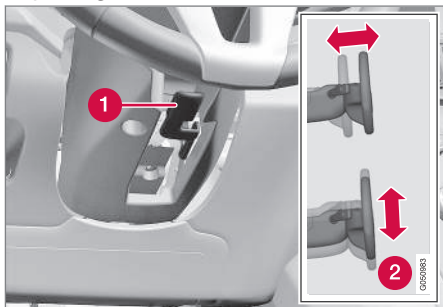

Adjusting the steering wheel.

- 1 Lever - releasing the steering wheel
- 2 Possible steering wheel positions

The steering wheel can be adjusted for both height and depth:

1. Push the lever forwards to release the steering wheel.
2. Adjust the steering wheel to the position that suits you.

3. Pull the lever back to fix the steering wheel in place. If the lever is stiff, press the steering wheel lightly at the same time as you push the lever back.

WARNING

Adjust the steering wheel and fix it before driving away.

With speed related power steering* the level of steering force can be adjusted, see Adjustable steering force (p. 258).

Keypads* and paddles*

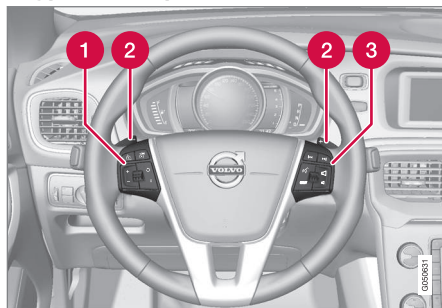

Keypads and paddles in the steering wheel.

- 1 Cruise control* (p. 193)
Adaptive cruise control (ACC)* (p. 198)

- 2 Paddle for manual gear changing in an automatic gearbox, see Automatic gearbox - Geartronic* (p. 269)
- 3 Audio and phone control, see supplement, Sensus Infotainment

Horn



Horn.

Press the centre of the steering wheel to signal.



Light switches

The headlamp control activates and adjusts the external lighting. It is also used to adjust display and instrument lighting and ambience lights (p. 92).

Overview, light switches

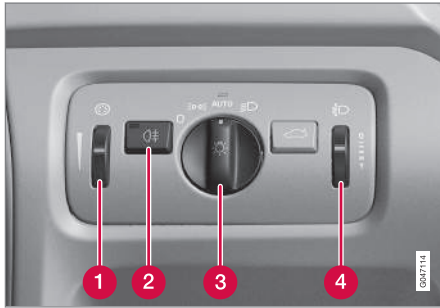



Overview, light switches.

- 1 Thumbwheel for adjusting display and instrument lighting as well as ambience lights*
- 2 Button for rear fog lamp
- 3 Knob for daytime running lights and parking lamps
- 4 Thumbwheel¹⁸ for headlamp levelling

¹⁸ Not available for cars equipped with active Xenon headlamps*.

Knob positions

Position	Specification
0	Daytime running lights ^A when the car's electrical system is in key position II or the engine is running. Main beam flash can be used.
	Daytime running lights, side marker lamps rear and position/parking lamps when the car's electrical system is in key position II or the engine is running. Side marker lamps rear and position/parking lamps when the car is parked. Main beam flash can be used.

Position	Specification
AUTO	Daytime running lights, side marker lamps rear and position/parking lamps in daylight when the car's electrical system is in key position II or the engine is running. Dipped beam, side marker lamps rear and position/parking lamps in weak daylight or darkness or when the rear fog lamp is activated. On cars with active Xenon headlamps* (p. 89) the daytime running light lamps are switched on with reduced brightness. The tunnel detection (p. 86)* function is activated. The Active main beam (p. 87)* function can be used. Main beam can be activated when dipped beam is switched on. Main beam flash can be used.
	Dipped beam, side marker lamps rear and position/parking lamps.



Position	Specification
	Main beam can be activated. Main beam flash can be used. On cars with active Xenon headlamps the daytime running light lamps are switched on with reduced brightness.

A Fitted in or under the front bumper.

Volvo recommends that **AUTO** mode is used when the car is being driven, as long as traffic situations or weather conditions are unfavourable for the Active main beam* function.

Instrument lighting

Different display and instrument lighting is switched on depending on key position; see Key positions - functions at different levels (p. 76).

The display lighting is automatically subdued in darkness - the sensitivity is set with the thumbwheel.

The intensity of the instrument lighting is adjusted with the thumbwheel.

Headlamp levelling

The load in the car changes the vertical alignment of the headlamp beam, which could dazzle oncoming motorists. Avoid this by adjusting the height of the beam. Lower the beam if the car is heavily laden.

1. Leave the engine running, or have the car's electrical system in key position I.
2. Roll the thumbwheel up/down to raise/lower beam alignment.

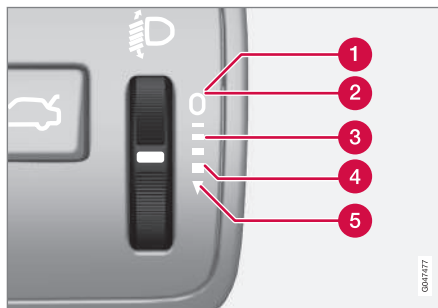

Thumbwheel positions for different load cases.

- 1 Only driver
- 2 Driver and passenger in the front passenger seat
- 3 Occupants in all seats
- 4 Occupants in all seats and maximum load in the cargo area
- 5 Driver and maximum load in the cargo area

Cars with active Xenon headlamps* have automatic headlamp levelling and are therefore not equipped with the thumbwheel.

Related information

- Position/parking lamps (p. 85)
- Daytime running lights (p. 85)
- Main/dipped beam (p. 86)



Position/parking lamps

Position/parking lamps are switched on with the headlamp control knob.



Knob for headlamp control in the position for position/parking lamps.

Turn the knob to the position for  (number plate lighting is switched on at the same time).

If the car's electrical system is in key position **II** or the engine is running then the daytime running lights also switch on.

When it is dark outside and the tailgate is opened the rear position/parking lamps illuminate to alert traffic behind. This takes place irrespective of what position the knob is in or what key position the car's electrical system is in.

Related information

- Light switches (p. 83)

Daytime running lights

With the knob for headlamp control in **AUTO** position, and the car's electrical system in key position **II** or the engine running, the daytime running lights are activated automatically in daylight.

Daytime running lights during the day. DRL

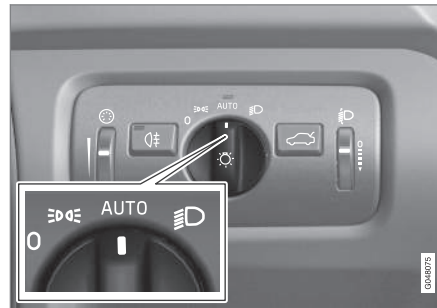

Knob for headlamp control in **AUTO** position.

With the knob for headlamp control in **AUTO** position the daytime running lights (Daytime Running Lights - DRL) are activated automatically when the car is driven in daylight. A light sensor on the top of the instrument panel changes from daytime running lights to dipped beam at twilight or when daylight becomes too weak. Switching to dipped beam also takes place when the rear fog lamps are activated.

On cars with halogen headlamps the daytime running light lamps are switched off when main or dipped beam is activated.

On cars with active Xenon headlamps (p. 89) the daytime running light lamps are switched on with reduced brightness when main or dipped beam is activated.

WARNING

This system help to save energy - it cannot determine in all situations when daylight is too weak or sufficiently strong, e.g. in mist and rain.

The driver is always responsible for ensuring that the car is driven with the correct beam pattern for the traffic situation and in accordance with applicable traffic regulations.

Tunnel detection*

Tunnel detection changes the lighting from daytime running lights to dipped beam when the car is driven into a tunnel. Approx. 20 seconds after the car has left the tunnel, the lighting returns to daytime running lights.

The tunnel detection function is available in cars with rain sensor*. The sensor detects the entrance to a tunnel and resets the lighting from daytime running lights to dipped beam. Approx. 20 seconds after the car has left the tunnel, the lighting returns to daytime running lights. If the car is driven into another tunnel within this time period then dipped beam is kept switched on. This prevents frequent changes to the car's beam pattern.

Note that the headlamp control's knob must remain in **AUTO** position for tunnel detection to work.

Related information

- Main/dipped beam (p. 86)
- Light switches (p. 83)

¹⁹ When dipped beam is activated.

Main/dipped beam



Stalk switch and knob for headlamp control.

- ➔ Position for main beam flash
- ➔ Position for main beam

Dipped beam

With the knob in **AUTO** position, dipped beam is activated automatically at dusk or when daylight becomes too weak. Dipped beam is also activated automatically when the rear fog lamp is activated.

With the knob in **DIPPER** position, dipped beam is always switched on when the engine is running or when key position II is active.

Main beam flash

Move the stalk switch gently towards the steering wheel to the position for main beam

flash. Main beam comes on until the stalk switch is released.

Main beam

Main beam can be activated when the knob is in position **AUTO**¹⁹ or **DIPPER**. Activate/deactivate main beam by moving the stalk switch towards the steering wheel to the end position and then releasing. Alternatively, the main beam can be deactivated by a light press of the stalk switch toward the steering wheel.

When main beam has been activated the **DIPPER** symbol illuminates in the combined instrument panel.

Related information

- Active Xenon headlamps* (p. 89)
- Active main beam* (p. 87)
- Light switches (p. 83)
- Headlamps - adjusting headlamp pattern (p. 94)
- Tunnel detection* (p. 86)



Active main beam*

Active main beam function detects the headlamp beams from oncoming traffic or the rear lights of vehicles in front, and switches the lighting from main beam to dipped beam. The lighting returns to main beam when the incoming light has stopped.

Active main beam - AHB

Active main beam (Active High Beam - AHB) is a function which uses a camera sensor at the top edge of the windscreen to detect the headlamp beams from oncoming traffic or the rear lights of vehicles in front, and then switches from main beam to dipped beam. The function can also take streetlights into account.

The lighting returns to main beam about a second after the camera sensor no longer detects the headlamp beams from oncoming traffic or the rear lights from vehicles in front.

Activating/deactivating

AHB can be activated when the headlamp control's knob is in position **AUTO** (provided that the function has not been deactivated in the menu system MY CAR, see MY CAR (p. 108)).





Stalk switch and knob for headlamp control in **AUTO** position.

The function can start while driving in the dark when the car's speed is 20 km/h or higher.

Activate/deactivate AHB by moving the left-hand stalk switch towards the steering wheel to the end position and then releasing. Deactivation when main beam is on means that the lights are reset directly to dipped beam.

Car with analogue combined instrument panel

When AHB is activated the  symbol illuminates in the instrument's information display.

When main beam has been switched on the  symbol also illuminates in the combined instrument panel.

Car with digital combined instrument panel

When AHB is activated the  symbol turns white in the instrument's information display.

When main beam is activated, the symbol shines blue.



03 Instruments and controls



Manual operation

NOTE

Keep the windscreen surface in front of the camera sensor free from ice, snow, mist and dirt.

Do not stick or attach anything to the windscreen in front of the camera sensor as this may reduce effectiveness or cause one or more of the systems dependent on the camera to stop working.

If the message **Active main beam Temporary unavailable** Switch manually is shown in the combined instrument panel's information display then you have to switch manually between main and dipped beam. However, the knob for headlamp control can still remain in position **AUTO**. The same applies if the message **Windscreen sensors blocked** See manual and the symbol are shown. The symbol goes out when these messages are shown.

AHB may be temporarily unavailable e.g. in situations with dense fog or heavy rain. When AHB becomes available again, or the windscreen sensors are no longer blocked, the message goes out and the symbol illuminates.

WARNING

AHB is an aid for using the optimum beam pattern when conditions are favourable.

The driver always bears responsibility for manually switching between main and dipped beam when traffic situations or weather conditions so require.

IMPORTANT

Examples of when manual switching between main and dipped beam may be required:

- In heavy rain or dense fog
- In freezing rain
- In snow flurries or slush
- In moonlight
- When driving in poorly lit built-up areas
- When the traffic ahead has weak lighting
- If there are pedestrians on or beside the road
- If there are highly reflective objects such as signs in the vicinity of the road
- When the lighting from oncoming traffic is obscured by e.g. a crash barrier
- When there is traffic on connecting roads
- On the brow of a hill or in a hollow
- In sharp bends.

For more information on the limitations of the camera sensor, see Collision warning system* - camera sensor limitations (p. 229).

Related information

- Main/dipped beam (p. 86)
- Light switches (p. 83)



Active Xenon headlamps*

Active Xenon headlamps are designed to provide maximum illumination in bends and junctions and so provide increased safety.

Active Xenon headlamps ABL

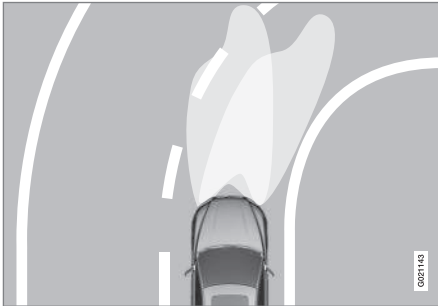

Headlamp pattern with function deactivated (left) and activated (right) respectively.

If the car is equipped with active Xenon headlamps (Active Bending Lights – ABL) then the light from the headlamps follows the steering wheel movement in order to provide maximum lighting in bends and junctions and so provide increased safety.

The function is activated automatically when the car is started (provided that it has not been deactivated in the menu system MY CAR, see MY CAR (p. 108)). In the event of a fault in the function the  symbol illu-

minates in the combined instrument panel at the same time as the information display shows an explanatory text and a further illuminated symbol.

Symbol	Message	Specification
	Headlamp system malfunction Service required	The system is disengaged. Visit a workshop if the message remains. Volvo recommends that you contact an authorised Volvo workshop.

The function is only active in twilight or darkness and only when the car is moving.

The function²⁰ can be deactivated/activated in the menu system MY CAR, see MY CAR (p. 108).

Related information

- Main/dipped beam (p. 86)
- Active main beam* (p. 87)
- Light switches (p. 83)
- Headlamps - adjusting headlamp pattern (p. 94)

Rear fog lamp

When visibility is reduced by fog the rear fog lamp can be used so that other road users shall notice vehicles in front at an early stage.

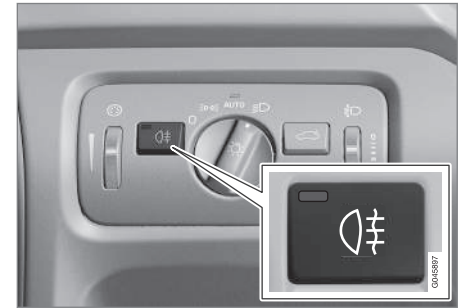

Button for rear fog lamp.

The rear fog lamp consists of one rear lamp and can only be switched on when key position II is active or the engine is running and the headlamp control's knob is in position **AUTO** or .

Press the button for On/Off. The rear fog lamp indicator symbol  in the combined instrument panel and the lamp in the button illuminate when the rear fog lamp is switched on.

The rear fog lamp is switched off automatically when the engine is switched off or when

²⁰ Activated on delivery from the factory.



the headlamp control's knob is turned to position **0** or **☰☱**.



NOTE

Regulations on the use of rear fog lamps vary from country to country.

Related information

- Light switches (p. 83)

Brake lights

The brake light automatically comes on during braking.

The brake light is switched on when the brake pedal is depressed. In addition, it is switched on when one of driving support systems Adaptive cruise control (p. 198), City Safety (p. 216) or Collision warning system (p. 223) brakes the car.

Related information

- Foot brake - emergency brake lights and automatic hazard warning flashers (p. 290)

Hazard warning flashers

The hazard warning flashers warn other road users by means of all of the car's direction indicator lamps flashing simultaneously when this function is activated.

When the hazard warning flashers are activated both direction indicator symbols flash in the combined instrument panel.

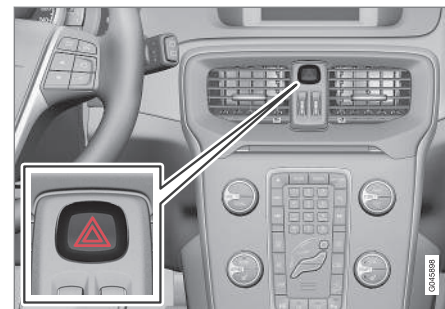

Button for hazard warning flashers.

Press the button to activate the hazard warning flashers. Both direction indicator symbols in the combined instrument panel flash when the hazard warning flashers are used.

The hazard warning flashers are activated automatically when the car has been braked so suddenly that the emergency brake lights have been activated at a speed below 10 km/h. The hazard warning flashers remain on when the car has stopped and are deacti-

000008



vated automatically when the car is driven off again or the button is depressed.

Related information

- direction indicators (p. 91)
- Foot brake - emergency brake lights and automatic hazard warning flashers (p. 290)

direction indicators

The car's direction indicators are operated with the left-hand stalk switch. The direction indicator lamps flash three times or continuously, depending on how far up or down the stalk switch is moved.



Direction indicators.

Short flash sequence

- 1 Move the stalk switch up or down to the first position and release. The direction indicator lamps flash three times. The function can be activated/deactivated in the menu system MY CAR, see MY CAR (p. 108).

Continuous flash sequence

- 2 Move the stalk switch up or down to the outer position.

The stalk switch remains in its position and is moved back manually, or automatically by the steering wheel movement.

Direction indicator symbols

For direction indicator symbols, see Combined instrument panel - meaning of indicator symbols (p. 66).

Related information

- Hazard warning flashers (p. 90)

Interior lighting

The passenger compartment lighting is activated/deactivated with the buttons in the controls above the front seats and the rear seat.

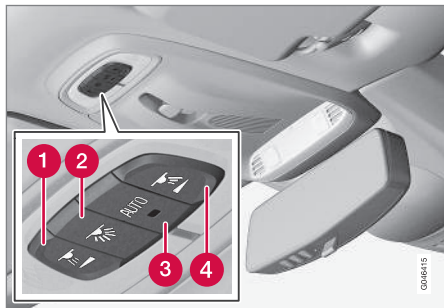

Controls in roof console for the front reading lamps and passenger compartment lighting.

- 1 Reading lamp, left-hand side
- 2 Passenger compartment lighting (floor lamps* and ceiling lamps) - On/Off
- 3 Auto function for passenger compartment lighting
- 4 Reading lamp, right-hand side

All lighting in the passenger compartment can be switched on and off manually within 30 minutes from when:

- the engine has been switched off and the car's electrical system is in key position **0**
- the car has been unlocked but the engine has not been started.

Front reading lamps*

The reading lamps are switched on or off by briefly pressing the relevant button in the roof console.

Brightness is adjusted by holding the button pressed in.

Rear reading lamps*



Rear reading lamps.

The lamps are switched on or off by briefly pressing the relevant button.

Brightness is adjusted by holding the button pressed in.

Floor lighting as ambient light*

To make the interior brighter while driving the floor lighting can be activated at dimmed level.

Floor lamp intensity can be changed in the menu system MY CAR, see MY CAR (p. 108).

Lighting in the front door storage compartments*

Lighting in the front door storage compartments comes on when the engine starts.

Glovebox lighting

Glovebox lighting is switched on and off respectively when the lid is opened or closed.

Vanity mirror lighting

The lighting for the vanity mirror (p. 147) is switched on and off respectively when the cover is opened or closed.

Lighting in the cargo area

The lighting in the cargo area is switched on and off respectively when the tailgate is opened or closed.

Auto function for passenger compartment lighting

The auto function is activated when the lamp in the **AUTO** button is lit.

The passenger compartment lighting is then switched on and off as indicated below.

The passenger compartment lighting is switched on and remains on for 30 seconds if:

- the car is unlocked with the remote control key or key blade, see Remote control



key - functions (p. 160) or Detachable key blade - unlocking doors (p. 164)

- the engine has been switched off and the car's electrical system is in key position 0.

Passenger compartment lighting is switched off when:

- the engine is started
- the car is locked.

The passenger compartment lighting is switched on and off respectively when a side door is opened or closed.

It remains switched on for two minutes if one of the doors is open.

If any lighting is switched on manually and the car is locked then it will be switched off automatically after two minutes.

Mood lights*

When the normal passenger compartment lighting is switched off and the engine is running, an LED illuminates in the front and rear roof console respectively in order to provide a low light and enhance the ambience while driving. The light also makes it easier during dark periods of the day to see objects in storage compartments, etc. This lighting switches off when the engine is switched off. The intensity and colour of the light can be changed in the menu system MY CAR, see MY CAR (p. 108).

Home safe light duration

Home safe lighting consists of dipped beam, parking lamps, lamps in the door mirrors, number plate lighting, interior roof lighting and floor lighting.

Some of the exterior lighting can be kept switched on to work as home safe lighting after the car has been locked.

1. Remove the remote control key from the ignition switch.
2. Move the left-hand stalk switch toward the steering wheel to the end position and release it. The function can be activated in the same way as with main beam flash; see Main/dipped beam (p. 86).
3. Get out of the car and lock the door.

When the function is activated, dipped beam, parking lamps, door mirror lamps, number plate lighting, interior roof lighting and floor lighting are switched on.

The length of time for which the home safe lighting should be kept on can be set in the menu system MY CAR, see MY CAR (p. 108).

Related information

- Approach light duration (p. 93)

Approach light duration

Approach lighting consists of parking lamps, lamps in the door mirrors, number plate lighting, interior roof lighting and floor lighting.

Approach lighting is switched on with the remote control key, see Remote control key - functions (p. 160), and is used to switch on the car's lighting at a distance.

When the function is activated with the remote control, the parking lamps, door mirror lamps, number plate lighting, interior roof lighting and floor lighting are switched on.

The length of time for which the approach lighting should be kept on can be set in the menu system MY CAR, see MY CAR (p. 108).

Related information

- Home safe light duration (p. 93)



Headlamps - adjusting headlamp pattern

The headlamp pattern must be adjusted to avoid dazzling oncoming motorists and can be set for right or left-hand traffic.

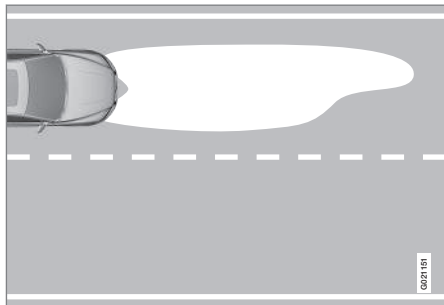

Headlamp pattern, left-hand traffic.

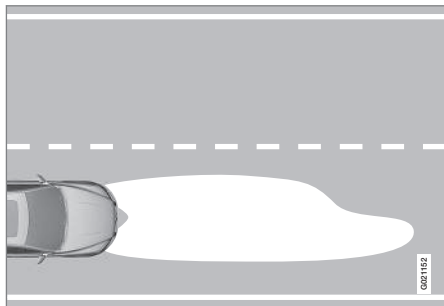

Headlamp pattern, right-hand traffic.

Active Xenon headlamps*

The light pattern does not need to be adjusted. The headlamp pattern is designed in such a way that oncoming traffic is not dazzled.

Halogen headlamps

The headlamp pattern for halogen headlamps is readjusted by masking the headlamp lens. The headlamp pattern may not be as good.

Masking the headlamps

1. Copy the A and B templates for left-hand drive cars or the C and D templates for right-hand drive cars, see later section "Templates for halogen headlamps". The templates have a scale of 1:2. Use a photocopier with a zoom function for example, and copy the templates at 200 %:
 - A = LHD Right (left-hand drive, right lens)
 - B = LHD Left (left-hand drive, left lens)
 - C = RHD Right (right-hand drive, right lens)
 - D = RHD Left (right-hand drive, left lens)
2. Transfer the template to a self-adhesive waterproof material and cut it out.
3. Start from the design lines on the headlamp lenses; see the lines in the following figure. Position the self-adhesive templates at the design lines with the help of the illustration.

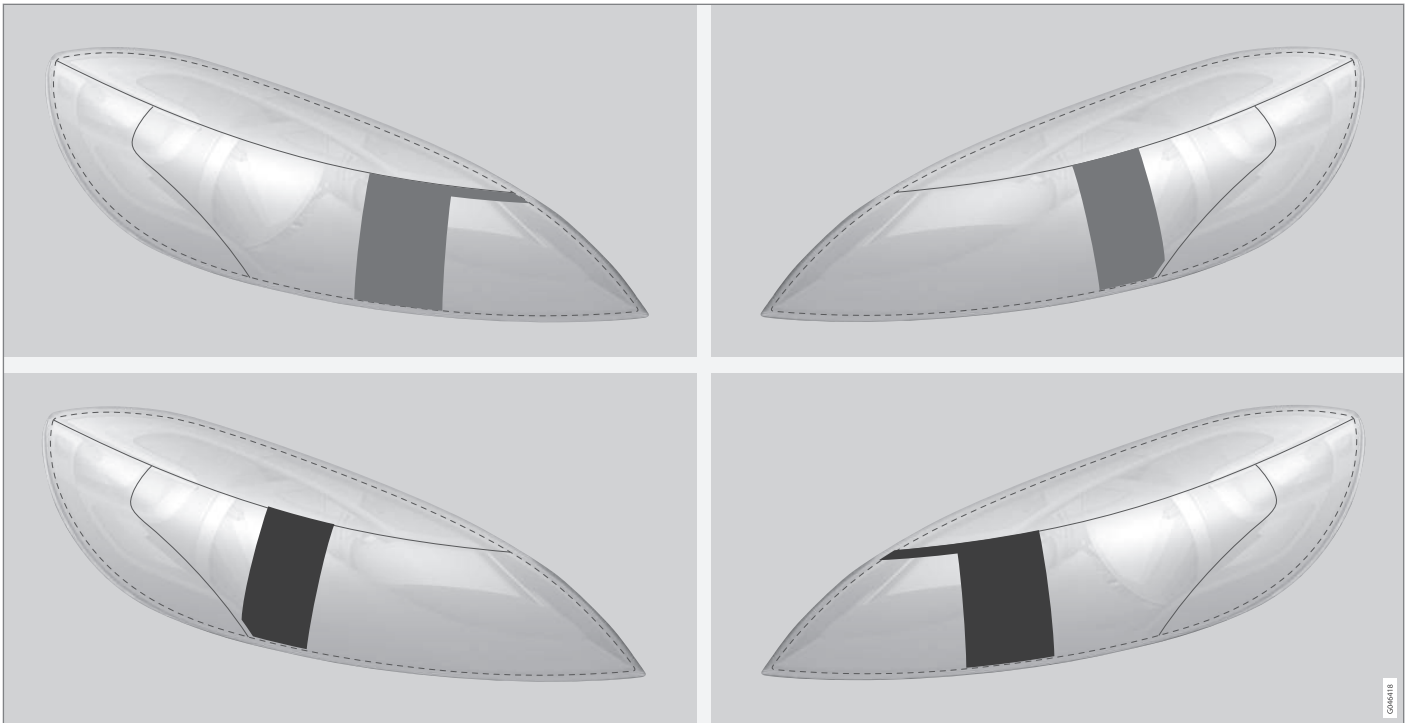

Upper row: left-hand drive cars, templates A and B. Lower row: right-hand drive cars, templates C and D.



Templates for halogen headlamps

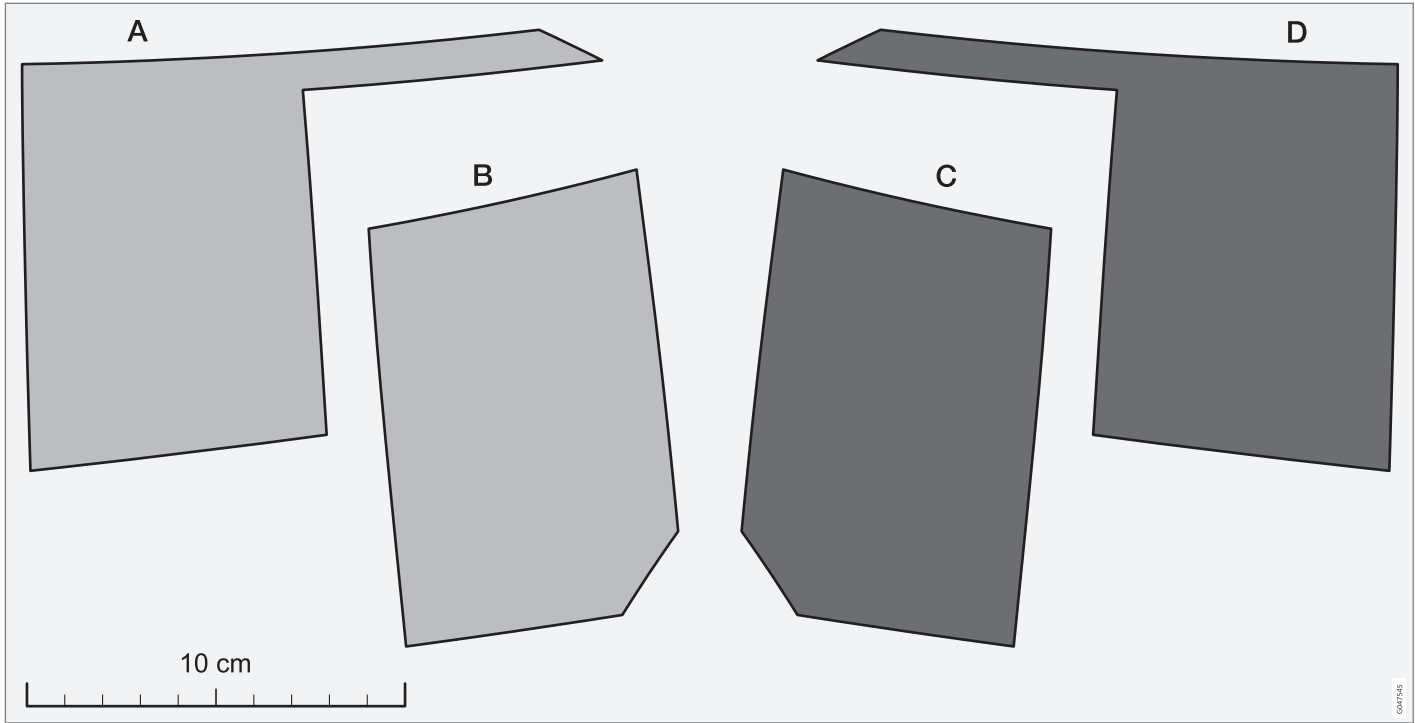

03



Wipers and washing

Wipers and washers clean the windscreen and rear window. The headlamps are cleaned with high-pressure washing.

Windscreen wipers²¹

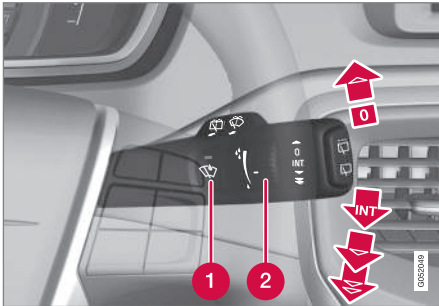

Windscreen wipers and windscreen washers.

- 1 Rain sensor, On/Off
- 2 Thumbwheel sensitivity/frequency

Windscreen wipers off

0 Move the stalk switch to position 0 to switch off the windscreen wipers.

Single sweep

 Raise the stalk switch and release to make one sweep.

Intermittent wiping

INT Set the number of sweeps per time unit with the thumbwheel when intermittent wiping is selected.

Continuous wiping

 The wipers sweep at normal speed.

 The wipers sweep at high speed.

! IMPORTANT

Before activating the wipers during winter ensure that the wiper blades are not frozen in, and that any snow or ice on the windscreen is scraped away.

! IMPORTANT

Use plenty of washer fluid when the wipers are cleaning the windscreen. The windscreen must be wet when the windscreen wipers are operating.

Service position wiper blade

For cleaning the windscreen/wiper blades and replacement of wiper blades, see Wiper blades (p. 367) and Car wash (p. 386).

Rain sensor*

The rain sensor automatically starts the windscreen wipers based on how much water it

detects on the windscreen. The sensitivity of the rain sensor can be adjusted using the thumbwheel.

When the rain sensor is activated a lamp in the button is illuminated and the rain sensor symbol  is shown in the combined instrument panel.

Activating and setting the sensitivity

When activating the rain sensor, the car must be running or the remote control key in position I or II while the windscreen wiper stalk switch must be in position 0 or in the position for a single sweep.

Activate the rain sensor by pressing the button . The windscreen wipers make one sweep.

Press the stalk switch up for the wipers to make an extra sweep.

Turn the thumbwheel upward for higher sensitivity and downward for lower sensitivity. (An extra sweep is made when the thumbwheel is turned upward.)

Deactivate

Deactivate the rain sensor by pressing the button  or move the stalk switch down to another wiper program.

²¹ For replacing the wiper blades and service position wiper blades, see Wiper blades (p. 367). For filling washer fluid, see Washer fluid - filling (p. 370).



03 Instruments and controls



The rain sensor is automatically deactivated when the remote control key is removed from the ignition switch or five minutes after the engine has been switched off.

! IMPORTANT

The windscreen wipers could start and be damaged in an automatic car wash. Switch off the rain sensor while the car is in motion or when the remote control key is in position **I** or **II**. The symbol in the combined instrument panel and the light in the button go out.

Washing the headlamps and windows

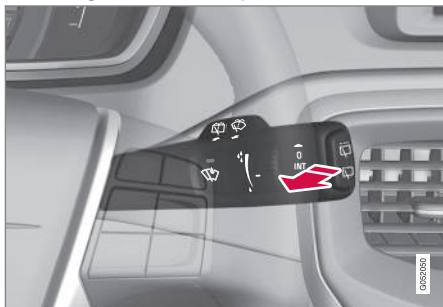

Washing function.

Washing the windscreen

Move the stalk switch toward the steering wheel to start the windscreen and headlamp washers.

The windscreen wipers will make several more sweeps and the headlamps are washed once the stalk switch has been released.

High-pressure headlamp washing*

High-pressure headlamp washing consumes a large quantity of washer fluid. To save fluid, the headlamps are washed automatically at every fifth windscreen wash cycle.

Reduced washing

If only approx. 1 litre of washer fluid remains in the reservoir and the message that you should fill the washer fluid is shown in the combined instrument panel, then the supply of washer fluid to the headlamps is switched off. This is in order to prioritise cleaning the windscreen and the visibility through it.

Wiping and washing the rear window

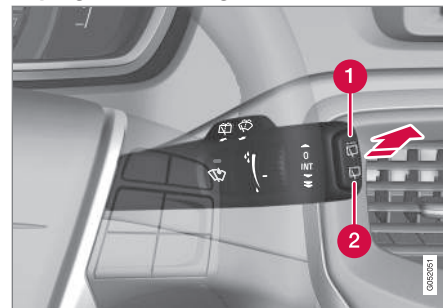

- 1 Rear window wiper – intermittent wiping
- 2 Rear window wiper – continuous speed

Press the stalk switch forward (see the arrow in the illustration above) to initiate rear window washing and wiping.

i NOTE

The rear window wiper is equipped with overheating protection which means that the motor is switched off if it overheats. The rear window wiper works again after a cooling period (30 seconds or longer, depending on the heat in the motor and the outside temperature).



Wiper – reversing

Engaging reverse gear while the windscreen wipers are on initiates intermittent rear window wiping²². The function stops when reverse gear is disengaged.

If the rear window wiper is already on at continuous speed, no change is made.

i NOTE

On cars with rain sensors, the rear wiper is activated during reversing if the sensor is activated and it is raining.

Related information

- Washer fluid - filling (p. 370)
- Washer fluid - quality and volume (p. 405)

Power windows

All power windows can be operated using the control panel for the driver's door - the control panels for the other doors operate their respective power window.

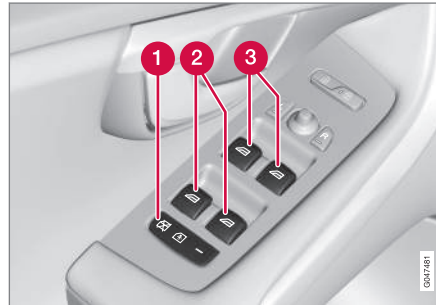

Driver's door control panel.

- 1 Switch for electric child safety locks* and disengaging rear power window buttons; see Child safety locks - electrical activation* (p. 177).
- 2 Rear window controls
- 3 Front window controls

! WARNING

Check that no rear seat passengers are trapped when the windows are closed from the driver's door.

! WARNING

Check that children or other passengers are not trapped if the windows are closed, even when the remote control key is used.

! WARNING

If there are children in the car - remember to always switch off the power supply to the power windows by selecting key position **0** and then take the remote control key with you when leaving the car. For information on key positions - see Key positions - functions at different levels (p. 76).

²² This function (intermittent wiping when reversing) can be deactivated. Visit a workshop. Volvo recommends that you contact an authorised Volvo workshop.



Operating



Operating the power windows.

1 Operating without auto

2 Operating with auto

All power windows can be operated using the control panel for the driver's door - the control panels for the other doors can only each operate their respective power window. Only one control panel can be operated at a time.

In order for the power windows to be used, the key position must be at least I - see Key positions - functions at different levels (p. 76). The power windows can be operated for a few minutes after the engine has been switched off and after the remote control key has been removed - although not after a door has been opened.

Closing of the windows is stopped and the window is opened if anything prevents its

movement. It is possible to override the pinch protection when closing has been interrupted, e.g. if there is ice forming. After two successive closing interruptions the pinch protection will be forced and the automatic function deactivated for a short while, now it is possible to close by continually holding the button pulled up.

i NOTE

One way to reduce the pulsating wind noise when the rear windows are open is to also open the front windows slightly.

Operating without auto

Move one of the controls up/down gently. The power windows move up/down as long as the control is held in position.

Operating with auto

Move one of the controls up/down to the end position and release it. The window runs automatically to its end position.

Operating with the remote control key and central locking

To remotely operate the power windows from the outside with the remote control key or from inside with central locking, see Remote control key (p. 156) and Locking/unlocking - from the inside (p. 172).

Resetting

If the battery is disconnected then the function for automatic opening must be reset so that it can work correctly.

1. Gently raise the front section of the button to raise the window to its end position and hold it there for one second.
2. Release the button briefly.
3. Raise the front section of the button again for one second.

! WARNING

A reset must take place for pinch protection to work.



Door mirrors

The door mirror positions are adjusted with the joystick in the driver's door controls.



Door mirror controls.

Adjusting

1. Press the **L** button for the left-hand door mirror or the **R** button for the right-hand door mirror. The light in the button illuminates.
2. Adjust the position with the joystick in the centre.
3. Press the **L** or **R** button again. The light should no longer be illuminated.

WARNING

Both mirrors are the wide-angle type to provide optimal vision. Objects may appear further away than they actually are.

Storing settings²³

The settings for the rearview and door mirrors and the positions of the driver's seat can be stored for each remote control key in the car key memory*, see Remote control key - personalisation* (p. 157).

Angling the door mirror when parking²³

The door mirror can be angled down for the driver to view the side of the road when parking for example.

- Engage reverse gear and press the **L** or **R** button.

When reverse gear is disengaged the mirror automatically returns to its original position after approx. 10 seconds, or earlier by pressing the button labelled **L** or **R** respectively.

Automatic angling of the door mirror when parking²³

When reverse gear is engaged the door mirror is automatically angled down so that the driver can see the side of the road when parking for example. When reverse gear is disengaged the mirror automatically returns to its original position after a short time.

The function can be activated/deactivated in the menu system MY CAR, see MY CAR (p. 108).

Automatic retraction when locking²³

When the car is locked/unlocked with the remote control key the door mirrors are automatically retracted/extended.

The function can be activated/deactivated in the menu system MY CAR, see MY CAR (p. 108).

Resetting to neutral

Mirrors that have been moved out of position by an external force must be reset electrically to the neutral position for electric retracting/extending to work correctly:

1. Retract the mirrors with the **L** and **R** buttons.
2. Fold them out again with the **L** and **R** buttons.
3. Repeat the above procedure as necessary.

The mirrors are now reset in neutral position.

Retractable power door mirrors*

The mirrors can be retracted for parking/driving in narrow spaces:

1. Depress the **L** and **R** buttons simultaneously (key position must be at least I).

²³ Only in combination with power seat with memory, see Seats, front - electrically operated (p. 79).



03 Instruments and controls



- Release them after approximately 1 second. The mirrors automatically stop in the fully retracted position.

Fold out the mirrors by pressing down the **L** and **R** buttons simultaneously. The mirrors automatically stop in the fully extended position.

Home safe and approach lighting

The lamp on the door mirrors illuminates when approach lighting (p. 93) or home safe lighting (p. 93) is selected.

Related information

- Rearview mirror - interior (p. 103)
- Windows and rearview and door mirrors - heating (p. 102)

Windows and rearview and door mirrors - heating

The defroster is used to quickly remove misting and ice from the windscreen, rear window and door mirrors.

Heated windscreen*, rear window and door mirrors

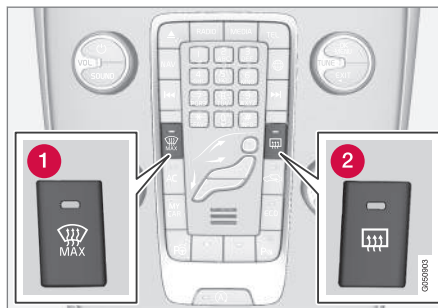

- Heating, windscreen
- Heating, rear window and door mirrors

The function is used to remove ice and misting from the windscreen, rear window and door mirrors.

One press of the respective button starts the heating. The light in the button indicates that the function is active. Switch off the heating as soon as the ice/misting is cleared in order not to load the battery unnecessarily. However, the function is switched off automatically after a certain time.

See also Demisting and defrosting the windscreen (p. 132).

The door mirrors and rear window are demisted/defrosted automatically if the car is started in an outside temperature lower than +7 °C. Automatic defrosting can be selected in the menu system MY CAR, see MY CAR (p. 108).

The compass (p. 104) is deactivated when the heated windscreen is activated. When the heated windscreen is deactivated, the compass is reactivated.



Rearview mirror - interior

The interior rearview mirror can be dimmed with a control in the mirror's lower edge. Alternatively, the rearview mirror dims automatically.

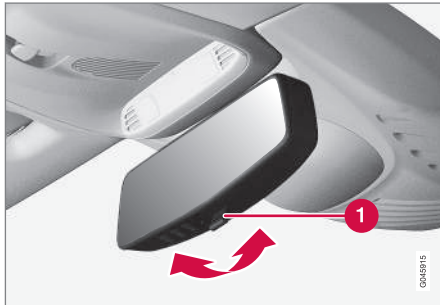

- 1 Control for dimming

Manual dimming

Bright light from behind could be reflected in the rearview mirror and dazzle the driver. Use dimming with the dimming control when lights from behind are distracting:

1. Use dimming by moving the control in towards the passenger compartment.
2. Return to normal position by moving the control towards the windscreen.

Automatic dimming*

Bright light from behind is automatically dimmed by the rearview mirror. The control

for manual dimming is not available on mirrors with automatic dimming.

The rearview mirror contains two sensors - one forward facing and one rearward facing - that work together to identify and eliminate dazzling light. The forward facing sensor detects ambient light, while the rearward facing sensor detects the light from vehicle headlights behind.

NOTE

If the sensors are obscured by e.g. parking permits, transponders, sun visors or objects in the seats or in the cargo area in such a way that light is prevented from reaching the sensors, then the dimming function of the rearview mirror is reduced.

Only rearview mirror with automatic dimming can be equipped with compass (p. 104).

Related information

- Door mirrors (p. 101)

Glass roof*

The glass roof's blind can be operated with the control in the roof console.

The glass roof is fixed but the power operated roller blind can be operated in key position I or II with the control in the roof console. For information on key positions - see Key positions - functions at different levels (p. 76).

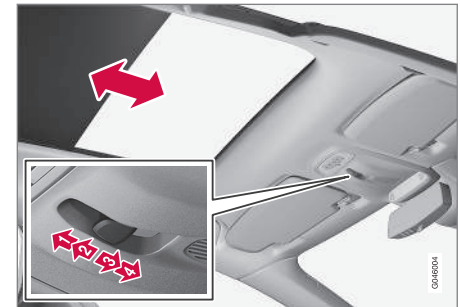

- 1 Automatic opening to end position
- 2 Manual opening until the button is released
- 3 Manual closing until the button is released
- 4 Automatic closing to end position



! IMPORTANT

- Avoid touching the blind because it may then be damaged.
- Only use the control in the roof console to operate the blind.

Compass

The rearview mirror contains an integrated display that shows the compass direction in which the front of the car is pointing.

Operation

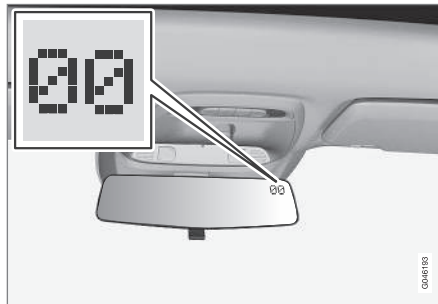

Rearview mirror with compass.

The upper right-hand corner of the rearview mirror has an integrated display that shows the compass direction in which the front of the car is pointing. Eight different directions are shown with English abbreviations: **N** (north), **NE** (north east), **E** (east), **SE** (south east), **S** (south), **SW** (south west), **W** (west) and **NW** (north west).

The compass* is activated automatically when the car is started or when key position **II** is active, see Key positions - functions at different levels (p. 76). To deactivate/activate the compass - press in the button on the rear

side of the mirror using a paper clip for example.

The compass is deactivated when the heated windscreen is activated. When the heated windscreen is deactivated, the compass is reactivated.

Calibration

The earth is divided into 15 magnetic zones. The compass is set for the geographic area to which the car was delivered. The compass should be calibrated if the car is moved across several magnetic zones. Proceed as follows:

1. Stop the car in a large open area free from steel structures and high-voltage power lines.
2. Start the car.

i NOTE

For the best calibration, switch off all electrical equipment (climate control system, wipers, etc.) and make sure that all doors are closed.

3. Hold the button on the underside of the rearview mirror depressed approx. 3 seconds. The number of the current magnetic zone is shown.

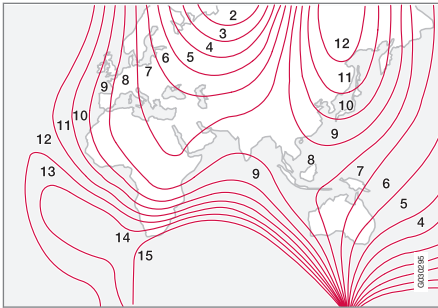

Magnetic zones.

4. Press the button repeatedly until the required magnetic zone (1–15) is shown. See the map of magnetic zones for the compass.
5. Wait until the display returns to showing the character **C**, or hold the button on the bottom of the rearview mirror depressed for approx. 6 seconds (use e.g. a paper clip) until the character **C** is shown.
6. Drive slowly in a circle at a speed of no more than 10 km/h until a compass direction is shown in the display, indicating that calibration is complete. Then drive a further 2 circles to fine-tune calibration.
7. Repeat the above procedure as necessary.

Menu navigation - combined instrument panel

The menus shown on the information display in the combined instrument panel (p. 61) are controlled with the left-hand stalk switch. Which menus are shown depends on the key position (p. 76).

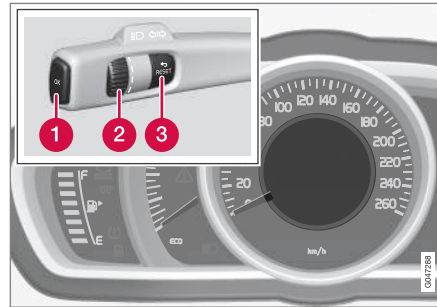

Information display (analogue combined instrument panel) and menu navigation controls.

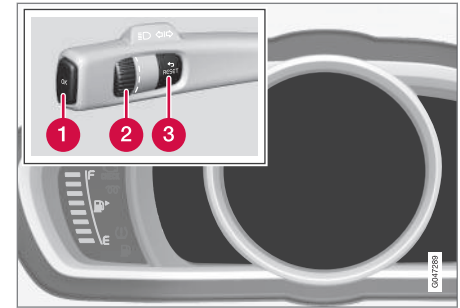

Information displays (digital combined instrument panel) and controls for menu navigation.

- 1 **OK** - access the menu, acknowledge messages and confirm menu selections.
- 2 **Thumbwheel** – browse between menu options.
- 3 **RESET** - reset data in the selected trip computer step and go back in the menu structure.

If there is a message (p. 106) then it must be acknowledged with **OK** in order that the menus shall be shown.

Related information

- Messages - handling (p. 107)
- Menu overview - analogue combined instrument panel (p. 106)
- Menu overview - digital combined instrument panel (p. 106)



Menu overview - analogue combined instrument panel

Which menus are shown in the combined instrument panel's information display depends on the key position (p. 76).

Some of the following menu options require the function and hardware to be installed in the car.

Digital speed

Parking heater*

Additional heater*

TC options

Service status

Oil level²⁴

Messages (##)²⁵

Related information

- Menu navigation - combined instrument panel (p. 105)
- Menu overview - digital combined instrument panel (p. 106)
- Combined instrument panel (p. 61)

²⁴ Certain engines.

²⁵ The number of messages is indicated in brackets.

²⁶ The number of messages is indicated in brackets.

²⁷ Certain engines.

Menu overview - digital combined instrument panel

Which menus are shown in the combined instrument panel's information display depends on the key position (p. 76).

Some of the following menu options require the function and hardware to be installed in the car.

Settings*

Themes

Contrast mode/Colour mode

Service status

Messages²⁶

Oil level²⁷

Parking heater*

Trip computer reset

Related information

- Menu navigation - combined instrument panel (p. 105)
- Menu overview - analogue combined instrument panel (p. 106)
- Combined instrument panel (p. 61)

Messages

When a warning, information or indicator symbol illuminates, a corresponding message appears on the information display.

Message	Specification
Stop safely ^A	Stop and switch off the engine. Serious risk of damage - consult a workshop ^B .
Stop engine ^A	Stop and switch off the engine. Serious risk of damage - consult a workshop ^B .
Service urgent ^A	Contact a workshop ^B to check the car immediately.
Service required ^A	Contact a workshop ^B to check the car as soon as possible.
See manual ^A	Read the owner's manual.
Book time for maintenance	Time to book regular service - contact a workshop ^B .



Message	Specification
Time for regular maintenance	Time for regular service - contact a workshop ^B . The timing is determined by the number of kilometres driven, number of months since the last service, engine running time and oil grade.
Maintenance overdue	If the service intervals are not followed then the warranty does not cover any damaged parts - contact a workshop ^B .
Transmission Oil change needed	Contact a workshop ^B to check the car as soon as possible.
Transmission Reduced performance	The gearbox cannot handle full capacity. Drive with care until the message clears ^C . If shown repeatedly - contact a workshop ^B .
Transmission hot Reduce speed	Drive more smoothly or stop the car in a safe manner. Disengage the gear and run the engine at idling speed until the message clears ^C .

Message	Specification
Transmission hot Stop safely Wait for cooling	Critical fault. Stop the car immediately in a safe manner and contact a workshop ^B .
Temporarily off^A	A function has been temporarily switched off and is reset automatically while driving or after starting again.
Low battery charge Power save mode	The audio system is switched off to save energy. Charge the battery.

^A Part of message, shown together with information on where the problem has arisen.

^B An authorised Volvo workshop is recommended.

^C For more messages concerning automatic gearbox.

Related information

- Messages - handling (p. 107)
- Menu navigation - combined instrument panel (p. 105)

Messages - handling

Use the left-hand stalk switch to acknowledge and browse among messages (p. 106) that are shown in the information display of the combined instrument panel.

When a warning, information or indicator symbol illuminates, a corresponding message is shown in the display. An error message is stored in a memory list until the fault has been rectified.

Press **OK** on the left-hand stalk switch to acknowledge²⁸ a message. Scroll through messages with the thumbwheel (p. 105).

NOTE

If a warning message appears while you are using the trip computer, the message must be read (press **OK**) before the previous activity can be resumed.

Related information

- Menu overview - analogue combined instrument panel (p. 106)
- Menu overview - digital combined instrument panel (p. 106)

MY CAR

MY CAR is a menu source that handles many of the car's functions, e.g. City Safety™, locks and alarm, automatic fan speed, setting the clock, etc.

Certain functions are standard, others are optional - the range also varies depending on the market.

Operation

Navigation in the menus is carried out using buttons in the centre console or with the steering wheel's right-hand keypad*.

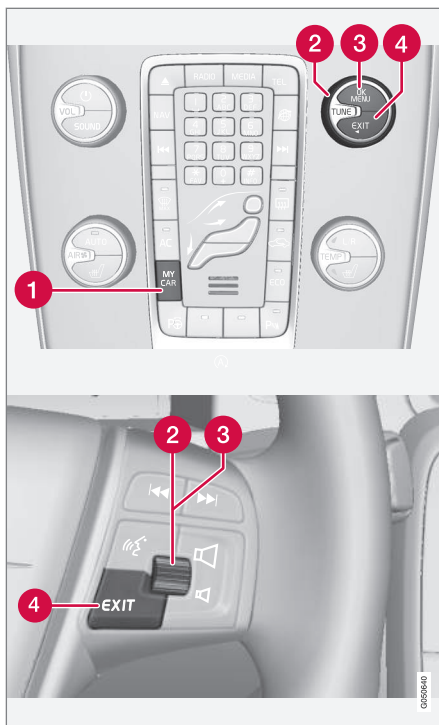

Control panel in centre console and steering wheel keypad. The figure is schematic - the number of functions and layout of the buttons both

vary, depending on the equipment selected and the market.

- 1 **MY CAR** - opens the menu system MY CAR.
- 2 **OK/MENU** - press the button in the centre console or the thumbwheel on the steering wheel to select/tick in the highlighted menu option or store the selected function in the memory.
- 3 **TUNE** - turn the knob in the centre console or the thumbwheel on the steering wheel to scroll up/down through the menu options.
- 4 **EXIT**

EXIT functions

Depending on the function the cursor is on when **EXIT** is depressed briefly, and on which menu level, one of the following may occur:

- phone call is rejected
- current function is interrupted
- input characters are deleted
- most recent selections are undone
- leads up in the menu system.

A long press on **EXIT** leads to the normal view for MY CAR or if you are in the normal view, to the highest menu level (main source menu).

²⁸ A message can also be acknowledged via the thumbwheel or **RESET** button.



Menu options and search paths

For a description of the menu options and search paths in MY CAR, see the Sensus Infotainment supplement.

Trip computer

The car's trip computer can record, calculate and show information.

General

Checking and settings can be made immediately after the combined instrument panel is automatically illuminated in connection with unlocking. If none of the trip computer's controls are actuated within approx. 30 seconds after the driver's door has been opened then the instrument extinguishes, after which either key position II (p. 76) or engine starting is required in order to operate the trip computer.



NOTE

If a warning message appears when the trip computer is used then the message must first be acknowledged before the trip computer can be reactivated.

- Acknowledge the message by briefly pressing the indicator stalk **OK** button.

Group menus

The trip computer has two different group menus:

- Functions
- Heading in combined instrument panel

The trip computer's **functions** or **headings** are each listed in an infinite loop.

Related information

- Trip computer - analogue combined instrument panel (p. 110)
- Trip computer - digital combined instrument panel (p. 114)
- Trip computer - supplementary information (p. 118)
- Trip computer - trip statistics* (p. 119)



Trip computer - analogue combined instrument panel

The trip computer's menu is in a variable loop. One of the alternatives is that the trip computer's display extinguishes - this also marks the start/end of the loop.

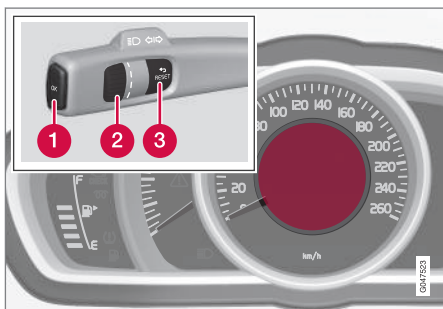

Information display and controls.

- 1 **OK** - Opens the loop with the trip computer's functions + Activates the selected option.
- 2 **Thumbwheel** - Opens the loop with the trip computer's headings + Scrolls through the options.
- 3 **RESET** - Undoes, zeroes or backs out of a function after making a selection.

Functions

Proceed as follows to open and check/adjust functions:

1. To ensure that no control is in the middle of a sequence - "Reset" them first with two presses on **RESET**.
2. Press **OK** - the loop with all functions opens.
3. Browse through the functions with the **thumbwheel** and select/confirm with **OK**.
4. Finish by pressing twice on **RESET** after completed checking/adjustment.

The different functions of the trip computer are listed in the following table:



Functions	Information
Digital speed <ul style="list-style-type: none"> • km/h • mph • No display 	<p>Shows the car's speed digitally in the centre of the combined instrument panel:</p> <ul style="list-style-type: none"> • Open with OK, select with the thumbwheel, confirm with OK and back out with ENTER.
Parking heater* <ul style="list-style-type: none"> • DIRECT START • - Timer 1 - leads to the menu for selecting time. • - Timer 2 - leads to the menu for selecting time. 	<p>For a description of programming the timer, see Engine block heater and passenger compartment heater* - timer (p. 138).</p>
Additional heater* <ul style="list-style-type: none"> • Auto On • Off 	<p>For more information, see Additional heater* (p. 140).</p>
TC options <ul style="list-style-type: none"> • Distance to empty tank • Fuel consumption • Average speed • Trip meter T1 and total dist. • Trip meter T2 and total dist. 	<p>Here you can select/activate the options that you want to be available as selectable headings in the trip computer. The symbols for the items already selected are WHITE with a "tick" - others are GREY and have no "tick":</p> <ol style="list-style-type: none"> 1. Open the function with OK, scroll through the symbols for the options with the thumbwheel and select/stop on the desired symbol. 2. Confirm with OK - the symbol changes colour from GREY to WHITE and is marked with a "tick". 3. Continue to select the function symbols with the thumbwheel or finish with RESET.
Service status	<p>Shows the number of months and the distance until the next service.</p>



03 Instruments and controls



Functions	Information
Oil level ^A	For more information, see Engine oil - checking and filling (p. 355).
Messages (###)	For more information, see Messages (p. 106).

A Certain engines.

Headings

One of the headings in the following table can be selected for constant display in the combined instrument panel. Proceed as follows to determine which:

1. To ensure that no control is in the middle of a sequence - "Reset" them first with two presses on **RESET**.
2. Turn the **thumbwheel** - selectable headings for the trip computer are shown in a loop.
3. Stop on desired heading.

Trip computer heading in combined instrument panel	Information
Trip meter T1 and total dist.	<ul style="list-style-type: none"> • Long press on RESET resets trip meter T1.
Trip meter T2 and total dist.	<ul style="list-style-type: none"> • Long press on RESET resets trip meter T2.
Distance to empty	For more information - see the section "Range - distance to empty tank" (p. 118).
Fuel consumption	Current consumption.
Average speed	<ul style="list-style-type: none"> • Long press on RESET resets Average speed.
No trip computer information.	This option shows a blank display - it also marks the beginning/end of the loop.

The combined instrument panel's trip computer can be changed to another option at any time during the journey. Proceed as follows:

- Turn the **thumbwheel** - stop on the desired heading.

Resetting - Trip meter and Average speed

With the current trip computer heading - **T1 and total dist., T2 and total dist.** or



Average speed - shown in the combined instrument panel:

- Give a long press on RESET **RESET** - selected heading is zeroed.

Each heading must be zeroed individually.

Related information

- Trip computer (p. 109)
- Trip computer - digital combined instrument panel (p. 114)
- Trip computer - supplementary information (p. 118)
- Trip computer - trip statistics* (p. 119)



03 Instruments and controls

Trip computer - digital combined instrument panel

The trip computer's menu is in a variable loop. One of the alternatives is that the trip computer's three displays extinguish - this also marks the start/end of the loop.

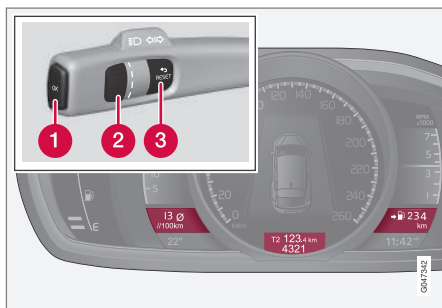

Information displays and controls.

- 1 OK** - Opens the loop with the trip computer's functions + Activates the selected option.
- 2 Thumbwheel** - Opens the loop with the trip computer's headings + Scrolls through the options.
- 3 RESET** - Undoes, zeroes or backs out of a function after making a selection.

Functions

Proceed as follows to open and check/adjust functions:

- To ensure that no control is in the middle of a sequence - "Reset" them first with two presses on **RESET**.
- Press **OK** - loop with all functions opens.
- Browse through the functions with the **thumbwheel** and select/confirm with **OK**.
- Finish by pressing twice on **RESET** after completed checking/adjustment.

The different functions of the trip computer are listed in the following table:



Functions	Information
Trip computer reset <ul style="list-style-type: none"> • Average • Average speed 	Note that this function does not reset both trip meters T1 and T2 - see table under next section "Headings" and section "Resetting - Average speed/consumption" for information on the process.
Messages	For more information, see Messages (p. 106).
Themes	Combined instrument panel appearance is selected here, see Digital combined instrument panel - overview (p. 62).
Settings*	Select Auto On or Off . For more information, see Additional heater* (p. 140).
Contrast mode/Colour mode	Adjusting the combined instrument panel's brightness and colour intensity.
Parking heater* <ul style="list-style-type: none"> • Direct start • - Symbol Timer 1 - leads to the menu for selecting time. • - Symbol Timer 2 - leads to the menu for selecting time. 	For a description of programming the timer, see Engine block heater and passenger compartment heater* - timer (p. 138).
Service status	Shows the number of months and the distance until the next service.
Oil level^A	For more information, see Engine oil - checking and filling (p. 355).

^A Certain engines.



03 Instruments and controls



Headings

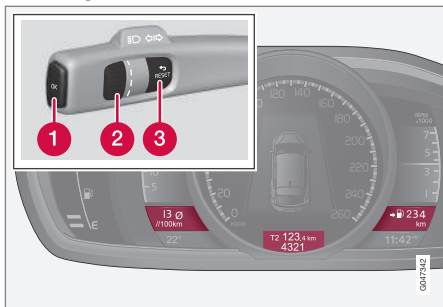

Three trip computer headings can be displayed simultaneously - one in each "window".

One of the heading combinations in the following table can be selected for constant display in the combined instrument panel. Proceed as follows to determine which:

1. To ensure that no control is in the middle of a sequence - "Reset" them first with two presses on **RESET**.
2. Turn the **thumbwheel** - selectable heading combinations are shown in a loop.
3. Stop on desired heading combination.

Heading combinations			Information
Average	Trip meter T1 + Meter reading	Average speed	• Long press on RESET resets trip meter T1.
Instantaneous	Trip meter T2 + Meter reading	Distance to empty tank	• Long press on RESET resets trip meter T2.
Instantaneous	Meter reading	kmh<>mph	kmh<>mph - "Digital speed display", see Trip computer - supplementary information (p. 118).
	No trip computer information.		This option extinguishes all three trip computer displays - it also marks the beginning/end of the loop.

The combined instrument panel's heading combination for the trip computer can be changed to another option at any time during the journey. Proceed as follows:

- Turn the **thumbwheel** - stop on the desired heading.

Resetting - Trip meter

Turn with the **thumbwheel** to the heading combination containing the trip meter to be reset:



- Give a long press on **RESET** - selected trip meter is zeroed.

Resetting - Average speed/ consumption

1. Select function **Trip computer reset** and activate with **OK**.
2. Select one of the following options with the **thumbwheel** and activate with **OK**:
 - l/100 km
 - km/h
 - Reset both
3. Finish with **RESET**.

Related information

- Trip computer (p. 109)
- Trip computer - analogue combined instrument panel (p. 110)
- Trip computer - supplementary information (p. 118)
- Trip computer - trip statistics* (p. 119)



Trip computer - supplementary information

Supplementary information covering several functions follows below.

Average

Average fuel consumption is calculated from the last resetting.

NOTE

There may be a slight deviation if a fuel-driven heater* has been used.

Average speed

The average speed is calculated for the driving distance driven since the last reset to zero.

Instantaneous

The information for current fuel consumption is updated continuously - approximately once per second. When the car is driven at low speed the consumption is shown per time unit - at a higher speed it is shown related to mileage.

Different units (km/miles) can be selected for the display - see section below. "Change unit" (p. 118)

Range - distance to empty tank

The trip computer shows the approximate distance that can be driven with the fuel quantity remaining in the tank.

No guaranteed range remains when the heading **Distance to empty** shows "----".

- In which case, refuel as soon as possible.

The calculation is based on the average fuel consumption over the last 30 km and the remaining driveable fuel quantity.

NOTE

There may be a slight deviation if the driving style has been changed.

An economic driving style generally results in a longer driving distance. For more information on how fuel consumption can be influenced, see Volvo Cars' environmental philosophy (p. 21).

Digital speed display²⁹

The speed is shown in the opposite unit (kmh/mph) in relation to the main instrument. If it is calibrated in mph then the trip computer shows the corresponding speed in km/h and vice versa.

Change unit

You can change unit (km/miles) for distance and speed in the menu system MY CAR, see MY CAR (p. 108).

NOTE

In addition to in the trip computer, these units are also changed in Volvo's navigation system*.

Related information

- Trip computer (p. 109)
- Trip computer - analogue combined instrument panel (p. 110)
- Trip computer - digital combined instrument panel (p. 114)
- Trip computer - trip statistics* (p. 119)

²⁹ Only with combined instrument panel "Digital".



Trip computer - trip statistics*

Information is stored about completed trips containing average fuel consumption and average speed, which can be viewed in the centre console's screen as a bar chart.

Function

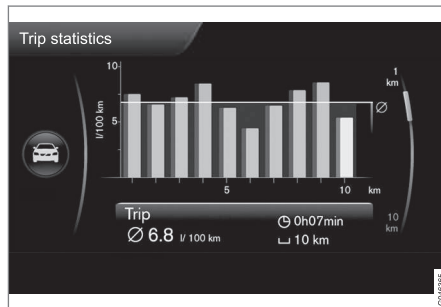

Trip statistics³⁰.

Each bar symbolises 1 km or 10 km driven distance, depending on the scale selected - the bar at the far right shows the value for the current kilometre or 10 km.

The **TUNE** knob can be used to change the scale for each bar between 1 km and 10 km - the cursor at the far right changes position between up and down depending on the scale selected.

Operation

Different settings can be made in the menu system **MY CAR**, see MY CAR (p. 108) - there, find **Trip statistics**.

With the "**Reset when vehicle has been off for minimum 4h**" option highlighted, all statistics are deleted automatically once driving is complete and the car has been stopped for 4 hours. The journey statistics start again from zero the next time the engine is started.

- **Reset when vehicle has been off for minimum 4h** - highlight the box by selecting **ENTER** and go back out of the menu by selecting **EXIT**.

If a new drive cycle begins before 4 hours have passed, the current period has to be deleted manually first using the "**Start new trip**" option.

- **Start new trip - ENTER** is used to delete all previous statistics, back out of the menu by selecting **EXIT**.

See also information on Eco guide (p. 65).

Related information

- Trip computer (p. 109)
- Trip computer - analogue combined instrument panel (p. 110)
- Trip computer - digital combined instrument panel (p. 114)

- Trip computer - supplementary information (p. 118)

³⁰ The figure is schematic - layout may vary depending on updated software and market.

04



CLIMATE CONTROL





General information on climate control

The car is equipped with electronic climate control. The climate control system cools or heats as well as dehumidifies the air in the passenger compartment.

There are two different climate control systems:

- Electronic temperature control (ETC) (p. 128)
- Electronic climate control (ECC) (p. 127)

NOTE

Air conditioning (AC) (p. 131) can be switched off, but to ensure the best possible climate comfort in the passenger compartment, and to prevent the windows from misting, it should always be switched on.

To bear in mind

- To ensure that the air conditioning works optimally, the side windows must be closed.
- Global opening (p. 173) opens/closes all side windows simultaneously and can be used for example to quickly air the car during hot weather.
- Remove ice and snow from the climate control system air intake (the grille between the bonnet and the windscreen).

- In warm weather, condensation from the air conditioning may drip under the car. This is normal.
- When the engine requires full power, e.g. for full acceleration, the air conditioning can be temporarily switched off. There may then be a temporary increase in temperature in the passenger compartment.
- Remove misting on the insides of the windows primarily by using the defroster function (p. 132). To reduce the risk of misting, keep the windows clean and use window cleaner.

Cars with Start/Stop*

With an auto-stopped (p. 276) engine certain equipment may have its function temporarily reduced, e.g. climate control fan speed (p. 130).

Cars with ECO*

Certain equipment may have its function temporarily reduced or deactivated when the ECO (p. 285) function is activated, e.g. the air conditioning (p. 131).

NOTE

When the ECO function is activated, several parameters in the climate control system's settings are changed, and several electricity consumer functions are reduced. Certain settings can be reset manually, but full functionality is only restored by deactivating the ECO function.

Related information

- Actual temperature (p. 122)
- Sensors - climate control (p. 122)
- Menu settings - climate control (p. 124)
- Air distribution in the passenger compartment (p. 125)
- Air quality (p. 122)
- Heated front seats* (p. 129)
- Heated rear seat* (p. 129)



Actual temperature

The temperature you select in the passenger compartment corresponds to the physical experience with reference to factors such as ambient temperature, air speed, humidity and solar radiation etc. in and around the car at the time.

The system includes a sun sensor (p. 122) which detects on which side the sun is shining into the passenger compartment. This means¹ that the temperature can differ between the right and left-hand air vents despite the controls being set for the same temperature on both sides.

Related information

- General information on climate control (p. 121)
- Temperature control in the passenger compartment (p. 131)

Sensors - climate control

The climate control system has a number of sensors to help control the temperature (p. 122) in the car.

- The sun sensor is located on the top side of the dashboard.
- The temperature sensor for the passenger compartment is located below the climate control panel.
- The outside temperature sensor is located in the door mirror.



NOTE

Do not cover or block the sensors with clothing or other objects.

Related information

- General information on climate control (p. 121)

Air quality

The interior in a passenger compartment is designed to be pleasant and comfortable, even for people with contact allergies and for asthma sufferers.

- Passenger compartment filter (p. 123)
- Material in the passenger compartment (p. 124)
- Clean Zone Interior Package (CZIP) (p. 123)*
- Interior Air Quality System (IAQS) (p. 124)*

Related information

- General information on climate control (p. 121)

¹ Only applies to ECC.



Air quality - passenger compartment filter

All air entering the car's passenger compartment is cleaned with a filter.

The filter must be replaced at regular intervals. Follow the Volvo Service Programme for the recommended replacement intervals. If the car is used in a severely contaminated environment, it may be necessary to replace the filter more often.

NOTE

There are different types of passenger compartment filter. Make sure that the correct filter is fitted.

Related information

- Air quality (p. 122)

Air quality - Clean Zone Interior Package (CZIP)*

CZIP comprises a series of modifications that keep the passenger compartment even clearer from allergy and asthma-inducing substances.

The following is included:

- An enhanced fan function that means that the fan starts when the car is opened with the remote control key. The fan fills the passenger compartment with fresh air. The function starts when required and is disengaged automatically after a time or when one of the passenger compartment doors is opened. The amount of time the fan runs is reduced gradually due to reduced need up until the car is 4 years old.
- The air quality system IAQS (p. 124) is a fully automatic system that cleans the air in the passenger compartment from contaminants such as particles, hydrocarbons, nitrous oxides and ground-level ozone.

NOTE

To maintain the CZIP standard in cars with CZIP the IAQS filter should be changed after 15 000 km or once per year depending on whichever occurs first. However, up to 75 000 km over 5 years. In cars without CZIP and where the customer does not want to retain the CZIP standard, the IAQS filter must be replaced during a regular service.

For more information on CZIP, see the brochure included with the purchase of the car.

Related information

- General information on climate control (p. 121)
- Air quality (p. 122)



04 Climate control

Air quality - IAQS*

The air quality system IAQS separates gases and particles to reduce the levels of odours and pollution in the passenger compartment.

If the outside air is contaminated then the air intake is closed in order to shut out hydrocarbons, nitrous oxides and ground-level ozone. The air is recirculated in the passenger compartment.

It is possible to activate/deactivate the function in the menu system MY CAR. For a description of the menu system, see MY CAR (p. 108).

NOTE

The air quality sensor must always be enabled to ensure the best air in the passenger compartment.

In a cold climate, automatic recirculation is limited so as to prevent misting.

Related information

- General information on climate control (p. 121)
- Air quality (p. 122)
- Air quality - Clean Zone Interior Package (CZIP)* (p. 123)

Air quality - material

Tested materials have been developed in order to minimise the quantity of dust in the passenger compartment and to contribute to making the passenger compartment easier to keep clean.

The carpets in both the passenger compartment and the cargo area are removable and easy to remove and clean. Use cleaning agents and car care products recommended by Volvo to clean the interior (p. 389).

Related information

- Air quality (p. 122)

Menu settings - climate control

It is possible to activate/deactivate or change the default settings for four of the climate control system's functions via the centre console.

- Fan level during automatic climate control* (p. 130).
- Recirculation timer (p. 133).
- Automatic start of rear window defroster (p. 102).
- Interior air quality system* (p. 124).

The climate control system's functions can be reset to the default settings via the menu system in MY CAR. For a description of the menu system, see MY CAR (p. 108).

Related information

- General information on climate control (p. 121)



Air distribution in the passenger compartment

The incoming air is divided between a number of different vents in the passenger compartment.

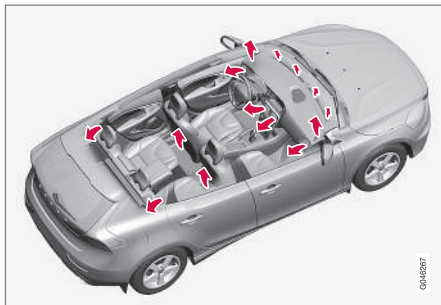

Air distribution is fully automatic in **AUTO** mode*.

If necessary it can be controlled manually; see the air distribution table (p. 134).

Air vents in the dashboard

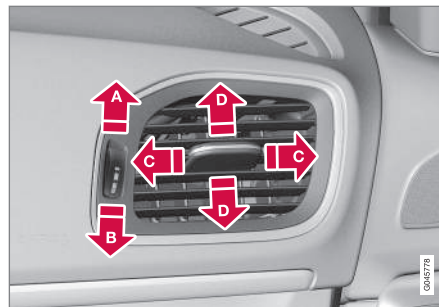

- A** Open
- B** Closed
- C** Lateral airflow
- D** Vertical airflow

Aim the vents at the side windows to remove misting.

i NOTE

Remember that small children may be sensitive to air flows and draughts.

Air distribution

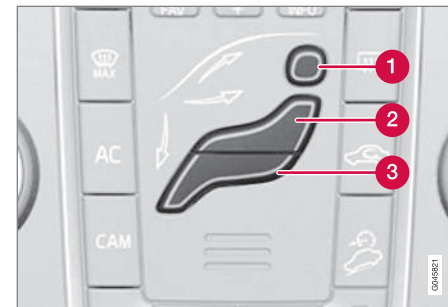

- 1** Air distribution - defroster windscreen
- 2** Air distribution - air vent instrument panel
- 3** Air distribution - ventilation floor

The figure consists of three buttons. When pressing the buttons the corresponding figure is illuminated in the display screen (see figure below) and an arrow in front of each part of the figure shows the air distribution that is selected. For more information, see the air distribution table (p. 134).



04 Climate control

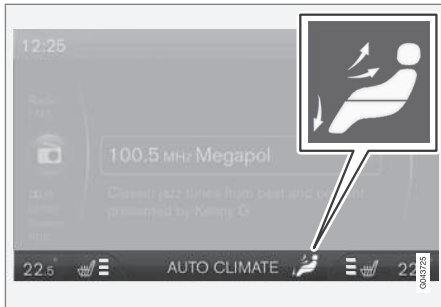

The selected air distribution is shown in the centre console display screen.

Related information

- General information on climate control (p. 121)
- Auto-regulation (p. 130)
- Air distribution - recirculation (p. 133)



Electronic climate control - ECC*

ECC (Electronic Climate Control) maintains the temperature selected in the passenger

compartment and can be set separately for the driver's side and passenger side.

The auto function is used to automatically control temperature, air conditioning, fan speed, recirculation and air distribution.

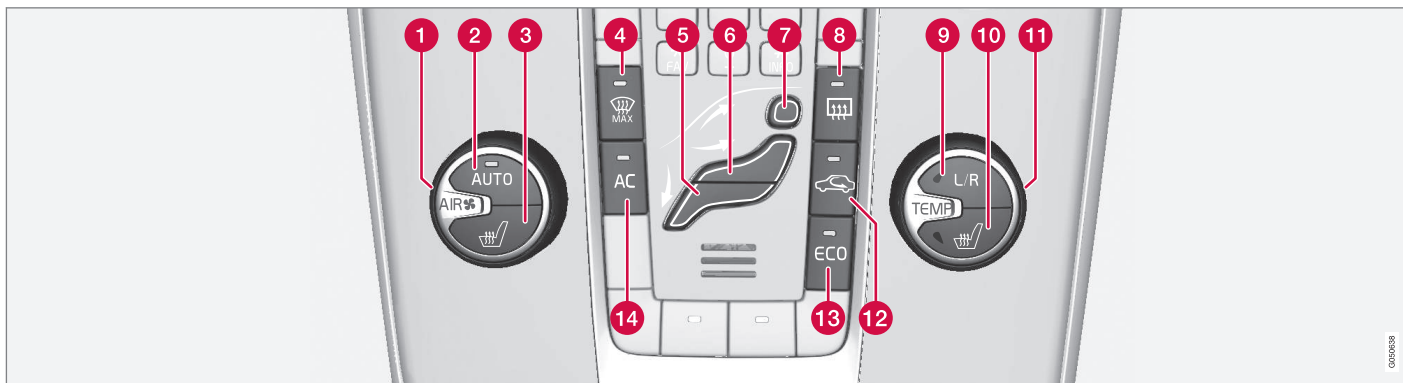

- 1 Fan (p. 130)
- 2 **AUTO** - Automatic climate control (p. 130)
- 3 Electrically heated front seat (p. 129), left side
- 4 Heated windscreen* and max. defroster (p. 132)
- 5 Air distribution (p. 125) - ventilation floor
- 6 Air distribution - air vent instrument panel
- 7 Air distribution - defroster windscreen
- 8 Rear window and door mirror defrosters (p. 102)
- 9 Setting, left/right-hand side for temperature control (p. 131)
- 10 Electrically heated front seat (p. 129), right side
- 11 Temperature control (p. 131)
- 12 Recirculation (p. 133)
- 13 ECO* (p. 285)
- 14 **AC** - Air conditioning on/off (p. 131)

Related information

- General information on climate control (p. 121)



04 Climate control

Electronic temperature control - ETC

The passenger compartment's climate comfort is controlled manually using the ETC (Electronic Temperature Control).

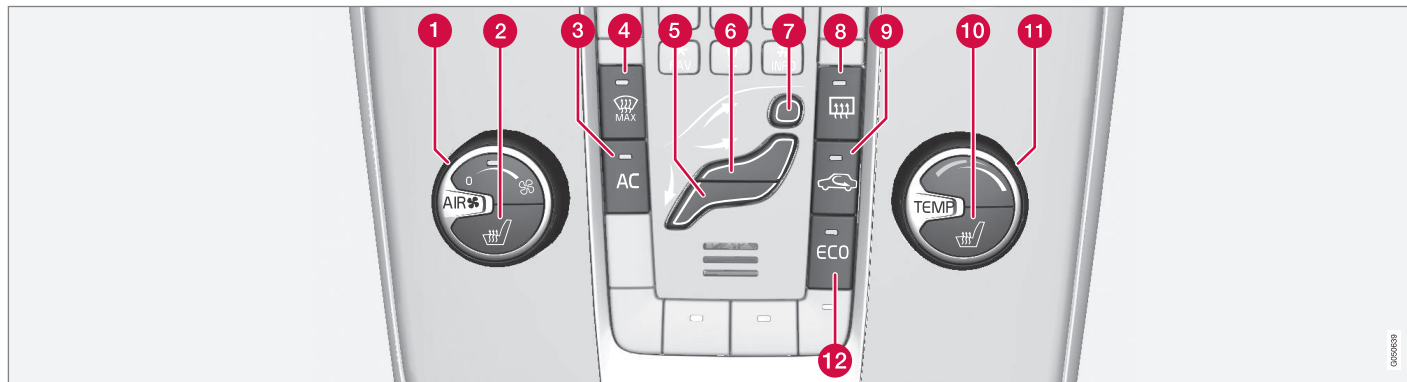

- 1 Fan (p. 130)
- 2 Electrically heated front seat (p. 129), left side
- 3 **AC** - Air conditioning on/off (p. 131)
- 4 Heated windscreen and max. defroster*
- 5 Air distribution (p. 125) - ventilation floor
- 6 Air distribution - air vent instrument panel
- 7 Air distribution - defroster windscreen
- 8 Rear window and door mirror defrosters (p. 102)
- 9 Recirculation (p. 133)
- 10 Electrically heated front seat (p. 129), right side
- 11 Temperature control (p. 131)
- 12 **ECO*** (p. 285)

Related information

- General information on climate control (p. 121)

000009



Heated front seats*

The front seat heating has three positions for increasing the comfort for driver and passenger when it is cold.

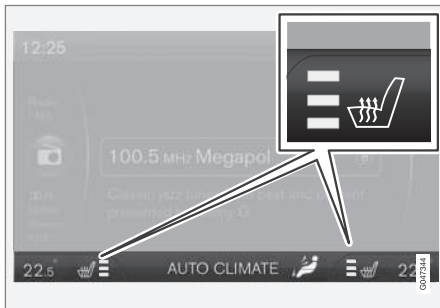

Current heat level is shown in the centre console display screen.



Press the button repeatedly in order to activate the function:

- Highest heat level - three orange fields illuminate in the centre console's screen (see figure above).
- Lower heat level - two orange fields illuminate in the screen.

- Lowest heat level - one orange field illuminates in the screen.
- Switch off the heat - no field illuminates.

WARNING

Heated seats must not be used by people who find it difficult to perceive an increase in temperature due to a lack of sensation or who otherwise have problems operating the controls for the heated seats. Otherwise they may suffer burn injuries.

Related information

- General information on climate control (p. 121)
- Heated rear seat* (p. 129)

Heated rear seat*

The heating for the rear seat's outer positions has three positions for increasing the comfort for passengers when it is cold.



Current heat level is shown in the pushbutton's lamps:

Press the button repeatedly in order to activate the function:

- Highest heat level - three lamps illuminate.
- Lower heat level - two lamps illuminate.
- Lowest heat level - one lamp illuminates.
- Switch off the heat - no lamp illuminates.



04 Climate control



! WARNING

Heated seats must not be used by people who find it difficult to perceive an increase in temperature due to a lack of sensation or who otherwise have problems operating the controls for the heated seats. Otherwise they may suffer burn injuries.

Related information

- General information on climate control (p. 121)
- Heated front seats* (p. 129)

Fan

The fan should always be activated in order to avoid misting on the windows.

i NOTE

If the fan is fully switched off then the air conditioning is not engaged - which can cause a risk of misting on the windows.

ECC*



Turn the knob to increase or decrease fan speed, **AUTO** is disengaged. If **AUTO** is selected, then the fan speed is regulated automatically (p. 130) - the fan speed previously set is disengaged.

ETC



Turn the knob to increase or decrease fan speed.

Related information

- General information on climate control (p. 121)
- Electronic climate control - ECC* (p. 127)
- Electronic temperature control - ETC (p. 128)

Auto-regulation

Auto-regulation is only possible in electronic climate control (ECC) (p. 127).



The auto function automatically regulates temperature (p. 131), air conditioning (p. 131), fan speed (p. 130), recirculation (p. 133) and air distribution (p. 125).

If you select one or more manual functions, the other functions continue to be controlled automatically. All manual settings are disengaged when **AUTO** is pressed. The display screen shows **AUTO CLIMATE**.

Fan speed in automatic mode can be set in the menu system MY CAR. For a description of the menu system, see MY CAR (p. 108).

Related information

- General information on climate control (p. 121)



Temperature control in the passenger compartment

When the car is started, the most recent temperature setting is resumed.

NOTE

Heating or cooling cannot be hastened by selecting a higher or lower temperature than the actual desired temperature.

ECC*

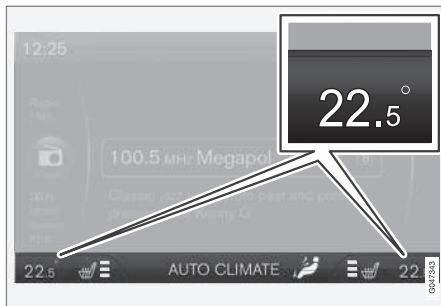

Current temperature for each side is shown in the centre console's display screen.



The temperatures on the driver and passenger sides can be set independently. Repeatedly press **L/R** in the button to select the setting for left, right or both sides. Set the temperature using

the knob - the selected temperature for either side is displayed in the centre console display.

ETC



The temperature in the passenger compartment can be adjusted with the knob.

Related information

- General information on climate control (p. 121)
- Actual temperature (p. 122)
- Electronic temperature control - ETC (p. 128)
- Electronic climate control - ECC* (p. 127)

Air conditioning

The air conditioning cools and dehumidifies incoming air as required.



When the lamp in the **AC** button illuminates, the air conditioning is controlled by the system's automatic function.

When the lamp in the **AC** button is switched off the air conditioning is disconnected. Other functions are still controlled automatically. When the max. defroster function (p. 132) is activated, the air conditioning is switched on automatically so that the air is dehumidified at the maximum setting.



04 Climate control

Demisting and defrosting the windscreen

Heated windscreen* and max. defroster are used to quickly remove misting and ice from the windscreen and side windows.



The selected setting is shown in the centre console display screen.

- 1 Heated windscreen*
- 2 Max. defroster



The light in the defroster button illuminates when the function is active.

Press the button repeatedly in order to activate the function.

For cars without heated windscreens:

- Air flows to the windows - symbol (2) illuminates in the screen.
- Switch off the function - no symbol illuminates.

For cars with heated windscreens:

- Start the heating for the windscreen² - symbol (1) illuminates in the screen.
- Start the heating for the windscreen² and air flow to the windows - symbols (1) and (2) illuminate in the screen.
- Switch off the function - no symbol illuminates.

i NOTE

Heated windscreen and IR window (p. 19) may have an impact on the performance of transponders and other communication equipment.

i NOTE

A triangular area at the end of each side of the windscreen is not electrically heated, where de-icing may take longer.

i NOTE

Electrically heated windscreen is not available when the engine is auto-stopped (p. 276).

The following also takes place when the function is active in order to provide maximum dehumidification in the passenger compartment:

- the air conditioning is automatically engaged
- recirculation and the air quality system are automatically disengaged.

i NOTE

The noise level increases as the fan is operating at max.

When the defroster is switched off the climate control returns to the previous settings.

Related information

- General information on climate control (p. 121)

² The compass goes off when the heated windscreen is active.



Air distribution - recirculation

Select recirculation to shut out bad air, exhaust gases etc. from the passenger compartment, i.e. no outside air is taken into the car when this function is activated.



When recirculation is engaged the orange lamp in the button illuminates.

IMPORTANT

If the air in the car recirculates for too long, there is a risk of misting on the insides of the windows.

Timer

With the timer function activated the system will exit manually activated recirculation mode according to a time that depends on the outside temperature. This reduces the risk of ice, misting and bad air.

It is possible to activate/deactivate the function in the menu system MY CAR. For a description of the menu system, see MY CAR (p. 108).

NOTE

When max. defroster is selected, recirculation is always deactivated.

Related information





- General information on climate control (p. 121)
- Air distribution in the passenger compartment (p. 125)
- Air distribution - table (p. 134)



04 Climate control





Air distribution - table

Three buttons are used to select the distribution (p. 125) of the air.

	Air distribution	Use
	A large amount of hot air flows to the windows.	to remove ice and misting quickly.
	Air to windscreen, via defroster vent, and side windows. Some air flows from the air vents.	to prevent misting and icing in a cold and humid climate, (not at too low fan speed to enable this).
	Airflow to windows and from dashboard air vents.	to ensure good comfort in warm, dry weather.
	Airflow to the head and chest from the dashboard air vents.	to ensure efficient cooling in warm weather.

04



	Air distribution	Use
	Air to the floor and windows. Some air flows from the dashboard air vents.	to ensure comfortable conditions and good demisting in cold or humid weather.
	Air to floor and from dashboard air vents.	in sunny weather with cool outside temperatures.
	Air to floor. Some air flows to the dashboard air vents and windows.	to direct heat or cold to the floor.
	Airflow to windows, from dashboard air vents and to the floor.	to provide cooling along the floor in hot, dry weather or warming upwards in cold weather.

Related information

- General information on climate control (p. 121)
- Air distribution - recirculation (p. 133)



04 Climate control

Engine block heater and passenger compartment heater*

Preconditioning prepares the heater, engine and passenger compartment before departure so that both wear and energy needs during the journey are reduced. Warming up your car will also extend the driving distance.

The heater can be started directly (p. 137) or with a timer (p. 138).

The heater cannot start if the outside temperature exceeds 15 °C. At -5 °C or lower the maximum running time of the heater is 50 minutes.

WARNING

Do not use the fuel-driven heater indoors. Exhaust gases are secreted.

NOTE

When the fuel-driven auxiliary heater is active there may be smoke from underneath the car, which is perfectly normal.

Refuelling

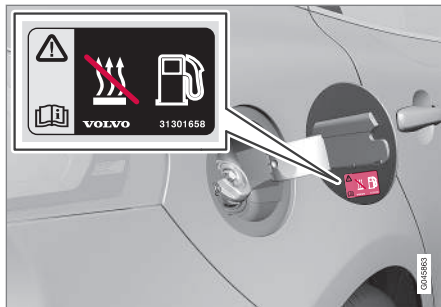

Warning label on fuel filler flap.

WARNING

Fuel which spills out could be ignited. Switch off the fuel-driven auxiliary heater before starting to refuel.

Check in the combined instrument panel that the heater is switched off. The heat symbol is shown when it is operating.

Parking on a hill

If the car is parked on a steep hill, the front of the car should point downhill to ensure that there is a supply of fuel to the fuel-driven heater.

Battery and fuel

If the battery has insufficient charge or the fuel level is too low, the heater will be switched off automatically and a message

appears in the display. Acknowledge the message by pressing the indicator stalk (p. 105) **OK** button once.

IMPORTANT

Repeated use of the heater in combination with short driving distances may cause low charge level in the starter battery, this can lead to the heater stopping or never starting. In the worst case, engine starting will not be possible.

The car should be driven for the same time as the heater is used to ensure that the starter battery is recharged adequately to replace the energy consumed by the heater when it is used on a regular basis. The heater is used for a maximum of 50 minutes each time.

Related information

- Engine block heater and passenger compartment heater* - messages (p. 139)
- Additional heater* (p. 140)



Engine block heater and passenger compartment heater* - direct start

The engine block heater and passenger compartment heater can be started directly.

Direct start can be performed via:

- information display
- remote control key*
- mobile*.

Upon direct start of the engine block and passenger compartment heater (p. 136), it will run for 50 minutes.

Heating of the passenger compartment will begin as soon as the engine coolant has reached the correct temperature.

i NOTE

The car can be started and driven while the heater is running.

Direct start via the information display

1. Press **OK** to access the menu.
2. Scroll with the thumbwheel to **Parking heater** and select with **OK**.
3. Scroll forward in the next menu to **Direct start** in order to activate the heater and select with **OK**.
4. Exit the menu with **RESET**.

Direct start via the remote control key*

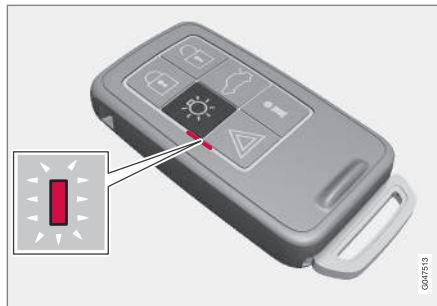

Indicator lamp on remote control key with PCC*.

The engine block heater and passenger compartment heater can be activated via the remote control key:

- Hold the button for approach lighting  depressed for 2 seconds.
 - Hazard warning flashers provide information in accordance with the following:
 - 5 short flashes followed by a constant glow for approx. 3 seconds - the signal has reached the car and the heater has been activated.
 - 5 short flashes - the signal has reached the car but the heater has not been activated.
 - Hazard warning flashers remain switched off - the signal has not reached the car.

If the button for information  is depressed when the heater is active then the indicator lamp will show the status for this - at the same time the car's lock status (p. 162) is shown. While the status is being investigated the indicator lamp emits a pair of short flashes followed by a constant glow if the heater is active.

Status is also shown in the trip computer during heating.

Direct start via a mobile*

Activation and information about the selected settings that can be managed from a mobile phone will be available via the Volvo On Call* mobile app.

Related information

- Engine block heater and passenger compartment heater* - timer (p. 138)
- Engine block heater and passenger compartment heater* - immediate stop (p. 138)
- Engine block heater and passenger compartment heater* - messages (p. 139)



Engine block heater and passenger compartment heater* - immediate stop

The engine block heater and passenger compartment heater can be deactivated directly via the information display.

1. Press **OK** to access the menu.
2. Scroll with the thumbwheel to **Parking heater** and select with **OK**.
3. Scroll forward in the next menu to **Stop** in order to deactivate the heater and select with **OK**.
4. Exit the menu with **RESET**.

Related information

- Engine block heater and passenger compartment heater* - direct start (p. 137)
- Engine block heater and passenger compartment heater* - timer (p. 138)
- Engine block heater and passenger compartment heater* - messages (p. 139)

Engine block heater and passenger compartment heater* - timer

The timer of the engine block and passenger compartment heater (p. 136) is connected to the car's clock.

Two different times can be selected using the timer. Here, time refers to the time when the car is heated and ready. The car's electronic system calculates when heating should be started based on the outside temperature.

NOTE

All timer programming will be cleared if the car's clock is reset.

Adjusting

1. Press **OK** to access the menu.
2. Scroll with the thumbwheel (p. 105) to **Parking heater** and select with **OK**.
3. Select one of the two timers using the thumbwheel and confirm with **OK**.
4. Briefly press **OK** to move to the lit hours setting.
5. Select the required hour using the thumbwheel.
6. Briefly press **OK** to move to the lit minutes setting.

7. Select the required minute using the thumbwheel.
8. Press **OK**³ to confirm the setting.
9. Go back in the menu structure using **RESET**.
10. Select the other time (continue from step 2) or exit the menu with **RESET**.

Starting

1. Press **OK** to access the menu.
2. Scroll with the thumbwheel to **Parking heater** and select with **OK**.
3. Select one of the two timers using the thumbwheel and activate with **OK**.
4. Exit the menu with **RESET**.

Switching off

A timer-started heater can be switched off manually before the set time has elapsed. Proceed as follows:

1. Press **OK** to access the menu.
2. Scroll with the thumbwheel to **Parking heater** and select with **OK**.
 - > If a timer is set but not activated, a clock icon is shown next to the set time.
3. Select one of the two timers using the thumbwheel and confirm with **OK**.

³ Press **OK** again to activate the timer.

* Option/accessory, for more information, see Introduction.



4. Deactivate the timer as follows:

- long press on **OK** or
- short press on **OK** to continue in the menu. Then select to stop the timer and confirm with **OK**.

5. Exit the menu with **RESET**.

A timer-started heater can be switched off directly (p. 137).

Related information

- Engine block heater and passenger compartment heater* - messages (p. 139)

Engine block heater and passenger compartment heater* - messages

Symbols and messages regarding the engine block and passenger compartment heater (p. 136) differ depending on whether the combined instrument panel is analogue (p. 61) or digital (p. 62).



When the heater has been activated the heat symbol illuminates in the information display.

When one of the timers is activated the symbol for activated timer illuminates in the information display at the same time as the set time is shown next to the symbol.



Symbol for activated timer in analogue combined instrument panel.



Symbol for activated timer in digital combined instrument panel.



The table shows symbols and display texts that appear.

Symbol	Message	Specification
		<p>The heater is switched on and running.</p> <p>The heater's timer is activated after the remote control key has been removed from the ignition switch and leaving the car - the engine and passenger compartment are heated at the set time.</p>
 	<p>Fuel operated heater stopped Battery saving mode</p>	<p>The heater has been stopped by the car's electronics in order to facilitate starting the engine.</p>



04 Climate control



Sym- bol	Mes- sage	Specification
 	Fuel operated heater stopped Low fuel level	Setting the heater is not possible due to fuel level being too low - this is in order to facilitate starting the engine as well as approx. 50 km driving.
	Fuel operated heater Service required	Heater not working. Contact a workshop for repair. Volvo recommends that you contact an authorised Volvo workshop.

A display text clears automatically after a time or after one press on the indicator stalk (p. 105) **OK** button.

Related information

- Engine block heater and passenger compartment heater* - direct start (p. 137)
- Engine block heater and passenger compartment heater* - timer (p. 138)

Additional heater*

For cars with diesel engines sold in cold climate zones⁴ an additional heater may be required to obtain the correct operating temperature in the engine and to obtain sufficient heating in the passenger compartment.

In such instances, the car is equipped with either

- electric additional heater (p. 141) or
- fuel-driven additional heater (p. 140)⁵.

Related information

- Engine block heater and passenger compartment heater* (p. 136)

Fuel-driven additional heater*

The car is equipped with either an electric (p. 141) or a fuel-driven additional heater (p. 140).

The heater starts automatically when extra heat is required when the engine is running.

The heater is switched off automatically when the correct temperature is reached or when the engine is switched off.



NOTE

When the auxiliary heater is active there may be smoke from underneath the car, which is perfectly normal.

Auto mode or shutdown

The additional heater's automatic start sequence can be switched off if required.



NOTE

Volvo recommends that the fuel-driven additional heater should be switched off for short distances.

1. Before starting the engine: Select key position **I** (p. 76).
2. Press **OK** to access the menu.

⁴ An authorised Volvo dealer has information regarding the geographical areas concerned.

⁵ For cars equipped with parking heater (p. 136).



3. Scroll with the thumbwheel to **Additional heater**⁶ or **Settings**⁷ and select with **OK**.
4. Select one of the options **ON** or **OFF** using the thumbwheel and confirm with **OK**.
5. Exit the menu with **RESET**.

i NOTE

The menu options are only visible in key position I - any adjustments must therefore be made before starting the engine.

Related information

- Engine block heater and passenger compartment heater* (p. 136)

Electric additional heater*

The car is equipped with either a fuel-driven (p. 140) or an electric additional heater (p. 140).

The heater cannot be controlled manually but is instead activated automatically after the engine has been started in outside temperatures below 9 °C and is switched off after the set passenger compartment temperature has been reached.

Related information

- Engine block heater and passenger compartment heater* (p. 136)

⁶ Analogue combined instrument panel.

⁷ Digital combined instrument panel.

05



LOADING AND STORAGE

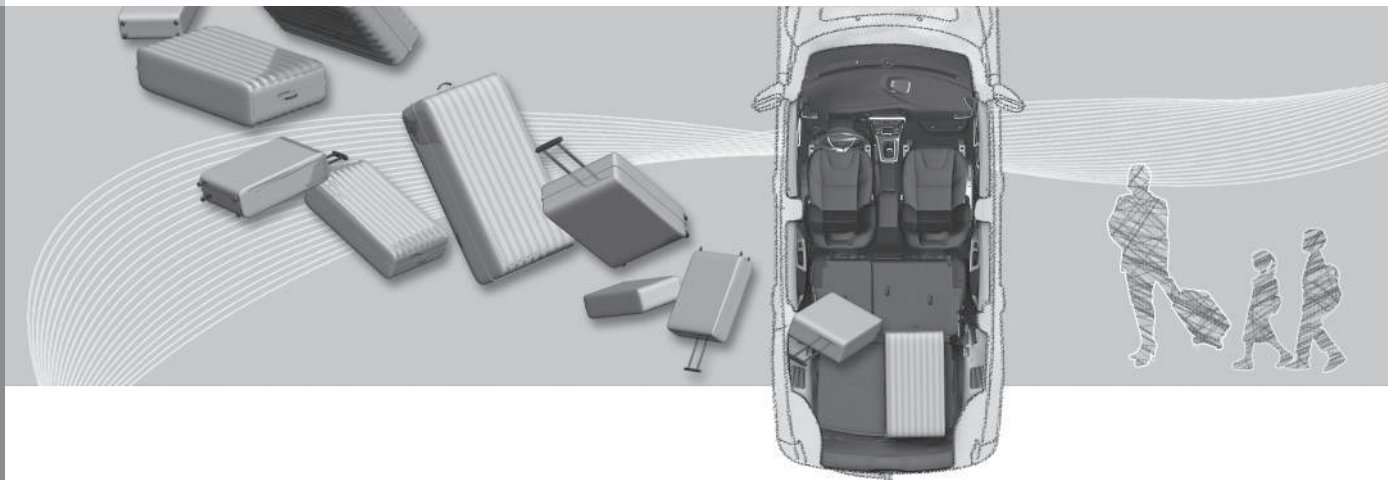



Storage spaces

Overview of storage spaces in the passenger compartment.

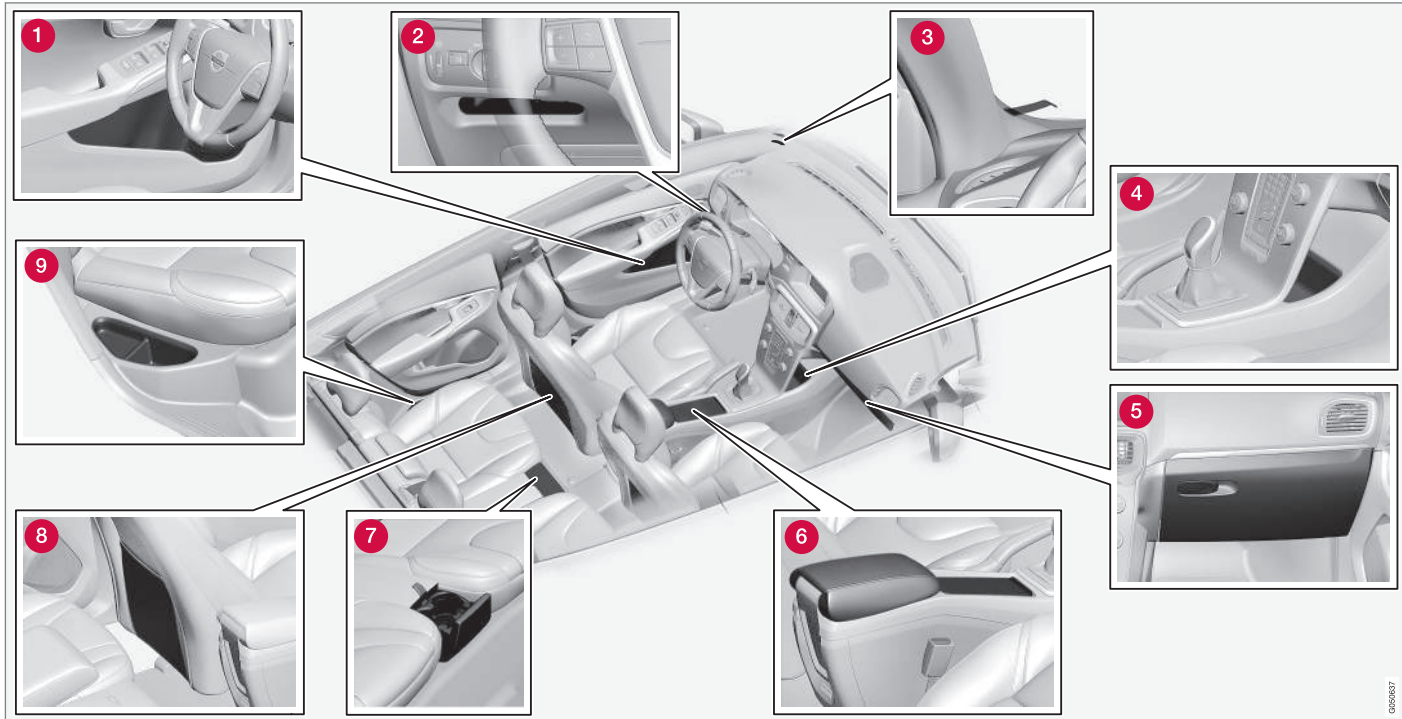



05 Loading and storage



- 1 Storage compartment¹ in door panel
- 2 Storage compartment, driver's side
(p. 145)
- 3 Ticket clip
- 4 Storage compartment
- 5 Glovebox (p. 146)
- 6 Storage compartment, cup holder
(p. 145)
- 7 Cup holder* in rear seat
- 8 Storage pocket²
- 9 Storage compartment, rear seat



WARNING

Keep loose objects such as mobile phones, cameras, remote controls for accessories, etc. in the glove compartment or other compartments. Otherwise they may injure people in the car in the event of sudden braking or a collision.

¹ With ice scraper holder on the driver's side.

² Not applicable to textile upholstery.



Storage compartment driver's side

This storage compartment (p. 143) is located on the driver's side, to the left under the lighting panel.

WARNING

Do not keep any sharp objects in the compartment, or objects which protrude.

Tunnel console

The tunnel console is located between the front seats.

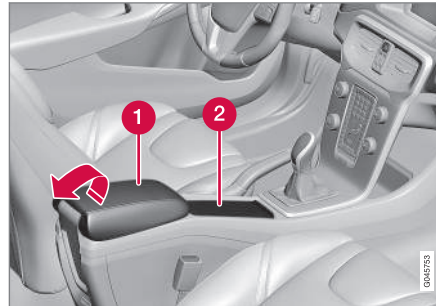

- 1 Storage compartment (e.g. for CDs) and USB*/AUX input under the armrest.
- 2 Includes cup holder for driver and passenger. (If ashtray and cigarette lighter (p. 146) are specified, then there is a cigarette lighter in the 12 V socket (p. 147) for the front seat and a detachable ashtray in the cup holder.)

Related information

- Storage spaces (p. 143)
- Tunnel console - armrest (p. 145)

Tunnel console - armrest

The tunnel console is located between the front seats.

When closed, the tunnel console's armrest can be adjusted* longitudinally.

Related information

- Tunnel console - 12 V-sockets (p. 147)
- Tunnel console - cigarette lighter and ashtray* (p. 146)



Tunnel console - cigarette lighter and ashtray*

A detachable ashtray is fitted in the cup holder under the armrest. The cigarette lighter is fitted in the 12 V socket (p. 147) for the front seat.

The ashtray in the tunnel console (p. 145) is detached by lifting the tray straight up.

Activate the lighter by pushing in the button. The button pops out when the lighter is hot. Pull out the lighter and light a cigarette on the heated coils.

Related information

- Storage spaces (p. 143)

Glovebox

The glovebox is located on the passenger side.

The owner's manual and maps can be kept in here for example. There are also holders for pens on the inside of the lid. The glovebox can be locked* (p. 173), using the key blade (p. 164).

Related information

- Storage spaces (p. 143)
- Glovebox - cooling (p. 146)

Glovebox - cooling

Glovebox (p. 146) can also be used as a cooled area³.

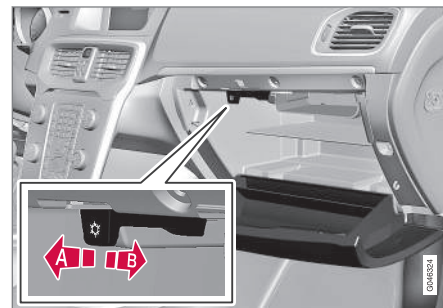

- A** Start cooling by moving the control towards the passenger compartment to the end position.
- B** Switch off the cooling by moving the control forwards to the end position.

Cooling is active when the climate control system is active (i.e. in key position **II** (p. 76)) or when the engine is running.

³ Applicable only to cars with ECC.



Inlay mats*

Inlay mats collect e.g. rubbish and slush. Volvo supplies specially manufactured inlay mats.

! WARNING

Only use one inlaid mat at each seat, and check before setting off that the mat by the driver's seat is firmly affixed and secured in the pins so that it does not get caught adjacent to and under the pedals.

Related information

- Cleaning the interior (p. 389)

Vanity mirror

The vanity mirror is located on the rear of the sun visor.

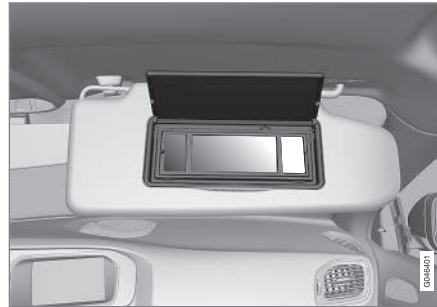

Vanity mirror with lighting.

The light illuminates automatically when the cover is lifted.

Related information

- Lamp replacement - vanity mirror lighting (p. 366)

Tunnel console - 12 V-sockets

The electrical sockets (12 V) are located in the tunnel console's storage compartment and beside the cup holder⁴.

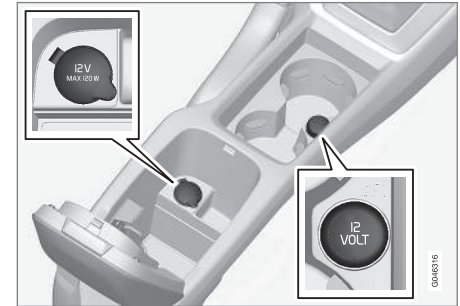

12 V socket in tunnel console, front seat.

The electrical sockets can be used for various accessories designed for 12 V, e.g. display screens, music players and mobile phones. For the sockets to supply current, the remote control key must be in at least key position I (p. 76).

! WARNING

Always leave the plug in the socket when the socket is not in use.

⁴ If ashtray and cigarette lighter are specified then there is no cup holder and adjacent 12 V socket.



NOTE

Optional equipment and accessories - e.g. display screens, music players and mobile phones - which are connected to one of the passenger compartment's 12V electrical sockets could be activated by the climate control system, even when the remote control key has been removed or when the car is locked, for example, when the engine block and passenger compartment heater* is activated at a preset time.

For this reason remove the plugs from the electrical sockets for optional equipment or accessories when not in use because the battery could be drained in the event of such an occurrence!

IMPORTANT

Max. power takeoff is 10 A (120 W) in either socket.

NOTE

The compressor for emergency puncture repair (p. 333) has been tested and approved by Volvo. For information on the use of Volvo's recommended temporary emergency puncture repair (TMK).

Related information

- Tunnel console - cigarette lighter and ashtray* (p. 146)
- 12 V socket - cargo area (p. 151)

Loading

Payload depends on the car's kerb weight.

Payload depends on the car's kerb weight. The total of the weight of the passengers and all accessories reduces the car's payload by a corresponding weight.

For more detailed information on weights, see Weights (p. 396).



The tailgate is opened via a button on the lighting panel or the remote control key, see Locking/unlocking - tailgate (p. 173).

WARNING

The car's driving properties change depending on the weight and positioning of the load.

To bear in mind when loading

- Position the load firmly against the rear seat's backrest.

Note that objects must not prevent the function of the WHIPS system for the front seats if any of the rear seat's backrests is folded down, see WHIPS - seating position (p. 38).

- Centre the load.
- Heavy objects should be placed as low as possible. Avoid placing heavy loads on lowered backrests.

- Cover sharp edges with something soft to avoid damaging the upholstery.
- Secure all loads to the load retaining eye-lets with straps or web lashings.

WARNING

A loose object weighing 20 kg can, in a frontal collision at a speed of 50 km/h, carry the impact of an item weighing 1000 kg.

WARNING

The protection provided by the inflatable curtain in the headlining may be compromised or eliminated by high loads.

- Never load cargo above the backrest.

WARNING

Always secure the load. Always secure the load. During heavy braking the load may otherwise shift, causing personal injury to the car's occupants.

Cover sharp edges and sharp corners with something soft.

Switch off the engine and apply the parking brake when loading/unloading long items. Otherwise you may accidentally knock the gear lever or gear selector with the load into a drive position - and the car could then move off.



Related information

- Load retaining eyelets (p. 150)
- Cargo net (p. 152)
- Loading - long load (p. 149)
- Roof load (p. 149)

Loading - long load

To simplify loading in the cargo area, the rear seat backrest can be folded down. The passenger seat backrest can also be folded for an extra long load.

Folding the passenger seat

See (p. 78).

Lowering the rear seat backrest

See (p. 81).

Related information

- Loading (p. 148)

Roof load

The load carriers recommended for roof loads are the ones developed by Volvo. This is in order to avoid damage to the car and in order to achieve the maximum possible safety during a journey.

Carefully follow the installation instructions supplied with the carriers.

- Load carriers must always be mounted on the aluminium rail.
- Check periodically that the load carriers and load are properly secured. Lash the load securely with retaining straps.
- Distribute the load evenly over the load carriers. Put the heaviest objects at the bottom.
- The size of the area exposed to the wind, and therefore fuel consumption, increase with the size of the load.
- Drive gently. Avoid quick acceleration, heavy braking and hard cornering.



WARNING

The car's centre of gravity and driving characteristics are altered by roof loads.

For information about the maximum permitted load on the roof, including load carriers and any space box, see Weights (p. 396).

Related information

- Loading (p. 148)



Load retaining eyelets

The load retaining eyelets are used to fasten straps in order to anchor items in the cargo area.

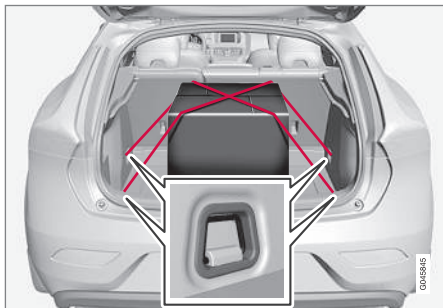

WARNING

Hard, sharp and/or heavy objects which protrude may cause injury under violent braking.

Always secure large and heavy objects with a seatbelt or cargo retaining straps.

Related information

- Loading (p. 148)

Loading - bag holder

The bag holders keep carrier bags in place and prevent them from overturning and spreading their contents around the cargo area. The holder has a capacity of max. 3 kg.

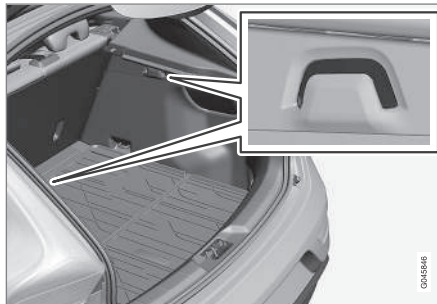

Bag holder

Related information

- Loading (p. 148)
- Loading - folding bag holder* (p. 150)

Loading - folding bag holder*

A folding bag holder in the floor keeps bags in place and prevents them from overturning and spreading their contents in the cargo area, and can be opened up in three positions.



Folding bag holder

It can be set to two adjustment positions and one service position, as it is known, where it is fully unfolded. There are also two floor combination variants, one with adjustment positions in a tub under the floor and one with adjustment positions in plastic rails. The raising below shows the adjustment position in a tub under the floor.

The load on the central holder is max. 3 kg and max. 10 kg on the outer holder.



Folding up



- 1 Lift the handle* on the upper floor and fold up the floor.
- 2 Move the floor forwards to an appropriate position and place it in the adjustment groove.
3. In service position, the floor is moved all the way forwards towards the rear seat back and placed in the plastic support in the centre.

Related information

- Loading (p. 148)
- Loading - bag holder (p. 150)

12 V socket - cargo area

The electrical socket can be used for various accessories designed for 12 Volts, e.g. display screens, music players and mobile phones.

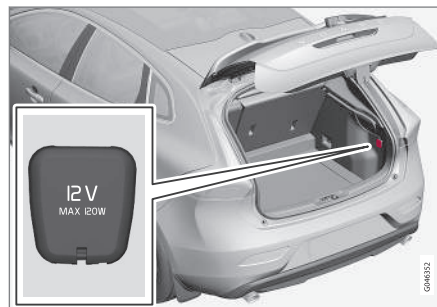

Lower the cover to access the electrical socket.

- The socket also provides voltage when the remote control key is not in the ignition switch.

IMPORTANT

Max. socket current is 10 A (120 W).

NOTE

Remember that using the electrical socket with the engine switched off involves the risk of discharging the car's battery.

NOTE

The compressor for temporary emergency puncture repair has been tested and approved by Volvo. For information on the use of Volvo's recommended temporary emergency puncture repair (TMK), see Emergency puncture repair* (p. 333).

Related information

- Tunnel console - 12 V-sockets (p. 147)



Cargo net

A cargo net prevents cargo from being thrown forward in the passenger compartment in the event of heavy braking.



The cargo net is fitted into four mounting points.

For safety reasons, the cargo net must always be correctly fastened and secured. The mesh is made of a strong nylon fabric and secured behind the front seat backrests.

WARNING

Loads in the luggage compartment must be anchored well, and also have a correctly fitted safety net.

Attaching

NOTE

The easiest way to fit the safety net is via one of the rear doors.

WARNING

It is necessary to ensure that the upper securing points of the safety net are fitted correctly and that the puller-straps are secured properly. Damaged nets must not be used.

1. Unfold the cargo net and make sure that the split upper rod is locked in the extended position.
2. Hook one end of the rod into the roof mounting with the anchoring strap locks turned towards you.

3. Hook the other end of the rod into the roof mounting on the opposite side - the telescopic spring-loaded retaining hooks facilitate alignment. Take care to press forward the rod's retaining hooks for each respective roof mounting's front end position.

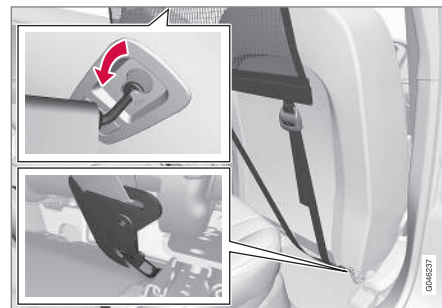



- Hook the cargo net's anchoring straps into the eyes on the rear of the seat slide rails - it is easier if the backrests are straightened and the seats are moved forward slightly.

Pay attention to make sure that you do not press the seat/backrest hard against the net when the seat/backrest is moved back again - only adjust until the seat/backrest makes contact with the net.

! IMPORTANT

If a seat/backrest is pushed backwards hard into the safety net then the net and/or its roof mounts may be damaged.

- Tension the cargo net with the anchoring straps.

Removal and storage

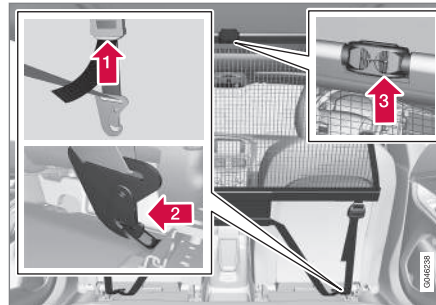

The cargo net can be easily removed and folded up.

- Release the tension in the net by pressing in the button on the anchoring strap's lock and feeding out part of the strap.
- Press in the catch and detach both of the anchoring strap's hooks.
- Unhook the rod from its roof mounting by pulling back on the rod in the roof mountings' rear end position. Press the rod in any direction so that the hook engages in the rod, which at the same time releases the hook on the other side.

Finally, remove the remaining roof mounting hook from the roof mounting.

- Break the rod in the centre, fold it together and roll up the net.
Insert the net in the storage bag.

The folded cargo net is stored in its bag in the cargo area.



Related information

- Loading (p. 148)
- Load retaining eyelets (p. 150)



Hat shelf

The hat shelf can be removed to provide additional cargo space.

Hat shelf removal

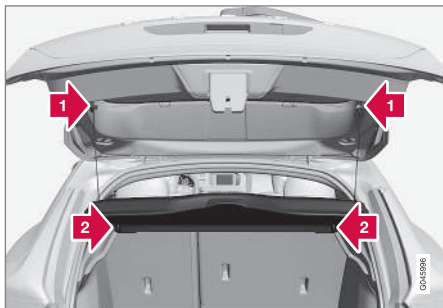

- 1** Undo the hat shelf lifting eyes on both sides.
- 2** Unhook the front edge of the hat shelf and remove it.

Related information

- Loading (p. 148)
- Loading - long load (p. 149)

06

LOCKS AND ALARM





Remote control key

Amongst other things, the remote control key is used for locking/unlocking and starting the engine.

There are three variants of key available - Remote control key in basic version, Remote control key without PCC* and Remote control key with PCC*.

Functionality	Basic ^A	without PCC ^A	with PCC ^B
Locking/unlocking and detachable key blade	x	x	x
Keyless locking/unlocking		x	x
Keyless engine starting		x	x
Information button and indicator lamps			x

A 5-button key

B 6-button key

More information

- Remote Control Key Basic - is a key in the basic version, see Remote control key - functions (p. 160) for a description of its functions.
- Remote control key without PCC - with Keyless Drive* (p. 166) and keyless locking (p. 168) and unlocking (p. 168).
- Remote control key with PCC - also has an information button and indicator lamps. Read more about these unique functions (p. 162).

All remote control keys have a detachable key blade (p. 163) made of metal. The visible section is available in two versions so that it is possible to distinguish between the remote control keys.

More remote control keys can be ordered - but not variants other than the one supplied with the car. Up to six keys can be programmed and used for one single car.

The car is supplied with two remote control keys.



WARNING

If there are children in the car:

Remember to switch off the supply to the power windows by removing the remote control key if the driver leaves the car.

Remote control key - losing

If you lose a remote control key (p. 156) then a new one can be ordered at a workshop - an authorised Volvo workshop is recommended.

The remaining remote control keys must be taken to the Volvo workshop. The code of the missing remote control key must be erased from the system as a theft prevention measure. The current number of keys registered to the car can be checked in the menu system MY CAR. For a description of the menu system, see MY CAR (p. 108).

Related information

- Remote control key - functions (p. 160)
- Remote control key - range (p. 161)



Remote control key - personalisation*

The key memory in the remote control key means that certain settings in the car can be individually adapted for different people.

The key memory function is available in combination with power* driver's seat (p. 79).

Settings for door mirrors (p. 101), driver's seat, steering force (p. 258) and the combined instrument panel's theme, contrast and colour mode (p. 62) can be stored in the key memory, depending on the car's equipment level.

The function¹ can be activated/deactivated in the menu system MY CAR. For a description of the menu system, see MY CAR (p. 108).

When the function is activated, the settings are automatically linked to the key memory. This means that a change in a setting will automatically be saved in the specific remote control key's memory.

Storing settings

Make sure that the key memory function is activated in the menu system MY CAR.

Proceed as follows in order to store the settings and use the key memory in the remote control key:

1. Unlock the car with the remote control key in whose memory the setting² shall be stored.
2. Make the desired settings for e.g. the seat and the door mirrors.
3. The settings are stored in the current remote control key's memory.

The next time the car is unlocked with the same remote control key, the positions that are stored in the key memory will be set automatically - providing that they have been changed since the last time the current remote control key was used.

Emergency stop

If the seat accidentally begins to move, press one of the setting buttons for the seat or memory buttons in order to stop the seat.

Restarting to reach the seat position stored in the key memory is performed by pressing the unlock button on the remote control key. The driver's door must then be open.



WARNING

Risk of crushing! Make sure that children do not play with the controls. Check that there are no objects in front of, behind or under the seat during adjustment. Ensure that none of the rear seat passengers is in danger of becoming trapped.

Changing settings

If several people each with a remote control key approach the car, then the settings for e.g. seat and door mirrors are implemented for the person whose remote control key unlocks the driver's door.

If the driver's door has been opened by person A with remote control key A, but person B with remote control key B shall drive, then the settings can be changed as follows:

- Standing by the driver's door, or sitting behind the steering wheel, person B presses the button for unlocking on his/her remote control key.
- Select one of three possible memories for seat adjustment with seat button 1-3.
- Adjust the seat and door mirrors manually.

¹ Known as Car key memory in MY CAR.

² This setting does not affect settings that have been stored in the power seat's memory function.



Related information

- Remote control key - functions (p. 160)
- Remote control key with PCC* - unique functions (p. 162)

Locking/unlocking - indicator

When the car is locked or unlocked using the remote control key (p. 156) the direction indicators confirm that locking/unlocking was correctly performed.

- Locking - one flash and the door mirrors are folded³ in.
- Unlocking - two flashes and the door mirrors are folded³ out.

NOTE

Be aware of the risk of locking the remote control key in the car.

When locking, indication is given only if all locks have been locked and all doors are closed. Indication is given when the last door has been closed.

Selecting the function

Different options for indicating locking/unlocking with light can be set in the menu system MY CAR. For a description of the menu system, see MY CAR (p. 108).

Related information

- Keyless drive* (p. 166)
- Lock indicator (p. 158)
- Alarm indicator (p. 179)

Lock indicator

A flashing LED by the windscreen verifies that the car is locked.



Same LED as alarm indicator (p. 179).

NOTE

Cars that are not equipped with alarm also have this indicator.

Related information

- Locking/unlocking - indicator (p. 158)

³ Only for cars with retractable power door mirrors.

* Option/accessory, for more information, see Introduction.



Remote control key - electronic immobiliser

The electronic immobiliser is a theft protection system that prevents the vehicle from being started (p. 265) by an unauthorised person.

Each remote control key (p. 156) has a unique code. The car can only be started with the correct remote control key with the correct code.

The following error messages in the combined instrument panel's information display are related to the electronic immobiliser:

Message	Specification
Insert car key	Error when reading the remote control key during starting - Remove the key from the ignition switch, press it in again and make a new start attempt.
Car key not found ^A	Error reading the remote control key during starting - Try to start again. If the error persists: Insert the remote control key into the ignition switch and try to start again.
Immobiliser Try to start again	Error in immobiliser system during starting. If the error persists: Contact a workshop - an authorised Volvo workshop is recommended.

^A Applicable only to cars with the Keyless function

Related information

- Remote-controlled immobiliser with tracking system* (p. 159)
- Keyless drive* (p. 166)

Remote-controlled immobiliser with tracking system*

Remote-controlled immobiliser with tracking system⁴ makes it possible to track and locate the car, and to remotely activate the immobiliser to switch off the engine.

Contact your nearest Volvo dealer for more information and assistance with activating the system.

Related information

- Remote control key (p. 156)
- Remote control key - electronic immobiliser (p. 159)

⁴ Only certain markets and in combination with Volvo On Call*.



Remote control key - functions

The remote control key has functions such as locking and unlocking the doors.

Functions



Remote control key in basic version.

- Locking
- Unlocking
- Approach light duration
- Tailgate
- Panic function



Remote control key with PCC* (Personal Car Communicator).

- Information button - see Remote control key with PCC* - unique functions (p. 162) for a description of its functionality.

Function buttons

- Locking** – Locks the doors and tailgate while the alarm is activated, see Locking/ unlocking - from the outside (p. 170).

Press and hold to close all windows simultaneously. For more information, see Total airing function (p. 173).

WARNING

If windows are closed using the remote control key, check that nobody's hands are trapped.

- Unlocking (p. 170)** - Unlocks the doors and tailgate while the alarm is deactivated.

Press and hold to open all windows simultaneously. For more information, see Total airing function (p. 173).

The function can be changed from unlocking all doors simultaneously, to unlocking the driver's door only with one press of the button and, after a further press of the button - within ten seconds - unlocking the remaining doors.

The function can be changed in the menu system MY CAR. For a description of the menu system, see MY CAR (p. 108).

- Approach light duration (p. 93)** - Used to switch on the car's lighting at a distance.

- Tailgate (p. 173)** - Unlocks and disarms the alarm for the tailgate only.

- Panic function** – Used to attract attention in an emergency.

Press and hold the button for at least three seconds or press it twice within three seconds to activate the direction indicators and the horn.

The function can be turned off with the same button once it has been active for at least five seconds. Otherwise the function switches off automatically after approx. three minutes.



Related information

- Remote control key (p. 156)

Remote control key - range

Remote control key functions (in its basic version) have a range of approx. 20 metres from the car.

If the car does not verify a button being pressed - move closer and try again.



NOTE

The remote control key functions may be disrupted by surrounding radio waves, buildings, topographical conditions, etc. The car can always be locked/unlocked with the key blade (p. 164).

If the remote control key is removed from the car when the engine is running or key position **I** or **II** (p. 75) is active, and if all doors are closed, then a warning message is shown in the information display in the combined instrument panel and an audio reminder signal sounds at the same time.

The message is extinguished and the audible reminder signal stops when the remote control key is brought back to the car after either/or:

- The remote control key has been inserted in the ignition switch.
- Speed exceeds 30 km/h.
- The **OK** button has been pressed.

Related information

- Remote control key (p. 156)
- Remote control key - functions (p. 160)



Remote control key with PCC* - unique functions

A remote control key with PCC* has enhanced functionality compared with a remote control key in basic version (p. 156) in the form of an information button and indicator lamps.

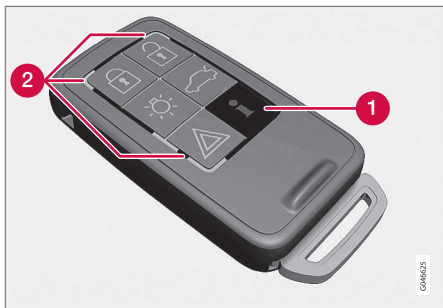

Remote control key with PCC.

- 1 Information button
- 2 Indicator lamps

Using the information button enables access to certain information from the car via the indicator lamps.

Using the information button

- Press the information button .
 - > All indicator lamps flash for approximately 7 seconds and the light travels around on the PCC. This indicates that information from the car has been read.

If any of the other buttons are pressed during this time then the reading is interrupted.

NOTE

 If none of the indicator lamps illuminates with repeated use of the information button and in different locations (as well as after 7 seconds and after the light has travelled around on the PCC), contact a workshop - an authorised Volvo workshop is recommended.

Indicator lamps display information in accordance with the following illustration:

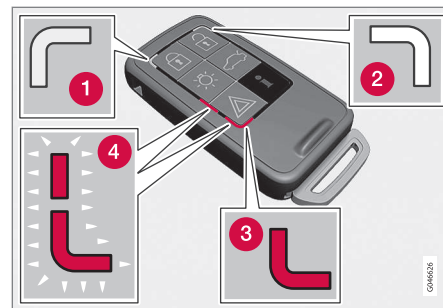

- 1 Green continuous light – the car is locked.
- 2 Yellow continuous light – the car is unlocked.
- 3 Red continuous light – the alarm has been triggered since the car was locked.
- 4 Red light flashing alternately in both indicator lamps – The alarm was triggered less than 5 minutes ago.

Related information

- Remote control key with PCC* - range (p. 163)



Remote control key with PCC* - range

The range of a remote control key with PCC (Personal Car Communicator) for unlocking the doors and tailgate is approx. 20 metres from the car - the other functions are up to approx. 100 metres. If the car does not verify a button being pressed - move closer and try again.

NOTE

The information button function may be disrupted by surrounding radio waves, buildings, topographical conditions, etc.

Out of range

If the remote control key is too far away from the car for the information to be read then the status the car was last left in is shown, without the light travelling around on the remote control key.

If several remote control keys are used for the car then it is only the remote control key last used for locking/unlocking that shows the correct status.

NOTE

 If none of the indicator lamps illuminates with repeated use of the information button and in different locations (as well as after 7 seconds and after the light has travelled around on the PCC), contact a workshop - an authorised Volvo workshop is recommended.

Related information

- Keyless Drive* - range (p. 166)
- Remote control key - range (p. 161)

Detachable key blade

The remote control key contains a detachable key blade of metal with which some functions can be activated and some operations carried out.

The key blade's unique code is provided by authorised Volvo workshops, which are recommended when ordering new key blades.

Key blade functions

Using the remote control key's detachable key blade:

- the left-hand front door can be opened manually (p. 164) if central locking cannot be activated with the remote control key.
- the rear doors' mechanical child safety locks can be activated/deactivated (p. 176).
- the right-hand front door and the rear doors can be locked manually, e.g. in the event of power failure.
- the glovebox lock* opens.
- the airbag for front passenger seat (PACOS*) can be activated/deactivated.

Related information

- Manual locking of the door (p. 171)
- Locking/unlocking - glovebox (p. 173)
- Passenger airbag - activating/deactivating* (p. 33)



Detachable key blade - detaching/ attaching

Detaching/attaching the detachable key blade (p. 163) is carried out as follows:

Removing the key blade



- 1** Slide the spring-loaded catch to the side.
- 2** At the same time pull the key blade straight out backwards.

Attaching the key blade

Carefully refit the key blade into its location in the remote control key (p. 156).

1. Hold the remote control key with the slot pointed up and lower the key blade into its slot.
2. Lightly press the key blade. You should hear a "click" when the key blade is locked in.

Related information

- Detachable key blade - unlocking doors (p. 164)
- Child safety locks - manual activation (p. 176)
- Passenger airbag - activating/deactivating* (p. 33)

Detachable key blade - unlocking doors

The detachable key blade can be used if the central locking cannot be activated with the remote control key - e.g. if the remote control key's battery (p. 165) has been discharged.

The left-hand front door can be opened as follows:

1. Unlock the left-hand front door with the key blade in the door handle's lock cylinder. For more information, see Keyless Drive* - unlocking with the key blade (p. 169).



NOTE

When the door has been unlocked using the key blade and is opened, the alarm is triggered.

2. Deactivate the alarm by inserting the remote control key in the ignition switch.

For a car with Keyless Drive, see Keyless Drive* - unlocking with the key blade (p. 169).

Related information

- Detachable key blade (p. 163)
- Remote control key (p. 156)



Remote control key/PCC - replacing the battery

The battery⁶ in the remote control key may need to be replaced.

The battery for the remote control key should be replaced if:

- the information symbol is illuminated and the display in the combined instrument panel shows **Car key battery low** See manual

and/or

- the locks repeatedly do not react to signals from the remote control key within 20 metres from the car.

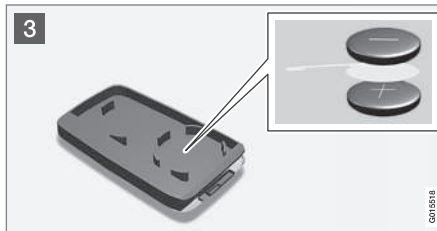

Opening

- 1 ➔ Slide the spring-loaded catch to the side.
- 2 ➔ At the same time pull the key blade straight out backwards.
- 2 ➔ Insert a 3 mm slot screwdriver in the hole behind the spring-loaded catch and gently prize the remote control key open.

NOTE

Turn the remote control key over with the buttons facing up, this is to avoid the batteries falling out when it is opened.

IMPORTANT

Avoid touching new batteries and their contact surfaces with your fingers as this may impair their function.

Battery replacement

NOTE

Volvo recommends that the batteries to be used in the remote control key/PCC fulfil UN Manual of Test and Criteria, Part III, sub-section 38.3. Batteries fitted in the factory or replaced by an authorised Volvo workshop fulfil the above criteria.

- 3 Closely study how the battery/batteries are secured on the inside of the cover, with regard to their (+) and (-) sides.

Remote control key with one battery

1. Carefully prize out the battery.
2. Install a new one with the (+) side down.

⁶ Remote control key with PCC has two batteries.



Remote control key with PCC* with two batteries

1. Carefully prize out the batteries.
2. First install one new one with the (+) side up.
3. Position the white plastic tab in between and finally install a second new battery with the (+) side down.

Battery type

Use batteries with designation CR2430, 3 V.

Assembly

1. Press the remote control key together.
2. Hold the remote control key with the slot pointed up and lower the key blade into its slot.
3. Lightly press the key blade. You should hear a "click" when the key blade is locked in.

IMPORTANT

Make sure that exhausted batteries are disposed of in a manner which is kind to the environment.

Related information

- Remote control key (p. 156)
- Remote control key - functions (p. 160)

Keyless drive*

Cars equipped with Keyless Drive have a starting and locking system that can be operated keylessly.

With the keyless starting and locking system the car can be started, locked and unlocked without the remote control key (p. 156) inserted in the ignition switch⁷. It is enough to have the remote control key with you in a pocket. The system makes it easier and more convenient to e.g. open the car when your hands are full.

Both of the remote control keys included with the car have Keyless functionality. It is possible to order more remote control keys.

The car's electrical system can be set to three different levels - key position **0**, **I** and **II** (p. 76) - with the remote control key.

Related information

- Keyless Drive* - range (p. 166)
- Keyless Drive* - secure handling of the remote control key (p. 167)
- Keyless Drive* - interference to remote control key function (p. 167)

Keyless Drive* - range⁹

In order to unlock the doors or tailgate automatically without pressing a button on the remote control key, a remote control key must be within approx. 1.5 metres from the car's door handle or tailgate.

The person who wishes to lock or unlock a door must have the remote control key with him or her. It is not possible to lock or unlock a door if the remote control key is on the opposite side of the car.

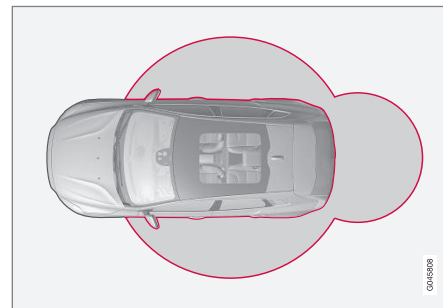

The red rings in the above figure indicate the range covered by the system's antennas.

If all remote control keys are removed from the car when the engine is running or key position **I** or **II** (p. 76) is active, and if a door has been opened and then closed, then a

⁷ Does not apply to Remote Control Key Basic.

⁹ Does not apply to cars with keyless start



warning message is shown in the information display in the combined instrument panel and an audio reminder signal sounds at the same time.

When the remote control key has been returned to the car, the warning message goes off and the audible reminder ceases once either/or:

- a door has been opened and closed
- the remote control key has been inserted in the ignition switch
- The **OK** button on the direction indicator stalk.

Related information

- Keyless drive* (p. 166)
- Keyless Drive* - antenna location (p. 170)

Keyless Drive* - secure handling of the remote control key

It is important to handle all remote control keys with great care.

If one of the remote control keys¹⁰ has been left in the car then the Keyless functionality is deactivated in case the car is e.g. locked with the other remote control key that belongs to the car. This prevents unauthorised entry.

The next time the car is unlocked with the other remote control key the forgotten remote control key is reactivated again.

IMPORTANT

Avoid leaving the remote control key with PCC behind in the car. If someone breaks into your car and takes the remote control key, it will e.g. be possible to start the car by pressing the remote control key in the ignition switch and then pressing the **START/STOP ENGINE** button.

Related information

- Keyless drive* (p. 166)

Keyless Drive* - interference to remote control key function

Electromagnetic fields and screening can interfere with the remote control key's Keyless functions (p. 166).

NOTE

Do not place/store the remote control key with keyless function near a mobile phone or metal object - no closer than 10-15 cm.

If interference is experienced nonetheless, use the remote control key and the key blade like a remote control key in basic version (p. 156).

Related information

- Remote control key/PCC - replacing the battery (p. 165)
- Keyless Drive* - secure handling of the remote control key (p. 167)
- Keyless Drive* - range (p. 166)

¹⁰ Applies to remote control key with PCC (Personal Car Communicator).



Keyless Drive* - locking

Cars equipped with Keyless Drive have a touch-sensitive area on the outer handle of the doors and a rubberised button next to the tailgate's rubberised pressure plate.

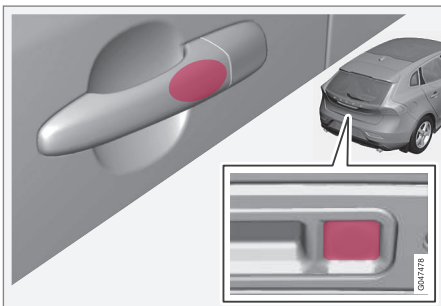

Lock the doors and the tailgate by grasping one of the door handles or pressing the smaller of the tailgate's two rubberised buttons - the lock indicator (p. 158) in the windscreen confirms that locking has been completed by starting to flash.

All doors and the tailgate must be closed before the car can be locked - otherwise the car is not locked.

i NOTE

In cars with automatic gearbox selectors, the gear selector must be set to the **P** position; otherwise the car can be neither locked nor alarmed.

Related information

- Keyless drive* (p. 166)
- Alarm indicator (p. 179)

Keyless Drive* - unlocking¹²

Unlocking takes place when a hand grasps a door handle or the tailgate's rubberised pressure plate is actuated - open the door or tailgate as normal.

i NOTE

The door handles normally register a hand that takes hold of the handle, but with thick gloves on or after a very quick hand movement a second attempt may be required, or with the glove taken off.

Related information

- Keyless drive* (p. 166)
- Keyless Drive* - locking (p. 168)



Keyless Drive* - unlocking with the key blade

If central locking cannot be activated with the remote control key, e.g. if the batteries are discharged, then the left-hand front door can be opened using the remote control key's detachable key blade (p. 163).

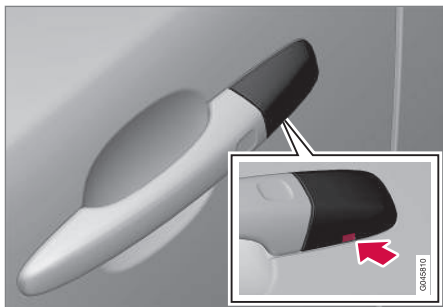

Hole for key blade - to loosen the cover.

To access the lock cylinder, the door handle's plastic cover must be removed - this is also done with the key blade:

1. Press the key blade approx. 1 cm straight up into the hole on the underside of the door handle/cover - do not prize.
 - > The plastic cover loosens automatically by means of the torque when the blade is pushed straight up and into the opening.
2. Then insert the key blade in the lock cylinder and unlock the door.
3. Refit the plastic cover after unlocking.

i NOTE

When the left-hand front door is unlocked using the key blade and is opened, this triggers the alarm (p. 178). It is switched off by inserting the remote control key in the ignition switch, see Alarm - remote control key not working (p. 180).

Related information

- Keyless drive* (p. 166)
- Detachable key blade - detaching/attaching (p. 164)

Keyless Drive* - lock settings

Lock settings for cars equipped with Keyless Drive can be adapted by indicating in the menu system MY CAR which doors are to be unlocked.

For a description of the menu system, see MY CAR (p. 108).

Related information

- Keyless drive* (p. 166)

¹² Does not apply to remote control key with keyless start.



Keyless Drive* - antenna location

Cars equipped with Keyless Drive have a number of built-in antennas positioned at different locations in the car.

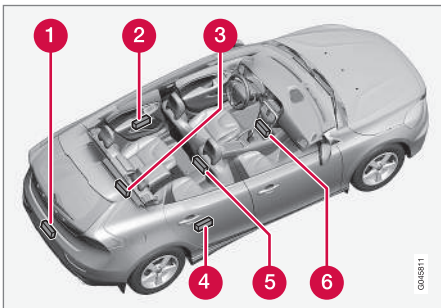

- 1 Rear bumper, centre
- 2 Door handle, left rear
- 3 Cargo area, central and furthest in under the floor
- 4 Door handle, right rear
- 5 Centre console, under the rear section
- 6 Centre console, under the front section.



WARNING

People with pacemaker operations should not come closer than 22 cm to the keyless system's antennae with their pacemaker. This is to prevent interference between the pacemaker and the keyless system.

Related information

- Keyless drive* (p. 166)

Locking/unlocking - from the outside

Locking/unlocking from the outside is carried out using the remote control key (p. 160). The remote control key can lock/unlock all doors, the tailgate and the fuel filler flap. Different sequences for unlocking can be selected.

In order that the lock sequence can be activated, the driver's door must be closed - if any of the other doors or the tailgate is open, then it/they is/are locked and the alarm is activated only when it/they are closed. For cars equipped with keyless locking system* all doors and the tailgate must be closed, see Keyless Drive* - locking (p. 168) and Keyless Drive* - unlocking (p. 168).



NOTE

Be aware of the risk of locking the remote control key in the car.

If it is not possible to lock/unlock with the remote control key, the battery may be discharged - lock or unlock the left-hand front door with the detachable key blade (p. 164).



NOTE

Remember that the alarm is triggered when the door is opened after being unlocked with the key blade - the alarm is switched off when the remote control key is inserted into the ignition switch.



! WARNING

Be aware of the risk of being locked in the car when it is locked from the outside using the remote control key - it is then not possible to open any of the doors from the inside with the door controls. For more information, see Deadlocks* (p. 175).

Automatic relocking

If none of the doors or the tailgate is opened within two minutes of unlocking, all are locked again automatically. This function prevents the car from being left unlocked unintentionally. For cars with alarm, see Alarm (p. 178).

Related information

- Locking/unlocking - from the inside (p. 172)
- Remote control key - functions (p. 160)

Manual locking of the door

In certain situations the car must be lockable manually, e.g. in the event of power failure.

The left-hand front door can be locked with its lock cylinder and the remote control key's detachable key blade (p. 169).

Other doors have no lock cylinders and instead have a lock switch on the end of each door which must be depressed using the key blade - they are then mechanically locked/ blocked to prevent them being opened from outside. The doors can still be opened from the inside.

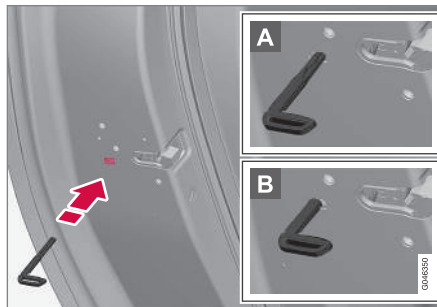

Manual locking of the door. Not to be mixed up with child safety locks (p. 176).

- Remove the detachable key blade (p. 164) from the remote control key. Insert the key blade in the hole for lock reset and press the key in until the key bottoms, approx. 12 mm.

- A** The door can be opened from both the outside and the inside.
- B** The door is blocked against opening from the outside. To return to position A, the inner door handle must be opened.

The doors can also be unlocked with the unlock button on the remote control key (p. 156) or with the central locking button on the driver's door.

i NOTE

- A door's lock reset only locks that particular door - not all doors simultaneously.
- A manually locked rear door with activated manual child safety locks (p. 176) cannot be opened from either the outside or the inside. A rear door that is locked in this way can only be unlocked with the remote control key or central locking button.

Related information

- Remote control key/PCC - replacing the battery (p. 165)





Locking/unlocking - from the inside

Locking/unlocking can be performed using the driver's door button for central locking. All doors and tailgate (p. 173) can be locked or unlocked simultaneously.



Central locking

- Press one side  of the button to lock - the other side  to unlock.

Lamp in lock button

When the lamp in the central locking button for the driver's door is illuminated it means that all doors are locked.

With central locking button only in the driver's door, other doors have no button:

- Illuminated lamp means that all doors are locked.

With central locking button on both front doors and electric lock button in each rear door:

- Illuminated lamp means that only that particular door is locked. When all buttons are illuminated all doors are locked.

Unlocking

A door can be unlocked from the inside in two different ways:

- Press the central locking button .

A long press also opens all the side windows* simultaneously (see also section Total airing function (p. 173)).

- Pull the door handle and open the door - the door is unlocked and opened in one operation.

Locking

- Both front doors must be closed for the central locking to be activated. Press the central locking button  - all doors are locked. If any of the rear doors is open, it will lock when it is closed.

A long press also closes all the side windows simultaneously (see also section Total airing function (p. 173)).

Automatic locking

The doors and tailgate are locked automatically when the car starts to move.

The function can be activated/deactivated in the menu system MY CAR. For a description of the menu system, see MY CAR (p. 108).

Related information

- Locking/unlocking - from the outside (p. 170)
- Alarm (p. 178)





Total airing function

The total airing function opens or closes all side windows simultaneously and can be used for example to quickly air the car during hot weather.



Central locking button

A long press on the  symbol in the central locking button **opens** all side windows simultaneously. The same procedure on the  button **closes** all side windows simultaneously.

Related information

- Locking/unlocking - from the inside (p. 172)
- Power windows (p. 99)

Locking/unlocking - glovebox

The glovebox (p. 146) can only be locked/unlocked using the detachable key blade from the remote control key (p. 156).

For information on the key blade, see Detachable key blade - detaching/attaching (p. 164).



Locking the glovebox:

- 1 Insert the key blade in the glovebox lock cylinder.
 - 2 Turn the key blade 90 degrees clockwise. The keyhole is horizontal in the locked position.
 - 3 Pull out the key blade.
- Unlock by carrying this out in reverse order.

Related information

- Remote control key - functions (p. 160)

Locking/unlocking - tailgate

The tailgate can be opened, locked and unlocked in a number of different ways.

Manual opening

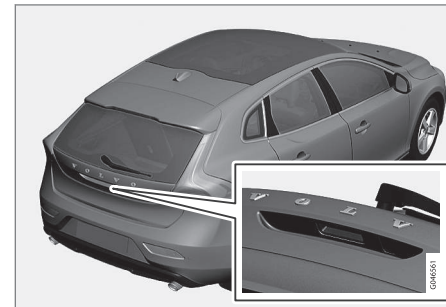

Rubber plate with electrical contact.

The tailgate is held closed by an electrical lock. To open:

1. Push down gently on the wider of the two rubberised pressure plates under the outer handle - the lock is released.
2. Lift the outside handle in order to fully open the tailgate.



06 Locks and alarm



! IMPORTANT

- Minimal force is required to release the rear hatch lock - just gently press the rubberised panel.
- Do not place the lift force on the rubber panel when opening the rear hatch - lift the handle. Using too much force may damage the electrical contacts on the rubber panel.

Unlocking with the remote control key

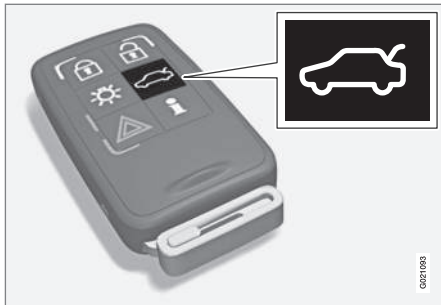

Using the remote control key (p. 156)  button the alarm for the tailgate can be disarmed* and the tailgate unlocked on its own.

The lock indicator (p. 158) on the instrument panel stops flashing in order to show that not all of the car is locked and the alarm's* level and movement sensors and the sensors for opening the tailgate are disconnected.

The doors remain locked and armed.

The tailgate can be opened in two different ways using the remote control key:

One press - The boot lid is unlocked, but remains closed - press lightly on the rubberised pressure plate under the outer handle and lift the boot lid. If the tailgate is not opened within 2 minutes then it is relocked and the alarm is re-armed.

Two presses - The boot lid is unlocked and the lock is disengaged at which the boot lid opens about a centimetre - lift the outer handle to open. Rain, cold, frost or snow could however prevent the tailgate from disengaging from the lock.

i NOTE

- When the boot lid/tailgate is unlocked with 2 presses or from the car interior, automatic relocking does not take place because the boot lid/tailgate is open - it must be closed manually.
- After the boot lid/tailgate has been closed it is unlocked and the alarm is not armed - relock it and re-arm the alarm with the remote control key's lock button .

Opening the car from inside



1 Unlocking, tailgate

To open the tailgate:

- Press the lighting panel button (1).
 - > The lock releases and the tailgate opens by a few centimetres.

Locking with the remote control key

- Press the remote control key (p. 160) button for locking .
 - > The lock indicator on the instrument panel starts flashing, which means that the car is locked and the alarm* has been activated.

Related information

- Locking/unlocking - from the inside (p. 172)
- Locking/unlocking - from the outside (p. 170)



Locking/unlocking - fuel filler flap

The fuel filler flap is unlocked with the remote control key (p. 156) button for unlocking



The fuel filler flap remains unlocked until the car is locked with the remote control key's button for locking (). If the car is locked while driving or with the interior buttons then the fuel filler flap remains unlocked.

The fuel filler flap's locking logic also follows the locking or unlocking of the Keyless system and the central locking system.

Related information

- Fuel filler flap - Opening/closing (p. 295)
- Fuel filler flap - manual opening (p. 295)

Deadlocks*

Deadlocks¹³ means that all door handles are mechanically disengaged, which prevents doors being opened from the inside.

The deadlocks are activated with the remote control key (p. 156) and are set after an approx. ten seconds delay after the doors have been locked.

NOTE

If a door is opened within the delay time then the sequence is interrupted and the alarm is deactivated.

The car can only be unlocked with the remote control key when the deadlocks function is activated. The front left door can also be unlocked with the detachable key blade (p. 163).

WARNING

Do not allow anyone to remain in the car without first deactivating the deadlocks in order to avoid the risk of anyone being locked in.

¹³ Only in combination with alarm.

Temporary deactivation



Active menu options are indicated with a cross.

- 1 MY CAR
- 2 OK MENU
- 3 TUNE knob control
- 4 EXIT

If someone is going to stay in the car but the doors must be locked from the outside, then the deadlocks function can be temporarily switched off, which is carried out in the menu system MY CAR. For a detailed description of the menu system, see MY CAR (p. 108).

In MY CAR one of the following options can be selected:

- **Activate once:** - The combined instrument panel then shows **Locks and alarm Reduced guard** and deadlocks



06 Locks and alarm



are switched off when the car is locked, only at this time. (Note that the alarm's movement and tilt detectors* are switched off at the same time.)

During the next time the engine is started, the system is reset to zero and the combined instrument panel shows the message **Locks and alarm Full guard** at which the deadlocks and the alarm's movement and tilt detectors are re-engaged.

- **Ask on exit:** - Each time the engine is switched off, the driver must answer the question **Activate Reduced Guard until engine has started again?**

If the deadlocks function shall be switched off

- Press **OK/MENU** and lock the car. (Note that the alarm's movement and tilt detectors* are switched off at the same time.)
 - > The next time the engine is started, the system is reset to zero and the combined instrument panel shows the message **Locks and alarm Full guard** at which the deadlocks function and the alarm's movement and tilt detectors are re-engaged.

If the locking system shall not be changed

- Press **EXIT** and lock the car.

NOTE

- Remember that the alarm is activated when the car is locked.
- If any of the doors are opened from the inside then the alarm is triggered.

Related information

- Keyless Drive* - unlocking with the key blade (p. 169)

Child safety locks - manual activation

The child safety locks prevent children from being able to open a rear door from the inside.

The child safety locks are located on the trailing edge of the rear doors and are only accessible when the doors are open.

Activate/deactivate child safety locks

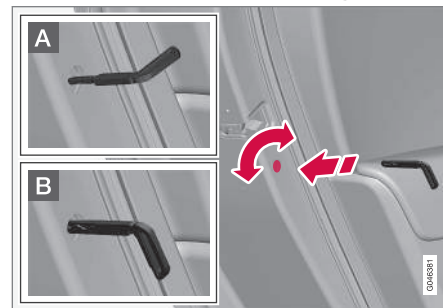

Manual child safety locks. Not to be mixed up with manual door lock (p. 171).

- Use the remote control key's detachable key blade (p. 164) to turn the knob.
- A** The door is blocked against opening from the inside.
- B** The door can be opened from both the outside and the inside.



NOTE

- A door's knob control only blocks that particular door - not both rear doors simultaneously.
- Cars with an electric child safety lock do not have a manual child lock.

Related information

- Child safety locks - electrical activation* (p. 177)
- Locking/unlocking - from the inside (p. 172)

Child safety locks - electrical activation*

The child safety locks prevent children from being able to open a rear door from the inside.

Activation

The electrical child safety locks can be activated/deactivated in all key positions (p. 75) higher than **0**. Activation/deactivation can be performed up to 2 minutes after switching off the engine, provided that no door is opened.



Control panel driver's door.

1. Start the engine or choose a key position higher than **0**.

2. Press the button in the driver's door control panel.
 - > The information display shows the message **Rear child lock activated** and the button's lamp illuminates - the locks are active.

When the electric child safety lock is active then the rear:

- windows can only be opened with the driver's door control panel
- doors cannot be opened from inside.

The current setting is stored when the engine is switched off - if the child safety locks are activated at engine shutdown, the function will remain activated the next time the engine is started.

Related information

- Child safety locks - manual activation (p. 176)
- Locking/unlocking - from the inside (p. 172)



Alarm

The alarm is a device that warns in the event of e.g. a break-in in the car.

Activated alarm is triggered if:

- a door, the bonnet or the tailgate is opened
- a movement is detected in the passenger compartment (if fitted with a movement detector*)
- the car is raised or towed away (if fitted with a tilt detector*)
- the battery's cable is disconnected
- the siren is disconnected.

If there is a fault in the alarm system then the information display in the combined instrument panel shows a message. In which case, contact a workshop - an authorised Volvo workshop is recommended.



NOTE

The movement sensors trigger an alarm in the event of movement in the passenger compartment - air currents are also registered. For this reason the alarm is triggered if the car is left with a window open or if the passenger compartment heater is used.

To avoid this: Close the window when leaving the car. If the car's integrated passenger compartment heater (or a portable electric heater) shall be used - direct the airflow from the air vents so that they are not pointing upwards in the passenger compartment. Alternatively, reduced alarm level can be used, Reduced alarm level (p. 180).



NOTE

Do not attempt to repair or alter components in the alarm system yourself. Any such attempts may affect the terms of the insurance.

Deactivating a triggered alarm

- Press the remote control key unlock button or insert the remote control key in the ignition switch.

Related information

- Alarm - automatic re-arming (p. 179)
- Alarm - remote control key not working (p. 180)

Arming the alarm

- Press the remote control key lock button.

Deactivate the alarm

- Press the remote control key unlock button.



Alarm indicator

The alarm indicator shows alarm system (p. 178) status.



Same LED as lock indicator (p. 158).

A red LED on the instrument panel indicates the alarm system's status:

- LED not lit – Alarm not armed
- The LED flashes once every other second – Alarm is armed
- The LED flashes rapidly after disarming the alarm (and until the remote control key is inserted in the ignition switch and key position I is selected) – Alarm has been triggered.

Alarm - automatic re-arming

Automatic re-arming of the alarm (p. 178) prevents the car being left with the alarm disarmed unintentionally.

If the car is unlocked with the remote control key (p. 156)(and the alarm is disarmed) but none of the doors or the tailgate is opened within 2 minutes, then the alarm is automatically re-armed. The car is relocked at the same time.

Related information

- Alarm - automatic arming (p. 179)

Alarm - automatic arming

In certain countries the alarm (p. 178) is activated after a certain delay if the driver's door was opened and closed but the car was not re-locked.

Related information

- Alarm signals (p. 180)



Alarm - remote control key not working

If the alarm (p. 178) cannot be deactivated with the remote control key, e.g. if the key's battery (p. 165) is discharged - the car can be unlocked, disarmed and the engine started as follows:

1. Open the left-hand front door with the detachable key blade (p. 169).
 - > The alarm is triggered, the direction indicators flash and the siren sounds.



2. Insert the remote control key in the ignition switch.
 - > The alarm is deactivated.

Alarm signals

When the alarm (p. 178) is triggered a siren sounds and all direction indicators flash.

- A siren sounds for 30 seconds or until the alarm is switched off. The siren has its own battery and works independently of the car battery.
- The direction indicators flash for 5 minutes or until the alarm is switched off.

Reduced alarm level

Reduced guard means that the movement and tilt detectors can be temporarily deactivated.

To avoid accidental triggering of the alarm - e.g. if a dog is left in a locked car or during transport on a car train or car ferry - temporarily deactivate the movement and tilt detectors.

The procedure is the same as with the temporary disengaging of deadlocks, see Deadlocks* (p. 175).

Related information

- Alarm (p. 178)
- Alarm indicator (p. 179)



Type approval - remote control key system

Type approval for the remote control key system can be read in the table.

Lock system, standard

Country/Area	
EU, China	<p>Continental FCC ID: K956WTKAR284 IC:2871-SWK49265 @ CCA308LP166074 CET2177C20080R TRC/LPD/200822 CE CHN ID:20080J1134 Complies with IDA Standards DB01783 TA-2008F10 RCM/01786-248 Made in Cz</p>

Keyless lock system (Keyless drive)

Country/Area	
EU	<p>Continental SWK4 9265 CE</p>
Korea	<p>Continental SIE-SWK 49268 Made in Cz K</p>

Country/Area	
China	<p>Continental SWK4 9265 CET2177C20080R TRC/LPD/200822 CHN ID:20080J1134 Complies with IDA Standards DB01783 TA-2008F10 RCM/01786-248 Made in Cz</p>
Hong Kong	<p>Continental SWK4 9265</p>

Related information

- Remote control key (p. 156)

07



DRIVER SUPPORT

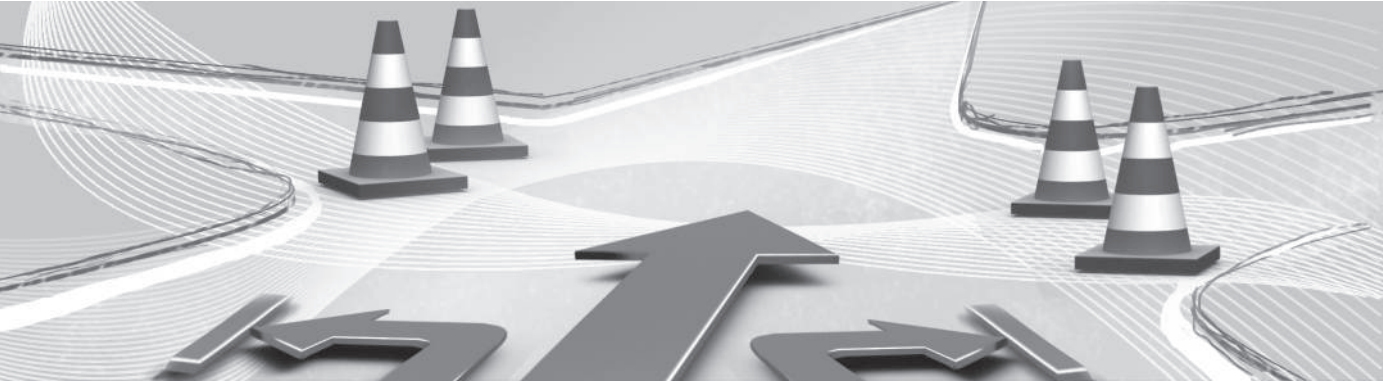



Electronic stability control (ESC) - general

Stability system ESC (Electronic Stability Control) helps the driver to avoid skidding and improves the car's traction.



The activation of the ESC system during braking may be noticed as a throbbing sound. The car may accelerate slower than expected when the accelerator pedal is depressed.

WARNING

The stability system ESC is supplementary assistance - it cannot handle all situations in all road conditions.

The driver always bears responsibility that the vehicle is driven safely and that applicable road traffic rules and regulations are followed.

The ESC system consists of the following functions:

- Active Yaw Control
- Spin Control
- Traction control system
- Engine drag control - EDC
- Corner Traction Control - CTC
- Driver Steering Recommendation – DSR
- Trailer Stability Assist* - TSA

Active Yaw Control

The function checks the driving and brake force of the wheels individually in order to stabilise the car.

Spin Control

The function reduces engine power if the drive wheels slip against the underlying surface in order to maintain stability and traction.

Traction control system

The function is active at low speed and transfers power from the driving wheel that is spinning to the one that is not.

Engine drag control - EDC

EDC (Engine Drag Control) prevents involuntary wheel locking, e.g. after shifting down or engine braking when driving in low gears on slippery road surfaces.

Involuntary wheel locking while driving can, amongst other things, impair the driver's ability to steer the car.

Corner Traction Control - CTC

CTC (Corner Traction Control) compensates for understeer and allows higher than normal acceleration in a bend without wheelspin on the inner wheel, e.g. on an arcing motorway entrance road to quickly reach the prevailing traffic speed.

Driver Steering Recommendation – DSR

DSR (Driver Steering Recommendation) helps the driver steer the car in the right direction when there is reduced traction or when the ABS system engages.

The primary role of the DSR function is to help the driver steer in the right direction when the car is skidding.

DSR engages by applying slight torque to the steering wheel in the direction in which the car should be steered to maintain/achieve maximum possible traction and stabilise the car.

Trailer Stability Assist* - TSA¹

Trailer stability assist (p. 308) function is to stabilise the car and trailer combination if it begins to snake. For more information, see Driving with a trailer (p. 301).

NOTE

The function is deactivated if the driver selects **Sport** mode.

Related information

- Electronic stability control (ESC) - operation (p. 184)
- Electronic stability control (ESC) - symbols and messages (p. 185)

¹ Trailer Stability Assist is included in the installation of the Volvo genuine towbar.



Electronic stability control (ESC) - operation

Selection of level - Sport mode

The ESC system is always activated - it cannot be deactivated.



However, the driver can select the **Sport** mode, which allows for a more active driving experience.

In **Sport** mode the system detects whether the accelerator pedal, steering wheel movements and cornering are more active than in normal driving and then allows controlled skidding with the rear section up to a certain level before it intervenes and stabilises the car.

If the driver stops a controlled skid by releasing the accelerator pedal, for example, then the ESC system intervenes and stabilises the car.

With **Sport** mode, maximum traction is also obtained if the car has become stuck, or when driving on a loose surface - e.g. sand or deep snow.

Proceed as follows to select **Sport** mode:

Sport mode is selected in the menu system MY CAR. For a description of the menu system, see MY CAR (p. 108).



Sport mode is indicated in the combined instrument panel by means of this symbol illuminating with a constant glow until the driver deselects the function or until the engine is switched off - after the next time the engine is started the ESC system is back in its normal mode once again.

Related information

- Electronic stability control (ESC) - general (p. 183)
- Electronic stability control (ESC) - symbols and messages (p. 185)
- MY CAR (p. 108)



Electronic stability control (ESC) - symbols and messages

Table

Symbol	Message	Specification
	ESC Temporarily OFF	ESC system has been temporarily reduced due to excessive brake disc temperature - the function is reactivated automatically when the brakes have cooled.
	ESC Service required	ESC system disengaged. <ul style="list-style-type: none"> • Stop the car in a safe place, switch off the engine and start it again. • Visit a workshop if the message remains - an authorised Volvo workshop is recommended.
 and 	"Message"	There is a message in the combined instrument panel - read it!
	Constant glow for 2 seconds.	System check when the engine is started.
	Flashing light.	ESC system is being activated.
	Constant glow.	Sport mode is activated. NOTE: The ESC system is not deactivated in this mode - it is partially reduced.



Related information

- Electronic stability control (ESC) - general (p. 183)
- Electronic stability control (ESC) - operation (p. 184)



Road Sign Information (RSI)

The road sign information function (RSI – Road Sign Information) helps the driver to remember which road signs the car has passed.

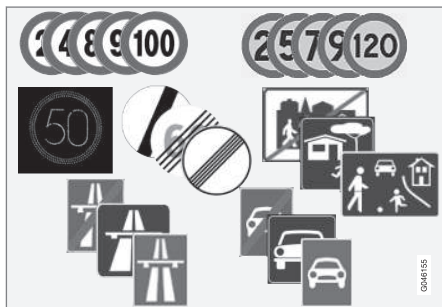

Examples of readable speed related² signs.

The road sign information function gives information on current speed, that a motorway or road is starting/ending and when overtaking is prohibited. If both a sign for motorway/road for motorised traffic and a sign showing the maximum permitted speed are passed, RSI decides to show the sign symbol for maximum permitted speed.

WARNING

RSI does not work in all situations but is designed merely as a supplementary aid.

The driver always bears ultimate responsibility for ensuring that the vehicle is driven safely and that applicable road traffic rules and regulations are followed.

Related information

- Road sign information (RSI)* - operation (p. 187)
- Road sign information (RSI)* - limitations (p. 189)

Road sign information (RSI)* - operation

The road sign information function (RSI – Road Sign Information) helps the driver to remember which road signs the car has passed. How the function is operated is described below.

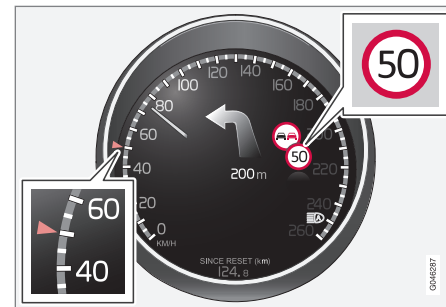

Recorded speed information³.

When RSI has recorded a road sign with an imposed speed, the combined instrument panel displays the sign as a symbol.

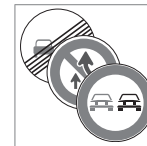

Together with the symbol for the current speed limit, a sign showing that overtaking is prohibited may also be displayed where appropriate.

² Road signs shown in the combined instrument panel are market-dependent - the illustrations only show a few examples.

³ Road signs shown in the combined instrument panel are market-dependent - the illustrations only show a few examples.



07 Driver support



End of restriction or motorway

A corresponding road sign is shown in the combined instrument panel for approx. 10 seconds in situations where RSI detects a sign that involves the end of a speed limit - or other speed-related information, e.g. end of a motorway.

Examples of such signs are:

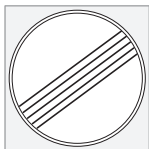

End of all restrictions.



End of motorway.

Following which, the sign information is hidden until the next speed-related sign is detected.

Additional signs

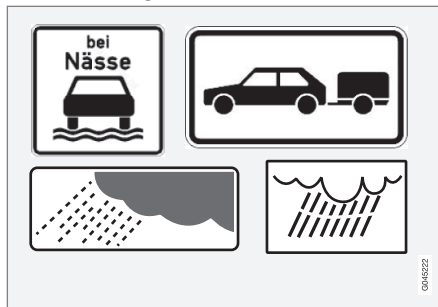

Examples of additional signs³.

Sometimes different speed limits are signposted for the same road - an additional sign then indicates the circumstances under which the different speeds apply. The road section may be particularly susceptible to accidents in rain and/or fog, for example.

An additional sign relating to rain is displayed only if the windscreen wipers are in use.

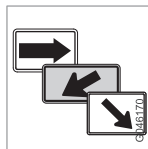

The speed applicable on an exit is indicated in certain markets by means of an additional sign containing an arrow.

Speed signs linked to this type of additional sign are displayed only if the driver is using the direction indicator.

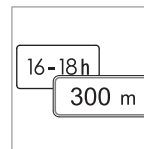

Some speeds are applicable only after e.g. a specific distance or at a certain time of day. The driver's attention is drawn to the situation by means of a symbol for an additional sign under the

symbol showing speed.

Display of additional information



A symbol for additional sign in the form of an empty frame under the combined instrument panel's speed symbol means that the RSI has detected an additional sign with supplementary information for the current speed limit.

Road sign information On/Off



The combined instrument panel's speed symbol display can be disabled.

³ Road signs shown in the combined instrument panel are market-dependent - the illustrations only show a few examples.



To deactivate the RSI function:

- Search for the function in the menu system **MY CAR MY CAR** (p. 108), uncheck **Road sign information** and back out with **EXIT**.

Speed Alert On/Off



The driver can opt to receive a warning when the applicable speed limit is exceeded by 5 km/h or more. This warning is given by the symbol showing the applicable maximum speed temporarily flashing when this speed is exceeded.

To activate speed warning:

- Search for the function in the menu system **MY CAR MY CAR** (p. 108), check **Speed alert** and back out with **EXIT**.

Related information

- Road Sign Information (RSI) (p. 187)
- Road sign information (RSI)* - limitations (p. 189)
- MY CAR (p. 108)

Road sign information (RSI)* - limitations

The road sign information function (RSI – Road Sign Information) helps the driver to remember which road signs the car has passed. The function has the following limitations.

The RSI function's camera sensor has limitations just like the human eye. Find out more about this in the section on the camera sensor limitations (p. 229).

Signs which indirectly provide information on a prevailing speed limit, e.g. name signs for towns/districts, are not recorded by the RSI function.

Here are some other examples of what can disrupt the function:

- Faded signs
- Signs positioned on bends
- Rotated or damaged signs
- Concealed or poorly positioned signs
- Signs completely or partly covered with frost, snow and/or dirt.

Related information

- Road Sign Information (RSI) (p. 187)
- Road sign information (RSI)* - operation (p. 187)

Speed limiter*

A (Speed Limiter) can be regarded as a reverse cruise control - the driver regulates the speed using the accelerator pedal but is prevented from accidentally exceeding a pre-selected/set speed by the speed limiter.

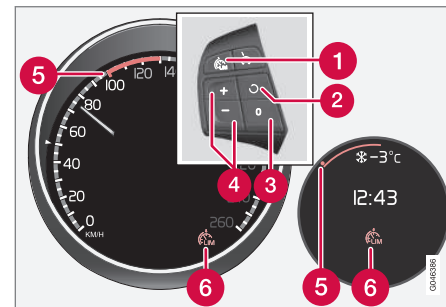

Steering wheel keypad and combined instrument panel Digital and Analogue.

- 1 Speed limiter - On/Off.
- 2 Standby mode ceases and the stored speed is resumed.
- 3 Standby mode
- 4 Activate and adjust the max. speed.
- 5 Selected speed
- 6 Speed limiter active



Related information

- Speed limiter* - getting started (p. 190)
- Speed limiter - temporary deactivation and standby mode* (p. 191)
- Speed limiter* - alarm for speed exceeded (p. 192)
- Speed limiter* - deactivation (p. 193)

Speed limiter* - getting started

A (Speed Limiter) can be regarded as a reverse cruise control - the driver regulates the speed using the accelerator pedal but is prevented from accidentally exceeding a pre-selected/set speed by the speed limiter.

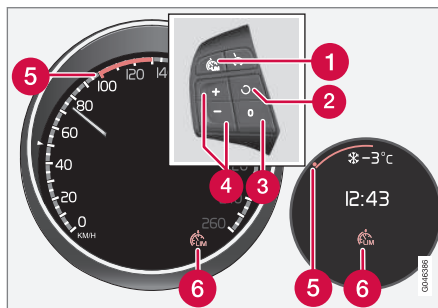

Steering wheel keypad and combined instrument panel Digital and Analogue.



- 1 Speed limiter - On/Off.
- 2 Standby mode ceases and the stored speed is resumed.
- 3 Standby mode
- 4 Activate and adjust the max. speed.
- 5 Selected speed
- 6 Speed limiter active

Switch on and activate

When the speed limiter is active, its symbol (6) is shown in combination with a mark (5) by the set maximum speed in the combined instrument panel.

Selection and storage of the highest possible speed in the memory can be made both during a journey and while stationary.

While driving

1. Press the steering wheel button  to switch on the speed limiter.
 - > The symbol (6) for speed limiter illuminates in the combined instrument panel.
2. When the car is moving at the desired highest possible speed: Press one of the steering wheel buttons  or  until the combined instrument panel shows a mark (5) next to the desired maximum speed.
 - > The speed limiter is then active and the selected max. speed is stored in the memory.

When stationary

1. Press the steering wheel button  to switch on the speed limiter.





2. Scroll with the  button until the combined instrument panel shows a mark (5) by the desired maximum speed.
 - > The speed limiter is then active and the selected max. speed is stored in the memory.

Related information

- Speed limiter* (p. 189)

Speed limiter* - changing speed

Changing the stored speed

Stored maximum speed is changed with short or long presses on the  or  button.

To adjust +/- 5 km/h:

- Use short presses - each press gives +/- 5 km/h.

To adjust +/- 1 km/h:

- Hold the button depressed and release when the combined instrument panel's mark is by the desired maximum speed.

Last press made is stored in the memory.

Related information

- Speed limiter* (p. 189)

Speed limiter - temporary deactivation and standby mode*

A (Speed Limiter) can be regarded as a reverse cruise control - the driver regulates the speed using the accelerator pedal but is prevented from accidentally exceeding a pre-selected/set speed by the speed limiter.

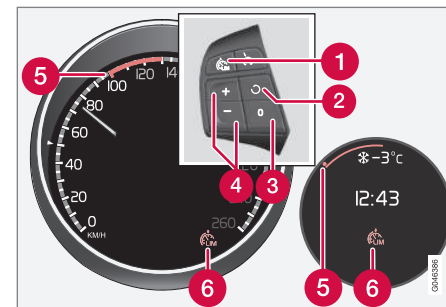

Steering wheel keypad and instrument panel Digital and Analogue.

- 1 Speed limiter - On/Off.
- 2 Standby mode ceases and the stored speed is resumed.
- 3 Standby mode
- 4 Activate and adjust the max. speed.
- 5 Selected speed
- 6 Speed limiter active





07 Driver support



Temporary deactivation - standby mode

To temporarily deactivate the speed limiter and set it in standby mode:

- Press .
 - > The combined instrument panel's mark (5) changes colour from GREEN to WHITE (Digital) or from WHITE to GREY (Analogue) and the driver can temporarily exceed the set maximum speed.
- The speed limiter is reactivated with one press on . The mark (5) then changes colour from WHITE to GREEN (Digital) or GREY to WHITE (Analogue) and the car's maximum speed is limited again.

Temporary deactivation with the accelerator pedal

The speed limiter can also be set in standby mode with the accelerator pedal, e.g. for rapidly accelerating the car out of a situation:

- Depress the accelerator pedal fully.
 - > The combined instrument panel shows the stored maximum speed with a coloured mark (5) and the driver can temporarily exceed the set maximum speed – the mark (5) changes colour from GREEN to WHITE (Digital) or WHITE to GREY (Analogue) during that time.
- The speed limiter is automatically reactivated after the accelerator pedal is released and the car's speed is slowed down to below the selected/stored maximum speed - the mark (5) changes colour from WHITE to GREEN (Digital) or GREY to WHITE (Analogue) and the car's maximum speed is again limited.

Related information

- Speed limiter* (p. 189)



Speed limiter* - alarm for speed exceeded

A (Speed Limiter) can be regarded as a reverse cruise control - the driver regulates the speed using the accelerator pedal but is prevented from accidentally exceeding a pre-selected/set speed by the speed limiter.

On steep roads the speed limiter's engine braking effect may be inadequate and the selected maximum speed is exceeded. The driver is alerted about this with an acoustic signal. The signal is active until the driver has slowed to below the selected maximum speed.



NOTE

The alarm is only activated after 5 seconds if the speed has been exceeded by at least 3 km/h provided that none of the buttons  or  has been depressed during the last half minute.

Related information



- Speed limiter* (p. 189)



Speed limiter* - deactivation

A (Speed Limiter) can be regarded as a reverse cruise control - the driver regulates the speed using the accelerator pedal but is prevented from accidentally exceeding a pre-selected/set speed by the speed limiter.

To deactivate the speed limiter:

- Press the steering wheel button .
 - > The combined instrument panel's (p. 189) symbol for the speed limiter and the mark for the set speed are extinguished. The selected and stored speed are thus deleted from the memory and cannot be resumed with the  button.

The driver can then use the accelerator pedal to choose a speed without limitation.

Related information

- Speed limiter* (p. 189)

Cruise control*

The cruise control (CC – Cruise Control) helps the driver maintain an even speed, resulting in more relaxing driving on motorways and long, straight roads with regular traffic flows.

Overview

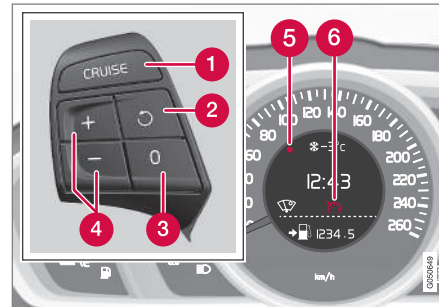

The steering wheel buttons and combined instrument panel in cars **without** speed limiter⁴.

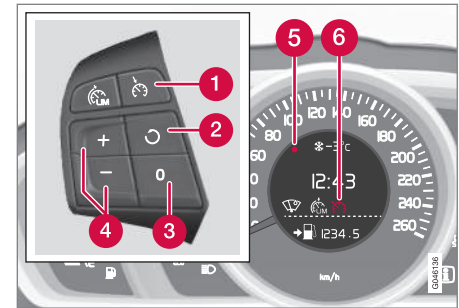

The steering wheel buttons and combined instrument panel in cars **with** speed limiter⁴.

- 1 Cruise control - On/Off.
- 2 Standby mode ceases and the stored speed is resumed.
- 3 Standby mode
- 4 Activate and adjust the speed.
- 5 Selected speed (GREY = Standby mode).
- 6 Cruise control active - WHITE symbol (GREY = Standby mode).

⁴ A Volvo dealer has updated information about what applies in each respective market.



! WARNING

The driver must always be observant with regard to the traffic conditions and intervene when the cruise control is not maintaining a suitable speed and/or suitable distance.

The driver always bears ultimate responsibility for ensuring that the vehicle is driven safely.

Related information

- Cruise control* - managing speed (p. 194)
- Cruise control* temporary deactivation and standby mode (p. 195)
- Cruise control* - resume set speed (p. 196)
- Cruise control* - deactivate (p. 197)
- Adaptive cruise control (ACC)* (p. 198)

Cruise control* - managing speed

It is possible to activate, set and change the stored speed.

Activating and setting the speed

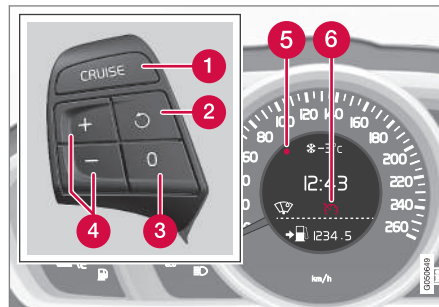

*The steering wheel buttons and display in cars **without** speed limiter⁵.*

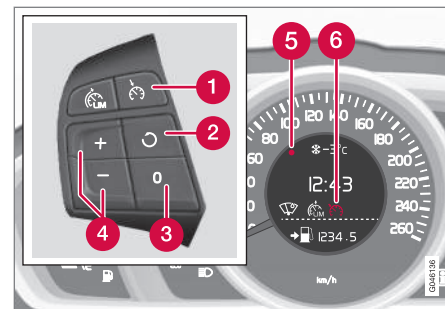



*The steering wheel buttons and display in cars **with** speed limiter⁵.*

To enable cruise control:

- Press the steering wheel button for **CRUISE (without speed limiter)** or  **(with speed limiter)**.
- > The cruise control symbol (6) in the combined instrument panel illuminates - Cruise control is in standby mode.

To activate cruise control:

- At the required speed - press the steering wheel button  or .
- > The current speed is stored in the memory and the combined instrument panel's marking (5) illuminates at the selected speed and the symbol (6) changes from GREY to WHITE - the car then follows the stored speed.

⁵ A Volvo dealer has updated information about what applies in each respective market.

**i NOTE**

Cruise Control cannot be enabled at speeds below 30 km/h.

Changing the stored speed

Stored speed is changed by pressing button

+ or **-**:

- Short presses give +/- 5 km/h.

or

- Hold down the button and release it at the required speed.

If speed is increased using the accelerator pedal prior to pressing the **+**/**-** button, then it is the car's current speed when the button is pressed that is stored. Last press made is stored in the memory.

A temporary increase in speed with the accelerator pedal, e.g. during overtaking, does not affect the cruise control setting - the car returns to the last stored speed when the accelerator pedal is released.

i NOTE

If any of the Cruise Control buttons are held depressed for several minutes then it is blocked and deactivated. To be able to reactivate Cruise Control, the car must be stopped and the engine restarted.

Related information

- Cruise control* (p. 193)

Cruise control* temporary deactivation and standby mode

The function can be temporarily deactivated and set in standby mode.

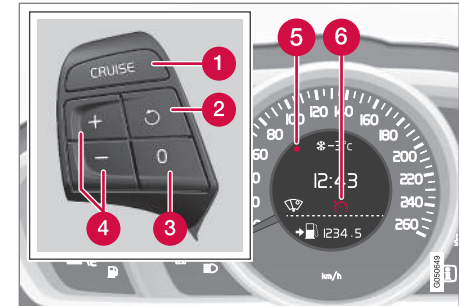
Temporary deactivation - standby mode

The steering wheel buttons and display in cars **without** speed limiter⁶.

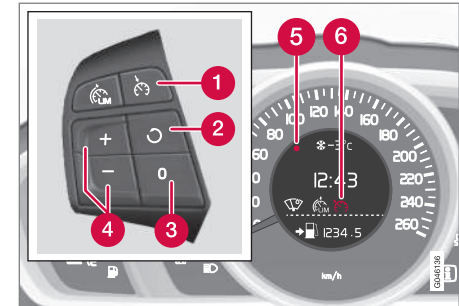

The steering wheel buttons and display in cars **with** speed limiter⁶.

To temporarily disengage cruise control and set it in standby mode:

- Press **0**.



07 Driver support



- > The combined instrument panel's marking (5) and symbol (6) change colour from WHITE to GREY - Cruise control is temporarily disengaged.

Standby mode due to driver intervention

Cruise control is temporarily disengaged and set automatically in standby mode if:

- the foot brake is used
- the clutch pedal is depressed
- the gear lever/selector is moved to **N** position
- the driver maintains speed higher than the stored speed for longer than 1 minute.

The driver must then regulate the speed.

A temporary increase in speed with the accelerator pedal, e.g. during overtaking, does not affect the setting - the car returns to the last stored speed when the accelerator pedal is released.

Automatic standby mode

Cruise control is temporarily disengaged and set in standby mode if:

- wheels lose traction
- engine speed is too low/high
- speed falls below approx. 30 km/h.

The driver must then regulate the speed.

Related information

- Cruise control* (p. 193)
- Cruise control* - managing speed (p. 194)
- Cruise control* - resume set speed (p. 196)
- Cruise control* - deactivate (p. 197)

Cruise control* - resume set speed

The cruise control (p. 193) (CC - Cruise Control) helps the driver to maintain an even speed.

After temporary deactivation and standby mode (p. 195) it is possible to resume the set speed.

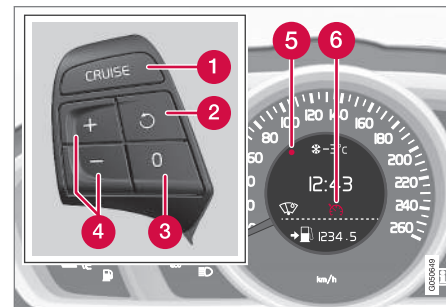

The steering wheel buttons and display in cars **without** speed limiter⁷.

⁶ A Volvo dealer has updated information about what applies in each respective market.

⁷ A Volvo dealer has updated information about what applies in each respective market.

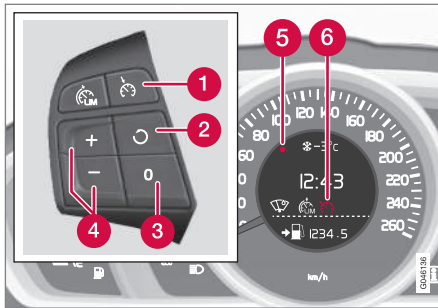

The steering wheel buttons and display in cars **with** speed limiter⁷.

To reactivate the cruise control from standby mode:

- Press the steering wheel button .
- > The combined instrument panel's marking (5) and symbol (6) change colour from GREY to WHITE - the car then follows the last stored speed.

i NOTE

A marked speed increase may occur once the speed has been resumed by selecting



Related information

- Cruise control* (p. 193)
- Cruise control* - managing speed (p. 194)

⁷ A Volvo dealer has updated information about what applies in each respective market.

⁸ A Volvo dealer has updated information about what applies in each respective market.

- Cruise control* temporary deactivation and standby mode (p. 195)
- Cruise control* - deactivate (p. 197)

Cruise control* - deactivate

How it is deactivated is described here.

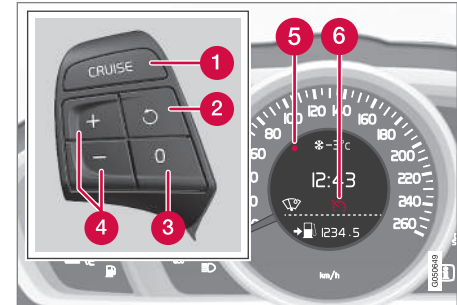

The steering wheel buttons and display in cars **without** speed limiter⁸.

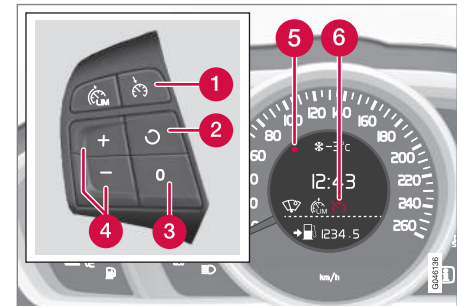

The steering wheel buttons and display in cars **with** speed limiter⁸.



The cruise control is switched off with the steering wheel button (1) or by switching off the engine - the stored speed is deleted from the memory and cannot be resumed with the  button.

Related information

- Cruise control* (p. 193)
- Cruise control* - managing speed (p. 194)
- Cruise control* temporary deactivation and standby mode (p. 195)
- Cruise control* - resume set speed (p. 196)

Adaptive cruise control (ACC)*

The adaptive cruise control (ACC – Adaptive Cruise Control) helps the driver to maintain an even speed combined with a pre-selected time interval to the vehicle ahead.

The adaptive cruise control provides a more relaxing driving experience on long journeys on motorways and long straight main roads in smooth traffic flows.

The driver sets the desired speed (p. 202) and time interval to the car in front. When the radar detector detects a slower vehicle in front of the car, the speed is automatically adapted to that. When the road is clear again the car returns to the selected speed.

If the adaptive cruise control is switched off or set to standby mode and the car comes too close to a vehicle in front, then the driver is warned instead by a Distance Alert (p. 213) about the short distance.



WARNING

The driver must always be observant with regard to the traffic conditions and intervene when the adaptive cruise control is not maintaining a suitable speed or suitable distance.

The adaptive cruise control cannot handle all traffic, weather and road conditions.

Read all the sections about the adaptive cruise control in the owner's manual in order to learn about its limitations, of which the driver should be aware before it is used.

The driver always bears responsibility for maintaining the correct distance and speed, even when the adaptive cruise control is being used.



IMPORTANT

Maintenance of adaptive cruise control components must only be performed at a workshop - an authorised Volvo workshop is recommended.

Automatic gearbox

Cars with automatic gearbox have enhanced functionality with the adaptive cruise control's Queue assistance (p. 205) function.



Related information

- Adaptive cruise control* - function (p. 199)
- Adaptive cruise control* - overview (p. 201)
- Adaptive cruise control* - managing speed (p. 202)
- Adaptive cruise control* - set time interval (p. 203)
- Adaptive cruise control* - temporary deactivation, and standby mode (p. 203)
- Adaptive cruise control* - overtaking another vehicle (p. 204)
- Adaptive cruise control* - deactivate (p. 205)
- Adaptive Cruise Control* - queue assistance (p. 205)
- Adaptive cruise control* - switch cruise control functionality (p. 207)
- Radar sensor (p. 208)
- Radar sensor - limitations (p. 208)
- Adaptive cruise control* - fault tracing and action (p. 210)
- Adaptive cruise control* - symbols and messages (p. 211)

Adaptive cruise control* - function

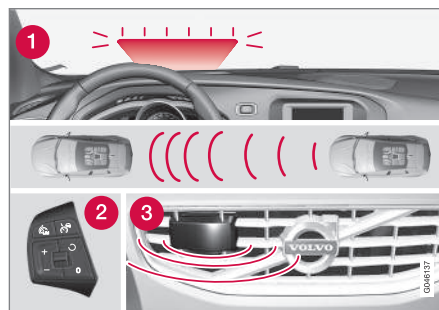

Function overview⁹.

- 1 Warning lamp - braking by driver required
- 2 Steering wheel (p. 82) keypad
- 3 Radar sensor (p. 208)

Adaptive cruise control consists of a cruise control system and a coordinated spacing system.

! WARNING

Adaptive cruise control is not a collision avoidance system. The driver must intervene if the system does not detect a vehicle in front.

The adaptive cruise control does not brake for humans or animals, and not for small vehicles such as bicycles and motorcycles. Nor for oncoming, slow or stationary vehicles and objects.

Do not use the adaptive cruise control, for example, in city traffic, in dense traffic, at junctions, on slippery surfaces, with a lot of water or slush on the road, in heavy rain/snow, in poor visibility, on winding roads or on slip roads.

The distance to the vehicle ahead is mainly measured by a radar sensor. The cruise control function regulates the speed with acceleration and braking. It is normal for the brakes to emit a low sound when they are being used by the adaptive cruise control.

! WARNING

The brake pedal moves when the adaptive cruise control brakes. Do not rest your foot beneath the brake pedal - it may then become trapped.

⁹ NOTE: The illustration is schematic - details may differ depending on car model.



07 Driver support



The adaptive cruise control aims to follow the vehicle ahead in the same lane according to what the driver set for time interval (p. 203). If the radar sensor cannot see any vehicle in front then the car will instead maintain the speed set and stored by the driver. This also takes place if the speed of the vehicle in front exceeds the stored speed.

The adaptive cruise control aims to control the speed in a smooth way. In situations that demand sudden braking the driver must brake himself/herself. This applies with large differences in speed, or if the vehicle in front brakes heavily. Due to limitations in the radar sensor (p. 208) braking may come unexpectedly or not at all.

The adaptive cruise control can be activated to follow another vehicle at speeds from 30 km/h¹⁰ up to 200 km/h. If the speed falls below 30 km/h or if the engine speed becomes too low, the cruise control is set in standby mode at which automatic braking ceases - the driver must then take over himself/herself to maintain a safe distance to the vehicle ahead.

Warning lamp - braking by driver required

Adaptive cruise control has a braking capacity that is equivalent to approx. 40% of the car's braking capacity.

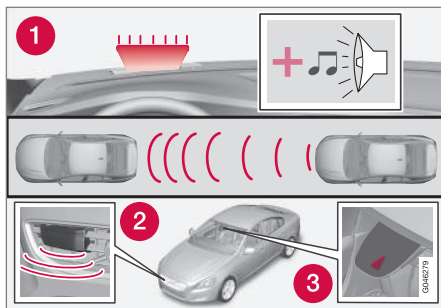

1. Collision warning system warning lamp and warning sound¹¹.

If the car needs to be braked more heavily than the adaptive cruise control capacity and the driver does not brake, then the warning lamp and warning sound from the Collision warning system (p. 223) are used in order to alert the driver that immediate intervention is required.

NOTE

The warning lamp may be difficult to see in strong sunlight or when wearing sunglasses.

WARNING

The adaptive cruise control only warns of vehicles which the radar sensor has detected. Hence the warning may not be given, or it may be given with a certain delay. Do not wait for a warning without braking when so required.

Steep roads and/or heavy load

Bear in mind that the adaptive cruise control is primarily intended for use when driving on level road surfaces. It may have difficulty in keeping the correct distance from the vehicle ahead when driving on steep downhill slopes, with a heavy load or with a trailer - in which case, be extra attentive and ready to slow down.

Related information

- Adaptive cruise control (ACC)* (p. 198)
- Adaptive cruise control* - overview (p. 201)
- Cruise control* (p. 193)

¹⁰ Queue Assist (p. 205) in cars with automatic gearbox can operate in the range of 0-200 km/h.

¹¹ NOTE: The illustration is schematic - details may vary depending on car model.



Adaptive cruise control* - overview

Operation of the adaptive cruise control (p. 198) and steering wheel keypad varies depending on whether or not the car is equipped with speed limiter (p. 189)¹².

Adaptive cruise control with Speed limiter

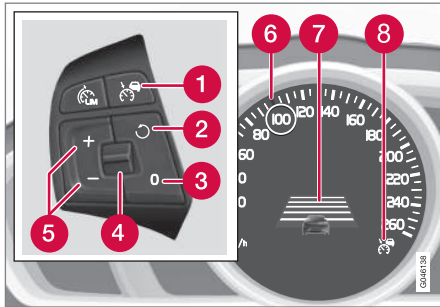

- 1 Cruise control - On/Off.
- 2 Standby mode ceases and the stored speed is resumed.
- 3 Standby mode
- 4 Time interval - Increase/decrease.
- 5 Activate and adjust the speed.
- 6 Green marking at stored speed (WHITE = standby mode).

- 7 Time distance
- 8 ACC is active at the GREEN symbol (WHITE = standby mode).

Adaptive cruise control without Speed limiter

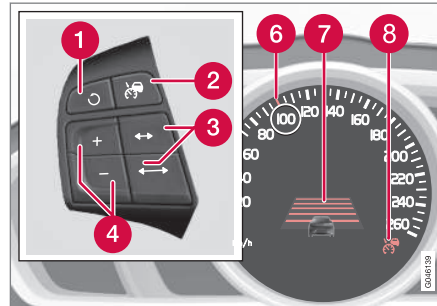

- 1 Standby mode ceases and the stored speed is resumed.
- 2 Cruise control - On/Off or Standby mode.
- 3 Time interval - Increase/decrease.
- 4 Activate and adjust the speed.
- 5 (Not used)
- 6 Green marking at stored speed (WHITE = standby mode).

- 7 Time distance
- 8 ACC is active at the GREEN symbol (WHITE = standby mode).

Related information

- Adaptive cruise control (ACC)* (p. 198)
- Adaptive cruise control* - managing speed (p. 202)
- Adaptive cruise control* - set time interval (p. 203)
- Adaptive cruise control* - temporary deactivation, and standby mode (p. 203)
- Cruise control* (p. 193)

¹² A Volvo dealer has updated information about what applies in each respective market.





Adaptive cruise control* - managing speed

To switch on ACC:

- Press the steering wheel button  - a similar WHITE symbol illuminates in the combined instrument panel (8) which shows that the adaptive cruise control is in standby mode (p. 203).

To activate ACC:

- At the required speed - press the steering wheel button  or .
- > The current speed is stored in the memory, the combined instrument panel shows a "magnifying glass" (6) around the stored speed for a second or so and its marking changes from WHITE to GREEN.



When this symbol changes colour from WHITE to GREEN, ACC is active and the car maintains the stored speed.





Only when the symbol shows an image of another vehicle is the **distance** to the vehicle in front controlled by ACC.



At the same time a speed range is marked:

- the higher speed with GREEN marking is the pre-programmed speed
- the lower speed is the speed of the vehicle in front.

Changing the stored speed

Stored speed is changed with short or long presses on the  or  button.

To adjust +/- 5 km/h:

- Use short presses - each press gives +/- 5 km/h.

To adjust +/- 1 km/h:

- Hold the button depressed and release when the combined instrument panel's mark is by the desired speed.

Last press made is stored in the memory.

If speed is increased using the accelerator pedal prior to pressing the  button, then it is the car's current speed when the button is pressed that is stored.

A temporary increase in speed with the accelerator pedal, e.g. during overtaking, does not affect the setting - the car returns to the last

stored speed when the accelerator pedal is released.



NOTE

If any of the adaptive cruise control buttons are held depressed for several minutes then the function is blocked and deactivated. To be able to reactivate it, the car must be stopped and the engine restarted.

In certain situations it cannot be reactivated - in which case, the combined instrument panel (p. 211) shows **Adaptive cruise control unavailable**.

Related information

- Adaptive cruise control (ACC)* (p. 198)
- Adaptive cruise control* - overview (p. 201)
- Cruise control* (p. 193)





Adaptive cruise control* - set time interval



Different time intervals to the vehicle in front can be selected and shown in the combined instrument panel as 1-5 horizontal lines - the more lines the longer the time interval. One line corre-

sponds to approximately 1 second to the vehicle in front, 5 lines approximately 3 seconds.

To set/change the time distance:

- Turn the steering wheel button set's thumbwheel (or use the / buttons for cars without Speed limiters).

At low speed, when the distances are short, the adaptive cruise control increases the time interval slightly.

The adaptive cruise control allows the time interval to vary noticeably in certain situations in order to allow the car to follow the vehicle in front smoothly and comfortably.

Note that a short time interval only allows the driver a short time to react and take action if any unforeseen traffic problem should arise.

The same symbol is also shown when Distance Alert (p. 213) is activated.

NOTE

Only use the time intervals permitted by local traffic regulations.

If the adaptive cruise control does not appear to react when activated, this may be because the time distance to the vehicle in front is preventing an increase in speed.

The higher the speed the longer the calculated distance in metres for a given time interval.

Read more how speed is handled (p. 202).

Related information

- Adaptive cruise control (ACC)* (p. 198)
- Adaptive cruise control* - overview (p. 201)
- Cruise control* (p. 193)

Adaptive cruise control* - temporary deactivation, and standby mode

The adaptive cruise control can be temporarily deactivated and set in standby mode.

Temporary deactivation/standby mode - with speed limiter

To temporarily disengage adaptive cruise control and set it in standby mode:

- Press the steering wheel button 



This symbol and stored speed marking then changes colour from GREEN to WHITE.

Temporary deactivation/standby mode - without speed limiter

To temporarily disengage adaptive cruise control and set it in standby mode:

- Press the steering wheel button 

Standby mode due to driver intervention

The adaptive cruise control is temporarily disengaged and set automatically in standby mode if:

- the foot brake is used
- the clutch pedal is depressed for longer than 1 minute¹³

¹³ Disengaging and selecting a higher or lower gear does not involve standby mode.



- the gear selector is moved to **N** position (automatic gearbox)
- the driver maintains speed higher than the stored speed for longer than 1 minute.

The driver must then regulate the speed.

A temporary increase in speed with the accelerator pedal, e.g. during overtaking, does not affect the setting - the car returns to the last stored speed when the accelerator pedal is released.

For more information, see the sections Managing speed (p. 202) and Overtaking another vehicle (p. 204).

Automatic standby mode

The adaptive cruise control is dependent on other systems, e.g. Stability system ESC (p. 183). If any of these systems stops working, the adaptive cruise control is deactivated automatically.

In the event of automatic deactivation a signal will sound and the message **Adaptive cruise control cancelled** is shown in the combined instrument panel. The driver must then intervene and adapt the speed and distance to the vehicle ahead.

An automatic deactivation can be due to:

- the driver opens the door
- the driver takes off his seatbelt

- engine speed is too low/high
- speed has fallen below 30 km/h¹⁴
- wheels lose traction
- brake temperature is high
- the radar sensor is covered e.g. by wet snow or heavy rain (radar waves blocked).

For more information on symbols, messages and their meaning, see section Symbols and messages in the display (p. 211).

Resume set speed

Adaptive cruise control in standby mode is reactivated with one press on the steering wheel button  - the speed is then set to the last stored speed.



NOTE

A marked speed increase may occur once the speed has been resumed by selecting .

Related information

- Adaptive cruise control (ACC)* (p. 198)
- Adaptive cruise control* - overview (p. 201)
- Cruise control* (p. 193)

Adaptive cruise control* - overtaking another vehicle

ACC can also assist during overtaking.

When the car is following another vehicle and the driver indicates an impending overtaking manoeuvre with the direction indicator¹⁵, the adaptive cruise control helps to briefly accelerate the car towards the vehicle in front.

This function is active at speeds above 70 km/h.

Read more about the different time intervals (p. 203) to the vehicle in front.

Read more about how you manage the speed (p. 202).



WARNING

Be aware that this function can be activated in more situations other than during overtaking, e.g. when a direction indicator is used to indicate a change of lane or exit to another road - the car will then accelerate briefly.

Related information

- Adaptive cruise control (ACC)* (p. 198)
- Adaptive cruise control* - overview (p. 201)
- Cruise control* (p. 193)



¹⁴ Does not apply to a car with Queue Assist - it can go all the way down to 0 km/h.

* Option/accessory, for more information, see Introduction.





Adaptive cruise control* - deactivate

Keypad with Speed limiter

The adaptive cruise control is disengaged with a **short** press of the steering wheel button . The set speed is cleared and cannot be resumed with the  button.

Keypad without Speed limiter

A **short** press on the steering wheel button  sets the adaptive cruise control in standby mode. With a further short press it is deactivated. The set speed is cleared and cannot be resumed with the  button.

Related information

- Adaptive cruise control (ACC)* (p. 198)
- Adaptive cruise control* - overview (p. 201)
- Cruise control* (p. 193)

Adaptive Cruise Control* - queue assistance

Queue assistance also provides the adaptive cruise control with enhanced functionality at speeds lower than 30 km/h.

In cars with automatic gearbox the adaptive cruise control is supplemented with the queue assistance function (also referred to as "Queue Assist").

Queue assistance has the following functions:

- Extended speed range - also at lower than 30 km/h and at stationary
- Change of target
- Automatic braking ceases when stationary

Note that the lowest programmable speed for the adaptive cruise control is 30 km/h - even though the cruise control is capable of following another vehicle down to a standstill, a lower speed **cannot** be selected.

Learn more about how you manage the speed (p. 198) and different time intervals to the vehicle in front (p. 203).

Extended speed range

NOTE

In order to activate the cruise control the driver's door must be closed and the driver must be wearing the seatbelt.

With an automatic gearbox, the adaptive cruise control can follow another vehicle within the range 0-200 km/h.

NOTE

Activation of the cruise control below 30 km/h requires a vehicle in front within a reasonable distance.

For shorter stops in connection with inching in slow traffic or at traffic lights driving is automatically resumed if the stops do not exceed approx. 3 seconds - if it takes longer before the car in front starts moving again then the cruise control is set in standby mode (p. 203) with automatic braking. The driver must then reactivate it in one of the following ways:

- Press the steering wheel button .
- or
- Depress the accelerator pedal.
- > The cruise control will then resume following the vehicle in front.

¹⁵ On left flash only in left-hand-drive car, or right flash in right-hand-drive car.



NOTE

Queue Assist can keep the car stationary for a maximum of 4 minutes - then the brakes release.

See more information under the header below, "Cessation of automatic braking when stationary".

Change of target

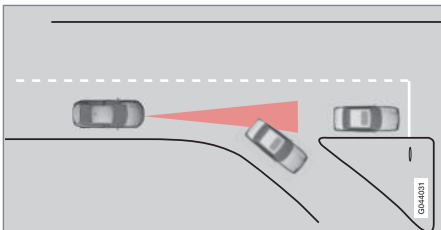

If the target vehicle in front suddenly turns then there may be stationary traffic in front.

When the adaptive cruise control is following another vehicle at speeds **lower** than 30 km/h and changes target from a moving to a stationary vehicle, the cruise control will slow down for the stationary vehicle.

WARNING

When the adaptive cruise control is following a vehicle ahead at speeds **in excess of** 30 km/h and the target is changed from a vehicle ahead to a stationary vehicle, the cruise control will ignore the stationary vehicle and instead select the stored speed.

- The driver must intervene him/herself and brake.

Automatic standby mode with change of target

The adaptive cruise control is disengaged and set in standby mode:

- when the speed is below 5 km/h and cruise control is not sure whether the target object is a stationary vehicle or some other object, e.g. a speed bump.
- when the speed is below 5 km/h and the vehicle in front turns off so the cruise control no longer has a vehicle to follow.

Termination of automatic braking at a standstill

In the following situations, queue assistance stops automatic braking at a standstill:

- the driver opens the door
- the driver takes off his seatbelt.

This means that the brakes are released and the car will start to roll - the driver must there-

fore intervene and brake the car himself in order to maintain its position.

IMPORTANT

Queue Assist can keep the car stationary for a maximum of 4 minutes - then the brakes release.

The driver's attention is drawn to this over several stages, with increasing intensity:

1. Acoustic alarm (pinging) and text message.
2. A warning lamp in the windscreen also starts to flash.
3. "Stabbing" braking occurs.

For more information on symbols, messages and their meaning, see the section Symbols and messages in the display (p. 211).

Queue assistance releases the foot brake and is set to standby mode in these situations as well:



- the driver puts his/her foot on the brake pedal
- the gear selector is moved to **P**, **N** or **R** position
- the driver sets the cruise control in standby mode
- the parking brake is applied.

**Related information**



- Adaptive cruise control (ACC)* (p. 198)
- Adaptive cruise control* - overview (p. 201)
- Cruise control* (p. 193)

Adaptive cruise control* - switch cruise control functionality**Changing from ACC to CC**

A symbol for active cruise control is shown in the combined instrument panel:

CC Cruise Control	ACC Adaptive Cruise Control
	
Cruise control	Adaptive cruise control

With one press of the button the adaptive element (spacing system) in the adaptive cruise control (p. 198) is deactivated, at which point the car only follows the set/stored speed.

- **Hold down** the steering wheel button  - the combined instrument panel's symbol changes from  to .
- > This activates Cruise Control CC.

 WARNING

The car no longer brakes automatically after switching from ACC to CC - it merely follows the set speed.

Changing back from CC to ACC

Switch off the cruise control (CC) with 1-2 presses on the  button. The next time the system is switched on it is the adaptive cruise control (ACC) that is activated.

Related information

- Adaptive cruise control (ACC)* (p. 198)
- Adaptive cruise control* - overview (p. 201)
- Adaptive cruise control* - temporary deactivation, and standby mode (p. 203)
- Cruise control* (p. 193)



Radar sensor

The function of the radar sensor is to detect cars or larger vehicles in the same direction, in the same lane.

The radar sensor is used by the following functions:

- Distance Warning*
- Adaptive cruise control*
- Collision Warning with Auto Brake and Pedestrian Detection*

! IMPORTANT

In the event of visible damage to the car's grille, or if you suspect that the radar sensor may be damaged:

- Contact a workshop - an authorised Volvo workshop is recommended.

The function may completely or partially disappear - or malfunction - if the grille, the radar sensor or its bracket is damaged or has loosened.

Modification of the radar sensor could result in it being illegal to use.

Related information

- Radar sensor - limitations (p. 208)
- Adaptive cruise control (ACC)* (p. 198)
- Collision warning system* (p. 223)
- Distance Warning* (p. 213)

Radar sensor - limitations

A radar sensor (p. 208) has certain limitations - due to its limited field of vision for example.

The capacity of the adaptive cruise control to detect a vehicle in front is significantly reduced if:

- the speed of vehicles in front is significantly different from your own speed
- its radar sensor becomes blocked - e.g. in heavy rain or slush, or if other objects have collected in front of the radar sensor.

i NOTE

Keep the surface in front of the radar sensor clean.

Field of vision

The radar sensor has a limited field of vision. In some situations another vehicle is not detected, or the detection is made later than expected.

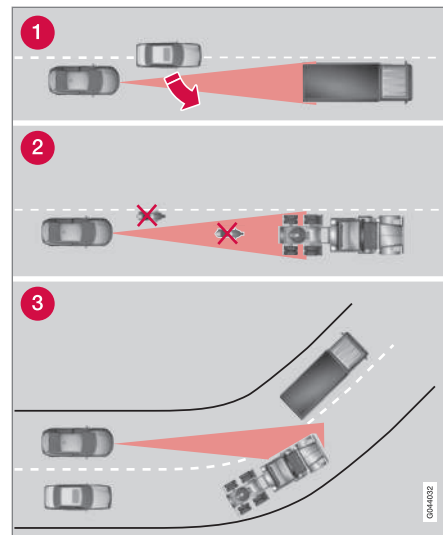

ACC field of vision.

- 1 Sometimes the radar sensor is late at detecting vehicles at close distances - e.g. a vehicle that drives in between the car and vehicles in front.
- 2 Small vehicles, such as motorcycles, or vehicles not driving in the centre of the lane can remain undetected.
- 3 In bends the radar sensor may detect the wrong vehicle or lose a detected vehicle from view.

**! WARNING**

The driver must always be observant with regard to the traffic conditions and intervene when the adaptive cruise control is not maintaining a suitable speed or suitable distance.

The adaptive cruise control cannot handle all traffic, weather and road conditions.

Read all the sections about the adaptive cruise control in the owner's manual in order to learn about its limitations, of which the driver should be aware before it is used.

The driver always bears responsibility for maintaining the correct distance and speed, even when the adaptive cruise control is being used.

! WARNING

Accessories or other objects such as auxiliary lamps must not be fitted in front of the grille.

! WARNING

Adaptive cruise control is not a collision avoidance system. The driver must intervene if the system does not detect a vehicle in front.

The adaptive cruise control does not brake for humans or animals, and not for small vehicles such as bicycles and motorcycles. Nor for oncoming, slow or stationary vehicles and objects.

Do not use the adaptive cruise control, for example, in city traffic, in dense traffic, at junctions, on slippery surfaces, with a lot of water or slush on the road, in heavy rain/snow, in poor visibility, on winding roads or on slip roads.

Related information

- Adaptive cruise control (ACC)* (p. 198)
- Collision warning system* (p. 223)
- Distance Warning* (p. 213)



07 Driver support

Adaptive cruise control* - fault tracing and action

If the combined instrument panel shows the message **Radar blocked** See manual then it means that the adaptive cruise control's radar

sensor (p. 208) cannot detect other vehicles in front of the car.

This message indicates that neither of the functions for Distance Alert (p. 213) or Colli-

sion Warning with Auto Brake (p. 223) are working.

The following table presents examples of possible causes for a message being shown along with the appropriate action:

Cause	Action
The radar surface in the grille is dirty or covered with ice or snow.	Clean the radar surface in the grille from dirt, ice and snow.
Heavy rain or snow blocking the radar signals.	No action. Sometimes the radar does not work during heavy rain or snowfall.
Water or snow from the road surface swirls up and blocks the radar signals.	No action. Sometimes the radar does not work on a very wet or snowy road surface.
The radar surface has been cleaned but the message remains.	Wait. It could take several minutes for the radar to sense that it is no longer blocked.

Related information





- Adaptive cruise control (ACC)* (p. 198)
- Adaptive cruise control* - overview (p. 201)
- Cruise control* (p. 193)



Adaptive cruise control* - symbols and messages

Sometimes the adaptive cruise control may display a symbol and/or text message. Here

are some examples - follow the recommendation given if appropriate:

Symbol ^A	Message	Specification
	The symbol is WHITE	Adaptive cruise control is set to standby mode (p. 203).
	The symbol is GREEN	The car maintains the stored speed.
		Standard cruise control is selected manually.
	Set ESC to Normal to enable Cruise	The adaptive cruise control cannot be activated until ESC has been set in Normal mode - Stability system (p. 183).
	Adaptive cruise control cancelled	The adaptive cruise control has been deactivated - the driver has to regulate the speed himself.
	Adaptive cruise control unavailable	The adaptive cruise control cannot be activated. This could be due to: <ul style="list-style-type: none"> • brake temperature is high • the radar sensor is blocked by e.g. wet snow or rain. For more information about fault tracing, see section Fault tracing and action (p. 210)
	Radar blocked See manual	The adaptive cruise control is temporarily disengaged. <ul style="list-style-type: none"> • The radar sensor is blocked and cannot detect other vehicles. For example, in the event of heavy rain or if slush has collected in front of the radar sensor. The driver can then choose to switch to normal Cruise control (p. 193) (CC) - a text message provides information on appropriate alternatives. Read more about radar sensor limitations (p. 208).





Symbol ^A	Message	Specification
	Adaptive cruise control Service required	The adaptive cruise control is disengaged. <ul style="list-style-type: none">• Contact a workshop - an authorised Volvo workshop is recommended.
	Press brake to hold vehicle + acoustic alarm + warning light in windscreen + "pulling" brakes (Only with Queue Assist)	The car is at a standstill and the adaptive cruise control will release the foot brake, which is why the car may start rolling soon. <ul style="list-style-type: none">• The driver must brake himself/herself. The message remains and the alarm sounds until the driver depresses the brake pedal or uses the accelerator pedal.
	Below 30 km/h Lead vehicle required (Only with Queue Assist)	Shown in the event of attempts to activate the adaptive cruise control at speeds below 30 km/h without a vehicle in front within the activation distance.

^A The symbols are schematic.

Related information

- Adaptive cruise control (ACC)* (p. 198)
- Adaptive cruise control* - overview (p. 201)
- Cruise control* (p. 193)



Distance Warning*

The Distance Warning function (Distance Alert) warns the driver if the time interval to the vehicle ahead becomes too short.

Distance Warning is active at speeds above 30 km/h and only reacts to vehicles driving in front of the car, in the same direction. No distance information is provided for oncoming, slow or stationary vehicles.

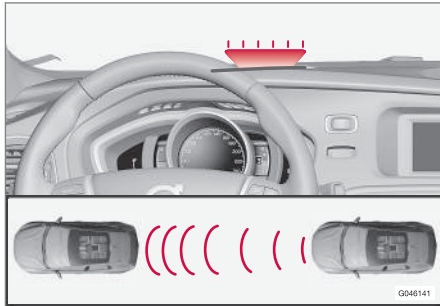

Orange-coloured warning lamp¹⁶.

An orange-coloured warning lamp in the windscreen illuminates with a constant glow if the distance to the vehicle in front is shorter than the set time interval.

NOTE

Distance warning is deactivated during the time the adaptive cruise control is active.

WARNING

Distance warning only reacts if the distance to the vehicle ahead is shorter than the preset value - the speed of the driver's vehicle is not affected.

Operation



Press the button in the centre console to switch the function on or off. The function is switched on if one lamp is illuminated in the button.

Some combinations of the selected equipment leave no vacant space for a button in the centre console - in which case, the func-

tion is operated in the car's menu system **MY CAR** (p. 108) - once there, search for the **Distance Alert** function.

Set time interval

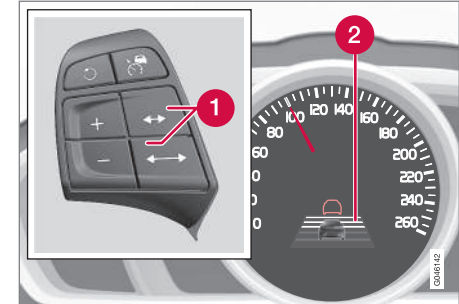

Controls and symbol for time interval.

- 1 Time interval - Increase/decrease.
- 2 Time interval - On.

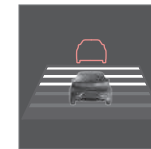

Different time intervals to the vehicle in front can be selected and shown in the combined instrument panel as 1-5 horizontal lines - the more lines the longer the time interval. One line corresponds to approximately 1 second to the vehicle in front, 5 lines approximately 3 seconds.

¹⁶ NOTE: The illustration is schematic - details may vary depending on car model.



The same symbol is also shown when adaptive cruise control (p. 198) is activated.

NOTE

The higher the speed the longer the calculated distance in metres for a given time interval.

The set time interval is also used by the function adaptive cruise control (p. 199).

Only use the time intervals permitted by local traffic regulations.

Related information

- Distance Warning* - limitations (p. 214)
- Distance Warning* - symbols and messages (p. 215)

Distance Warning* - limitations

This function, which uses the same radar sensor as Adaptive cruise control (p. 198) and Collision warning with auto brake (p. 223), has certain limitations.

NOTE

Strong sunlight, reflections or strong variations in light intensity, as well as wearing sunglasses, could mean that the warning light in the windscreen cannot be seen.

Poor weather or winding roads could affect the radar sensor's capacity to detect vehicles in front.

The size of other vehicles could also affect detection capacity, e.g. motorcycles. This could mean that the warning lamp illuminates at a shorter distance than the setting or that the warning is temporarily absent.

Extremely high speeds can also cause the lamp to illuminate at a shorter distance than that set due to limitations in sensor range.

For further information on radar sensor limitations, see Radar sensor - limitations (p. 208) and Collision warning system* - operation (p. 227).

Related information



- Distance Warning* (p. 213)
- Distance Warning* - symbols and messages (p. 215)



Distance Warning* - symbols and messages

instrument panel if the function is reduced due to its limitations (p. 214).

The function has certain symbols and messages that can be shown in the combined

Symbol ^A	Message	Specification
	Radar blocked See manual	Distance Warning temporarily disengaged. Radar sensor (p. 208) is blocked and cannot detect other vehicles. For example, in the event of heavy rain or if slush has collected in front of the radar sensor. For information, see Radar sensor - limitations (p. 208).
	Collision warning Service required	Distance Warning and Collision Warning with Auto Brake (p. 228) fully or partially disengaged. Visit a workshop if the message remains - an authorised Volvo workshop is recommended.

^A The symbols are schematic.



City Safety™

City Safety™ is a function for helping the driver to avoid a collision when driving in queues, amongst other things, when changes in the traffic ahead, combined with a lapse in attention, could lead to an incident.

The City Safety™ function is active at speeds under 50 km/h and it helps the driver by automatically braking the car in the event of imminent risk of collision with vehicles in front, should the driver not react in time by braking and/or steering away.

City Safety™ is activated in situations where the driver should have started braking earlier, which is why it cannot help the driver in every situation.

City Safety™ is designed to be activated as late as possible in order to avoid unnecessary intervention.

City Safety™ must not be used as an excuse for the driver to change his/her driving style. If the driver solely relies on City Safety™ to do the braking, there might be a risk of a collision sooner or later.

The driver or passengers normally only notice City Safety™ if a situation arises where the car is extremely close to being in a collision.

If the car is also equipped with Collision Warning with Auto Brake* (p. 223) these two systems complement each other.

IMPORTANT

Maintenance and replacement of City Safety™ components must only be performed by a workshop - an authorised Volvo workshop is recommended.

WARNING

City Safety™ does not engage in all driving situations or traffic, weather or road conditions.

City Safety™ does not react to vehicles driving in a different direction from the car, to small vehicles and motorcycles or to people and animals.

City Safety™ can prevent collision at a speed difference of less than 15 km/h - at a higher speed difference, it is only possible to reduce collision speed. In order to obtain full brake function, the driver must depress the brake pedal.

Never wait for City Safety™ to engage. The driver always bears responsibility for maintaining the proper distance and speed.

City Safety™ - function

City Safety™ detects the traffic in front of the car with a laser sensor (p. 220) fitted in the top edge of the windscreen. If there is an imminent risk of collision, City Safety™ will automatically brake the car, which may be experienced as sudden braking.

Related information

- City Safety™ - limitations (p. 218)
- City Safety™ - function (p. 216)
- City Safety™ - operation (p. 217)
- City Safety™ - laser sensor (p. 220)
- City Safety™ - symbols and messages (p. 222)

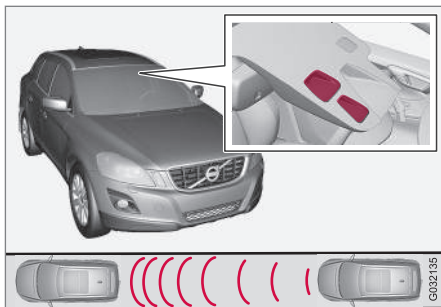

Laser sensor transmitter and receiver window¹⁷.

If the speed difference is 4-15 km/h in relation to the vehicle in front then City Safety™ can completely prevent a collision.

City Safety™ activates a short, sharp braking and stops the car in normal circumstances, just behind the vehicle in front. For most drivers this is well outside normal driving style and may be experienced as being uncomfortable.

If the difference in speed between the vehicles is greater than 15 km/h then City Safety™ may not prevent the collision on its own. To obtain full brake force, the driver must depress the brake pedal. This could then make it possible to prevent a collision, even at speed differences above 15 km/h.

When the function is activated and brakes, the combined instrument panel shows a message (p. 222) to the effect that the function is/has been active.

NOTE

When City Safety™ brakes, the brake lights come on.

Related information

- City Safety™ (p. 216)
- City Safety™ - operation (p. 217)
- City Safety™ - limitations (p. 218)

City Safety™ - operation

City Safety™ is a function for helping the driver to avoid a collision when driving in queues, amongst other things, when changes in the traffic ahead, combined with a lapse in attention, could lead to an incident.

On and Off

NOTE

The City Safety™ function is activated automatically when the engine is started.

In certain situations, it may be advisable to disable City Safety™, e.g. where leafy branches could sweep over the bonnet and/or windscreen.

City Safety™ handled in the menu system **MY CAR** (p. 108) and after starting the engine the function can be deactivated as follows:

- Search in **MY CAR** for **Driver support system** and select the **Off** option at **City Safety**.

However, the function will be enabled the next time the engine is started, regardless of whether the system was enabled or disabled when the engine was switched off.

¹⁷ NOTE: The illustration is schematic - details may vary depending on car model.



WARNING

The laser sensor (p. 220) emits laser light even when City Safety™ is disabled manually.

To enable City Safety™ again:

- Follow the same procedure as for disabling, but select the **On** option.

Related information

- City Safety™ (p. 216)
- City Safety™ - limitations (p. 218)
- City Safety™ - symbols and messages (p. 222)

City Safety™ - limitations

The sensor in City Safety™ is designed to detect cars and other large vehicles in front of the car irrespective of whether it is day or night.

However, the function does have some limitations.

The sensor's limitations mean that City Safety™ has poorer functionality - or none at all - in e.g. heavy snowfall or rain, dense fog, dust storms or white-out situations. Misting, dirt, ice or snow on the windscreen may also disrupt the function.

Low-hanging objects, e.g. a flag/pennant for projecting load, or accessories such as auxiliary lamps and bull bars that are higher than the bonnet limit the function.

The laser light from the sensor in City Safety™ measures how the light is reflected. The sensor cannot detect objects with low reflection capacity. The rear sections of the vehicle generally reflect the light sufficiently thanks to the number plate and rear light reflectors.

On slippery road surfaces the braking distance is extended, which may reduce the capacity of City Safety™ to avoid a collision. In such situations the ABS¹⁸ and ESC¹⁹ sys-

tems will provide best possible braking force with maintained stability.

When your own car is reversing, City Safety™ is temporarily deactivated.

City Safety™ is not activated at low speeds - under 4 km/h, which is why the system does not intervene in situations where a vehicle in front is being approached very slowly, e.g. when parking.

Driver commands are always prioritised, which is why City Safety™ does not intervene in situations where the driver is steering or accelerating in a clear manner, even if a collision is unavoidable.

When City Safety™ has prevented a collision with a stationary object the car remains stationary for a maximum of 1.5 seconds. If the car is braked for a vehicle in front that is moving, then speed is reduced to the same speed as that maintained by the vehicle in front.

On a car with manual gearbox the engine stops when City Safety™ has stopped the car, unless the driver manages to depress the clutch pedal beforehand.

¹⁸ (Anti-lock Braking System) - Anti-lock braking system.

¹⁹ (Electronic Stability Control) - Stability system.

**i NOTE**

- Keep the windscreen surface in front of the laser sensor (p. 220) free from ice, snow and dirt. For an illustration of sensor location, see City Safety™ - function (p. 216).
- Do not affix or mount anything on the windscreen in front of the laser sensor
- Remove ice and snow from the bonnet - snow and ice must not exceed a height of 5 cm.

Fault tracing and action

If the message (p. 222) **Windscreen sensors blocked** See manual is shown in the combined instrument panel it indicates that the laser sensor is blocked and cannot detect vehicles in front of the car. This means that City Safety™ is not operational.

The **Windscreen sensors blocked** See manual message is not shown for all situations in which the laser sensor is blocked. The driver must therefore be diligent about keeping the windscreen and area in front of the laser sensor clean.

The following table presents possible causes for the message being shown, along with suggestions for appropriate action.

Cause	Action
The windscreen surface in front of the laser sensor is dirty or covered with ice or snow.	Clean the windscreen surface in front of the sensor from dirt, ice and snow.
The laser sensor field of vision is blocked.	Remove the blocking object.

i IMPORTANT

If there are cracks, scratches or stone chips in the windscreen in front of either of the laser sensor's "windows" and they cover a surface of approx. 0.5 x 3.0 mm (or larger), then a workshop must be contacted for replacement of the windscreen - an authorised Volvo workshop is recommended. For an illustration of sensor location, see City Safety™ - function (p. 216).

Failure to take action may result in reduced performance for City Safety™.

To avoid the risk of failed, deficient or reduced operation for City Safety™, the following also applies:

- Volvo recommends that you do **not** repair cracks, scratches or stone chips in the area in front of the laser sensor - instead, the whole windscreen should be replaced.
- Before replacing a windscreen, contact an authorised Volvo workshop to verify that the correct windscreen is ordered and fitted.
- The same type or Volvo-approved windscreen wipers must be fitted during replacement.

Related information

- City Safety™ (p. 216)
- City Safety™ - function (p. 216)
- City Safety™ - operation (p. 217)



City Safety™ - laser sensor

The City Safety™ function includes a sensor which transmits laser light. Contact a qualified workshop in the event of a fault or if the laser sensor needs servicing - an authorised Volvo workshop is recommended. It is absolutely essential to follow the prescribed instructions when handling the laser sensor.

The following two labels relate to the laser sensor:

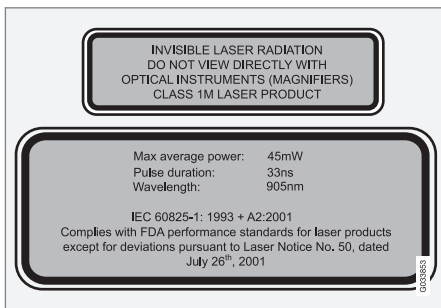

The upper label in the figure describes the laser beam's classification:

- Laser radiation - Do not look into the laser beam with optical instruments - Class 1M laser product.

The lower label in the figure describes the laser beam's physical data:

- IEC 60825-1:1993 + A2:2001. Complies with FDA (U.S. Food Administration)

standards for laser product design with the exception of deviations in accordance with "Laser Notice No. 50" from 26 July 2001.

Radiation data for the laser sensor

The following table specifies the laser sensor's physical data.

Maximum pulse energy	2.64 µJ
Maximum average output	45 mW
Pulse duration	33 ns
Divergence (horizontal x vertical)	28° × 12°



WARNING

If any of these instructions are not followed then there is a risk of eye injury!

- Never look into the laser sensor (which emits spreading invisible laser radiation) at a distance of 100 mm or closer with magnifying optics such as a magnifying glass, microscope, lens or similar optical instruments.
- Testing, repair, removal, adjustment and/or replacement of the laser sensor's spare parts must only be carried out by a qualified workshop - we recommend an authorised Volvo workshop.
- To avoid exposure to harmful radiation, do not carry out any readjustments or maintenance other than those specified here.
- The repairer must follow specially drawn up workshop information for the laser sensor.
- Do not remove the laser sensor (this includes removing the lenses). A removed laser sensor fulfils laser class 3B as per standard IEC 60825-1. Laser class 3B is not eye-safe and therefore entails a risk of injury.
- The laser sensor's connector must be unplugged before removal from the windscreen.



- The laser sensor must be fitted onto the windscreen before the sensor's connector is plugged in.
- The laser sensor transmits a laser light when the remote control key is in key position II (p. 76) even if the engine is switched off.

Related information

- City Safety™ (p. 216)





City Safety™ - symbols and messages

In conjunction with automatic braking by the City Safety (p. 216)™ system, one or more

symbols (p. 222) may illuminate in the combined instrument panel and a text message may be shown. A text message can be

acknowledged by briefly pressing the **OK** button on the direction indicator stalk.

Symbol ^A	Message	Meaning/Action
	Auto braking by City Safety	City Safety™ is braking or has automatically braked.
	Windscreen sensors blocked See manual	The laser sensor is temporarily non-operational because something is blocking it. <ul style="list-style-type: none"> Remove the object blocking the sensor and/or clean the windscreen in front of the sensor. Read about the laser sensor's limitations.
	City Safety Service required	City Safety™ is not operational. <ul style="list-style-type: none"> Visit a workshop if the message remains - an authorised Volvo workshop is recommended.

^A The symbols are schematic.

Related information

- City Safety™ (p. 216)
- City Safety™ - function (p. 216)



Collision warning system*

"Collision Warning with Auto Brake and Cyclist and Pedestrian Detection" is an aid to assist the driver when there is a risk of colliding with a pedestrian, cyclist or vehicle in front that are stationary or moving in the same direction.

"Collision Warning with Auto Brake and Cyclist and Pedestrian Detection" is activated in situations where the driver should have started braking earlier, which is why it cannot help the driver in every situation.

"Collision Warning with Auto Brake and Cyclist and Pedestrian Detection" is designed to be activated as late as possible in order to avoid unnecessary intervention.

"Collision Warning with Auto Brake and Cyclist and Pedestrian Detection" can prevent a collision or reduce collision speed.

"Collision Warning with Auto Brake and Cyclist and Pedestrian Detection" must not be used as an excuse for the driver to change his/her driving style. If the driver solely relies on Collision Warning with Auto Brake to do the braking, there might be a risk of a collision sooner or later.

Two system levels

Depending on how the car is equipped, the "Collision Warning with Auto Brake and

Cyclist and Pedestrian Detection" function may appear in two variants:

Level 1

The driver is merely warned²⁰ of occurring obstacles by means of visual and acoustic signals - no automatic braking intervenes, the driver must himself brake.

Level 2

The driver is warned of occurring obstacles by means of visual and acoustic signals - the car is braked automatically if the driver himself does not act within a reasonable time.



IMPORTANT

Maintenance of the internal components of the "Collision Warning with Auto Brake and Cyclist and Pedestrian Detection" must only be performed at a workshop - an authorised Volvo workshop is recommended.

Related information

- Collision warning system* - function (p. 224)
- Collision warning system* - detection of pedestrians (p. 226)
- Collision warning system* - detection of cyclists (p. 225)
- Collision warning system* - operation (p. 227)

- Collision warning system* - limitations (p. 228)
- Collision warning system* - camera sensor limitations (p. 229)
- Collision warning system* - symbols and messages (p. 231)

²⁰ No warning for cyclists with "Level 1".



Collision warning system* - function

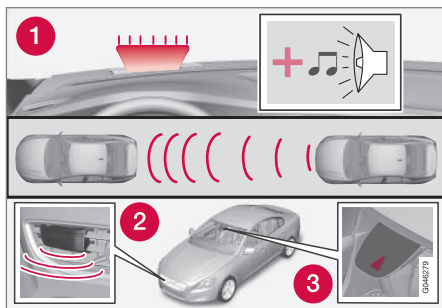

Function overview²¹.

- 1 Audio-visual warning signal in the event of a collision risk.
- 2 Radar sensor²²
- 3 Camera sensor

Collision Warning with Auto Brake executes three steps in the following order:

1. **Collision warning**
2. **Brake support**²²
3. **Auto Brake**²²

The collision warning system and City Safety™ (p. 216) complement each other.

1 - Collision warning

The driver is first warned of a potentially imminent collision.

The collision warning system can detect pedestrians, cyclists or vehicles that are stationary or moving in the same direction in front of the driver's vehicle.

If there is a risk of collision with a pedestrian, cyclist or a vehicle then the driver's attention is attracted with a flashing red warning signal (1) and an acoustic signal.

2 - Brake support

If the risk of collision has increased further after the collision warning then the brake support is activated.

This means that the brake system is prepared for rapid braking by applying the brakes lightly, which may feel like a slight jolt.

If the brake pedal is depressed sufficiently quickly then full brake function is implemented.

Brake support also reinforces the driver's braking if the system considers that the braking is not sufficient to avoid a collision.

3 - Auto Brake

The automatic brake function is activated last.

If in this situation the driver has not yet started to take evasive action and the risk of collision is imminent then the automatic braking function is deployed - this takes place irrespective of whether or not the driver brakes. Braking then takes place with full brake force in order to reduce collision speed, or with limited brake force if it is sufficient to avoid a collision. For cyclists, the warning and full brake intervention may come very late or simultaneously.

²¹ NOTE: The illustration is schematic - details may vary depending on car model.

²² With system Level 2 only.



! WARNING

The collision warning system does not engage in all driving situations or traffic, weather or road conditions. The collision warning system does not react to vehicles or cyclists driving in another direction to the car or to animals.

Warning only activated in the event of a high risk for collision. This section "Function" and the section "Limitations" inform about limitations that the driver must be aware of before using the Collision Warning system with Auto Brake.

Warnings and brake interventions for pedestrians and cyclists are deactivated at a vehicle speed exceeding 80 km/h.

Warnings and brake interventions for pedestrians and cyclists do not work in darkness and tunnels - not even when streetlights are lit.

The auto-brake function can prevent a collision or reduce collision speed. To ensure full brake performance, the driver should always depress the brake pedal - even when the car auto-brakes.

Never wait for a collision warning. The driver is always responsible that the correct distance and speed are maintained - even when the collision warning system with auto-brake is used.

Related information

- Collision warning system* (p. 223)

²³ The reflector must fulfil the recommendations and conditions of the traffic authority in the market in question.

Collision warning system* - detection of cyclists

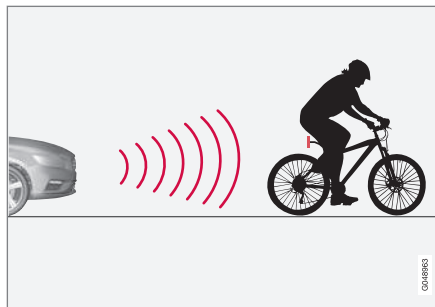

The function only "sees" cyclists from behind, who are travelling in the same direction.

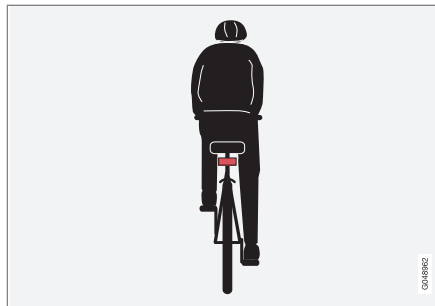

Optimal example of what the system interprets as a cyclist - with clear body and bicycle con-

tours, directly from behind and in the car's centre line.

Optimal performance of the system requires that the system function that detects a cyclist receives as unambiguous information as possible about the body and bicycle contours - this implies the opportunity to identify the bicycle, head, arms, shoulders, legs, upper and lower body combined with a normal human pattern of movement.

If large parts of the cyclist's body or bicycle are not visible to the function's camera then the system cannot detect a cyclist.

- For the function to be able to detect a cyclist, he/she must be an adult and riding an "adult bicycle".
- The function can only detect cyclists directly from behind and who are travelling in the same direction - not at an angle from behind, not from the side.
- The bicycle must be equipped with a highly visible and approved²³ rearward-facing red reflector, fitted at least 70 cm above the roadway.
- Cyclists travelling on the left or right-hand edge of the car's imagined/extended side lines may be detected late or not at all.
- The function's capacity to detect cyclists at dusk and dawn is limited - just like the human eye.



07 Driver support



- The function's capacity to detect cyclists is deactivated when driving in darkness and tunnels - even when streetlights are lit.
- For optimum bicycle detection, the City Safety™ function must be activated, see City Safety™ (p. 216).

WARNING

Collision Warning with Auto Brake & Cyclist Detection is a means of assistance.

The function cannot detect:

- all cyclists in all situations and does not see partially obscured cyclists, for example.
- cyclists in clothing that obscures the contours of the body or who are approaching from the side.
- bicycles that have no rearward-facing red reflector.
- bicycles loaded with large objects.

The driver is always responsible that the vehicle is driven properly and with a safety distance adapted to the speed.

Related information

- Collision warning system* (p. 223)

Collision warning system* - detection of pedestrians

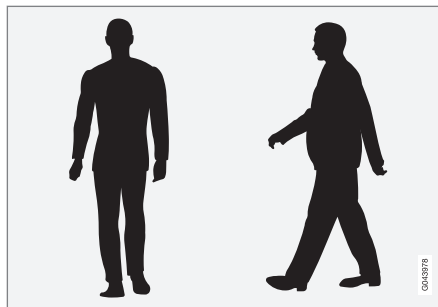

Optimal examples of what the system regards as pedestrians with clear body contours.

Optimal performance of the system requires that the system function that detects pedestrians receives as unambiguous information as possible about the contours of the body - this implies the opportunity to identify the head, arms, shoulders, legs, upper and lower body combined with a normal human pattern of movement.

If large parts of the body are not visible to the function's camera then the system cannot detect a pedestrian.

- In order for a pedestrian to be detected he/she must appear full-length and have a height of at least 80 cm.
- The camera sensor's ability to see pedestrians at dusk and dawn is limited - just like the human eye.
- The camera sensor's capacity to detect pedestrians is deactivated when driving in darkness and tunnels - even when streetlights are lit.

WARNING

"Collision Warning with Auto Brake and Cyclist and Pedestrian Detection" is a means of assistance. The function cannot detect all pedestrians in all situations and does not see, for example:

- partially obscured pedestrians, people in clothing that hides their body contour or pedestrians shorter than 80 cm.
- pedestrians who are carrying larger objects.

The driver is always responsible that the vehicle is driven properly and with a safety distance adapted to the speed.

Related information

- Collision warning system* (p. 223)



Collision warning system* - operation

Settings for the collision warning system are made from **MY CAR** via the centre console screen and menu system, see MY CAR (p. 108).

Warning signals On and Off

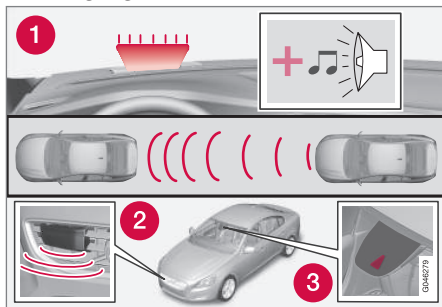

1. Acoustic and visual warning signal in the event of a collision risk.²⁴

It is possible to select whether the collision warning system's acoustic and visual warning signals should be switched on or off.

When starting the engine, the setting that was selected when the engine was switched off is obtained automatically.

NOTE

The Brake Support and Auto Brake functions are always activated - they cannot be deactivated.

Settings for the collision warning system are made via the centre console's screen and the menu system **MY CAR**, see (p. 108).

Light and acoustic signals

When the collision warning system's light and acoustic warnings are activated, the warning lamp (no. [1] in previous illustration) is tested each time the engine is started by briefly illuminating the warning lamp's separate points of light.

After starting the engine, both light and acoustic signals are switched off:

- Search for **Collision warning in Driver support system** in the menu system **MY CAR** (p. 108) - and there select to uncheck the function.

Audible signal

After starting the engine the warning sound can be activated/deactivated separately:

- Search for **Warning sound in Collision warning** in the menu system **MY CAR** (p. 108) - and there select On or Off.

Following which, the collision warning system is only indicated with a light signal.

Set warning distance

The warning distance regulates the distance at which the visual and acoustic warnings are deployed.

- Search for **Warning distance in Collision warning** in the menu system **MY CAR** (p. 108) - and there select **Long**, **Normal** or **Short**.

The warning distance determines the system's sensitivity. Warning distance **Long** provides an earlier warning. First test with **Long** and if this setting produces too many warnings, which could be perceived as irritating in certain situations, then change to warning distance **Normal**.

Only use warning distance **Short** in exceptional cases, e.g. for dynamic driving.

NOTE

When the adaptive cruise control is in use the warning lamp and warning sound will be used by the cruise control even if the collision warning system is switched off.

The collision warning system warns the driver in the event of a risk of a collision, but the function cannot shorten driver reaction time.

In order for the collision warning system to be effective, always drive with Distance Alert (p. 213) set at time interval 4-5.

²⁴ The illustration is schematic - car model and details may differ.



07 Driver support



NOTE

Even if the warning distance has been set to **Long** warnings could be perceived as being late in certain situations, e.g. when there are large differences in speed or if vehicles in front brake heavily.

WARNING

No automatic system can guarantee 100 % correct function in all situations. Therefore, never test Collision Warning with Auto Brake by driving at people or vehicles - this may cause severe damage and injury and risk lives.

Checking settings

The settings required can be controlled on the centre console display screen.

- Search in the menu system MY CAR (p. 108) for **Collision warning in Driver support system**.

Maintenance

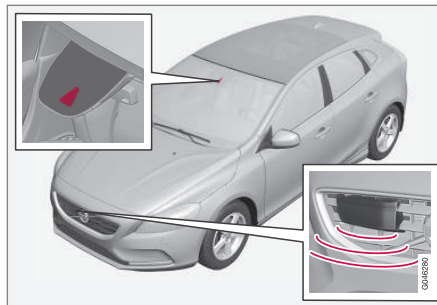

Camera and radar sensor²⁵.

For the sensors to work correctly, they must be kept clear of dirt, ice and snow, and be cleaned regularly with water and car shampoo.

NOTE

Dirt, ice and snow covering the sensors will reduce their function and may prevent measurement.

Related information

- Collision warning system* (p. 223)

Collision warning system* - limitations

The function has certain limitations - for example, it is not active until approx. 4 km/h.

The collision warning system's visual warning signal may be difficult to notice in the event of strong sunlight, reflections, when sunglasses are being worn or if the driver is not looking straight ahead. The warning sound should therefore always be activated.

On slippery road surfaces the braking distance is extended, which may reduce the capacity to avoid a collision. In such situations the ABS and ESC (p. 183) systems will provide best possible braking force with maintained stability.

NOTE

The visual warning signal can be temporarily disengaged in the event of high passenger compartment temperature caused by strong sunlight for example. If this occurs then the warning sound is activated even if it is deactivated in the menu system.

- Warnings may not appear if the distance to the vehicle in front is small or if steering wheel and pedal movements are large, e.g. a very active driving style.

²⁵ NOTE: The illustration is schematic - details may vary depending on car model.

**! WARNING**

Warnings and brake interventions could be implemented late or not at all if the traffic situation or external influences mean that the radar or camera sensor cannot detect a pedestrian, a vehicle or a cyclist in front correctly.

The sensor system has a limited range for pedestrians and cyclists²⁶ - the system can provide effective warnings and brake interventions for them at vehicle speeds up to 50 km/h. For stationary or slow-moving vehicles, warnings and brake interventions are effective at vehicle speeds up to 70 km/h.

Warnings for stationary or slow-moving vehicles could be disengaged due to darkness or poor visibility.

Warnings and brake interventions for pedestrians and cyclists are deactivated at vehicle speeds exceeding 80 km/h.

The collision warning system uses the same radar sensors as the adaptive cruise control (p. 198).

If warnings are perceived as being too frequent or disturbing then the warning distance can be reduced. This then leads to the system providing a warning at a later stage, which reduces the total number of warnings; see Collision warning system - operation (p. 227).

²⁶ For cyclists, the warning and full brake intervention may come very late or simultaneously.

Collision Warning with Auto Brake is temporarily deactivated with reverse gear engaged.

Collision Warning with Auto Brake is not activated at low speeds - under 4 km/h, which is why the system does not intervene in situations where the car is approaching a vehicle in front very slowly, e.g. when parking.

In situations where the driver demonstrates active, aware driving behaviour, a collision warning may be postponed slightly in order to keep unnecessary warnings to a minimum.

When Auto Brake has prevented a collision with a stationary object the car remains stationary for a maximum of 1.5 seconds. If the car is braked for a vehicle in front that is moving, then speed is reduced to the same speed as that maintained by the vehicle in front.

On a car with manual gearbox the engine stops when Auto Brake has stopped the car, unless the driver manages to depress the clutch pedal beforehand.

Related information

- Collision warning system* (p. 223)

Collision warning system* - camera sensor limitations

The function uses the car's camera sensor, which has certain limitations.

The car's camera sensor is also used - as well as by Collision Warning with Auto Brake - by the functions:

- Active high beam (p. 87)
- Road sign information (p. 187)
- Driver Alert Control - DAC (p. 232)
- Lane Keeping Aid (p. 235).

i NOTE

Keep the windscreen surface in front of the camera sensor free from ice, snow, mist and dirt.

Do not stick or attach anything to the windscreen in front of the camera sensor as this may reduce effectiveness or cause one or more of the systems dependent on the camera to stop working.

The camera sensors have limitations similar to the human eye, i.e. they "see" worse in darkness, heavy snowfall or rain and in thick fog for example. Under such conditions the functions of camera-dependent systems could be significantly reduced or temporarily disengaged.



07 Driver support



Strong oncoming light, reflections in the carriageway, snow or ice on the road surface, dirty road surfaces or unclear lane markings could also significantly reduce camera sensor function when it is used to scan the carriageway and detect pedestrians and other vehicles.

The field of vision of the camera sensor is limited, which is why pedestrians, cyclists and vehicles cannot be detected in some situations, or they are detected later than anticipated.

During very high temperatures the camera is temporarily switched off for approx. 15 minutes after the engine is started in order to protect camera functionality.

Fault tracing and action

If the display shows the message **Windscreen sensors blocked** See manual then this means that the camera sensor is blocked and cannot detect pedestrians, cyclists, vehicles or road markings in front of the car.

At the same time, this means that - besides Collision Warning with Auto Brake - the Automatic main/dipped beam dimming, Road Sign Information, Driver Alert Control and Lane Keeping Aid functions will not have full functionality either.

The following table presents possible causes for a message being shown along with the appropriate action.

Cause	Action
The windscreen surface in front of the camera is dirty or covered with ice or snow.	Clean the windscreen surface in front of the camera from dirt, ice and snow.
Thick fog, heavy rain or snow means that the camera does not work sufficiently well.	No action. At times the camera does not work during heavy rain or snowfall.
The windscreen surface in front of the camera has been cleaned but the message remains.	Wait. It may take several minutes for the camera to measure the visibility.
Dirt has appeared between the inside of the windscreen and the camera.	Visit a workshop to have the windscreen inside the camera cover cleaned - an authorised Volvo workshop is recommended.

Related information

- Collision warning system* (p. 223)



Collision warning system* - symbols and messages

Symbol ^A	Message	Specification
	Collision warning system OFF	Collision warning system switched off. Shown when the engine is started. The message clears after about 5 seconds or after one press of the OK button.
	Collision warning system Unavailable	The collision warning system cannot be activated. Shown when the driver attempts to activate the function. The message clears after about 5 seconds or after one press of the OK button.
	Auto Braking was activated	Auto Brake has been active. The message clears after one press of the OK button.
	Windscreen sensors blocked See manual	Camera sensor (p. 229) is temporarily disengaged. Shown in the event of snow, ice or dirt on the windscreen for example. <ul style="list-style-type: none"> Clean the windscreen surface in front of the camera sensor.
	Radar blocked See manual	Collision Warning with Auto Brake is temporarily disengaged. Radar sensor (p. 208) is blocked and cannot detect other vehicles. For example, in the event of heavy rain or if slush has collected in front of the radar sensor.
	Collision warning Service required	Collision Warning with Auto Brake is fully or partially disengaged. <ul style="list-style-type: none"> Visit a workshop if the message remains - an authorised Volvo workshop is recommended.

^A Symbols are schematic - may vary by market and car model.

Related information

- Collision warning system* (p. 223)



Driver Alert System*

The Driver Alert System is intended to assist drivers whose driving ability is deteriorating or who are inadvertently leaving the lane they are driving on.

The Driver Alert System consists of different functions which can either be switched on at the same time or individually:

- Driver Alert Control - DAC (p. 233).
- Lane Keeping Aid (p. 237).

A switched-on function is set in standby mode and is not activated automatically until speed exceeds 65 km/h.

The function is deactivated again when speed decreases to below 60 km/h.

The functions use a camera which is dependent on the lane having side markings painted on each side.

WARNING

Driver Alert System does not work in all situations but is designed merely as a supplementary aid.

The driver always bears ultimate responsibility for ensuring that the vehicle is driven safely.

Related information

- Driver Alert Control (DAC)* (p. 232)
- Lane Keeping Aid* (p. 235)

Driver Alert Control (DAC)*

DAC is intended to attract the driver's attention when he/she starts to drive less consistently, e.g. if he/she becomes distracted or starts to fall asleep.

The objective for DAC is to detect slowly deteriorating driving ability and it is primarily intended for major roads.

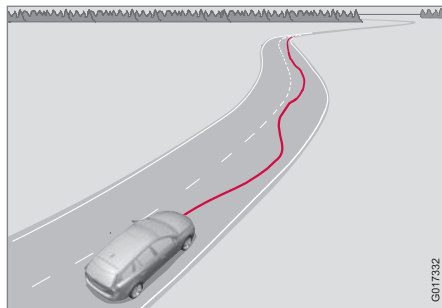

A camera detects the side markings painted on the carriageway and compares the section of the road with the driver's steering wheel movements. The driver is alerted if the vehicle does not follow the carriageway evenly.

In some cases driving ability is not affected despite driver fatigue. In which case there may not be any warning issued for the driver. For this reason it is always important to stop and take a break in the event of any signs of

driver fatigue, irrespective of whether or not DAC issues a warning.

NOTE

The function must not be used to extend a period of driving. Always plan breaks at regular intervals, and make sure you are well rested.

Limitation

In some cases the system may issue a warning despite driving ability not deteriorating, for example:

- in strong side winds
- on rutted road surfaces.

DAC is not intended for city traffic.

NOTE

The camera sensor has certain limitations, see Collision warning system* - camera sensor limitations (p. 229).

Related information

- Driver Alert System* (p. 232)
- Driver Alert Control (DAC)* - operation (p. 233)
- Driver Alert Control (DAC)* - symbols and messages (p. 234)
- Lane Keeping Aid* (p. 235)



Driver Alert Control (DAC)* - operation

Settings are made from the centre console display screen and its menu system.

On/Off

The Driver Alert function can be set in standby mode via the menu system **MY CAR** (p. 108):

- Checked box - function activated.
- Unchecked box - the function is deactivated.

Function

Driver Alert is activated when speed exceeds 65 km/h and remains active as long as the speed is over 60 km/h.



If the vehicle is being driven erratically, the driver is notified by an acoustic signal plus the text message (p. 234) **Driver Alert Time for**

a break - the linked symbol is illuminated in the combined instrument panel at the same time. The warning is repeated after a time if driving ability does not improve.

The warning symbol can go off:

- Press the left stalk switch **OK** button.



WARNING

An alarm should be taken very seriously, as a sleepy driver is often not aware of his/her own condition.

In the event of an alarm or a feeling of tiredness; stop the car in a safe manner as soon as possible and rest.

Studies have shown that it is equally as dangerous to drive while tired as it is under the influence of alcohol.

Related information

- Driver Alert System* (p. 232)
- Driver Alert Control (DAC)* (p. 232)





07 Driver support

Driver Alert Control (DAC)* - symbols and messages

Driver Alert Control - DAC (p. 232) can show symbols and text messages in the combined

instrument panel or in the centre console's screen in different situations.

Here are some examples:

Symbol ^A	Message	Specification
	Driver Alert Time for a break	The vehicle has been driven inconsistently - the driver is alerted by an acoustic warning signal + text.
	Windscreen sensors blocked See manual	The camera sensor is temporarily disengaged. Shown in the event of snow, ice or dirt on the windscreen for example. <ul style="list-style-type: none"> Clean the windscreen surface in front of the camera sensor. Read about the limitations of the camera sensor, see Collision warning system* - camera sensor limitations (p. 229).
	Driver Alert system Service required	The system is disengaged. <ul style="list-style-type: none"> Visit a workshop if the message remains - an authorised Volvo workshop is recommended.

^A The symbols are schematic.

Related information

- Driver Alert System* (p. 232)
- Driver Alert Control (DAC)* - operation (p. 233)
- Lane Keeping Aid* (p. 235)



Lane Keeping Aid*

Lane Keeping Aid is one of the functions in the Driver Alert System - sometimes also referred to as LKA (Lane Keeping Aid).

The function is intended for use on motorways and similar major roads in order to reduce the risk of the vehicle accidentally leaving its own lane in certain situations.

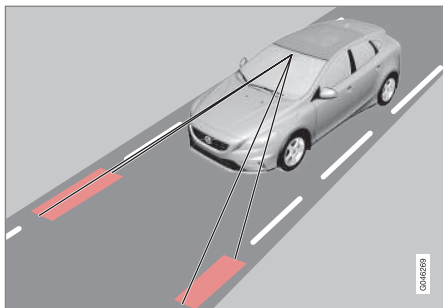

A camera reads the painted side lines of the road/lane. If the car is about to cross a side line then Lane Keeping Aid will actively steer the car back into the lane with a slight steering torque in the steering wheel.

If the car reaches or crosses a side line then Lane Keeping Aid will also alert the driver with pulsating vibration in the steering wheel.

WARNING

LKA is merely a driver's aid and does not engage in all driving situations or traffic, weather or road conditions.

The driver always bears ultimate responsibility for ensuring that the vehicle is driven safely and that applicable laws and road traffic regulations are followed.

Related information

- Lane Keeping Aid - function (p. 235)
- Lane Keeping Aid - operation (p. 237)
- Lane Keeping Aid - limitations (p. 237)
- Lane Keeping Aid - symbols and messages (p. 239)
- Driver Alert System* (p. 232)

Lane Keeping Aid - function

Off & On

Lane Keeping Aid is active within the speed range 65-200 km/h on roads with clearly visible side lines. The function is temporarily deactivated on narrow roads with less than 2.6 metres between the lane side lines.



Press the button in the centre console to activate or deactivate the function. An illuminated lamp in the button shows when the function is switched on.

Some combinations of the selected equipment leave no vacant space for an On/Off button in the centre console - in which case, the function is instead operated in the car's menu system **MY CAR** (p. 108). Here, proceed as follows:

- Search for **Lane Keeping Aid** and then select On or Off.



07 Driver support



In addition, the following selections can be made in **MY CAR**:

- Warning with vibration in the steering wheel: **Vibration only** - On or Off.
- Active steering: **Steering assist only** - On or Off.
- Both Warning with vibration in the steering wheel and Active steering: **Full function** - On or Off.

Active steering

Lane Keeping Aid strives to keep the car within the side lines for the lane.

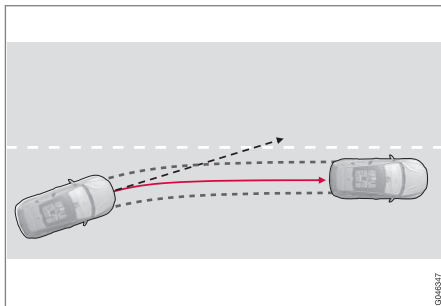

LKA intervenes and steers away.

If the vehicle approaches the left or right side line of the lane and the direction indicator is not activated, the car is steered back into the lane.

Warning with vibration in the steering wheel

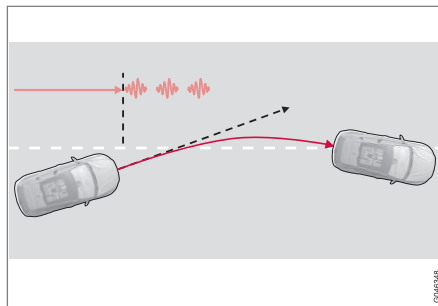

LKA steers and warns with pulsating steering wheel vibrations²⁷.

If the vehicle crosses a side line then Lane Keeping Aid alerts the driver with pulsating vibration in the steering wheel. This occurs regardless of whether the car is actively steered back by applying a slight steering torque.

Dynamic cornering

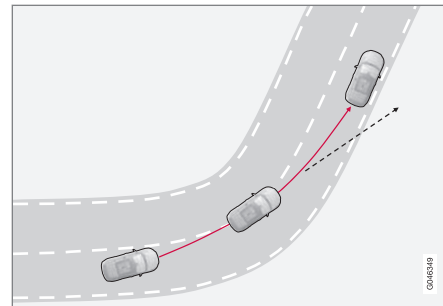

LKA does not engage in sharp inside curves.

In certain cases, Lane Keeping Aid allows the car to cross side lines without engaging active steering or alerting with pulsating vibration in the steering wheel. Using an adjacent lane for dynamic cornering when there is a clear line of vision is an example of one such case.

Related information

- Lane Keeping Aid* (p. 235)

²⁷ The figure shows 3 pulsating vibrations when the side line is passed.



Lane Keeping Aid - operation

Lane Keeping Aid is supplemented with self-explanatory graphics in different situations. Here are some examples:

i NOTE

LKA is temporarily deactivated for as long as the direction indicator is switched on.



LKA "sees" the following side lines.

If Lane Keeping Aid is active and detects/"sees" the side lines, the LKA symbol indicates this with WHITE lines.

- GREY side line - Lane Keeping Aid does not see a line on that side of the car.



LKA engages on the right side.

Lane Keeping Aid intervenes and steers away from the side line - this is indicated with:

- RED line for the side in question.

Related information

- Lane Keeping Aid* (p. 235)

Lane Keeping Aid - limitations

- Lane Keeping Aid's camera sensor has limitations in a similar way to the human eye. For more information, see Collision warning system* - camera sensor limitations (p. 229) and (p. 228).

i NOTE

In certain demanding situations LKA may find it difficult to assist the driver correctly - in which case it is recommended that LKA is switched off.

Examples of such a situation could be:

- roadworks
- winter road conditions
- poor road surface
- very sporty driving style
- poor weather with reduced visibility.

Hands on the steering wheel

In order for Lane Keeping Aid to operate, the driver must have his/her hands on the steering wheel. LKA continually monitors this. If hands are not detected on the steering wheel then a text message is shown, prompting the driver to actively steer the car.

If the driver does not follow the request to begin steering then Lane Keeping Aid goes into standby mode and will remain in this mode until the driver begins to steer the car again.

* Option/accessory, for more information, see Introduction.



07 Driver support



Related information

- Lane Keeping Aid* (p. 235)





Lane Keeping Aid - symbols and messages

In situations where there is no LKA function or it is interrupted, a symbol may be shown in

the combined instrument panel in combination with an explanatory message - follow the recommendation given if appropriate.

Message examples:

Symbol ^A	Message	Specification
	Windscreen sensors blocked See manual	The camera sensor is temporarily disengaged. Shown in the event of snow, ice or dirt on the windscreen for example. <ul style="list-style-type: none"> Clean the windscreen surface in front of the camera sensor. Read about the limitations of the camera sensor, see Collision warning system* - camera sensor limitations (p. 229) and (p. 228).
	Lane Keeping Aid Service required	The system is disengaged. <ul style="list-style-type: none"> Visit a workshop if the message remains - an authorised Volvo workshop is recommended.
	Lane Keeping Aid Interrupted	LKA has been set to standby mode. The lines of the LKA symbol indicate when the function is active again.

^A The table's symbols are schematic. The symbols shown in the combined instrument panel may have a slightly different appearance.

Related information

- Lane Keeping Aid* (p. 235)



Park Assist*

Parking assistance is used as an aid to parking. An acoustic signal as well as symbols on the centre console's display screen indicate the distance to the detected obstacle.

Parking assistance sound level can be adjusted during the ongoing acoustic signal using the centre console's **VOL** knob or in the car's menu system **MY CAR**, see MY CAR (p. 108).

Parking assistance is available in two variants:

- Rear only
- Both front and rear.



NOTE

When a towbar is configured with the car's electrical system, the protrusion of the towbar is included when the function measures the parking space.



WARNING

- Parking assistance does not relinquish the driver's own responsibility during parking.
- The sensors have blind spots where obstacles cannot be detected.
- Be aware of e.g. people and animals near the car.

Related information

- Park assist syst* - cleaning the sensors (p. 243)
- Park assist syst* - function (p. 240)
- Park assist syst* - forward (p. 242)
- Park assist syst* - fault indication (p. 243)
- Park assist syst* - backward (p. 242)
- Park assist camera (p. 244)
- Park Assist Pilot (PAP)* (p. 248)

Park assist syst* - function

The parking assistance system is automatically activated when the engine is started - the switch's On/Off lamp is illuminated. If parking assistance is switched off with the button, the lamp goes out.



On/Off for the sensors for parking assistance and CTA²⁸.

The centre console's display screen shows an overview of the relationship between the car and detected obstacle.

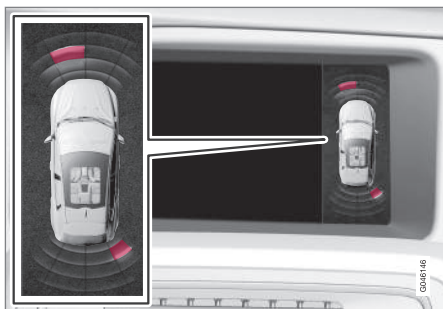

Display screen view - showing an obstacle left front and right rear.

Marked sectors show which of the four sensor(s) detected an obstacle. The closer to the car symbol a selected sector box is, the shorter the distance between the car and a detected obstacle.

The frequency of the signal increases the shorter the distance to an obstacle, in front of or behind the car. Other sound from the audio system is muted automatically.

When the distance is within 30 cm the tone is constant and the active sensor's field nearest the car is filled in. If the detected obstacle is within the distance for the constant tone both behind and in front of the car, then the tone sounds alternately from the loudspeakers.

! IMPORTANT

Objects e.g. chains, thin glossy poles or low barriers may be in the "signal shadow" and are then temporarily not detected by the sensors - the pulsating tone may then unexpectedly stop instead of changing over to the expected constant tone.

The sensors cannot detect high objects, such as projecting loading docks.

- In such situations, pay extra attention and manoeuvre/reposition the car particularly slowly or stop the current parking manoeuvre - there may be a high risk of damage to vehicles or other objects since the sensors are temporarily unable to function optimally.

Related information

- Park Assist* (p. 240)
- Park assist syst* - cleaning the sensors (p. 243)
- Park assist syst* - forward (p. 242)
- Park assist syst* - fault indication (p. 243)
- Park assist syst* - backward (p. 242)
- Park assist camera (p. 244)
- Park Assist Pilot (PAP)* (p. 248)

²⁸ Side warning, CTA (Cross Traffic Alert) (p. 255)



07 Driver support

Park assist syst* - backward

Parking assistance is used as an aid to parking. An acoustic signal as well as symbols on the centre console's display screen indicate the distance to the detected obstacle.

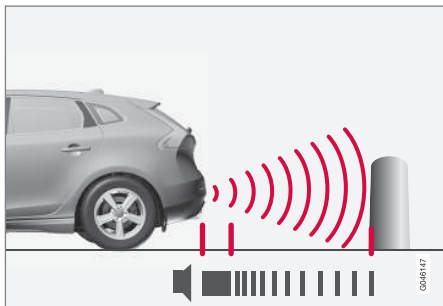

The distance covered to the rear of the car is about 1.5 metres. The acoustic signal for obstacles behind comes from one of the rear loudspeakers.

Rear parking assistance is activated when reverse gear is engaged.

When reversing with e.g. a trailer on the towbar, rear parking assistance is switched off automatically - otherwise the sensors would react to the trailer.

NOTE

When reversing with e.g. a trailer or bike carrier on the towbar - without Volvo genuine trailer wiring - parking assistance may need to be switched off manually in order that the sensors do not react to them.

Related information

- Park Assist* (p. 240)
- Park assist syst* - cleaning the sensors (p. 243)
- Park assist syst* - function (p. 240)
- Park assist syst* - forward (p. 242)
- Park assist syst* - fault indication (p. 243)
- Park assist camera (p. 244)
- Park Assist Pilot (PAP)* (p. 248)

Park assist syst* - forward

Parking assistance is used as an aid to parking. An acoustic signal as well as symbols on the centre console's display screen indicate the distance to the detected obstacle.

The parking assistance system is automatically activated when the engine is started - the switch's On/Off lamp is illuminated. If parking assistance is switched off with the button, the lamp goes out.

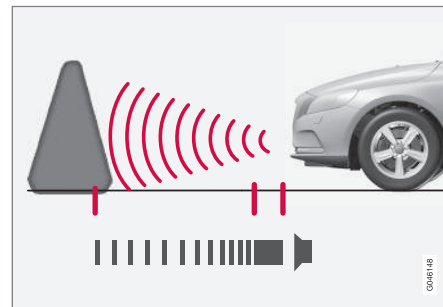

The distance covered in front of the car is about 0.8 metres. The acoustic signal for obstacles in front comes from one of the front loudspeakers.

Front park assist is active up to approx. 10 km/h. The lamp in the button is illuminated in order to indicate that the system is activated. When the speed is below 10 km/h the system is reactivated.

**! IMPORTANT**

When auxiliary lamps are fitted: Remember that these must not obscure the sensors - the auxiliary lamps may then be perceived as an obstacle.

Related information

- Park Assist* (p. 240)
- Park assist syst* - cleaning the sensors (p. 243)
- Park assist syst* - function (p. 240)
- Park assist syst* - fault indication (p. 243)
- Park assist syst* - backward (p. 242)
- Park assist camera (p. 244)
- Park Assist Pilot (PAP)* (p. 248)

Park assist syst* - fault indication

Parking assistance is used as an aid to parking. An acoustic signal as well as symbols on the centre console's display screen indicate the distance to the detected obstacle.



If the combined instrument panel's information symbol illuminates with constant glow and the text message

Park Assist System Service required is shown then parking assistance is disengaged.

! IMPORTANT

Under some circumstances, the parking sensors can give false warning signals due to external sound sources which emit the same ultrasound frequencies as those with which the system works.

Examples of such sources include horns, wet tyres on asphalt, pneumatic brakes and exhaust noises from motorcycles etc.

Related information

- Park Assist* (p. 240)
- Park assist syst* - cleaning the sensors (p. 243)
- Park assist syst* - function (p. 240)
- Park assist syst* - forward (p. 242)
- Park assist syst* - backward (p. 242)
- Park assist camera (p. 244)
- Park Assist Pilot (PAP)* (p. 248)

Park assist syst* - cleaning the sensors

Parking assistance is used as an aid to parking. An acoustic signal as well as symbols on the centre console's display screen indicate the distance to the detected obstacle.

The sensors for parking assistance must be cleaned regularly to ensure that they work properly. Clean them with water and car shampoo.

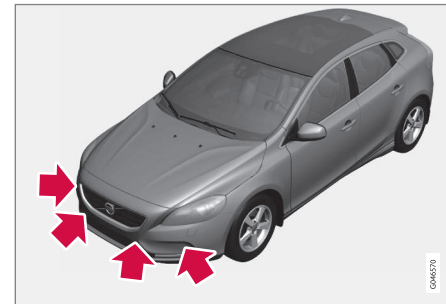

Sensor location, front.

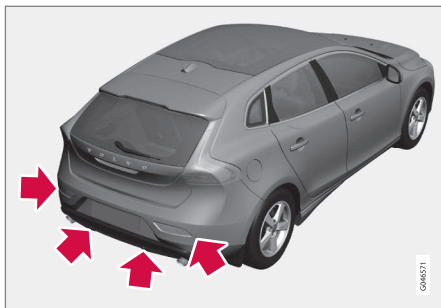

Sensor location, rear.

NOTE

Dirt, ice and snow covering the sensors will reduce their function and may prevent measurement.

Related information

- Park Assist* (p. 240)
- Park assist syst* - function (p. 240)
- Park assist syst* - forward (p. 242)
- Park assist syst* - fault indication (p. 243)
- Park assist syst* - backward (p. 242)
- Park assist camera (p. 244)
- Park Assist Pilot (PAP)* (p. 248)

Park assist camera

The parking camera is an auxiliary system and is activated when the reverse gear is selected.

The camera image is shown on the centre console's screen.

NOTE

When a towbar is configured with the car's electrical system, the protrusion of the towbar is included when the function measures the parking space.

WARNING

- The parking camera is an aid and can never replace the responsibilities of the driver when reversing.
- The camera has blind spots where obstacles cannot be detected.
- Be aware of people and animals near the car.

Function and operation

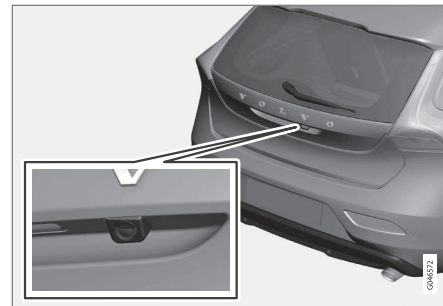

Camera location next to the opening handle.

The camera shows what is behind the car and if something appears from the sides.

The camera shows a wide area behind the car and part of the bumper and any towbar.

Objects on the screen may appear to tilt slightly - this is normal.

NOTE

Objects on the display screen may be closer to the car than they appear to be on the screen.

If another view is active then the parking camera system takes over automatically and its camera image is displayed on the screen.

When reverse gear is selected, two unbroken lines are shown graphically which illustrate



where the car's rear wheels will roll with the current steering wheel angle - this facilitates parallel parking, reversing into tight spaces and for hitching a trailer. The car's approximate external dimensions are illustrated by means of dashed lines. The park assist lines can be deactivated - see section Settings (p. 246).

If the car is also equipped with Parking assistance sensors * (p. 240) then their information is shown graphically as coloured areas in order to illustrate the distance to detected obstacles, see heading "Cars with reversing sensors" later in the text.

The camera is active approx. 5 seconds after reverse gear has been disengaged or until the car's speed exceeds 10 km/h forward or 35 km/h backward.

Light conditions

The camera image is adjusted automatically according to prevailing light conditions. Because of this, the image may vary slightly in brightness and quality. Poor light conditions can result in a slightly reduced image quality.

i NOTE

Keep the camera lens clear of dirt, snow and ice to ensure optimum function. This is particularly important in poor light.

Park assist lines

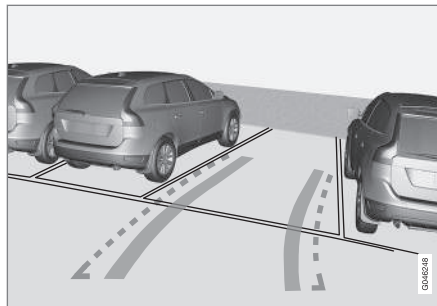

Examples of how the park assist lines can be displayed for the driver.

The lines on the screen are projected as if they were at ground level behind the car and are directly related to steering wheel movement, which shows the driver the path the car will then take - also when the car is turning.

i NOTE

- When reversing with a trailer which is not connected electrically to the car, the lines on the display show the route the **car** will take - not the trailer.
- The screen shows no lines when a trailer is connected electrically to the car's electrical system.
- The parking camera is deactivated automatically when towing a trailer if a Volvo genuine trailer cable is used.

i IMPORTANT

Remember that the display only shows the area behind the car - so pay attention to the sides and front of the car when turning the steering while reversing.

Boundary lines

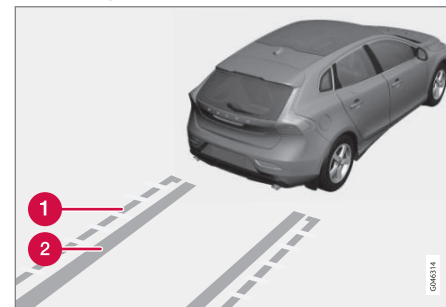

Different lines in the system.

- 1 Boundary line, free reversing zone
- 2 "Wheel tracks"

The dashed line (1) frames in a zone up to about 1.5 m back from the bumper. It is also the limit of the car's most protruding parts, such as door mirrors and corners - also when the car is turning.

The wide "wheel tracks" (2) between the side lines indicate where the wheels will roll and can extend about 3.2 m back from the bumper if no obstacle is in the way.



07 Driver support



Cars with reversing sensors*

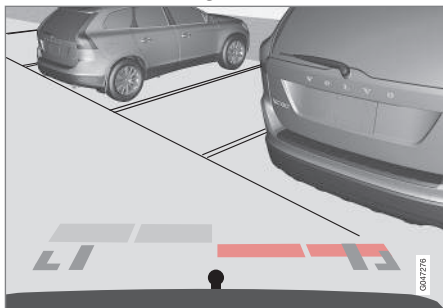

Coloured areas (x 4 - one per sensor) show distance.

If the car is also equipped with Parking assistance (p. 240) the distance is shown with coloured fields for each sensor that registers an obstacle.

The colour of the areas changes with decreasing distance to the obstacle - from light yellow to yellow, via orange to red.

Colour / paint	Distance (metres)
Light yellow	0,7–1,5
Yellow	0,5–0,7
Orange	0,3–0,5
Red	0–0,3

Related information

- Park assist camera - settings (p. 246)
- Park assist camera - limitations (p. 248)
- Park Assist* (p. 240)
- Park Assist Pilot (PAP)* (p. 248)

Park assist camera - settings

Activate switched-off camera

If the camera function is switched off when reverse gear is selected, it is activated in the following way:

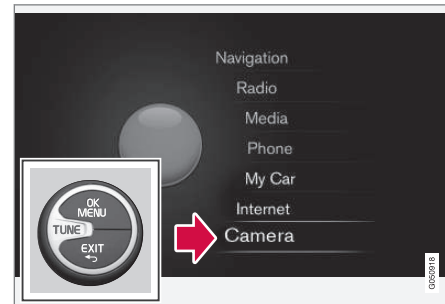

Main source menu²⁹.

1. Give one or two **long** presses on **EXIT** to access the main source menu.
2. Turn to the "Camera" option with **TUNE** and press **OK/MENU**.
3. In the following menu: - Turn to the desired camera view with **TUNE** and press **OK/MENU** - the screen shows the current camera view.

²⁹ See the Sensus Infotainment supplement for more information about the menu system.

* Option/accessory, for more information, see Introduction.



Options*

Cars with the front camera option have a **CAM** button on the climate panel.



Button location may vary depending on options for other equipment.

- Press **CAM** to activate the camera - the screen shows the current camera view.

To change view between the reversing camera and front camera:

- Press **CAM** or turn **TUNE**.

Change setting

The default setting is that the camera is activated when reverse gear is selected.

The settings for the parking camera can be changed when the screen shows a camera view:

1. Press **OK/MENU** when a camera view is shown - the screen changes to a menu with various options.
2. Turn to reach the desired option with **TUNE**.
3. Highlight the option by pressing **OK/MENU** once and go back out with **EXIT**.

Towbar

The camera can be used to advantage when hitching a trailer. A park assist line for the towbar's intended "trajectory" toward the trailer can be shown on the screen - exactly as for the "wheel tracks".

A choice can be made between showing the "wheel tracks" or the towbar's trajectory - both options cannot be shown simultaneously.

1. Press **OK/MENU** when a camera view is shown.
2. Turn to reach the **Tow bar trajectory guide line** option with **TUNE**.
3. Highlight the option by pressing **OK/MENU** once and go back out with **EXIT**.

Zoom

If precise manoeuvring is required then the camera view can be zoomed in:

- Press **CAM** or turn **TUNE** - repeated press/turn changes back to the normal view.

If more options are available, they are in a loop - press/turn until the desired camera view is shown.

Related information

- Park assist camera (p. 244)
- Park assist camera - limitations (p. 248)
- Park Assist* (p. 240)
- Park Assist Pilot (PAP)* (p. 248)



Park assist camera - limitations

NOTE

Bicycle racks or other accessories mounted on the back of the car may obscure the line of sight of the camera.

To bear in mind

Pay attention to the possibility that, even if it only looks like a relatively small part of the image is obscured, it could be a relatively large sector that is hidden from view. Obstacles could thereby go undetected until they are very close to the car.

- Keep the camera lens free from dirt, ice and snow.
- Clean the camera lens regularly with luke-warm water and car shampoo - take care not to scratch the lens.

Related information

- Park assist camera (p. 244)
- Park assist camera - settings (p. 246)
- Park Assist* (p. 240)
- Park Assist Pilot (PAP)* (p. 248)

Park Assist Pilot (PAP)*

The Park Assist Pilot (PAP – Park Assist Pilot) helps the driver to park by first checking whether a space is sufficiently large and then turning the steering wheel and steering the car into the space.

The combined instrument panel uses symbols, graphics and text when elements are to be executed.

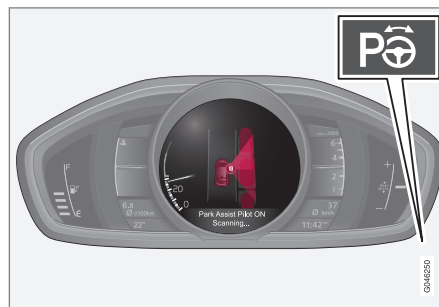

The On/Off button is on the centre console.

NOTE

When a towbar is configured with the car's electrical system, the protrusion of the towbar is included when the function measures the parking space.



WARNING

PAP does not work in all situations but is designed merely as a supplementary aid.

The driver always has the final responsibility for driving the vehicle in a safe manner and for paying attention to the surroundings and other road users approaching or passing during parking.

Related information

- Park Assist Pilot (PAP)* - function (p. 249)
- Park Assist Pilot (PAP)* - operation (p. 249)
- Park Assist Pilot (PAP)* - limitations (p. 251)
- Active Park Assist (PAP)* - symbols and messages (p. 252)
- Park assist camera (p. 244)



Park Assist Pilot (PAP)* - function

The combined instrument panel uses symbols, graphics and text when elements are to be executed.

i NOTE

The PAP function measures the space and turns the steering wheel - the driver's task is to follow the combined instrument panel's instructions and select the gear (reverse/forward), control the speed, brake and stop.

PAP can be activated if the following criteria are met once the engine has been started:

- The functions ABS³⁰ or ESC³¹ must not intervene when the PAP function is activated - these can be activated in the event of e.g. steep and slippery surfaces, see the sections on Foot brake (p. 289) and Stability system ESC (p. 183) for more information.
- Trailers must not be connected to the car.
- The speed must be below 50 km/h.

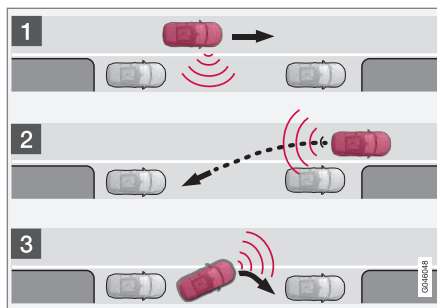

Principle for PAP.

PAPThe function parks the car using the following steps:

1. The function searches for a parking space and measures it - during measurement, speed must not exceed 30 km/h.
2. The car is steered into the space during reversing.
3. The car is positioned in the space by driving forward and back.

Related information

- Park Assist Pilot (PAP)* (p. 248)
- Park assist camera (p. 244)

Park Assist Pilot (PAP)* - operation

The driver is instructed about how PAP works by means of simple, clear instructions in the combined instrument panel - using both graphics and text graphics and text message (p. 252).

i NOTE

Remember that certain steering wheel positions may obstruct the combined instrument panel's instructions when you turn it during the parking manoeuvre.

1 - Searching and checking measurements

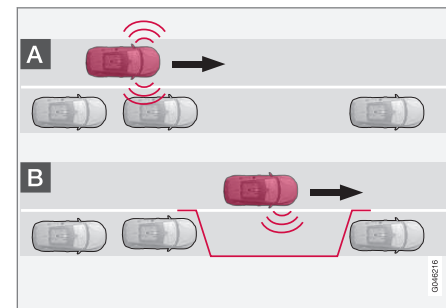

³⁰ (Anti-lock Braking System) - Anti-lock braking system.

³¹ (Electronic Stability Control) - Stability system.



07 Driver support



The PAP function searches for a parking space and checks whether it is big enough. Proceed as follows:



1. Activate PAP by pressing this button and do not drive faster than 30 km/h.

2. Keep an eye on the combined instrument panel and be prepared to stop the car when the graphics and text message so request.
3. Stop the car when the graphics and text so request.

i NOTE

PAP searches the area for a parking space, displays instructions and guides the car in on its passenger side. But if required the car can also be parked on the driver's side of the street:

- Activate the direction indicator for the driver's side - the car is then parked on that side of the street instead.

2 - Reversing in

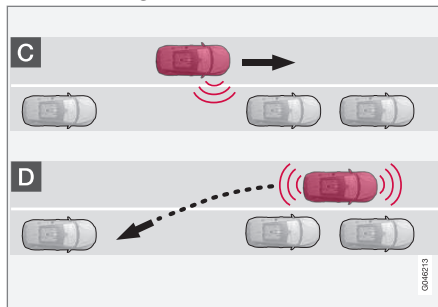

During the Reversing step, PAP will steer the car into the parking space. Proceed as follows:

1. Check that the area behind the car is clear, then engage reverse gear.
2. Reverse slowly and carefully without touching the steering wheel - and no faster than approx. 7 km/h.
3. Keep an eye on the combined instrument panel and be prepared to stop the car when the graphics and text message so request.

i NOTE

- Keep your hands away from the steering wheel when the PAP function is activated.
- Make sure that the steering wheel is not hindered in any way and can rotate freely.
- To achieve optimum results - wait until the steering wheel is fully turned before starting to drive backward/forward.

3 - Straightening up

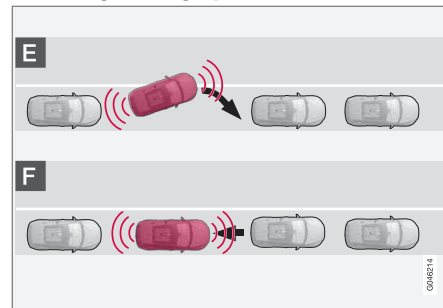

When the car has reversed into the parking space, it must be straightened up and stopped.



1. Engage first gear or **D** position, wait until the steering wheel has been turned, then drive slowly forwards.
2. Stop the car when the graphics and text message so request.
3. Engage reverse gear and drive backwards slowly until the graphics and text message tell you to stop.

The function is disengaged automatically when parking is complete, and the graphics and text message show that parking is complete. It may be necessary for the driver to correct the positioning. Only the driver can determine whether the car is properly parked.

IMPORTANT

The warning distance is shorter when the sensors are used by Active Park Assist compared with when Park Assist uses the sensors.

Related information

- Park Assist Pilot (PAP)* (p. 248)
- Park assist camera (p. 244)

Park Assist Pilot (PAP)* - limitations

The PAP sequence is stopped:

- if the car is driven too quickly - above 7 km/h
- if the driver touches the steering wheel
- if the ABS³² or ESC³³ function is engaged - e.g. if a wheel loses grip on a slippery road surface.

A text message indicates where the PAP sequence was stopped.

NOTE

Dirt, ice and snow covering the sensors will reduce their function and may prevent measurement.

IMPORTANT

Under certain circumstances, PAP is unable to find parking spaces - one reason for this may be the fact that there is interference with the sensors from external sound sources which emit the same ultrasound frequencies as those with which the system works.

Examples of such sources include horns, wet tyres on asphalt, pneumatic brakes and exhaust noises from motorcycles etc.

To bear in mind

The driver should bear in mind that the Park Assist Pilot is an aid – not an infallible, fully-automatic function. The driver must therefore be prepared to intervene. There are also details to bear in mind while parking, e.g.:

- PAP starts out from the current location of the parked vehicles - if they are inappropriately parked then the car's tyres and wheel rims may be damaged against kerbs.
- PAP is designed for parking on straight streets, not sharp curves or bends. For this reason, make sure the car is parallel to the parking space when PAP measures the space.
- It is not always possible to find parking spaces on narrow streets since there is not enough space for manoeuvring. In such parking situations, it helps the system to drive as close to the side of the road as possible where you intend to park.
- Bear in mind that the front of the car may swing out towards oncoming traffic while being parked.
- Objects situated higher than the detection areas of the sensors are not included when calculations are made for the parking manoeuvre. This may cause PAP to swing into the parking space too early,

³² (Anti-lock Braking System) - Anti-lock braking system.

³³ (Electronic Stability Control) - Stability and traction control system.





07 Driver support



and hence such parking pockets should be avoided.

- The driver is responsible for determining whether the space selected by PAP is suitable for parking.
- Use approved tyres³⁴ with the correct tyre pressure - this affects the ability of PAP to park the car.
- Heavy rain or snow may cause the system to measure the parking space incorrectly.
- Do not use PAP if snow chains or a spare wheel are fitted.
- Do not use PAP if loaded objects are protruding from the car.

IMPORTANT

The PAP system's parameters may need to be updated when changing to another approved wheel rim size involving changed tyre circumference. Consult a workshop - an authorised Volvo workshop is recommended.

Maintenance

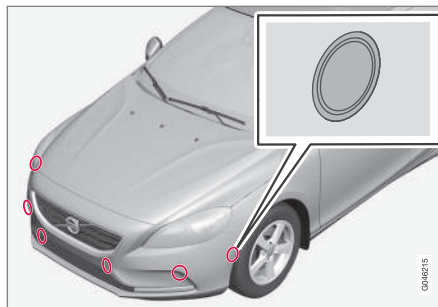

The PAP sensors are located in the bumpers³⁵ - 6 front and 4 rear.

For the PAP function to work correctly, its sensors must be cleaned (p. 243) regularly with water and car shampoo - these are the same sensors as are used by parking assistance (p. 240).

Related information

- Park Assist Pilot (PAP)* (p. 248)
- Park assist camera (p. 244)

Active Park Assist (PAP)* - symbols and messages

The combined instrument panel can show different combinations of symbols and text with varying content - sometimes with a self-explanatory piece of advice on appropriate action.

If a message says that the Park Assist Pilot is disengaged, contact with an authorised Volvo workshop is recommended.

Related information

- Park Assist Pilot (PAP)* (p. 248)
- Park assist camera (p. 244)

³⁴ "Approved tyres" refers to tyres of the same type and make as those fitted new on delivery from the factory.

³⁵ NOTE: The illustration is schematic - details may differ depending on car model.



BLIS

BLIS (Blind Spot Information System) is a function designed for providing support for the driver when driving in dense traffic on roads with several lanes in the same direction.

BLIS is a driver's aid intended to provide a warning about:

- vehicles in the car's blind spot
- quickly approaching vehicles in the left and right lanes closest to the car.

WARNING

BLIS is a supplementary aid and does not work in all situations.

BLIS is no substitute for a safe driving style and the use of rearview and door mirrors.

BLIS can never replace the driver's responsibility and attention - it is always the driver's responsibility to change lanes in a safe manner.

Overview

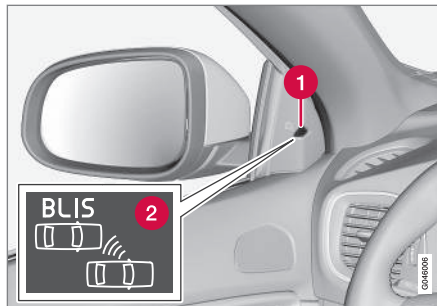

Position of the BLIS lamp³⁶.

- 1 Indicator lamp
- 2 BLIS symbol

NOTE

The lamp illuminates on the side of the car where the system has detected the vehicle. If the car is overtaken on both sides at the same time then both lamps illuminate.

Maintenance

The sensors for the BLIS functions are located inside the rear wing/bumper on each corner of the car.



Keep this surface clean - also on the left-hand side.

- To ensure optimal functionality, the areas in front of the sensors must be kept clean.

Related information

- BLIS - operation (p. 254)
- BLIS and CTA - symbols and messages (p. 257)
- CTA* (p. 255)

³⁶ NOTE: The illustration is schematic - details may vary depending on car model.



BLIS - operation

BLIS (Blind Spot Information System) is a function designed for providing support for the driver when driving in dense traffic on roads with several lanes in the same direction.

Activate/deactivate BLIS

BLIS is activated when the engine is started. This is confirmed by the indicator lamps in the door panels flashing once.



Button for activating/deactivating.

The **BLIS** function can be deactivated/activated by pressing the **BLIS** button on the centre console.

Some combinations of the selected equipment leave no vacant space for a button in the centre console - in which case the function is handled by the car's menu system MY CAR³⁷:

- Select **On** or **Off** at **Settings** → **Car settings** → **BLIS**.

When BLIS is deactivated/activated the lamp in the button goes out/illuminates and the combined instrument panel confirms the change with a text message. The door panel indicator lamps flash once upon activation.

To extinguish the message:

- Press the left stalk switch **OK** button.
- or
- Wait approx. 5 seconds – the message extinguishes.

When BLIS operates

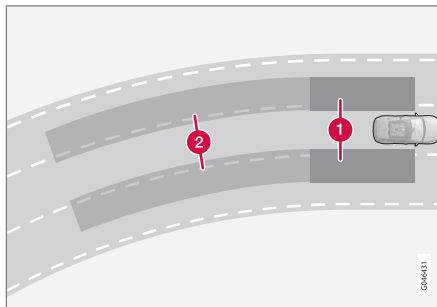

Principle for BLIS: 1. Zone in blind spot. 2. Zone for quickly approaching vehicle.

The BLIS function is active at speeds above approx. 10 km/h.

The system is designed to react when:

- the vehicle is overtaken by other vehicles
- another vehicle is quickly approaching the vehicle.

When BLIS detects a vehicle in zone 1 or a quickly approaching vehicle in zone 2, the door panel BLIS lamp illuminates with a constant glow. If the driver activates the direction indicator on the same side as the warning in this situation then the BLIS lamp will change from a constant glow to flashing with a more intense light.



WARNING

- BLIS does not work in sharp bends.
- BLIS does not work when the car is being reversed.

Limitations

- Dirt, ice and snow covering sensors can reduce functionality and make it impossible to provide warnings. BLIS cannot detect hazards if it is covered.
- Do not affix any objects, tape or labels in the area of the sensors.
- BLIS is deactivated when a trailer is connected to the car's electrical system.

³⁷ For information on the menu system - MY CAR (p. 108).



! IMPORTANT

Repair of the BLIS and CTA functions' components or repainting the bumpers must only be performed by a workshop - an authorised Volvo workshop is recommended.

Related information

- BLIS (p. 253)
- BLIS and CTA - symbols and messages (p. 257)

CTA*

The BLIS function CTA (Cross Traffic Alert) is a driver aid intended to warn about crossing traffic when the car is reversing. CTA is a supplement to BLIS (p. 253).

Activate/deactivate CTA

CTA is activated when the engine is started. This is confirmed by the indicator lamps in the door panels flashing once.



On/Off for parking assistance and CTA sensors.

In cars equipped with Parking assistance (p. 240), the CTA function can be deactivated/activated separately with the parking assistance On/Off button.

In cars without a button for parking assistance, the CTA function can be operated in the menu system **MY CAR** (p. 108), as follows:

- Search for **Cross Traffic Alert** under **BLIS** and uncheck - the CTA function is then deactivated.

However, the BLIS function remains activated after the CTA has been deactivated.

! WARNING

CTA is a supplementary aid and does not work in all situations.

CTA is no substitute for a safe driving style and the use of rearview and door mirrors.

CTA can never replace the driver's responsibility and attention - it is always the driver's responsibility to reverse in a safe manner.

When CTA operates

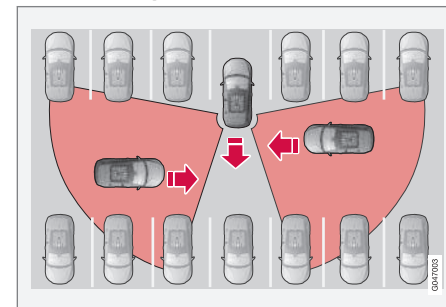

Principle for CTA.

CTA supplements the BLIS function by being able to see crossing traffic from the side dur-



07 Driver support



ing reversing, such as when reversing out of a parking space.

CTA is primarily designed to detect vehicles. In favourable conditions, it may also be able to detect smaller objects, such as cyclists and pedestrians.

CTA is only active during reversing and is activated automatically when reverse is selected at the gearbox.

- If CTA detects something approaching from the side, an acoustic warning signal sounds. The signal comes from either the left or the right speaker depending on which direction the approaching object is coming from.
- CTA also warns by illuminating the BLIS lamps.
- An additional warning is provided in the form of an illuminated icon in the display screen's PAS graphics (p. 240).

Limitations

CTA does not perform optimally in all situations, but has a certain limitation - for example, the CTA sensors cannot "see" through other parked vehicles or obstructing objects.

Here are some examples of when CTA's "field of vision" may be limited from the beginning and approaching vehicles cannot therefore be detected until they are very close:

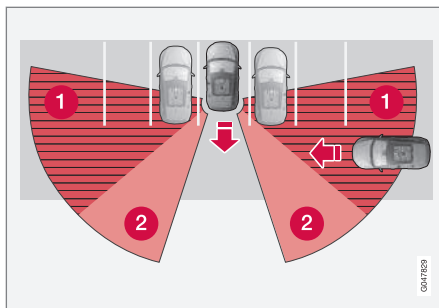

The car is parked deep inside a parking slot.

- 1 Blind CTA sector.
- 2 Sector where CTA can detect/"see".

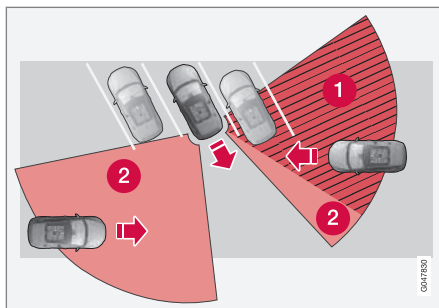

In an angled parking slot CTA can be completely "blind" on one side.

However, when the driver is slowly reversing the car, the angle is changed in relation to the

vehicle/object that is blocking, at which the blind sector rapidly decreases.

Examples of further limitations:

- Dirt, ice and snow covering sensors can reduce functionality and make it impossible to provide warnings. CTA cannot detect hazards if it is covered.
- CTA is deactivated when a trailer is connected to the car's electrical system.



IMPORTANT

Repair of the BLIS and CTA functions' components or repainting the bumpers must only be performed by a workshop - an authorised Volvo workshop is recommended.

Maintenance

The sensors for the BLIS and CTA functions are located inside the rear wing/bumper on each corner of the car.

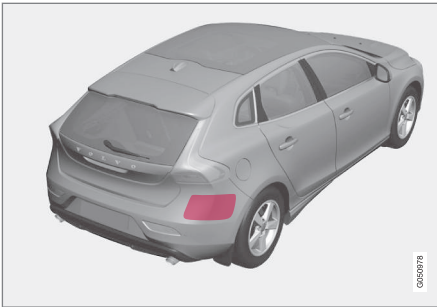

Keep this surface clean - also on the left-hand side.

- To ensure optimal functionality, the areas in front of the sensors must be kept clean.
- Do not affix any objects, tape or labels in the area of the sensors.

Related information

- BLIS (p. 253)
- BLIS and CTA - symbols and messages (p. 257)

BLIS and CTA - symbols and messages

In situations where the BLIS (Blind Spot Information System) (p. 253) and CTA (p. 255) functions fail or are interrupted, the combined instrument panel may show a symbol, supplemented by an explanatory message. Follow any recommendation given.

Message examples:

Message	Specification
CTA OFF	CTA has been deactivated manually. BLIS is active.
BLIS and CTA OFF Trailer attached	BLIS and CTA are temporarily disabled because a trailer is connected to the car's electrical system.
BLIS and CTA Service required	BLIS and CTA are not working. <ul style="list-style-type: none"> • Visit a workshop if the message remains - an authorised Volvo workshop is recommended.

A text message can be acknowledged by briefly pressing the **OK** button on the direction indicator stalk.

Related information

- BLIS (p. 253)
- CTA* (p. 255)



07 Driver support

Adjustable steering force

Speed related power steering causes the steering wheel force to increase with the speed of the car in order to give the driver enhanced sensitivity.

On motorways the steering feels firmer. Steering is light and requires no extra effort when parking and at low speed.

The driver can choose between three different levels of steering force for road responsiveness or steering sensitivity in the menu system **MY CAR** (p. 108):

- Once there, search for **Steering force level** and select **Low**, **Medium** or **High**.

This menu is not accessible when the car is moving.

NOTE

In certain situations the power steering may become too hot and then needs to be temporarily cooled - during this time the power steering operates with reduced power and turning the steering wheel may then be perceived to be slightly heavier.

In parallel with the temporarily reduced steering assistance the combined instrument panel shows a message.

Related information

- MY CAR (p. 108)

Type approval - radar system

Type approval for the radar system can be read in the table.

Country/ Area	
Singapore	<div style="border: 1px solid black; padding: 5px; text-align: center;"> Complies with IDA standards DA105753 </div> <p>IDA: Infocomm Development Authority of Singapore.</p>
Brazil	
Europe	<p>CE Delphi Electronics & Safety hereby declares that L2C0038TR and L2C0049TR are in compliance with the essential requirements and other relevant provisions of Directive 1999/5/EC. This declaration of conformity may, if necessary, be consulted with Delphi Electronics & Safety / One Corporate Center / Kokomo, Indiana 46904-9005 USA.</p>

Related information

- Radar sensor (p. 208)

08

STARTING AND DRIVING

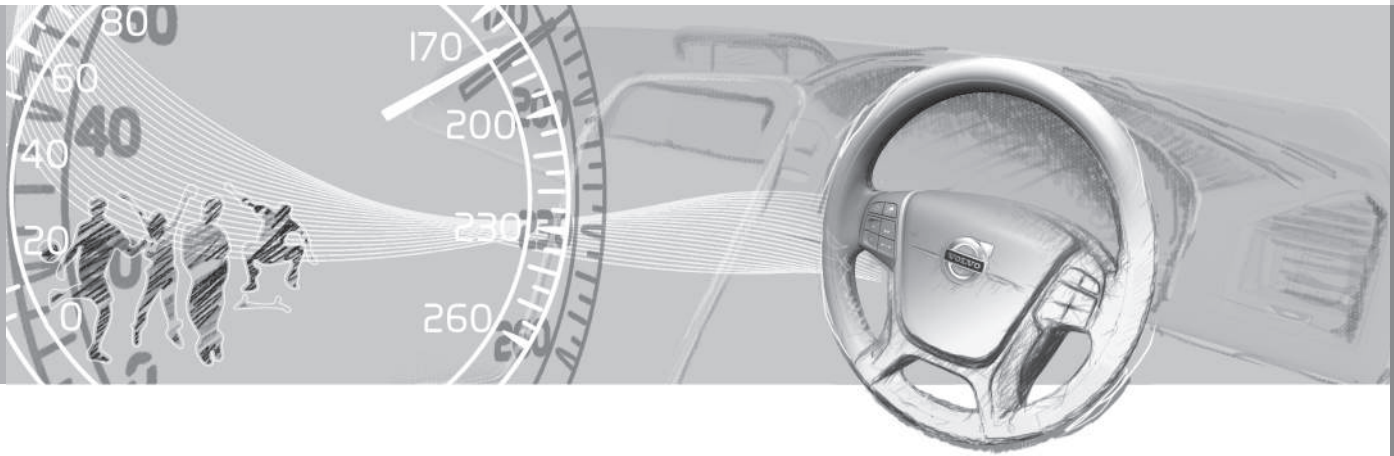



Alcohol lock*

The function of the alcohol lock is to prevent the car from being driven by individuals under the influence of alcohol. Before the engine can be started the driver must take a breath test that verifies that he/she is not under the influence of alcohol. Alcohol lock calibration takes place in accordance with each market's limit value in force for driving legally.

WARNING

The alcohol lock is an aid and does not exempt the driver from responsibility. It is always the responsibility of the driver to be sober and to drive the car safely.

Related information

- Alcohol lock* - functions and operation (p. 260)
- Alcohol lock* - storage (p. 261)
- Alcohol lock* - before starting the engine (p. 261)
- Alcohol lock* - to bear in mind (p. 263)
- Alcohol lock* - symbols and messages (p. 264)

Alcohol lock* - functions and operation

Functions

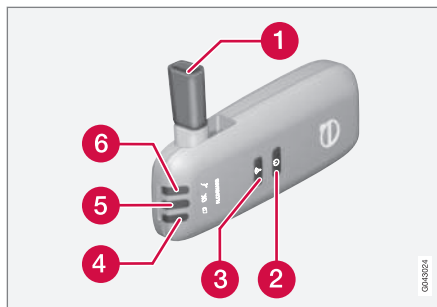

- 1 Nozzle for breath test.
- 2 Switch.
- 3 Transmission button.
- 4 Lamp for battery status.
- 5 Lamp for result of breath test.
- 6 Lamp indicates ready for breath test.

Operation Battery

Alcohol lock indicator lamp (4) shows battery status:

Indicator lamp (4)	Battery status
Green flashing	Charging in progress
Green	Fully charged
Yellow	Semi-charged
Red	Discharged - fit the charger in the holder or connect the power supply cable from the glovebox.

NOTE

Store the alcohol lock in its holder. This will keep the built-in battery fully charged and the alcohol lock is activated automatically when the car is opened.

Related information

- Alcohol lock* (p. 260)
- Alcohol lock* - storage (p. 261)
- Alcohol lock* - before starting the engine (p. 261)
- Alcohol lock* - to bear in mind (p. 263)
- Alcohol lock* - symbols and messages (p. 264)



Alcohol lock* - storage

Store the alcohol lock in its holder. Release the handheld unit by depressing it slightly into its holder and releasing it - it then springs out and can be removed from the holder.



Handheld unit storage and charging station.

- Replace the handheld unit in the holder by pushing it in until it engages.
- Store the handheld unit in the holder - this provides it with the best protection and keeps its batteries fully charged.

Related information

- Alcohol lock* (p. 260)
- Alcohol lock* - functions and operation (p. 260)
- Alcohol lock* - before starting the engine (p. 261)
- Alcohol lock* - to bear in mind (p. 263)

- Alcohol lock* - symbols and messages (p. 264)

Alcohol lock* - before starting the engine

The alcohol lock is activated automatically and is then ready for use when the car is opened.

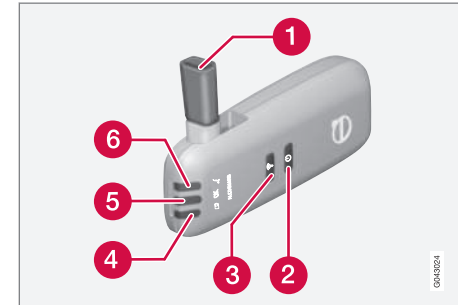

- 1 Nozzle for breath test.
 - 2 Switch.
 - 3 Transmission button.
 - 4 Lamp for battery status.
 - 5 Lamp for result of breath test.
 - 6 Lamp indicates ready for breath test.
1. When the indicator lamp (6) is green the alcohol lock is ready for use.
 2. Withdraw the alcohol lock from its holder. If the alcohol lock is outside the car when it is unlocked then it must first be activated with the switch (2).



08 Starting and driving



3. Fold up the nozzle (1), take a deep breath and blow with an even pressure until a "click" is heard after approx. 5 seconds. The result will be one of the alternatives in the following table **Result after breath test**.
4. If no message is shown then the transmission to the car may have failed - in which case, press the button (3) to transmit the result to the car manually.
5. Fold down the nozzle and refit the alcohol lock in its holder.
6. Start the engine following an approved breath test within 5 minutes - otherwise it must be repeated.

Result after breath test

Indicator lamp (5) + Display text	Specification
Green lamp + Alcoguard Approved test	Start the engine - no alcohol content measured.
Yellow lamp + Alcoguard Approved test	Engine starting possible - measured alcohol content is above 0.1 promille but below the limit value in force ^A .
Red lamp + Dis-approved test Wait 1 minute to try again	Engine starting not possible - measured alcohol content is above the limit value in force ^A .

^A Limit values vary from country to country. Find out what applies in your country. See also Alcohol lock* - to bear in mind (p. 263).



NOTE

After a completed period of driving, the engine can be restarted within 30 minutes without a new breath test.

- Alcohol lock* - storage (p. 261)
- Alcohol lock* - to bear in mind (p. 263)
- Alcohol lock* - symbols and messages (p. 264)

Related information

- Alcohol lock* (p. 260)
- Alcohol lock* - functions and operation (p. 260)



Alcohol lock* - to bear in mind

In order to obtain correct function and as accurate a measurement result as possible:

- Avoid eating or drinking approx. 5 minutes before the breath test.
- Avoid excess windscreen washing - the alcohol in the washer fluid may result in an incorrect measurement result.

Change of driver

In order to ensure that a new breath test is carried out in the event of a change of driver - depress the switch (2) and the send button (3) simultaneously for approx. 3 seconds. At which point the car returns to start inhibition mode and a new approved breath test is required before starting the engine.

Calibration and service

The alcohol lock must be checked and calibrated at a workshop¹ every 12 months.

30 days before recalibration is necessary the combined instrument panel shows the message **Alcoguard Calibration required See manual**. If calibration is not carried out within these 30 days then normal engine starting will be blocked - only starting with the Bypass function will then be possible, see the following heading "Emergency situation".

The message can be cleared by pressing the send button (3) once. Otherwise it goes out

on its own after approx. 2 minutes but then reappears each time the engine is started - only recalibration at a workshop¹ can clear the message permanently.

Cold or hot weather

The colder the weather the longer it takes before the alcohol lock is ready for use:

Temperature (°C)	Maximum heating time (seconds)
+10 to +85	10
-5 to +10	60
-40 to -5	180

At temperatures below -20 °C or above +60 °C the alcohol lock requires additional power supply. The combined instrument panel shows **Alcoguard Please insert power cable**. In which case, connect the power supply cable from the glovebox and wait until indicator lamp (6) is green.

In extremely cold weather the heating time can be reduced by taking the alcohol lock indoors.

Emergency situation

In the event of an emergency situation or the alcohol lock is out of order, it is possible to bypass the alcohol lock in order to drive the car.

NOTE

All activation with bypass is logged and saved in a memory; see Recording data (p. 18).

After the bypass function has been activated the combined instrument panel shows **Alcoguard Bypass enabled** the whole time while driving and can only be reset by a workshop¹.

The Bypass function can be tested without the error message being logged - in which case, carry out all the steps without starting the car. The error message is cleared when the car is locked.

When the alcohol lock is installed, either the Bypass or Emergency function is selected as the bypassing option. This setting can be changed afterwards at a workshop¹.

Activating the Bypass function

- Depress and hold the left-hand stalk switch **OK** button and the button for hazard warning flashers simultaneously for approx. 5 seconds - the combined instru-

¹ An authorised Volvo workshop is recommended.





08 Starting and driving



ment panel first shows **Bypass activated**
Please wait for 1 minute and then
Alcoguard Bypass enabled - after
which the engine can be started.

This function can be activated several times.
The error message shown during driving can
only be cleared at a workshop¹.

Activating the Emergency function

- Depress and hold the left-hand stalk switch **OK** button and the button for hazard warning flashers simultaneously for approx. 5 seconds - the combined instrument panel shows **Alcoguard Bypass enabled** and the engine can be started.

This function can be used once, after which a reset must be made at a workshop¹.

Related information

- Alcohol lock* (p. 260)
- Alcohol lock* - functions and operation (p. 260)
- Alcohol lock* - storage (p. 261)
- Alcohol lock* - before starting the engine (p. 261)
- Alcohol lock* - symbols and messages (p. 264)

Alcohol lock* - symbols and messages

In addition to the previously described messages related to how the alcohol lock works before starting the engine (p. 261), the following can also be displayed:

Display text	Meaning/Action
Alcoguard Restart possible	The engine has been switched off for less than 30 minutes - engine starting possible without new test.
Alcoguard Service required	Contact a workshop ^A .
Alcoguard No signal received	Transmission failed - send manually with button (3) or take a new breath test.
Alcoguard Please try again	Test failed - take a new breath test.
Alcoguard Please blow longer	Blowing too short - blow for longer.

Display text	Meaning/Action
Alcoguard Please blow softer	Blowing too hard - blow more gently.
Alcoguard Please blow harder	Blowing too weak - blow harder.
Alcoguard preheating Please wait	Heating not finished - wait for text Alcoguard Please blow for 5 seconds .

^A An authorised Volvo workshop is recommended.

Related information

- Alcohol lock* (p. 260)
- Alcohol lock* - functions and operation (p. 260)
- Alcohol lock* - storage (p. 261)
- Alcohol lock* - before starting the engine (p. 261)
- Alcohol lock* - to bear in mind (p. 263)

¹ An authorised Volvo workshop is recommended.

* Option/accessory, for more information, see Introduction.



Starting the engine

The engine is started and switched off using the remote control key and the **START/STOP ENGINE** button.



Ignition switch with remote control key extracted/inserted, and **START/STOP ENGINE** button.

! IMPORTANT

Do not press in the remote control key incorrectly turned - Hold the end with the detachable key blade - see Detachable key blade - detaching/attaching (p. 164)

1. Insert the remote control key in the ignition switch and press it in to its end position. Note that if the car is equipped with alcohol lock* then a breath test must first be approved before the engine can be started. For more information on the Alcohol lock, see Alcohol lock* (p. 260).
2. Hold the clutch pedal fully depressed². (For cars with automatic gearbox - Depress the brake pedal.)
3. Press the **START/STOP ENGINE** button and then release it.

The starter motor works until the engine is started or until its overheating protection triggers.

! IMPORTANT

If the engine fails to start after 3 attempts - wait for 3 minutes before making a further attempt. Starting capacity increases if the battery is allowed to recover.

! WARNING

Always remove the remote control key from the ignition switch when leaving the car, and make sure that the key position is **0** - in particular if there are children in the car. For information on how this works, see Key positions (p. 75).

i NOTE

The idling speed can be noticeably higher than normal for certain engine types during cold starting. This is done in order that the emissions system can reach normal operating temperature as quickly as possible, which minimises exhaust emissions and protects the environment.

Keyless Drive*

Follow steps 2–3 for keyless (p. 166) starting of petrol and diesel engines.

i NOTE

A prerequisite for the engine to start is that one of the car's remote control keys with the Keyless drive function is in the passenger compartment or cargo area.

! WARNING

Never remove the remote control key from the car while driving or during towing.

² If the car is moving then it is enough to press the **START/STOP ENGINE** button to start the car.





Related information

- Key positions (p. 75)

Switching off the engine

*The engine is switched off using the **START/STOP ENGINE** button.*

To switch off the engine:

- Press the **START/STOP ENGINE** button - the engine stops.
- If the car has an automatic gearbox and the gear selector is not in a position **P** or if the car is moving - Press twice or hold the **START/STOP ENGINE** button depressed until the engine stops.

Related information

- Key positions (p. 75)

Steering lock

The steering lock makes steering difficult if the car is e.g. taken unlawfully.

Function

- The steering lock locks when the driver's door is opened after the engine has been switched off.
- The steering lock unlocks when the remote control key is in the ignition switch³ and the **START/STOP ENGINE** button is depressed.

A mechanical noise can be perceived when the steering lock unlocks or locks.

Related information

- Starting the engine (p. 265)
- Key positions (p. 75)
- Steering wheel (p. 82)

³ Cars with Keyless drive only need to have a remote control key inside the passenger compartment.



Jump starting

If the starter battery (p. 370) is discharged then the car can be started with current from another battery.

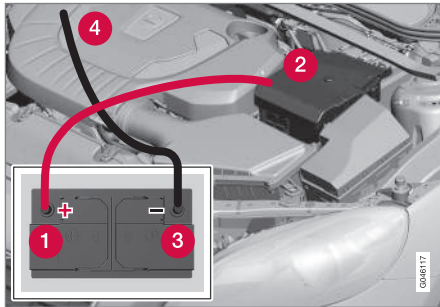

When jump starting the car, the following steps are recommended to avoid short circuits or other damage:

1. Set the car's electrical system in key position **0**, see Key positions (p. 75).
2. Check that the donor battery has a voltage of 12 V.
3. If the donor battery is installed in another car - switch off the donor car's engine and make sure that the two cars do not touch each other.

4. Connect one of the red jump lead's clamps to the donor battery's positive terminal (1).

! IMPORTANT

Connect the start cable carefully to avoid short circuits with other components in the engine compartment.

5. Open the clips on the front cover of the battery in your car and remove the cover.
6. Connect the red jump lead's other clamp onto the car's positive terminal (2).
7. Connect one of the black jump lead's clamps to the donor battery's negative terminal (3).
8. Connect the other clamp to a grounding point, e.g. right-hand engine mounting at the top, the outer screw head (4).
9. Check that the jump lead clamps are affixed securely so that there are no sparks during the starting procedure.
10. Start the engine of the "donor car" and allow it to run a few minutes at a speed slightly higher than idle approx. 1500 rpm.

11. Start the engine in the car with the discharged battery.

! IMPORTANT

Do not use the connections when attempting to start, as there is a risk of sparking.

12. Remove the jump leads in reverse order - first the black and then the red.
 - > Make sure that none of the black jump lead's clamps comes into contact with the battery's positive terminal or the clamp connected to the red jump lead!

! WARNING

- The battery can generate oxyhydrogen gas, which is highly explosive. A spark can be formed if a jump lead is connected incorrectly, and this can be enough for the battery to explode.
- The battery contains sulphuric acid, which can cause serious burns.
- If sulphuric acid comes into contact with eyes, skin or clothing, flush with large quantities of water. If acid splashes into the eyes - seek medical attention immediately.

Related information

- Starting the engine (p. 265)



Gearboxes

There are two main types of gearbox - Manual and Automatic.

- Manual gearbox (p. 268)
- Automatic gearbox - Geartronic (p. 269) and Powershift (p. 273)

IMPORTANT

To prevent damage to any drive system components, the working temperature of the gearbox is checked. If there is a risk of overheating, a warning symbol in the combined instrument panel lights up and a text message is shown. Follow the recommendation given in the text message.

Manual gearbox

The function of the gearbox is to change the gear ratio depending on speed and power requirements.

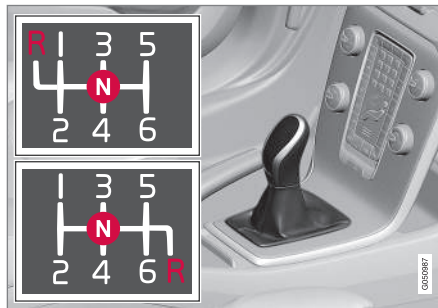

Gearing pattern.

The 6-speed box is available in two versions - reverse gear position differs between them. Look at the actual gearshift pattern imprinted on the gear lever.

- Depress the clutch pedal fully during each gear change.
- Take your foot off the clutch pedal between gear changes.

WARNING

Always apply the parking brake when parking on a slope - leaving the car in gear is not sufficient to hold the car in all situations.

Reverse gear inhibitor

The reverse gear inhibitor hinders the possibility of mistakenly attempting to engage reverse gear during normal forward travel.

- Follow the gearing pattern printed on the gear lever and start from neutral position, **N** before moving it to **R** position.
- Engage reverse gear only when the car is stationary.

Related information

- Transmission fluid - grade and volume (p. 404)
- Gearboxes (p. 268)



Gear shift indicator*

The gear shift indicator notifies the driver when it is appropriate to engage the next higher or lower gear in order to obtain the lowest possible fuel consumption.

An essential detail in connection with environmental driving is to drive in the right gear and to change gear in plenty of time.

An indicator is available as an aid on certain variants - GSI (Gear Shift Indicator) - which notifies the driver when it is appropriate to engage the next higher or lower gear in order to obtain the lowest possible fuel consumption. However, taking into consideration characteristics such as performance and vibration-free running, it may be advantageous to change gear at a higher engine speed.

Manual gearbox



Gear shift indicator for manual gearbox. Only one marker is illuminated at a time - it is illuminated in the centre only during normal driving.

When gearing up/down as recommended, the upper one is illuminated at "+" or the lower at "-", marked red in the illustration.

Automatic gearbox



Combined instrument panel "Digital" with gear shift indicator.

The framed number indicates the current gear.



With "Analogue" combined instrument panel, the gear positions and indicator arrows are displayed in its centre.

Related information

- Manual gearbox (p. 268)
- Automatic gearbox - Geartronic* (p. 269)

Automatic gearbox - Geartronic*

An automatic gearbox with Geartronic differs from an Automatic gearbox - Powershift (p. 273), in that it has a hydraulic torque converter that transfers power from engine to gearbox. It has two different gear modes - Automatic and Manual.



D: Automatic gear positions. **+/-:** Manual gear positions. **S:** Sport mode*.⁴

The combined instrument panel shows the position of the gear selector using the following indications: **P, R, N, D, S*, 1, 2, 3** etc.

⁴ The gear lever's gearshift pattern varies depending on engine option.





Gear positions

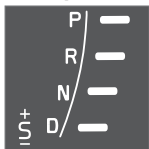

Automatic gear positions are indicated on the right of the combined instrument panel. (Only one marker is illuminated at a time - the one showing the current gear selector position.)

Symbol "S" for Sport mode is ORANGE when the mode is active.

P – Parking position

Select **P** when starting the engine or when the car is parked.

In order to move the gear selector from the **P** position the brake pedal must be depressed and the remote control key must be in position **I** or **II**.

The gearbox is mechanically blocked when the **P** position is engaged. Also apply the parking brake when the car is parked, see Parking brake (p. 291).

NOTE

The gear selector must be in **P** position to allow the car to be locked and alarmed.

IMPORTANT

The car must be stationary when position **P** is selected.

WARNING

Always apply the parking brake when parking on a slope - the automatic transmission in **P** is not sufficient to hold the car in all situations.

R – Reverse

The car must be stationary when position **R** is selected.

N – Neutral

No gear is engaged and the engine can be started. Apply the parking brake if the car is stationary with the gear selector in position **N**.

To be able to move the gear selector from **N** to other gear positions, the brake pedal must be depressed and the remote control key must be in key position **II**.

D – Drive

D is the normal driving position. Shifting up and down takes place automatically based on the level of acceleration and speed. The car must be stationary when the gear selector is moved to position **D** from position **R**.

Geartronic – Manual gear positions (+/-)

The driver can also change gear manually using the Geartronic automatic gearbox. The car engine-brakes when the accelerator pedal is released.

The manual gear position is reached by moving the lever to the side from position **D** to the

end position at "+/-". The combined instrument panel's symbol "+/-" changes colour from WHITE to ORANGE and the digits **1, 2, 3** etc. are displayed in a box which corresponds to the gear that has just been selected.

- Move the lever forwards towards + (plus) to change up a gear and release the lever, which returns to its neutral position between "+" and "-".

or

- Pull the lever back towards "-" (minus) to change down a gear and release it.

The manual gearshift mode "+/-" can be selected at any time while driving.

Geartronic automatically shifts down if the driver allows the speed to decrease lower than a level suitable for the selected gear, in order to avoid jerking and stalling.

To return to automatic driving mode:

- Move the lever to the side to the end position at **D**.

NOTE

If the gearbox has a Sport programme then the gearbox will only become manual after the lever has been moved forwards or backwards in its "+/-" position. The combined instrument panel then shifts the indication from **S** to show which of the gears **1, 2, 3** etc. is engaged.



Paddles*

As a supplement to manual gear changing with the gear selector there are also controls located on the steering wheel, so-called "paddles".

To be able to change gear with the steering wheel paddles they must first be activated. This is by means of pulling one of the paddles toward the steering wheel - the combined instrument panel then changes indication from "D" to a figure, which indicates the current gear.

To then change gear one step:

- Pull one of the paddles backwards - towards the steering wheel - and release.



Both steering wheel "paddles".

- ① "-": Selects the next lower gear.
- ② "+": Selects the next higher gear.

⁵ If the car has Sport mode* then "S" is shown first.

A gear change occurs at each pull of the paddle provided that the engine speed does not leave the permitted range.

After each gear change the combined instrument panel changes figure to show the current gear.

NOTE

Automatic deactivation

If the steering wheel paddles are not used then they are deactivated after a short time - this is indicated when the combined instrument panel switches indication, from the figure for the current gear back to "D".

The exception is during engine braking - then the paddles are activated as long as engine braking is in progress.

Manual deactivation

The steering wheel paddle shifters can also be deactivated manually:

- Pull both paddles toward the steering wheel and hold until the combined instrument panel changes character from the figure for the current gear to "D".

The paddles can also be used with the gear selector in Sport mode* - then the paddles are constantly activated without being deactivated.

Geartronic - Sport mode (S)



The Sport programme provides sportier characteristics and allows higher engine speed for the gears.

At the same time it responds more quickly to acceleration. During active driving, the use of a lower gear is prioritised, leading to a delayed upshift.

To activate Sport mode:

- Move the gear selector to the side from D position to the end position at "+S-" - the combined instrument panel changes indication from D to S.

Sport mode can be selected at any time while driving.

Geartronic - Winter mode

It can be easier to pull away on slippery roads if 3rd gear is engaged manually.

1. Depress the brake pedal and move the gear selector from D position to the end position at "+/-" - the combined instrument panel shifts the indication from D to the figure 1⁵.
2. Scroll up to gear 3 by pushing the lever forward towards "+" (plus) twice - the combined instrument panel shifts the indication from 1 to 3.
3. Release the brake and accelerate carefully.





The gearbox "winter mode" means that the car moves off with a lower engine speed and reduced engine power on the drive wheels.

Kick-down

When the accelerator pedal is pressed all the way to the floor (beyond the position normally regarded as full acceleration) a lower gear is immediately engaged. This is known as kick-down.

If the accelerator is released from the kick-down position, the gearbox automatically changes up.

Kick-down is used when maximum acceleration is needed, such as for overtaking.

Safety function

To prevent overrevving the engine, the gearbox control program has a protective downshift inhibitor which prevents the kick-down function.

Geartronic does not permit downshifting/ kick-down which would result in an engine speed high enough to damage the engine. Nothing happens if the driver still tries to shift down in this way at high engine speed – the original gear remains engaged.

When kick-down is activated the car can change one or more gears at a time depending on engine speed. The car changes up when the engine reaches its maximum speed in order to prevent damage to the engine.

Towing

If the car has to be towed - see important information in the section Towing (p. 309).

Related information

- Transmission fluid - grade and volume (p. 404)
- Gearboxes (p. 268)
- Automatic gearbox - Powershift* (p. 273)



Automatic gearbox - Powershift*

The Powershift automatic gearbox transmits the motive force from the engine to the drive wheels with double mechanical clutch discs, as opposed to Geartronic which instead uses a hydraulic torque converter.



D: Automatic gear positions. **+/-:** Manual gear positions. **S:** Sport mode*.⁶

Powershift transmission operates in the same way and has similar controls and functions as the Geartronic automatic transmission.

One exception is "Geartronic - Winter mode" (p. 269):

- Powershift enables driving away on a slippery road surface if **2nd** gear is engaged manually - instead of 3rd gear with Geartronic.

Towing

The model with Powershift transmission should not be towed as it is dependent on the engine running in order to receive sufficient lubrication. If towing (p. 309) still has to take place, the route must be as short as possible and then at very low speed.

In the event of uncertainty as to whether the car is equipped with Powershift or Geartronic transmission, this can be verified by checking the designation on the gearbox label under the bonnet, Type designations (p. 393). The designation "MPS6" means that it is Powershift transmission - otherwise it is Geartronic automatic transmission.

See also important information in section Towing (p. 309).

To bear in mind

The transmission's double clutch has overload protection that is activated if it becomes too hot, e.g. if the car is held stationary with the accelerator pedal on an uphill gradient for a long time.

Overheated transmission causes the car to shake and vibrate, and the warning symbol illuminates and the combined instrument panel shows a message. The transmission can also overheat during slow driving in

queues (10 km/h or slower) on an uphill gradient, or with a trailer hitched. The gearbox cools down when the car is stationary, with foot brake depressed and the engine running at idling speed.

Overheating during slow driving in queues can be avoided by driving in stages:

- Stop the car and wait with your foot on the brake pedal until there is a moderate distance to the traffic ahead, drive forward a short distance, and then wait another moment with your foot on the brake pedal.



IMPORTANT

Use the foot brake to hold the car stationary on an uphill gradient - do not hold the car with the accelerator pedal. The gearbox could then overheat.

Text message and action

In some situations the combined instrument panel may show a text message at the same time as a symbol is illuminated.

⁶ The gear lever's gearshift pattern varies depending on engine option.





08 Starting and driving



Symbol	Message	Driving characteristics	Action
	Transmission hot Brake to hold	Difficulty in maintaining even speed at constant engine speed.	Transmission overheated. Keep the car stationary using the foot brake. ^A
	Transmission hot Park safely Let engine run	Significant pulling in the car's traction.	Transmission overheated. Park the car immediately in a safe manner. ^A
	Transmission cooling Let engine run	No drive due to overheated gearbox.	Transmission overheated. For fastest cooling: Run the engine at idling speed with the gear lever in the N or P position until the message clears.

^A For fastest cooling: run the engine at idling speed with the gear lever in the **N** or **P** position, until the message clears.

The table shows three steps with an increased degree of seriousness should the transmission become too hot. In parallel with the text message, the driver is also advised that the car's electronics are temporarily changing the driving characteristics. Follow the instructions in the text message where appropriate.

NOTE

The examples in the table are no indication of the car being defective, but show that a safety function has been activated with a view to preventing damage to any of the car's components.

WARNING

If a warning symbol combined with the text **Transmission hot Park safely Let engine run** is ignored then the heat in the gearbox may become so high that the power transmission between engine and gearbox is temporarily halted in order to prevent the clutch from malfunctioning - the car then loses drive and is stationary until gearbox temperature has cooled to an acceptable level.

For more possible text messages with their respective proposals for solutions concerning automatic gearbox, see Messages (p. 106).

A text message extinguishes automatically after the action has been carried out or after one press on the indicator stalk **OK** button.

Related information

- Automatic gearbox - Geartronic* (p. 269)
- Transmission fluid - grade and volume (p. 404)



Gear selector inhibitor

There are two different types of gear selector inhibitor - mechanical and automatic.

Mechanical gear selector inhibitor

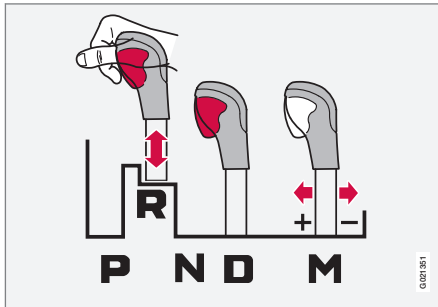

The gear selector can be moved forward and back freely between **N** and **D**. Other positions are locked with a latch that is released with the inhibitor button on the gear selector.

With the inhibitor button depressed the lever can be moved forwards or backwards between **P**, **R**, **N** and **D**.

Automatic gear selector inhibitor

The automatic gearbox has special safety systems:

Parking position (P)

Stationary car with engine running:

- Keep your foot on the brake pedal when moving the gear selector to another position.

Electric gear inhibitor – Shiftlock Parking position (P)

To be able to move the gear selector from **P** to other gear positions, the brake pedal must be depressed and the remote control key must be in position **II**.

Shiftlock – Neutral (N)

If the gear selector is in the **N** position and the car has been stationary for at least 3 seconds (irrespective of whether the engine is running) then the gear selector is locked.

To be able to move the gear selector from **N** to another gear position the brake pedal must be depressed and the remote control key must be in key position **II** (p. 75).

Deactivate automatic gear selector inhibitor

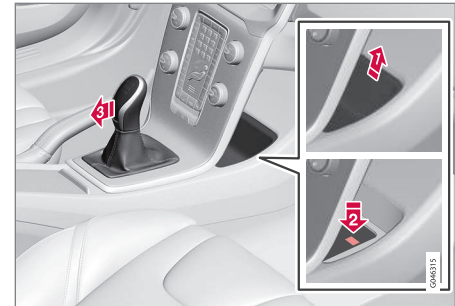

If the car cannot be driven, e.g. due to a flat starter battery, the gear selector must be moved from the **P** position so that the car can be moved.

- 1 Lift out the contoured insert in the compartment behind the centre console and locate a spring-loaded button in the bottom of the compartment.
- 2 Press and hold the button.
- 3 Move the gear selector from the **P** position and release the button.
- 4 Refit the storage compartment insert.

Related information

- Automatic gearbox - Geartronic* (p. 269)
- Automatic gearbox - Powershift* (p. 273)



Hill start assist (HSA)*

The foot brake can be released before setting off or reversing uphill - the HSA (Hill Start Assist) function means that the car does not roll backwards.

The function means that the pedal pressure in the brake system remains for several seconds while the driver's foot is moved from brake pedal to accelerator pedal.

The temporary braking effect releases after several seconds or when the driver accelerates.

Related information

- Starting the engine (p. 265)

Start/Stop*

Some engine and gearbox combinations come fitted with a Start/Stop function which engages in the event of e.g. stationary traffic or waiting at traffic lights - the engine is then switched off temporarily and restarts automatically when the journey is due to continue.

Environmental care is one of Volvo Car Corporation's core values and it influences all of our operations. This target orientation has resulted in several separate energy-saving functions of which Start/Stop is one, all with the collective task of reducing fuel consumption, which in turn helps to reduce exhaust emissions.

General information on Start/Stop

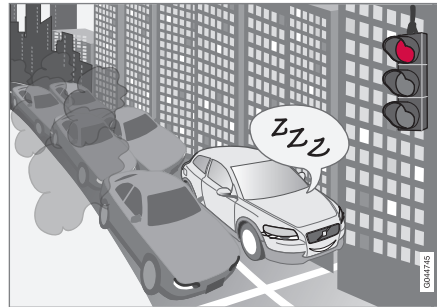

The engine is switched off - it becomes quieter and cleaner...

The Start/Stop function gives the driver the opportunity for a more active environmentally

conscious way of driving the car by means of being able to allow the engine to stop automatically, whenever appropriate.

Manual or Automatic

Note that there are differences in the Start/Stop function depending on whether the gearbox is manual or automatic.

Related information

- Start/Stop* - function and operation (p. 277)
- Starting the engine (p. 265)
- Start/Stop* - settings (p. 282)
- Start/Stop* - the engine does not auto-start (p. 281)
- Start/Stop* - the engine auto-starts (p. 280)
- Start/Stop* - the engine does not stop (p. 278)
- Start/Stop* - involuntary stop manual gearbox (p. 281)
- Start/Stop* - symbols and messages (p. 283)
- Battery - Start/Stop (p. 373)



Start/Stop* - function and operation

The Start/Stop function is activated automatically when the engine is started with the key.



The Start/Stop function is activated automatically when the engine is started with the key. The driver is alerted to the function by means of the symbol for the On/Off button illuminating in the combined instrument panel and the lamp in the On/Off button illuminating.



All of the car's normal systems such as lighting, radio, etc. work as normal even with an engine that has stopped automatically, except that some equipment may have the function temporarily reduced, e.g. the climate control system's fan speed or extremely high volume on the audio system.

Auto-stopping the engine

The following is required for the engine to auto-stop:

Conditions	M/A A
Dec clutch, set the gear lever in neutral position and release the clutch pedal - the engine stops automatically.	M
Stop the car with the foot brake and then keep your foot on the pedal - the engine stops automatically.	A

A M = Manual gearbox, A = Automatic gearbox.



If the ECO function is activated then the engine may auto-stop before the car is completely stationary.



The combined instrument panel's symbols for the Start/Stop function illuminate as verification and reminder that the engine has stopped automatically.

Auto-starting the engine

Conditions	M/ A ^A
With the gear lever in neutral position:	M
<ol style="list-style-type: none"> Depress the clutch pedal or press the accelerator pedal - the engine starts. Engage a suitable gear and drive. 	
Release the foot pressure on the foot brake - the engine starts automatically and the journey can continue.	A
Maintain foot pressure on the foot brake and depress the accelerator pedal - the engine auto-starts.	A
The following option is also available on a downhill gradient:	M + A
<ul style="list-style-type: none"> Release the foot brake and let the car move off - the engine starts automatically when the speed exceeds normal walking pace. 	

A M = Manual gearbox, A = Automatic gearbox.





Deactivating the Start/Stop function



In certain situations, it may be advisable to temporarily switch off the automatic Start/Stop function - this is carried out with a push of this button.



Disengaged function is indicated by the combined instrument panel's Start/Stop symbols and the button's lamp extinguishing.



The Start/Stop function is disengaged until it is reactivated with the button or until the next time the engine is started with the key.

Start assistance HSA

The foot brake can also be released on an uphill slope to auto-start the engine - the HSA (p. 276) (Hill Start Assist) function prevents the car from rolling backwards.

HSA means that the pressure in the brake system remains temporarily available while the driver's foot is moved from the brake pedal to the accelerator pedal for driving off with the engine having stopped automatically. The temporary braking effect releases after a couple of seconds or when the driver accelerates.

Related information

- Start/Stop* (p. 276)
- Starting the engine (p. 265)
- Start/Stop* - settings (p. 282)
- Start/Stop* - the engine does not auto-start (p. 281)
- Start/Stop* - the engine auto-starts (p. 280)
- Start/Stop* - the engine does not stop (p. 278)
- Start/Stop* - involuntary stop manual gearbox (p. 281)
- Start/Stop* - symbols and messages (p. 283)
- Battery - Start/Stop (p. 373)

Start/Stop* - the engine does not stop

Although the Start/Stop function is activated, the engine does not always stop automatically.

The engine does not auto-stop if:

Conditions	M/A A
the car has not first achieved approx. 8 km/h after a key start or the last auto-stop.	M + A
the driver has opened the seat-belt's buckle.	M + A
the capacity of the starter battery is below the minimum permissible level.	M + A
the engine does not have normal operating temperature.	M + A
ambient temperature is around freezing point or above approx. 30 °C.	M + A
the windscreen's electric heating is activated.	M + A



Conditions	M/A A
the environment in the passenger compartment differs from the pre-set values ^B - indicated by the ventilation fan running at a high speed.	M + A
the car is reversed.	M + A
the starter battery's temperature is below freezing point or too high.	M + A
the driver makes greater steering wheel movements.	M + A
the exhaust system's particulate filter is full - the temporarily disengaged Start/Stop function is reactivated as soon as an automatic cleaning cycle has been performed (see Diesel particle filter (DPF) (p. 300)).	M + A
the road is very steep.	M + A
a trailer is connected electrically to the car's electrical system.	M + A
the bonnet has been opened ^C .	M + A

Conditions	M/A A
the gearbox does not have normal operating temperature.	A
the atmospheric air pressure is less than equivalent to 1500-2500 metres above sea level - the current air pressure varies with the prevailing weather conditions.	A
adaptive cruise control Queue Assist is activated.	A
the gear selector is moved out of the D position to S position ^D or "+/-".	A

A M = Manual gearbox, A = Automatic gearbox.

B Car with ECC.

C With certain engines only.

D Sport mode.

Related information

- Start/Stop* (p. 276)
- Start/Stop* - function and operation (p. 277)
- Starting the engine (p. 265)
- Start/Stop* - settings (p. 282)
- Start/Stop* - the engine does not auto-start (p. 281)
- Start/Stop* - the engine auto-starts (p. 280)

- Start/Stop* - involuntary stop manual gearbox (p. 281)
- Start/Stop* - symbols and messages (p. 283)
- Battery - Start/Stop (p. 373)



Start/Stop* - the engine auto-starts

An auto-stopped engine may restart in certain cases without the driver having decided that the journey should continue.

In the following cases the engine also starts automatically if the driver has not depressed the clutch pedal (manual gearbox) or takes his/her foot off the brake pedal (automatic gearbox):

Conditions	M/A ^A
Misting forms on the windows.	M + A
The environment in the passenger compartment deviates from the preset values ^B .	M + A
There is a temporarily high current take-off or starter battery capacity drops below the lowest permissible level.	M + A
Repeated pumping of the brake pedal.	M + A
The bonnet is opened ^C .	M + A
The car starts to roll, or there is a small increase in speed if the car auto-stopped without being completely stationary.	M + A

Conditions	M/A ^A
The driver's seatbelt buckle is opened with the gear selector in D or N position.	A
Steering wheel movements ^C .	A
The gear selector is moved out of the D position to S position ^D , R or "+/-".	A
The driver's door is opened with the gear selector in D position - a "ping" sound and text message inform that the Start/Stop function is active.	A

A M = Manual gearbox, A = Automatic gearbox.

B Car with ECC.

C With certain engines only.

D Sport mode.

WARNING

Do not open the bonnet when the engine has stopped automatically - the engine may suddenly start automatically. First switch off the engine as normal using the **START/STOP ENGINE** button before opening the bonnet.

Related information

- Start/Stop* - function and operation (p. 277)
- Starting the engine (p. 265)

- Start/Stop* - settings (p. 282)
- Start/Stop* - the engine does not auto-start (p. 281)
- Start/Stop* - the engine does not stop (p. 278)
- Start/Stop* - involuntary stop manual gearbox (p. 281)
- Start/Stop* - symbols and messages (p. 283)
- Battery - Start/Stop (p. 373)
- Start/Stop* (p. 276)



Start/Stop* - the engine does not auto-start

The engine does not always auto-start after having auto-stopped.

In the following cases the engine does not auto-start after having auto-stopped:

Conditions	M/ A ^A
A gear is engaged without declutching - a display text prompts the driver to set the gear lever in neutral position in order to enable automatic starting.	M
The driver is unrestrained, the gear selector is in P position and the driver's door is open - a normal engine start must take place.	A

A M = Manual gearbox, A = Automatic gearbox.

Related information

- Start/Stop* (p. 276)
- Start/Stop* - function and operation (p. 277)
- Starting the engine (p. 265)
- Start/Stop* - settings (p. 282)
- Start/Stop* - the engine auto-starts (p. 280)
- Start/Stop* - the engine does not stop (p. 278)

- Start/Stop* - involuntary stop manual gearbox (p. 281)
- Start/Stop* - symbols and messages (p. 283)
- Battery - Start/Stop (p. 373)

Start/Stop* - involuntary stop manual gearbox

In the event that a start-up fails and the engine stops, proceed in accordance with the below:

1. Depress the clutch pedal again - the engine starts automatically.
2. In certain cases the gear lever must be set in neutral position. The combined instrument panel then shows the text **Put gear in neutral**.

Related information

- Start/Stop* (p. 276)
- Start/Stop* - function and operation (p. 277)
- Starting the engine (p. 265)
- Start/Stop* - settings (p. 282)
- Start/Stop* - the engine does not auto-start (p. 281)
- Start/Stop* - the engine auto-starts (p. 280)
- Start/Stop* - the engine does not stop (p. 278)
- Start/Stop* - symbols and messages (p. 283)
- Battery - Start/Stop (p. 373)



Start/Stop* - settings

The car's menu system MY CAR (p. 108) contains information on Volvo's Start-Stop system, as well as recommendations for energy-saving driving techniques.

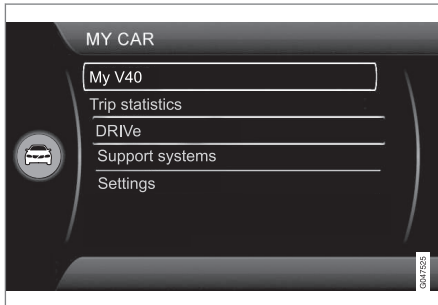

- Start/Stop* - symbols and messages (p. 283)
- Battery - Start/Stop (p. 373)

Related information

- Start/Stop* (p. 276)
- Start/Stop* - function and operation (p. 277)
- Starting the engine (p. 265)
- Start/Stop* - the engine does not auto-start (p. 281)
- Start/Stop* - the engine auto-starts (p. 280)
- Start/Stop* - the engine does not stop (p. 278)
- Start/Stop* - involuntary stop manual gearbox (p. 281)







Start/Stop* - symbols and messages

The Start/Stop function can show text messages in the combined instrument panel.

Text message

 In combination with this indicator lamp the Start/Stop function may display text messages in the combined instrument panel for certain situations.

For some of them there is a recommended action that should be performed. The following table shows some examples.

Symbol	Message	Info/Action	M/A ^A
	Auto Start/Stop Service required	Start/Stop is not operational. Contact a workshop - an authorised Volvo workshop is recommended.	M + A
	Autostart Engine running + acoustic signal	Activated if the driver's door is opened with auto-stopped engine and the gear selector in D position.	A
	Press start button	The engine will not start automatically - start the engine as normal with the START/STOP ENGINE button.	M + A
	Depress clutch pedal to start	The engine is ready to auto-start - waiting for the clutch pedal to be depressed.	M
	Depress brake and clutch pedals to start	The engine is ready to auto-start - waiting for the brake or clutch pedal to be depressed.	M
	Put gear in neutral to start	Gear is engaged without declutching - disengage and set the gear lever in neutral position.	M



Symbol	Message	Info/Action	M/A ^A
	Select P or N to start	Start/Stop has been deactivated - move the gear selector to N or P position and start the engine as normal with the START/STOP ENGINE button.	A
	Press start button	The engine will not start automatically - start the engine as normal with the START/STOP ENGINE button and the gear selector in P or N .	A

A M = Manual gearbox, A = Automatic gearbox.

If a message does not go out following completion of the action then a workshop should be contacted - an authorised Volvo workshop is recommended.

Related information

- Start/Stop* (p. 276)
- Start/Stop* - function and operation (p. 277)
- Starting the engine (p. 265)
- Start/Stop* - settings (p. 282)
- Start/Stop* - the engine does not auto-start (p. 281)
- Start/Stop* - the engine auto-starts (p. 280)
- Start/Stop* - the engine does not stop (p. 278)
- Start/Stop* - involuntary stop manual gearbox (p. 281)
- Battery - Start/Stop (p. 373)



ECO*

ECO⁷ is an innovative Volvo function for automatic-gearbox cars, capable of reducing fuel consumption by up to 5%, depending on the driver's driving style. The function gives the driver the option of a more active environmentally conscious way of driving.

General



The following are changed upon activation of the ECO function:

- Gearbox gearshift points.
- Engine management and response from the accelerator pedal.
- Start/Stop function - the engine can also auto-stop before the car has stopped down to being completely stationary.
- The Eco Coast function is activated - engine braking ceases.
- Climate control system settings - some electricity consumers are deactivated or operate at reduced power.

NOTE

When the ECO function is activated, several parameters in the climate control system's settings are changed, and several electricity consumer functions are reduced. Certain settings can be reset manually, but full functionality is only restored by deactivating the ECO function.

ECO - Operation

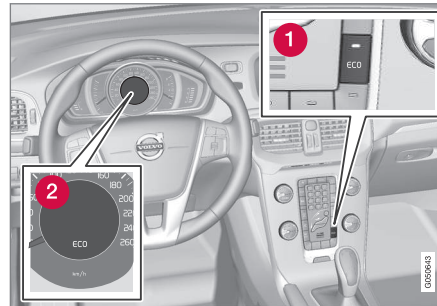

1 ECO On/Off

2 ECO symbol

The ECO function is deactivated when the engine is switched off, and must therefore be activated after each time the engine is started. There are exceptions for certain engines. However, it is easily verified by means of both the combined instrument pan-

el's ECO symbol and the ECO- button's lamp illuminating when the function is activated.

ECO function On or Off

ECO



Disengaged ECO function is indicated by the combined instrument panel ECO symbol and the ECO button lamp extinguishing. The function is then switched off until it is reactivated with the ECO button.

Eco Coast - Function

The Eco Coast subfunction means in practice that engine braking is deactivated, meaning in turn that the car's kinetic energy is used to coast for longer distances. When the driver releases the accelerator pedal the gearbox is automatically disengaged from the engine whose speed is reduced to idling speed with minimum consumption.

This function is intended for use in the event of an anticipated reduction in speed, e.g. to coast forward to an intersection or a red light.

Eco Coast enables proactive driving where the driver can use the so-called "Pulse & Glide" technique and a minimum of braking.

Combination On and Off

A combination of Eco Coast and temporarily deactivated ECO function can also collec-

⁷ Not possible on the V40 CROSS COUNTRY AWD.





tively contribute to reduced consumption. Accordingly:

- Active Eco Coast: Long coasting **without** engine braking = Low consumption and
- Deactivated ECO function: Short coasting **with** engine braking = Minimum consumption.

NOTE

However, to achieve optimal low fuel consumption, Eco Coast in combination with short coasting distances should generally be avoided.

Activating Eco Coast

The function is activated when the accelerator pedal is fully released, in combination with the following parameters:

- **ECO** button activated
- Gear selector in **D** position
- Speed within the range of approx. 65-140 km/h
- The road's downhill gradient is not steeper than approx. 6%.

Deactivate Eco Coast

In certain situations it may be desirable to deactivate the Eco Coast function. Examples of such situations include:

- on steep downhill gradients - to be able to use engine braking.
- before an imminent overtaking manoeuvre - in order to be able to complete it in the safest possible way.

Deactivating Eco Coast and returning to engine braking can be performed as follows:

- Press the **ECO** button.
- Move the gear lever to manual "**S+/-**" position.
- Change gear with the steering wheel paddle shifters.
- Actuate the accelerator or brake pedal.

Eco Coast - Limitations

The function is not available if:

- cruise control is activated
- the road's downhill gradient is steeper than approx. 6%
- manual gear changing is performed with the steering wheel paddle shifters*
- engine and/or gearbox are not at normal operating temperature.
- the gear selector is moved from **D-** to "**S +/-**" position
- speed is outside the range of approx. 65-140 km/h

More information and settings

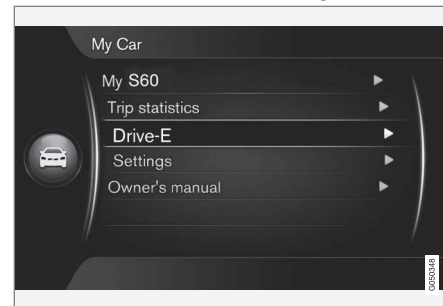

The car's menu system **MY CAR** contains further information on the ECO concept - see the section MY CAR (p. 108).

Related information

- General information on climate control (p. 121)



All Wheel Drive⁸ (AWD)*

All Wheel Drive (AWD – All Wheel Drive) means that the car is driven by all four wheels. All-wheel drive is always engaged.

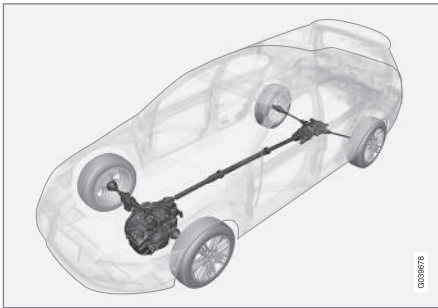

AWD principle⁹.

The power is automatically distributed between the front and rear wheels. An electronically controlled clutch system distributes the power to the wheels that have the best grip on the current road surface. This provides the best traction and prevents wheel spin. Under normal driving conditions, the majority of power is transmitted to the front wheels.

All-wheel drive improves driving safety in rain, snow and icy conditions.

Related information

- Hill Descent Control (HDC) (p. 287)

Hill Descent Control (HDC)¹¹

HDC can be compared to an automatic engine brake. When you release the accelerator on downhill gradients the car is normally braked by means of the engine striving for low engine idling speeds, so-called engine braking. But the steeper the roadway and the more load in the car, the faster the car coasts despite engine braking - the HDC function compensates for this with automatic brake intervention.

General information on HDC

The function makes it possible to increase/reduce speed on steep downhill gradients, with a foot only on the accelerator pedal, without using the footbrake. The sensitivity of the accelerator pedal decreases and becomes more precise by means of the full actuation of the pedal being restricted to adjusting engine speed within a limited range. The brake system brakes itself and provides the car with a low and even speed, so allowing the driver to fully focus on steering.

HDC is particularly helpful on steep gradients with an uneven road surface and slippery sections. E.g. when launching a boat on a trailer from a ramp.

⁸ V40 CROSS COUNTRY

⁹ The figure is schematic - details may vary depending on market and model.

¹¹ HDC is only possible on the V40 CROSS COUNTRY AWD.



08 Starting and driving



WARNING

HDC does not work in all situations but is designed merely as a supplementary aid.

The driver always bears ultimate responsibility for ensuring that the vehicle is driven safely.

Function



HDC On/Off.

HDC is activated or deactivated with one of the centre console's switches. The lamp within it illuminates when the function is activated.

 When HDC is working normally the combined instrument panel's symbol illuminates combined with the text message **Hill descent control ON**.

The function only operates in first gear position and in reverse gear. For an automatic

gearbox, gear position **1** must be selected, which is shown with the figure 1 in the combined instrument panel, see Automatic gearbox - Geartronic* (p. 269).

NOTE

HDC cannot be activated on an automatic gearbox in position **D**.

Operation

HDC allows the car to roll at a maximum of 10 km/h forwards with engine braking and 7 km/h backwards. However, any speed within the gear's speed register can be selected using the accelerator pedal. When the accelerator pedal is released, the car is braked quickly to 10 or 7 km/h respectively, irrespective of the hill's gradient and without the need for the footbrake.

The brake lights come on automatically when the function is operating. The driver can brake or stop the car at any time by using the footbrake.

HDC is deactivated:

- with the centre console's On/Off button
- if a gear higher than **1** is selected on a manual gearbox
- if a gear higher than **1** is selected on an automatic gearbox, or if the gear selector is moved to position **D**.

The function can be disengaged at any time. If it takes place on a steep downhill gradient then the braking effect will not release directly, but slowly instead.

NOTE

With HDC activated you may experience a delay between acceleration pedal activation and engine response.

Related information

- All Wheel Drive (AWD)* (p. 287)



Foot brake

The foot brake is used to reduce the car's speed while driving.

The car is equipped with two brake circuits. If a brake circuit is damaged then the brake pedal will engage deeper and a higher pressure on the pedal is needed to produce the normal braking effect.

The driver's brake pedal pressure is assisted by a brake servo.

WARNING

The brake servo only works when the engine is running.

If the brake is used when the engine is switched off then the pedal will feel stiff and more force must be used to brake the car.

In very hilly terrain or when driving with a heavy load the brakes can be relieved by using engine braking. Engine braking is most efficiently used if the same gear is used downhill as up.

For more general information on heavy loads on the car, Engine oil - adverse driving conditions (p. 400).

Cleaning the brake discs

Coatings of dirt and water on the brake discs may result in delayed brake function. This

delay is minimised by cleaning the brake linings.

Manual cleaning is advisable with wet road surfaces, prior to long-stay parking and after the car has been washed. Carry this out by braking gently during a short period while en route.

Maintenance



To keep the car as safe and reliable as possible, follow the Volvo service intervals as specified in the Service and Warranty Booklet.

IMPORTANT



The wear on the brake system's components must be checked regularly.

Contact a workshop for information about the procedure or engage a workshop to carry out the inspection - an authorised Volvo workshop is recommended.

Symbols in the combined instrument panel

Symbol	Specification
	Constant glow – Check the brake fluid level. If the level is low, fill with brake fluid and check for the cause of the brake fluid loss.
	Constant glow for 2 seconds when the engine is started – automatic function check.

WARNING

If  and  illuminate at the same time, there may be a fault in the brake system.

If the level in the brake fluid reservoir is normal at this stage, drive carefully to the nearest workshop and have the brake system checked - an authorised Volvo workshop is recommended.

If the brake fluid is below the **MIN** level in the brake fluid reservoir, do not drive further before topping up the brake fluid.

The reason for the loss of brake fluid must be investigated.



Related information

- Parking brake (p. 291)
- Foot brake - emergency brake lights and automatic hazard warning flashers (p. 290)
- Foot brake - emergency brake assistance (p. 291)
- Foot brake - anti-lock braking system (p. 290)

Foot brake - anti-lock braking system

The anti-lock braking system, ABS (Anti-lock Braking System), prevents the wheels from locking up during braking.

The function allows the steering ability to be maintained, and it is easier to swerve to avoid a hazard for example. Vibration may be felt in the brake pedal when this is engaged and this is normal.

A short test of the ABS system is made automatically after the engine has been started when the driver releases the brake pedal. A further automatic test of the ABS system may be made when the car reaches 10 km/h. The test may be experienced as pulses in the brake pedal.

Related information

- Foot brake (p. 289)
- Parking brake (p. 291)
- Foot brake - emergency brake lights and automatic hazard warning flashers (p. 290)
- Foot brake - emergency brake assistance (p. 291)

Foot brake - emergency brake lights and automatic hazard warning flashers

Emergency brake lights are activated to alert vehicles behind about sudden braking. The function means that the brake light flashes instead of - as in normal braking - shining with a constant glow.

Emergency brake lights are activated at speeds above 50 km/h if the ABS system is working and/or in the event of sudden braking. After the car's speed has been slowed below 10 km/h the brake light returns from flashing to the normal constant glow - while at the same time the Hazard warning flashers are activated, and they flash until the driver accelerates the car to at least 20 km/h or they are deactivated with their button.

Related information

- Foot brake (p. 289)
- Parking brake (p. 291)
- Foot brake - emergency brake assistance (p. 291)
- Foot brake - anti-lock braking system (p. 290)



Foot brake - emergency brake assistance

Emergency brake assistance EBA (Emergency Brake Assist) helps to increase the braking force and so reduce the braking distance.

EBA detects the driver's braking style and increases the braking force when necessary. The brake force can be reinforced up to the level when the ABS system is engaged. The EBA function is interrupted when the pressure on the brake pedal is reduced.

i NOTE

When EBA is activated the brake pedal lowers slightly more than usual, depress (hold) the brake pedal as long as necessary. If the brake pedal is released then all braking ceases.

Related information

- Foot brake (p. 289)
- Parking brake (p. 291)
- Foot brake - emergency brake lights and automatic hazard warning flashers (p. 290)
- Foot brake - anti-lock braking system (p. 290)

Parking brake

The parking brake holds the car stationary, when the driver's seat is empty, by mechanically locking/blocking two wheels.

! WARNING

Always apply the parking brake when parking on a slope - leaving the car in gear, or in **P** if it has automatic transmission, is not sufficient to hold the car in all situations.



Combined instrument panel warning symbol.

Applying the parking brake

1. Press the foot brake pedal down firmly.

2. Pull the lever firmly.
 - > The combined instrument panel warning symbol comes on.

i NOTE

(P) - The combined instrument panel's warning symbol illuminates regardless of whether the parking brake is applied slightly or fully.

3. Release the foot brake pedal and make sure that the car is at a standstill position.
4. If the vehicle moves then the parking brake lever must be applied at least a little more firmly.
 - When parking the vehicle, always engage 1st gear (for manual gearbox) or put the gear selector in position **P** (for automatic gearbox).

Parking on a hill

If the car is parked facing uphill:

- Turn the wheels **away from** the kerb.

If the car is parked facing downhill:

- Turn the wheels **towards** the kerb.

Disengaging the parking brake

1. Press the foot brake pedal down firmly.



2. Pull the lever up slightly, press the button, release the lever and release the button.
 - > The combined instrument panel warning symbol goes off.

If the driver forgets to release the parking brake – in addition to the illuminated warning lamp – a pinging sound combined with a message in the combined instrument panel alerts the driver of this when the car's speed exceeds 10 km/h.

Related information

- Foot brake (p. 289)

Driving in water

Fording means that the car is driven through a water-covered roadway. Forging must be carried out with great caution.

The car can be driven through water at a maximum depth of 30 cm at a maximum speed of 10 km/h. Extra caution should be exercised when passing through flowing water.

During driving in water, maintain a low speed and do not stop the car. When the water has been passed, depress the brake pedal lightly and check that full brake function is achieved. Water and mud for example can make the brake linings wet resulting in delayed brake function.

- Clean the electric contacts of the electric engine block heater and trailer coupling after driving in water and mud.
- Do not let the car stand with water over the sills for any long period of time - this could cause electrical malfunctions.



IMPORTANT

Engine damage can occur if water enters the air filter.

In depths greater than 30 cm, water could enter the transmission. This reduces the lubricating ability of the oils and shortens the service life of these systems.

Damage to any component, engine, transmission, turbocharger, differential or its internal components caused by flooding, hydrostatic locking or oil shortage, is not covered by the warranty.

In the event of the engine stalling in water, do not try restart - tow the car from the water to a workshop - an authorised Volvo workshop is recommended. Risk of engine breakdown.

Related information

- Recovery (p. 311)
- Towing (p. 309)



Overheating

Under special conditions, for example hard driving in hilly terrain and hot climate, there is a risk that the engine and drive system may overheat - in particular with a heavy load.

For information about overheating when driving with a trailer, see Driving with a trailer (p. 301).

- Remove any auxiliary lamps from in front of the grille when driving in hot climates.
- If the temperature in the engine's cooling system is too high then a warning symbol is illuminated and a text message **High engine temperature Stop safely** is shown in the combined instrument panel's information display - stop the car in a safe way and allow the engine to run at idling speed for several minutes in order to cool down.
- If the text message **High engine temperature Turn off engine** or **Engine coolant level low Stop safely** is shown then the engine must be switched off after stopping the car.
- In the event of overheating in the gearbox a built-in protection function is activated, which is indicated in the combined instrument panel with a warning symbol and the text message **Transmission hot Reduce speed** or **Transmission hot Stop safely Wait for cooling** - follow the recommendation given and lower the speed and stop the car in a safe way and

allow the engine to run at idling speed for a few minutes in order to allow the gearbox to cool down.

- If the car overheats, the air conditioning may be switched off temporarily.
- Do not turn the engine off immediately you stop after a hard drive.

NOTE

It is normal for the engine's cooling fan to operate for a time after the engine has been switched off.

Related information

- Driving with a trailer - manual gearbox (p. 303)
- Driving with a trailer - automatic gearbox (p. 303)

Driving with open tailgate

When driving with the tailgate open, toxic exhaust fumes can be sucked into the car through the cargo area.

WARNING

Do not drive with an open tailgate! Toxic exhaust fumes could be drawn into the car through the cargo area.

Related information

- Loading (p. 148)



Overload - starter battery

The electrical functions in the car load the starter battery to varying degrees. Avoid using the key position **II** when the engine is switched off. Instead use the **I** mode - which uses less power, see Key positions - functions at different levels (p. 76).

Also, be aware of different accessories that load the electrical system. Do not use functions which use a lot of power when the engine is switched off. Examples of such functions are:

- ventilation fan
- headlamps
- windscreen wiper
- audio system (high volume).

If the battery voltage is low the information display shows the text **Low battery charge Power save mode**. The energy-saving function then shuts down certain functions or reduces certain functions such as the ventilation fan and/or audio system.

- In which case, charge the starter battery by starting the engine and then running it for at least 15 minutes - battery charging is more effective during driving than running the engine at idling speed while stationary.

Related information

- Starter battery - general (p. 370)

Before a long journey

Before a long journey, it makes good sense to go through the following points:

- Check that the engine is working normally and that fuel consumption (p. 409) is normal.
- Make sure that there are no leaks (fuel, oil or other fluid).
- Check all bulbs and tyre tread depths.
- Carrying a warning triangle (p. 324) is a legal requirement in certain countries.

Related information

- Engine oil - checking and filling (p. 355)
- Spare wheel* (p. 319)
- Lamp replacement - general (p. 360)

Winter driving

For winter driving it is important to perform certain checks in order to ensure that the car can be driven safely.

To bear in mind:

Check the following in particular before the cold season:

- The engine coolant (p. 403) must contain at least 50% glycol. This mixture protects the engine against frost erosion down to approximately -35°C . To achieve optimum antifreeze protection, different types of glycol must not be mixed.
- The fuel tank must be kept filled to prevent condensation.
- Engine oil viscosity is important. Oils with lower viscosity (thinner oils) facilitate starting in cold weather and also reduce fuel consumption while the engine is cold. For more information on suitable oils, see Engine oil - adverse driving conditions (p. 400).



IMPORTANT

Low viscosity oil must not be used for hard driving or in hot weather.

- The condition of the battery and charge level must be inspected. Cold weather



places great demands on the battery and its capacity is reduced by the cold.

- Use washer fluid (p. 370) to avoid ice forming in the washer fluid reservoir.

To achieve optimum roadholding Volvo recommends using winter tyres on all wheels if there is a risk of snow or ice.

i NOTE

The use of winter tyres is a legal requirement in certain countries. Studded tyres are not permitted in all countries.

Slippery driving conditions

Practise driving on slippery surfaces under controlled conditions to learn how the car reacts.

Fuel filler flap - Opening/closing

The fuel filler flap can be opened/closed as follows:

Opening/closing the fuel filler flap

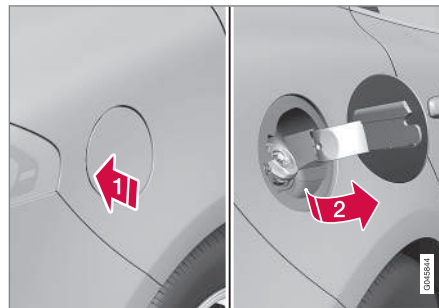

- ➔ Open the fuel filler flap by slightly pressing in the rear part of the hatch.
- ➔ Take out the flap.

Close the flap after fuelling.

For a description of locking and unlocking the fuel filler flap, see Locking/unlocking - fuel filler flap (p. 175). The fuel filler flap's lock logic also follows the locking or unlocking of the Keyless system and the central locking system.

Related information

- Filling up with fuel (p. 296)

Fuel filler flap - manual opening

The fuel filler flap can be opened manually when it cannot be opened from outside.

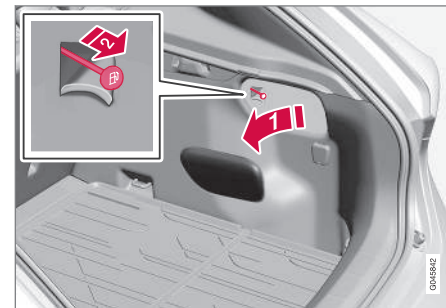

- ➔ Open/remove the side hatch in the cargo area (same side as fuel filler flap).
- ➔ Carefully pull the line back in a straight line. The flap can now be opened from outside.

i IMPORTANT

Pull the wire gently - minimal force is required to disengage the hatch lock.

Related information

- Locking/unlocking - fuel filler flap (p. 175)
- Filling up with fuel (p. 296)



Filling up with fuel

The fuel tank is fitted with a coverless fuel filler system. Filling is carried out as follows:

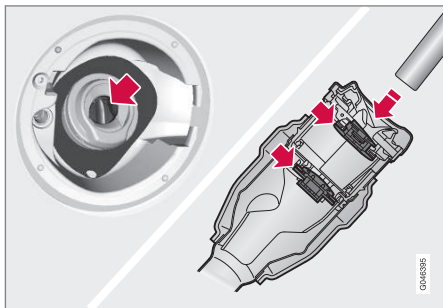

- Open the fuel filler flap (p. 295). See also Fuel filler flap - manual opening (p. 295).
- Insert the pump nozzle in the fuel filler opening. Take care to insert the nozzle **properly** into the filler pipe. The filler pipe consists of two opening covers. The nozzle must be pushed past both covers before refuelling is started.
- Do not overfill the tank but fill until the pump nozzle cuts out.

i NOTE

Excess fuel in the tank can overflow in hot weather.

i NOTE

Avoid spilling by waiting approximately 5-8 seconds before carefully removing the nozzle once refuelling is complete.

Related information

- Filling with fuel - with a fuel can (p. 300)

Fuel - handling

Fuel of a lower quality than that recommended by Volvo must not be used as engine power and fuel consumption is negatively affected.

! WARNING

Always avoid inhaling fuel vapour and fuel splashing in the eyes.

In the event of fuel in the eyes, remove any contact lenses and rinse the eyes in plenty of water for at least 15 minutes and seek medical attention.

Never swallow fuel. Fuels such as petrol and diesel are highly toxic and could cause permanent injury or be fatal if swallowed. Seek medical attention immediately if fuel has been swallowed.

! WARNING

Fuel which spills onto the ground can be ignited.

Switch off the fuel-driven heater before starting to refuel.

Never carry an activated mobile phone when refuelling. The ring signal could cause spark build-up and ignite petrol fumes, leading to fire and injury.



! IMPORTANT

Mixtures of various fuel types or use of fuels which are not recommended will invalidate Volvo's guarantees and any supplementary service agreements; this is applicable to all engines.

i NOTE

Extreme weather conditions, driving with a trailer or driving at high altitudes in combination with fuel grade are factors that could affect the car's performance.

Related information

- Economical driving (p. 301)

Fuel - petrol

Petrol is used as fuel.

Only use petrol from well-known producers. Never use fuel of dubious quality. Petrol must fulfil the EN 228 standard if this is available.

- 95 RON can be used for normal driving.
- 98 RON is recommended for optimum performance and minimum fuel consumption.

When driving in temperatures above +38 °C, fuel with the highest possible octane rating is recommended for optimum performance and fuel economy.

! IMPORTANT

- Use only unleaded petrol to avoid damaging the catalytic converter.
- Fuel that contains up to 10 volume-% ethanol is permitted.
- Fuel containing metallic additives must not be used.
- Do not use any additives which have not been recommended by Volvo.

! IMPORTANT

- Fuel that contains up to 10 percent by volume ethanol is permitted.
- EN 228 E10 petrol (max 10 percent by volume ethanol) is approved for use.
- Ethanol higher than E10 (max 10 percent by volume ethanol) is not permitted, e.g. E85.
- Ethanol higher than E10 (max 10 percent by volume ethanol) is not permitted, e.g. E85.

Related information

- Economical driving (p. 301)
- Fuel - handling (p. 296)
- Filling up with fuel (p. 296)



Fuel - diesel

Diesel is used as fuel.

Only use diesel fuel from well-known producers. Never use fuel of dubious quality. Diesel fuel should fulfil the EN 590 or JIS K2204 standard. Diesel engines are sensitive to contaminants in the fuel, such as metals and a high volume of sulphur for example.

At low temperatures (-6 °C to -40 °C), a paraffin precipitate may form in the diesel fuel, which may lead to ignition problems. Special diesel fuel designed for low temperatures around freezing point is available from the major oil companies. This fuel is less viscous at low temperatures and reduces the risk of paraffin precipitate.

The risk of condensation in the fuel tank is reduced if the tank is kept well filled. When refuelling, check that the area around the fuel filler pipe is clean. Avoid spilling fuel onto the paintwork. Wash off any spillage with detergent and water.

IMPORTANT

Diesel fuel must:

- fulfil the EN 590 and/or SS 155435 standards
- have a sulphur content not exceeding 10 mg/kg
- have a maximum of 7 vol % FAME (Fatty Acid Methyl Ester).

IMPORTANT

Diesel type fuels that must not be used:

- Special additives
- Marine diesel fuel
- Heating oil
- FAME¹³ (Fatty Acid Methyl Ester) and vegetable oil.

These fuels do not fulfil the requirements in accordance with Volvo recommendations and generate increased wear and engine damage that is not covered by the Volvo warranty.

Empty tank

The design of the fuel system in a diesel engine means that if the vehicle runs out of fuel, the tank may need to be vented in the workshop in order to restart the engine after fuelling.

Once the engine has stopped due to fuel starvation, the fuel system needs a few moments to carry out a check. Do this before starting the engine, once the fuel tank has been filled with diesel:

1. Insert the remote control key in the ignition switch and push it in to the end position, see Key positions (p. 75).
2. Press the **START** button **without** depressing the brake and/or clutch pedal.
3. Wait approx. one minute.
4. To start the engine: Depress the brake and/or clutch pedal and then press the **START** button again.

NOTE

Before filling with fuel in the event of fuel shortage:

- Stop the car on as flat/level ground as possible - if the car is tilting there is a risk of air pockets in the fuel supply.

Draining condensation from the fuel filter

The fuel filter separates condensation from the fuel. Condensation can disrupt engine operation.

The fuel filter must be drained at the intervals specified in the Service and Warranty Booklet

¹³ Diesel fuel may contain a certain amount of FAME, but further amounts must not be added.



or if you suspect that the car has been filled with contaminated fuel, see Volvo service programme (p. 347).

IMPORTANT

Certain special additives remove the water separation in the fuel filter.

Related information

- Diesel particle filter (DPF) (p. 300)
- Fuel - handling (p. 296)
- Economical driving (p. 301)

Catalytic converters

The purpose of the catalytic converters is to purify exhaust gases. They are located close to the engine so that operating temperature is reached quickly.

The catalytic converters consist of a monolith (ceramic or metal) with channels. The channel walls are lined with a thin layer of platinum/rhodium/palladium. These metals act as catalysts, i.e. they participate in and accelerate a chemical reaction without being used up themselves.

Lambda-sond™ oxygen sensor

The Lambda-sond is part of a control system intended to reduce emissions and improve fuel economy. For more information, see Fuel consumption and CO₂ emissions (p. 409).

An oxygen sensor monitors the oxygen content of the exhaust gases leaving the engine. This value is fed into an electronic system that continuously controls the injectors. The ratio of fuel to air directed to the engine is continuously adjusted. These adjustments create optimal conditions for efficient combustion, and together with the three-way catalytic converter reduce harmful emissions (hydrocarbons, carbon monoxide and nitrous oxides).

Related information

- Economical driving (p. 301)
- Fuel - petrol (p. 297)

- Fuel - diesel (p. 298)



Filling with fuel - with a fuel can

When filling with fuel (p. 296) from a fuel can, use the funnel located under the floor hatch in the cargo area.

IMPORTANT

Statutory provisions relating to storage of reserve fuel cans in cars vary from country to country. Check what does apply.

Take care to insert the funnel **properly** into the filler pipe. The filler pipe consists of two opening covers. The funnel must be pushed past both covers before filling is started.

Related information

- Locking/unlocking - fuel filler flap (p. 175)
- Fuel filler flap - manual opening (p. 295)

Diesel particle filter (DPF)

Diesel cars are equipped with a particle filter, which results in more efficient emission control.

The particles in the exhaust gases are collected in the filter during normal driving. So-called "regeneration" is started in order to burn away the particles and empty the filter. This requires the engine to have reached normal operating temperature.

Filter regeneration takes place automatically and normally takes 10-20 minutes. It may take a little longer at a low average speed. Fuel consumption may increase slightly during regeneration.

Regeneration in cold weather

If the car is frequently driven short distances in cold weather then the engine does not reach normal operating temperature. This means that regeneration of the diesel particle filter does not take place and the filter is not emptied.

When the filter has become approximately 80% full of particles, a yellow warning triangle is shown in the combined instrument panel, and the message **Soot filter full** See manual is shown in the information display.

Start regeneration of the filter by driving the car until the engine reaches normal operating temperature, preferably on a main road or

motorway. The car should then be driven for approximately 20 minutes more.

NOTE

The following may arise during regeneration:

- a smaller reduction of engine power may be noticed temporarily
- fuel consumption may increase temporarily
- a smell of burning may arise.

When regeneration is complete the warning text is cleared automatically.

Use the parking heater* in cold weather so that the engine reaches normal operating temperature more quickly.

IMPORTANT

If the filter is completely filled with particles, it may be difficult to start the engine and the filter is non-functional. Then there is a risk that the filter will need to be replaced.

Related information

- Fuel - diesel (p. 298)
- Economical driving (p. 301)



Economical driving

Driving economically means driving smoothly while thinking ahead and adjusting your driving style and speed to the prevailing conditions.

- Use the ECO Guide* (p. 65) which indicates how fuel-efficiently the car is being driven.
- For lowest fuel consumption, activate ECO* (p. 285)¹⁴ which can further reduce fuel consumption.
- Do not use winter tyres when the winter season is over.
- Drive in the highest gear possible, adapted to the current traffic situation and road - lower engine speeds result in lower fuel consumption. Use the gear shift indicator (p. 269)¹⁵.
- Avoid sudden unnecessary acceleration and heavy braking.
- High speed results in increased fuel consumption - the wind resistance increases with speed.
- Do not run the engine to operating temperature at idling speed, but rather drive with a light load as soon as possible - a cold engine consumes more fuel than a warm one.

- Drive with the correct air pressure in the tyres and check this regularly - select ECO tyre pressure for best results, see Tyres - approved tyre pressures (p. 412).
- Choice of tyres can affect fuel consumption - seek advice on suitable tyres from a dealer.
- Remove unnecessary items from the car - the greater the load the higher the fuel consumption.
- Use engine braking to slow down, when it can take place without risk to other road users.
- A roof load and ski box increase air resistance, leading to higher fuel consumption - remove the load carriers when not in use.
- Avoid driving with open windows.

For more information, see Volvo Cars' environmental philosophy (p. 21) and Fuel consumption and CO2 emissions (p. 409).

WARNING

Never switch off the engine while moving, such as downhill, this deactivates important systems such as the power steering and brake servo.

Driving with a trailer

When driving with a trailer there are a number of important points to think about regarding e.g. the towing bracket, the trailer and how the load is positioned in the trailer.

Payload depends on the car's kerb weight. The total of the weight of the passengers and all accessories, e.g. towbar, reduces the car's payload by a corresponding weight. For more detailed information, see Weights (p. 396).

If the towing bracket is mounted by Volvo, then the car is delivered with the necessary equipment for driving with a trailer.

- The car's towing bracket must be of an approved type.
- If the towbar is retrofitted, check with your Volvo dealer that the car is fully equipped for driving with a trailer.
- Distribute the load on the trailer so that the weight on the towing bracket complies with the specified maximum towbar load.
- Increase the tyre pressure to the recommended pressure for a full load. For information on the tyre pressure, see Tyres - approved tyre pressures (p. 412).
- The engine is loaded more heavily than usual when driving with a trailer.

¹⁴ Automatic gearbox

¹⁵ Manual gearbox





08 Starting and driving



- Do not tow a heavy trailer when the car is brand new. Wait until it has been driven at least 1000 km.
- The brakes are loaded much more than usual on long and steep downhill slopes. Downshift to a lower gear and adjust your speed.
- For safety reasons, the maximum permitted speed for the car when coupled with a trailer should not be exceeded. Follow the regulations in force for the permitted speeds and weights.
- Maintain a low speed when driving with a trailer up long, steep ascents.
- Avoid driving with a trailer on inclines of more than 12%.

Trailer cable

An adapter is required if the car's towing bracket has a 13 pin connector and the trailer has a 7 pin connector. Use an adapter cable approved by Volvo. Make sure the cable does not drag on the ground.

Direction indicators and brake lights on the trailer

If any of the trailer's lamps for direction indicators are broken, the symbol for direction indicators in the combined instrument panel flashes faster than normal and the information display shows the text **Trailer indicator malfunction**.

If any of the trailer's lamps for the brake light are broken then the **Trailer brake light malfunction** text is shown.

Level control*

The rear shock absorbers maintain a constant height irrespective of the car's load (up to the maximum permissible weight). When the car is stationary the rear of the car lowers slightly, which is normal.

Trailer weights

For information on Volvo's permitted trailer weights, see Towing capacity and towball load (p. 397).



NOTE

The stated maximum permitted trailer weights are those permitted by Volvo. The maximum permitted speed for a car with a trailer attached is 100 km/h. National vehicle regulations may further restrict the trailer weight and speed. Towbars can be certified for higher towing weights than the car can actually tow.



WARNING

Follow the stated recommendations for trailer weights. Otherwise, the car and trailer may be difficult to control in the event of sudden movement and braking.

Related information

- Towing bracket (p. 304)
- Lamp replacement - general (p. 360)



Driving with a trailer - manual gearbox

When driving with a trailer (p. 301) in hilly terrain in a hot climate there may be a risk of overheating.

- Do not run the engine at higher revolutions than 4500 rpm (diesel engines: 3500 rpm) - otherwise the oil temperature may become too high.

Diesel engine 5-cyl

- In the event of a risk of overheating the optimal speed for the engine is 2300-3000 rpm for optimal circulation of the coolant.

Related information

- Manual gearbox (p. 268)

Driving with a trailer - automatic gearbox

When driving with a trailer in hilly terrain in a hot climate there may be a risk of overheating.

- An automatic gearbox selects the optimum gear related to load and engine speed.
- In the event of overheating, a warning symbol is illuminated in the combined instrument panel and a text message is shown in the information display - follow the recommendation given.

Steep inclines

- Do not lock the automatic transmission in a higher gear than the engine "can cope with" - it is not always a good idea to drive at a high gear with low engine revolutions.



IMPORTANT

See also the specific information on slow driving with a trailer for cars with automatic gearbox - Powershift (p. 273).

Parking on a hill

1. Depress the foot brake.
2. Activate the parking brake.
3. Move the gear selector to position **P**.
4. Release the foot brake.

- Move the gear selector to park position **P** when parking an automatic car with a hitched trailer. Always use the parking brake.
- Block the wheels with chocks when parking a car with hitched trailer on a hill.

Starting on a hill

1. Depress the foot brake.
2. Move the gear selector to driving position **D**.
3. Release the parking brake.
4. Release the foot brake and start driving off.

Related information

- Automatic gearbox - Geartronic* (p. 269)
- Automatic gearbox - Powershift* (p. 273)



Towing bracket

A towing bracket means that it is possible to e.g. tow a trailer behind the car.

If the car is equipped with a detachable towbar, the installation instructions for the loose section must be followed carefully, see Detachable towbar* - attachment/removal (p. 305).

WARNING

If the car is fitted with a Volvo detachable towbar:

- Follow the installation instructions carefully.
- The detachable section must be locked with the key before setting off.
- Check that the indicator window shows green.

Important checks

- The towbar's towball must be cleaned and greased regularly.

WARNING

The moving parts of the detachable towbar must not be lubricated/oiled. This may reduce safety.

NOTE

When a hitch with a vibration damper is used, the towball must not be lubricated.

Related information

- Driving with a trailer (p. 301)
- Detachable towbar* - specifications (p. 305)
- Detachable towbar* - storage (p. 304)

Detachable towbar* - storage

Store the detachable towbar in the cargo area.

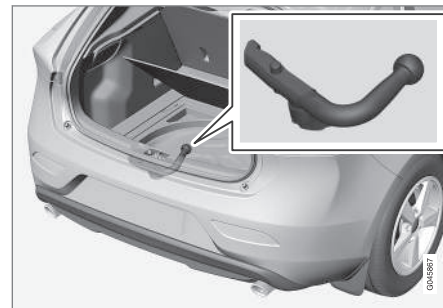

The storage location for the removable towbar.

IMPORTANT

Always remove the detachable towbar after use and store it in the designated location in the car.

Related information

- Detachable towbar* - specifications (p. 305)
- Detachable towbar* - attachment/removal (p. 305)
- Driving with a trailer (p. 301)



Detachable towbar* - specifications

Specifications for detachable towbar.

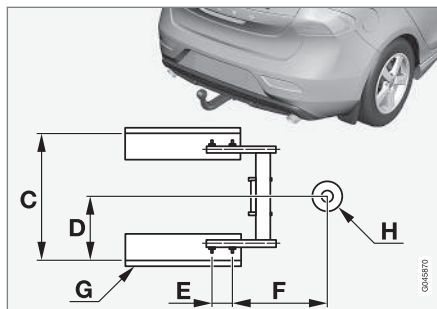
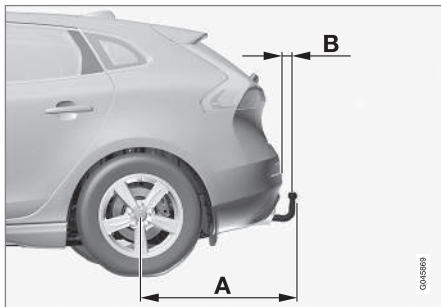

Dimensions, mounting points (mm)

A	887
B	73
C	881
D	441
E	109
F	306
G	Side member
H	Ball centre

Related information

- Detachable towbar* - attachment/removal (p. 305)
- Detachable towbar* - storage (p. 304)
- Driving with a trailer (p. 301)

Detachable towbar* - attachment/removal

The attachment/removal of the detachable towbar is performed in the following way:

Attaching

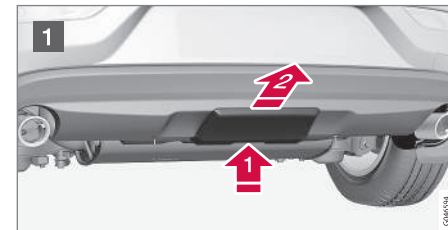

- 1 Remove the protective cover by first pressing in the catch and then pulling the cover straight back .

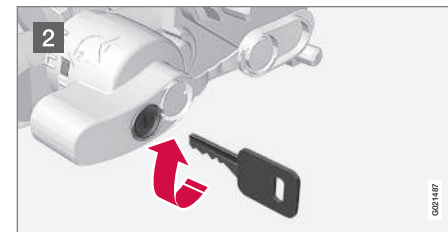

- 2 Ensure that the mechanism is in the unlocked position by turning the key clockwise.



08 Starting and driving

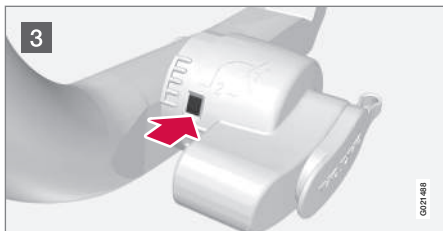

3 The indicator window must show red.

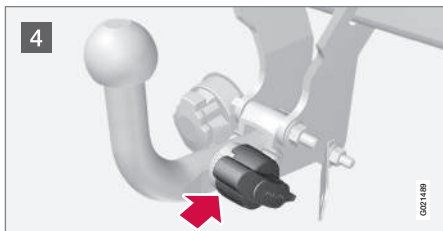

4 Insert the towball section until you hear a click.

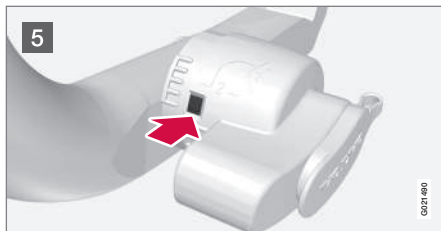

5 The indicator window must show green.



6 Turn the key anticlockwise to locked position. Remove the key from the lock.

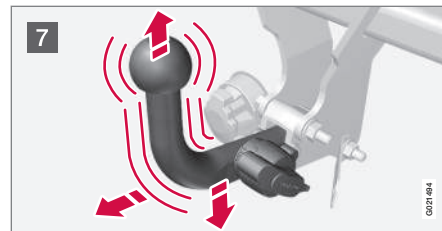

7 Check that the towball section is secure by pulling it up, down and back.

WARNING

If the towball is not fitted correctly then it must be detached and reattached in accordance with the previous instructions.

IMPORTANT

Only grease in the ball for the towball hitch, the remainder of the towbar must be clean and dry.



8 Safety cable.

WARNING

Take care to secure the trailer's safety cable in the intended bracket.

Removal of removable towbar

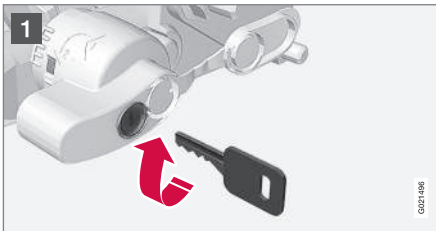

1 Insert the key and turn it clockwise to the unlocked position.

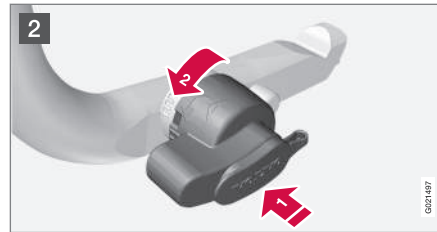

2 Push in the locking wheel and turn it anticlockwise until you hear a click.



3 Turn the locking wheel down fully, until it comes to a stop. Hold it in this position while pulling the towball rearward and upward.

WARNING

Secure the detachable towbar safely if it is stored in the car, see Detachable towbar* - storage (p. 304).

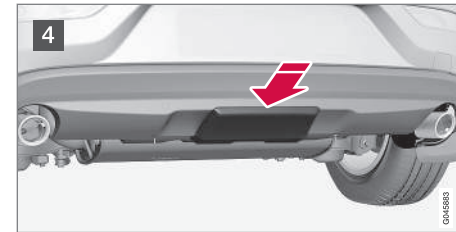

4 Push the protective cover until it snaps tight.

Related information

- Detachable towbar* - storage (p. 304)
- Detachable towbar* - specifications (p. 305)
- Driving with a trailer (p. 301)



Trailer Stability Assist - TSA¹⁶

The trailer stability assist TSA (Trailer Stability Assist) function is designed to stabilise the car and trailer combination if it begins to snake.

TSA- the function is included in the stability system (p. 183) ESC¹⁷.

Function

The snaking phenomenon can occur with any car/trailer combination. Snaking normally occurs at high speeds. But, there is a risk of it occurring at lower speeds (70-90 km/h) if the trailer is overloaded or the load is improperly distributed, e.g. too far back.

In order for snaking to occur, there must be a triggering factor, e.g.:

- Car with trailer subjected to a sudden and powerful side wind.
- Car with trailer drives on an uneven road surface or in a pothole.
- Sweeping steering wheel movements.

Operation

If snaking has started, it could be difficult or even impossible to suppress. This makes the car/trailer combination difficult to control and there is a risk that you could, for example, end up in the wrong lane or leave the carriageway.

The trailer stability assist function continually monitors car movements, particularly lateral movements. If snaking is detected, the front wheels are individually braked. This serves to stabilise the car/trailer combination. This is often enough to help the driver regain control of the car.

If snaking is not eliminated the first time the TSA system comes into action, the car/trailer combination is braked with all wheels and engine power is reduced. Once snaking has been gradually suppressed and the car/trailer combination is once again stable, the TSA system stops regulating and the driver once again has full control of the car. For more information, see Electronic stability control (ESC) - general (p. 183).

Miscellaneous

The TSA system can engage within the speed interval 65-160 km/h.

NOTE

TSA function is switched off if the driver selects **Sport** mode, see Electronic stability control (ESC) - general (p. 183).

TSA may fail to engage if the driver uses severe steering wheel movements to try to rectify the snaking because in such a situation the TSA system cannot determine

whether it is the trailer or the driver that is causing the snaking.



The **ESC**¹⁷ symbol in the combined instrument panel flashes when the TSA system is working.

Related information

- Electronic stability control (ESC) - general (p. 183)

¹⁶ Included in the installation of Volvo genuine towbar.

¹⁷ (Electronic Stability Control) - Electronic stability control.



Towing

During towing, one vehicle is towed by another vehicle using a tow rope.

Find out the statutory maximum speed limit for towing before towing begins.

1. Unlock the steering lock (p. 266) by inserting the remote control key in the ignition switch and giving a long press on the **START/STOP ENGINE** button - key position **II** (p. 76) is activated.
2. The remote control key must remain in the ignition switch while the car is being towed.
3. Keep the towline taut when the towing vehicle reduces speed by holding your foot gently pressed on the brake pedal - thereby avoiding unnecessary jerking.
4. Be prepared to brake to stop.

WARNING

- Check that the steering lock is unlocked before towing.
- The remote control key must be in key position **II** - in position **I** all airbags are deactivated.
- Never remove the remote control key from the ignition switch when the car is being towed.

WARNING

The brake servo and power steering do not work when the engine is switched off - the brake pedal needs to be depressed about 5 times more heavily and the steering is considerably heavier than normal.

Manual gearbox

Prior to towing:

- Move gear lever into neutral and release the parking brake.

Automatic gearbox Geartronic

IMPORTANT

Note that the car must always be towed with the wheels rolling forward.

- Do not tow cars with automatic transmission at speeds higher than 80 km/h or for distances in excess of 80 km. Follow the speeds that are permitted in accordance with local traffic regulations.

Prior to towing:

- Move the gear selector to position **N** and release the parking brake.

Automatic gearbox Powershift

Models with the Powershift gearbox should not be towed. If towing still has to take place,

the route must be as short as possible and then with very low speed.

In the event of uncertainty as to whether or not the car is equipped with Powershift transmission, this can be verified by checking the type designation (p. 393) on the gearbox label under the bonnet. The designation "MPS6" means that it is Powershift transmission - otherwise it is Geartronic automatic transmission.

IMPORTANT

Avoid towing.

- However, the car can be towed for a short distance at low speed to move it from a dangerous position - not further than 10 km and not faster than 10 km/h. Note that the car must always be towed with the wheels rolling forward.
- In the event of moving a longer distance than 10 km, the car must be transported with the drive wheels raised from the road - professional recovery is recommended.

Prior to towing:

- Move the gear selector to position **N** and release the parking brake.



Jump starting

Do not tow the car to bump start the engine. Use a donor battery if the starter battery is discharged and the engine does not start, see Jump starting (p. 267).

! IMPORTANT

The catalytic converter may be damaged during attempts to tow-start the engine.

Related information

- Towing eye (p. 310)

Towing eye

The towing eye is screwed into a threaded socket behind a cover on the right-hand side of the bumper, front or rear.

Attaching the towing eye

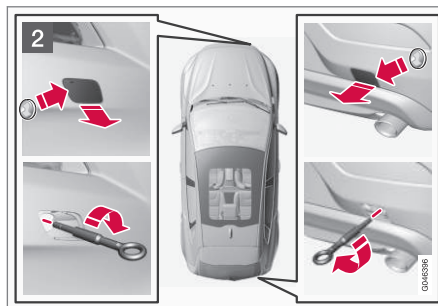
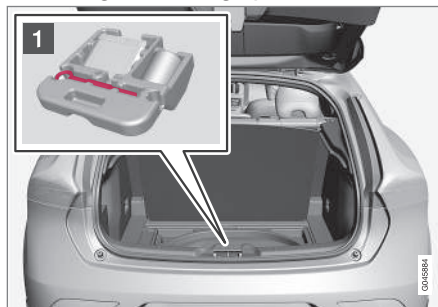

- 1 Take out the towing eye that is located under the floor hatch in the cargo area.

i NOTE

To access the towing eye/wheel wrench in the foam block:

- **Version 1:** Lift the emergency puncture repair kit compressor unit (point 5) to access the wheel wrench. Lift out the bottle of sealant (point 6) to access the towing eye.
- **Version 2:** Lift the emergency puncture repair kit compressor unit (point 5) to access the towing eye. The wheel wrench is located underneath the jack.



2 The cover for the towing eye's attachment point is available in two variants which must be opened in the following way:

- Open the rear bumper's recess using a coin or similar inserted in the recess, carefully turning it outwards. Then turn out the cover completely and remove it.
- The front bumper's recess has a marking along one side or in a corner: Press the marking with a finger and fold out the opposite side/corner at the same time - the cover turns around its axis and can then be removed.

Screw the towing eye right in up to its flange. Turn in the towing eye firmly e.g. using the wheel wrench.

The towing eye is unscrewed after use. Place the towing eye back in its position.

Finish by refitting the cover onto the bumper.

IMPORTANT

The towing eye is only designed for towing on roads - **not** for pulling the car unstuck or out of a ditch. Call a recovery service for recovery assistance.

Related information

- Towing (p. 309)
- Recovery (p. 311)

Recovery

Recovery means that the vehicle is transported away by means of another vehicle.

Call a recovery service for recovery assistance.

The towing eye may be used to pull the car up onto a recovery vehicle with a flatbed platform. The car's position and ground clearance determine whether it is possible. If the slope of the recovery vehicle's ramp is too steep, or if the ground clearance under the car is inadequate, then the car may be damaged if you try to pull it up using the towing eye. Raise the car using the recovery vehicle's lifting device if necessary.

IMPORTANT

Note that the car must always be transported with the wheels rolling forward.

- An all-wheel drive car (AWD) with raised front suspension must not be towed at speeds above 70 km/h. It should not be towed further than 50 km.

Related information

- Towing (p. 309)

09



WHEELS AND TYRES

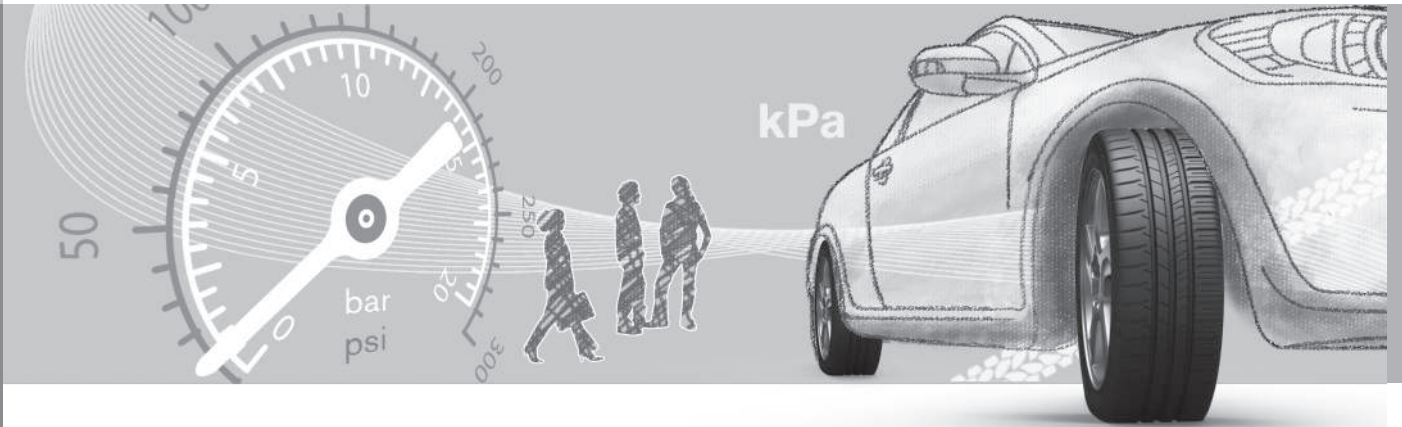



Tyres - maintenance

Amongst other things, the function of the tyres is to provide grip on the road surface, dampen vibration and protect the wheel from wear.

Driving characteristics

Tyres greatly affect the car's driving characteristics. The type of tyre, dimensions, tyre pressure and speed rating are important for how the car performs.

Tyre age

All tyres older than 6 years old should be checked by an expert even if they seem undamaged. Tyres age and decompose, even if they are hardly ever or never used. The function can therefore be affected. This applies to all tyres that are stored for future use. Examples of external signs which indicate that the tyre is unsuitable for use are cracks or discoloration.

New tyres

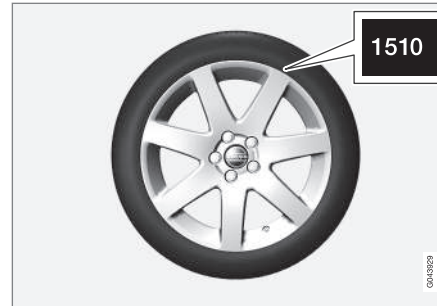

Tyres are perishable. After a few years they begin to harden at the same time as the friction capacity/characteristics gradually deteriorate. For this reason, aim to get as fresh tyres as possible when you replace them. This is especially important with regard to winter tyres. The last four digits in the sequence mean the week and year of manufacture. This is the tyre's DOT marking (Department of Transportation), and this is stated with four digits, for example 1510. The tyre in the figure was manufactured in week 15 of 2010.

Summer and winter tyres

When summer and winter wheels are changed the wheels should be marked with which side of the car they were mounted on, for example **L** for left and **R** for right.

Wear and maintenance

Correct tyre pressure (p. 315) results in more even wear. Driving style, tyre pressure, climate and road condition affect how quickly your tyres age and wear. To avoid differences in tread depth and to prevent wear patterns (p. 315) arising, the front and rear wheels can be switched with each other. A suitable distance for the first change is approx. 5000 km and then at 10000 km intervals. Volvo recommends that you contact an authorised Volvo workshop for checking if you are uncertain about tread depth. If significant differences in wear (>1 mm difference in tread depth) between tyres have already occurred, the least worn tyres must always be placed on the rear. Understeer is normally easier to correct than oversteer, and leads to the car continuing forwards in a straight line rather than having the rear end skidding to one side, resulting in possible complete loss of control over the car. This is why it is important for the rear wheels never to lose grip before the front wheels.

Wheels must be stored lying down or hanging up - never standing up.



WARNING

A damaged tyre may lead to loss of control over the car.



Related information

- Tyres - dimensions (p. 316)
- Tyres - speed ratings (p. 317)
- Tyres - direction of rotation (p. 314)

Tyres - direction of rotation

Tyres with a tread pattern which are designed to only turn in one direction have the direction of rotation marked with an arrow.

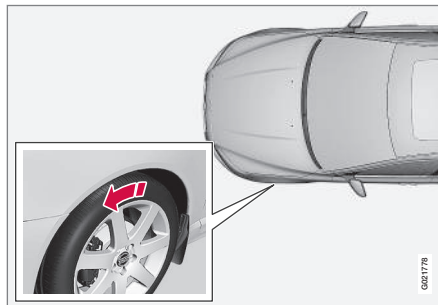

The arrow shows the tyre's direction of rotation.

The tyre must always rotate in the same direction throughout its lifespan. Tyres should only be switched between front and rear positions, never between left and right-hand sides, or vice versa. If the tyres are fitted incorrectly, the car's braking characteristics and capacity to force rain and slush out of the way are adversely affected. Tyres with the greatest tread depth should always be fitted to the rear of the car (to decrease the risk of skidding).



NOTE

Make sure that both pairs of wheels have the same type and dimension, and also the same make.

Follow the recommended tyre pressure (p. 315) specified in the tyre pressure table.

Related information

- Tyres - dimensions (p. 316)
- Tyres - speed ratings (p. 317)
- Tyres - maintenance (p. 313)
- Tyres - tread wear indicators (p. 315)



Tyres - tread wear indicators

A tread wear indicator shows the status of the tyre's tread.

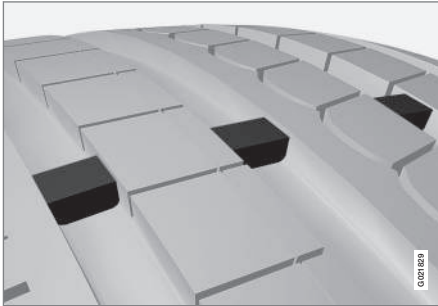

Tread wear indicators.

Tread wear indicators are narrow treadless bands across the width of the tread. On the side of the tyre are the letters TWI (Tread Wear Indicator). When the tyre's tread depth is down to 1.6 mm, the tread depth will be level in height with the tread wear indicators. Change to new tyres as soon as possible. Remember that tyres with little tread depth provide very poor grip in rain and snow.

Related information

- Tyres - speed ratings (p. 317)
- Tyres - air pressure (p. 315)
- Tyres - direction of rotation (p. 314)

Tyres - air pressure

Tyres can have different air pressures which are measured in bar.

Check the air pressure in the tyres

The air pressure for the tyres should be checked every month and should be checked on cold tyres. "Cold tyres" means the tyres are the same temperature as the ambient temperature. After several few kilometres of driving, the tyres warm up and the pressure increases. Inadequate tyre pressure increases fuel consumption, shortens tyre lifespan and impairs the car's roadholding. Driving on tyres with tyre pressure that is too low could result in the tyres overheating and being damaged. Tyre pressure affects travelling comfort, road noise and steering characteristics.

i NOTE

Tyre pressure decreases over time, this is a natural phenomenon. Tyre pressure also varies depending on ambient temperature.

Tyre pressure label



The tyre pressure label on the driver's side door pillar (between frame and rear door) shows which pressure the tyres should have at different loads and speed conditions. This is also specified in the tyre pressure table.

Tyre pressure for the car's recommended tyre dimension and information about ECO pressure that results in improved fuel economy can be found in the printed owner's manual.

i NOTE

Temperature differences change the tyre pressure.

Fuel economy, ECO pressure

In order to obtain optimum fuel economy at speeds below 160 km/h an ECO pressure is recommended (applies to both full and light



load - see the tyre pressure in the printed owner's manual).

Related information

- Tyres - speed ratings (p. 317)
- Tyres - direction of rotation (p. 314)
- Tyres - maintenance (p. 313)
- Tyres - tread wear indicators (p. 315)

Wheel and wheel rim dimensions

Wheel and rim dimensions are designated in accordance with the examples in the table below.

The car has an approval for the complete vehicle. This means that there are certain combinations of wheels and tyres that are approved.

Wheels (rims) have a designation of dimensions, for example: 7Jx16x50.

7	Rim width in inches
J	Rim flange profile
16	Rim diameter in inches
50	Off-set in mm (distance from wheel centre to wheel contact surface against the hub)

Related information

- Wheel nuts (p. 318)

Tyres - dimensions

The car's wheels, tyres and rims have a certain dimension, see the examples in the table below.

The car has an approval for the complete vehicle. This means that there are certain combinations of wheels and tyres that are approved.

The dimensions are stated on all car tyres. Example of designation: 215/55R16 97W.

205	Tyre width (mm)
50	Ratio between tyre wall height and tyre width (%)
R	Radial ply
17	Rim diameter in inches (")
93	Codes for the maximum permitted tyre load, load index (p. 317) (LI)
W	Speed rating for maximum permitted speed, speed rating (p. 317) (SS). (In this case 270 km/h).

Related information

- Tyres - air pressure (p. 315)
- Tyres - direction of rotation (p. 314)
- Tyres - tread wear indicators (p. 315)



Tyres - load index

Load index indicates a tyre's ability to carry a certain load.

Each tyre has a certain capacity to carry a load, a load index (LI). The car's weight determines the load capacity required of the tyres.

Related information

- Tyres - dimensions (p. 316)
- Tyres - speed ratings (p. 317)
- Tyres - air pressure (p. 315)
- Tyres - tread wear indicators (p. 315)

Tyres - speed ratings

Each tyre can withstand a certain maximum speed and therefore belongs to a particular speed rating (SS - Speed Symbol).

Tyre speed class must at least correspond with the car's top speed. Minimum speed rating is indicated in the speed rating table below. The only exception to these conditions is winter tyres (p. 318) (both those with metal studs and those without), where a lower speed rating may be used. If such a tyre is chosen, the car must not be driven faster than the speed rating of the tyre (for example, class Q can be driven at a maximum of 160 km/h). Traffic regulations determine how fast a car can be driven, not the speed rating of the tyres.

NOTE

The maximum permitted speed is specified in the table.

Q	160 km/h (used only on winter tyres)
T	190 km/h
H	210 km/h
V	240 km/h
W	270 km/h
Y	300 km/h



WARNING

The car must be fitted with tyres which have the same or a higher load index (p. 317) (LI) and speed rating (SS) than specified. If a tyre with too low a load index or speed rating is used, it may over-heat.

Related information

- Tyres - dimensions (p. 316)
- Tyres - air pressure (p. 315)
- Tyres - direction of rotation (p. 314)



Wheel nuts

Wheel nuts are used to fasten the wheels at the hubs and are available in different versions.

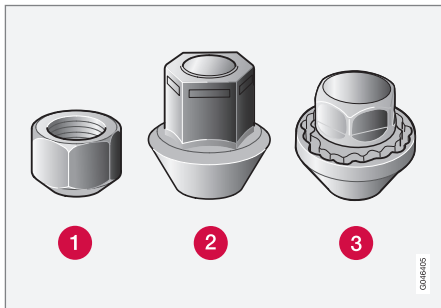

- 1 Standard wheel nuts
- 2 Bulge acorn wheel nuts
- 3 Locking wheel nuts

Tightening torque

- **Type 1 wheel nut (steel wheel rim):** 110 Nm
- **Type 2 wheel nut (aluminium wheel rim):** 130 Nm
- **Type 3 Lockable wheel nut (steel/aluminium wheel rim):** 110 Nm

Only use rims that are tested and approved by Volvo and which are Volvo genuine accessories. Check the torque with a torque wrench.

Locking wheel nuts*

Locking wheel nuts can be used on both aluminium and steel rims. Under the cargo area floor there is space for the sleeve for the lockable wheel nuts.

Related information

- Wheel and wheel rim dimensions (p. 316)

Winter tyres

Winter tyres are tyres that are adapted for winter road conditions.

Winter tyres

Volvo recommends winter tyres with particular dimensions. Tyre dimensions are dependent on engine variant. When driving on winter tyres, the correct type of tyres must be fitted to all four wheels.



NOTE

Volvo recommends that you consult a Volvo dealer about which wheel rim and tyre types are most suitable.

Studded tyres

Studded winter tyres should be run in gently for 500-1000 km so the studs settle properly into the tyres. This gives the tyre, and especially the studs, a longer service life.



NOTE

The legal provisions for the use of studded tyres vary from country to country.

Tread depth

Road conditions with ice, slush and low temperatures place considerably higher demands on tyres than summer conditions. Volvo therefore recommends not to drive on winter tyres that have a tread depth of less than 4 mm.



Using snow chains

Snow chains may only be used on the front wheels (also applies to all-wheel drive cars). Never drive faster than 50 km/h with snow chains. Avoid driving on bare ground as this wears out both the snow chains and tyres.

WARNING

Use Volvo genuine snow chains or equivalent chains designed for the car model, and tyre and rim dimensions. In the event of uncertainty Volvo recommends that you consult an authorised Volvo workshop. The wrong snow chains may cause serious damage to your car and lead to an accident.

Related information

- Changing wheels - removing wheels (p. 320)

Spare wheel*

A spare wheel (Temporary spare) is used to temporarily replace a punctured normal wheel.

A spare wheel is only intended for use temporarily and must be replaced by a normal wheel as soon as possible. The car's handling may be altered by the use of a spare wheel. The spare wheel is smaller than the normal wheel. The car's ground clearance is affected accordingly. Pay attention to high kerbs and do not machine wash the car. If the spare wheel is fitted on the front axle, you cannot use snow chains at the same time. On all-wheel drive cars the drive on the rear axle can be disconnected. The spare wheel must not be repaired. The correct tyre pressure for the spare wheel is stated in the tyre pressure table, Tyres - air pressure (p. 315).

IMPORTANT

- Never drive faster than 80 km/h with a spare wheel on the car.
- The car must never be driven fitted with more than one "Temporary Spare" wheel.

Related information

- Changing wheels - removing wheels (p. 320)
- Changing wheels - fitting the spare wheel* (p. 322)

- Changing wheels - taking out the spare wheel* (p. 320)
- Jack (p. 325)
- Warning triangle (p. 324)
- Wheel nuts (p. 318)



Changing wheels - taking out the spare wheel*

The spare wheel* plus jack* and wheel wrench* are stored under the floor in the cargo area.

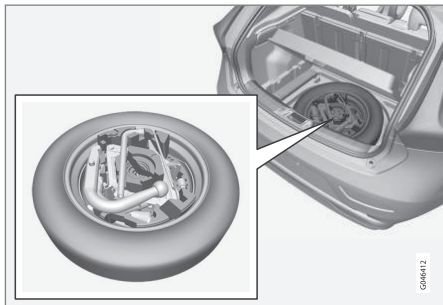

1. Lift the rear edge of the luggage compartment floor (or on models with a jointed luggage compartment floor, take hold of the luggage compartment floor handle, lift and move the rear part of the floor forwards).
2. Lift out the storage compartment* (only models with a jointed cargo area floor).
3. Lift out the lower floor (models with a jointed luggage compartment floor only).
4. Undo the attaching screw and lift out the foam block containing the jack and tools.

5. Take hold of the far end of the spare wheel, then lift. Push the spare wheel forwards slightly and lift it out of the storage compartment.
6. Remove the wheel wrench, the jack and the towing eye from the foam block.

i NOTE

The jack must be lifted out in order to access the towing eye.

Related information

- Changing wheels - removing wheels (p. 320)
- Changing wheels - fitting the spare wheel* (p. 322)
- Jack (p. 325)
- Spare wheel* (p. 319)
- Warning triangle (p. 324)
- Wheel nuts (p. 318)

Changing wheels - removing wheels

The car's wheels can be changed for e.g. winter wheels/winter tyres.

Set up the warning triangle if a wheel must be changed in a trafficked location. The car and jack* must be on a firm horizontal surface.

1. Apply the parking brake and engage reverse gear, or position **P** if the car has an automatic gearbox.

! WARNING

Check that the jack is not damaged, that the threads are thoroughly lubricated and that it is free from dirt.

i NOTE

Volvo recommends only using the jack* that belongs to the car model in question, which is indicated on the jack's label.

The decal also indicates the jack's maximum lift capacity at a specified lifting height.

2. Take out the wheel to be fitted (summer tyre, winter tyre or spare wheel) as well as the tools. If it is a spare wheel being fitted then there is a package in its location containing gloves and a plastic bag for the punctured wheel.



3. Place chocks in front of and behind the wheels which will remain on the ground to prevent them from rolling. Use heavy wooden blocks or large stones for example.
4. Cars with steel rims have removable wheel covers. Use the removal tool to hook in and pull off any full-wheel wheel covers. Alternatively, the wheel covers can be pulled away by hand.

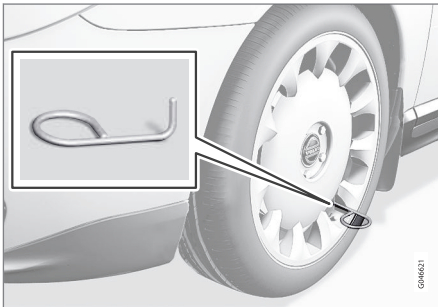

5. Screw together the towing eye with the wheel wrench* until the stop position as shown in the following illustration.

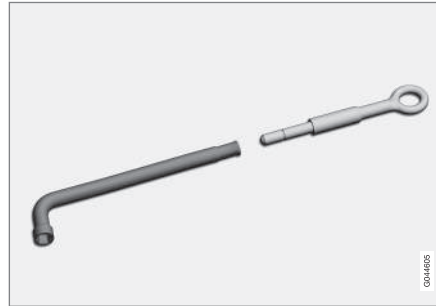

The wheel wrench and towing eye.

! IMPORTANT

The towing eye must be screwed into all threads in the wheel bolt wrench.

6. Remove the plastic caps from the wheel nuts with the intended tool.



7. Loosen the wheel nuts $\frac{1}{2}$ -1 turn anti-clockwise with the wheel wrench.



WARNING

Never position anything between the ground and the jack, nor between the jack and the car's jacking point.

8. There are two jacking points on each side of the car.

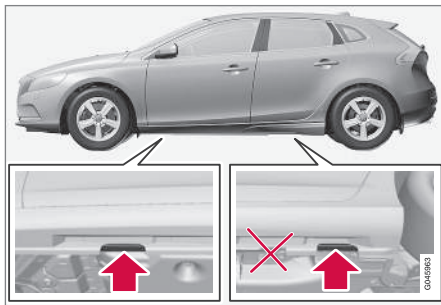

IMPORTANT

The ground under the jack must be firm, smooth and level.

9. Wind up the jack so that the flange in the bodywork ends up in the notch in the head of the jack.
10. Lift the car so that the wheel is free. Remove the wheel nuts and lift off the wheel.

WARNING

Never crawl under the car when it is raised on the jack.

Passengers must leave the car when it is raised on the jack. If a wheel must be changed in a trafficked environment, passengers must stand in a safe place.

NOTE

The car's regular jack is designed only for use occasionally and for a short time, such as when changing a wheel with a punctured tyre, switching between summer tyres and winter tyres, etc. Only the jack belonging to the specific model is to be used to jack up the car. If the car is to be jacked up more often, or for a longer time than is required just to change a wheel, use of a garage jack is recommended. In this instance, follow the instructions for use that come with the equipment.

Related information

- Changing wheels - fitting the spare wheel* (p. 322)
- Changing wheels - taking out the spare wheel* (p. 320)
- Spare wheel* (p. 319)
- Warning triangle (p. 324)
- Wheel nuts (p. 318)

Changing wheels - fitting the spare wheel*

It is important that the procedure for fitting the spare wheel is carried out correctly.

Fitting

1. Clean the contact surfaces between wheel and hub.
2. Put on the wheel. Tighten the wheel nuts thoroughly.
3. Lower the car so that the wheels cannot rotate.



4. Tighten the wheel nuts crosswise. It is important that the wheel nuts are tightened with the correct tightening torque. Check the torque with a torque wrench.

5.

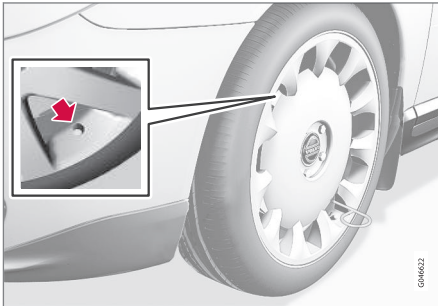

Refit any full wheel covers.

NOTE

The wheel cover outlet for the valve must be positioned over the valve on the wheel rim during fitting.

Putting back the jack* and tools

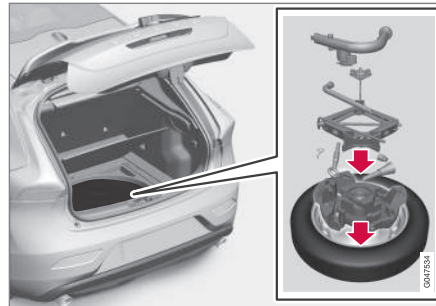

The tools and jack must be returned to their correct places in the foam block after use.

1. Unscrew the towing eye from the wheel bolt wrench.
2. Put any tools used back in their individual compartments in the foam block in the following order:
 - towing eye/funnel/torx wrench/socket for locking wheel nuts/tool for wheel covers
 - jack (must be cranked to the correct height so that it fits into the foam block's compartment, the handle above the foot and down in the groove in the foam block)
 - socket wrench (above the jack).

3. If the spare wheel has been used, then the punctured wheel can be placed in the plastic bag contained in the package with the gloves. Place the foam block back in the storage compartment and tighten the mounting screw to the floor of the storage compartment.

If the spare wheel has **not** been used, place the foam block in the spare wheel and place the spare wheel back in the storage compartment. Tighten the attaching screw to the floor of the storage compartment.

4. Return the detachable towbar.

NOTE

- After a tyre has been inflated, always refit the dust cap in order to avoid damage to the valve from gravel, dirt, etc.
- Only use plastic dust caps. Metal dust caps can rust and become difficult to unscrew.

IMPORTANT

The tools and jack* must be stored in the intended location in the car's cargo area when not in use.



Related information

- Changing wheels - taking out the spare wheel* (p. 320)
- Changing wheels - removing wheels (p. 320)
- Spare wheel* (p. 319)
- Warning triangle (p. 324)
- Wheel nuts (p. 318)

Warning triangle

The warning triangle is used to warn other road users of a stationary vehicle.

Storage and folding up

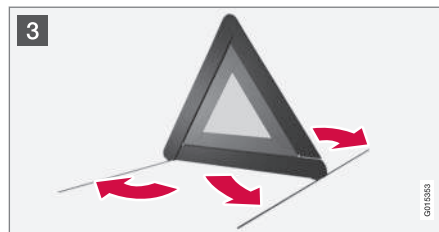
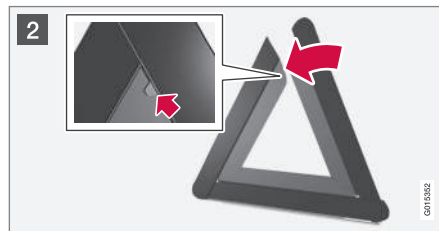

- 1 Lift the floor hatch (or push the rear part of the luggage compartment floor forwards in models with a jointed floor and then lift the lower floor) and remove the warning triangle.
- 2 Take the warning triangle from the case, fold out and assemble the two loose sides.
- 3 Fold out the warning triangle's support legs.

Follow the regulations for the use of a warning triangle. Position the warning triangle in a suitable place with regard to traffic.

Ensure the warning triangle and its case are properly secured in the cargo area after use.

Related information

- Spare wheel* (p. 319)

Jack

A jack is used to raise the car, e.g. when changing the tyres.

The original jack should only be used for changing to the spare wheel. The jack's thread must always be well greased.

Related information

- Warning triangle (p. 324)
- Emergency puncture repair* (p. 333)

First aid kit*

The first aid box contains first aid equipment.



A case containing first aid equipment is located on the left-hand side of the cargo area.

Tyre pressure monitoring*¹

Tyre pressure monitoring warns the driver when the pressure is too low in one or more of the car's tyres. For certain markets the tyre pressure monitoring is standard in accordance with legal requirements.

There are two systems for tyre pressure monitoring, TPMS (Tyre Pressure Monitoring System) and TM (Tyre Monitor). In the event of uncertainty about which system the car has, open the menu system **MY CAR** and search for the car's settings:

- The **Tyre pressure** menu is used if it is TPMS, see Tyre pressure monitoring system (TPMS)* - general (p. 326).
- The **Tyre monitoring** menu is used if it is TM, see Tyre pressure monitoring (TM)* (p. 331).

The system does not replace normal tyre maintenance.



IMPORTANT

If a fault occurs in the TPMS system the warning lamp  in the combined instrument panel will flash for approx. 1 minute and then illuminate with a constant glow. A message is also shown in the combined instrument panel.

¹ Standard in certain markets.



Related information

- Tyre pressure monitoring system (TPMS)* - general (p. 326)
- Tyre pressure monitoring (TPMS)* - adjust (recalibration) (p. 327)
- Tyre pressure monitoring (TPMS)* - rectifying low tyre pressure (p. 330)
- Tyre pressure monitoring (TPMS)* - activate/deactivate (p. 329)
- Tyre pressure monitoring (TPMS)* - recommendations (p. 329)
- Tyre pressure monitoring (TPMS)* - drive-able punctured tyres* (p. 330)
- Tyre pressure monitoring system (TPMS)* - status (p. 328)

Tyre pressure monitoring system (TPMS)*⁹ - general

Tyre pressure monitoring (TPMS) (Tyre Pressure Monitoring System) warns the driver when the pressure is too low in one or more of the car's tyres.*

Tyre pressure monitoring uses sensors located inside the air valve in each wheel. When the car is driven at about 30 km/h the system detects the tyre pressure. If the pressure is too low then a warning lamp  illuminates in the combined instrument panel and one of the following messages is shown:

- **Tyre pressure low Check front right tyre**
- **Tyre pressure low Check front left tyre**
- **Tyre pressure low Check rear right tyre**
- **Tyre pressure low Check rear left tyre**
- **Tyre needs air now Check front right tyre**
- **Tyre needs air now Check front left tyre**
- **Tyre needs air now Check rear right tyre**
- **Tyre needs air now Check rear left tyre**

- **Tyre pressure system Service required**

If wheels without TPMS sensors are used or if a sensor has failed then **Tyre pressure system Service required** will be shown.

Always check the system after changing a wheel in order to ensure that replacement wheels work with the system.

For information on the correct tyre pressure, see Tyres - air pressure (p. 315).

The system does not replace normal tyre maintenance.



IMPORTANT

If a fault occurs in the TPMS system the warning lamp  in the combined instrument panel will flash for approx. 1 minute and then illuminate with a constant glow. A message is also shown in the combined instrument panel.

Related information

- Tyre pressure monitoring (TPMS)* - adjust (recalibration) (p. 327)
- Tyre pressure monitoring (TPMS)* - rectifying low tyre pressure (p. 330)
- Tyre pressure monitoring (TPMS)* - activate/deactivate (p. 329)

⁹ Standard in certain markets.



- Tyre pressure monitoring (TPMS)* - recommendations (p. 329)
- Tyre pressure monitoring (TPMS)* - drive-able punctured tyres* (p. 330)
- Tyre pressure monitoring system (TPMS)* - status (p. 328)

Tyre pressure monitoring (TPMS)*¹⁶ - adjust (recalibration)

Tyre pressure monitoring (TPMS) (Tyre Pressure Monitoring System) warns the driver when the pressure is too low in one or more of the car's tyres.*

TPMS can be adjusted in order to follow Volvo's tyre pressure recommendations (p. 315), when driving with a heavy load for example.

NOTE

The car must be stationary when calibration is started.

The settings are made with the control in the centre console, see MY CAR (p. 108).

1. Inflate the tyres to the desired pressure in accordance with the tyre pressure label on the driver's side door pillar (between front and rear doors).
2. Start the engine.
3. Select the menu system **MY CAR** to open the menus for tyre pressure.
4. Select **Calibrate tyre pressure** and press **OK**.

5. Drive for at least 10 minutes at a speed of at least 30 km/h.
 - > Calibration is performed automatically following initialisation by the driver. The system provides no confirmation when the calibration is complete.

Related information

- Tyre pressure monitoring* (p. 325)
- Tyres - air pressure (p. 315)

¹⁶ Standard in certain markets.



Tyre pressure monitoring system (TPMS)*¹⁸ - status

Tyre pressure monitoring (TPMS) (Tyre Pressure Monitoring System) warns the driver when the pressure is too low in one or more of the car's tyres.*

System and tyre status

The current status of the system and the tyres can be checked, see MY CAR (p. 108).

1. Select the menu system **MY CAR** to open the menus for tyre monitoring.
2. Select **Tyre pressure**.

The status is colour-coded for each tyre in accordance with the following:

- All-green: the system is operating normally and the tyre pressure in all tyres is slightly above the recommended level.
- Yellow wheel: corresponding tyre's pressure is too low.
- Red wheel: corresponding tyre's pressure is very low.
- All wheels grey: the system is temporarily unavailable. It may be necessary to drive the car for a few minutes at a speed above 30 km/h before the system becomes active again.
- All wheels grey and the message **Tyre pressure system Service required**: an

error has occurred in the system. Contact a Volvo dealer or workshop.

Clearing warning messages

If a tyre pressure message has been shown and the TPMS warning lamp has been illuminated:

1. Check the tyre pressure on the indicated tyre/tyres with a tyre pressure gauge.
2. Inflate the tyre/tyres to the correct pressure in accordance with the tyre pressure label on the driver's side door pillar (between front and rear doors).
3. In some cases it may be necessary to drive the car for a few minutes at a speed above 30 km/h in order to clear the warning text. At which point, the TPMS warning lamp is extinguished as well.



NOTE

- The TPMS system uses a so-called compensated pressure value, based on both tyre temperature and ambient temperature. This means that the tyre pressure may differ slightly from the recommended pressures listed on the tyre pressure label on the driver's side door pillar (between front and rear doors). For this reason, it may be necessary to inflate the tyres to a slightly higher pressure in order to clear a low tyre pressure message.
- To avoid incorrect tyre pressure, the pressure should be checked on cold tyres. "Cold tyres" means the tyres are the same temperature as the ambient temperature (approx. 3 hours after the car has been driven). After a few kilometres of driving, the tyres warm up and the pressure increases.



WARNING

- Incorrect tyre pressure may lead to tyre failure, which could result in the driver losing control of the car.
- The system cannot indicate sudden tyre damage in advance.

Related information

- Tyre pressure monitoring* (p. 325)

¹⁸ Standard in certain markets.

* Option/accessory, for more information, see Introduction.



Tyre pressure monitoring (TPMS)*²⁰ - activate/deactivate

Tyre pressure monitoring (TPMS) (Tyre Pressure Monitoring System) warns the driver when the pressure is too low in one or more of the car's tyres.*

NOTE

The car must be stationary when the tyre pressure monitoring is activated/deactivated.

Settings are made using the centre console's controls, see MY CAR (p. 108).

1. Start the engine.
2. Select the system **MY CAR** to open the menus for tyre pressure.
3. Select **Tyre pressure** and press **OK**.
 - > An **X** is shown in the information display if the system is activated, the option disappears if the system is deactivated²¹.

Related information

- Tyre pressure monitoring* (p. 325)

²⁰ Standard in certain markets.

²¹ Only in certain markets.

²³ Standard in certain markets.

Tyre pressure monitoring (TPMS)*²³ - recommendations

Tyre pressure monitoring (TPMS) (Tyre Pressure Monitoring System) warns the driver when the pressure is too low in one or more of the car's tyres.*

- Volvo recommends that TPMS sensors are fitted to all wheels on the car, including winter wheels.
- Volvo recommends that sensors are not moved between different wheels.
- The spare wheel is not equipped with a TPMS sensor.
- If the spare wheel or a wheel without a TPMS sensor is used, the error message **Tyre pressure system Service required** will be shown in the combined instrument panel.
- If a wheel has been changed, or if the TPMS sensor has been moved to another wheel then the seal, nut and valve core must be replaced.
- When TPMS sensors are installed, the car should be switched off for at least 15 minutes otherwise an error message will be shown in the combined instrument panel.

WARNING

When inflating a tyre equipped with TPMS, hold the nozzle of the pump directly against the valve to avoid damaging the valve.

NOTE

- After a tyre has been inflated, always refit the dust cap in order to avoid damage to the valve from gravel, dirt, etc.
- Only use plastic dust caps. Metal dust caps can rust and become difficult to unscrew.

NOTE

If you want to change the tyre dimension then the TPMS system must be reconfigured. For further information - contact a Volvo dealer.

Related information

- Tyre pressure monitoring* (p. 325)



Tyre pressure monitoring (TPMS)*²⁵ - driveable punctured tyres*

If SST (Self Supporting run flat Tyres)* is selected, the car is also equipped with TPMS (p. 325).

This type of tyre has a specially reinforced side wall that makes continued driving possible to a limited extent despite the tyre losing all or some of its pressure. These tyres are fitted on a special rim. (Normal tyres can also be fitted to this rim.)

If an SST tyre loses tyre pressure then the yellow TPMS lamp in the combined instrument panel illuminates and a message is shown in the information display. If this occurs, reduce speed to max. 80 km/h. The tyre must be replaced as soon as possible.

Drive carefully, in some cases it can be difficult to see which tyre is faulty. In order to establish which tyre needs attention, check all four tyres.



WARNING

Only people with knowledge of SST tyres should fit them.

SST tyres must only be fitted together with TPMS.

After an error message about low tyre pressure has been shown, do not drive faster than 80 km/h.

Maximum mileage before tyre replacement is 80 km.

Avoid hard driving such as sudden braking or turning.

SST tyres must be replaced if they are damaged or punctured.

Related information

- Tyre pressure monitoring* (p. 325)

Tyre pressure monitoring (TPMS)*²⁷ - rectifying low tyre pressure

The tyre pressure monitoring system TPMS (Tyre Pressure Monitoring System)²⁸ warns the driver when the pressure is too low in one or more of the car's tyres and indicates the tyre to which it applies. The lamp illuminates in yellow at the first indication, stop and check the tyre pressure as soon as possible. When the lamp illuminates in red you must stop and rectify the tyre pressure immediately.

If a message for low tyre pressure is shown in the display:

1. Check the tyre pressure on the tyre in question.
2. Inflate the tyre(s) to the correct pressure.
3. Drive at least at 30 km/h for several minutes and check that the message disappears.

Related information

- Tyre pressure monitoring* (p. 325)

²⁵ Standard in certain markets.

²⁷ Standard in certain markets.

²⁸ Option only in certain markets.



Tyre pressure monitoring (TM)*³⁰

The TM (Tyre Monitor) system senses tyre rotation speed in order to determine whether the tyres have the correct tyre pressure. If the pressure is too low, the tyre's diameter is changed and, as a result, so is the rotation speed. By comparing the tyres with each other the system can determine whether one or more tyres have pressure that is too low.

Messages

If the tyre pressure is too low then a warning lamp (⚠) illuminates in the combined instrument panel and one of the following messages is shown:

- Tyre pressure low Check front right tyre
- Tyre pressure low Check front left tyre
- Tyre pressure low Check rear right tyre
- Tyre pressure low Check rear left tyre
- Tyre pressure low Check tyres
- Tyre pressure system Service required



IMPORTANT

If a fault occurs in the TM system the warning lamp (⚠) in the combined instrument panel will flash for approx. 1 minute and then illuminate with a constant glow. A message is also shown in the combined instrument panel.

The system does not replace normal tyre maintenance.

TM recalibration

In order for TM to work correctly, a reference value for the tyre pressure must be determined. This must be performed each time the tyres are changed or the tyre pressure is changed.

Recalibration

Settings are made using the centre console's controls, see MY CAR (p. 108).

1. Switch off the ignition.
2. Inflate the tyres to the desired pressure in accordance with the tyre pressure label on the driver's side door pillar (between front and rear doors) and select key position II, see Key positions (p. 75).
3. Select the menu system **MY CAR** to open the menus for tyre pressure.

4. Select **Calibrate tyre pressure** and press **OK**.
5. Start and drive the car.
 - > Recalibration is carried out while the car is being driven and can be interrupted at any time. If the engine is switched off while recalibration is in progress then it is resumed when the car is driven again.

TM is then recalibrated and the new reference value applies until steps 1-5 are carried out again.



NOTE

Remember that the TM system must be recalibrated at each tyre change or if the tyre pressure is changed. If new reference values are not stored then the system cannot function properly.



NOTE

- After a tyre has been inflated, always refit the dust cap in order to avoid damage to the valve from gravel, dirt, etc.
- Only use plastic dust caps. Metal dust caps can rust and become difficult to unscrew.

³⁰ Standard in certain markets.



System and tyre status

The current status of the system and the tyres can be checked, see MY CAR (p. 108).

1. Select the menu system **MY CAR** to open the menus for tyre monitoring.
2. Select **Tyre monitoring**.

The status is colour-coded for each tyre in accordance with the following:

- All-green: the system is operating normally and the tyre pressure in all tyres is slightly above the recommended level.
- Yellow wheel: corresponding tyre's pressure is too low.
- All wheels yellow: two or more tyres have pressure that is too low.
- All wheels grey: the system is temporarily unavailable. It may be necessary to drive the car for a few minutes at a speed above 30 km/h before the system becomes active again.
- All wheels grey and the message **Tyre pressure system Service required**: an error has occurred in the system. Contact a Volvo dealer or workshop.

Clearing warning messages

If a tyre pressure message has been shown and the TPI warning lamp has been illuminated:

1. Check the tyre pressure on the indicated tyre/tyres with a tyre pressure gauge.
2. Inflate the tyre/tyres to the correct pressure in accordance with the tyre pressure label on the driver's side door pillar (between front and rear doors).
3. Recalibrate the TM system.



NOTE

- The TM system uses a so-called compensated pressure value, based on both tyre temperature and ambient temperature. This means that the tyre pressure may differ slightly from the recommended pressures listed on the tyre pressure label on the driver's side door pillar (between front and rear doors). For this reason, it may be necessary to inflate the tyres to a slightly higher pressure in order to clear a low tyre pressure message.
- To avoid incorrect tyre pressure, the pressure should be checked on cold tyres. "Cold tyres" means the tyres are the same temperature as the ambient temperature (approx. 3 hours after the car has been driven). After a few kilometres of driving, the tyres warm up and the pressure increases.



WARNING

- Incorrect tyre pressure may lead to tyre failure, which could result in the driver losing control of the car.
- The system cannot indicate sudden tyre damage in advance.



Emergency puncture repair*

The emergency puncture repair kit* (TMK - Temporary Mobility Kit) is used to seal a puncture and check and adjust the air pressure. Air pressure for the car's recommended tyre dimensions can be found in the printed owner's manual.

The emergency puncture repair kit consists of a compressor and a bottle of sealant. The sealing works as a temporary repair. The sealing fluid bottle must be replaced before its expiration date and after use. The sealing fluid effectively seals tyres punctured in the tread.

i NOTE

The emergency puncture repair kit is only intended for sealing tyres with a puncture in the tread.

The emergency puncture repair kit has limited capacity to seal tyres which have punctures in the wall. Do not seal tyres with the emergency puncture repair kit if they have larger slits, cracks or similar damage. Connect the compressor to one of the car's 12 V sockets. Choose the socket that is nearest to the punctured tyre.

i NOTE

The compressor for temporary emergency puncture repair has been tested and approved by Volvo.

Related information

- Emergency puncture repair* - operation (p. 335)
- Emergency puncture repair* - rechecking (p. 337)
- Emergency puncture repair kit* - overview (p. 334)

Emergency puncture repair kit* - location

Emergency puncture repair kit (TMK - Temporary Mobility Kit) is used to seal a puncture and check and adjust the air pressure. Air pressure for the car's recommended tyre dimensions can be found in the printed owner's manual.

Location of the emergency puncture repair kit

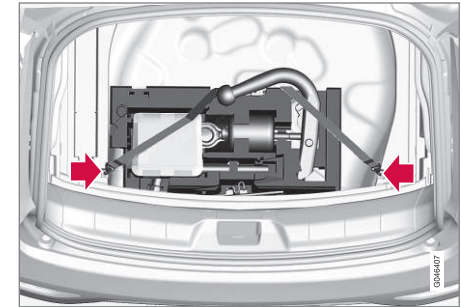

Version 1.

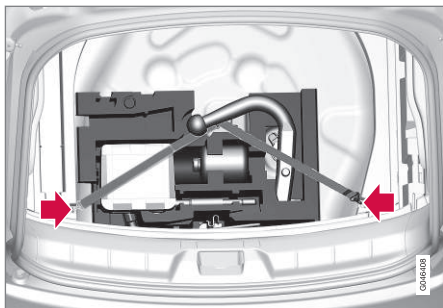

Version 2.

Set up the warning triangle if a tyre is being sealed in a trafficked location. The warning triangle and emergency puncture repair kit are located under the floor in the cargo area.

1. Lift the rear edge of the luggage compartment floor (or on models with a jointed luggage compartment floor, take hold of the luggage compartment floor handle, lift and move the rear part of the floor forwards).
2. Lift out the storage compartment (optional extra) - models with a jointed luggage compartment floor only.
3. Lift out the lower floor (models with a jointed luggage compartment floor only).
4. Unhook the elastic part of the belt over the TMK compressor unit on the left side.

5. Lift the TMK compressor unit straight up.
6. To access the bottle of sealant, it must be pushed to the left until it can be lifted out of the foam block.

i NOTE

To access the towing eye/wheel wrench in the foam block:

- **Version 1:** Lift the emergency puncture repair kit compressor unit (point 5) to access the wheel wrench. Lift out the bottle of sealant (point 6) to access the towing eye.
- **Version 2:** Lift the emergency puncture repair kit compressor unit (point 5) to access the towing eye. The wheel wrench is located underneath the jack.

After use, hook the belt back onto the left side.

Version 1: The belt must be pulled behind the foam block (not above).

Version 2: The belt must be in the fork on the rear part of the foam block.

Related information

- Emergency puncture repair kit* - overview (p. 334)
- Emergency puncture repair kit* - sealant (p. 339)
- Emergency puncture repair* (p. 333)

Emergency puncture repair kit* - overview

Emergency puncture repair kit (TMK - Temporary Mobility Kit) is used to seal a puncture and check and adjust the air pressure. Air pressure for the car's recommended tyre dimensions can be found in the printed owner's manual.

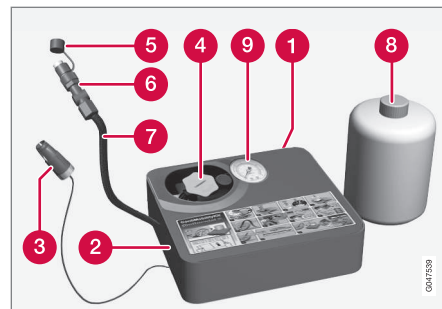

- 1 Label, maximum permitted speed
- 2 Switch
- 3 Cable
- 4 Bottle holder (orange cap)
- 5 Protective cap
- 6 Pressure reducing valve
- 7 Air hose



- 8 Bottle holder with sealant
- 9 Pressure gauge

Related information

- Emergency puncture repair kit* - location (p. 333)
- Emergency puncture repair kit* - sealant (p. 339)
- Emergency puncture repair* (p. 333)
- Emergency puncture repair* - returning components to their places (p. 339)

Emergency puncture repair* - operation

Emergency puncture repair, using the emergency puncture repair kit (TMK - Temporary Mobility Kit) is used to seal a puncture and check and adjust the air pressure.*

The tyre pressure label on the driver side's door pillar (between frame and rear door) shows the tyre pressures for the car's recommended tyre dimensions.

Emergency puncture repair

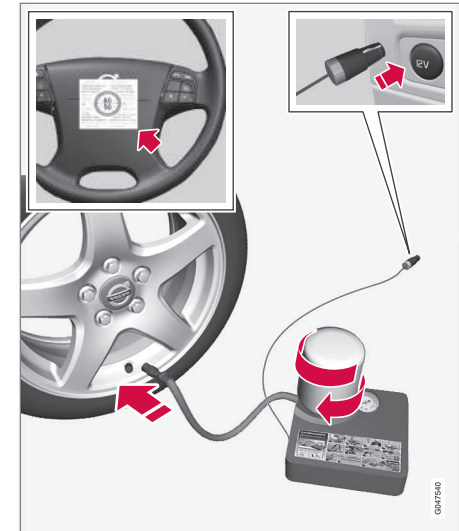

For information on the function of the parts, see Emergency puncture repair kit.

1. Detach the label for maximum permitted speed (which is fitted on one side of the compressor) and affix it to the steering wheel.



09 Wheels and tyres



WARNING

You should not drive faster than 80 km/h after the emergency tyre repair kit has been used. Volvo recommends that you visit an authorised Volvo workshop for inspection of the sealed tyre (maximum driving distance is 200 km). The staff there can determine whether or not the tyre can be repaired or if it needs to be replaced.

WARNING

The sealing fluid can irritate the skin. In the case of contact with skin, wash away the fluid with soap and water.

2. Check that the switch is in position **0** and locate the cable and the air hose.

NOTE

Do not break the bottle's seal before use. The seal is broken automatically when the bottle is screwed in.

3. Unscrew the orange cap and unscrew the bottle's stopper.
4. Screw the bottle into its holder.

WARNING

Do not unscrew the bottle, it is equipped with a reverse catch to prevent leakage.

5. Unscrew the wheel's dust cap and screw in the air hose valve connection to the bottom of the thread on the tyre's air valve.
6. Plug the cable into the 12 V socket and start the car.

WARNING

Do not leave children in the car without supervision when the engine is running.

7. Flick the switch to position **I**.

WARNING

Never stand next to the tyre when the compressor is running. If cracks or unevenness arise then the compressor must be switched off immediately. The journey should not be continued. Contacting an authorised tyre centre is recommended.

NOTE

When the compressor starts, the pressure can increase up to 6 bar but the pressure drops after approximately 30 seconds.

8. Inflate the tyre for 7 minutes.

IMPORTANT

Risk of overheating. The compressor must not run for more than 10 minutes.

9. Switch off the compressor to check the pressure on the pressure gauge. Minimum pressure is 1.8 bar and maximum 3.5 bar. (Release air with the pressure reducing valve if the tyre pressure is too high.)

WARNING

If the pressure is below 1.8 bar then the hole in the tyre is too big. The journey should not be continued. Contacting an authorised tyre centre is recommended.

10. Switch off the compressor and unplug the cable from the 12 V socket.
11. Detach the hose from the tyre valve and fit the valve cap.
12. As soon as possible, drive approximately 3 km at a maximum speed of 80 km/h so that the sealing fluid can seal the tyre.

Related information

- Emergency puncture repair* (p. 333)
- Emergency puncture repair* - rechecking (p. 337)



- Emergency puncture repair kit* - overview (p. 334)
- Emergency puncture repair* - returning components to their places (p. 339)

Emergency puncture repair* - rechecking

Emergency puncture repair (p. 333), in which the emergency puncture repair kit (p. 334) (TMK - Temporary Mobility Kit), is used to seal a puncture and check and adjust the air pressure.*

Check tyre pressure

1. Connect the tyre sealing equipment again.
2. Read the tyre pressure on the pressure gauge.
 - If it is below 1.3 bar then the tyre is insufficiently sealed. The journey should not be continued. Contact a tyre centre.
 - If the tyre pressure is higher than 1.3 bar, the tyre must be inflated to the tyre pressure specified in accordance with the tyre pressure table found in the printed owner's manual (1 bar = 100 kPa). Release air using the pressure reducing valve if the tyre pressure is too high.



WARNING

Do not unscrew the bottle, it is equipped with a reverse catch to prevent leakage.

3. Make sure the compressor is switched off. Detach the air hose and cable. Refit the dust cap.
4. Fold the hose into the box and leave the bottle where it is. Place TMK in the cargo area.



NOTE

- After a tyre has been inflated, always refit the dust cap in order to avoid damage to the valve from gravel, dirt, etc.
- Only use plastic dust caps. Metal dust caps can rust and become difficult to unscrew.



NOTE

The sealing fluid bottle and the hose must be replaced after use. Volvo recommends that this replacement is performed by an authorised Volvo workshop.



WARNING

Check the tyre pressure regularly.



09 Wheels and tyres



Volvo recommends that you drive to the nearest authorised Volvo workshop for the replacement/repair of the damaged tyre. Advise the workshop that the tyre contains sealing fluid.

WARNING

You should not drive faster than 80 km/h after the emergency tyre repair kit has been used. Volvo recommends that you visit an authorised Volvo workshop for inspection of the sealed tyre (maximum driving distance is 200 km). The staff there can determine whether or not the tyre can be repaired or if it needs to be replaced.

Related information

- Emergency puncture repair* - operation (p. 335)
- Emergency puncture repair* - returning components to their places (p. 339)

Inflating tyres with the emergency puncture repair kit*

The car's original tyres can be inflated using the compressor in the emergency puncture repair kit.

1. The compressor must be switched off. Make sure that the switch is in position **0** and locate the cable and air hose.
2. Unscrew the wheel's dust cap and screw in the air hose valve connection to the bottom of the thread on the tyre's air valve.

WARNING

Inhaling car exhaust fumes could result in danger to life. Never leave the engine running in sealed areas or areas that lack sufficient ventilation.

WARNING

Do not leave children in the car without supervision when the engine is running.

3. Connect the cable to one of the car's 12 V sockets and start the car.
4. Start the compressor by flicking the switch to position **I**.



IMPORTANT

Risk of overheating. The compressor must not run for more than 10 minutes.

5. Inflate the tyre to the pressure specified in accordance with the tyre pressure table that is found in the printed owner's manual. (Release air using the pressure reducing valve if the tyre pressure is too high.)
6. Switch off the compressor. Detach the air hose and cable.
7. Refit the dust cap.

Related information

- Emergency puncture repair* (p. 333)
- Emergency puncture repair kit* - overview (p. 334)

Emergency puncture repair* - returning components to their places

After using the puncture repair kit, the components should be placed back into the foam block.

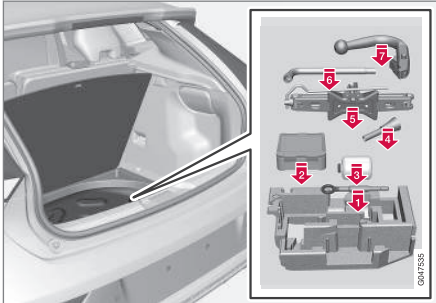

Version 1.

The components are fitted in the foam block in the following order:

1. Towing eye/socket wrench
2. Bottle (pressed in from the side)
3. TMK kit
4. Funnel
5. Jack
6. Torx wrench
7. Towbar

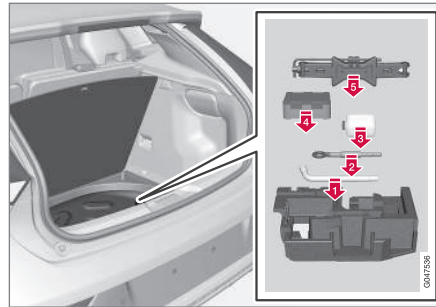

Version 2.

The components are fitted in the foam block in the following order:

1. Socket wrench
2. Towing eye
3. Bottle
4. TMK kit
5. Jack

Related information

- Emergency puncture repair* (p. 333)
- Emergency puncture repair* - operation (p. 335)
- Emergency puncture repair* - rechecking (p. 337)
- Emergency puncture repair kit* - overview (p. 334)

Emergency puncture repair kit* - sealant

The container (bottle) with the emergency puncture repair kit (p. 334) contains sealant and it can be replaced.

Replace the bottle when the expiration date has passed. Treat the old bottle as environmentally hazardous waste.

WARNING

The bottle contains 1.2-Ethanol and natural rubber-latex.

Harmful if ingested. Could result in allergic reaction in the event of skin contact.

Avoid contact with the skin and eyes.

Store out of the reach of children.

Related information

- Emergency puncture repair* (p. 333)
- Emergency puncture repair kit* - location (p. 333)



Type approval - tyre pressure monitoring (TPMS)

Type approval of the sensors in tyre pressure monitoring - TPMS (Tyre Pressure Monitoring System) can be read in the table.*



Country/Area		
Brazil		
Ukraine		



09 Wheels and tyres





09



Country/Area	
Israel	<div data-bbox="497 184 938 490" style="border: 1px solid black; padding: 10px;"><p data-bbox="587 202 849 225">שם הדגם (Hebrew: Model name)</p><p data-bbox="655 238 780 260">S180052050</p><p data-bbox="507 286 930 309">שם היצרן וכתובתו (Hebrew: Manufacturer and address)</p><p data-bbox="627 331 810 409">Continental AG Siemensstraße 12 93055 Regensburg</p><p data-bbox="906 434 919 471" style="writing-mode: vertical-rl; transform: rotate(180deg);">0051154</p></div>



Declaration of Conformity (Declaration of Conformity)

Country/ Area									
Countries in the EU:	<div style="text-align: center;">  </div> <p>Exporting country: Germany Manufacturer: Continental Automotive GmbH Type of equipment: TPMS unit</p> <div style="border: 1px solid black; padding: 5px; margin-top: 10px;">  <p style="font-size: small;">Joseph Lohr 185 PG3 C/F/F 100 Phone: +49 (0)41 750-3342 Fax: +49 (0)41 750-3342 j.lohr@continental-corporation.com</p> <table border="0" style="width: 100%; font-size: x-small;"> <tr> <td>Issn:</td> <td>For message used:</td> <td>For reference:</td> <td>For reference:</td> </tr> <tr> <td>April 16, 2012</td> <td>TG/IC Valve</td> <td></td> <td></td> </tr> </table> <p>Declaration of Conformity in accordance with Directive 1999/5/EC (R&TTE Directive)</p> <p>Manufacturer: Continental Automotive GmbH Address: Siemensstrasse 12 D-10585 Regensburg Germany</p> <p>Product type designation: 816003050 Intended use: Tyre Pressure Monitoring Sensor</p> <p>The product mentioned above complies with the essential requirements and other relevant provisions of Directive 1999/5/EC, when used for its intended purposes.</p> <p>Health and safety pursuant to Art. 3(1)(a): Applied standard(s): EN 60 800-1:2006 + A11:2009 + A2:2010 + A2:2011 EN 62 479:2010</p> <p>Electromagnetic compatibility pursuant to Art. 3(1)(b): Applied standard(s): EN 301 489-1 V18.1 (1:2008-04) EN 301 489-3 V1.4.1 (1:2002-08)</p> <p>Efficient use of spectrum pursuant to Art. 3(2): Applied standard(s): EN 300 220-1 V2.3.1 (2:010-02) EN 300 220-2 V2.3.1 (2:010-02)</p> <p>The following marking applies to the above-mentioned product:</p> <div style="display: flex; justify-content: space-between; align-items: flex-start;"> <div style="font-size: x-small;"> <p>Continental Automotive GmbH Regensburg, 93120-04-10</p> <p><i>Wey</i></p> <p>Address: V&P Responsible Head of Production Body & Security</p> <p style="font-size: xx-small;">(Signature of Responsible Head of Production) Date: 16.04.2012 Time: 10:00:00 Location: Regensburg</p> </div> <div style="font-size: x-small;"> <p> </p> <p>Responsible Officer: Charles-Philippe Coupez Body & Security</p> <p style="font-size: xx-small;">(Signature of Responsible Officer) Date: 16.04.2012 Time: 10:00:00 Location: Regensburg</p> </div> </div> <p style="font-size: xx-small; text-align: right;">Continental Automotive GmbH, Regensburg, 93120-04-10</p> </div>	Issn:	For message used:	For reference:	For reference:	April 16, 2012	TG/IC Valve		
Issn:	For message used:	For reference:	For reference:						
April 16, 2012	TG/IC Valve								



09 Wheels and tyres



09

Country/ Area	
Czech Republic:	Continental tímto prohlašuje, že tento Radio Transmitter je ve shodě se základními požadavky a dalšími příslušnými ustanoveními směrnice 1999/5/ES.
Denmark:	Undertegnede Continental erklærer herved, at følgende udstyr Radio Transmitter overholder de væsentlige krav og øvrige relevante krav i direktiv 1999/5/EF.
Germany:	Hiermit erklärt Continental, dass sich das Gerät Radio Transmitter in Übereinstimmung mit den grundlegenden Anforderungen und den übrigen einschlägigen Bestimmungen der Richtlinie 1999/5/EG befindet.
Estonia:	Käesolevaga kinnitab Continental seadme Radio Transmitter vastavust direktiivi 1999/5/EÜ põhinõuetele ja nimetatud direktiivist tulenevatele teistele asjakohastele sätetele.
UK	Hereby, Continental declares that this Radio Transmitter is in compliance with the essential requirements and other relevant provisions of Directive 1999/5/EC.
Spain:	Por medio de la presente Continental declara que el Radio Transmitter cumple con los requisitos esenciales y cualesquiera otras disposiciones aplicables o exigibles de la Directiva 1999/5/CE.
Greece:	ΜΕ ΤΗΝ ΠΑΡΟΥΣΑ Continental ΔΗΛΩΝΕΙ ΟΤΙ Radio Transmitter ΣΥΜΜΟΡΦΩΝΕΤΑΙ ΠΡΟΣ ΤΙΣ ΟΥΣΙΩΔΕΙΣ ΑΠΑΙΤΗΣΕΙΣ ΚΑΙ ΤΙΣ ΛΟΙΠΕΣ ΣΧΕΤΙΚΕΣ ΔΙΑΤΑΞΕΙΣ ΤΗΣ ΟΔΗΓΙΑΣ 1999/5/ΕΚ.
France:	Par la présente Continental déclare que l'appareil Radio Transmitter est conforme aux exigences essentielles et aux autres dispositions pertinentes de la directive 1999/5/CE.
Italy:	Con la presente Continental dichiara che questo Radio Transmitter è conforme ai requisiti essenziali ed alle altre disposizioni pertinenti stabilite dalla direttiva 1999/5/CE.
Latvia:	Ar šo Continental deklarē, ka Radio Transmitter atbilst Direktīvas 1999/5/EK būtiskajām prasībām un citiem ar to saistītajiem noteikumiem.
Lithuania:	Šiuo Continental deklaruoja, kad šis Radio Transmitter atitinka esminius reikalavimus ir kitas 1999/5/EB Direktyvos nuostatas.
Netherlands:	Hierbij verklaart Continental dat het toestel Radio Transmitter in overeenstemming is met de essentiële eisen en de andere relevante bepalingen van richtlijn 1999/5/EG.



Country/ Area	
Malta:	Hawnhekk, Continental, jiddikjara li dan Radio Transmitter jikkonforma mal-htigijiet essenzjali u ma provvedimenti oħrajn relevanti li hemm fid-Dirrettiva 1999/5/EC.
Hungary:	Alulírott, Continental nyilatkozom, hogy a Radio Transmitter megfelel a vonatkozó alapvető követelményeknek és az 1999/5/EC irányelv egyéb előírásainak.
Poland:	Niniejszym Continental oświadcza, że Radio Transmitter jest zgodny z zasadniczymi wymogami oraz pozostałymi stosownymi postanowieniami Dyrektywy 1999/5/EC.
Portugal:	Continental declara que este Radio Transmitter está conforme com os requisitos essenciais e outras disposições da Directiva 1999/5/CE.
Slovenia:	Continental izjavlja, da je ta Radio Transmitter v skladu z bistvenimi zahtevami in ostalimi relevantnimi določili direktive 1999/5/ES.
Slovakia:	Continental týmto vyhlasuje, že Radio Transmitter spĺňa základné požiadavky a všetky príslušné ustanovenia Smernice 1999/5/ES.
Finland:	Continental vakuuttaa täten että Radio Transmitter tyyppinen laite on direktiivin 1999/5/EY oleellisten vaatimusten ja sitä koskevien direktiivin muiden ehtojen mukainen.
Sweden:	Härmed intygar Continental att denna Radio Transmitter står i överensstämmelse med de väsentliga egenskapskrav och övriga relevanta bestämmelser som framgår av direktiv 1999/5/EG.
Iceland:	Hér með lýsir Continental yfir því að Radio Transmitter er í samræmi við grunnkröfur og aðrar kröfur, sem gerðar eru í tilskipun 1999/5/EC.
Norway:	Continental erklærer herved at utstyret Radio Transmitter er i samsvar med de grunnleggende krav og øvrige relevante krav i direktiv 1999/5/EF.

Related information

- Tyre pressure monitoring* (p. 325)

10



MAINTENANCE AND SERVICE

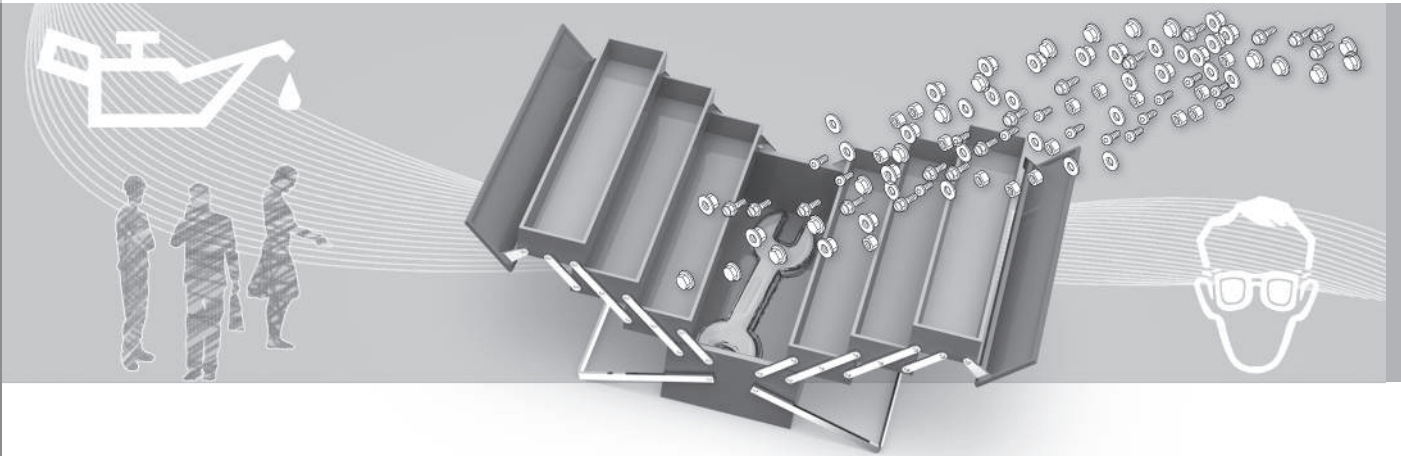



Volvo service programme

To keep the car as safe and reliable as possible, follow the Volvo service programme as specified in the Service and Warranty Booklet.

Volvo recommends engaging an authorised Volvo workshop to perform the service and maintenance work. Volvo workshops have the personnel, special tools and service literature to guarantee the highest quality of service.

IMPORTANT

For the Volvo warranty to apply, check and follow the instructions in the Service and Warranty Booklet.

Related information

- Climate control system - fault tracing and repair (p. 360)

Book service and repair*¹

Manage service, repair and booking information directly in your Internet-connected car.

This service provides a convenient way to book a service and workshop visit directly in the car. Car information is sent to your dealer, who can prepare the workshop visit. The dealer will contact you to schedule an appointment time. For certain markets, the system reminds you of a scheduled appointment time as it approaches and the navigation system² can also guide you to the workshop when the time comes.

Before the service can be used

Volvo ID and my profile

- Register a Volvo ID. For more information and how to create a Volvo ID, see Volvo ID (p. 20).
- Log in to the web portal My Volvo, go to your profile and carry out the following:
 1. Check that the car is connected to your profile.
 2. Check that your contact information is correct.
 3. Select the Volvo dealer you want to contact for service and repair.

4. Select preferred communication channel (SMS or phone). Booking information is always sent to the car and to you via email.

Prerequisite for booking from car

- To send and receive booking information to and from the car, the car must be connected to the Internet, see Sensus Infotainment supplement for information on how to connect the car to the Internet.
- Since the booking information is sent over your private phone subscription, you will be asked whether you want to send the information. The question is asked once and then applies to the selected connection for a limited time.
- For the service to work and for the system to communicate via the car's screen, notifications/pop-up messages must be accepted. In the normal view for the **MY CAR** source, press **OK/MENU** and then **Service & repair** → **Display notifications**.

Using the service

All menus and settings are accessed from the normal view in **MY CAR** by pressing **OK/MENU** and then **Service & repair**.

When it is time for service, and in some cases when the car is in need of repair, this is noti-

¹ Applies to certain markets.

² Applies to Sensus Navigation.



fied in the combined instrument panel (p. 61) and via a pop-up menu in the screen.

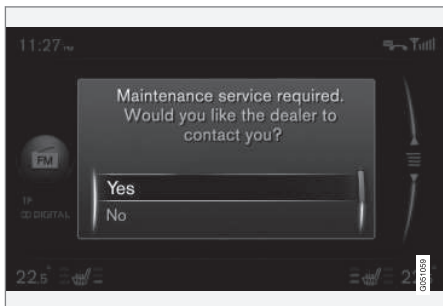

Service message in the screen.

Meaning of the answer options in the screen's pop-up menu:

- **Yes** - A booking enquiry is sent to your dealer who then comes back with a booking proposal. The service lamp and service message in the combined instrument panel are extinguished.
- **No** - No more pop-up messages will be shown in the screen. The message in the combined instrument panel remains. After this option has been selected, it is possible to start the manual booking in the car, see below.
- **Postpone** - The pop-up menu is shown the next time the car is started.

¹ Applies to certain markets.

² Applies to Sensus Navigation.

³ Vehicle Identification Number

Book a service or repair manually¹

1. Press the **MY CAR** button in the centre console and select **Service & repair** → **Dealer information** → **Request service or repair**.
 - > Vehicle data is sent automatically to your dealer.
2. The dealer sends a booking proposal to the car.
3. Accept or request a new booking proposal.

After the booking has been accepted the booking information is stored in the car, see My bookings. The car will automatically communicate with you via the screen by means of reminders about the booking and guide you to the workshop visit.

You can also book a workshop visit via My Volvo. Go to "My bookings" and select "Update" in order to gain access to bookings from My Volvo.

My bookings¹

Show booking information in the car's screen. Accept or request a new booking proposal.

- Select **Service & repair** → **My bookings**.

Call the dealer¹

With a Bluetooth® phone connected to the car, you can call your dealer. For connecting the phone, see Sensus Infotainment supplement.

- Select **Service & repair** → **Dealer information** → **Call dealer**.

Using the navigation system^{1, 2}

Enter your workshop as destination or waypoint in the navigation system.

- Select **Service & repair** → **Dealer information** → **Set single destination**.
- Select **Service & repair** → **Dealer information** → **Add as waypoint**.

Sending vehicle data¹

Vehicle data is sent to a central Volvo database (not your dealer) from which Volvo dealers can retrieve vehicle information using the car's identification number (VIN³). The number is printed in the car's service and warranty booklet, alternatively inside the windscreen's bottom left-hand corner.

- Select **Service & repair** → **Send car data**.



Booking information and vehicle data

When you decide to book a service from your car, the booking information and vehicle data will be sent. Vehicle data information consists of a number of signals within the following areas:

- Service requirement.
- Function status.
- Fluid levels.
- Mileage (distance).
- The car's vehicle identification number (VIN³).
- The car's software version.

Related information

- Volvo ID (p. 20)

³ Vehicle Identification Number



Raising the car

When raising the car it is important that the jack or lifting arms are fitted in the intended points on the car's underbody.



NOTE

Volvo recommends only using the jack that belongs to the car model in question. If a jack is selected other than the one recommended by Volvo, follow the instructions supplied with the equipment.

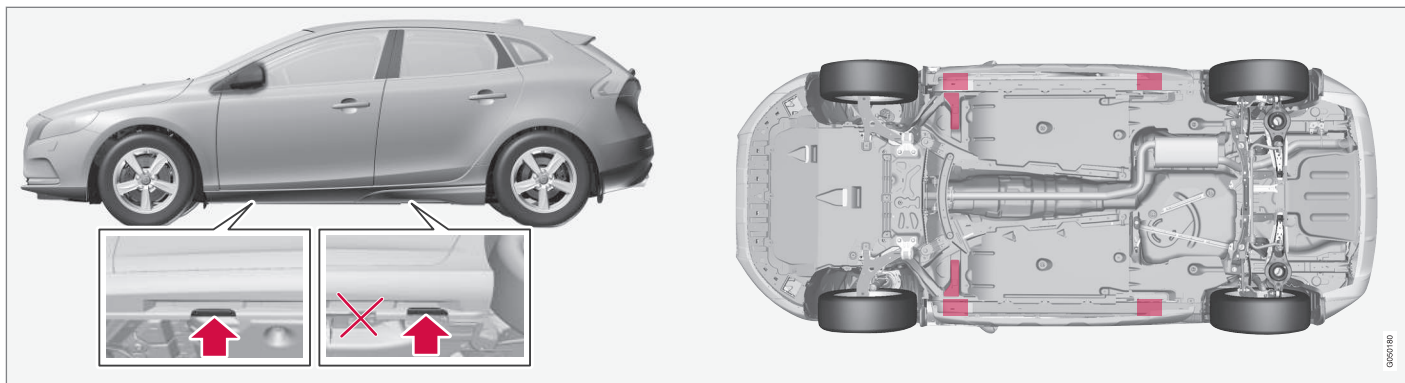

Jacking points (arrows) for the jack that belongs to the car and lifting points (marked in red).

If the car is raised with a front workshop jack then this must be positioned under one of the two lifting points furthest in under the car. If the car is raised with a rear workshop jack then it must be positioned under one of the lifting points. Ensure that the workshop jack is positioned so that the car cannot slide off the jack. Always use axle stands or similar.

If the car is raised with a two-pillar workshop lift then the front and rear lifting arms can be positioned under the outer lifting points (jacking points). Alternatively, the inner lifting points can be used at the front.

Related information

- Changing wheels - removing wheels (p. 320)



Bonnet - opening and closing

The bonnet can be opened when the handle in the passenger compartment has been turned clockwise and the lock by the grille has been moved to the left.



The handle for bonnet opening is always on the left-hand side.

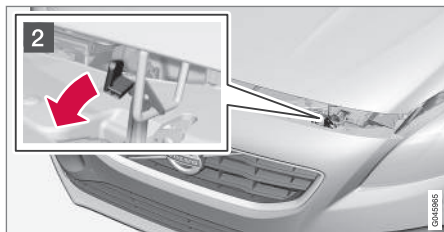

- 1 Turn the handle about 20-25 degrees clockwise. You will hear when the catch releases.

- 2 Move the catch to the left and open the bonnet. (The catch hook is located between the headlamp and grille, see illustration.)

WARNING

Check that the bonnet locks properly when closed.

Related information

- Engine compartment - checking (p. 353)
- Engine compartment - overview (p. 352)

Engine compartment - overview

The overview shows normal checking points.

Engine compartment 4-cyl. 2.0 l

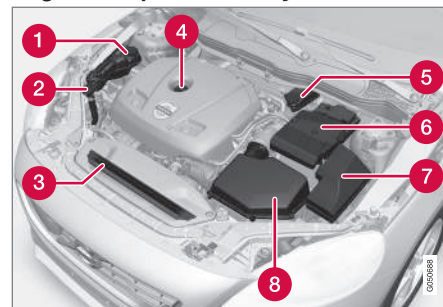

The appearance of the engine compartment may differ depending on engine variant.

- 1 Coolant expansion tank
- 2 Filling washer fluid
- 3 Radiator
- 4 Filling engine oil
- 5 Reservoir for brake and clutch fluid (located on the driver's side)
- 6 Starter battery
- 7 Relay and fuse box
- 8 Air filter



! WARNING

The ignition system has very high voltage and output. The voltage in the ignition system is highly dangerous. The car's electrical system must always be in key position **0** when work is being performed in the engine compartment; see Key positions - functions at different levels (p. 76).

Do not touch the spark plugs or ignition coil when the car's electrical system is in key position **II** or when the engine is hot.

Engine compartment, apart from 4-cyl. 2.0 I

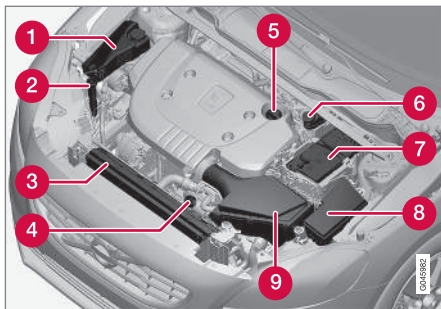

The appearance of the engine compartment may differ depending on engine variant.

- 1 Coolant expansion tank
- 2 Filling washer fluid

- 3 Radiator
- 4 Engine oil dipstick⁴
- 5 Filling engine oil
- 6 Reservoir for brake and clutch fluid (located on the driver's side)
- 7 Starter battery
- 8 Relay and fuse box
- 9 Air filter

! WARNING

The ignition system has very high voltage and output. The voltage in the ignition system is highly dangerous. The car's electrical system must always be in key position **0** when work is being performed in the engine compartment; see Key positions - functions at different levels (p. 76).

Do not touch the spark plugs or ignition coil when the car's electrical system is in key position **II** or when the engine is hot.

Related information

- Bonnet - opening and closing (p. 352)
- Engine compartment - overview (p. 352)
- Engine compartment - checking (p. 353)

Engine compartment - checking

Some oils and fluids should be checked at regular intervals.

Regular checking

Check the following oils and fluids at regular intervals, e.g. when refuelling:

- Coolant
- Engine oil
- Washer fluid

! WARNING

Remember that the radiator fan (located at the front of the engine compartment, behind the radiator) may start automatically some after the engine has been switched off.

Always have the engine cleaned by a workshop - an authorised Volvo workshop is recommended. There is a risk of fire if the engine is hot.

Related information

- Bonnet - opening and closing (p. 352)
- Engine compartment - overview (p. 352)
- Coolant - level (p. 358)
- Engine oil - checking and filling (p. 355)
- Washer fluid - filling (p. 370)

⁴ Engines with electronic oil level sensor do not have a dipstick (5-cyl. diesel).



Engine oil - general

An approved engine oil must be used in order that the recommended service intervals can be applied.

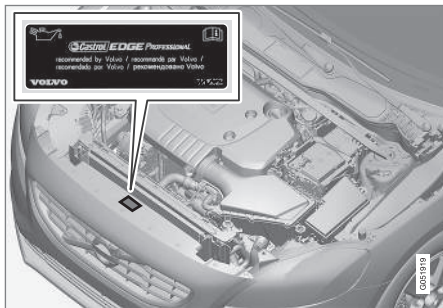

Volvo recommends:



When driving under adverse conditions, see Engine oil - adverse driving conditions (p. 400).

! IMPORTANT

In order to fulfil the requirements for the engine's service intervals all engines are filled with a specially adapted synthetic engine oil at the factory. The choice of oil has been made very carefully with regard to service life, starting characteristics, fuel consumption and environmental impact.

An approved engine oil must be used in order that the recommended service intervals can be applied. Only use a prescribed grade of oil for both filling and oil change, otherwise you will risk affecting service life, starting characteristics, fuel consumption and environmental impact.

Volvo Car Corporation disclaims all warranty liability if engine oil of the prescribed grade and viscosity is not used.

Volvo recommends that oil changes are carried out at an authorised Volvo workshop.

Volvo uses different systems for warning of low/high oil level or low oil pressure. Certain engine variants have an oil pressure sensor, and then the combined instrument panel's warning symbol for low oil pressure is used. Other variants have an oil level sensor, when the driver is informed via the instrument's warning symbol  and display texts. Cer-

tain variants have both systems. Contact a Volvo dealer for more information.

Change the engine oil and oil filter in accordance with the intervals specified in the Service and Warranty Booklet.

Using oil of a higher than specified grade is permitted. If the car is driven in adverse conditions, Volvo recommends using an oil of a higher grade; see Engine oil - adverse driving conditions (p. 400).

For filling capacities, see Engine oil - grade and volume (p. 401).

Related information

- Engine oil - checking and filling (p. 355)



Engine oil - checking and filling

Depending on engine variant the oil level is checked with the dipstick or the electronic oil level sensor.

Engine with oil dipstick⁵

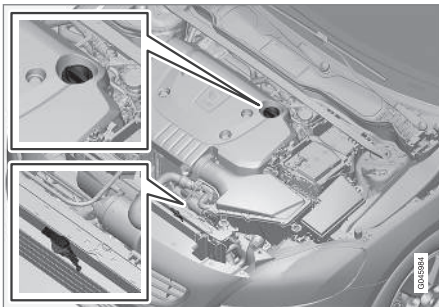

Dipstick and filler pipe.

Checking the oil level in a new car is especially important before the first scheduled oil change.

Volvo recommends checking the oil level every 2 500 km. The most accurate measurements are made on a cold engine before starting. The measurement will be inaccurate if taken immediately after the engine is switched off. The dipstick will indicate that the level is too low because the oil has not had time to flow down into the oil sump.

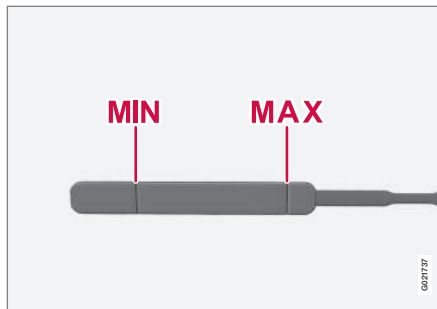

The oil level must be between the **MIN** and **MAX** marks.

Measurement and filling if required

1. Ensure that the car is level. After switching off the engine it is important to wait 5 minutes to allow the oil time to run back to the sump.
2. Pull up and wipe the dipstick.
3. Re-insert the dipstick.
4. Pull it out and check the level.
5. If the level is close to **MIN** then 0.5 litres should be added. If the level is significantly below, then an additional amount is required.

6. If required, check the level again, do it after driving a short distance. Then repeat steps 1 - 4.

! WARNING

Never fill above the **MAX** mark. The level should never be above **MAX** or below **MIN** as this could lead to engine damage.

! WARNING

Do not spill oil onto the hot exhaust manifold due to the risk of fire.

Engine with electronic oil level sensor, 4-cyl. 2.0 l

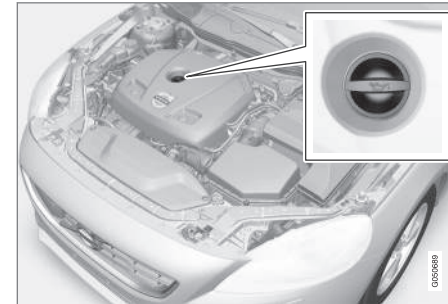

Filler pipe⁶.

⁵ Does not apply to the 4-cyl. 2.0 litre or 5-cyl. diesel, which have electronic oil level sensor.

⁶ Engines with electronic oil level sensor do not have a dipstick.



10 Maintenance and service



You do not need to take action with respect to the engine oil level before a message is shown in the display, see following illustration.

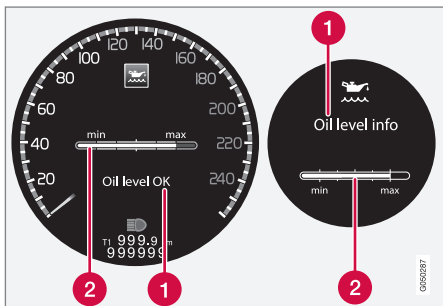

Message and graph in the display. The left-hand display shows the digital combined instrument panel and the right-hand the analogue.

- 1 Message
- 2 Engine oil level

The oil level is checked using the electronic oil level gauge with the thumbwheel when the engine is switched off, see Menu navigation - combined instrument panel (p. 105).

WARNING

If the message **Oil service required** is shown, visit a workshop - an authorised Volvo workshop is recommended. The oil level may be too high.

IMPORTANT

If notified of low oil level, only fill with the volume specified, for example, 0.5 litres.

NOTE

The system cannot directly detect changes when the oil is filled or drained. The car must have been driven approx. 30 km and have been stationary for 2 hours with the engine switched off and on level ground before oil level indication is correct.

WARNING

Do not spill oil onto the hot exhaust manifold due to the risk of fire.

Measuring the oil level, 4-cyl. 2.0 I

If the oil level needs to be checked then it should be carried out in accordance with the following sequence.

1. Activate key position **II**; see Key positions - functions at different levels (p. 76).

2. Rotate the thumbwheel on the left-hand stalk switch to position **Oil level**.
 - > You will then see information displayed about the engine oil level.

For more information on menu navigation, see Menu navigation - combined instrument panel (p. 105).

NOTE

If the right conditions for measuring the oil level are not met (time after engine shut-down, the car's inclination, outside temperature, etc.) then the message **Not available** will be shown. This does **not** mean that there is something wrong in the car's systems.



Engine with electronic oil level sensor, 5-cyl. diesel

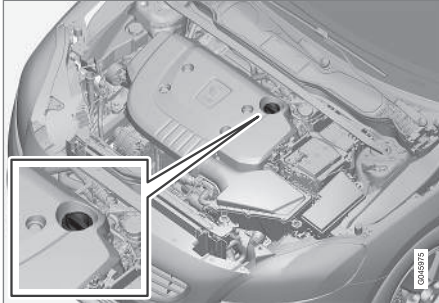

Filler pipe⁷.

You do not need to take action with respect to the engine oil level before a message is shown in the combined instrument panel's information display, see following illustration.

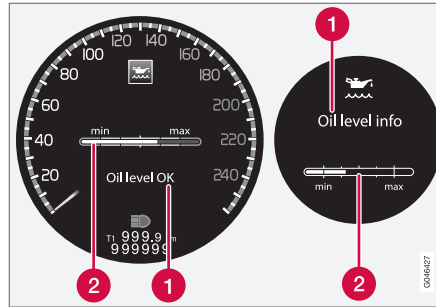

Message and graph in the display. The left-hand display shows the digital combined instrument panel and the right-hand the analogue.

- 1 Message
- 2 Engine oil level

On certain cars, the oil level can be checked using the electronic oil level gauge with the thumbwheel when the engine is switched off.

WARNING

If the message **Oil service required** is shown, visit a workshop - an authorised Volvo workshop is recommended. The oil level may be too high.

IMPORTANT

In the event of the message **Oil level low Refill 0.5 litre**, only fill with 0.5 litres.

NOTE

The oil level is only detected by the system during driving. The system cannot directly detect changes when the oil is filled or drained. The car must be driven about 30 km before the oil level display is correct.

WARNING

Do not fill more oil if filling level (3) or (4) appears as shown in the illustration below. The level must never be above **MAX** or below **MIN**, as this could lead to engine damage.

WARNING

Do not spill oil onto the hot exhaust manifold due to the risk of fire.

⁷ Engines with electronic oil level sensor do not have a dipstick.



Measuring the oil level, 5-cyl. diesel

If the oil level needs to be checked then it should be carried out in accordance with the following sequence.

1. Activate key position **II**; see Key positions - functions at different levels (p. 76).
2. Rotate the thumbwheel on the left-hand stalk switch to position **Oil level**.
 - > You will then see information displayed about the engine oil level.

For more information on menu navigation, see Menu navigation - combined instrument panel (p. 105).

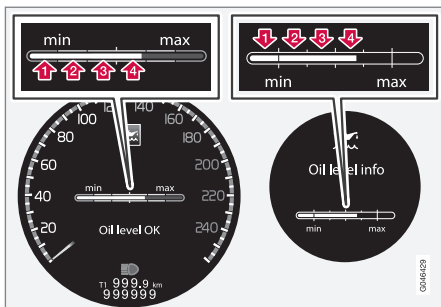

The figures 1-4 represent filling level. Do not fill more oil if filling level (3) or (4) is shown. The recommended filling level is 4. Message and graph in the display. The left-hand display shows the digital combined instrument panel and the right-hand the analogue.

Related information

- Engine oil - general (p. 354)
- Key positions - functions at different levels (p. 76)

Coolant - level

The coolant cools the internal combustion engine to the correct operating temperature. The heat that is transferred from the engine to the coolant can be used to heat the passenger compartment.

The coolant level must lie between the **MIN** and **MAX** marks on the expansion tank.

Checking the level and topping up

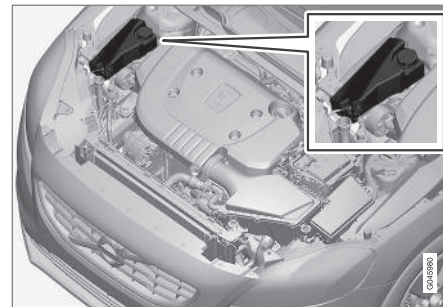

When topping up the coolant, follow the instructions on the packaging. It is important that the mixture of coolant concentrate and water is correct for the prevailing weather conditions. Never top up with water only. The risk of freezing increases with both too little and too much coolant concentrate.



WARNING

Coolant can be very hot. If the coolant requires topping up when the engine is at operating temperature, unscrew the expansion tank cap slowly to gently release the overpressure.

For capacities and for standards regarding water quality; see Coolant - grade and volume (p. 403).

Check the coolant regularly

The level must lie between the **MIN** and **MAX** marks on the expansion tank. If the system is not filled sufficiently, high temperatures could occur, causing a risk of damage to the engine.

IMPORTANT

- A high content of chlorine, chlorides and other salts may cause corrosion in the cooling system.
- Always use coolant with anti-corrosion agent as recommended by Volvo.
- Ensure that the coolant mixture is 50% water and 50% coolant.
- Mix the coolant with approved quality tap water. In the event of any doubt about water quality, used ready-mixed coolant in accordance with Volvo recommendations.
- When changing coolant/replacing cooling system components, flush the cooling system clean with approved quality tap water or flush with ready-mixed coolant.
- The engine must only be run with a well-filled cooling system. Otherwise, temperatures that are too high may occur resulting in the risk of damage (cracks) in the cylinder head.

Brake and clutch fluid - level

*Brake and clutch fluid level should be between the reservoir **MIN** and **MAX** marks.*

Checking the level

Brake and clutch fluid have a common reservoir. The level must be between the **MIN** and **MAX** marks that are visible inside the reservoir. Check the level regularly.

Change the brake fluid every other year or at every other regular service.

The fluid should be changed annually on cars driven in conditions requiring hard, frequent braking, such as driving in mountains or tropical climates with high humidity.

For capacities and recommended brake fluid grade, see Brake fluid - grade and volume (p. 405).

WARNING

If the brake fluid is below the **MIN** level in the brake fluid reservoir, do not drive further before topping up the brake fluid. Volvo recommends that the reason for the loss of brake fluid is investigated by an authorised Volvo workshop.



Filling

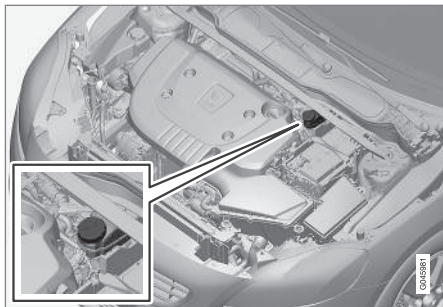

The fluid reservoir is located on the driver's side.

Unscrew the reservoir cap and fill the fluid. The level must be between the **MIN** and **MAX** marks, which are located on the inside of the reservoir.

IMPORTANT

Do not forget to refit the cap.

Climate control system - fault tracing and repair

The air conditioning system must only be serviced and repaired by an authorised workshop.

Troubleshooting and repair

The air conditioning system contains fluorescent tracing agents. Use ultraviolet light when looking for leaks.

Volvo recommends that you contact an authorised Volvo workshop.

WARNING

The air conditioning system contains pressurised refrigerant R134a. This system must only be serviced and repaired by an authorised workshop.

Related information

- Volvo service programme (p. 347)

Lamp replacement - general

Lamp replacement can be carried out for bulbs. When replacing LED and Xenon lamps, please refer to a workshop.

The bulbs are specified (p. 367). The following list contains locations of bulbs and other light sources that are specialised, such as LED⁸ lamps, or are unsuitable for changing for some other reason, except at a workshop⁹:

- active xenon headlamps - ABL (xenon lamps)
- position/parking lamps front¹⁰
- daytime running light lamps¹⁰
- side direction indicators, door mirrors¹⁰
- approach lighting, door mirrors
- interior and cargo area lighting
- glovebox lighting
- position/parking lamps rear
- side marker lamps rear
- brake light above the rear windscreen
- number plate lighting.

⁸ LED (Light Emitting Diode)

⁹ An authorised Volvo workshop is recommended.

¹⁰ Certain variants.



! WARNING

On cars with Xenon headlamps, the replacement of Xenon lamps must be carried out at a workshop - an authorised Volvo workshop is recommended. Working with Xenon lamps demands extreme caution because the headlamp is equipped with a high voltage unit.

! WARNING

The car's electrical system must be in key position **0** when replacing bulbs; see Key positions - functions at different levels (p. 76).

! IMPORTANT

Never touch the glass part of the bulbs with your fingers. Grease from your fingers is vaporised by the heat, coating the reflector and then causing damage.

i NOTE

If an error message remains after the broken bulb has been replaced then we recommend that you visit an authorised Volvo workshop.

i NOTE

Outside lighting such as headlamps, fog lamps and rear lamps may temporarily have condensation on the inside of the lens. This is normal, all exterior lighting is designed to withstand this. Condensation is normally vented out of the lamp housing when the lamp has been switched on for a time.

Related information

- Lamps - specifications (p. 367)
- Lamp replacement - location of front lamps (p. 361)
- Lamp replacement - location of rear lamps (p. 365)
- Lamp replacement - vanity mirror lighting (p. 366)

Lamp replacement - location of front lamps

The overview shows the location of the lamps at the front.

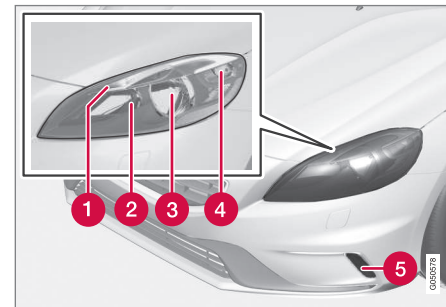

- 1** Position/parking lamps (p. 364) (LED in Xenon headlamps)
- 2** Main beam in Xenon headlamps (p. 363) / Extra main beam in Xenon headlamps (p. 363)
- 3** Dipped beam in halogen headlamps (p. 363) / Xenon lamps in Xenon headlamps (p. 360)
- 4** Indicator (p. 364)
- 5** Daytime running lights (p. 364) (LED* or bulb depending on variant)

Related information

- Lamp replacement - general (p. 360)
- Lamps - specifications (p. 367)

* Option/accessory, for more information, see Introduction.



Lamp replacement - headlamps

All of the headlamp bulbs are replaced via the engine compartment. First loosen and remove the whole headlamp.

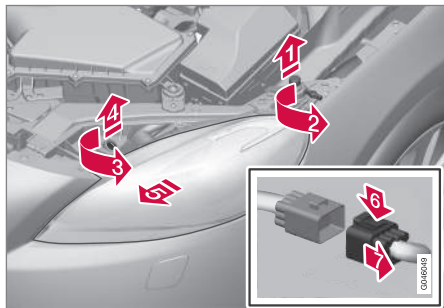

1. Lift out the bonnet stop.
2. Loosen the screw with a Torx tool, size T30.
3. Turn the locking pin anticlockwise.
 Pull out the locking pin.
4. Release the headlamp by alternately tilting and pulling it out.

IMPORTANT

Take care when lifting out the headlamp so as not to damage any parts.

5. Press down the catch.

- Unplug the connector.

Place the headlight on a soft surface so as not to scratch the lens.

IMPORTANT

Do not pull the electrical cable, only the connector.

6. Replace the relevant bulb as instructed. The headlight must be fitted and the contact fitted correctly before switching on the lights or switching key position.

Related information

- Lamp replacement - general (p. 360)
- Lamp replacement - location of front lamps (p. 361)
- Lamp replacement - cover for main/dipped beam bulbs (p. 362)
- Lamps - specifications (p. 367)

Lamp replacement - cover for main/dipped beam bulbs

Main/dipped beam bulbs are accessed by releasing the headlamp's larger cover.

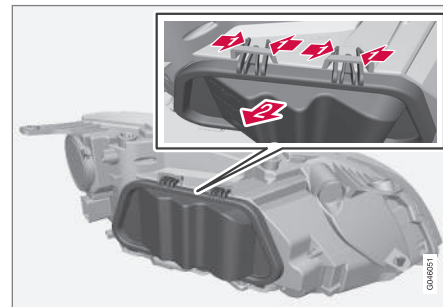

1. Press the hooks together.
 Angle out the cover.
2. Replace the relevant bulb as instructed.

Related information

- Lamp replacement - headlamps (p. 362)
- Lamp replacement - dipped beam (p. 363)
- Lamp replacement - main beam (p. 363)
- Lamp replacement - extra main beam (p. 363)



Lamp replacement - dipped beam

The dipped beam bulb is fitted inside the headlamp's larger cover.

i NOTE

Applies to cars with halogen headlamps.

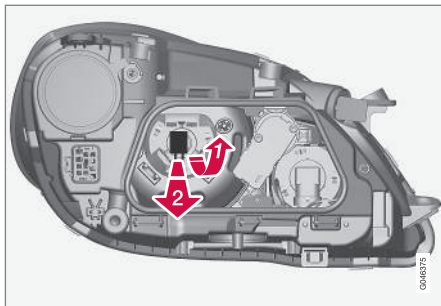

1. Detach the headlamp (p. 362).
2. Undo the cover (p. 362).
3. **1** Press the bulb holder upwards until it releases.
2 Pull out the bulb holder.
4. Replace the bulb and put back the parts in reverse order.

Related information

- Lamps - specifications (p. 367)

Lamp replacement - main beam

The main beam bulb is fitted inside the headlamp's larger cover.

i NOTE

Applies to cars with halogen headlamps.

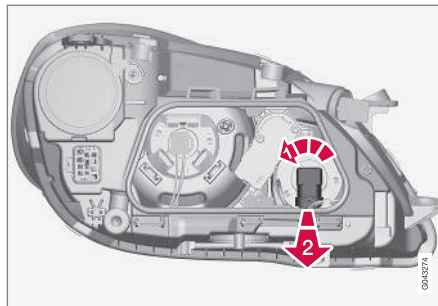

1. Detach the headlamp (p. 362).
2. Undo the cover (p. 362).
3. **1** Turn the bulb holder anticlockwise.
2 Pull out the bulb holder.
4. Replace the bulb and put back the parts in reverse order.

Related information

- Lamps - specifications (p. 367)

Lamp replacement - extra main beam

The extra main beam bulb is fitted inside the headlamp's larger cover.

i NOTE

Applies to cars with Xenon headlamps*.

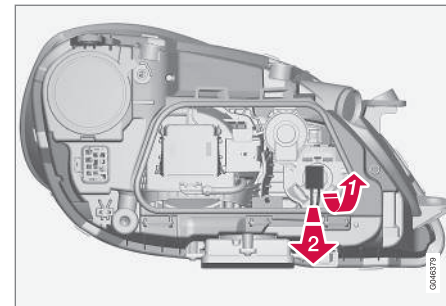

1. Detach the headlamp (p. 362).
2. Undo the cover (p. 362).
3. **1** Press the bulb holder upwards until it detaches.
2 Pull out the bulb holder.
4. Replace the bulb and put back the parts in reverse order.

Related information

- Lamps - specifications (p. 367)



Lamp replacement - direction indicators front

The direction indicator lamp is fitted inside the headlamp's smaller cover.

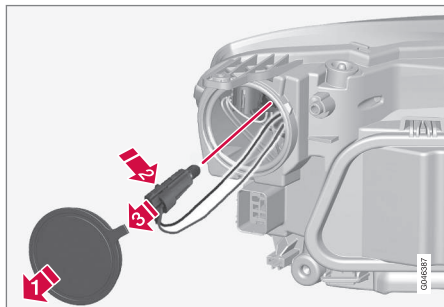

1. Detach the headlamp (p. 362).
2. Undo the cover.
3. Push in the catch.
 Pull out the bulb holder.
4. Replace the bulb and put back the parts in reverse order.

Related information

- Lamps - specifications (p. 367)

Lamp replacement - position/parking lamps front

The position/parking lamp bulb holder is located on the side of the headlamp.

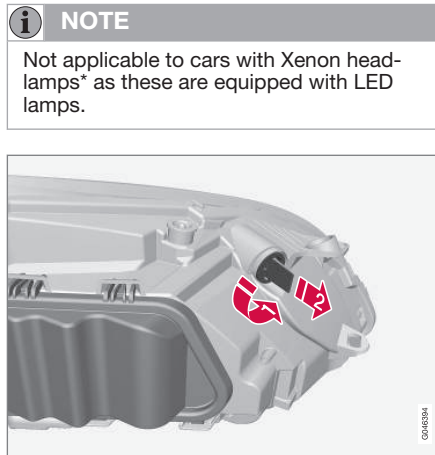

1. Detach the headlamp (p. 362).
2. Turn the bulb holder anticlockwise.
 Pull out the bulb holder.
3. Replace the bulb and put back the parts in reverse order.

Related information

- Lamps - specifications (p. 367)

Lamp replacement - daytime running lights

The daytime running light bulb is fitted inside the bumper's cover.

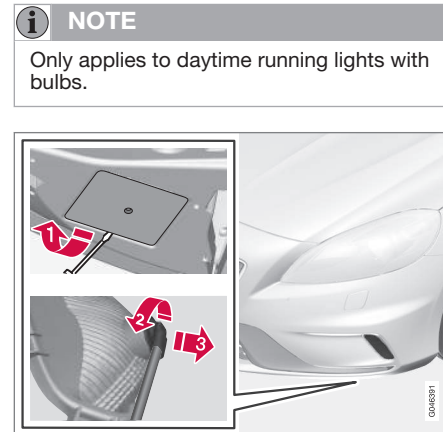

1. Undo the cover.
2. Turn the bulb holder anticlockwise.
 Pull out the bulb holder.
3. Replace the bulb and put back the parts in reverse order.

Related information

- Lamps - specifications (p. 367)



Lamp replacement - location of rear lamps

The overview shows the location of the lamps at the rear.

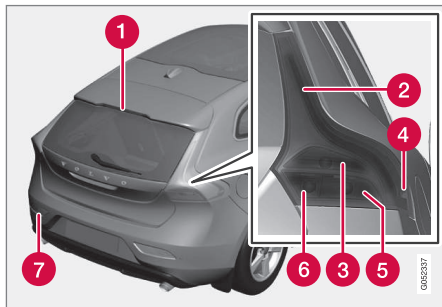

- 1 Brake light (LED)
- 2 Position/parking lights (LED)
- 3 Brake light (p. 365)
- 4 Side marker lamps (LED)
- 5 Indicator (p. 365)
- 6 Reversing lamp (p. 365)
- 7 Fog lamp (driver's side) (p. 366)

Related information

- Lamp replacement - general (p. 360)
- Lamps - specifications (p. 367)

Lamp replacement - direction indicators rear, brake lights and reversing lamp

Direction indicators rear, brake lights and reversing lamp are replaced from inside the cargo area.

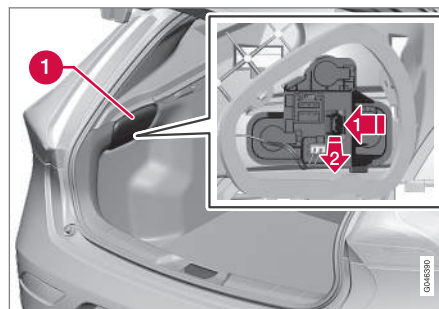

1. Remove the hatch in the upholstery (1) on the same side as the defective bulb.
2. Press the catch sideways.
- Pull out the bulb holder.
3. Remove the blown bulb by pressing it in and turning anticlockwise.
4. Replace the bulb and put back the parts in reverse order.

Related information

- Lamp replacement - location of rear lamps (p. 365)
- Lamps - specifications (p. 367)



Lamp replacement - rear fog lamp

The fog lamp bulb is fitted in the bumper's bulb holder.

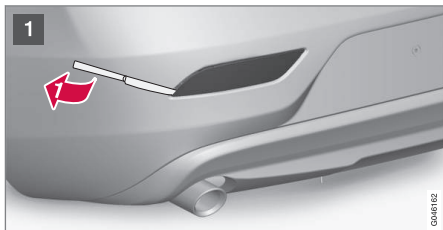

1 Insert (approx.20 mm) a blunt, knife-like object, e.g. a table knife, at the triangle.

▶ Carefully prise until the lug releases.

! IMPORTANT

Take care not to damage any parts.

2 ▶ Turn the bulb holder anticlockwise.

▶ Pull out the bulb holder.

3. Replace the bulb and put back the parts in reverse order.

Related information

- Lamps - specifications (p. 367)

Lamp replacement - vanity mirror lighting

The vanity mirror's lamps are fitted inside the lamp lenses.

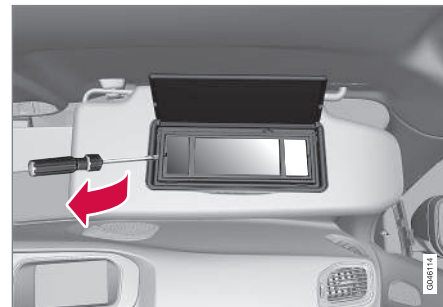

1. Insert a screwdriver under the lamp lens and gently prize up the lug on the edge.
2. Carefully detach and lift aside the lamp lens.
3. Using needle-nose pliers, pull the bulb straight out to the side. Do not squeeze too hard with the pliers. Otherwise, the bulb glass could break.
4. Replace the bulb and put back the parts in reverse order.

Related information

- Lamps - specifications (p. 367)



Lamps - specifications

The specifications apply to bulbs. When replacing LED and Xenon lamps, please refer to a workshop.

Lighting	[W] ^A	Type
Dipped beam ^B	55	H7 LL
Main beam ^B	65	H9
Additional main beam ^C	55	H7 LL
Front direction indicators	21	HY21W
Position/parking lamps front ^B	5	W5W LL
Daytime running lights ^D	19	PW19W
Side direction indicators, door mirrors ^D	5	WY5W LL
Direction indicators, rear	21	PY21W LL
Brake light	21	P21W LL
Reversing lamp	21	P21W LL

Lighting	[W] ^A	Type
Rear fog lamp	21	H21W LL
Vanity mirror lighting	1.2	T5 Socket W2x4.6d

A Watt

B Cars with halogen headlights

C Cars with xenon headlights

D Certain variants

Related information

- Lamp replacement - general (p. 360)
- Lamp replacement - location of front lamps (p. 361)
- Lamp replacement - location of rear lamps (p. 365)
- Lamp replacement - vanity mirror lighting (p. 366)

Wiper blades

The wiper blades sweep water away from the windscreen and rear window. Together with the washer fluid they clean the windows and ensure visibility for driving.

The windscreen wiper blades must be in service position when they are to be replaced.

Service position



Wiper blades in service position.

In order to change, clean or lift the wiper blades (for scraping off ice from the windscreen, for example) they must be in service position.



IMPORTANT

Before placing the wiper blades in the service position, make sure that they are not frozen down.



10 Maintenance and service



1. Insert the remote control key in the ignition switch¹¹ and briefly press the **START/STOP ENGINE** button to set the car's electrical system to key position **I**. For detailed information on key positions, see Key positions - functions at different levels (p. 76).
2. Briefly press the **START/STOP ENGINE** button again to set the car's electrical system in key position **0**.
3. Within 3 seconds, move the right stalk switch up and hold it in position for approx. 1 second.
 - > The wipers then move to standing straight up.

The wipers return to their starting position when you briefly press the **START/STOP ENGINE** button to set the car's electrical system to key position **I** (or when the car is started).

IMPORTANT

If the wiper arms in the service position have been folded up from the windscreen, they must be folded back down onto the windscreen before the wipers are allowed to return to their starting position. This is to avoid scraping the paint on the bonnet.

Replacing the wiper blades

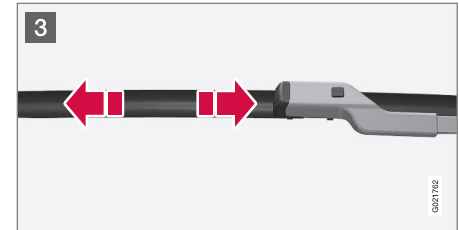
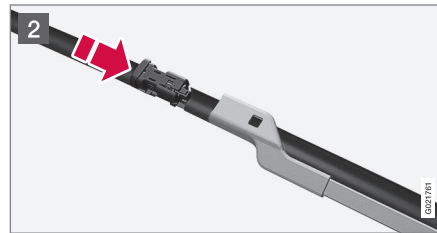
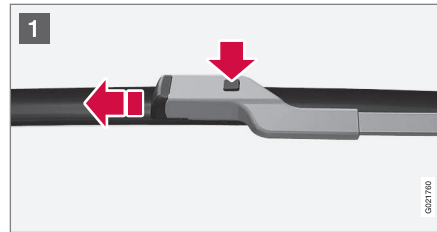

- 1 Fold up the wiper arm when it is in service position. Press the button located on the wiper blade mounting and pull straight out parallel with the wiper arm.
- 2 Slide in the new wiper blade until a "click" is heard.
- 3 Check that the blade is firmly installed.
4. Fold the wiper arm back towards the windscreen.

The wipers return from service position to their starting position when you briefly press the **START/STOP ENGINE** button to set the car's electrical system to key position **I** (or when the car is started).

¹¹ Not necessary in cars with the Keyless function.

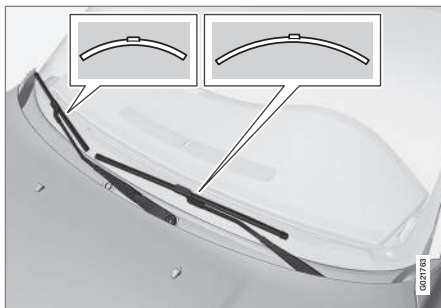

i NOTE

The wiper blades are different lengths. The blade on the driver's side is longer than on the passenger side.

⚠ WARNING

If the car is equipped with airbag Pedestrian Airbag then Volvo recommends that genuine wiper arms are used and that you only use genuine parts for them.

Replacing the wiper blades, rear window

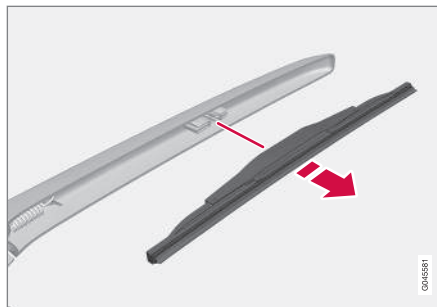

1. Fold out the wiper arm.
2. Grip the inner section of the blade (by the arrow).
3. Turn anticlockwise to use the blade's end position against the wiper arm as a lever to detach the blade more easily.
4. Press the new wiper blade into position. Check that it is firmly installed.
5. Lower the wiper arm.

Cleaning

For cleaning wiper blades and windscreen, see Car wash (p. 386).

! IMPORTANT

Check the blades regularly. Neglected maintenance shortens the service life of the wiper blades.

Related information

- Washer fluid - filling (p. 370)



Washer fluid - filling

Washer fluid is used for cleaning the headlamps and windows. Washer fluid with anti-freeze must be used during winter.

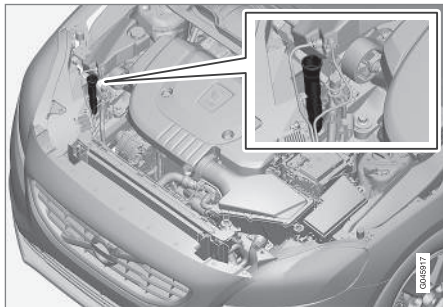

The windscreen and headlamp washers share a common reservoir.

! IMPORTANT

Use Volvo genuine washer fluid or equivalent with a recommended pH of between 6 and 8, in working dilution (e.g. 1:1 with neutral water).

! IMPORTANT

Use washer fluid with antifreeze during the winter to avoid freezing in the pump, reservoir and hoses.

For capacities, see Washer fluid - quality and volume (p. 405).

Related information

- Wiper blades (p. 367)

Starter battery - general

The starter battery is used to drive the starter motor and other electrical equipment in the car.

The starter battery is a traditional 12 V battery.

The service life and function of the starter battery is influenced by factors such as the number of starts, discharging, driving style, driving conditions, climatic conditions etc.

- Never disconnect the starter battery when the engine is running.
- Check that the cables to the starter battery are correctly connected and properly tightened.

The following table shows specifications for the starter battery.

Voltage (V)	12
Cold start capacity ^A - CCA ^B (A)	720 ^C 760 ^D or 800 ^D



Size , LxWxH (mm)	278x175x190 ^C 278x175x190 ^D or 315x175x190 ^D
Capacity (Ah)	70 ^C 70 ^D or 80 ^D

A According to EN standard.

B Cold Cranking Amperes.

C Manual gearbox.

D Automatic gearbox. The specification is dependent on the model variant.

IMPORTANT

When replacing the starter battery, in cars with Start/Stop function, a battery of the correct type must be fitted, EFB¹² in cars with manual gearbox and AGM¹³ in cars with automatic gearbox.

When replacing the support battery, a battery of AGM type must be fitted.

IMPORTANT

If the starter battery is replaced, make sure you replace it with a battery with the same cold starting capacity and type as the original battery (see the label on the battery).

NOTE

- The battery's container size should be consistent with the original battery's dimensions.
- The battery's height is different depending on size.

WARNING

- The battery can generate oxyhydrogen gas, which is highly explosive. A spark can be formed if a jump lead is connected incorrectly, and this can be enough for the battery to explode.
- The battery contains sulphuric acid, which can cause serious burns.
- If sulphuric acid comes into contact with eyes, skin or clothing, flush with large quantities of water. If acid splashes into the eyes - seek medical attention immediately.

IMPORTANT

When charging the starter battery or the support battery (p. 373), only use a modern battery charger with controlled charging voltage. Fast charging function must not be used since it may damage the battery.

IMPORTANT

If the following instruction is not observed then the energy saving function for information system may be temporarily disengaged, and/or the message in the combined instrument panel's information display about the starter battery's state of charge may be temporarily inapplicable, following the connection of an external battery or battery charger:

- The negative battery terminal on the car's starter battery must **never** be used for connecting an external battery or battery charger - only the **car chassis** may be used as the grounding point.

See Jump starting (p. 267) for a description of how the cable clamps must be attached.

¹² Enhanced Flooded Battery.

¹³ Absorbed Glass Mat.



NOTE

The life of the battery is shortened if it becomes discharged repeatedly.

The life of the battery is affected by several factors, including driving conditions and climate. Battery starting capacity decreases gradually with time and therefore needs to be recharged if the car is not used for a longer time or when it is only driven short distances. Extreme cold further limits starting capacity.

To maintain the battery in good condition, at least 15 minutes of driving/week is recommended or that the battery is connected to a battery charger with automatic trickle charging.

A battery that is kept fully charged has a maximum service life.





Related information

- Battery - symbols (p. 372)
- Starter battery - replacement (p. 373)
- Battery - Start/Stop (p. 373)

Battery - symbols

There are information and warning symbols on the battery.

Symbols on the battery

	Use protective goggles.
	Further information in the owner's manual for the car.
	Store the battery out of the reach of children.
	The battery contains corrosive acid.

	Avoid sparks and naked flames.
	Risk of explosion.
	Must be taken for recycling.

NOTE

An expended battery must be recycled in an environmentally safe manner as it contains lead.

Related information

- Starter battery - general (p. 370)
- Battery - Start/Stop (p. 373)



Starter battery - replacement

The starter battery should be replaced by an authorised workshop.

The starter battery is a traditional 12 V battery.

Volvo recommends that you allow an authorised workshop to replace the batteries - an authorised Volvo workshop is recommended.

For more information on the car's starter battery, see Jump starting (p. 267).

Battery - Start/Stop

Cars with Start/Stop function, in addition to the starter battery, are equipped with a support battery.

Cars with the Start/Stop function are equipped with two 12 V batteries - one extra powerful starter battery for starting and one support battery that helps during the Start/Stop function's starting sequence.

For more information on the Start/Stop function, see Start/Stop* (p. 276).

For more information on the car's starter battery, see Jump starting (p. 267).

The following table shows specifications for the support battery.

Voltage (V)	12
Cold start capacity ^A - CCA ^B (A)	120 ^C 170 ^D

Size , LxWxH (mm)	150x90x106 ^C
	150x90x130 ^D
Capacity (Ah)	8 ^C
	10 ^D

A According to EN standard.

B Cold Cranking Amperes.

C Manual gearbox in combination with Start/Stop function that only auto-stops when the car is completely stationary.

D Others.



IMPORTANT

When replacing the starter battery, in cars with Start/Stop function, a battery of the correct type must be fitted, EFB¹⁴ in cars with manual gearbox and AGM¹⁵ in cars with automatic gearbox.

When replacing the support battery, a battery of AGM type must be fitted.

¹⁴ Enhanced Flooded Battery.

¹⁵ Absorbed Glass Mat.



NOTE

- The higher the current take-off in the car, the more the alternator must be working and the batteries charging = Increased fuel consumption.
- When the capacity of the starter battery has fallen below the lowest permissible level then the Start/Stop function is disengaged.

Temporarily reduced Start/Stop function due to high current take-off means:

- The engine starts automatically¹⁶ without the driver depressing the clutch pedal (manual gearbox).
- The engine starts automatically without the driver lifting his/her foot off the foot brake pedal (automatic gearbox).

Location of the batteries

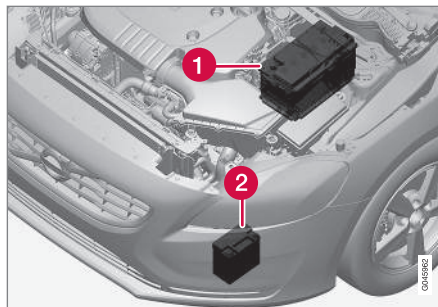

(1) Starter battery¹⁷ (2) Support battery

The support battery normally requires no more service than the normal starter battery. A workshop should be contacted in the event of questions or problems - an authorised Volvo workshop is recommended.

IMPORTANT

If the following instruction is not observed then the Start/Stop function may temporarily cease to work after the connection of an external battery or battery charger:

- The negative battery terminal on the car's starter battery must **never** be used for connecting an external battery or battery charger - only the **car chassis** may be used as the grounding point.

See Jump starting (p. 267) for a description of how the cable clamps must be attached.

¹⁶ Automatic starting can only take place if the gear lever is in neutral position.

¹⁷ See Starter battery - general (p. 370) for a detailed description of the starter battery.

**i NOTE**

If the battery has become so discharged that everything is "black" and in principle the car does not have all the normal electrical functions and the engine is subsequently started using an external battery or battery charger, then the Start/Stop function will be activated. It will then be possible for the engine to be auto-stopped but in the event of an auto-stop the Start/Stop function may fail to auto-start the engine due to inadequate capacity in the battery.

The battery must first be charged in order to ensure a successful auto-start after an auto-stop. At an outside temperature of +15 °C the battery needs to be charged for at least 1 hour. At a lower outside temperature a charging time of 3-4 hours is recommended. The recommendation is that the battery is charged using an external battery charger.

If this is not possible then the recommendation is to temporarily deactivate the Start/Stop function until the battery has been adequately recharged.

For more information on charging the starter battery, see Starter battery - general (p. 370).

Related information

- Battery - symbols (p. 372)

Electrical system

The electrical system is single-pole and uses the chassis and engine casing as a conductor.

The car has a voltage-regulated AC alternator.

The size, type and performance of the starter battery depend on the car's equipment and function.

! IMPORTANT

If the starter battery is replaced, make sure you replace it with a battery with the same cold starting capacity and type as the original battery (see the label on the battery).

Related information

- Starter battery - replacement (p. 373)
- Starter battery - general (p. 370)

Fuses - general

All electrical functions and components are protected by a number of fuses in order to protect the car's electrical system from damage by short circuiting or overloading.

If an electrical component or function does not work, it may be because the component's fuse was temporarily overloaded and failed. If the same fuse fails repeatedly then there is a fault in the circuit. Volvo recommends that you visit an authorised Volvo workshop for checking.

Changing

1. Look in the fuse diagram to locate the fuse.
2. Pull out the fuse and check from the side to see whether the curved wire has blown.
3. If this is the case, replace it with a new fuse of the same colour and amperage.

! WARNING

Never use a foreign object or a fuse with an amperage higher than that specified when replacing a fuse. This could cause significant damage to the electrical system and possibly lead to fire.



Location of central electrical units

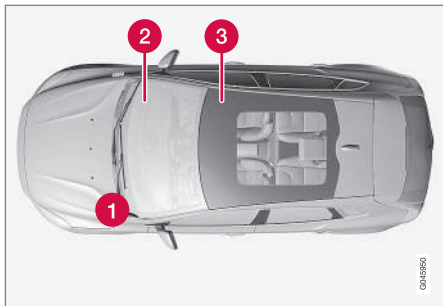

Fuse box locations in a left-hand drive car. In a right-hand drive car the fuse box under the glovebox changes sides.

- 1 Engine compartment
- 2 Under the glovebox
- 3 Under the right-hand front seat

Related information

- Fuses - in engine compartment (p. 377)
- Fuses - under glovebox (p. 381)
- Fuses - under the right-hand front seat (p. 384)



Fuses - in engine compartment

Fuses in the engine compartment protect engine and brake functions, amongst other things.

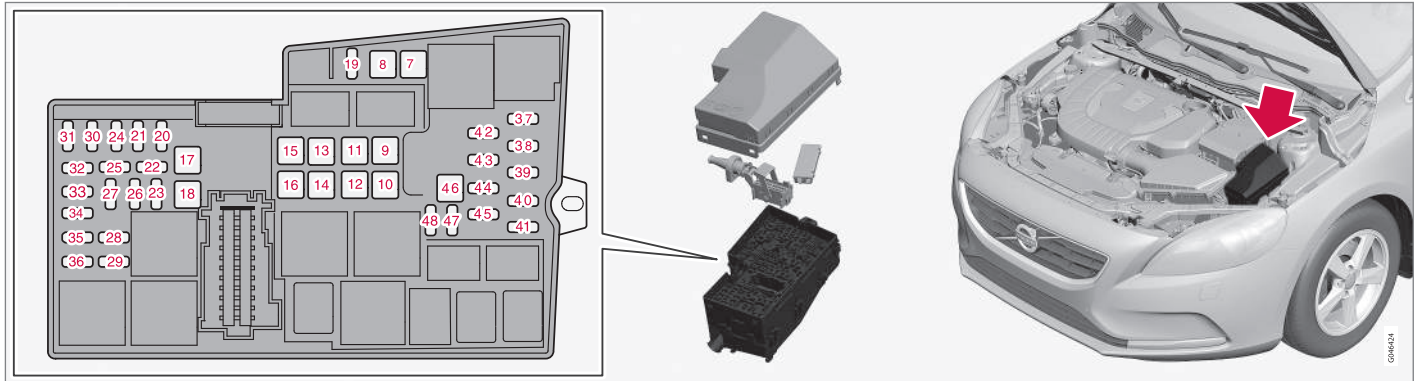

On the inside of the cover there are tweezers that facilitate the procedure for the removal and fitting of fuses.

The fuse box also provides space for several spare fuses.

Replacing fuses

The fuses can be accessed following the removal of the cover fitted on the starter battery and the cover for the electrical distribution unit.

Removing the covers

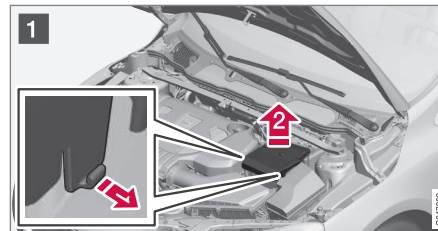

- 1 Fold out the locking catches that are fitted on the sides of the cover on the starter battery.
- 2 Lift the cover straight up.



10 Maintenance and service

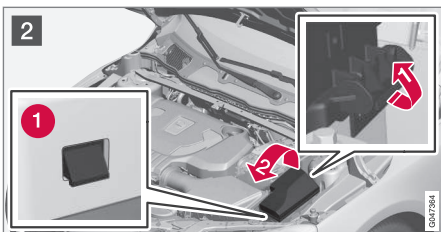

2 **1** Fold out the locking catch that is fitted on the side of the electrical distribution unit.

2 Rotate the cover upward until the lock lugs (1) are released.

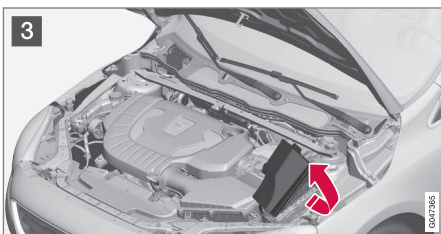

3 Fold the cover toward the engine to access the fuses.

Refitting the covers

Reinstall the parts in reverse order.

Positions

The label on the inside of the cover shows the positions of the fuses.

- Fuses 7-18 are of "JCASE" type and should be replaced by a workshop¹⁸.
- Fuses 19-45 and 47-48 are of "Mini Fuse" type.

	Function	A
7	ABS pump	40
8	ABS valves	30
9	Headlamp washers*	20
10	Ventilation fan	40
11	-	-
12	Primary fuse for fuses 32-36	30
13	-	-
14	Heated windscreen, right-hand side*	40
15	-	-
16	Heated windscreen, left-hand side*	40
17	Parking heater*	20

	Function	A
18	Windscreen wipers	20
19	Central electronic module, reference voltage, support battery	5
20	Horn	15
21	Brake light	5
22	-	-
23	Headlamp control	5
24	Internal relay coils	5
25	12 V socket, tunnel console front	15
26	Transmission control module	15
27	Solenoid clutch A/C (1.6 litre, 5-cyl. petrol)	15
28	12 V socket, tunnel console rear	15
29	-	-
30	Engine control module (4-cyl. 2.0 l, 5-cyl.)	5
31	Power seat, right*	20

¹⁸ An authorised Volvo workshop is recommended.



	Function	A
32	Relay coil in cooling fan relay (4-cyl. 1.6 l, 5-cyl. diesel); Lambda-sonds (4-cyl. 1.6 l petrol); Mass air flow meter (1.6 l diesel, 5-cyl. diesel), Bypass valve, EGR cooling (1.6 l diesel); Bypass solenoid EGR cooling (5-cyl. diesel); Regulator valve, fuel flow (5-cyl. diesel); Regulator valve, fuel pressure (5-cyl. diesel)	10
	Lambda sonds (4-cyl. 2.0 l); Relay coil in relay for cooling fan (4-cyl. 2.0 l)	15
	Relay coil in cooling fan relay (5-cyl. petrol); Lambda-sonds (5-cyl. petrol)	20

	Function	A
33	Oil pump automatic gearbox (5-cyl.); Mass air flow sensor (1.6 l petrol, 5-cyl. petrol); EVAP valve (1.6 l petrol); Valves (4 cyl. 2.0 l 5-cyl. petrol); Solenoids (5-cyl. petrol); Crankcase ventilation heater (5-cyl. petrol); Control motor turbo (1.6 l diesel); Regulator valve, fuel flow (1.6 l diesel); Control module radiator roller cover (1.6 l diesel); Solenoid piston cooling (5-cyl. diesel); Turbo control valve (5-cyl. diesel); Oil level sensor (5-cyl. diesel); Compressor A/C (4-cyl. 2.0 l 5-cyl. diesel); Oil pump (4-cyl. 2.0 l); Cooling valve for climate control system (4-cyl. 2.0 l diesel); Relay coils in relays for Start/Stop functions	10

	Function	A
34	Valves (1.6 l petrol); Solenoids (1.6 l petrol); Injectors (5-cyl. petrol); Lambda-sond (5-cyl. diesel); Crankcase ventilation heater (5-cyl. diesel)	10
	Valve (4-cyl 2.0 l diesel); EVAP valve (4-cyl. 2.0 l petrol); Crankcase ventilation heater (4 cyl. 2.0 l petrol); Engine control module (4-cyl. 2.0 l), Mass air flow sensor (4-cyl. 2.0 l); Thermostat (4-cyl. 2.0 l petrol); Cooling pump for EGR (4 cyl. 2.0 l diesel); Glow control module (4-cyl. 2.0 l diesel)	15
35	Ignition coils (1.6 l petrol, 5-cyl. petrol)	10
	Ignition coils (4-cyl. 2.0 l petrol); Diesel filter heater (1.6 l diesel, 5-cyl. diesel); Glow control module (5-cyl. diesel)	15
	Diesel filter heater (4-cyl. 2.0 l diesel)	25
36	Engine control module (1.6 l)	10
	Engine control module (4-cyl. 2.0 l, 5-cyl.); Throttle unit (5-cyl. petrol)	15



	Function	A
37	ABS	5
38	Engine control module; Transmission control module; Airbags	7.5
39	Headlamp levelling*	10
40	Electric control servo	5
41	Central electronic module	15
42	-	-
43	-	-
44	Collision warning system	5
45	Accelerator pedal sensor	5
46	Charging point, support battery	-
47	-	-
48	Coolant pump (when no parking heater is available)	10

Related information

- Fuses - under glovebox (p. 381)
- Fuses - under the right-hand front seat (p. 384)



Fuses - under glovebox

Fuses under the glovebox protect the airbag and passenger compartment lighting functions, amongst other things.



On the inside of the cover for the **fuse box in the engine compartment** there are tweezers that facilitate the procedure for the removal and fitting of fuses.

The **fuse box in the engine compartment** also provides space for several spare fuses.

Replacing fuses

The fuses can be accessed when a protective cover has been removed from the fuse box.

Cover removal

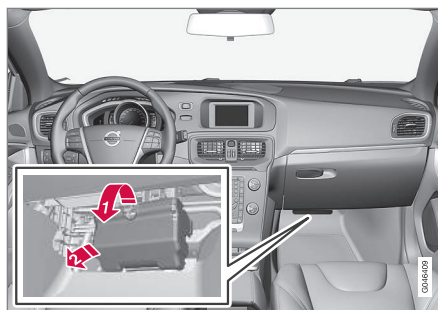

- 1 Take hold of the recess and pull until the locking lugs in the lower edge of the cover are released from the fuse box.
- 2 Remove the cover.

i NOTE

A relatively large amount of tensile force is required to release the locking lugs at the top edge of the cover from the electrical distribution unit.



10 Maintenance and service



Cover refitting



- 1 Guide in the lower lugs.
- 2 Turn the cover upwards until the upper lugs engage.

NOTE

Make sure that the upper locking lugs are seated properly in the grooves of the electrical distribution unit.

Positions

The fuses are of "Mini Fuse" type.

	Function	A
56	Fuel pump	20
57	-	-
58	Rear window wiper	15

	Function	A
59	Display in roof console (Seat-belt reminder/Indicator for air-bag on the front passenger seat)	5
60	Interior lighting, Controls in roof console for front reading lamps and passenger compartment lighting; Power seats*	7.5
61	Power operated roller blind, glass roof*	10
62	Rain sensor*; Dimming, interior rearview mirror*; Moisture sensor*	5
63	Collision warning system*	5
64	-	-
65	Unlocking, tailgate ^A	10
66	-	-
67	Reserve position 3, constant voltage	5
68	Steering lock	15
69	Combined instrument panel	5
70	Central locking system, fuel filler flap ^B	10

	Function	A
71	Climate panel	7.5
72	Steering wheel module	7.5
73	Siren*; Data link connector OBDII	5
74	Main beam	15
75	-	-
76	Reversing lamp	7.5
77	Windscreen wipers ^C ; Rear windscreen wiper ^C	20
78	Immobiliser	5
79	Reserve position 1, constant voltage	15
80	Reserve position 2, constant voltage	20
81	Movement sensor alarm*; Remote receiver	5
82	Windscreen wipers ^D ; Rear windscreen wiper ^D	20
83	Central locking system, fuel filler flap ^E	10
84	Unlocking, tailgate ^F	10



	Function	A
85	Electric additional heater*; Button seat heating rear*	7.5
86	Airbags; Pedestrian airbag*	7.5
87	Reserve position 4, constant voltage	7.5
88	-	-
89	-	-

- A See also fuse 84.
 B See also fuse 83.
 C See also fuse 82.
 D See also fuse 77.
 E See also fuse 70.
 F See also fuse 65.

Related information

- Fuses - in engine compartment (p. 377)
- Fuses - under the right-hand front seat (p. 384)



Fuses - under the right-hand front seat

Fuses under the right-hand front seat protect the infotainment system and seat heating, amongst other things.

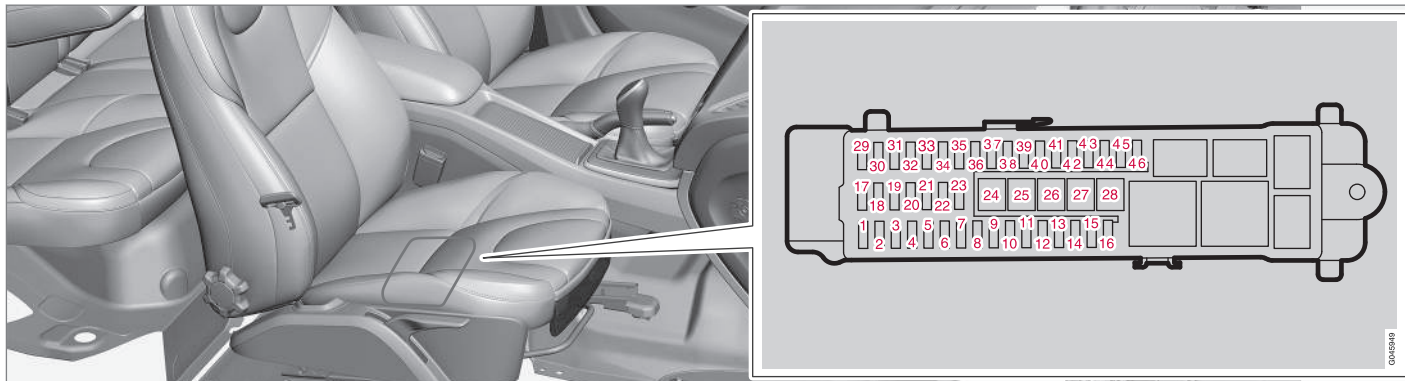

On the inside of the cover for the **fuse box in the engine compartment** there are tweezers that facilitate the procedure for the removal and fitting of fuses.

The **fuse box in the engine compartment** also provides space for several spare fuses.

Positions

- Fuses 24-28 are of "JCASE" type and should be replaced by a workshop¹⁹.
- Fuses 1-23 and 29-46 are of "Mini Fuse" type.

	Function	A
1	-	-
2	Keyless*	10
3	Door handle (Keyless*)	5
4	Control panel, left front door	25

¹⁹ An authorised Volvo workshop is recommended.



	Function	A
5	Control panel, right front door	25
6	Control panel, left rear door	25
7	Control panel, right rear door	25
8	Primary fuse for fuses 12-16: Infotainment	25
9	Power seat, left*	20
10	-	-
11	Internal relay coil	5
12	Audio control unit (amplifier)*, signal for diagnosis	5
13	-	-
14	Telematics*; Bluetooth*	5
15	Audio control module or Control module Sensus ^A ; Infotainment control module or Screen ^A	15
16	Digital radio*; TV*	7.5
17	12 V socket, cargo area	15
18	-	-
19	-	-

	Function	A
20	-	-
21	-	-
22	-	-
23	Trailer socket 2*	20
24	Audio control unit (amplifier)*	30
25	-	-
26	Trailer socket 1*	40
27	Rear window defroster	30
28	-	-
29	BLIS*	5
30	Parking assistance*	5
31	Parking camera*	5
32	-	-
33	-	-
34	Seat heating, front driver's side	15
35	Seat heating, front passenger side	15

	Function	A
36	-	-
37	-	-
38	-	-
39	Seat heating, rear right*	15
40	Seat heating, rear left*	15
41	AWD control module*	15
42	-	-
43	-	-
44	-	-
45	-	-
46	-	-

^A Certain model variants.

Related information

- Fuses - in engine compartment (p. 377)
- Fuses - under glovebox (p. 381)



Car wash

The car should be washed as soon as it becomes dirty. Wash the car in a car wash with oil separator. Use car shampoo.

Washing by hand

- Remove bird droppings from the paintwork as soon as possible. Bird droppings contain chemicals that affect and discolour paintwork very quickly. An authorised Volvo workshop is recommended for the removal of any discoloration.
- Hose down the underbody.
- Rinse the entire car until the dissolved dirt has been removed so as to reduce the risk of scratches from washing. Do not spray directly onto the locks.
- If necessary, use cold degreasing agent on very dirty surfaces. Note that in this case, the surfaces must not be hot from the sun!
- Wash using a sponge, car shampoo and plenty of lukewarm water.
- Clean the wiper blades with a lukewarm soap solution or car shampoo.
- Dry the car using a clean, soft chamois or a water scraper. If you avoid allowing drops of water to dry in strong sunlight, you reduce the risk of water drying stains which may need to be polished out.

WARNING

Always have the engine cleaned by a workshop. There is a risk of fire if the engine is hot.

IMPORTANT

Dirty headlamps have impaired functionality. Clean them regularly, when refuelling for example.

Do not use any corrosive cleaning agents but use water and a non-scratching sponge instead.

NOTE

Outside lighting such as headlamps, fog lamps and rear lamps may temporarily have condensation on the inside of the lens. This is normal, all exterior lighting is designed to withstand this. Condensation is normally vented out of the lamp housing when the lamp has been switched on for a time.

Wiper blades

Asphalt, dust and salt residue on wiper blades, as well as insects, ice etc. on the windscreen, impair the service life of wiper blades.

For cleaning:

- Set the wiper blades to the service position; see Wiper blades (p. 367).

NOTE

Wash the wiper blades and windscreen regularly with lukewarm soap solution or car shampoo.

Do not use any strong solvents.

Automatic car washes

An automatic car wash is a simple and quick way of washing the car, but it cannot reach everywhere. Handwashing the car is recommended for achieving optimum results.

NOTE

The car must only be washed by hand over the first few months. This is because the paint is more delicate when it is new.

High-pressure washing

When using high-pressure washing, use sweeping movements and make sure that the nozzle does not come closer than 30 cm to the surface of the car (the distance applies to all exterior parts). Do not spray directly onto the locks.



Testing the brakes

WARNING

Always test the brakes after washing the car, including the parking brake, to ensure that moisture and corrosion do not attack the brake linings and reduce braking performance.

Lightly depress the brake pedal now and then when driving long distances in rain or slush. The heat from the friction causes the brake linings to warm up and dry. Do the same thing after starting in very damp or cold weather.

Exterior plastic, rubber and trim components

A special cleaning agent available from Volvo dealers is recommended for the cleaning and care of coloured plastic parts, rubber and trim components, such as glossy trim mouldings. When using such a cleaning agent the instructions must be followed carefully.

IMPORTANT

Avoid waxing and polishing on plastic and rubber.

When using degreasant on plastic and rubber, only rub with light pressure if it is necessary. Use a soft washing sponge.

Polishing glossy trim mouldings could wear away or damage the glossy surface layer.

Polishing agent that contains abrasive must not be used.

Rims

Only use rim cleaning agent recommended by Volvo.

Strong rim cleaning agents can damage the surface and cause stains on chrome-plated aluminium rims.

Related information

- Polishing and waxing (p. 387)
- Cleaning the interior (p. 389)
- Water and dirt-repellent coating (p. 388)

Polishing and waxing

Polish and wax the car if the paintwork is dull or to give the paintwork extra protection.

The car does not need to be polished until it is at least one year old. However, the car can be waxed during this time. Do not polish or wax the car in direct sunlight.

Wash and dry the car thoroughly before you begin polishing or waxing. Clean off asphalt and tar stains using tar remover or white spirit. More stubborn stains can be removed using fine rubbing paste designed for car paintwork.

Polish first with a polish and then wax with liquid or solid wax. Follow the instructions on the packaging carefully. Many preparations contain both polish and wax.

IMPORTANT

Avoid waxing and polishing on plastic and rubber.

When using degreasant on plastic and rubber, only rub with light pressure if it is necessary. Use a soft washing sponge.

Polishing glossy trim mouldings could wear away or damage the glossy surface layer.

Polishing agent that contains abrasive must not be used.



IMPORTANT

Only paint treatment recommended by Volvo should be used. Other treatment such as preserving, sealing, protection, lustre sealing or similar could damage the paintwork. Paintwork damage caused by such treatments is not covered by Volvo warranty.

Related information

- Car wash (p. 386)

Water and dirt-repellent coating

The windows are treated with a surface coating that improves visibility in difficult weather conditions.

Water and dirt-repellent coating*



There is natural wear of the water-repellent coating.

Maintenance:

- Never use products such as car wax, degreaser or similar on glass surfaces as this could ruin their water-repellent properties.
- Take care when cleaning so as not to damage the glass surface.
- To avoid damaging glass surfaces when removing ice – only use plastic ice scrapers.
- Treatment with a special finishing agent available from Volvo dealers is recommended in order to maintain the water-repellent properties. This should be used first after three years and then each year.

IMPORTANT

Do not use a metal ice scraper to remove ice from the windows. Use the heating to remove ice from the door mirrors; see Windows and rearview and door mirrors - heating (p. 102).

Related information

- Car wash (p. 386)

Rustproofing

The car received a thorough and complete rustproofing at the factory. Parts of the body are made of galvanised sheet metal. The underbody is protected by a wear-resistant anti-corrosion compound. A thin, penetrating rustproofing fluid was sprayed into the exposed members, cavities, closed sections and side doors.

Inspection and maintenance

Dirt and road salt can lead to corrosion so it is important to keep the car clean. The car's rustproofing needs to be checked regularly and touched-up if necessary in order for it to be maintained.

Under normal conditions the rustproofing does not require treatment for approximately 12 years. After this period, it should be treated at three-year intervals. Volvo recommends that you engage an authorised Volvo workshop for assistance if the car needs further treatment.

Related information

- Paint damage (p. 390)



Cleaning the interior

Only use cleaning agents and car care products recommended by Volvo. Clean regularly and treat stains at once for best results. Vacuuming is important prior to using cleaning agents.

! IMPORTANT

- Certain items of coloured clothing (e.g. dark jeans and suede garments) may stain the upholstery. If this occurs, it is important to clean and treat these parts of the upholstery as soon as possible.
- Never use strong solvents such as washer fluid, pure petrol or white spirit to clean the interior, since this may damage the upholstery as well as other interior materials.
- Never spray the cleaning agent directly onto components that have electrical buttons and controls. Wipe them instead using a moistened cloth containing the cleaning agent.
- Sharp objects and Velcro may damage the fabric upholstery.

Fabric upholstery and ceiling upholstery

Volvo offers a comprehensive fabric care product for fabric upholstery and ceiling upholstery which, when used in accordance with the instructions, preserves the properties

of the upholstery. The fabric care product is available at your Volvo dealer.

Leather upholstery

Volvo's leather upholstery is treated to preserve its original appearance.

Leather upholstery is a natural product that changes and acquires a beautiful patina over time. Regular cleaning and treatment are required in order that the properties and colours of the leather shall be preserved. Volvo offers a comprehensive product, Volvo Leather Care Kit/Wipes, for the cleaning and treatment of leather upholstery which, when used in accordance with the instructions, preserves the leather's protective coating.

To achieve best results, Volvo recommends the cleaning and application of the protective cream once to four times per year (or more if required). The Volvo Leather Care Kit/Wipes is available from your Volvo dealer.

Leather steering wheel

Leather needs to breathe. Never cover the leather steering wheel with protective plastic. Volvo Leather Care Kit/Wipes is recommended for cleaning the leather steering wheel.

Interior plastic, metal and wood parts

A fibrillated fibre or microfibre cloth, lightly moistened with water, available from Volvo dealers, is recommended for cleaning interior parts and surfaces.

Do not scrape or rub stains. Never use strong stain removers. A special cleaning agent available from Volvo dealers can be used for more difficult cleaning.

Seatbelts

Use water and a synthetic detergent. A special textile cleaning agent is available from your Volvo dealer. Ensure that the seatbelt is dry before allowing it to retract.

Inlay mats and floor mat

Remove inlaid carpets for separate cleaning of the floor carpet and the inlaid carpets. Use a vacuum cleaner to remove dust and dirt. Each inlay mat is secured with pins.

Remove the inlay mat by taking hold of the inlay mat at each pin and lifting the mat straight up.

Fit the inlay mat in place by pressing it in at each pin.

! WARNING

Only use one inlaid mat at each seat, and check before setting off that the mat by the driver's seat is firmly affixed and secured in the pins so that it does not get caught adjacent to and under the pedals.

A special textile cleaner is recommended for stains on the floor mat after vacuuming. Floor mats should be cleaned with agents recommended by your Volvo dealer.



Related information

- Car wash (p. 386)

Paint damage

Paint is an important part of the car's rust-proofing and should therefore be checked regularly. The most common types of paintwork damage are stone chips, scratches, and marks on the edges of wings, doors and bumpers.

Touching up minor paintwork damage

To avoid the onset of rust, damaged paintwork should be rectified immediately.

Materials

- primer²⁰ - a special adhesive primer in a spray can is available for e.g. plastic-coated bumpers
- basecoat and clearcoat - available in spray cans or as touch-up pens/sticks²¹
- masking tape
- fine sand paper²⁰.

Colour code

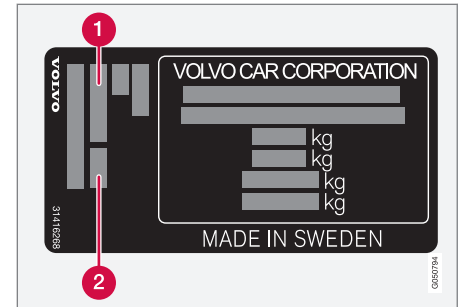

- 1 Exterior colour code
- 2 Any secondary exterior colour code

It is important that the correct colour is used. For product label location, see Type designations (p. 393).

²⁰ If required.

²¹ Follow the instructions that are included with the package for the touch-up pen/stick.



Repair minor paintwork damage such as stone chips and scratches

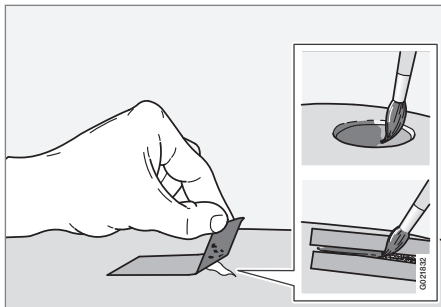

Before work is begun, the car must be clean and dry and at a temperature above 15 °C.

1. Apply a piece of masking tape over the damaged surface. Then remove the tape to remove any loose paint.

If the damage is down to the metal, use of a primer is appropriate. In the event of damage to a plastic surface, an adhesive primer should be used to give better results - spray into the lid of the spray can and brush on thinly.

2. Before painting, gentle polishing using a very fine polishing agent may be carried out locally if required (e.g. if there are any uneven edges). The surface is cleaned thoroughly and left to dry.

3. Stir the primer well and apply using a fine brush, a matchstick or similar. Finish off with a basecoat and clearcoat once the primer has dried.
4. For scratches, proceed as above, but mask around the damaged area to protect the undamaged paintwork.

i NOTE

If the stone chip has not penetrated down to the metal and an undamaged layer of paint remains in place, fill in with basecoat and clearcoat as soon as the surface has been cleaned.

Related information

- Rustproofing (p. 388)



SPECIFICATIONS

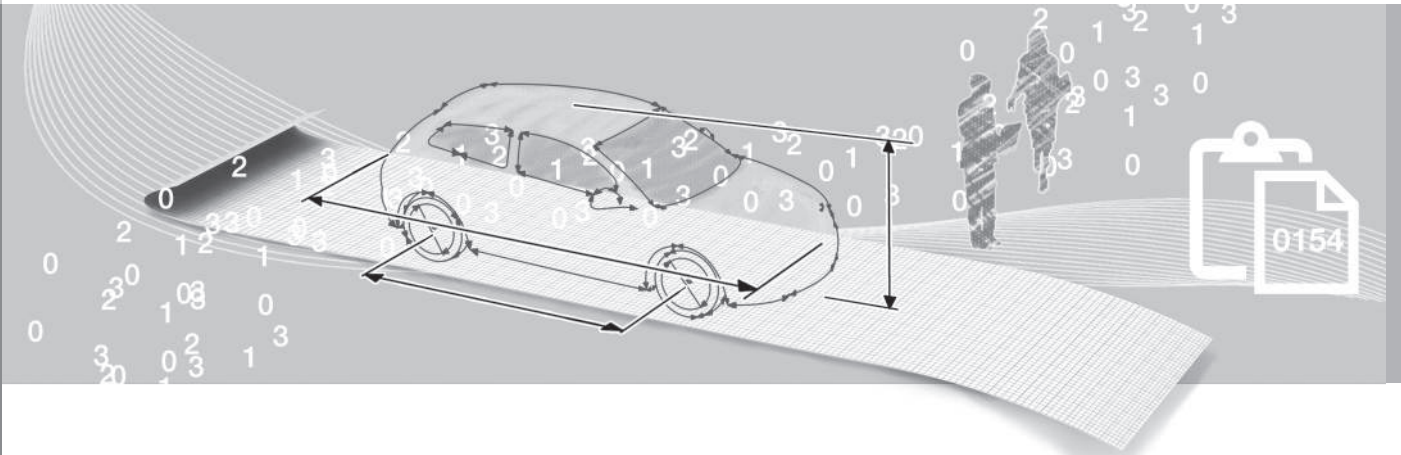

Type designations

Type designation, vehicle identification number, etc., i.e. information unique to the car, can be read on a label in the car.

Label location

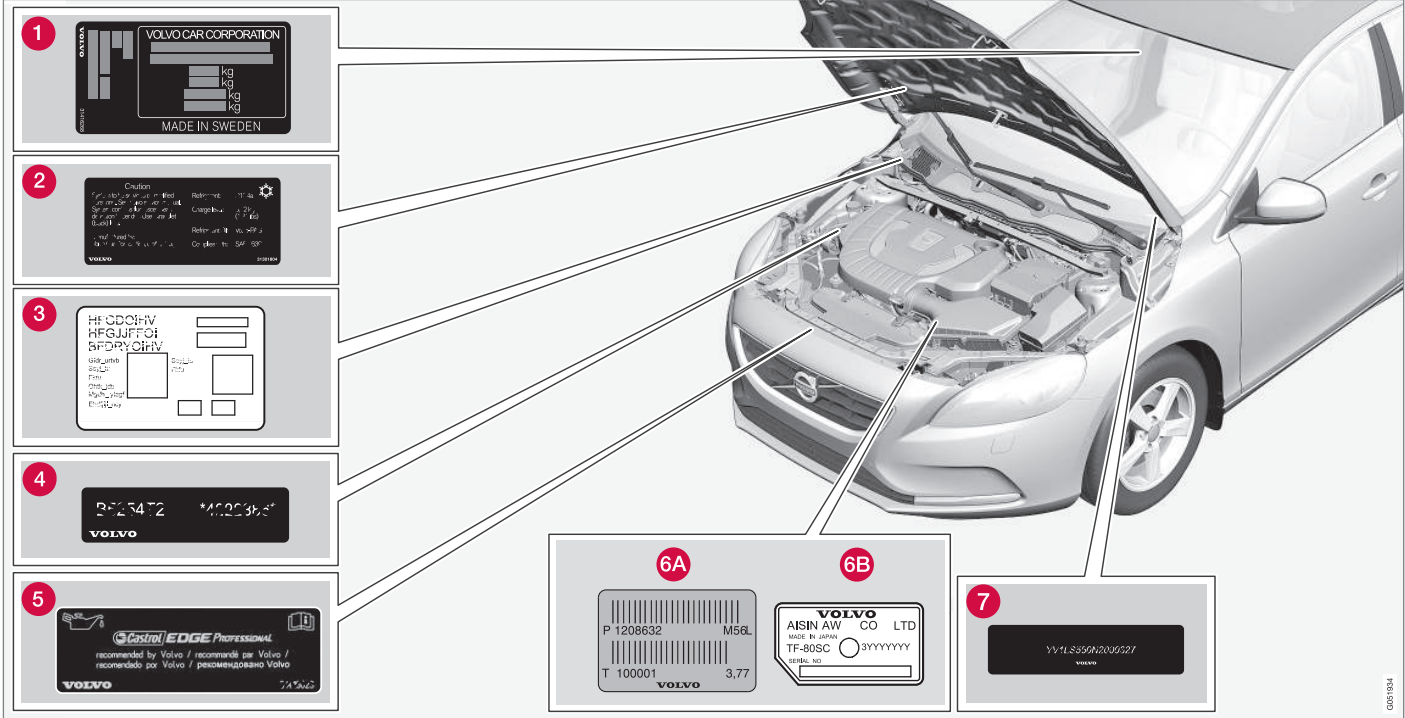

005104



Knowing the car's type designation, vehicle identification and engine numbers can facilitate all contact with an authorised Volvo dealer regarding the car and when ordering spare parts and accessories.

- 1 Type designation, vehicle identification number, permissible maximum weights and code designation for exterior colour and type approval number. The decal is positioned on the door pillar, and will be visible when the right-hand rear door is opened.
- 2 Label for A/C system.
- 3 Label for parking heater.
- 4 Engine code and engine serial number.
- 5 Label for engine oil.
 - A Manual gearbox
 - B Automatic gearbox
- 7 Car's identification number. (VIN Vehicle Identification Number)

Further information on the car is presented in the registration document.



NOTE

It is not intended that the decals illustrated in the owner's manual should be exact replicas of those in the car. They are included to show their approximate appearance and location in the car. The information that applies to your particular car is available on the respective decals for your car.

Related information

- Weights (p. 396)
- Engine specifications (p. 399)

Dimensions

Measurement of car length, height, etc. can be read in the table.

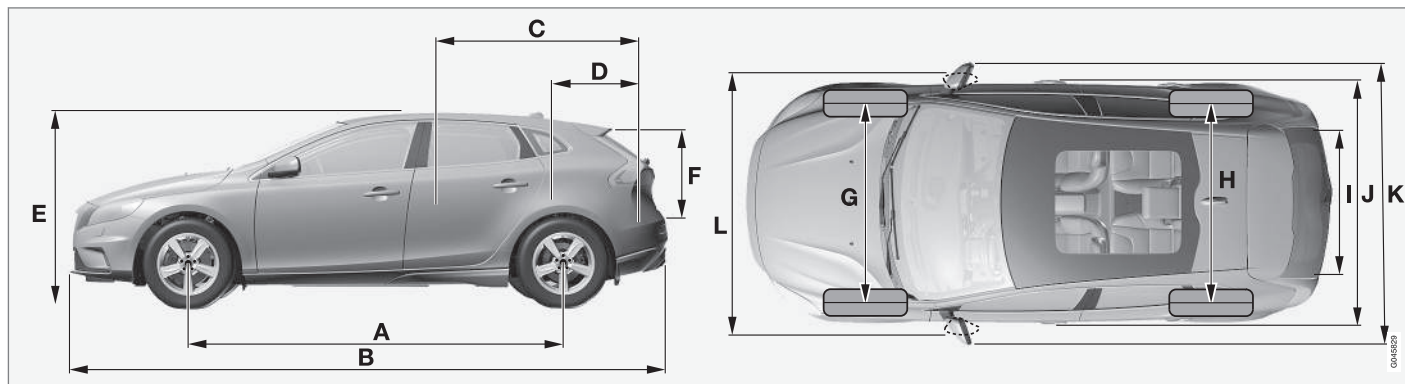

V40 CROSS COUNTRY.

	Dimensions	mm
A	Wheelbase	2646
B	Length	4370
C	Load length, floor, folded rear seat	1508
D	Load length, floor	684
E	Height	1458
F	Load height	532

	Dimensions	mm
G	Front track	1552 ^A
		1547 ^B
H	Rear track	1540 ^A
		1535 ^B
I	Load width, floor	960
J	Width	1802

	Dimensions	mm
K	Width including door mirrors	2041
L	Width including folded-in door mirrors	1857

^A Offset 50 mm.
^B Offset 52.5 mm.

11 Specifications

Weights

Max. gross vehicle weight, etc. can be read on a label in the car.

Kerb weight includes the driver, the fuel tank 90% full and all fluids.

The weight of passengers and accessories, and towball load (p. 397) (when a trailer is hitched) influence the load capacity and are not included in the kerb weight.

Permitted max. load = Gross vehicle weight - Kerb weight.

i NOTE

The documented kerb weight applies to cars in the standard version - i.e. a car without extra equipment or accessories. This means that for every accessory added the loading capacity of the car is reduced correspondingly by the weight of the accessory.

Examples of accessories that reduce loading capacity are the Kinetic/Momentum/Summum equipment levels, as well as other accessories such as Towbar, Load carrier, Space box, Audio system, Auxiliary lamps, GPS, Fuel-driven engine block heater, Safety grille, Carpets, Cargo cover, Power seats, etc.

Weighing the car is a certain way of ascertaining the kerb weight of your own particular car.

⚠ WARNING

The car's driving characteristics change depending on how heavily it is loaded and how the load is distributed.

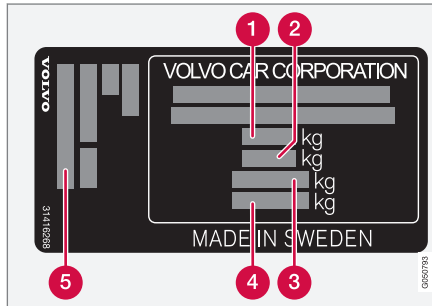

For information on label location, see Type designations (p. 393).

- 1** Max. gross vehicle weight
- 2** Max. train weight (car+trailer)
- 3** Max. front axle load
- 4** Max. rear axle load
- 5** Equipment level

Max. load: See registration document.

Max. roof load: 75 kg.

Related information

- Towing capacity and towball load (p. 397)

Towing capacity and towball load

Towing capacity and towball load for driving with a trailer can be read in the tables.

Max. weight braked trailer

V40CC ^A Engine	Engine code ^B	Gearbox	Max. weight braked trailer (kg)	Max. towball load (kg)
T4	B4164T	Manual, B6	1300	75
T4	B4164T	Automatic, MPS6	1500	75
T4	B5204T8	Automatic, TF-80SD	1500	75
T4 AWD	B5204T8	Automatic, TF-80SD	1500	75
T5	B5204T9	Automatic, TF-80SD	1500	75
T5 AWD	B5204T9	Automatic, TF-80SD	1500	75
T5 AWD	B5254T12	Automatic, TF-80SD	1500	75
T5 AWD	B4204T11	Automatic, TG-81SC	1500	75
D2	D4162T	Manual, B6	1300	75
D2	D4162T	Automatic, MPS6	1300	75
D3	D5204T6	Manual, M66	1500	75
D3	D5204T6	Automatic, TF-80SD	1500	75
D4	D4204T14	Manual, M66	1500	75
D4	D4204T14	Automatic, TG-81SC	1500	75

^A V40 CROSS COUNTRY

^B Engine code, component and serial number can be read on the engine; see Type designations (p. 393).



Max. weight unbraked trailer

V40CC ^A Engine	Engine code ^B	Gearbox	Max. weight unbraked trailer (kg)	Max. towball load (kg)
T4	B4164T	Manual, B6	650	50
T4	B4164T	Automatic, MPS6	700	50
T4	B5204T8	Automatic, TF-80SD	700	50
T4 AWD	B5204T8	Automatic, TF-80SD	700	50
T5	B5204T9	Automatic, TF-80SD	700	50
T5 AWD	B5204T9	Automatic, TF-80SD	750	50
T5 AWD	B5254T12	Automatic, TF-80SD	750	50
T5 AWD	B4204T11	Automatic, TG-81SC	750	50
D2	D4162T	Manual, B6	650	50
D2	D4162T	Automatic, MPS6	700	50
D3	D5204T6	Manual, M66	700	50
D3	D5204T6	Automatic, TF-80SD	750	50
D4	D4204T14	Manual, M66	700	50
D4	D4204T14	Automatic, TG-81SC	700	50

^A V40 CROSS COUNTRY

^B Engine code, component and serial number can be read on the engine; see Type designations (p. 393).

Related information

- Weights (p. 396)
- Driving with a trailer (p. 301)
- Trailer Stability Assist - TSA (p. 308)

Engine specifications

Engine specifications (output etc.) for each respective engine alternative can be read in the table.



NOTE

Not all engines are available in all markets.

V40CC ^A Engine	Engine code ^B	Output (kW/rpm)	Output (hp/rpm)	Torque (Nm/rpm)	No. of cylinders	Bore (mm)	Stroke (mm)	Swept volume (litres)	Compression ratio
T4	B4164T	132/5700	180/5700	240/1600–5000	4	79	81.4	1.596	10.0:1
T4	B5204T8	132/5000	180/5000	300/2700–4000	5	81.0	77	1.984	10.5:1
T5	B5204T9	157/6000	213/6000	300/2700–5000	5	81.0	77	1.984	10.5:1
T5	B5254T12	187/5400	254/5400	360/1800–4200	5	83	92,3	2,497	9.5:1
T5	B4204T11	180/5500	245/5500	350/1500–4800	4	82.0	93.2	1,969	10.8:1
D2	D4162T	84/3600	115/3600	270/1750-2500	4	75	88.3	1.560	16.0:1
D3	D5204T6	110/3500	150/3500	350/1500-2750	5	81.0	77	1.984	16.5:1
D4	D4204T14	140/4250	190/4250	400/1750-2500	4	82.0	93.2	1,969	15.8:1

^A V40 CROSS COUNTRY

^B Engine code, component and serial number can be read on the engine; see Type designations (p. 393).

Related information

- Coolant - grade and volume (p. 403)
- Engine oil - grade and volume (p. 401)

Engine oil - adverse driving conditions

Adverse driving conditions can lead to abnormally high oil temperature or oil consumption. Below are some examples of adverse driving conditions.

Check the oil level (p. 355), more frequently for long journeys:

- towing a caravan or trailer
- in mountainous regions
- at high speeds
- in temperatures colder than -30 °C or hotter than +40 °C

The above also apply to shorter driving distances at low temperatures.

Choose a fully synthetic engine oil for adverse driving conditions. It provides extra protection for the engine.

Volvo recommends:



! IMPORTANT

In order to fulfil the requirements for the engine's service intervals all engines are filled with a specially adapted synthetic engine oil at the factory. The choice of oil has been made very carefully with regard to service life, starting characteristics, fuel consumption and environmental impact.

An approved engine oil must be used in order that the recommended service intervals can be applied. Only use a prescribed grade of oil for both filling and oil change, otherwise you will risk affecting service life, starting characteristics, fuel consumption and environmental impact.

Volvo Car Corporation disclaims all warranty liability if engine oil of the prescribed grade and viscosity is not used.

Volvo recommends that oil changes are carried out at an authorised Volvo workshop.

Related information

- Engine oil - grade and volume (p. 401)
- Engine oil - general (p. 354)

Engine oil - grade and volume

Recommended engine oil grade and volume for each respective engine alternative can be read in the table.

Volvo recommends:



V40CC ^A Engine	Engine code ^B	Oil grade	Volume, incl. oil filter (litres)
T4	B4164T	Certified and factory-filled oil: Oil grade WSS-M2C925-A options for service: Oil grade: ACEA A5/B5 Viscosity: SAE 5W-30	approx. 4.1
D2	D4162T	Oil grade: ACEA A5/B5 Viscosity: SAE 0W-30	approx. 3.8
D3	D5204T6	Oil grade: ACEA A5/B5 Viscosity: SAE 0W-30	approx. 5.9

11 Specifications



V40CC ^A Engine	Engine code ^B	Oil grade	Volume, incl. oil filter (litres)
T4	B5204T8	Oil grade: ACEA A5/B5 Viscosity: SAE 0W-30	approx 5.5
T5	B5204T9		approx 5.5
T5	B5254T12		approx 5.5
T5	B4204T11	Castrol Edge Professional V 0W-20 or VCC RBS0-2AE 0w20	approx. 5.4
D4	D4204T14		approx 5.2

A V40 CROSS COUNTRY

B Engine code, component and serial number can be read on the engine; see Type designations (p. 393).

Related information

- Engine oil - adverse driving conditions (p. 400)
- Engine oil - checking and filling (p. 355)

Coolant - grade and volume

Approved coolant volume for each respective engine alternative can be read in the table.

Prescribed grade: Coolant recommended by Volvo mixed with 50% water², see the packaging.

V40CC ^A Engine ^B		Volume (litres)
T4	B4164T	7.0
D2	D4162T	10.0
D3	D5204T6	8.0
T4	B5204T8	8.0
T5	B5204T9	
T5	B5254T12	
T5	B4204T11	7,5 (7,8 ^C)
D4	D4204T14	8,0 (8,4 ^C)

^A V40 CROSS COUNTRY

^B Engine code, component and serial number can be read on the engine; see Type designations (p. 393).

^C Applies to cars with fuel-driven heater.

Related information

- Coolant - level (p. 358)

² Water quality must fulfil the standard STD 1285.1.

Transmission fluid - grade and volume

The prescribed transmission fluid and volume for each respective gearbox alternative can be read in the table.

Manual gearbox

Manual gearbox	Volume (litres)	Prescribed transmission fluid
B6	approx 1.6	BOT 350M3
M66	approx. 1.9 (approx. 1.45 ^A)	

^A Applies to the D4204T14 engine.

Automatic gearbox

Automatic gearbox	Volume (litres)	Prescribed transmission fluid
TF-80SD	approx 7.0	AW1
TG-81SC	approx. 6.6 ^A approx. 7.5 ^B	AW1
MPS6	approx 7.3	BOT 341

^A Petrol engines

^B Diesel engines

**NOTE**

For the MPS6, oil changes must take place within certain service intervals.

For other gearboxes the gearbox oil does not need to be changed under normal driving conditions. However, it may be necessary under adverse driving conditions.

Related information

- Engine oil - adverse driving conditions (p. 400)
- Type designations (p. 393)

Brake fluid - grade and volume

The medium in a hydraulic brake system is called brake fluid, and it is used to transfer pressure from e.g. a brake pedal via a master brake cylinder to one or more slave cylinders, which in turn act on a mechanical brake.

Prescribed grade: DOT 4

Volume: 0.6 litres

Related information

- Brake and clutch fluid - level (p. 359)

Washer fluid - quality and volume

Washer fluid is used, together with windscreen and rear window wipers, to keep the car's windows and headlamps clean and ensure visibility while driving.

Prescribed grade: Washer fluid recommended by Volvo - with frost protection during cold weather and below freezing point.

Volume:

- Cars **with** headlamp washing: 5.5 litres.
- Cars **without** headlamp washing: 3.2 litres.

Related information

- Washer fluid - filling (p. 370)
- Wiper blades (p. 367)
- Wipers and washing (p. 97)

Fuel tank - volume

Fuel tank volume for each respective engine alternative can be read in the table.

V40CC ^A Engine	Volume (litres)	Prescribed grade
T4 (B4164T)	approx. 62	Fuel - petrol (p. 297)
T4 (B5204T8)		
T5 (B5204T9)		
T4 AWD (B5204T8)	approx. 57	
T5 AWD (B5204T9)		
T5 AWD (B5254T12)		
T5 AWD (B4204T11)		
D2 (D4162T)	approx. 52	Fuel - diesel (p. 298)
D3 (D5204T6)	approx. 60	
D4 (D4204T14)	approx. 62	

A V40 CROSS COUNTRY

Related information

- Filling up with fuel (p. 296)
- Engine specifications (p. 399)

Air conditioning, fluid - volume and grade

The prescribed grade and volume of fluids in the air conditioning system can be read in the table.

Compressor oil

V40CC ^A Engine	Engine code ^B	Volume	Prescribed grade
T4	B4164T	150 ml	PAG oil
D2	D4162T	110 ml	
T5	B4204T11	60 ml	
D4	D4204T14		
T4	B5204T8	110 ml	
T5	B5204T9		
T5	B5254T12		
D3	D5204T6		

^A V40 CROSS COUNTRY

^B Engine code, component and serial number can be read on the engine; see Type designations (p. 393).

11 Specifications



Coolant

V40CC ^A Engine	Engine code ^B	Weight	Prescribed grade
T5	B4204T11	625 g	R134a
D4	D4204T14		
Other engines		650 g	

A V40 CROSS COUNTRY

B Engine code, component and serial number can be read on the engine; see Type designations (p. 393).

WARNING

The air conditioning system contains pressurised refrigerant R134a. This system must only be serviced and repaired by an authorised workshop.

Related information

- Climate control system - fault tracing and repair (p. 360)

Fuel consumption and CO2 emissions

Fuel consumption in a vehicle is measured in litres per 100 km and CO2 emissions in grams per km.

Explanation

CO ₂	gram/km
	litre/100 km

	urban driving
	extra-urban driving
	combined driving

man	manual gearbox
aut	Automatic gearbox







NOTE
If the consumption and emission data is missing then it is included in the enclosed supplement.

11

V40CC ^A 							
		CO ₂		CO ₂		CO ₂	
T4 (B4164T)	man	164	7.0	109	4.7	129	5.5
T4 (B4164T)	aut	184	7.9	120	5.1	143	6.1
T4 AWD (B5204T8)	aut	259	11.1	146	6.3	187	8.0
T5 (B5204T9)	aut	243	10.4	135	5.8	174	7.5
T5 AWD (B5204T9)	aut	259	11.1	146	6.3	187	8.0
T5 AWD (B4204T11)	aut	-	-	-	-	-	-

11 Specifications



V40CC ^A 							
		CO ₂		CO ₂		CO ₂	
T5 AWD (B5254T12)	aut	270	11,6	150	6.4	194	8.3
D2 (D4162T)	man	110	4.2	93	3.5	99	3.8
D2 (D4162T)	aut	118	4.5	103	3.9	108	4.1
D3 (D5204T6)	man	140	5.3	103	3.9	117	4.4
D3 (D5204T6)	aut	178	6.8	114	4.3	137	5.2
D4 (D4204T14)	man	114	4.4	99	3.8	104	4.0
D4 (D4204T14)	aut	132	5.0	101	3.9	112	4.3

A V40 CROSS COUNTRY

Fuel consumption and emission values in the table above are based on specific EU cycles³, that apply to cars with kerb weight in the basic version and without extra equipment.

The car's weight may increase depending on equipment. This, as well as how heavily the car is loaded, increases fuel consumption and carbon dioxide emissions.

There are several reasons for increased fuel consumption compared with the table's values. Examples of this are:

³ Official fuel consumption figures are based on two standardised driving cycles in a laboratory environment ("EU driving cycles") all in accordance with EU Regulation no 692/2008 and 715/2007 (Euro 5 / Euro 6) and UN ECE Regulation no 101. The regulations cover the driving cycles for urban driving and extra-urban driving. - Urban driving - the measurement starts with cold starting the engine. The driving is simulated. - Extra-urban driving - the car is accelerated and braked at speeds between 0-120 km/h. The driving is simulated. - Cars with manual gearbox are started in 2nd gear. The value for combined driving, which is reported in the table, is a combination of urban driving and extra-urban driving, in accordance with legal requirements. CO₂ emissions - the exhaust gases are collected in order to calculate the carbon dioxide emissions during the two driving cycles. These are then analysed and give the value for CO₂ emissions.

- The driver's driving style.
- If the customer has specified wheels larger than those fitted as standard on the model's basic version, then resistance increases.
- High speed results in increased wind resistance.
- Fuel quality, road and traffic conditions, weather and the condition of the car.

Even a combination of the above-mentioned examples can result in significantly improved consumption. For further information, please refer to the regulations referred to³.

Large deviations in fuel consumption may arise in a comparison with the EU driving cycles³ which are used in the certification of the car and on which the consumption figures in the table are based.

Consumption is higher and power output lower for fuel with an octane rating of 91 RON.

i NOTE

Extreme weather conditions, driving with a trailer or driving at high altitudes in combination with fuel grade are factors that could affect the car's performance.

Related information

- Economical driving (p. 301)
- Fuel - petrol (p. 297)
- Fuel - diesel (p. 298)
- Weights (p. 396)

³ Official fuel consumption figures are based on two standardised driving cycles in a laboratory environment ("EU driving cycles") all in accordance with EU Regulation no 692/2008 and 715/2007 (Euro 5 / Euro 6) and UN ECE Regulation no 101. The regulations cover the driving cycles for urban driving and extra-urban driving. - Urban driving - the measurement starts with cold starting the engine. The driving is simulated. - Extra-urban driving - the car is accelerated and braked at speeds between 0-120 km/h. The driving is simulated. - Cars with manual gearbox are started in 2nd gear. The value for combined driving, which is reported in the table, is a combination of urban driving and extra-urban driving, in accordance with legal requirements. CO₂ emissions - the exhaust gases are collected in order to calculate the carbon dioxide emissions during the two driving cycles. These are then analysed and give the value for CO₂ emissions.

Tyres - approved tyre pressures

Approved tyre pressures for each respective engine alternative can be read in the table.

V40CC ^A Engine	Tyre size	Speed (km/h)	Load, 1 - 3 persons		Max. load		ECO pressure ^B
			Front (kPa) ^C	Rear (kPa)	Front (kPa)	Rear (kPa)	Front/rear (kPa)
All	205/60 R16	0 - 160	240	230	260	260	260
	225/50 R17						
	225/45 R18	160 +	260	240	280	280	-
	225/40 R19						
Temporary Spare Tyre		max. 80	420	420	420	420	-

A V40 CROSS COUNTRY

B Economical driving.

C In certain countries there is the "bar" unit beside the SI unit "Pascal": 1 bar = 100 kPa.

i NOTE

All engines, tyres or combinations of these are not always available in all markets.

Related information

- Tyres - dimensions (p. 316)
- Tyres - air pressure (p. 315)
- Type designations (p. 393)

A

ACC – Adaptive cruise control.....	198
Active Bending Lights (ABL).....	89
Active main beam.....	87
Active Park Assist.....	248
function.....	249
Limitations.....	251
operation.....	249
Symbols and messages.....	252
Active Xenon headlamps.....	89
Active Yaw Control.....	183
Adapting driving characteristics.....	258
Adaptive Cruise Control.....	198
change cruise control functionality.....	207
deactivate.....	205
fault tracing.....	210
function.....	199
managing speed.....	202
overtaking.....	204
overview.....	201
radar sensor.....	208
setting the time interval.....	203
standby mode.....	203
temporary deactivation.....	203
Additional heater	
electric.....	140, 141
fuel-driven.....	140
Adjusting the steering wheel.....	82
Airbag	
activating/deactivating, PACOS.....	33
driver's side.....	31, 39
passenger side.....	31, 33, 39
AIRBAG	31
Airbag system.....	30
warning symbol.....	29
Air cleaning	
material.....	124
passenger compartment....	122, 123, 124
Air conditioning.....	131
Air conditioning, fluid	
volume and grade.....	407
Air conditioning system	
repair.....	360
Air distribution.....	125
Recirculation.....	133
table.....	134
Air quality system IAQS.....	124
Alarm.....	178, 179, 180
alarm indicator.....	179
alarm signals.....	180
automatic activation.....	179
automatic re-arming.....	179
checking the alarm.....	162
reduced alarm level.....	180
remote control key not working.....	180

Alcohol lock.....	260
Allergy and asthma inducing substances.	123
All Wheel Drive, (AWD).....	287
All Wheel Drive (AWD).....	287
Approach lighting.....	93, 160
Automatic car washes.....	386
Automatic gearbox.....	269, 273
manual gear positions (Geartronic)....	270
towing and recovery.....	309
trailer.....	303
Automatic relocking.....	171
AWD, All Wheel Drive.....	287

B

Backrest.....	78
front seat, lowering.....	78
Backrest rear seat, lowering.....	80
Bag holder	150
folding.....	150
Battery.....	294, 370
jump starting.....	267
maintenance.....	370
overload.....	294
remote control key/PCC.....	165

- symbols on the battery..... 372
 warning symbols..... 372
- BLIS..... 253, 254
- Bonnet, opening..... 352
- Book service and repair..... 347
- Brake and clutch fluid..... 359
- Brake fluid
 grade and volume..... 405
- Brake light..... 90
- Brakes..... 289, 290
 Anti-lock braking system, ABS..... 290
 brake light..... 90
 brake system..... 289, 290
 Emergency Brake Assistance, EBA ... 291
 emergency brake lights..... 90
 filling brake fluid..... 360
 handbrake..... 291
 symbols in the combined instrument
 panel..... 289
- Bulbs, see Lighting..... 362
- C**
-
- Camera sensor..... 218, 229
- Car care..... 386
 Leather upholstery..... 389
- Cargo area
 cargo net..... 152
 lighting..... 92
 loading..... 148
 mounting points..... 150
 parcel shelf..... 154
- Car key memory..... 157
- Car upholstery..... 389
- Car washing..... 386
- Catalytic converter..... 299
 Recovery..... 310
- Changing wheels..... 320
- Checking the engine oil level..... 354
- Children
 child safety locks..... 44
 child seat and airbag..... 49
 child seats and side airbags..... 36
 location in car..... 49
 safety..... 36, 44
- Child safety locks..... 176, 177
- Child seats..... 44
 ISOFIX fixture system for child seats... 50
 recommended..... 45
 size classes for child seats with ISO-
 FIX fixture system..... 50
 types..... 51
 upper mounting points for child seats.. 53
- City Safety™..... 216
- Cleaning
 automatic car wash..... 386
 car washing..... 386
 rims..... 387
 seatbelts..... 389
 upholstery..... 389
- Clean Zone Interior Package (CZIP)..... 123
- Climate control
 actual temperature..... 122
 auto-regulation..... 130
 general..... 121
 personal preferences..... 124
 sensors..... 122
 temperature control..... 131
- Clock, adjustment..... 70
- CO₂ emissions..... 409
- Collision..... 40
- Collision warning..... 223, 224
- Collision warning system
 function..... 224
 general limitations..... 228
 operation..... 227
 Pedestrian detection..... 226
 Radar sensor..... 208, 216
- Collision Warning System with Auto
 Brake..... 223
- Colour code, paint..... 390
- Combined instrument panel..... 61, 62

Compass.....	104
calibration.....	104
Condensation in headlamps.....	386
Controls, lights.....	83
Control symbols.....	62, 64
Coolant	
volume and grade.....	403
Coolant, checking and filling.....	358
Cooling system.....	293
overheating.....	293
Corner Traction Control.....	183
Crash, see Collision.....	40
Cruise control.....	193
deactivate.....	197
managing speed.....	194
resume set speed.....	196
temporary deactivation.....	195
CTA.....	255
Cyclist detection.....	225
CZIP (Clear Zone Interior Package).....	123

D

Daytime running lights.....	85
Deadlock.....	175
deactivation.....	175
temporary deactivation.....	175
Defroster.....	132
Detachable towbar	
storage.....	304
Diesel.....	298
run out of fuel.....	298
Diesel particle filter.....	300
Dimensions.....	395
Dipstick, electronic.....	355, 357
Direction indicator.....	91
Direction indicators.....	91
direction of rotation.....	314
Disengaging the gear selector inhibitor...	275
Display lighting.....	84
Distance Warning.....	213
Limitations.....	214
Symbols and messages.....	215
Door mirrors.....	101
Driveable punctured tyres.....	330
Driver Alert Control.....	232
operation.....	233

Driver Alert System.....	232
Driving.....	294
cooling system.....	293
with a tailer.....	301
with the tailgate open.....	293
Driving in water.....	292
Driving with a trailer	
towball load.....	397
towing capacity.....	397

E

ECC, electronic climate control.....	127
Eco Cruise.....	285
EcoGuide.....	65
Ecolabelling, FSC, owner's manual.....	23
Economical driving.....	301
ECO pressure.....	315, 412
Electrical socket.....	147
cargo area.....	151
Electrical system.....	375
Electronic climate control - ECC.....	127
Electronic temperature control - ETC.....	128
Emergency equipment	
first aid kit.....	325
warning triangle.....	324

- Emergency puncture repair..... 333
 action..... 335
 inflating the tyres..... 338
 rechecking..... 337
 stowing components..... 339
- Emergency puncture repair kit
 location..... 333
 overview..... 334
 sealing fluid..... 339
- Emissions of carbon dioxide..... 409
- Engine
 deactivate..... 266
 overheating..... 301
 start..... 265
 Start/Stop..... 276
- Engine and passenger compartment heater
 messages..... 139
 timer..... 138
- Engine block heater..... 136
- Engine block heater and passenger compartment heater
 direct start..... 137
 immediate stop..... 138
- Engine braking, automatic..... 287
- Engine compartment
 coolant..... 358
 oil..... 354
 overview..... 352
- Engine drag control..... 183
- Engine oil..... 354, 400
 adverse driving conditions..... 400
 filter..... 354
 grade and volume..... 401
- Engine specifications..... 399
- Error messages
 Adaptive Cruise Control..... 211
 Driver Alert Control..... 234
 LKA..... 239
 see Messages and symbols..... 211
- Error messages in BLIS..... 257
- ETC, electronic temperature control..... 128
- External dimensions..... 395
- F**
- Fan
 ECC..... 130
 ETC..... 130
- Fault tracing for the camera sensor..... 219
- First aid..... 325
- First aid kit..... 325
- Fluids, capacities..... 403, 404, 405, 406, 407
- Fluids and oils..... 403, 404, 405, 407
- Fog lamp
 rear..... 89
- Foot brake..... 289, 290
- Front seat
 head restraint..... 78
- FSC, ecolabelling..... 23
- Fuel..... 296, 297, 298
 fuel consumption..... 409
 fuel economy..... 315
 fuel filter..... 298
- Fuel-driven heater
 timer..... 138
- Fuelling..... 175, 300
 filling..... 296
 filling with reserve fuel can..... 300
 fuel filler flap..... 295
 fuel filler flap, locking..... 175
 fuel filler flap, manual opening..... 295
- Fuel tank
 volume..... 406
- Fuse box..... 376
- Fuses..... 375
 changing..... 375
 engine compartment..... 377
 General..... 375
 under glovebox..... 381
 under the right-hand front seat..... 384

G

Gearbox.....	268
automatic.....	269, 273
manual.....	268
Gear selector inhibitor.....	275
Gear selector inhibitor, mechanical disengagement.....	275
Gear shift indicator.....	269
Geartronic.....	270
Glass	
laminated/reinforced.....	23
Glass roof, power operated roller blind...	103
Glovebox.....	146
cooling.....	146
locking.....	173
Gross vehicle weight.....	396
GSI - Gear selector assistance.....	269

H

Handbrake.....	291
Hazard warning flashers.....	90
HDC.....	287
Headlamp control.....	83
Headlamp levelling.....	84

Headlamp pattern, adjusting.....	94
Headlamp pattern adjustment.....	94
Active Bending Lights	94
Halogen headlamp.....	94
Headlamps.....	362
head restraint	
centre seat, rear.....	80
front seat.....	78
lowering.....	80
Heating	
rearview and door mirrors.....	102
rear window.....	102
seats.....	129
windscreen.....	102
Heat-reflecting windscreen.....	19
High engine temperature.....	301
High-pressure headlamp washing.....	98
Hill Descent Control.....	287
Hill Start Assist.....	276
Home safe light duration.....	93
Horn.....	82

I

IAQS - Interior Air Quality System.....	124
Immobiliser.....	159

Indicator symbols.....	66
Inflatable curtain.....	36, 39
Information button, PCC.....	162
Information display.....	61, 62
Inlaid mats.....	147
Instrument lighting, see Lighting.....	84
Instrument overview	
left-hand drive car.....	55
right-hand drive car.....	58
Instruments and controls.....	55, 58
Interior Air Quality System (IAQS)	
Air cleaning.....	124
Interior lighting, see Lighting.....	92
Interior rearview mirror.....	103
automatic dimming.....	103
Intermittent wiping.....	97
Internet-connected car	
book service and repair.....	347

J

Jack.....	325
Journey statistics.....	119
Jump starting.....	267

K

Kerb weight.....	396
Key.....	156, 158
Key blade.....	163, 164
Keyless drive....	166, 167, 168, 169, 170, 265
Keyless - locking.....	168
Keyless start (keyless drive)....	166, 167, 168, 169, 170, 265
Keyless - unlocking.....	168
Keypad in the steering wheel.....	82
Key positions.....	75

L

Labels.....	393
Laminated glass.....	23
Lamps, see Lighting.....	360
Lane keeping assistant operation.....	237
Lane keeping assistant - LKA.....	235
Laser sensor.....	220
Leather upholstery, washing instructions	389
Light indications, PCC.....	162

Lighting.....	360
Active Xenon headlamps.....	89
approach lighting.....	93, 160
automatic lighting, passenger com- partment.....	92
bulbs, specifications.....	367
controls.....	92
daytime running lights.....	85
display lighting.....	84
headlamp levelling.....	84
home safe lighting.....	93
instrument lighting.....	84
in the passenger compartment.....	92
main/dipped beam.....	86
position/parking lamps.....	85
rear fog lamp.....	89
tunnel detection.....	86
Lighting, bulb replacement.....	362
daytime running lights.....	364
dipped beam (cars with halogen head- lamps).....	363
direction indicators, front.....	364
main beam (cars with active xenon headlamps).....	363
main beam (cars with halogen head- lamps).....	363
position/parking lamps.....	364
rear bulb holder: direction indicators, brake lamps and reversing lamps.....	365

rear fog lamps.....	366
vanity mirror.....	366
LKA - Lane keeping assistant.....	235
Loading	
cargo area.....	148, 150
General.....	148, 150
long load.....	149
mounting points.....	150
roof load.....	149
Lock	
locking.....	170
manual locking.....	171
unlocking.....	170, 172
Lockable wheel bolts.....	318
Lock confirmation	158
Lock indicator.....	158
Locking/unlocking	
inside.....	172
tailgate.....	173

M

Main/dipped beam, see Lighting.....	86
Main beam, automatic activation.....	87
maintenance	
Rustproofing.....	388

Manual gearbox.....	268	Misting		Park Assist.....	240
GSI - Gear selector assistance.....	269	condensation in headlamps.....	386	backward.....	242
Towing and recovery.....	309	Mood lighting.....	93	fault indicator.....	243
trailer.....	303	MY CAR.....	108	function.....	240
Manual gear positions (Geartronic).....	270			parking assistance sensors.....	243
Max. roof load.....	396			Park assist camera.....	244
Memory function in seat.....	79			settings.....	246
Menus		O		Parking brake.....	291
Combined instrument panel.....	105	Oil, see also Engine oil.....	400, 401	Passenger compartment filter.....	123
menu overview, analogue.....	106	Oil level low.....	354	Passenger compartment heater.....	136
menu overview, digital.....	106	Output.....	399	Passenger compartment lighting	
Messages.....	107	outside temperature gauge.....	70	automatic.....	92
Information display.....	106	Overheating.....	301	PCC – Personal Car Communicator	
Messages and symbols		Owner's manual, ecolabelling.....	23	functions.....	160
Adaptive Cruise Control.....	211			range.....	163
Collision Warning with Auto		P		Pedestrian airbag.....	42
Brake.....	222, 231	PACOS.....	33	folding up.....	43
Driver Alert Control.....	234	Paintwork		moving the car.....	43
Engine block heater and passenger		colour code.....	390	Pedestrian detection.....	223
compartment heater.....	139	damage and touch-up.....	390	Personal Car Communicator.....	163
LKA.....	239	Panel lighting.....	84	Petrol grade.....	297
Messages in BLIS.....	257	Panic function.....	160	Pocket park assist - PAP.....	248
Meters		PAP - Active Park Assist.....	248	Polishing.....	387
fuel gauge.....	61, 62	Parcel shelf.....	154	Position/parking lamps.....	85
speedometer.....	61, 62			Power guide.....	65
tachometer.....	61, 62				
misting					
attending to the windows.....	121				

Power operated roller blind for glass roof.....	103
Power seat.....	79
Powershift gearbox.....	273, 309
Power windows.....	99

Q

Queue Assist.....	205
Queue Assistant.....	205

R

Radar sensor.....	199
Limitations.....	208
Rain sensor.....	97
Rear bulbs	
location.....	365
Rear seat	
Heating.....	129
Rearview and door mirrors	
compass.....	104
door.....	101
electrically retractable.....	101
heating.....	102
interior.....	103

Rear window	
heating.....	102
Recommendations during driving.....	294
Recommended child seats	
table.....	45
Recovery.....	311
Refrigerant.....	360
Regeneration.....	300
Relay/fuse box, see Fuses.....	375
Remote control immobiliser.....	159
Remote control key.....	156, 157, 158
battery replacement.....	165
detachable key blade.....	163, 164
functions.....	160
loss.....	156
range.....	161, 166
Remote control key system, type approval.....	181
Remote control key with PCC	
range.....	163
Resetting, trip meter.....	112, 116
Resetting the door mirrors.....	101
Resetting the power windows.....	100
Retractable power door mirrors.....	101
Reverse gear inhibitor.....	268

Road sign information.....	187
Limitations.....	189
operation.....	187
Roof load, max. weight.....	396
Rustproofing.....	388

S

Safety lock	
children.....	44
Safety mode.....	40
moving the car.....	42
start attempt.....	41
Sealing fluid.....	339
Seat, see Seats.....	77
Seatbelt.....	25
loosen.....	27
pregnancy.....	27
putting on.....	26
rear seat.....	28
seatbelt reminder.....	28
seatbelt tensioner.....	28
Seatbelt reminder.....	28
Seatbelt tensioner.....	28, 39
Seats.....	77
head restraints, rear.....	80
heating.....	129

Heating.....	129	Stability and traction control system.....	183	Driver Alert Control.....	234
lowering the front backrest.....	78	Stability system.....	183	LKA.....	239
lowering the rear backrest.....	80	Stains.....	389	System	
power.....	79	Start/Stop.....	276	tripping.....	39
Securing loads (Loading).....	150	function and operation.....	277		
Self Supporting run flat Tyres (SST).....	330	the engine does not stop.....	278		
Sensus.....	74	Steering force, speed related.....	258		
Service position.....	367	Steering force level, see Steering force...	258		
Service programme.....	347	Steering lock.....	266		
Set time interval.....	213	Steering wheel.....	82		
Side airbag SIPS.....	35, 39	keypad.....	82		
SIPS airbag.....	35	steering wheel adjustment.....	82		
Skidding.....	294, 295	Stone chips and scratches.....	390		
slippery driving conditions.....	295	Storage spaces			
Soot filter.....	300	driver's side.....	145		
SOOT FILTER FULL.....	300	glovebox.....	146		
spare wheel.....	319, 320	tunnel console.....	145		
installation.....	322	Storage spaces in the passenger com-			
taking out.....	320	partment.....	143		
Speed limiter.....	189	Switching off the engine.....	266		
alarm for speed exceeded.....	192	Symbols			
deactivation.....	193	indicator symbols.....	62, 64, 66		
getting started.....	190, 191	warning symbols.....	62, 64		
temporary deactivation.....	191	Symbols and messages			
Speed ratings, tyres.....	317	Adaptive Cruise Control.....	211		
Spin control.....	183	Collision Warning with Auto			
		Brake.....	222, 231		

T

Tailgate	
Locking/unlocking.....	173
Temperature	
actual temperature.....	122
Temperature control.....	131
Total airing function.....	121, 173
Towbar	
detachable, attachment.....	305
detachable, removal.....	307
Towbar, see Towing equipment.....	304
Towbar - detachable	
attachment/removal.....	305, 307
Towing.....	309
towing eye.....	310
Towing bracket.....	304
specifications.....	305
Towing capacity and towball load.....	397
Towing eye.....	310

- TPMS - Tyre Pressure Monitoring.... 325,
326, 328
- Traction control..... 183
- Trailer..... 301
cable..... 301, 302
driving with a trailer..... 301
snaking..... 308
- Trailer stability assist..... 183
- Trailer Stability Assist..... 308
- Transmission..... 268
- Transmission oil
volume and grade..... 404
- Transponder..... 19
- Tread depth..... 318
- Tread wear indicators..... 315
- Trip computer..... 109, 114, 118, 119
analogue instrument panel..... 110
- Trip meter..... 70
- Trip meter, resetting..... 112, 116
- Troubleshooting
Adaptive Cruise Control..... 210
- TSA - trailer stability assist 183, 308
- Tunnel console..... 145
12 V socket..... 147
armrest..... 145
cigarette lighter and ashtray..... 146
- Tunnel detection..... 86
- Type approval
radar system..... 258
remote control key system..... 181
tyre pressure monitoring..... 340
- Type designations..... 393
- Tyre dimension..... 316
- Tyre load index..... 317
- Tyre pressure label..... 315
- Tyre pressure monitoring. 325, 326, 328, 331
Adjust..... 327
arming..... 329
deactivate..... 329
driveable punctured tyres (SST)..... 330
low tyre pressure..... 330
recommendations..... 329
- Tyres
direction of rotation..... 314
maintenance..... 313
pressure..... 315, 412
puncture repair..... 333
specifications..... 412
tread depth..... 318
tread wear indicators..... 315
tyre pressure monitoring..... 325, 326,
328, 331
winter tyres..... 318
- ## U
- Unlocking
from the inside..... 172
from the outside..... 170
- Unlocking with the key blade..... 169
- ## V
- Vanity mirror..... 92, 147
- Ventilation..... 125
- Vibration damper..... 304
- Volvo ID..... 20
- Volvo Sensus..... 74
- ## W
- Warning lamp
Adaptive Cruise Control..... 199
collision warning system..... 227
stability and traction control system.. 183
- Warning lamps
Airbags – SRS..... 68
alternator not charging..... 68
Fault in brake system..... 68
Low oil pressure..... 68
Parking brake applied..... 68

- seatbelt reminder..... 28, 68
 Warning..... 68
 Warning sound
 collision warning system..... 227
 Warning symbols..... 62, 64, 68
 Warning triangle..... 324
 Washer fluid
 volume..... 405
 Washer fluid, filling..... 370
 Washers
 rear window..... 98
 washer fluid, filling..... 370
 windscreen..... 98
 Water and dirt-repellent coating..... 388
 Water-repellent surface, cleaning..... 388
 Waxing..... 387
 Weights
 kerb weight..... 396
 Wheel bolts..... 318
 lockable..... 318
 Wheel rim, dimensions..... 316
 Wheel rims
 cleaning..... 387
 Wheels
 removal..... 320
 snow chains..... 318
 spare wheel..... 319
 Wheels and tyres..... 319
 Whiplash injury, WHIPS..... 37
 WHIPS
 child seat/booster cushion..... 38
 seating position..... 38
 whiplash protection..... 37, 39
 Windows, rearview and door mirrors..... 388
 Windscreen
 heating..... 102, 132
 Windscreen washing..... 98
 Windscreen wiper..... 97
 rain sensor..... 97
 Winter driving..... 294
 Winter tyres..... 318
 Wiper blades..... 367
 changing..... 368
 Cleaning..... 369
 replacing, rear window..... 369
 Service position..... 367
 Wipers and washing..... 97

