



S 80

WEB EDITION  
OWNER'S MANUAL





## DEAR VOLVO OWNER

THANK YOU FOR CHOOSING VOLVO

We hope you will enjoy many years of driving pleasure in your Volvo. The car has been designed for the safety and comfort of you and your passengers. Volvo is one of the safest cars in the world. Your Volvo has also been designed to satisfy all current safety and environmental requirements.

In order to increase your enjoyment of the car, we recommend that you familiarise yourself with the equipment, instructions and maintenance information contained in this owner's manual.





## 01 Introduction

Owner information.....	13
Reading the owner's manual.....	13
Digital owner's manual in the car.....	16
Recording data.....	18
Accessories and extra equipment.....	18
Information on the Internet.....	19
Volvo ID.....	19
Volvo Cars' environmental philosophy.....	21
The owner's manual and the environment.....	23
Laminated glass.....	23



## 02 Safety

General information on seatbelts.....	25
Seatbelt - putting on.....	26
Seatbelt - loosening.....	26
Seatbelt - pregnancy.....	27
Seatbelt reminder.....	27
Seatbelt tensioner.....	28
Safety - warning symbol.....	28
Airbag system.....	29
Driver airbag.....	30
Passenger airbag.....	31
Passenger airbag - activating/deactivating*.....	32
Side airbag (SIPS).....	34
Side airbag (SIPS) - child seat/booster cushion.....	35
Inflatable Curtain (IC).....	35
General information on WHIPS (whiplash protection).....	36
WHIPS - child seats.....	37
WHIPS - seating position.....	37
When the systems deploy.....	38
General information on safety mode.....	39
Safety mode - attempting to start the car.....	40
Safety mode - moving the car.....	41



General information on child safety.....	41
Child seats.....	42
Child seats - location.....	46
Child seat - ISOFIX.....	47
ISOFIX - size classes.....	47
ISOFIX - types of child seat.....	49
Child seats - upper mounting points.....	51



### 03 Instruments and controls

Instruments and controls, left-hand drive car - overview.....	53
Instruments and controls, right-hand drive car - overview.....	56
Combined instrument panel.....	59
Analogue combined instrument panel - overview.....	59
Digital combined instrument panel - overview.....	60
Eco guide & Power guide*.....	63
Combined instrument panel - meaning of indicator symbols.....	64
Combined instrument cluster - meaning of warning symbols.....	66
Outside temperature gauge.....	68
Trip meter.....	68
Clock.....	69
Licenses - combined instrument panel....	69
Symbols in the display.....	70
Volvo Sensus.....	73
Key positions.....	74
Key positions - functions at different levels.....	74
Seats, front.....	76
Seats, front - electrically operated*.....	77



Seats, rear.....	78
Steering wheel.....	79
Heating* of the steering wheel.....	80
Light switches.....	81
Position/parking lamps.....	83
Daytime running lights.....	83
Tunnel detection*.....	84
Main/dipped beam.....	84
Active high beam*.....	85
Active Xenon headlamps*.....	87
Rear fog lamp.....	87
Brake lights.....	88
Hazard warning flashers.....	88
Direction indicators.....	89
Interior lighting.....	90
Home safe light duration.....	91
Approach lighting.....	91
Headlamps - adjusting headlamp pattern.....	92
Wipers and washing.....	96
Power windows.....	97
Sun blind*.....	99
Door mirrors.....	99



Windows and rearview and door mirrors - heating.....	101
Rearview mirror - interior.....	101
Compass*.....	102
Sunroof*.....	103
Menu navigation - combined instrument panel.....	105
Menu overview - combined instrument panel.....	106
Messages.....	106
Messages - handling.....	107
MY CAR.....	108
Trip computer.....	109
Trip computer - analogue combined instrument panel.....	110
Trip computer - digital combined instrument panel.....	114
Trip computer - supplementary information.....	118
Trip computer - trip statistics*.....	119



## 04 Climate control

General information on climate control...	121
Actual temperature.....	122
Sensors - climate control.....	122
Air cleaning.....	122
Air cleaning - passenger compartment filter.....	123
Air cleaning - Clean Zone Interior Package (CZIP)*.....	123
Air cleaning - IAQS*.....	124
Air cleaning - material.....	124
Menu settings - climate control.....	124
Air distribution in the passenger compartment.....	125
Electronic climate control - ECC.....	127
Heated front seats*.....	128
Heated rear seat*.....	128
Ventilated front seats*.....	129
Fan.....	130
Auto-regulation.....	130
Temperature control in the passenger compartment.....	130
Air conditioning.....	131
Demisting and defrosting the wind-screen.....	131
Air distribution - recirculation.....	132



Air distribution - table.....	134
Engine and passenger compartment heater*.....	136
Engine block heater and passenger compartment heater* - direct start.....	137
Engine block heater and passenger compartment heater* - immediate stop.....	138
Engine block heater and passenger compartment heater* - timer.....	138
Engine block heater and passenger compartment heater* - messages.....	140
Additional heater*.....	142
Fuel-driven additional heater*.....	142
Electric additional heater*.....	143



## 05 Loading and storage

Storage spaces.....	145
Tunnel console.....	147
Tunnel console - cigarette lighter and ashtray*.....	147
Glovebox.....	147
Inlay mats*.....	148
Vanity mirror.....	148
Tunnel console - 12 V-sockets.....	148
Loading.....	149
Loading - long load.....	150
Loading - ski hatch.....	151
Roof load.....	151
Load retaining eyelets.....	152
Loading - bag holder*.....	152
12 V electrical socket, cargo area*.....	153

**06 Locks and alarm**

Remote control key.....	155
Remote control key - losing .....	155
Remote control key - personalisation*....	156
Locking/unlocking - indicator.....	157
Immobiliser.....	157
Remote-controlled immobiliser with tracking system.....	158
Remote control key - functions.....	158
Remote control key - range.....	160
Remote control key with PCC* - unique functions.....	160
Remote control key with PCC* - range...	161
Detachable key blade.....	162
Detachable key blade - detaching/ attaching.....	162
Detachable key blade - unlocking doors	163
Privacy locking*.....	163
Remote control key - replacing the battery.....	165
Keyless drive*.....	166
Keyless Drive* - remote control key range.....	166
Keyless drive* - secure handling of the remote control key.....	167



Keyless drive* - interference to remote control key function.....	168
Keyless drive* - locking.....	168
Keyless drive* - unlocking.....	169
Keyless drive* - unlocking with the key blade .....	169
Keyless Drive* - lock settings.....	170
Keyless Drive* - antenna location.....	170
Locking/unlocking - from the outside....	171
Locking/unlocking - from the inside.....	171
Total airing function.....	172
Locking/unlocking - glovebox.....	172
Locking/unlocking - boot lid.....	173
Deadlocks*.....	174
Child safety locks - manual activation....	175
Child safety locks - electrical activation*	175
Alarm.....	176
Alarm indicator.....	177
Alarm - automatic re-arming.....	177
Alarm - remote control key not working.	178
Alarm signals.....	178
Reduced alarm level.....	178
Type approval - remote control key system.....	179

**07 Driver support**

Active chassis - Four C*.....	181
Electronic stability control (ESC) - general.....	181
Electronic stability control (ESC) - operation.....	182
Electronic stability control (ESC) - symbols and messages.....	183
Road Sign Information (RSI)*.....	185
Road sign information (RSI)* - operation	185
Road sign information (RSI)* - limitations	187
Cruise control*.....	188
Cruise control* - managing speed.....	188
Cruise control* temporary deactivation and standby mode.....	189
Cruise control* - resume set speed.....	190
Cruise control* - deactivate.....	190
Adaptive cruise control - ACC*.....	190
Adaptive cruise control* - function.....	191
Adaptive cruise control* - overview.....	193
Adaptive cruise control* - managing speed.....	194
Adaptive cruise control* - set time interval.....	195
Adaptive cruise control* - temporary deactivation, and standby mode.....	195



# Table of contents



Adaptive cruise control* - overtaking another vehicle.....	196
Adaptive cruise control* - deactivate.....	197
Adaptive Cruise Control* - queue assistance.....	197
Adaptive cruise control* - switch cruise control functionality.....	199
Radar sensor.....	199
Radar sensor - limitations.....	200
Adaptive cruise control* - fault tracing and action.....	202
Adaptive cruise control* - symbols and messages.....	203
Distance Warning*.....	205
Distance Warning* - limitations.....	206
Distance Warning* - symbols and messages.....	207
City Safety™.....	208
City Safety™ - function.....	208
City Safety™ - operation.....	209
City Safety™ - limitations.....	210
City Safety™ - laser sensor.....	212
City Safety™ - symbols and messages..	214
Collision warning system*.....	215
Collision warning system* - function.....	216



Collision warning system* - detection of cyclists.....	217
Collision warning system* - detection of pedestrians.....	218
Collision warning system* - operation....	219
Collision warning system* - limitations...	220
Collision warning system* - camera sensor limitations.....	221
Collision warning system* - symbols and messages.....	223
Driver Alert System*.....	225
Driver Alert Control (DAC)*.....	225
Driver Alert Control (DAC)* - operation...	226
Driver Alert Control (DAC)* - symbols and messages.....	227
Lane Departure Warning (LDW)*.....	229
Lane Departure Warning (LDW) - function.....	229
Lane Departure Warning (LDW) - operation.....	230
Lane Departure Warning (LDW) - limitations.....	231
Lane Departure Warning (LDW) - symbols and messages.....	232
Park Assist*.....	234
Park assist syst* - function.....	234



Park assist syst* - backward.....	235
Park assist syst* - forward.....	236
Park assist syst* - fault indication.....	237
Park assist syst* - cleaning the sensors..	237
Park assist camera*.....	238
Park assist camera - settings.....	240
Park assist camera - limitations.....	241
BLIS*.....	241
BLIS* - operation.....	242
BLIS - symbols and messages.....	244
Adjustable steering force*.....	245
Type approval - radar system.....	245





## 08 Starting and driving

Alcolock*	247
Alcolock* - functions and operation.....	247
Alcolock* - storage.....	248
Alcolock* - before starting the engine....	248
Alcolock* - to bear in mind.....	250
Alcolock* - symbols and text messages.	251
Starting the engine.....	252
Switching off the engine.....	253
Steering lock.....	253
Remote start (ERS)*.....	254
Remote start (ERS) - operation.....	254
Remote start (ERS) - symbols and messages.....	256
Starting the engine – Flexifuel.....	257
Jump starting with battery.....	258
Gearboxes.....	259
Manual gearbox.....	260
Gear shift indicator*.....	260
Automatic gearbox -- Geartronic*.....	261
Automatic gearbox -- Powershift*.....	265
Gear selector inhibitor.....	267
Hill start assist (HSA)*.....	268
Start/Stop*.....	268
Start/Stop* - function and operation.....	269



Start/Stop* - the engine does not stop...	271
Start/Stop* - the engine auto-starts.....	272
Start/Stop* - the engine does not auto-start.....	273
Start/Stop* - involuntary stop manual gearbox.....	274
Start/Stop* - settings.....	274
Start/Stop* - symbols and messages....	275
ECO*.....	277
All Wheel Drive - AWD*.....	279
Foot brake.....	279
Foot brake - anti-lock braking system....	280
Foot brake - emergency brake lights and automatic hazard warning flashers.....	280
Foot brake - emergency brake assistance.....	281
Parking brake.....	282
Fording.....	286
Overheating.....	286
Driving with open tailgate.....	287
Overload - starter battery.....	287
Before a long journey.....	288
Winter driving.....	288
Fuel filler flap - Opening/closing.....	289
Fuel filler flap - manual opening.....	289



Filling up with fuel.....	289
Fuel - handling.....	290
Fuel - petrol.....	291
Fuel - diesel.....	291
Catalytic converters.....	293
Fuel - bioethanol E85.....	293
Diesel particle filter (DPF).....	294
Economical driving.....	295
Driving with a trailer.....	296
Driving with a trailer - manual gearbox...	297
Driving with a trailer - automatic gearbox	297
Towing bracket/Towbar.....	298
Detachable towbar - storage.....	298
Detachable towbar - specifications.....	298
Detachable towbar - attachment/removal.....	299
Towing.....	301
Towing eye.....	303
Recovery.....	304



## 09 Wheels and tyres

Tyres - direction of rotation.....	306
Tyres - maintenance.....	306
Tyres - tread wear indicators.....	308
Wheel bolts.....	308
Tools.....	308
Jack*.....	309
Winter tyres.....	309
Wheel and wheel rim dimensions.....	310
Tyres - dimensions.....	310
Tyres - load index.....	311
Tyres - speed ratings.....	311
Changing wheels - removing wheels.....	312
Changing wheels - fitting.....	314
Tyres - air pressure.....	315
Warning triangle.....	316
First aid kit*.....	317
Tyre pressure monitoring*.....	317
TPMS (Tyre Pressure Monitoring System)* - general.....	318
TPMS (Tyre Pressure Monitoring System)* - adjusting (recalibration).....	319
TPMS (Tyre Pressure Monitoring System)* - status.....	320
TPMS (Tyre Pressure Monitoring System)* - activate/deactivate.....	321



TPMS (Tyre Pressure Monitoring System)* - recommendations.....	321
TPMS (Tyre Pressure Monitoring System)* - driveable punctured tyres*....	322
TPMS (Tyre Pressure Monitoring System)* - rectifying low tyre pressure...	322
TM (Tyre Monitor)*.....	323
Emergency puncture repair*.....	325
Emergency puncture repair kit* - location.....	325
Emergency puncture repair kit* - overview.....	326
Emergency puncture repair* - operation.....	327
Emergency puncture repair* - rechecking.....	328
Emergency puncture repair kit* - inflating the tyres.....	329
Emergency puncture repair kit* - sealant.....	330
Type approval - tyre pressure monitoring.....	331



## 10 Maintenance and service

Volvo service programme.....	338
Book service and repair*.....	338
Raising the car.....	341
Bonnet - opening and closing.....	343
Engine compartment - overview.....	343
Engine compartment - checking.....	344
Engine oil - general.....	345
Engine oil - checking and filling.....	346
Coolant - level.....	349
Brake and clutch fluid - level.....	350
Power steering fluid - level.....	351
Climate control system - fault tracing and repair.....	352
Lamp replacement.....	352
Lamp replacement - headlamps.....	353
Lamp replacement - cover for main/dipped beam bulbs.....	354
Lamp replacement - dipped beam.....	354
Lamp replacement - main beam.....	355
Lamp replacement - extra main beam....	355
Lamp replacement - direction indicators front.....	355
Lamp replacement - rear lamp.....	356
Lamp replacement - location of rear lamps.....	356



Lamp replacement - number plate lighting.....	357
Lamp replacement - lighting in cargo area.....	357
Lamp replacement - vanity mirror lighting.....	358
Lamps - specifications .....	358
Wiper blades.....	359
Washer fluid - filling.....	361
Starter battery - general.....	361
Battery - symbols.....	363
Starter battery - replacement.....	363
Battery - Start/Stop.....	365
Electrical system.....	367
Fuses - general.....	367
Fuses - in engine compartment.....	369
Fuses - under glovebox.....	373
Fuses - in the control module under the glovebox.....	375
Fuses - in cargo area.....	377
Fuses - in the engine compartment's cold zone.....	378
Car washing.....	380
Polishing and waxing.....	381
Water and dirt-repellent coating.....	382

Rustproofing.....	382
Cleaning the interior.....	382
Paint damage.....	384

<div style="border: 1px solid white; border-radius: 50%; width: 20px; height: 20px; display: flex; align-items: center; justify-content: center; margin: 0 auto;"> <span style="font-size: 8px; line-height: 1;">01 10 00 11</span> </div>	
<b>11 Specifications</b>	
Type designations.....	387
Dimensions.....	390
Weights.....	391
Towing capacity and towball load.....	392
Engine specifications.....	395
Engine oil - adverse driving conditions...	396
Engine oil - grade and volume.....	397
Coolant - grade and volume.....	399
Transmission fluid - grade and volume...	400
Brake fluid - grade and volume.....	402
Power steering fluid - grade.....	402
Washer fluid - quality and volume.....	402
Fuel tank - volume.....	403
Fuel consumption and CO2 emissions...	404
Tyres - approved tyre pressures.....	407



## 12 Alphabetical Index

Alphabetical Index.....	410
-------------------------	-----

12



# 01



## INTRODUCTION



## Owner information

Your car is equipped with a screen where you can find information about how your car works (applies to certain car models). For cars with owner information in the screen, the printed owner's manual is a supplement and contains important text, the latest updates, as well as instructions that can be useful when, for practical reasons, you are unable to read the information on the screen.

Changing the screen's language may mean that certain information is no longer in accordance with national or local laws and regulations.

### ! IMPORTANT

The driver is always responsible that the vehicle is driven safely in traffic and that applicable laws and regulations are followed. It is also important that the car is maintained and handled in accordance with Volvo's recommendations in the owner's information.

If there should be a difference between the information on the screen and in the printed manual then it is always the printed information that applies.

## Reading the owner's manual

A good way of getting to know your new car is to read the owner's manual, ideally before your first journey. This will give you the opportunity to familiarise yourself with new functions, to see how best to handle the car in different situations, and to make the best use of all the car's features. Please pay attention to the safety instructions contained in the manual.

The specifications, design features and illustrations in the owner's manual are not binding. We reserve the right to make modifications without prior notice.

© Volvo Car Corporation

## Owner's Manual in mobile devices



### i NOTE

The owner's manual is available for download as a mobile application (applies for certain car models and mobile devices), see [www.volvocars.com](http://www.volvocars.com).

The mobile application also includes video and searchable content and easy navigation between different sections.

## Options/accessories

All types of option/accessory are marked with an asterisk\*.

In addition to standard equipment, the owner's manual also describes options (factory fitted equipment) and certain accessories (retrofitted extra equipment).

The equipment described in the owner's manual is not available in all cars - they have different equipment depending on adaptations for the needs of different markets and national or local laws and regulations.

In the event of uncertainty over what is standard or an option/accessory, contact a Volvo dealer.

## Special texts

### ! WARNING

Warning texts appear if there is a risk of injury.

\* Option/accessory, for more information, see Introduction.



# 01 Introduction

01



## ! IMPORTANT

"Important" texts appear if there is a risk of damage.

## i NOTE

NOTE texts give advice or tips that facilitate the use of e.g. features and functions.

### Footnote

There is footnote information in the owner's manual that is located at the bottom of the page. This information is an addition to the text that it refers to via a number. If the footnote refers to text in a table then letters are used instead of numbers for referral.

### Message texts

There are displays in the car that show text messages. These text messages are highlighted in the owner's manual by means of the text being slightly larger and printed in grey. Examples of this are in menu texts and message texts on the information display (e.g. **Audio settings**).

### Decals

The car contains different types of decal which are designed to convey important information in a simple and clear manner. The decals in the car have the following descending degree of importance for the warning/information.

### Warning for personal injury



Black ISO symbols on yellow warning field, white text/image on black message field. Used to indicate the presence of danger which, if the warning is ignored, may result in serious personal injury or fatality.

### Risk of property damage

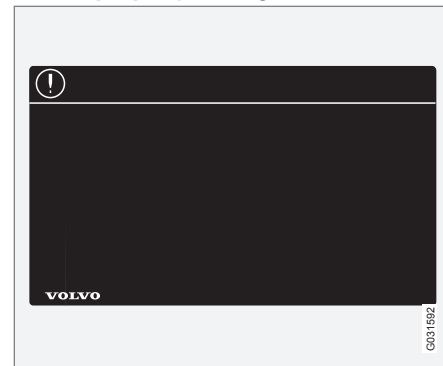

White ISO symbols and white text/image on black or blue warning field and message field. Used to indicate the presence of danger which, if the warning is ignored, may result in damage to property.



## Information

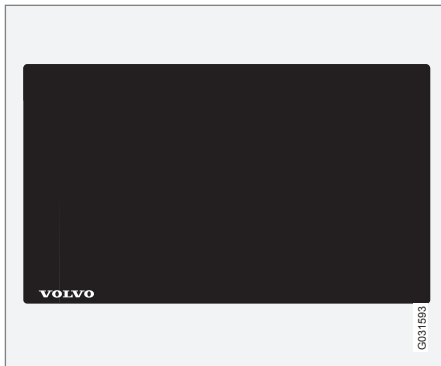

White ISO symbols and white text/image on black message field.

### **i** NOTE

It is not intended that the decals illustrated in the owner's manual should be exact replicas of those in the car. They are included to show their approximate appearance and location in the car. The information that applies to your particular car is available on the respective decals for your car.

## Procedure lists

Procedures where action must be taken in a certain sequence are numbered in the owner's manual.

**1** When there is a series of illustrations for step-by-step instructions each step is numbered in the same way as the corresponding illustration.

**A** There are numbered lists with letters adjacent to the series of illustrations where the order of the instructions is not significant.

**➔** Arrows appear numbered and unnumbered and are used to illustrate a movement.

**A➔** Arrows with letters are used to clarify a movement when the reciprocal order is of no relevance.

If there is no series of illustrations for step-by-step instructions then the different steps are numbered with normal numbers.

## Position lists

**1** Red circles containing a number are used in overview images where different components are pointed out. The number recurs in the position list featured in connection with the illustration that describes the item.

## Bulleted lists

A bulleted list is used when there is a list of points in the owner's manual.

Example:

- Coolant
- Engine oil

## Related information

Related information refers to other sections containing related information.

## Images

The manual's images are sometimes schematic and may deviate from the car's appearance depending on equipment level and market.

## To be continued

▶▶ This symbol is located furthest down to the right when an article continues on the following page.

## Continued from previous page

◀◀ This symbol is located furthest up to the left when an article continues from the previous page.

## Related information

- The owner's manual and the environment (p. 23)
- Information on the Internet (p. 19)



# 01 Introduction

01

## Digital owner's manual in the car

The owner's manual can be read on the screen in the car<sup>1</sup>. The content is searchable and it is easy to navigate between different sections.

Open the digital owner's manual - press the **MY CAR** button in the centre console, press **OK/MENU** and select **Owner's manual**.

For basic navigation, see Operating the system. See below for a more detailed description.

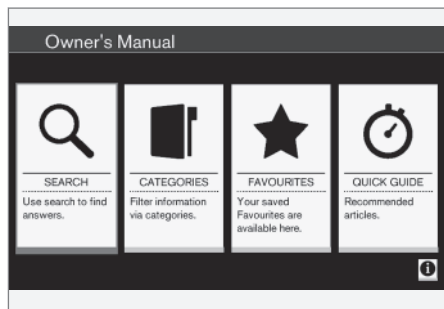

Owner's manual, start page.

There are four options for finding information in the owner's manual:

- **Search** - Search function for finding an article.
- **Categories** - All articles sorted into categories.
- **Favourites** - Quick access to favourite-bookmarked articles.
- **Quick Guide** - A selection of articles for common functions.

Select the information symbol in the lower right-hand corner in order to obtain information about the digital owner's manual.



### NOTE

The owner's manual is not available while driving.

## Search

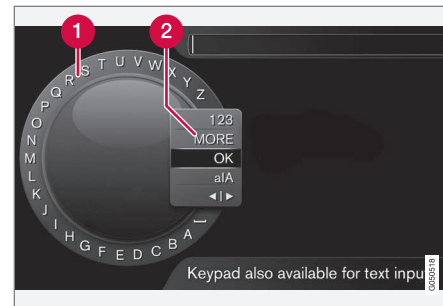

Searching using the daisy wheel.

- 1 Character list.
- 2 Changing the input mode (see following table).

Use the daisy wheel to enter a search term, e.g. "seatbelt".

1. Turn **TUNE** to the desired letter, press **OK/MENU** to confirm. The number and letter buttons on the control panel in the centre console can also be used.
2. Continue with the next letter and so on.

<sup>1</sup> Applies to certain car models.



3. To change the input mode to numbers or special characters, or to perform a search, turn **TUNE** to one of the options (see explanation in the following table) in the list for changing the input mode (2), press **OK/MENU**.

123/ABC	Change between letters and numbers with <b>OK/MENU</b> .
MORE	Change to special characters with <b>OK/MENU</b> .
OK	Perform the search. Turn <b>TUNE</b> to select a search result article, press <b>OK/MENU</b> to go to the article.
a A	Changes between lowercase and uppercase letters with <b>OK/MENU</b> .
◀ ▶	Changes from the text wheel to the search field. Move the cursor with <b>TUNE</b> . Delete any misspelling with <b>EXIT</b> . To return to the text wheel, press <b>OK/MENU</b> .  Note that the digit and letter buttons on the control panel can be used for editing in the search field.

### Categories

The articles in the owner's manual are structured into main categories and subcategories. The same article can be in several appropriate categories in order to be found more easily.

Turn **TUNE** to navigate in the category tree and press **OK/MENU** to open a category - selected - or article - selected . Press **EXIT** to go back to the previous view.

### Favourites

Located here are the articles that are saved as favourites. To select an article as a favourite, see the heading "Navigating in an article" below.

Turn **TUNE** to navigate in the favourite list and press **OK/MENU** to open an article. Press **EXIT** to go back to the previous view.

### Quick Guide

Located here is a selection of articles for getting to know the car's most common functions. The articles can also be accessed via categories, but are collected here for quick access.

Turn **TUNE** to navigate in the Quick Guide and press **OK/MENU** to open an article. Press **EXIT** to go back to the previous view.

### Navigating in an article

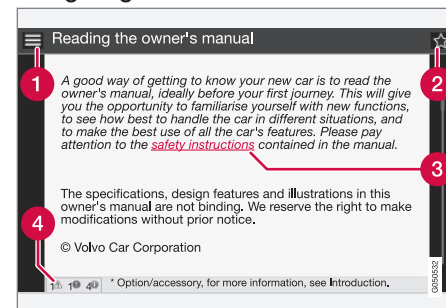

- 1 Home** - leads to the start page for the owner's manual.
- 2 Favourite** - adds/removes an article as a favourite. You can also press the **FAV** button in the centre console to add/remove an article as a favourite.
- 3 Highlighted link** - leads to linked article.
- 4 Special texts** - if the article contains warnings, important or note texts then an associated symbol is shown here as well as the number of such texts in the article.

Turn **TUNE** to navigate between the links or scroll in an article. When the screen has scrolled to the start/end of an article the home and favourite options are accessed by scrolling a further step up/down. Press **OK/MENU** to activate the selection/highlighted link. Press **EXIT** to go back to the previous view.

## Recording data

*Certain information about the vehicle's operation and functionality, and any incidents, are recorded in the car.*

Your vehicle contains a number of computers whose function is to continuously check and monitor the vehicle's operation and functionality. Some of the computers can record information during normal driving if they detect an error. In addition, information is recorded in the event of a collision or incident. Parts of the recorded information are required so that technicians can diagnose and rectify faults in the vehicle during servicing and maintenance and so that Volvo can fulfil legal requirements and other regulations. In addition to this, the information is used for research purposes by Volvo in order to continually develop quality and safety, as the information can contribute to a better understanding of the factors that cause accidents and injuries. The information includes details of the status and functionality of various systems and modules in the vehicle with regard to engine, throttle, steering and brake systems, amongst other things. This information may include details regarding the way the driver drives the vehicle, such as vehicle speed, brake and accelerator pedal use, steering wheel movement and whether or not the driver and passengers have used their seatbelts. For the reasons given this information may be stored in the vehicle's computers

for a certain length of time, but also as a result of a collision or incident. This information may be stored by Volvo as long as it can help to further develop and further enhance safety and quality and as long as there are legal requirements and other regulations that Volvo needs to consider.

Volvo will not contribute to the above-described information being disclosed to third parties without the vehicle owner's consent. However, due to national legislation and regulations Volvo may be required to disclose such information to authorities such as police authorities, or others who may assert a legal right to have access to it.

To be able to read and interpret the information recorded by the computers in the vehicle requires special technical equipment that Volvo, and workshops that have entered into agreements with Volvo, have access to. Volvo is responsible that the information, which is transferred to Volvo during servicing and maintenance, is stored and handled in a secure manner and that the handling complies with applicable legal requirements. For further information - contact a Volvo dealer.

## Accessories and extra equipment

*The incorrect connection and installation of accessories and extra equipment can negatively affect the car's electronic system.*

Certain accessories only function when associated software is installed in the car's computer system. Volvo therefore recommends that you always contact an authorised Volvo workshop before installing accessories or extra equipment which are connected to or affect the electrical system.

### Heat-reflecting windscreen\*

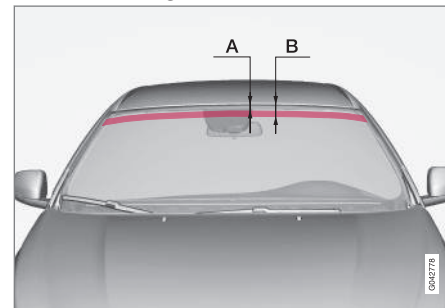

Areas where IR film is not applied.

	Dimensions
A	47 mm
B	87 mm

The windscreen is equipped with a heat-reflecting film (IR) that reduces the solar heat radiation into the passenger compartment.

The positioning of electronic equipment, such as a transponder, behind a glass surface with heat-reflecting film may affect its function and performance.

For the optimal function of electronic equipment, it should be positioned on the part of the windscreen with no heat-reflecting film (see the highlighted area in the above illustration).

### Information on the Internet

*At [www.volvocars.com](http://www.volvocars.com) there is further information concerning your car.*

*With a personal Volvo ID it is possible to log in to My Volvo web, which is a personal web page for you and your car.*



QR code

A QR code reader is required to read the QR code, which is available as a supplemental program (app) for several mobile phones. The QR code reader can be downloaded from e.g. App Store, Windows Phone or Google Play.

### Volvo ID

*Volvo ID is your personal ID that provides access to various services<sup>2</sup>.*

Examples of services:

- My Volvo - Your personal web page for you and your car.
- In an Internet-connected car\* - Certain functions and services require that you have registered your car to a personal Volvo ID, for example to be able to send a new address from a map service on the Internet directly to the car.
- Volvo On Call, VOC\* - Volvo ID is used when logging in to the Volvo On Call mobile app.



#### NOTE

Old login accounts must be upgraded to Volvo ID in order to continue using these services.

### Advantages of Volvo ID

- One user name and one password to access online services, i.e. only one user-name and one password to remember.
- When changing the username/password for a service (e.g. VOC) it will also be changed automatically for other services (e.g. My Volvo)

<sup>2</sup> The services available may vary over time and vary depending on equipment level and market.



## Create a Volvo ID

To create a Volvo ID you need to enter your personal e-mail address and follow the instructions in the e-mail message received in order to complete the registration. It is possible to create a Volvo ID via one of the following services:

- My Volvo web - Enter your e-mail address and follow the instructions.
- For an Internet-connected car\* - Enter your e-mail address in the app that requires Volvo ID and follow the instructions. Alternatively, press the Connect button  in the centre console and select **Apps**, **SETUP** and follow the instructions.
- Volvo On Call, VOC\* - Download the latest version of the VOC app. Choose to create a Volvo ID from the start page and follow the instructions.

## Related information

- Information on the Internet (p. 19)

**Volvo Cars' environmental philosophy**

Your Volvo complies with strict international environmental standards and is also manufac-

*tured in one of the cleanest and most resource-efficient plants in the world.*



Environmental care is one of Volvo Car Corporation's core values which influence all operations. We also believe that our customers share our consideration for the environment.

Your Volvo complies with strict international environmental standards and is also manufactured in one of the cleanest and most resource-efficient plants in the world. Volvo Car Corporation has global ISO certification, which includes the environmental standard ISO 14001 covering all factories and several of our other units. We also set requirements

for our partners so that they work systematically with environmental issues.

**Fuel consumption**

Volvo cars have competitive fuel consumption in each of their respective classes. Lower fuel consumption generally results in lower emission of the greenhouse gas, carbon dioxide.

It is possible for the driver to influence fuel consumption. For more information read under the heading, **Reducing environmental impact.**

**Efficient emission control**

Your Volvo is manufactured following the concept "Clean inside and out" – a concept that encompasses a clean interior environment as well as highly efficient emission control. In many cases the exhaust emissions are well below the applicable standards.

**Clean air in the passenger compartment**

A passenger compartment filter prevents dust and pollen from entering the passenger compartment via the air intake.



A sophisticated air quality system, IAQS\* (Interior Air Quality System) ensures that the incoming air is cleaner than the air in the traffic outside.

The system consists of an electronic sensor and a carbon filter. The incoming air is monitored continuously and if there is an increase in the level of certain unhealthy gases such as carbon monoxide then the air intake is closed. Such a situation may arise in heavy traffic, queues and tunnels for example.

The entry of nitrous oxides, ground-level ozone and hydrocarbons is prevented by the carbon filter.

## Interior

The interior of a Volvo is designed to be pleasant and comfortable, even for people with contact allergies and for asthma sufferers. Extreme attention has been given to choosing environmentally-compatible materials.

## Volvo workshops and the environment

Regular maintenance creates the conditions for a long service life and low fuel consumption for your car. In this way you contribute to a cleaner environment. When Volvo's workshops are entrusted with the service and maintenance of your car it becomes part of our system. Volvo makes clear demands regarding the way in which our workshops are designed in order to prevent spills and discharges into the environment. Our workshop staff have the knowledge and the tools

required to guarantee good environmental care.

## Reducing environmental impact

You can easily help reduce environmental impact - here are a few tips:

- Avoid letting the engine idle - switch off the engine when stationary for longer periods. Pay attention to local regulations.
- Drive economically - think ahead.
- Perform service and maintenance in accordance with the owner's manual's instructions - follow the intervals recommended in the Service and Warranty Booklet.
- If the car is equipped with an engine block heater\*, use it before starting from cold - it improves starting capacity and reduces wear in cold weather and the engine reaches normal operating temperature more quickly, which lowers consumption and reduces emissions.
- High speed increases consumption considerably due to increased wind resistance - a doubling of speed increases wind resistance 4 times.
- Always dispose of environmentally hazardous waste, such as batteries and oils, in an environmentally safe manner. Consult a workshop in the event of uncertainty about how this type of waste should be discarded - an authorised Volvo workshop is recommended.

Following this advice can save money, the planet's resources are saved, and the car's durability is extended. For more information and further advice, see Eco guide (p. 63), Economical driving (p. 295) and Fuel consumption (p. 404).

## Recycling

As a part of Volvo's environmental work, it is important that the car is recycled in an environmentally sound manner. Almost all of the car can be recycled. The last owner of the car is therefore requested to contact a dealer for referral to a certified/approved recycling facility.

## Related information

- The owner's manual and the environment (p. 23)





## The owner's manual and the environment

The paper pulp in a printed owner's manual comes from FSC® certified forests or other controlled sources.

The Forest Stewardship Council® symbol shows that the paper pulp in a printed owner's manual comes from FSC® certified forests or other controlled sources.

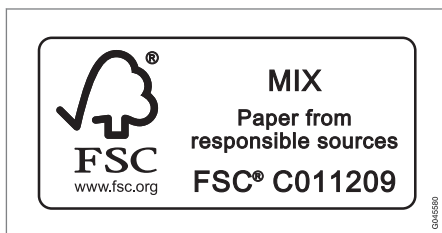

## Related information

- Volvo Cars' environmental philosophy (p. 21)

## Laminated glass

### Laminated glass



The glass is reinforced which provides better protection against break-ins and improved sound insulation in the passenger compartment. The windscreen and the side windows\* have laminated glass.

\* Option/accessory, for more information, see Introduction.

# 02

## SAFETY

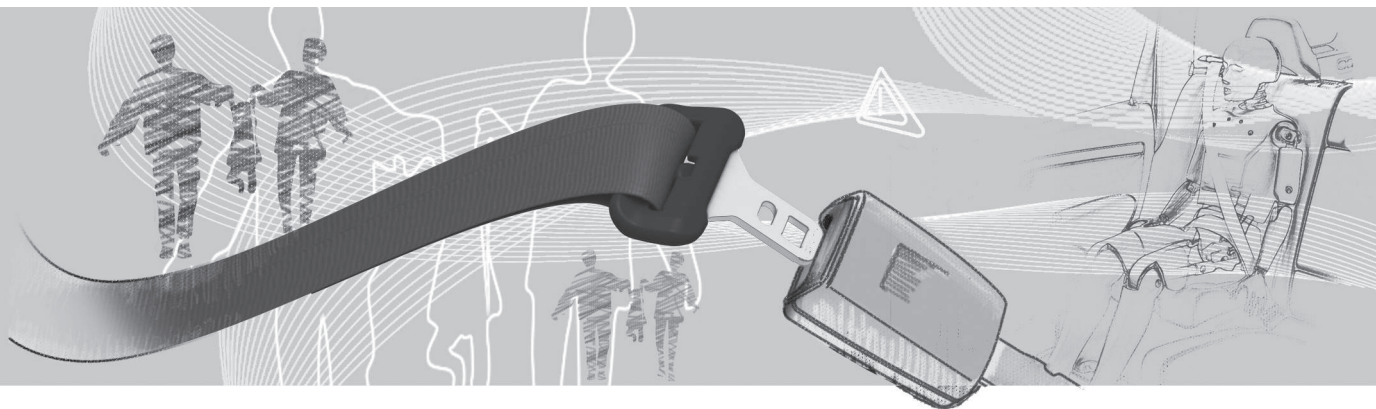



## General information on seatbelts

Heavy braking can have serious consequences if the seatbelts are not used. Ensure that all passengers are using their seatbelts during the journey.

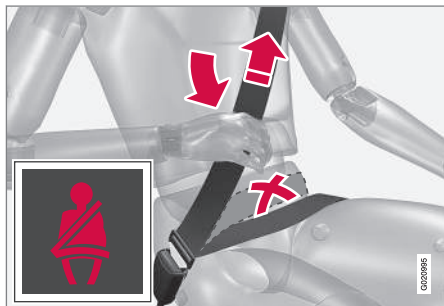

Tension the hip strap over the lap by pulling the diagonal shoulder belt up towards the shoulder. The hip strap must be positioned low down (not over the abdomen).

It is important that the seatbelt lies against the body so it can provide maximum protection. Do not lean the backrest too far back. The seatbelt is designed to protect in a normal seating position.

Unbelted occupants will be reminded to fasten their (p. 26) seatbelt by means of an audio and visual reminder (p. 27).

## Remember

- Do not use clips or anything else that can prevent the seatbelt from fitting properly.
- The seatbelt must not be twisted or caught on anything.

### WARNING

The seatbelts and airbags interact. If a seatbelt is not used or is used incorrectly, this may diminish the protection provided by the airbag in the event of a collision.

### WARNING

Each seatbelt is designed for only one person.

### WARNING

Never modify or repair the seatbelts yourself. Volvo recommends that you contact an authorised Volvo workshop.

If a seatbelt has been subjected to a major load, such as in conjunction with a collision, the entire seatbelt must be replaced. Some of the protective characteristics of the seatbelt may have been lost, even if it appears to be undamaged. In addition, replace the seatbelt if the belt is worn or damaged. The new seatbelt must be type-approved and intended for installation in the same position as the replaced seatbelt.

## Related information

- Seatbelt - pregnancy (p. 27)
- Seatbelt - loosening (p. 26)
- Seatbelt tensioner (p. 28)



### Seatbelt - putting on

Put on the seatbelt (p. 25) before driving starts.

Pull the belt out slowly and secure it by pressing its locking tab into the seatbelt buckle. A loud "click" indicates that the belt has locked.



Correctly fitted seatbelt.

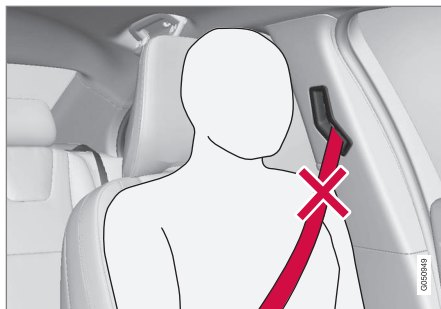

Incorrectly fitted seatbelt. The belt must rest on the shoulder.

The buckles only fit the intended lock in the rear seat<sup>1</sup>.

### Remember

The seatbelt locks and cannot be withdrawn:

- if it is pulled out too quickly
- during braking and acceleration
- if the car leans heavily.

### Related information

- Seatbelt - pregnancy (p. 27)
- Seatbelt - loosening (p. 26)
- Seatbelt tensioner (p. 28)
- Seatbelt reminder (p. 27)

### Seatbelt - loosening

Loosen the seatbelt (p. 25) when the car is stationary.

Press the red button on the seatbelt buckle and then let the belt retract. If the seatbelt does not retract fully, feed it in by hand so that it does not hang loose.

### Related information

- Seatbelt - putting on (p. 26)
- Seatbelt reminder (p. 27)

<sup>1</sup> Certain markets.



## Seatbelt - pregnancy

Seatbelt (p. 25) must always be worn during pregnancy. But it is crucial that it be worn in the correct way.



The diagonal section should wrap over the shoulder then be routed between the breasts and to the side of the abdomen.

The lap section should lay flat over the thighs and as low as possible under the abdomen. – It must never be allowed to ride upward. Remove the slack from the seatbelt and ensure that it fits as close to the body as possible. In addition, check that there are no twists in the seatbelt.

As the pregnancy progresses, pregnant drivers must adjust the seat (p. 76) and steering wheel (p. 79) such that they can easily maintain control of the vehicle as they drive (which means that they must be able to easily operate the foot pedals and steering wheel).

The aim should be to position the seat with as large a distance as possible between abdomen and steering wheel.

### Related information

- Seatbelt - putting on (p. 26)
- Seatbelt - loosening (p. 26)

## Seatbelt reminder

Unbelted occupants will be reminded to fasten their (p. 26) seatbelt by means of an audio and visual reminder.



The audio reminder is speed dependent, and in some cases time dependent. The visual reminder is located in the roof console and in the combined instrument panel (p. 59).

Child seats are not covered by the seatbelt reminder system.

### Rear seat

The seatbelt reminder in the rear seat has two subfunctions:

- Provides information on which seatbelts (p. 25) are being used in the rear seat. A message appears in the combined instrument panel when the seatbelts are in use, or if one of the rear doors has been opened. The message is cleared auto-



matically after driving for approximately 30 seconds or after pressing the indicator stalk **OK** button (p. 105).

- Provides a warning if one of the rear seatbelts is unfastened during travel. This warning takes the form of a message in the combined instrument panel along with the audio/visual signal. The warning stops when the seatbelt is re-fastened, or it can also be acknowledged manually by pressing the **OK** button.

The message in the combined instrument panel showing which seatbelts are in use is always shown. Press the **OK** button to see stored messages.

### Certain markets

An acoustic signal and indicator lamp remind the driver and front seat passenger to use a seatbelt if either of them is not wearing one. At low speed, the audible reminder will sound for the first 6 seconds.

### Seatbelt tensioner

*All the seatbelts (p. 25) are equipped with belt tensioners. A mechanism in the seatbelt tensioner tightens the seatbelt in the event of a sufficiently violent collision. The seatbelt then provides more effective restraint for the occupants.*

#### **WARNING**

Never insert the tongue of the passenger's seatbelt into the buckle on the driver's side. Always insert the tongue of the seatbelt into the buckle on the correct side. Do not make any damages on seatbelts nor insert any foreign objects into a buckle. The seatbelts and buckles would then possibly not function as intended in the event of a collision. There is a risk of serious injury.

### Safety - warning symbol

*The warning symbol is shown if a fault is detected during fault tracing or if a system has been activated. Where required, the warning symbol is shown together with a message in the combined instrument panel (p. 59) information display.*

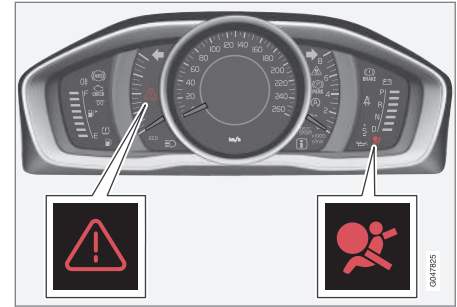

*Warning triangle and warning symbol for the air-bag system (p. 29) in the analogue combined instrument panel.*

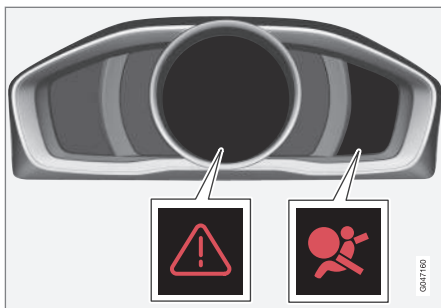

Warning triangle and warning symbol for the airbag system in the digital combined instrument panel.

The warning symbol in the combined instrument panel illuminates when the remote control key is in key position II (p. 74). The symbol is extinguished after approx. 6 seconds provided the airbag system is fault-free.

### **WARNING**

If the warning symbol for the airbag system remains illuminated or illuminates while driving, it means that the airbag system does not have full functionality. The symbol indicates a fault in the seatbelt tensioner system, SIPS, the IC system or some other fault in the system. Volvo recommends that you contact an authorised Volvo workshop immediately.

If the warning symbol malfunctions, the warning triangle illuminates and **SRS airbag**

**Service required or SRS airbag Service urgent** appears in the display. Volvo recommends that you contact an authorised Volvo workshop immediately.

### Related information

- General information on safety mode (p. 39)

### Airbag system

In the event of a frontal collision the airbag system helps to protect the head, face and chest of the driver and passenger.

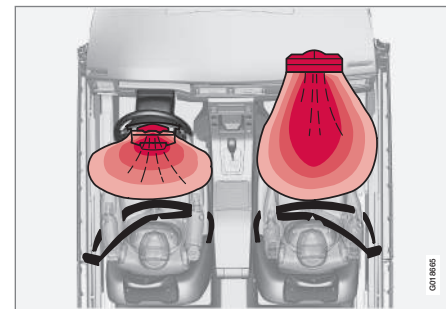

Airbag system viewed from above, left-hand drive car.

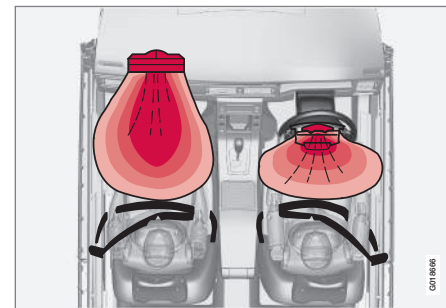

Airbag system viewed from above, right-hand drive car.



The system consists of airbags and sensors. A sufficiently violent collision trips the sensors and the airbag(s) are inflated and become hot. The airbag cushions the initial collision impact for the occupant. The airbag deflates when compressed by the collision. When this occurs, smoke escapes into the car. This is completely normal. The entire process, including inflation and deflation of the airbag, occurs within tenths of a second.

### WARNING

Volvo recommends that you contact an authorised Volvo workshop for repair. Defective work in the airbag system could cause malfunction and result in serious personal injury.

### NOTE

The detectors react differently depending on the nature of the collision and whether or not the seatbelts are fastened. Applies to all belt positions.

It is therefore possible that only one (or none) of the airbags may inflate in a collision. The detectors sense the force of the collision on the vehicle and the action is adapted accordingly so that one or more airbags are deployed.

### Related information

- Driver airbag (p. 30)
- Passenger airbag (p. 31)

- Safety - warning symbol (p. 28)

### Driver airbag

*To supplement the protection afforded by the seatbelt (p. 25) the car is equipped on the driver's side with an airbag (p. 29).*

This airbag is fitted into the centre of the steering wheel. The steering wheel is marked **AIRBAG**.

### WARNING

The seatbelts and airbags interact. If the belt is not used or is used incorrectly, this may diminish the protection provided by the airbag in the event of a collision.

### Related information

- Passenger airbag (p. 31)





## Passenger airbag

To supplement the protection afforded by the seatbelt (p. 25) on the passenger side, the car is equipped with an airbag (p. 29).

The airbag is folded up into a compartment above the glovebox. Its cover panel is marked **AIRBAG**.



Location of the front passenger airbag in a left-hand drive car.



Location of the front passenger airbag in a right-hand drive car.

The warning label for the passenger airbag is fitted in one of the following two locations in the car:



Alternative 1: Position of airbag label on passenger side sun visor.

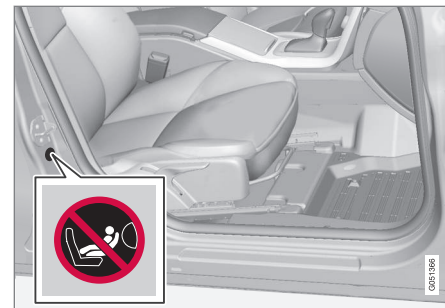

Alternative 2: Position of airbag label on passenger side door pillar. The label becomes visible when the passenger door is opened.

### **WARNING**

Never use a rear-facing child seat on a seat protected by an activated airbag. Failure to follow this advice can lead to death or serious injury to the child.

### **WARNING**

The seatbelts and airbags interact. If the belt is not used or is used incorrectly, this may diminish the protection provided by the airbag in the event of a collision.

To minimise the risk of injury if the airbag deploys, passengers must sit as upright as possible with their feet on the floor and backs against the backrest. Seatbelts must be secured.



## **! WARNING**

Do not put objects in front of or above the dashboard where the passenger airbag is located.

## **! WARNING**

Never place a child in a child seat or on a booster cushion in the front seat if the airbag is activated.

Never allow anybody to stand or sit in front of the front passenger seat.

No one shorter than 140 cm should ever sit in the front passenger seat if the airbag is activated.

Failure to follow the advice given above can endanger life.

### **Switch - PACOS\***

The front passenger airbag can be deactivated (p. 32) if the car is equipped with a switch, PACOS (Passenger Airbag Cut Off Switch).

## **! WARNING**

If the car is equipped with a front passenger airbag, but does not have a PACOS switch (Passenger Airbag Cut Off Switch), then the airbag will always be activated.

### **Related information**

- Driver airbag (p. 30)
- Child seats (p. 42)

### **Passenger airbag - activating/deactivating\***

*Front passenger airbag (p. 31) can be deactivated if the car is equipped with a switch, PACOS (Passenger Airbag Cut Off Switch).*

### **Switch - PACOS**

The switch for the passenger airbag (PACOS) is located on the passenger end of the instrument panel and is accessible when the passenger door is open.

Check that the switch is in the required position. The remote control key's key blade (p. 162) should be used to change position.

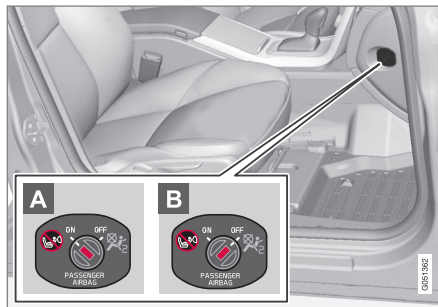

*Location of airbag switch.*

- A** The airbag is activated. With the switch in this position, persons taller than 140 cm can sit in the front passenger seat, but

never children in a child seat or on a booster cushion.

- B** The airbag is deactivated. With the switch in this position, children in a child seat or on a booster cushion can sit in the front passenger seat, but never persons taller than 140 cm.

## **! WARNING**

**Activated airbag** (passenger seat):

Never place a child in a child seat or on a booster cushion on the front passenger seat when the airbag is activated. This applies to everyone shorter than 140 cm.

**Deactivated airbag** (passenger seat):

No one taller than 140 cm should ever sit in the front passenger seat when the airbag is deactivated.

Failure to follow the advice given above can endanger life.

## **i NOTE**

When the remote control key is in key position **II** (p. 74) the warning symbol (p. 28) for the airbag is shown in the combined instrument panel for approx. 6 seconds.

Following which, the indicator in the roof console is illuminated showing the correct status for the front passenger seat airbag.



Indicator showing that the passenger airbag is activated.

A warning symbol in the roof console indicates that the airbag for the front passenger seat is activated (see preceding illustration).

### WARNING

Never place a child in a child seat or on a booster cushion in the front seat if the airbag is activated and the symbol  in the roof console is illuminated. Failure to follow this advice could endanger the life of the child.



Indicator showing that the passenger airbag is deactivated.

A text message and a symbol in the roof console indicate that the airbag for the front passenger seat is deactivated (see preceding illustration).

### WARNING

Do not allow anyone to sit in the front passenger seat if the message in the roof console indicates that the airbag is deactivated, and if the warning symbol (p. 28) for the airbag system is also displayed on the combined instrument panel. This indicates that there has been a severe malfunction. Visit a workshop as soon as possible. Volvo recommends that you contact an authorised Volvo workshop.

### WARNING

Failure to follow the advice given above can endanger the lives of passengers in the car.

#### Related information

- Child seats (p. 42)



## Side airbag (SIPS)

In a side impact collision a large proportion of the collision force is transferred by the SIPS (Side Impact Protection System) to beams, pillars, the floor, the roof and other structural parts of the body. The side airbags at the driver's and front passenger seats protect the chest area and the hip and are an important part of the SIPS.



The SIPS bag system consists of two main components, side airbag and sensors. The side airbags are located in the front seat's backrests.

A sufficiently violent collision trips the sensors and the side airbags are inflated. The airbag inflates between the occupant and the door panel and thereby cushions the initial impact. The airbag deflates when compressed by the collision. The side airbag is normally only deployed on the side of the collision.

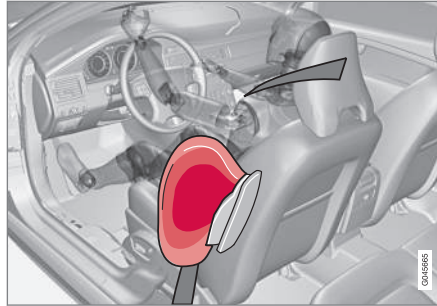

Driver's seat, left-hand drive.

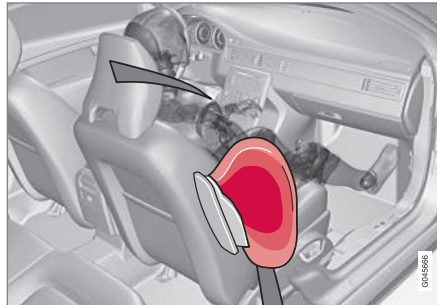

Front passenger seat, left-hand drive.

## WARNING

- Volvo recommends that repairs are only carried out by an authorised Volvo workshop. Defective work in the SIPS-bag system could cause malfunction and result in serious personal injury.
- Do not put objects in the area between the outside of the seat and the door panel, since this area is required by the side airbag.
- Volvo recommends the use only of car seat covers approved by Volvo. Other seat covers may impede the operation of the side airbags.
- Side airbags are a supplement the seatbelts. Always use a seatbelt.

### Related information

- Driver airbag (p. 30)
- Passenger airbag (p. 31)
- Side airbag (SIPS) - child seat/booster cushion (p. 35)
- Inflatable Curtain (IC) (p. 35)



### Side airbag (SIPS) - child seat/booster cushion

The protection provided by the car to children seated in a child seat or on a booster cushion is not diminished by the side airbag (p. 34).

Child seat/booster cushion (p. 42) can be placed on the front passenger seat provided that the car does not have an activated airbag (p. 32) on the front passenger side.

#### Related information

- Passenger airbag (p. 31)
- General information on child safety (p. 41)

### Inflatable Curtain (IC)

The inflatable curtain helps to prevent the driver and passengers from striking their heads on the inside of the car during a collision.

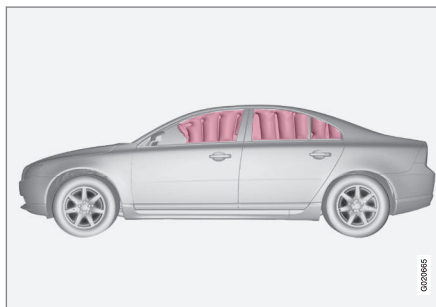

Inflatable curtain IC (Inflatable Curtain) is part of the SIPS system (p. 34) and the airbag system (p. 29). It is fitted in the headlining along both sides of the roof and protects the car's occupants sitting in the outer seats. A sufficiently violent collision trips the sensors and the inflatable curtain is inflated.

#### WARNING

Never hang or attach heavy items onto the handles in the roof. The hook is only designed for light clothing (not for solid objects such as umbrellas for example).

Do not screw or install anything onto the car's headlining, door pillars or side panels. This could compromise the intended protection. Volvo recommends that you only ever use Volvo genuine parts that are approved for placement in these areas.

#### WARNING

Do not load the car higher than 50 mm under the top edge of the door windows. Otherwise, the intended protection of the inflatable curtain, which is concealed in the headlining, may be compromised.

#### WARNING

The inflatable curtain is a supplement to the seatbelts.

Always use a seatbelt.

#### Related information

- General information on seatbelts (p. 25)



### General information on WHIPS (whiplash protection)

WHIPS (Whiplash Protection System) is a protection against whiplash injuries. The system consists of energy absorbing backrests and specially designed head restraints in the front seats.

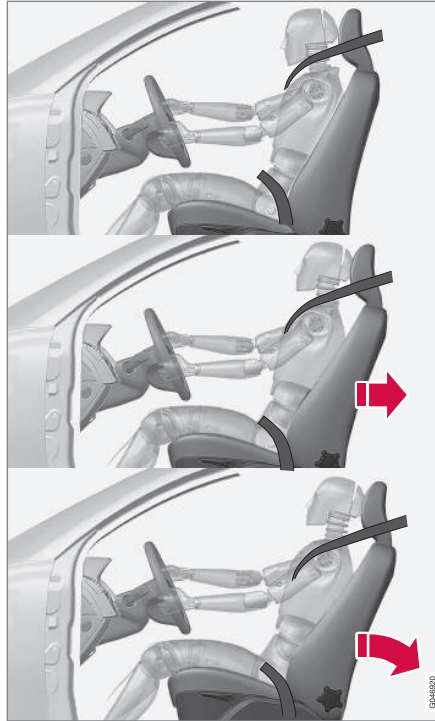

The WHIPS system is actuated by a rear-end collision, where the angle and speed of the collision, and the nature of the colliding vehicle all have an influence.

### WARNING

The WHIPS system is a supplement to the seatbelts. Always use a seatbelt.

### Seat properties

When the WHIPS system is deployed, the front seat backrests are lowered backward to change the seating position of the driver and front seat passenger. This reduces the risk of whiplash injury.

### WARNING

Never modify or repair the seat or WHIPS system yourself. Volvo recommends that you contact an authorised Volvo workshop.

### Related information

- WHIPS - child seats (p. 37)
- WHIPS - seating position (p. 37)
- General information on seatbelts (p. 25)



### WHIPS - child seats

The protection provided by the car to children seated in a child seat or on a booster cushion is not diminished by the WHIPS system (p. 36).

Child seat/booster cushion (p. 42) can be placed on the front passenger seat provided that the car does not have an activated airbag (p. 32) on the front passenger side.

### Related information

- General information on child safety (p. 41)

### WHIPS - seating position

For optimum protection from the WHIPS system (p. 36) the driver and passenger must have the correct seating position and make sure that the system's function is not obstructed.

#### Seating position

Set the correct seating position in the front seat (p. 76) before driving starts.

Driver and front seat passenger should sit in the centre of the seat with as little space as possible between the head and the head restraint.

#### Function



Do not leave any objects on the floor behind the driver's seat/passenger seat that may prevent the WHIPS system from functioning.

### WARNING

Do not squeeze rigid objects between the rear seat cushion and the front seat's backrest. Make sure you do not to obstruct the function of the WHIPS system.

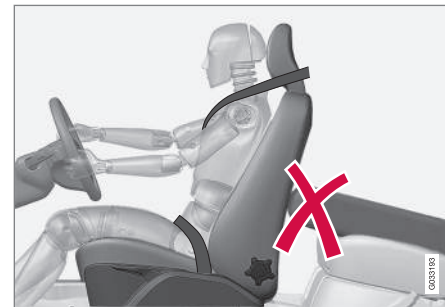

Do not place objects on the rear seat that may prevent the WHIPS system from functioning.

### WARNING

If a rear seat backrest is folded down, the corresponding front seat must be moved forward so that it does not make contact with the folded backrest.



## WARNING

If a seat has been subjected to extreme forces, such as due to a rear-end collision, the WHIPS system must be checked. Volvo recommends that it is checked by an authorised Volvo workshop.

Part of the WHIPS system's protective capacity may have been lost even if the seat appears to be undamaged.

Volvo recommends that you contact an authorised Volvo workshop to have the system checked even after a minor rear-end collision.

## When the systems deploy

*In the event of a collision Volvo's different personal safety systems work together in order to minimise injury.*

System	Triggered
Seatbelt tensioner (p. 28) front seat	In the event of a frontal collision, and/or side-impact collision, and/or rear-end collision and/or overturning
Seatbelt tensioner, rear seat	In a frontal collision and/or side-impact accident and/or overturning
Airbags (Steering wheel(p. 30) and passenger airbag (p. 31))	In a frontal collision <sup>A</sup>
Side airbags (SIPS) (p. 34)	In a side-impact accident <sup>A</sup>

System	Triggered
Inflatable Curtain IC (p. 35)	In the event of a side-impact collision and/or certain frontal collisions <sup>A</sup>
Whiplash protection WHIPS (p. 36)	In a rear-end collision

<sup>A</sup> The bodywork of the car could be greatly deformed in a collision without airbag deployment. A number of factors such as the rigidity and weight of the object hit, the speed of the car, the angle of the collision etc. affects how the different safety systems of the car are activated.

If the airbags (p. 29) have deployed, the following is recommended:

- Recovering the car. Volvo recommends that you have it conveyed to an authorised Volvo workshop. Do not drive with deployed airbags.
- Volvo recommends that you engage an authorised Volvo workshop to handle the replacement of components in the car's safety systems.
- Always contact a doctor.

## NOTE

The airbags and belt tensioner system are deployed only once during a collision.





### WARNING

The airbag system's control module is located in the centre console. If the centre console is drenched with water or other liquid, disconnect the battery cables. Do not attempt to start the car since the airbags may deploy. Recovering the car. Volvo recommends that you have it conveyed to an authorised Volvo workshop.

### WARNING

Never drive with deployed airbags. They can make steering difficult. Other safety systems may also be damaged. The smoke and dust created when the airbags are deployed can cause skin and eye irritation/injury after intensive exposure. In case of irritation, wash with cold water. The rapid deployment sequence and airbag fabric may cause friction and skin burns.

### General information on safety mode

*Safety mode is a protective state that is enforced when the collision may have damaged any of the car's vital functions, such as the fuel lines, sensors for one of the safety systems, or the brake system.*

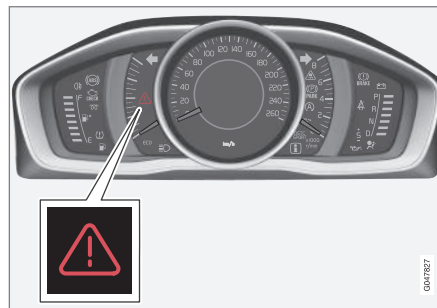

*Warning triangle in the analogue combined instrument panel.*

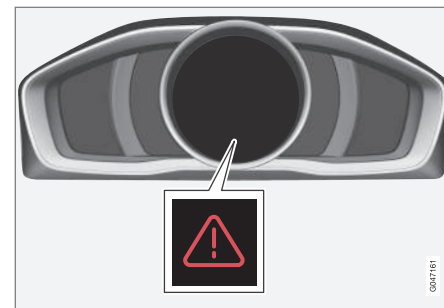

*Warning triangle in the digital combined instrument panel.*

If the car is involved in a collision, the text **Safety mode See manual** may appear in the combined instrument panel (p. 59) information display. This means that the car has reduced functionality.

### WARNING

Never attempt to repair your car or reset the electronics yourself if the car has been in safety mode. This could result in personal injury or the car not functioning as normal. Volvo recommends that you engage an authorised Volvo workshop to check and restore the car to normal status after **Safety mode See manual** has been displayed.



### Related information

- Safety mode - attempting to start the car (p. 40)
- Safety mode - moving the car (p. 41)

### Safety mode - attempting to start the car

*If the car is set in safety mode (p. 39) then an attempt to start the car can be made if everything seems normal and the absence of fuel leakage has been checked.*

First, check that no fuel is leaking from the car. There must be no smell of fuel either.

If everything seems normal and you have checked for indications of fuel leakage, you may attempt to start the car.

Remove the remote control key and open the driver's door. If a message is now shown to the effect that the ignition is on, press the start button. Then close the door and reinsert the remote control key. The car's electronics will now try to reset themselves to normal mode. Then try to start the car.

If the message **Safety mode See manual** is still shown on the display then the car must not be driven or towed but a vehicle recovery service (p. 304) used instead. Even if the car appears to be driveable, hidden damage may make the car impossible to control once moving.



### WARNING

Never, under any circumstances, attempt to restart the car if it smells of fuel when the **Safety mode See manual** message is displayed. Leave the car at once.



### WARNING

If the car is in safety mode it must not be towed. It must be transported from its location. Volvo recommends that it is transported to an authorised Volvo workshop.

### Related information

- Safety mode - moving the car (p. 41)



### Safety mode - moving the car

If **Normal mode** is shown after **Safety mode** *See manual* has been reset after attempting to start the car (p. 40), the car can be moved carefully out of a dangerous position.

Do not move the car further than necessary.

### Related information

- General information on safety mode (p. 39)

### General information on child safety

*Children of all ages and sizes must always sit correctly secured in the car. Never allow a child to sit on the knee of a passenger.*

Volvo recommends that children travel in rear-facing child seats until as late an age as possible, at least until 3-4 years of age, and then front-facing booster cushions/child seats until up to 10 years of age.

The position of a child in the car and the choice of equipment are dictated by the child's weight and size; see Child seats (p. 42).



### NOTE

Regulations regarding the placement of children in cars vary from country to country. Check what does apply.

Volvo has child safety equipment (child seats, booster cushions & attachment devices) which is designed for your particular car. Using Volvo's child safety equipment provides you with optimum conditions for your child to travel safely in the car. Furthermore, the child safety equipment fits and is easy to use.



### NOTE

In the event of questions when fitting child safety products, contact the manufacturer for clearer instructions.

### Child safety locks

The rear doors and rear door windows\* can be blocked manually (p. 175) or electronically (p. 175)\* from opening from the inside.

### Related information

- Child seats - location (p. 46)
- Child seat - ISOFIX (p. 47)
- Child seats - upper mounting points (p. 51)



### Child seats

Children should sit comfortably and safely. Make sure that the child seat is being used correctly.



Child seats and airbags are not compatible.



### NOTE

When using child safety products it is important to read the installation instructions included.



### WARNING

Do not secure the straps of the child seat to the seat's horizontal adjustment bar, springs or the rails and beams under the seat. Sharp edges may damage the straps.

Look in the installation instructions for the child seat for the correct fitting.



### Recommended child seats<sup>2</sup>

Weight	Front seat (with deactivated airbag)	Outer rear seat	Centre rear seat
Group 0 max 10 kg Group 0+ max 13 kg		Volvo infant seat (Volvo Infant Seat) - rear-facing child seat, secured with the ISOFIX fixture system.  Type approval: E1 04301146 (L)	
Group 0 max 10 kg Group 0+ max 13 kg	Volvo infant seat (Volvo Infant Seat) - rear-facing child seat, secured with the car's seatbelt.  Type approval: E1 04301146 (U)	Volvo infant seat (Volvo Infant Seat) - rear-facing child seat, secured with the car's seatbelt.  Type approval: E1 04301146 (U)	Volvo infant seat (Volvo Infant Seat) - rear-facing child seat, secured with the car's seatbelt.  Type approval: E1 04301146 (U)
Group 0 max 10 kg Group 0+ max 13 kg	Rear-facing child seat (Child Seat) - rear-facing child seat, secured with the car's seatbelt and straps.  Type approval: E5 03135 (L)	Rear-facing child seat (Child Seat) - rear-facing child seat, secured with the car's seatbelt and straps.  Type approval: E5 03135 (L)	Rear-facing child seat (Child Seat) - rear-facing child seat, secured with the car's seatbelt and straps.  Type approval: E5 03135 (L)
Group 0 max 10 kg Group 0+ max 13 kg	Child seats which are universally approved. (U)	Child seats which are universally approved. (U)	Child seats which are universally approved. (U)

<sup>2</sup> With regard to other child seats your car should be included in the manufacturer's enclosed list of vehicles or be universally approved in accordance with the ECE R44 legal requirement.



## 02 Safety



Weight	Front seat (with deactivated airbag)	Outer rear seat	Centre rear seat
Group 1 9-18 kg	Volvo rear-facing/turnable child seat (Volvo Convertible Child Seat) - rear-facing child seat, secured with the car's seatbelt and straps.  Type approval: E5 04192 (L)	Volvo rear-facing/turnable child seat (Volvo Convertible Child Seat) - rear-facing child seat, secured with the car's seatbelt and straps.  Type approval: E5 04192 (L)	
Group 1 9-18 kg	Rear-facing child seat (Child Seat) - rear-facing child seat, secured with the car's seatbelt and straps.  Type approval: E5 03135 (L)	Rear-facing child seat (Child Seat) - rear-facing child seat, secured with the car's seatbelt and straps.  Type approval: E5 03135 (L)	Rear-facing child seat (Child Seat) - rear-facing child seat, secured with the car's seatbelt and straps.  Type approval: E5 03135 (L)
Group 1 9-18 kg		Britax Fixway – rear-facing child seat, secured with the ISOFIX fixture system and straps.  Type approval: E5 03171 (L)	
Group 1 9-18 kg	Child seats which are universally approved. (U)	Child seats which are universally approved. (U)	Child seats which are universally approved. (U)
Group 2 15-25 kg	Volvo rear-facing/turnable child seat (Volvo Convertible Child Seat) - rear-facing child seat, secured with the car's seatbelt and straps.  Type approval: E5 04192 (L)	Volvo rear-facing/turnable child seat (Volvo Convertible Child Seat) - rear-facing child seat, secured with the car's seatbelt and straps.  Type approval: E5 04192 (L)	



Weight	Front seat (with deactivated airbag)	Outer rear seat	Centre rear seat
Group 2 15-25 kg	Volvo rear-facing/turnable child seat (Volvo Convertible Child Seat) - front-facing child seat, secured with the car's seatbelt.  Type approval: E5 04191 (U)	Volvo rear-facing/turnable child seat (Volvo Convertible Child Seat) - front-facing child seat, secured with the car's seatbelt.  Type approval: E5 04191 (U)	Volvo rear-facing/turnable child seat (Volvo Convertible Child Seat) - front-facing child seat, secured with the car's seatbelt.  Type approval: E5 04191 (U)
Group 2/3 15-36 kg	Booster cushion with and without backrest (Booster Cushion with and without backrest).  Type approval: E5 04216 (UF)	Booster cushion with and without backrest (Booster Cushion with and without backrest).  Type approval: E5 04216 (UF)	Booster cushion with and without backrest (Booster Cushion with and without backrest).  Type approval: E5 04216 (UF)
Group 2/3 15-36 kg	Volvo booster seat with backrest (Volvo Booster Seat with backrest).  Type approval: E1 04301169 (UF)	Volvo booster seat with backrest (Volvo Booster Seat with backrest).  Type approval: E1 04301169 (UF)	Volvo booster seat with backrest (Volvo Booster Seat with backrest).  Type approval: E1 04301169 (UF)

L: Suitable for specific child seats. These child seats may be intended for use in a special car model, limited or semi-universal categories.

U: Suitable for universally approved child seats in this weight class.

UF: Suitable for front-facing universally approved child seats in this weight class.

### Related information

- Child seats - location (p. 46)
- Child seats - upper mounting points (p. 51)
- Child seat - ISOFIX (p. 47)
- General information on child safety (p. 41)



## Child seats - location

Always fit child seats/booster cushions (p. 42) in the rear seat if the passenger airbag is activated (p. 32). If a child is sitting on the front passenger seat then he/she could suffer serious injury if the airbag deploys.

The warning label for the passenger airbag is fitted in one of the following two locations in the car:



Alternative 1: Position of airbag label on passenger side sun visor.

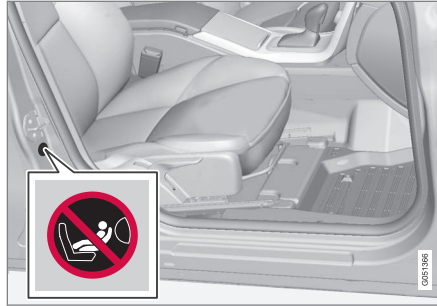

Alternative 2: Position of airbag label on passenger side door pillar. The label becomes visible when the passenger door is opened.

You may place:

- a child seat/booster cushion on the front passenger seat provided there is no activated airbag on the front passenger side.
- one or more child seats/booster cushions in the rear seat.

### WARNING

Never use a rear-facing child seat on a seat protected by an activated airbag. Failure to follow this advice can lead to death or serious injury to the child.

### WARNING

Never place a child in a child seat or on a booster cushion in the front seat if the airbag is activated.

Never allow anybody to stand or sit in front of the front passenger seat.

No one shorter than 140 cm should ever sit in the front passenger seat if the airbag is activated.

Failure to follow the advice given above can endanger life.

### WARNING

Booster cushions/child seats with steel braces or some other design that could rest on the seatbelt buckle's opening button must not be used, as they could cause the seatbelt buckle to open accidentally.

Do not allow the upper section of the child seat to rest against the windscreen.

### Related information

- General information on child safety (p. 41)
- Child seats - upper mounting points (p. 51)
- Child seat - ISOFIX (p. 47)





### Child seat - ISOFIX

ISOFIX is a fixture system for car child seats (p. 42) that is based on an international standard.

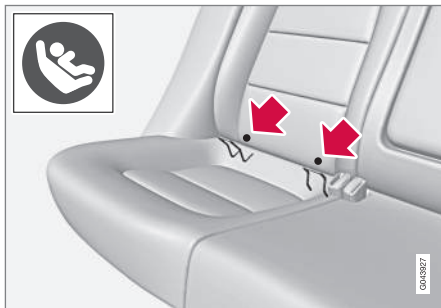

Mounting points for the ISOFIX fixture system are concealed behind the lower section of the rear seat backrest, in the outer seats.

The location of the mounting points is indicated by symbols in the backrest upholstery (see preceding illustration).

Press the seat cushion down to access the mounting points.

Always follow the manufacturer's installation instructions when connecting a child seat to the ISOFIX mounting points.

### Related information

- ISOFIX - size classes (p. 47)
- ISOFIX - types of child seat (p. 49)

- General information on child safety (p. 41)

### ISOFIX - size classes

There is a size classification for child seats using the ISOFIX (p. 47) fixture system in order to assist users in choosing the correct type of child seat (p. 49).

Size class	Description
A	Full size, front-facing child seat
B	Reduced size (alt. 1), front-facing child seat
B1	Reduced size (alt.2), front-facing child seat
C	Full size, rear-facing child seat
D	Reduced size, rear-facing child seat
E	Rear-facing infant seat
F	Transverse infant seat, left-hand
G	Transverse infant seat, right-hand



### **WARNING**

Never place the child in the passenger seat if the car is fitted with an activated air-bag.

### **NOTE**

If an ISOFIX child seat has no size classification, the car model must be included on the vehicle list for the child seat.

### **NOTE**

Volvo recommends that you contact an authorised Volvo dealer for recommendations about which ISOFIX child seats Volvo recommends.



### ISOFIX - types of child seat

Child seats are in different sizes – cars are in different sizes. This means that not all child

seats are suitable for all seats in all car models.

Type of child seat	Weight	Size class	Passenger seats for ISOFIX installation of child seats	
			Front seat	Outer rear seat
Infant seat transverse	max 10 kg	F	X	X
		G	X	X
Infant seat, rear-facing	max 10 kg	E	X	OK (IL)
Infant seat, rear-facing	max 13 kg	E	X	OK (IL)
		D	X	OK (IL)
		C	X	OK (IL)
Child seat, rear-facing	9-18 kg	D	X	OK (IL)
		C	X	OK (IL)



Type of child seat	Weight	Size class	Passenger seats for ISOFIX installation of child seats	
			Front seat	Outer rear seat
Front-facing child seat	9-18 kg	B	X	OK <sup>A</sup> (IUF)
		B1	X	OK <sup>A</sup> (IUF)
		A	X	OK <sup>A</sup> (IUF)

X: The ISOFIX position is not suitable for ISOFIX child seats in this weight class and/or size class.

IL: Suitable for specific ISOFIX child seats. These child seats may be intended for use in a special car model, limited or semi-universal categories.

IUF: Suitable for front-facing ISOFIX child seats that are universally approved in this weight class.

<sup>A</sup> Volvo recommends rear-facing child seats for this group.

Make sure you select the right size class (p. 47) of child seat with ISOFIX (p. 47) fixture system.



## Child seats - upper mounting points

The car is equipped with upper mounting points for child seats (p. 42). These mounting points are located on the parcel shelf and are concealed by plastic covers. Bend aside the plastic covers to access each respective mounting point.

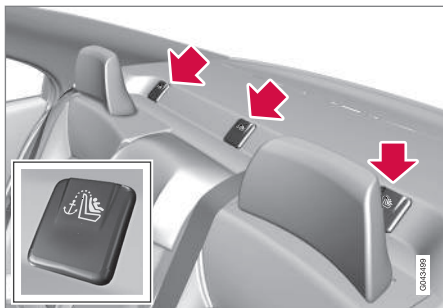

For cars with folding head restraints on the outside seats, the head restraints should be folded to facilitate installation.

The upper mounting points are primarily intended for use with front-facing child seats. Volvo recommends that small children should sit in rear-facing child seats for as long as possible.

For detailed information on how the child seat should be tensioned in the upper mounting points, see the seat manufacturer's instructions.

## WARNING

The child seat's straps must always be drawn through the hole in the head restraint leg before they are tensioned at the attachment point.

### Related information

- General information on child safety (p. 41)
- Child seats - location (p. 46)
- Child seat - ISOFIX (p. 47)

# 03



## INSTRUMENTS AND CONTROLS

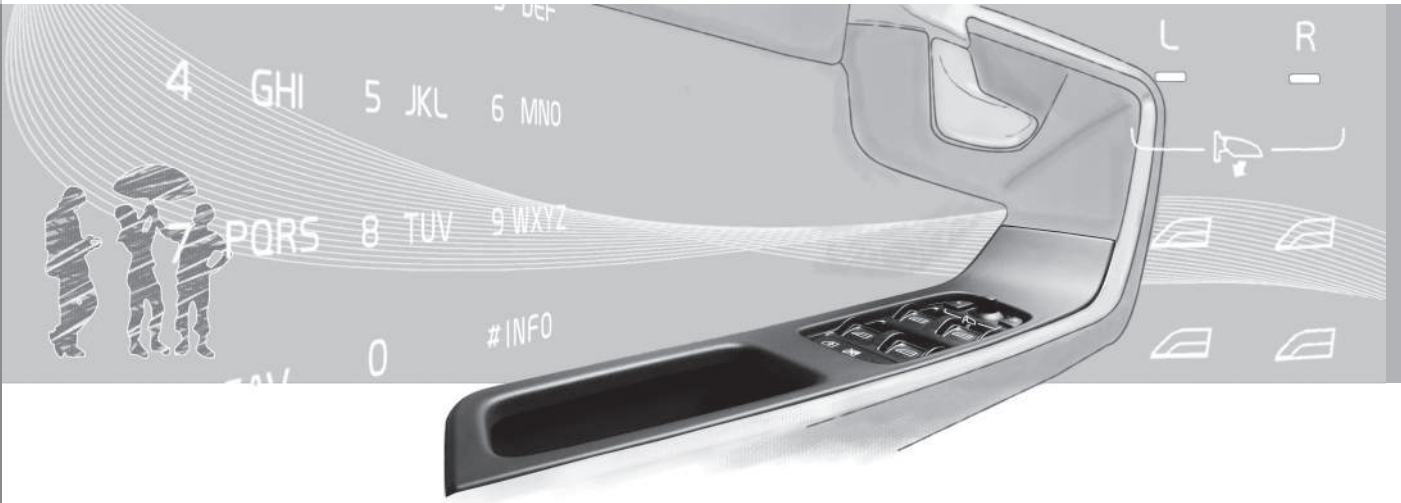



### **Instruments and controls, left-hand drive car - overview**

*The overview shows where the car's displays and controls are located.*



# 03 Instruments and controls



## Overview, left-hand drive cars

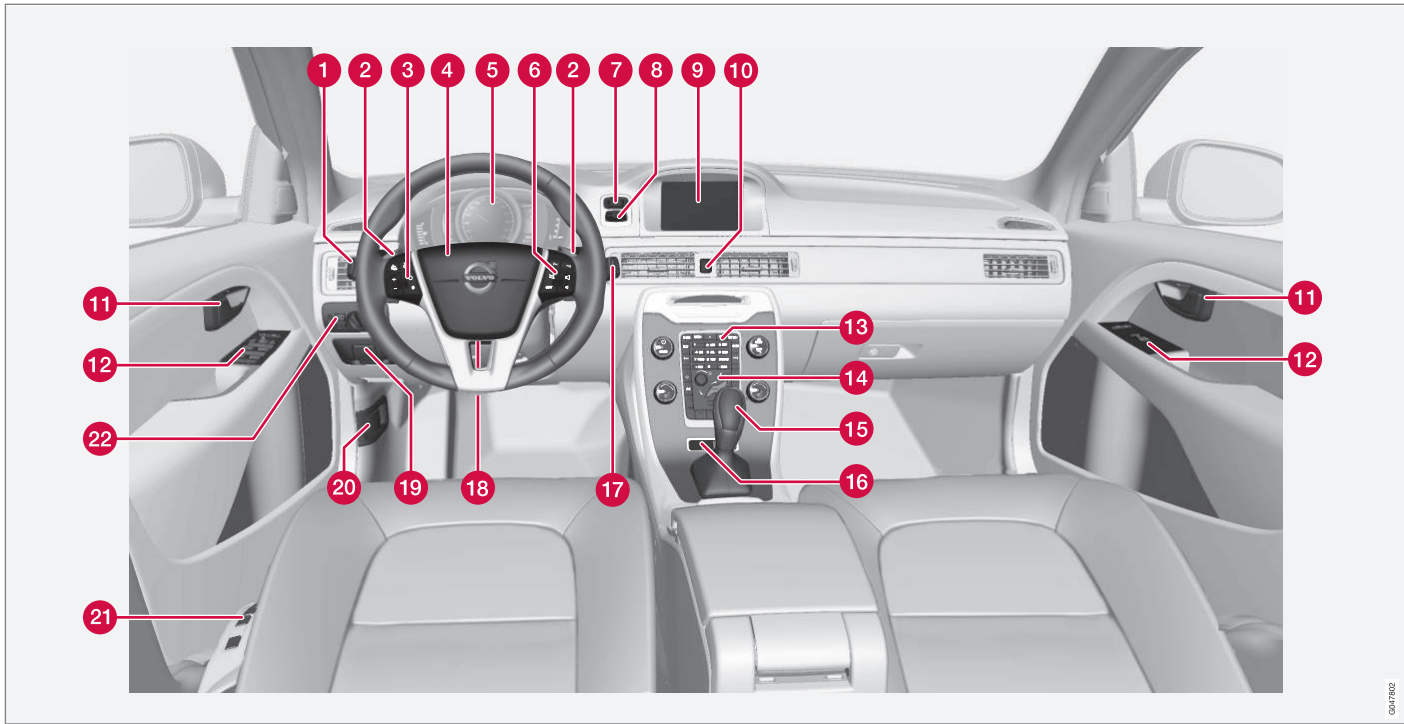

0411102





	Function	See
1	Menus and messages, direction indicators, main/dipped beam, trip computer	(p. 105), (p. 107), (p. 89), (p. 84) and (p. 118).
2	Manual gear changing in an automatic gearbox*	(p. 261).
3	Cruise control*	(p. 188) and (p. 190).
4	Horn, airbags	(p. 79) and (p. 29).
5	Combined instrument panel	(p. 59).
6	Menu navigation, audio control, phone control*	(p. 108) and the Sensus Infotainment supplement.
7	<b>START/STOP ENGINE</b> button	(p. 252).
8	Ignition switch	(p. 74).
9	Screen for infotainment system and display of menus	(p. 108) and the Sensus Infotainment supplement.

	Function	See
10	Hazard warning flashers	(p. 88).
11	Door handle	–
12	Control panel	(p. 171), (p. 175), (p. 97) and (p. 99).
13	Control panel for infotainment system and menu navigation	(p. 108) and the Sensus Infotainment supplement.
14	Control panel for climate control	(p. 127).
15	Gear selector	(p. 260), (p. 261) or (p. 265).
16	Controls for active chassis (Four-C)*	(p. 181).
17	Wipers and washing	(p. 96).
18	Steering wheel adjustment	(p. 79).
19	Parking brake	(p. 282).
20	Bonnet opener	(p. 343).

	Function	See
21	Seat adjustment*	(p. 77).
22	Headlamp control, opener for fuel filler flap and boot lid	(p. 81), (p. 289) and (p. 173).

#### Related information

- Outside temperature gauge (p. 68)
- Trip meter (p. 68)
- Clock (p. 69)



## 03 Instruments and controls

### **Instruments and controls, right-hand drive car - overview**

*The overview shows where the car's displays and controls are located.*

03



## Overview, right-hand drive cars

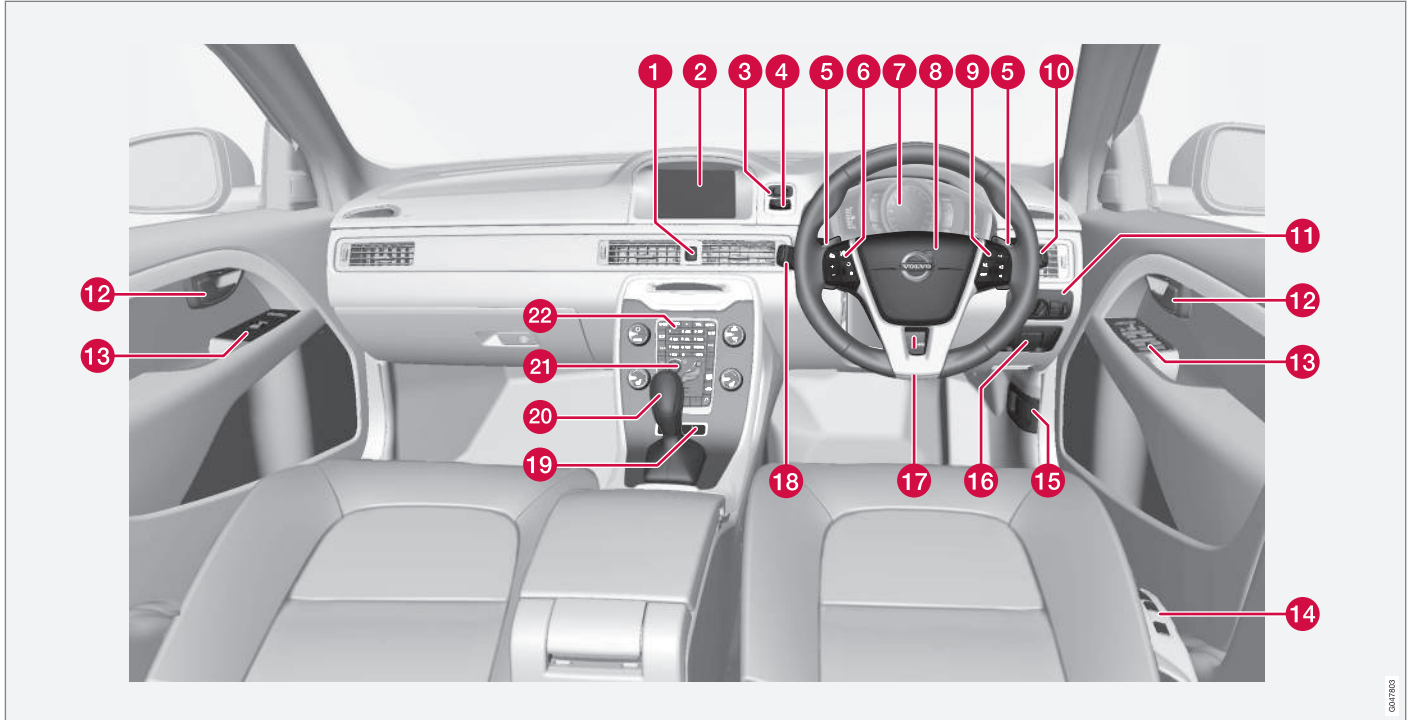



# 03 Instruments and controls



	Function	See
1	Hazard warning flashers	(p. 88).
2	Screen for infotainment system and display of menus	(p. 108) and the Sensus Infotainment supplement.
3	<b>START/STOP ENGINE</b> button	(p. 252).
4	Ignition switch	(p. 74).
5	Manual gear changing in an automatic gearbox*	(p. 261).
6	Cruise control*	(p. 188) and (p. 190).
7	Combined instrument panel	(p. 59).
8	Horn, airbags	(p. 79) and (p. 29).
9	Menu navigation, audio control, phone control*	(p. 108) and the Sensus Infotainment supplement.
10	Wipers and washing	(p. 96).

	Function	See
11	Headlamp control, opener for fuel filler flap and boot lid	(p. 81), (p. 289) and (p. 173).
12	Door handle	–
13	Control panel	(p. 171), (p. 175), (p. 97) and (p. 99).
14	Seat adjustment*	(p. 77).
15	Bonnet opener	(p. 343).
16	Parking brake	(p. 282).
17	Steering wheel adjustment	(p. 79).
18	Menus and messages, direction indicators, main/dipped beam, trip computer	(p. 105), (p. 107), (p. 89), (p. 84) and (p. 118).
19	Controls for active chassis (Four-C)*	(p. 181).
20	Gear selector	(p. 260), (p. 261) or (p. 265).

	Function	See
21	Control panel for climate control	(p. 127).
22	Control panel for infotainment system and menu navigation	(p. 108) and the Sensus Infotainment supplement.

### Related information

- Outside temperature gauge (p. 68)
- Trip meter (p. 68)
- Clock (p. 69)



## Combined instrument panel

The combined instrument panel's information display shows information on some of the car's functions, as well as messages.

- Analogue combined instrument panel - overview (p. 59)
- Digital combined instrument panel - overview (p. 60)
- Combined instrument panel - meaning of indicator symbols (p. 64)
- Combined instrument cluster - meaning of warning symbols (p. 66)

## Analogue combined instrument panel - overview

The combined instrument panel's information display shows information on some of the car's functions, e.g. cruise control and trip computer, as well as messages. The information is shown with symbols and text.

### Information display

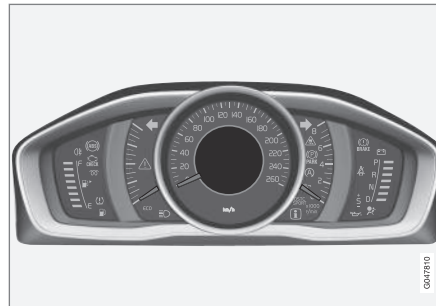

Information display, analogue instrument panel.

The combined instrument panel's information display shows information on some of the car's functions, e.g. cruise control and trip computer, as well as messages. The information is shown with symbols and text. There are further descriptions under the functions that use the display.

## Gauges and indicators

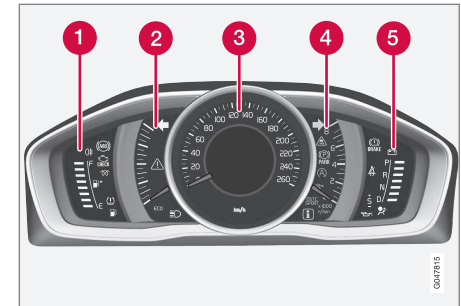

- 1 Fuel gauge. When the indicator lowers to only one white marking<sup>1</sup>, the yellow indicator symbol for low level in the fuel tank is illuminated. See also Trip computer - supplementary information (p. 118) and Filling up with fuel (p. 289).
- 2 Eco meter The meter provides an indication of how economically the car is being driven. The higher the reading on the scale, the more economical it is.
- 3 Speedometer

<sup>1</sup> When the display's message "Distance to empty fuel tank:" starts to show "----", the marking becomes red.



- 4 Tachometer. The meter indicates engine speed in thousands of revolutions per minute (rpm).
- 5 Gear shift indicator<sup>2</sup>/Gear position indicator<sup>3</sup> See also Gear shift indicator\* (p. 260), Automatic gearbox -- Geartronic\* (p. 261) or Automatic gearbox -- Powershift\* (p. 265).

## Indicator and warning symbols

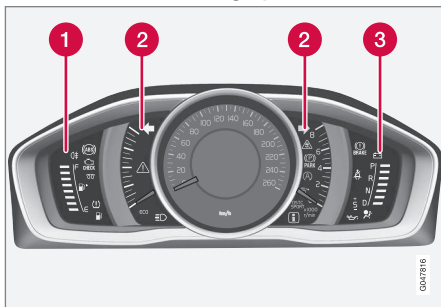

Indicator and warning symbols, analogue instrument panel.

- 1 Indicator symbols
- 2 Indicator and warning symbols
- 3 Warning symbols<sup>4</sup>

<sup>2</sup> Manual gearbox.

<sup>3</sup> Automatic gearbox.

<sup>4</sup> Certain engine variants do not have systems to warn of oil pressure loss. In cars with these variants the symbol for low oil pressure is not used. Warning for low oil level is via display text. For more information, see Engine oil - general (p. 345).

## Functionality check

All indicator and warning symbols, apart from symbols in the centre of the information display, illuminate in key position II or when the engine is started. When the engine has started, all the symbols should go out except the parking brake symbol, which only goes out when the brake is disengaged.

If the engine does not start or if the functionality check is carried out in key position II then all symbols go out within a few seconds except the symbol for faults in the car's emissions system and the symbol for low oil pressure.

## Related information

- Combined instrument panel (p. 59)
- Combined instrument panel - meaning of indicator symbols (p. 64)
- Combined instrument cluster - meaning of warning symbols (p. 66)

## Digital combined instrument panel - overview

The combined instrument panel's information display shows information on some of the car's functions, e.g. cruise control and trip computer, as well as messages. The information is shown with symbols and text.

## Information display

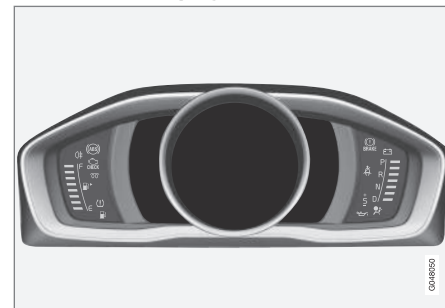

Information display, digital instrument panel\*.

The combined instrument panel's information display shows information on some of the car's functions, e.g. cruise control and trip computer, as well as messages. The information is shown with symbols and text. There are further descriptions under the functions that use the display.



### Gauges and indicators

Alternative themes can be selected for the digital combined instrument panel. Possible themes are "Elegance", "Eco" and "Performance".

A theme can only be selected when the engine is running.

To select the theme, press the left-hand stalk switch's **OK** button and select the **Themes** menu option by turning the thumbwheel on the lever. Press the **OK** button. Turn the thumbwheel to select the theme and confirm the selection by pressing the **OK** button.

On certain model variants, the appearance of the centre console's screen follows the theme selected for the combined instrument panel.

The contrast mode and colour mode for the instrument can also be set using the left-hand stalk switch.

For more information on menu navigation, see Menu navigation - combined instrument panel (p. 105).

The choice of theme and setting of contrast mode and colour mode can be stored for each remote control key in the car key memory\*, see Remote control key - personalisation\* (p. 156).

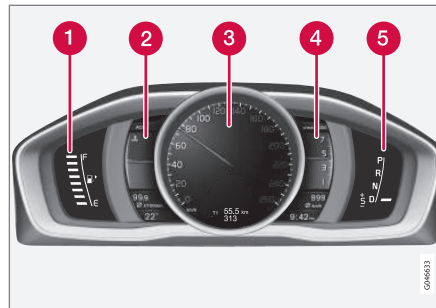

Gauges and indicators, theme "Elegance".

- 1 Fuel gauge. When the indicator lowers to only one white marking<sup>5</sup>, the yellow indicator symbol for low level in the fuel tank is illuminated. See also Trip computer - supplementary information (p. 118) and Filling up with fuel (p. 289).
- 2 Temperature gauge for engine coolant
- 3 Speedometer
- 4 Tachometer. The meter indicates engine speed in thousands of revolutions per minute (rpm).
- 5 Gear shift indicator<sup>6</sup>/Gear position indicator<sup>7</sup> See also Gear shift indicator\* (p. 260), Automatic gearbox --

Geartronic\* (p. 261) or Automatic gearbox -- Powershift\* (p. 265).

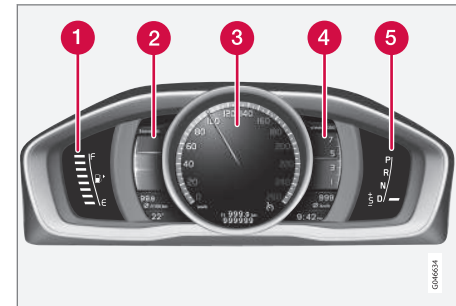

Gauges and indicators, theme "Eco".

- 1 Fuel gauge. When the indicator lowers to only one white marking<sup>5</sup>, the yellow indicator symbol for low level in the fuel tank is illuminated. See also Trip computer - supplementary information (p. 118) and Filling up with fuel (p. 289).
- 2 Eco guide. See also Eco guide & Power guide\* (p. 63).
- 3 Speedometer

<sup>5</sup> When the display's message "Distance to empty fuel tank:" starts to show "----", the marking becomes red.

<sup>6</sup> Manual gearbox.

<sup>7</sup> Automatic gearbox.



# 03 Instruments and controls



- 4 Tachometer. The meter indicates engine speed in thousands of revolutions per minute (rpm).
- 5 Gear shift indicator<sup>6</sup>/Gear position indicator<sup>7</sup>. See also Gear shift indicator\* (p. 260), Automatic gearbox -- Geartronic\* (p. 261) or Automatic gearbox -- Powershift\* (p. 265).

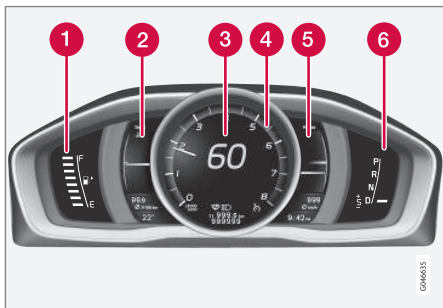

Gauges and indicators, theme "Performance".

- 1 Fuel gauge. When the indicator lowers to only one white marking<sup>5</sup>, the yellow indicator symbol for low level in the fuel tank is illuminated. See also Trip computer - supplementary information (p. 118) and Filling up with fuel (p. 289).
- 2 Temperature gauge for engine coolant

- 3 Speedometer
- 4 Tachometer. The meter indicates engine speed in thousands of revolutions per minute (rpm).
- 5 Power guide. See also Eco guide & Power guide\* (p. 63).
- 6 Gear shift indicator<sup>6</sup>/Gear position indicator<sup>7</sup>. See also Gear shift indicator\* (p. 260), Automatic gearbox -- Geartronic\* (p. 261) or Automatic gearbox -- Powershift\* (p. 265).

## Indicator and warning symbols

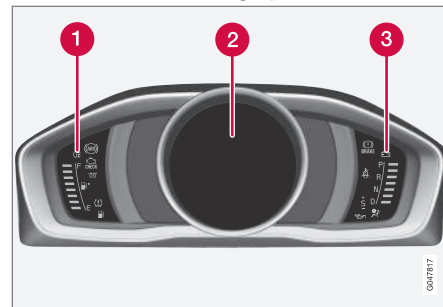

Indicator and warning symbols, digital instrument panel.

- 1 Indicator symbols
- 2 Indicator and warning symbols
- 3 Warning symbols<sup>8</sup>

<sup>6</sup> Manual gearbox.

<sup>7</sup> Automatic gearbox.

<sup>5</sup> When the display's message "Distance to empty fuel tank:" starts to show "----", the marking becomes red.

<sup>8</sup> Certain engine variants do not have systems to warn of oil pressure loss. In cars with these variants the symbol for low oil pressure is not used. Warning for low oil level is via display text. For more information, see Engine oil - general (p. 345).





### Functionality check

All indicator and warning symbols, apart from symbols in the centre of the information display, illuminate in key position II or when the engine is started. When the engine has started, all the symbols should go out except the parking brake symbol, which only goes out when the brake is disengaged.

If the engine does not start or if the functionality check is carried out in key position II then all symbols go out within a few seconds except the symbol for faults in the car's emissions system and the symbol for low oil pressure.

### Related information

- Combined instrument panel (p. 59)
- Combined instrument panel - meaning of indicator symbols (p. 64)
- Combined instrument cluster - meaning of warning symbols (p. 66)

### Eco guide & Power guide\*

*Eco guide and Power guide are two combined instrument panel (p. 59) instruments which help the driver to drive the car with optimum driving economy.*

*The car also stores statistics of journeys made, which can be viewed in the form of a block diagram; see Trip computer - trip statistics\* (p. 119).*

### Eco guide

This instrument provides an indication of how economically the car is being driven.

To view this function, select the theme "Eco"; see Digital combined instrument panel - overview (p. 60).

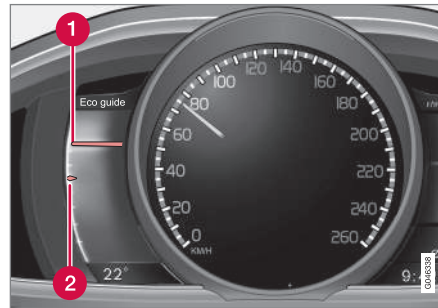

- 1 Instantaneous value
- 2 Average value

### Instantaneous value

The instantaneous value is shown here - the higher the reading on the scale, the better.

The instantaneous value is calculated based on speed, engine speed, engine power utilised plus use of the foot brake.

Optimum speed (50-80 km/h) and low engine speeds are encouraged. The pointers fall during acceleration and braking.

Very low instantaneous values illuminate the red zone on the meter (with a short delay), which means poor driving economy and hence should be avoided.

### Average value

The average value slowly follows the instantaneous value and describes how the car has been driven most recently. The higher the pointers on the scale, the better the economy achieved by the driver.

### Power guide

This instrument shows the relationship between how much power (Power) is being taken from the engine and how much power is available.

To view this function, select the theme "Performance"; see Digital combined instrument panel - overview (p. 60).

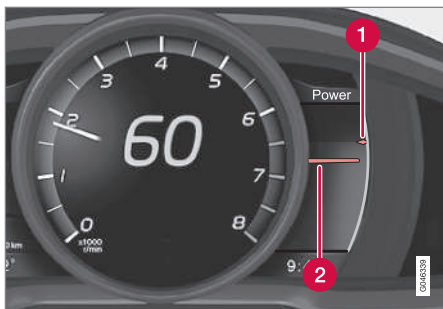

- 1 Available engine power
- 2 Engine power utilised

### Available engine power

The smaller, upper pointer shows the available engine power<sup>9</sup>. The higher the reading on the scale, the more power is available in the current gear.

### Engine power utilised

The larger, lower pointer shows the engine power utilised<sup>9</sup>. The higher the reading on the scale, the more power is being taken from the engine.

A large gap between the two pointers indicates a large power reserve.

## Combined instrument panel - meaning of indicator symbols

The indicator symbols alert the driver that a function is activated, that the system is operating, or that an error or failure has occurred.

### Indicator symbols

Symbol	Specification
	ABL fault
	Emissions system
	ABS fault
	Rear fog lamp on
	Stability system, see Electronic stability control (ESC) - general (p. 181)
	Stability system, sport mode, see Electronic stability control (ESC) - operation (p. 182)
	Engine preheater (diesel)
	Low level in fuel tank

Symbol	Specification
	Information, read display text
	Main beam On
	Left-hand direction indicator
	Right-hand direction indicator
	Eco-function on, see ECO* (p. 277)
	Start/Stop, the engine auto-stopped; see Start/Stop* - function and operation (p. 269)
	Tyre pressure system, see Tyre pressure monitoring* (p. 317)

### ABL fault

The symbol illuminates if a fault has arisen in the ABL function (Active Bending Lights).

### Emissions system

If the symbol illuminates after the engine has been started then it may be due to a fault in the car's emissions system. Drive to a workshop for checking. Volvo recommends that you seek assistance from an authorised Volvo workshop.

<sup>9</sup> Power is dependent on engine speed.

\* Option/accessory, for more information, see Introduction.



### ABS fault

If this symbol illuminates then the system is not working. The car's regular brake system continues to work, but without the ABS function.

1. Stop the car in a safe place and turn off the engine.
2. Restart the engine.
3. If the symbol remains illuminated, drive to a workshop to have the ABS system checked. Volvo recommends that you seek assistance from an authorised Volvo workshop.

### Rear fog lamp on

This symbol illuminates when the rear fog lamp is switched on.

### Stability system

A flashing symbol indicates that the stability system is operating. If the symbol illuminates with constant glow then there is a fault in the system.

### Stability system, sport mode

Sport mode allows for a more active driving experience. The system then detects whether the accelerator pedal, steering wheel movements and cornering are more active than in normal driving and then allows controlled skidding of the rear section up to a certain level before it intervenes and stabilises the car. The symbol illuminates when the sport mode is activated.

### Engine preheater (diesel)

This symbol illuminates during engine preheating. Preheating takes place mostly due to low temperature.

### Low level in fuel tank

When the symbol illuminates the level in the fuel tank is low, refuel as soon as possible.

### Information, read display text

When one of the car's systems does not behave as intended, this information symbol illuminates and a text appears on the information display. The message text is cleared with the **OK** button, see Menu navigation - combined instrument panel (p. 105), or it disappears automatically after a time (time depending on which function is indicated). The information symbol can also illuminate in conjunction with other symbols.

#### NOTE

When a service message is shown, the symbol and message are cleared using the **OK** button, or disappear automatically after a time.

### Main beam On

The symbol illuminates when main beam is on and with main beam flash.

### Left/right-hand direction indicator

Both direction indicator symbols flash when the hazard warning flashers are used.

### Eco function on

This symbol illuminates when the Eco function is activated.

### Start/Stop

The symbol shines when the engine is auto-stopped.

### Tyre pressure system

The symbol illuminates in the event of low tyre pressure, or if a fault arises in the tyre pressure system.

### Related information

- Combined instrument panel (p. 59)
- Combined instrument cluster - meaning of warning symbols (p. 66)
- Digital combined instrument panel - overview (p. 60)



# 03 Instruments and controls

## Combined instrument cluster - meaning of warning symbols

The warning symbols alert the driver that an important function is activated, or that a serious error or a serious failure has occurred.

### Warning symbols

Symbol	Specification
	Low oil pressure <sup>A</sup>
	Parking brake applied, digital instrument panel
	Parking brake applied, analogue instrument panel
	Airbags – SRS
	Seatbelt reminder
	Alternator not charging
	Fault in brake system
	Warning

<sup>A</sup> Certain engine variants do not have systems to warn of oil pressure loss. In cars with these variants the symbol for low oil pressure is not used. Warning for low oil level is via display text. For more information, see Engine oil - general (p. 345).

### Low oil pressure

If this symbol illuminates during driving then the engine's oil pressure is too low. Stop the engine immediately and check the engine oil level, top up if necessary. If the symbol illuminates and the oil level is normal, contact a workshop. Volvo recommends that you seek assistance from an authorised Volvo workshop.

### Parking brake applied

This symbol illuminates with a constant glow when the parking brake is applied. The symbol flashes during application, and then changes over to a constant glow.

A flashing symbol in any other situation means that a fault has arisen. Read the message on the information display.

For more information, see Parking brake (p. 282).

### Airbags – SRS

If this symbol remains illuminated or illuminates while driving, it means a fault has been detected in the seatbelt buckle, SRS, SIPS, or IC systems. Drive immediately to a workshop to have the system checked. Volvo recommends that you seek assistance from an authorised Volvo workshop.

### Seatbelt reminder

This symbol flashes if someone in a front seat has not put on their seatbelt or if someone in a rear seat has taken off their seatbelt.

### Alternator not charging

This symbol illuminates during driving if a fault has occurred in the electrical system. Visit a workshop. Volvo recommends that you seek assistance from an authorised Volvo workshop.

03



### Fault in brake system

If this symbol illuminates, the brake fluid level may be too low. Stop the car in a safe place and check the level in the brake fluid reservoir; see Brake and clutch fluid - level (p. 350).

If the brake and ABS symbols illuminate at the same time, there may be a fault in the brake force distribution system.

1. Stop the car in a safe place and turn off the engine.
2. Restart the engine.
  - If both symbols extinguish, continue driving.
  - If the symbols remain illuminated, check the level in the brake fluid reservoir; see Brake and clutch fluid - level (p. 350). If the brake fluid level is normal but the symbols are still illuminated, the car can be driven, with great care, to a workshop to have the brake system checked. Volvo recommends that you seek assistance from an authorised Volvo workshop.

### WARNING

If the brake fluid is under the **MIN** level in the brake fluid reservoir, do not drive further before topping up the brake fluid.

The loss of brake fluid must be investigated by a workshop. Volvo recommends that you contact an authorised Volvo workshop.

### WARNING

If the BRAKE and ABS symbols are lit at the same time, there is a risk that the rear end will skid during heavy braking.

### Warning

The red warning symbol illuminates when a fault has been indicated which could affect the safety and/or driveability of the car. An explanatory text is shown on the information display at the same time. The symbol remains visible until the fault has been rectified but the text message can be cleared with the **OK** button; see Menu navigation - combined instrument panel (p. 105). The warning symbol can also illuminate in conjunction with other symbols.

Action:

1. Stop in a safe place. Do not drive the car further.

2. Read the information on the information display. Implement the action in accordance with the message in the display. Clear the message using the **OK** button.

### Reminder – doors not closed

If one of the doors is not closed properly then the information or warning symbol illuminates together with an explanatory image in the information display. Stop the car in a safe place as soon as possible and close the door that is open.

 If the car is driven at a speed lower than approx. 7 km/h then the information symbol illuminates.

 If the car is driven at a speed higher than approx. 7 km/h then the warning symbol illuminates.

If the bonnet<sup>10</sup> is not closed properly then the warning symbol illuminates together with an explanatory image in the information display. Stop the car in a safe place as soon as possible and close the bonnet.

If the boot lid is not closed properly then the information symbol illuminates together with an explanatory image in the information display. Stop the car in a safe place as soon as possible and close the boot lid.

<sup>10</sup> Only cars with alarm\*.



## Related information

- Combined instrument panel (p. 59)
- Combined instrument panel - meaning of indicator symbols (p. 64)
- Digital combined instrument panel - overview (p. 60)

## Outside temperature gauge

The display for the outside temperature gauge appears in the combined instrument panel.

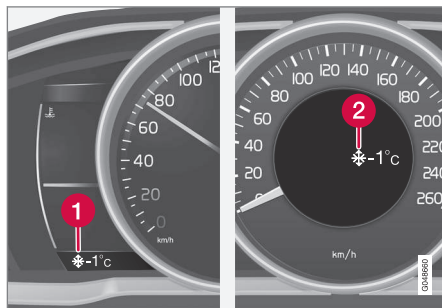

- 1 Display for outside temperature gauge, digital instrument panel
- 2 Display for outside temperature gauge, analogue instrument panel

When the temperature lies between +2 °C to -5 °C a snowflake symbol illuminates in the display. This warns of icy roads. If the car has been stationary, the gauge may display a reading that is too high.

## Related information

- Combined instrument panel (p. 59)

## Trip meter

The trip meter display appears in the combined instrument panel.



Trip meter, digital instrument.

- 1 Display for trip meter<sup>11</sup>

The two trip meters **T1** and **T2** are used for measuring short distances. The distance is shown in the display.

Turn the left stalk switch thumbwheel to show the required meter.

A long press (until the change occurs) on the left-hand stalk switch's **RESET** button resets the trip meter shown. For more information, see Trip computer - supplementary information (p. 118).

## Related information

- Combined instrument panel (p. 59)

<sup>11</sup> Display appearance may differ depending on instrument variant.



## Clock

The clock display appears in the combined instrument panel.



Clock, digital instrument panel.

- 1 Display for showing the time<sup>12</sup>

## Set the clock

The clock can be adjusted in the menu system MY CAR, see MY CAR (p. 108).

## Related information

- Combined instrument panel (p. 59)

## Licenses - combined instrument panel

A license is an agreement for the right to operate a certain activity or the right to use someone else's entitlement according to the terms and conditions in the agreement. The following text is Volvo's agreement with the manufacturer/developer.

### Combined Instrument Panel Software Open Source Software Notice

This product uses certain free / open source and other software originating from third parties, that is subject to the GNU Lesser General Public License version 2 (LGPLv2), The FreeType Project License ("FreeType License") and other different and/or additional copy right licenses, disclaimers and notices. The links to access the exact terms of LGPLv2, and the other open source software licenses, disclaimers, acknowledgements and notices are provided to you below. Please refer to the exact terms of the relevant License, regarding your rights under said licenses. Volvo Car Corporation (VCC) offers to provide the source code of said free/open source software to you for a charge covering the cost of performing such distribution, such as the cost of media, shipping and handling, upon written request. Please contact your nearest Volvo Dealer.

The offer is valid for a period of at least three (3) years from the date of the distribution of this product by VCC / or for as long as VCC offers spare parts or customer support.

Portions of this product uses software copyrighted © 2007 The FreeType Project ([www.freetype.org](http://www.freetype.org)). All rights reserved.

Portions of this product uses software with Copyright © 1994–2013 Lua.org, PUC-Rio (<http://www.lua.org/>)



### This product includes software under following licenses:

LGPL v2.1: <http://www.gnu.org/licenses/old-licenses/lgpl-2.1.html>

- • GNU FriBidi
- • DevIL

The FreeType Project License: <http://git.savannah.gnu.org/cgi/freetype/freetype2.git/tree/docs/FTL.TXT>

- • FreeType 2

<sup>12</sup> The time is shown in the centre of an analogue instrument panel.





MIT License: <http://opensource.org/licenses/mit-license.html>

- Lua



## Symbols in the display







There are a variety of different symbols in the display in the car. The symbols are divided into warning, indicator and information symbols. Shown below are the most common symbols with their meanings and a reference to where in the manual further information can be found.

 - Red warning symbol, illuminates when a fault has been indicated which could affect the safety and/or driveability of the car. An explanatory text is shown in the information display in the combined instrument panel at the same time.



 - Information symbol, illuminates in combination with text in the information display in the combined instrument panel, when a deviation in any of the car's systems has occurred. The information symbol can also illuminate in conjunction with other symbols.

## Warning symbols in the combined instrument panel

Symbol	Specification	See
	Low oil pressure	(p. 66)
	Parking brake applied	(p. 66), (p. 282)

Symbol	Specification	See
	Parking brake applied, alternative symbol	(p. 66)
	Airbags – SRS	(p. 28), (p. 66)
	Seatbelt reminder	(p. 25), (p. 66)
	Alternator not charging	(p. 66)
	Fault in brake system	(p. 66), (p. 279)
	Warning, safety mode	(p. 28), (p. 39), (p. 66), (p. 265)

## Control symbols in the combined instrument panel

Symbol	Specification	See
	ABL fault*	(p. 64), (p. 87)
	Emissions system	(p. 64)
	ABS fault	(p. 64), (p. 279)





Symbol	Specification	See
	Rear fog lamp on	(p. 64), (p. 87)
	Stability system, ESC (Electronic Stability Control)	(p. 64), (p. 183)
	Stability system, sport mode	(p. 64), (p. 183)
	Engine preheater (diesel)	(p. 64)
	Low level in fuel tank	(p. 64), (p. 140)
	Information, read display text	(p. 64)
	Main beam On	(p. 64), (p. 84)
	Left-hand direction indicators	(p. 64)
	Right-hand direction indicators	(p. 64)
	Start/Stop*, engine auto-stopped	(p. 64), (p. 275)

Symbol	Specification	See
	ECO function* on	(p. 64), (p. 277)
	Tyre pressure system*	(p. 64), (p. 317)

### Information symbols in the combined instrument panel

Symbol	Specification	See
	Cruise control*	(p. 188)
	Adaptive cruise control*	(p. 203)
	Adaptive cruise control*, time interval	(p. 190), (p. 193)
	Adaptive cruise control*, Distance Warning* (Distance Alert)	(p. 195), (p. 205)
	Radar sensor*	(p. 203), (p. 207), (p. 223)
-	-	-

Symbol	Specification	See	
	Windscreen sensor*, Camera sensor*, Laser sensor*	(p. 85), (p. 214), (p. 223), (p. 227), (p. 232)	
	Auto Brake*, Distance Warning* (Distance Alert), City Safety™, Collision warning system*	(p. 207), (p. 214), (p. 223)	
	ABL system*	(p. 87)	
	Driver Alert System*, Time for a break	(p. 226)	
	Driver Alert System*, Time for a break	(p. 227)	
	(P)!	Parking brake	(p. 282)
	Rain sensor*	(p. 96)	
	Active high beam, AHB (Active High Beam)*	(p. 85)	

03



# 03 Instruments and controls



Symbol	Specification	See
	Start/Stop*	(p. 275)
	Start/Stop*	(p. 275)
	Driver Alert System*, Lane Departure Warning (LDW)	(p. 227), (p. 232)
	Driver Alert System*, Lane Departure Warning*	(p. 230)
	Driver Alert System*, Lane Departure Warning*	(p. 232)
	Recorded speed information*	(p. 185)
	Engine block and passenger compartment heater*	(p. 140)

Symbol	Specification	See
	Engine block heater and passenger compartment heater* Service required	(p. 140)
	Activated timer*	(p. 140)
	Activated timer*	(p. 140)
	Low battery	(p. 140)
	Fuel filler flap, right-hand side	(p. 289)
	Gear shift indicator	(p. 260)
	Gear positions	(p. 261)
	Measuring the oil level	(p. 346)
-	-	-

## Information symbols in the roof console display

Symbol	Specification	See
	Seatbelt reminder	(p. 27)
	Airbag, passenger seat, activated	(p. 32)
	Airbag, passenger seat, deactivated	(p. 32)

## Related information

- Combined instrument panel - meaning of indicator symbols (p. 64)
- Combined instrument cluster - meaning of warning symbols (p. 66)
- Messages - handling (p. 107)



## Volvo Sensus

*Volvo Sensus is the heart of your personal Volvo experience. It is Sensus that provides information, entertainment and functions to simplify your ownership.*



When you are sitting in your car you want control, and in today's interconnected world, this includes information, communication and entertainment when it is most suitable for you. Sensus covers all our solutions that enable connection\* to the outside world, at the same time providing you with intuitive control over all the car's capabilities.

Volvo Sensus combines and presents many functions in several of the car's systems on the centre console's display screen. With Volvo Sensus the car can be personalised by means of an intuitive user interface. Settings can be made in Car settings, Audio and media, Climate control, etc.

With the centre console buttons and controls or the steering wheel's right-hand keypad\*

functions can be activated or deactivated and many different settings can be made.

With a press on **MY CAR** all settings related to the driving and control of the car are presented, such as City Safety, locks and alarm, automatic fan speed, setting the clock, etc.

With a press on the respective function **RADIO, MEDIA, TEL\***, **NAV\*** and **CAM\*** other sources, systems and functions can be activated, e.g. AM, FM, CD, DVD\*, TV\*, Bluetooth®, navigation\* and park assist camera\*.

For more information about all functions/systems, see the relevant section in the owner's manual or its supplement.

### Overview

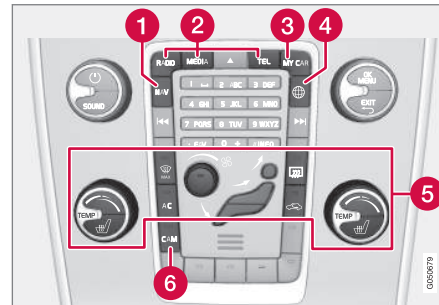

Control panel in centre console. The figure is schematic - the number of functions and layout

*of the buttons both vary, depending on the equipment selected and the market.*

- 1 Navigation\* - **NAV**, see separate supplement (Sensus Navigation).
- 2 Audio and media - **RADIO, MEDIA, TEL\***, see separate supplement (Sensus Infotainment).
- 3 Function settings - **MY CAR**, see MY CAR (p. 108).
- 4 Internet-connected car - **NAV\***, see separate supplement (Sensus Infotainment).
- 5 Climate control system (p. 121).
- 6 Park assist camera\* (p. 238) – **CAM\***.



## Key positions

The remote control key can be used to set the vehicle's electrical system in different modes/levels so that different functions are available; see *Key positions - functions at different levels* (p. 74).



Ignition switch with remote control key extracted/inserted.

## NOTE

For cars with the Keyless\* function the remote control key does not need to be inserted into the ignition switch but can be stored in e.g. a pocket. For more information on Keyless functions, see *Keyless drive\** (p. 166).

## Insert the remote control key

1. Hold the end of the remote control key with the detachable key blade and insert

the remote control key in the ignition switch.

2. Then press the remote control key in the lock up to its end position.

## IMPORTANT

Foreign objects in the ignition switch can impair the function or destroy the lock.

Do not press in the remote control key incorrectly turned - hold the end with the detachable key blade, see *Detachable key blade - detaching/attaching* (p. 162).

## Remove the remote control key

Push the remote control key, allow it to eject, then pull it out from the ignition switch.

## Key positions - functions at different levels

*In order to enable the use of a limited number of functions with the engine switched off, the car's electrical system can be set in 3 different levels (key positions) - 0, I and II - with the remote control key. Throughout this owner's manual these levels are described using the denomination "key positions".*

The following table shows the functions available in each key position/level.



Level	Functions
0	<ul style="list-style-type: none"> <li>• Odometer, clock and temperature gauge are illuminated.</li> <li>• Power seats can be adjusted.</li> <li>• The audio system can be used for a limited time - see the Sensus Infotainment supplement.</li> </ul>
I	<ul style="list-style-type: none"> <li>• Sunroof, power windows, 12V socket in the passenger compartment, navigation, phone, ventilation fan and wind-screen wipers can be used.</li> </ul>
II	<ul style="list-style-type: none"> <li>• The headlamps come on.</li> <li>• Warning/indicator lamps illuminate for 5 seconds.</li> <li>• Several other systems are activated. However, heating in seat cushions and the rear window can only be activated after the engine has been started.</li> </ul> <p><b>This key position consumes a lot of current from the starter battery and should therefore be avoided!</b></p>

### Choosing key position/level

- **Key position 0** - Unlock the car - This means that the car's electrical system is at level 0.
- **Key position I** - With the remote control key fully inserted into the ignition switch<sup>13</sup> - Briefly press **START/STOP ENGINE**.

#### NOTE

To reach level I or II **without** starting the engine - do **not** depress the brake/clutch pedal when these key positions are due to be selected.

- **Key position II** - With the remote control key fully inserted into the ignition switch<sup>13</sup> - Give a long<sup>14</sup> press on **START/STOP ENGINE**.
- **Back to key position 0** - To return to key position 0 from position II and I - Briefly press on **START/STOP ENGINE**.

### Audio system

For information on audio system functions with remote control key removed, see the Sensus Infotainment supplement.

### Starting and stopping the engine

For information about starting/stopping the engine, see Starting the engine (p. 252).

### Towing

For important information about the remote control key during towing, see Towing (p. 301).

### Related information

- Key positions (p. 74)

<sup>13</sup> Not necessary for cars with the Keyless\* function.

<sup>14</sup> Approx. 2 seconds.

### Seats, front

The car's front seats have different setting options for optimum seating comfort.

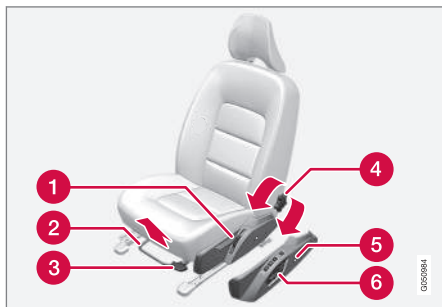

- 1 Raise/lower the seat, pump up/down.
- 2 Forward/backward: lift the handle to adjust the distance to the steering wheel and pedals. Check that the seat is locked after changing position.
- 3 Raise/lower\* front edge of seat cushion, pump up/down.
- 4 Adjust backrest rake, turn the wheel.
- 5 Change the lumbar support\*, press the button.
- 6 Control panel for power seat\*, see Seats, front - electrically operated\* (p. 77).

### WARNING

Adjust the position of the driver's seat before setting off, never while driving. Make sure that the seat is in locked position in order to avoid personal injury in the event of sudden braking or an accident.

### Lowering the passenger seat backrest\*

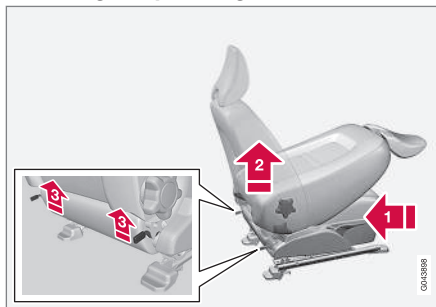

The passenger seat's backrest can be folded forward to make room for long loads.

- 1 Move the seat as far back/down as possible.
- 2 Adjust the backrest to an upright position.
- 3 Lift the catches on the rear of the backrest and fold it forward.
- 4 Push the seat forward so that the head restraint "locks" in under the glovebox.

Raising takes place in reverse order.

### WARNING

Grasp the backrest and make sure that it is properly locked after being folded up in order to avoid personal injury in the event of sudden braking or an accident.

### Related information

- Seats, front - electrically operated\* (p. 77)
- Seats, rear (p. 78)



### Seats, front - electrically operated\*

The car's front seats have different setting options for optimum seating comfort. The power seat can be moved forward/backward and up/down. The front edge of the seat cushion can be raised/lowered. The backrest angle and lumbar support\* can be changed.

#### Power seat

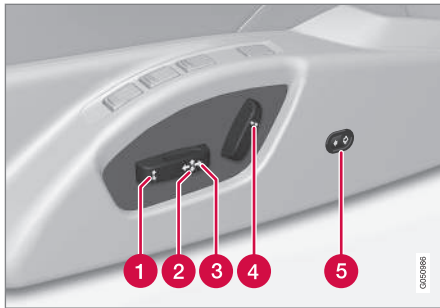

- 1 Front edge of seat cushion up/down
- 2 Raise/lower seat
- 3 Seat, forward/backward
- 4 Backrest rake
- 5 Lumbar support\* is adjusted inward and outward

The power seats have overload protection which is tripped if a seat is blocked by an

object. If this should happen, set the car's electrical system in key position **I** or **0** and wait a short time before adjusting the seat again.

Only one movement (forward/back/up/down/inward/outward) can be made at a time.

#### Preparations

The seat can be adjusted for a certain time after unlocking the door with the remote control key without the key in the ignition switch. Seat adjustment is normally made in key position **I** and can always be made when the engine is running.

#### Seat with memory function\*

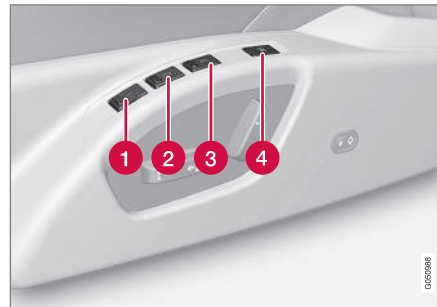

The memory function stores settings for the seat and the door mirrors.

#### Store setting

- 1 Memory button
- 2 Memory button
- 3 Memory button
- 4 Button for storing settings

1. Adjust the seat and the door mirrors.
2. Press and hold button **M** while pressing button **1**, **2** or **3** simultaneously. Hold the buttons depressed until the acoustic signal is heard and text is shown in the combined instrument panel.

The seat must be adjusted again before a new memory can be set.

The setting for lumbar support is not stored.

#### Using a stored setting

Press one of the memory buttons **1-3** until the seat and the door mirrors stop. If the button is released, the movement of the seat and door mirrors will be interrupted.

#### Key memory\* in remote control key

All remote control keys can be used by different drivers to store the settings for the driver's seat and door mirrors<sup>15</sup>, see Remote control key - personalisation\* (p. 156).

<sup>15</sup> Only if the car is equipped with power seat with memory and retractable power rearview and door mirrors. The setting for lumbar support is not stored.



## Emergency stop

If the seat accidentally begins to move, press one of the setting buttons for the seat or memory buttons in order to stop the seat.

Restarting to reach the seat position stored in the key memory is performed by pressing the unlock button on the remote control key. The driver's door must then be open.

### WARNING

Risk of crushing! Make sure that children do not play with the controls. Check that there are no objects in front of, behind or under the seat during adjustment. Ensure that none of the rear seat passengers is in danger of becoming trapped.

## Heated/ventilated seats\*

For heated seats/ventilated, see Heated front seats\* (p. 128) and Heated rear seat\* (p. 128).

## Related information

- Seats, front (p. 76)
- Seats, rear (p. 78)

## Seats, rear

*The rear seat backrest and the outer seat head restraints can be folded. The centre seat head restraint can be adjusted to suit the height of the passenger.*

## Lowering the rear seat backrest

### IMPORTANT

There must be no objects on the rear seat when the backrest is to be folded down. The seat belts must not be connected either. Otherwise there is a risk of damaging the rear seat upholstery.

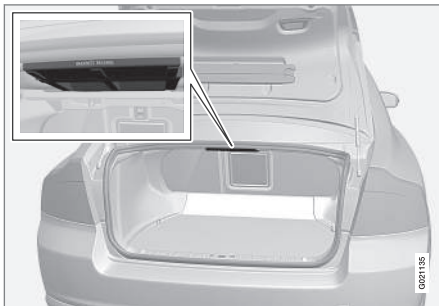

The backrest is in two parts. The parts can be folded forward, together or separately.

1. Pull the handle/handles.

2. Fold the backrest forward. Lower the centre head restraint fully if the backrest's wide section shall be lowered.

### WARNING

Take hold of the backrests and make sure they are locked properly after opening them out in order to prevent injury under hard braking or in the event of an accident.

## Head restraint, centre seat, rear



The head restraint can be adjusted vertically to suit the height of the passenger. The upper edge of the head restraint should be aligned with middle of the back of the head. Slide it up as required.

To lower the head restraint again, the button by the left-hand shaft must be pressed in while the head restraint is pressed down carefully.





### Electrical lowering of the rear seat's outer head restraints\*



1. The remote control key must be in key position **II**.
2. Press the button to lower the rear outer head restraints to improve rearward visibility.

#### **WARNING**

Do not lower the outer head restraints if there are any passengers using of the outer seats.

Move the head restraint back manually until a click is heard.

#### **WARNING**

The head restraints must be in locked position after being raised.

### Related information

- Seats, front (p. 76)
- Seats, front - electrically operated\* (p. 77)

### Steering wheel

The steering wheel can be adjusted in different positions and has controls for horn and cruise control, as well as menu, audio and phone control.

### Adjusting

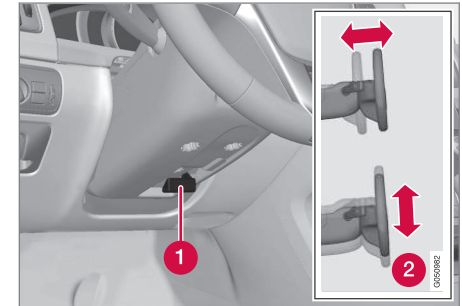

Adjusting the steering wheel.

- 1 Lever - releasing the steering wheel
- 2 Possible steering wheel positions

The steering wheel can be adjusted for both height and depth:

1. Pull the lever towards you to release the steering wheel.
2. Adjust the steering wheel to the position that suits you.



# 03 Instruments and controls



3. Push back the lever to fix the steering wheel in place. If the lever is stiff, press the steering wheel lightly at the same time as you push the lever back.

## **WARNING**

Adjust the steering wheel and fix it before driving away.

With speed related power steering\* the level of steering force can be adjusted, see Adjustable steering force\* (p. 245).

## Keypads\* and paddles\*

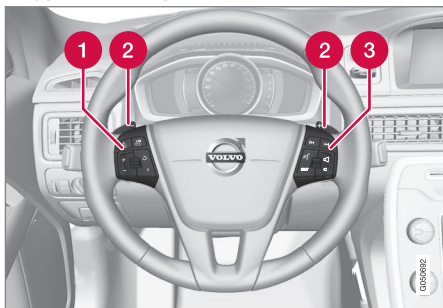

Keypads and paddles in the steering wheel.

- 1 Cruise control\* (p. 188)

Adaptive cruise control - ACC\* (p. 190)

- 2 Paddle for manual gear changing in an automatic gearbox, see Automatic gearbox -- Geartronic\* (p. 261)
- 3 Audio and phone control, see supplement, Sensus Infotainment

## Horn



Horn.

Press the centre of the steering wheel to signal.

## Related information

- Heating\* of the steering wheel (p. 80)

## Heating\* of the steering wheel

The steering wheel can be heated with electric heating.

## Function

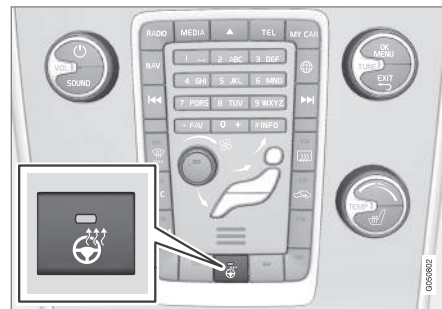

Button position may vary depending on equipment selected and market.

Repeatedly **press the button** to switch between the following functions:

Function	Indicator
Switched off	Button lamp extinguished
Heating	Button lamp illuminated

## Automatic steering wheel heating

With activated automatic start of steering wheel heating, the heating of the steering wheel starts when the engine is started. Automatic start takes place when the car is cold and the ambient temperature is below



approx. 10 °C. Activate/deactivate the function in the menu system **MY CAR** (p. 108).

## Light switches

The headlamp control activates and adjusts the external lighting. It is also used to adjust display and instrument lighting and mood lighting (p. 90).

### Overview, light switches

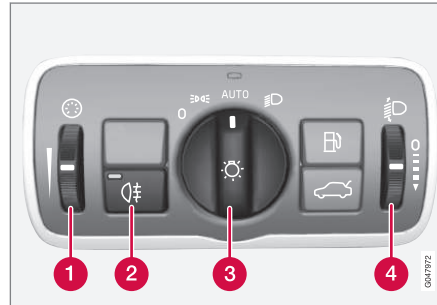

Overview, light switches.

- 1 Thumbwheel for adjusting display and instrument lighting as well as ambient lighting\*
- 2 Button for rear fog lamp
- 3 Knob for daytime running lights and parking lamps
- 4 Thumbwheel<sup>16</sup> for headlamp levelling

### Knob positions

Position	Specification
0	Daytime running lights <sup>A</sup> when the car's electrical system is in key position II or the engine is running. Main beam flash can be used.
☰☱☲☳	Daytime running lights, side marker lamps rear and position/parking lamps when the car's electrical system is in key position II or the engine is running. Side marker lamps rear and position/parking lamps when the car is parked. Main beam flash can be used.
AUTO	Daytime running lights, side marker lamps rear and position/parking lamps in daylight when the car's electrical system is in key position II or the engine is running. Dipped beam, side marker lamps rear and position/parking lamps in weak daylight or darkness, or when the rear fog lamp

03

<sup>16</sup> Not available for cars equipped with active Xenon headlamps\*.



Position	Specification
	<p>or windscreen wipers with continuous wiping are activated.</p> <p>The tunnel detection (p. 84)* function is activated.</p> <p>The active high beam (p. 85)* function can be used.</p> <p>Main beam can be activated when dipped beam is switched on.</p> <p>Main beam flash can be used.</p>
	<p>Dipped beam, side marker lamps rear and position/parking lamps.</p> <p>Main beam can be activated.</p> <p>Main beam flash can be used.</p>

A Fitted in or under the front bumper.

Volvo recommends that **AUTO** mode is used when the car is being driven, as long as traffic situations or weather conditions are unfavourable for the Active high beam\* function.

### Instrument lighting

Different display and instrument lighting is switched on depending on key position; see Key positions - functions at different levels (p. 74).

The display lighting is automatically subdued in darkness - the sensitivity is set with the thumbwheel.

The intensity of the instrument lighting is adjusted with the thumbwheel.

### Headlamp levelling

The load in the car changes the vertical alignment of the headlamp beam, which could dazzle oncoming motorists. Avoid this by adjusting the height of the beam. Lower the beam if the car is heavily laden.

1. Leave the engine running, or have the car's electrical system in key position I.
2. Roll the thumbwheel up/down to raise/lower beam alignment.

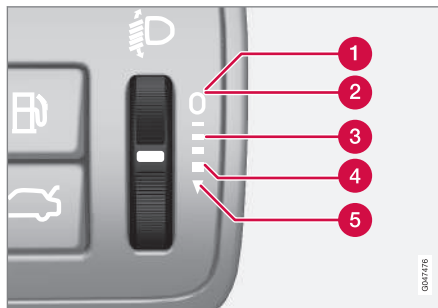

Thumbwheel positions for different load cases.

- 1 Only driver
- 2 Driver and passenger in the front passenger seat

- 3 Occupants in all seats
- 4 Occupants in all seats and maximum load in the cargo area
- 5 The driver and maximum load in the cargo area

Cars with active Xenon headlamps\* have automatic headlamp levelling and are therefore not equipped with the thumbwheel.

### Related information

- Position/parking lamps (p. 83)
- Daytime running lights (p. 83)
- Main/dipped beam (p. 84)



### Position/parking lamps

Position/parking lamps are switched on with the headlamp control's knob.



Knob for headlamp control in the position for position/parking lamps.

Turn the knob to the position for  (number plate lighting is switched on at the same time).

If the car's electrical system is in key position **II** or the engine is running then the daytime running lights also switch on.

When it is dark outside and the boot lid is opened the rear position/parking lamps illuminate to alert traffic behind. This takes place irrespective of what position the knob is in or what key position the car's electrical system is in.

### Related information

- Light switches (p. 81)

### Daytime running lights

With the knob for headlamp control in **AUTO** position, and the car's electrical system in key position **II** or the engine running, the daytime running lights are activated automatically in daylight.

### Daytime running lights during the day. DRL



Knob for headlamp control in **AUTO** position.

With the knob for headlamp control in **AUTO** position the daytime running lights (Daytime Running Lights - DRL) are activated automatically when the car is driven in daylight. A light sensor on the top of the instrument panel changes from daytime running lights to dipped beam at twilight or when daylight becomes too weak. Switching to dipped beam also takes place when the windscreen wipers or rear fog lamps are activated.

### WARNING

This system help to save energy - it cannot determine in all situations when daylight is too weak or sufficiently strong, e.g. in mist and rain.

The driver is always responsible for ensuring that the car is driven with the correct beam pattern for the traffic situation and in accordance with applicable traffic regulations.

## Tunnel detection\*

Tunnel detection changes the lighting from daytime running lights to dipped beam when the car is driven into a tunnel. Approx. 20 seconds after the car has left the tunnel, the lighting returns to daytime running lights.

The tunnel detection function is available in cars with rain sensor\*. The sensor detects the entrance to a tunnel and resets the lighting from daytime running lights to dipped beam. Approx. 20 seconds after the car has left the tunnel, the lighting returns to daytime running lights. If the car is driven into another tunnel within this time period then dipped beam is kept switched on. This avoids repeated changes to the car's lighting.

Note that the headlamp control's knob must remain in **AUTO** position for tunnel detection to work.

## Related information

- Main/dipped beam (p. 84)
- Light switches (p. 81)



## Main/dipped beam

With the knob for headlamp control in position **AUTO** and the car's electrical system in key position **II** or the engine running, the dipped beam is activated automatically in poor light conditions.

With the knob for headlamp control in position  dipped beam is always switched on when the engine is running or when key position **II** is active.



Stalk switch and knob for headlamp control.

-  Position for main beam flash
-  Position for main beam

## Dipped beam

With the knob in **AUTO** position, dipped beam is activated automatically at twilight or when daylight becomes too weak. Dipped beam is also activated automatically if the windscreen wipers or rear fog lamps are activated.

With the knob in position  dipped beam is always switched on when the engine is running or when key position **II** is active.

## Main beam flash

Move the stalk switch gently towards the steering wheel to the position for main beam flash. Main beam comes on until the stalk switch is released.

## Main beam

Main beam can be activated when the knob is in position **AUTO**<sup>17</sup> or . Activate/deactivate main beam by moving the stalk switch towards the steering wheel to the end position and then releasing.

When main beam has been activated the  symbol illuminates in the combined instrument panel.

## Auxiliary lamps\*

If the car has auxiliary lamps, the driver can use the MY CAR menu system to choose whether they should be deactivated or

<sup>17</sup> When dipped beam is switched on.



switched on/off simultaneously with the main beam<sup>18</sup>, see MY CAR (p. 108).

### Related information

- Active Xenon headlamps\* (p. 87)
- Active high beam\* (p. 85)
- Light switches (p. 81)
- Headlamps - adjusting headlamp pattern (p. 92)
- Tunnel detection\* (p. 84)

### Active high beam\*

*The Active High Beam function detects the headlamp beams of oncoming traffic or the rear lights of vehicles in front, and switches the lighting from main beam to dipped beam. The lighting returns to main beam when the incoming light has stopped.*

### Active high beam - AHB

Active high beam (Active High Beam - AHB) is a function which uses a camera sensor at the top edge of the windscreen to detect the headlamp beams of oncoming traffic or the rear lights of vehicles in front, and then switches from main beam to dipped beam. The function can also take streetlights into account.

The lighting returns to main beam about a second after the camera sensor no longer detects the headlamp beams from oncoming traffic or the rear lights from vehicles in front.

### Activating/deactivating

AHB can be activated when the headlamp control's knob is in position **AUTO** (provided that the function has not been deactivated in the menu system MY CAR, see MY CAR (p. 108)).





Stalk switch and knob for headlamp control in **AUTO** position.

The function can start while driving in the dark when the car's speed is 20 km/h or higher.

Activate/deactivate AHB by moving the left-hand stalk switch towards the steering wheel to the end position and then releasing. Deactivation when main beam is on means that the lights are reset directly to dipped beam.

### Car with analogue combined instrument panel

When AHB is activated the  symbol illuminates in the instrument's information display.

When main beam is switched on the  symbol also illuminates in the combined instrument panel.

<sup>18</sup> Auxiliary lamps must be connected to the electrical system by a workshop. Volvo recommends that you contact an authorised Volvo workshop.



## Car with digital combined instrument panel

When AHB is activated the  symbol turns white in the instrument's information display.

When main beam is activated, the symbol turns blue.



### Manual operation



#### NOTE

Keep the windscreen surface in front of the camera sensor free from ice, snow, mist and dirt.

Do not stick or attach anything to the windscreen in front of the camera sensor as this may reduce effectiveness or cause one or more of the systems dependent on the camera to stop working.

If the message **Active main beam Temporary unavailable** Switch manually is shown in the combined instrument panel's information display then you have to switch manually between main and dipped beam. However, the knob for headlamp control can still remain in position **AUTO**. The same applies if the message **Windscreen sensors blocked** See manual and the  symbol are shown. The  symbol goes out when these messages are shown.

AHB may be temporarily unavailable e.g. in situations with dense fog or heavy rain. When AHB becomes available again, or the windscreen sensors are no longer blocked, the message extinguishes and the  symbol illuminates.



#### WARNING

AHB is an aid for using the optimum beam pattern when conditions are favourable.

The driver always bears responsibility for manually switching between main and dipped beam when traffic situations or weather conditions so require.



#### IMPORTANT

Examples of when manual switching between main and dipped beam may be required:

- In heavy rain or dense fog
- In freezing rain
- In snow flurries or slush
- In moonlight
- When driving in poorly lit built-up areas
- When the traffic ahead has weak lighting
- If there are pedestrians on or beside the road
- If there are highly reflective objects such as signs in the vicinity of the road
- When the lighting from oncoming traffic is obscured by e.g. a crash barrier
- When there is traffic on connecting roads
- On the brow of a hill or in a hollow
- In sharp bends.

For more information on the limitations of the camera sensor, see Collision warning system\* - camera sensor limitations (p. 221).

#### Related information

- Main/dipped beam (p. 84)
- Light switches (p. 81)





### Active Xenon headlamps\*

Active Xenon headlamps are designed to provide maximum illumination in bends and junctions and so provide increased safety.

#### Active Xenon headlamps ABL

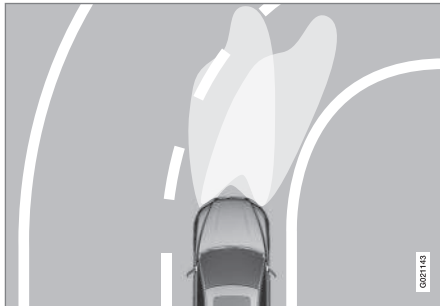

Headlamp pattern with function deactivated (left) and activated (right) respectively.

If the car is equipped with active Xenon headlamps (Active Bending Lights – ABL) the light from the headlamps follows the steering wheel movement in order to provide maximum lighting in bends and junctions and so provide increased safety.

The function is activated automatically when the car is started (provided that it has not been deactivated in the menu system MY CAR, see MY CAR (p. 108)). In the event of a fault in the function the  symbol illu-

minates in the combined instrument panel at the same time as the information display shows an explanatory text and a further illuminated symbol.

Symbol	Message	Specification
	<b>Headlamp system malfunction Service required</b>	The system is disengaged. Visit a workshop if the message remains. Volvo recommends that you contact an authorised Volvo workshop.

The function is only active in twilight or darkness and only when the car is moving.

The function<sup>19</sup> can be deactivated/activated in the menu system MY CAR, see MY CAR (p. 108).

For headlamp pattern adjustment, see Headlamps - adjusting headlamp pattern (p. 92).

#### Related information

- Main/dipped beam (p. 84)
- Active high beam\* (p. 85)
- Light switches (p. 81)

### Rear fog lamp

When visibility is reduced by fog the rear fog lamp can be used so that other road users shall notice vehicles in front at an early stage.

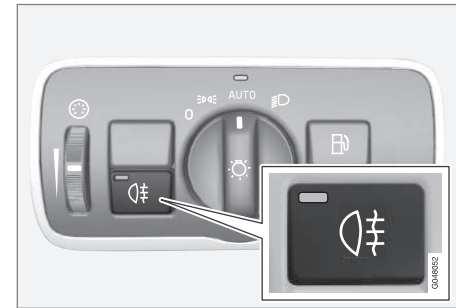

Button for rear fog lamp.

The rear fog lamp can only be switched on when key position II is active or the engine is running and the headlamp control's knob is in position **AUTO** or .

Press the button for On/Off. The rear fog lamp's indicator symbol  in the combined instrument panel and the light in the button both illuminate when the rear fog lamp is switched on.

The rear fog lamp is switched off automatically when the engine is switched off or when

<sup>19</sup> Activated on delivery from the factory.



the headlamp control's knob is turned to position **0** or **☰☱**.



### NOTE

Regulations on the use of rear fog lamps vary from country to country.

### Related information

- Light switches (p. 81)

### Brake lights

*The brake light automatically comes on during braking.*

The brake light is switched on when the brake pedal is depressed. In addition, it is switched on when one of driving support systems Adaptive cruise control (p. 190), City Safety (p. 208) or Collision warning system (p. 215) brakes the car.

For information on emergency brake lights and automatic hazard warning flashers, see Foot brake - emergency brake lights and automatic hazard warning flashers (p. 280).

### Hazard warning flashers

*The hazard warning flashers warn other road users by means of all of the car's direction indicator lamps flashing simultaneously when this function is activated.*

*When the hazard warning flashers are activated both direction indicator symbols flash in the combined instrument panel.*



Button for hazard warning flashers.

Press the button to activate the hazard warning flashers. Both direction indicator symbols in the combined instrument panel flash when the hazard warning flashers are used.

The hazard warning flashers are activated automatically when the car has been braked so suddenly that the emergency brake lights have been activated at a speed below 10 km/h. The hazard warning flashers remain on when the car has stopped and are deactivated automatically when the car is driven off



again or the button is depressed. For more information on emergency brake lights and automatic hazard warning flashers, see Foot brake - emergency brake lights and automatic hazard warning flashers (p. 280).

### Related information

- Direction indicators (p. 89)

### Direction indicators

*The car's direction indicators are operated with the left-hand stalk switch. The direction indicator lamps flash three times or continuously, depending on how far up or down the stalk switch is moved.*

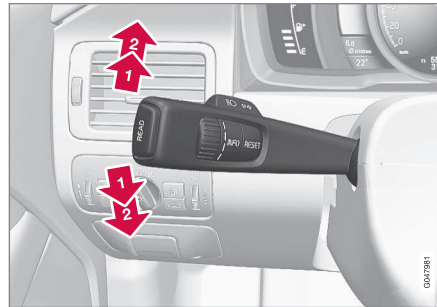

Direction indicators.

### Short flash sequence

- 1 Move the stalk switch up or down to the first position and release. The direction indicator lamps flash three times. The function can be activated/deactivated in the menu system MY CAR, see MY CAR (p. 108).

### Continuous flash sequence

- 2 Move the stalk switch up or down to the outer position.

The stalk switch remains in its position and is moved back manually, or automatically by the steering wheel movement.

### Direction indicator symbols

For direction indicator symbols, see Combined instrument panel - meaning of indicator symbols (p. 64).

### Related information

- Hazard warning flashers (p. 88)

## Interior lighting

The passenger compartment lighting is activated/deactivated with the buttons in the controls above the front seats and the rear seat.



Controls in roof console for the front reading lamps and passenger compartment lighting.

- 1 Reading lamp, left-hand side
- 2 Reading lamp, right-hand side
- 3 Interior lighting

All lighting in the passenger compartment can be switched on and off manually within 30 minutes from when:

- the engine has been switched off and the car's electrical system is in key position **0**
- the car has been unlocked but the engine has not been started.

## Front roof lighting

The front reading lamps are switched on or off by pressing the relevant button in the roof console.

## Rear roof lighting



Rear roof lighting.

The lamps are switched on or off by pressing each respective button.

## Courtesy lighting

Courtesy lighting (and passenger compartment lighting) is switched on and off respectively when a side door is opened or closed.

## Glovebox lighting

Glovebox lighting is switched on and off respectively when the lid is opened or closed.

## Vanity mirror lighting

The lighting for the vanity mirror (p. 148) is switched on and off respectively when the cover is opened or closed.

## Automatic lighting

The switch for passenger compartment lighting has three positions for the lighting in the passenger compartment:

- **Off** – right-hand side pressed in, automatic lighting deactivated.
- **Neutral position** – automatic lighting activated.
- **On** – left-hand side pressed in, passenger compartment lighting switched on.

## Neutral position

When the button is in neutral position the passenger compartment lighting is switched on and off automatically in accordance with the following.

The passenger compartment lighting is switched on and remains on for 30 seconds if:

- the car is unlocked with the remote control key or key blade, see Remote control key - functions (p. 158) or Detachable key blade - unlocking doors (p. 163)
- the engine has been switched off and the car's electrical system is in key position **0**.

Passenger compartment lighting is switched off when:

- the engine is started
- the car is locked.



The passenger compartment lighting comes on and remains on for two minutes if one of the doors is open.

If any lighting is switched on manually and the car is locked then it will be switched off automatically after two minutes.

### Mood lights\*

When the normal passenger compartment lighting is switched off and the engine is running, a number of LEDs illuminate, including one in the ceiling lighting, in order to provide a low-light and enhance the mood while driving. The light also makes it easier to see objects in storage compartments etc. during the darker hours of the day. This lighting goes out for a little while after the normal passenger compartment lighting when the car is locked. The brightness is controlled using the thumbwheel on the headlamp control (p. 81).

### Home safe light duration

*Home safe lighting consists of dipped beam, parking lamps, lamps in the door mirrors, number plate lighting, interior roof lighting as well as courtesy lighting.*

Some of the exterior lighting can be kept switched on to work as home safe lighting after the car has been locked.

1. Remove the remote control key from the ignition switch.
2. Move the left-hand stalk switch toward the steering wheel to the end position and release it. The function can be activated in the same way as with main beam flash; see Main/dipped beam (p. 84).
3. Get out of the car and lock the door.

When the function is activated, dipped beam, parking lamps, door mirror lamps, number plate lighting, interior roof lamps and courtesy lighting are switched on.

The length of time for which the home safe lighting should be kept on can be set in the menu system MY CAR, see MY CAR (p. 108).

### Related information

- Approach lighting (p. 91)

### Approach lighting

*Approach lighting consists of parking lamps, lamps in the door mirrors, number plate lighting, interior roof lighting as well as courtesy lighting.*

Approach lighting is switched on with the remote control key, see Remote control key - functions (p. 158), and is used to switch on the car's lighting at a distance.

When the function is activated with the remote control, the parking lamps, door mirror lamps, number plate lighting, interior roof lamps and courtesy lighting are switched on.

The length of time for which the approach lighting should be kept on can be set in the menu system MY CAR, see MY CAR (p. 108).

### Related information

- Home safe light duration (p. 91)

## Headlamps - adjusting headlamp pattern

The headlamp pattern must be adjusted to avoid dazzling oncoming motorists and can be set for right or left-hand traffic.

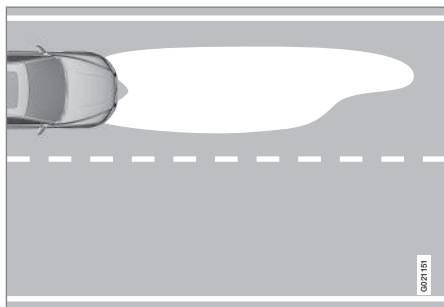

Headlamp pattern, left-hand traffic.

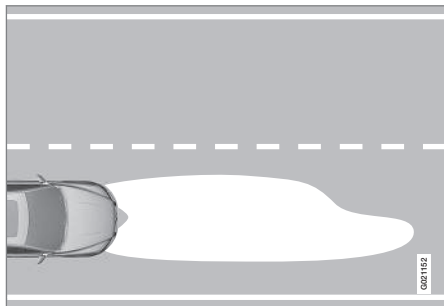

Headlamp pattern, right-hand traffic.

## Active Xenon headlamps\*

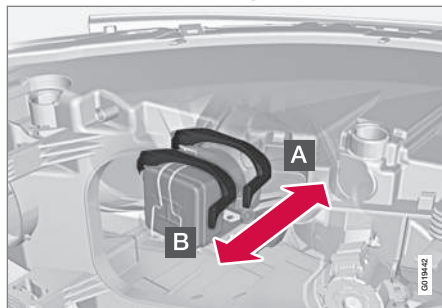

Headlamp control for adjusting headlamp pattern.

- A** Normal position – the headlamp pattern is correct for the country in which the car was delivered.
- B** Adapted position – designed for opposite headlamp pattern.

### WARNING

The headlamps must be handled with extreme caution due to the Xenon lamp being supplied by a high-voltage unit.

The country in which the car is delivered determines whether normal position is designed for right or left-hand traffic.

### Example 1

If a car that is delivered in Sweden shall be driven in the UK then the headlamps must be

set to the adjusted position, see preceding illustration.

### Example 2

A car that is delivered in the UK is designed for left-hand traffic and is driven there with the headlamps in normal position, see preceding illustration.

### Halogen headlamps

The headlamp pattern for halogen headlamps is readjusted by masking the headlamp lens. The headlamp pattern may not be as good.



### Masking the headlamps

1. Copy the A and B templates for left-hand drive cars or the C and D templates for right-hand drive cars, see the later section "Templates for halogen headlamps":
  - A = LHD Right (left-hand drive, right lens)
  - B = LHD Left (left-hand drive, left lens)
  - C = RHD Right (right-hand drive, right lens)
  - D = RHD Left (right-hand drive, left lens)
2. Transfer the template to a self-adhesive waterproof material and cut it out.
3. Start from the design line on the headlamp lenses; see the dotted line in the following figure. Position the self-adhesive templates at the right distance from each design line using the illustration and the dimensions in the following list:
  - A = LHD Right - approx. 86 mm
  - B = LHD Left - approx. 40 mm
  - C = RHD Right - 0 mm
  - D = RHD Left - approx. 96 mm



03



Upper row: left-hand drive cars, templates A and B. Lower row: right-hand drive cars, templates C and D.





Templates for halogen headlamps

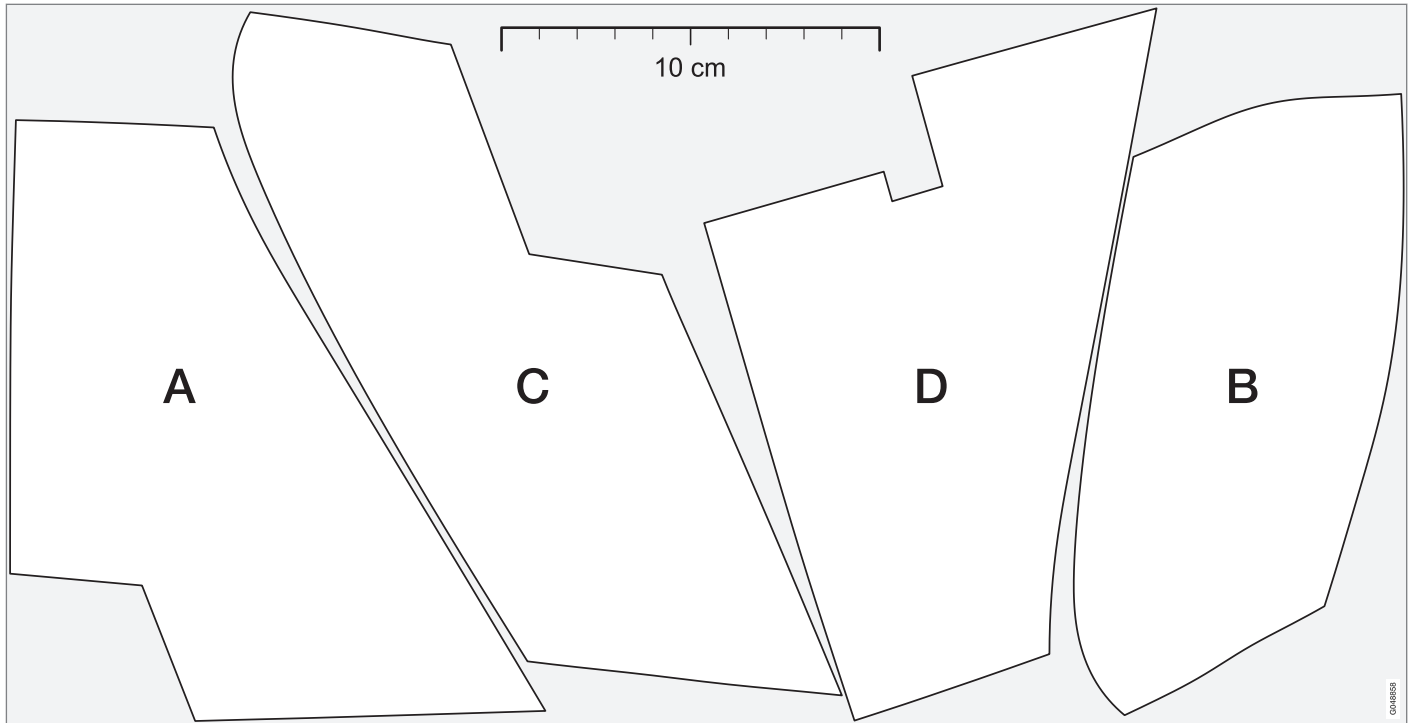

03

## Wipers and washing

Wipers and washers clean the windscreen and rear window. The headlamps are cleaned with high-pressure washing.

### Windscreen wipers<sup>20</sup>



Windscreen wipers and windscreen washers.

- 1 Rain sensor, on/off
- 2 Thumbwheel sensitivity/frequency

### Windscreen wipers off

- 0 Move the stalk switch to position 0 to switch off the windscreen wipers.



### Single sweep

-  Raise the stalk switch and release to make one sweep.

### Intermittent wiping

-  Set the number of sweeps per time unit with the thumbwheel when intermittent wiping is selected.

### Continuous wiping

-  The wipers sweep at normal speed.
-  The wipers sweep at high speed.

### ! IMPORTANT

Before activating the wipers during winter - ensure that the wiper blades are not frozen in, and that any snow or ice on the windscreen is scraped away.

### ! IMPORTANT

Use plenty of washer fluid when the wipers are cleaning the windscreen. The windscreen must be wet when the windscreen wipers are operating.

### Service position wiper blade

For cleaning the windscreen/wiper blades and replacement of wiper blades, see Wiper blades (p. 359) and Car washing (p. 380).

### Rain sensor\*

The rain sensor automatically starts the windscreen wipers based on how much water it

detects on the windscreen. The sensitivity of the rain sensor can be adjusted using the thumbwheel.

When the rain sensor is activated a lamp in the button is illuminated and the rain sensor symbol  is shown in the combined instrument panel.

### Activating and setting the sensitivity

When activating the rain sensor, the car must be running or the remote control key in position I or II while the windscreen wiper stalk switch must be in position 0 or in the position for a single sweep.

Activate the rain sensor by pressing the button . The windscreen wipers make one sweep.

Press the stalk switch up for the wipers to make an extra sweep.

Turn the thumbwheel upward for higher sensitivity and downward for lower sensitivity. (An extra sweep is made when the thumbwheel is turned upward.)

### Deactivate

Deactivate the rain sensor by pressing the button  or move the stalk switch down to another wiper program.

<sup>20</sup> For replacing the wiper blades and service position wiper blades, see Wiper blades (p. 359). For filling washer fluid, see Washer fluid - filling (p. 361).



The rain sensor is automatically deactivated when the remote control key is removed from the ignition switch or five minutes after the engine has been switched off.

### IMPORTANT

The windscreen wipers could start and be damaged in an automatic car wash. Switch off the rain sensor while the car is in motion or when the remote control key is in position I or II. The symbol in the combined instrument panel and the lamp in the button go out.

### Washing the headlamps and windows



Washing function.

### Washing the windscreen

Move the stalk switch toward the steering wheel to start the windscreen and headlamp washers.

The windscreen wipers will make several more sweeps and the headlamps are washed once the stalk switch has been released.

### Heated washer nozzles\*

The washer nozzles are heated automatically in cold weather to prevent the washer fluid freezing solid.

### High-pressure headlamp washing\*

High-pressure headlamp washing consumes a large quantity of washer fluid. To save fluid, the headlamps are washed automatically at every fifth windscreen wash cycle.

### Reduced washing

If only approx. 1 litre of washer fluid remains in the reservoir and the message that you should fill the washer fluid is shown in the combined instrument panel, then the supply of washer fluid to the headlamps is switched off. This is in order to prioritise cleaning the windscreen and the visibility through it.

### Related information

- Washer fluid - filling (p. 361)
- Washer fluid - quality and volume (p. 402)

### Power windows

All power windows can be operated using the control panel for the driver's door - the control panels for the other doors operate their respective power window.



Driver's door control panel.

- 1 Switch for electric child safety locks\* and disengaging rear power window buttons; see Child safety locks - electrical activation\* (p. 175).
- 2 Rear window controls
- 3 Front window controls



### WARNING

Check that no rear seat passengers are trapped when the windows are closed from the driver's door.



## WARNING

Check that children or other passengers are not trapped if the windows are closed, even when the remote control key is used.

## WARNING

If there are children in the car - remember to always switch off the power supply to the power windows by selecting key position **0** and then take the remote control key with you when leaving the car. For information on key positions - see Key positions - functions at different levels (p. 74).

03

### Operating



Operating the power windows.

- Operating without auto
- Operating with auto

All power windows can be operated using the control panel for the driver's door - the control panels for the other doors can only each operate their respective power window. Only one control panel can be operated at a time.

In order for the power windows to be used, the key position must be at least **I** - see Key positions - functions at different levels (p. 74). The power windows can be operated for a few minutes after the engine has been switched off and after the remote control key has been removed - although not after a door has been opened.

Closing of the windows is stopped and the window is opened if anything prevents its movement. It is possible to force the pinch protection when closing has been interrupted, e.g. with ice, by continuously holding the button up until the window is closed. The pinch protection is reactivated after a brief pause.

## NOTE

One way to reduce the pulsating wind noise when the rear windows are open is to also open the front windows slightly.

### Operating without auto

Move one of the controls up/down gently. The power windows move up/down as long as the control is held in position.

### Operating with auto

Move one of the controls up/down to the end position and release it. The window runs automatically to its end position.

### Operating with the remote control key and central locking

To remotely operate the power windows from the outside with the remote control key or from inside with central locking, see Remote control key (p. 155) and Locking/unlocking - from the inside (p. 171).

### Resetting

If the battery is disconnected then the function for automatic opening must be reset so that it can work correctly.

1. Gently raise the front section of the button to raise the window to its end position and hold it there for one second.
2. Release the button briefly.
3. Raise the front section of the button again for one second.

## WARNING

A reset must take place for pinch protection to work.



### Sun blind\*

Sun blinds are built into the panel on each rear door.

There is a sun blind built into the rear parcel shelf.

#### Rear door

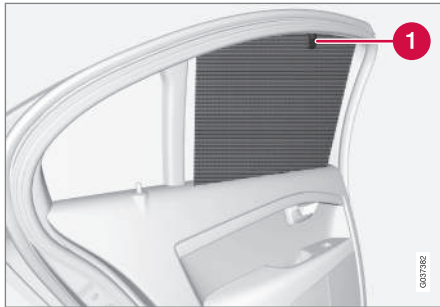

**1** Hook with associated catch

1. Pull up the sun blind and hook it into the hook in the upper door frame.
2. Lock the sun blind by moving the catch upwards.

The window can also be opened and closed when the sun blind is pulled up.

#### Rear window

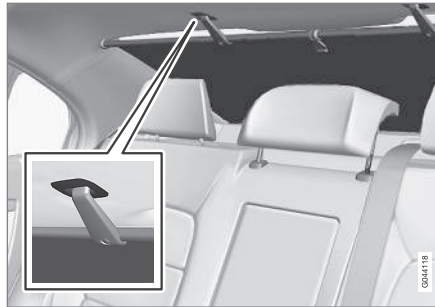

- Pull up the sun blind and hook it into the roof clip using the two hooks for the blind.
  - > The spring force in the blind keeps the hooks in position.

When the sun blind is not in use - unhook it, hold onto the handle and allow the blind to roll up slowly.

### Door mirrors

The door mirror positions are adjusted with the joystick in the driver's door controls.



Door mirror controls.

#### Adjusting

1. Press the **L** button for the left-hand door mirror or the **R** button for the right-hand door mirror. The light in the button illuminates.
2. Adjust the position with the joystick in the centre.
3. Press the **L** or **R** button again. The light should no longer be illuminated.



## **WARNING**

Both mirrors are the wide-angle type to provide optimal vision. Objects may appear further away than they actually are.

### Storing settings<sup>21</sup>

The settings for the rearview and door mirrors and the positions of the driver's seat can be stored for each remote control key in the car key memory\*, see Remote control key - personalisation\* (p. 156).

### Angling the door mirror when parking<sup>21</sup>

The door mirror can be angled down for the driver to view the side of the road when parking for example.

- Engage reverse gear and press the **L** or **R** button.

When reverse gear is disengaged the mirror automatically returns to its original position after approx. 10 seconds, or earlier by pressing the button labelled **L** or **R** respectively.

### Automatic angling of the door mirror when parking<sup>21</sup>

When reverse gear is engaged the door mirror is automatically angled down so that the driver can see the side of the road when parking for example. When reverse gear is disengaged the mirror automatically returns to its original position after a short time.

The function can be activated/deactivated in the menu system MY CAR, see MY CAR (p. 108).

### Automatic retraction when locking<sup>21</sup>

When the car is locked/unlocked with the remote control key the door mirrors are automatically retracted/extended.

The function can be activated/deactivated in the menu system MY CAR, see MY CAR (p. 108).

### Resetting to neutral

Mirrors that have been moved out of position by an external force must be reset electrically to the neutral position for electric retracting/extending to work correctly:

1. Retract the mirrors with the **L** and **R** buttons.
2. Fold them out again with the **L** and **R** buttons.
3. Repeat the above procedure as necessary.

The mirrors are now reset in neutral position.

### Retractable power door mirrors\*

The mirrors can be retracted for parking/driving in narrow spaces:

1. Depress the **L** and **R** buttons simultaneously (key position must be at least I).

2. Release them after approximately 1 second. The mirrors automatically stop in the fully retracted position.

Fold out the mirrors by pressing down the **L** and **R** buttons simultaneously. The mirrors automatically stop in the fully extended position.

### Home safe and approach lighting

The lamp on the door mirrors illuminates when approach lighting (p. 91) or home safe lighting (p. 91) is selected.

### Related information

- Rearview mirror - interior (p. 101)
- Windows and rearview and door mirrors - heating (p. 101)

<sup>21</sup> Only in combination with power seat with memory, see Seats, front - electrically operated\* (p. 77).

\* Option/accessory, for more information, see Introduction.



## Windows and rearview and door mirrors - heating

The defroster is used to quickly remove misting and ice from the windscreen, rear window and door mirrors.

### Heated windscreen\*, rear window and door mirrors

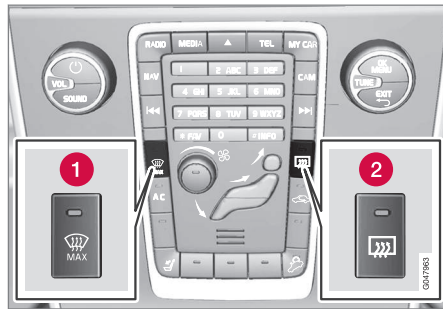

- 1 Heating, windscreen
- 2 Heating, rear window and door mirrors

The function is used to remove ice and misting from the windscreen, rear window and door mirrors.

One press of the respective button starts the heating. The light in the button indicates that the function is active. Switch off the heating as soon as the ice/misting is cleared in order not to load the battery unnecessarily. However, the function is switched off automati-

cally after a certain time. Following which, rear window heating is switched on and off automatically as long as the outside temperature is lower than +7 °C.

#### **i** NOTE

Rear window heating is not switched on and off automatically if the Eco function is activated, but then remains switched off, even in outside temperatures below +7 °C. For information about the Eco function, see ECO\* (p. 277).

See also Demisting and defrosting the windscreen (p. 131).

The door mirrors and rear window are demisted/defrosted automatically if the car is started in an outside temperature lower than +7 °C. Automatic defrosting can be selected in the menu system MY CAR, see MY CAR (p. 108).

## Rearview mirror - interior

The interior rearview mirror can be dimmed with a control in the mirror's lower edge. Alternatively, the rearview mirror dims automatically.



- 1 Control for dimming

### Manual dimming

Bright light from behind could be reflected in the rearview mirror and dazzle the driver. Use dimming with the dimming control when lights from behind are distracting:

1. Use dimming by moving the control in towards the passenger compartment.
2. Return to normal position by moving the control towards the windscreen.

### Automatic dimming\*

Bright light from behind is automatically dimmed by the rearview mirror. The control



for manual dimming is not available on mirrors with automatic dimming.

The rearview mirror contains two sensors - one forward facing and one rearward facing - that work together to identify and eliminate dazzling light. The forward facing sensor detects ambient light, while the rearward facing sensor detects the light from vehicle headlights behind.

### NOTE

If the sensors are obscured by e.g. parking permits, transponders, sun visors or objects in the seats or on the parcel shelf in such a way that light is prevented from reaching the sensors, then the dimming function of the rearview mirror is reduced.

The compass (p. 102) can only be specified for a rearview mirror with automatic dimming.

### Related information

- Door mirrors (p. 99)

### Compass\*

*The rearview mirror contains an integrated display that shows the compass direction in which the front of the car is pointing.*

### Operation



*Rearview mirror with compass.*

The upper right-hand corner of the rearview mirror has an integrated display that shows the compass direction in which the front of the car is pointing. Eight different directions are shown with English abbreviations: **N** (north), **NE** (north east), **E** (east), **SE** (south east), **S** (south), **SW** (south west), **W** (west) and **NW** (north west).

The compass is activated automatically when the car is started or when key position II is active, see Key positions - functions at different levels (p. 74). To deactivate/activate the compass - press in the button on the under-

side of the mirror using a paper clip for example.

### Calibration

The compass may need calibrating to show the correct compass direction.

The earth is divided into 15 magnetic zones. The compass should be calibrated if the car is moved across several magnetic zones.

Proceed as follows to perform calibration:

1. Stop the car in a large open area free from steel structures and high-voltage power lines.
2. Start the car and switch off all electrical equipment (air conditioning, wipers, etc.) and ensure that all doors are closed.

### NOTE

Calibration may fail or not start at all if electrical equipment is not switched off.

3. Hold the button on the underside of the rearview mirror depressed (use a paper clip or similar) for approx. 3 seconds. The number of the current magnetic zone is shown.



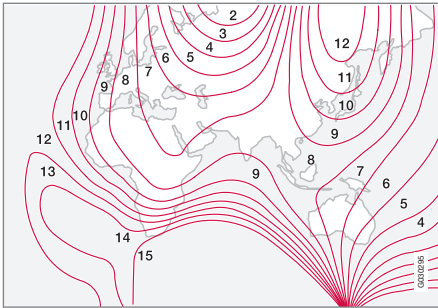

Magnetic zones.

4. Press the button repeatedly until the required magnetic zone (1–15) is shown. See the map of magnetic zones for the compass.
5. Wait until the display returns to showing the character **C**, or hold the button on the underside of the rearview mirror depressed for approx. 6 seconds until the character **C** is shown.
6. Drive slowly in a circle at a speed of no more than 10 km/h until a compass direction is shown in the display, indicating that calibration is complete. Then drive a further 2 circles to fine-tune calibration.

7. **Cars with heated windscreen\***: If the character **C** is shown in the display when the heated windscreen is activated, perform the calibration in accordance with point 6 above with the heated windscreen activated, see Demisting and defrosting the windscreen (p. 131).
8. Repeat the above procedure as necessary.

### Sunroof\*

The sunroof can be operated with a control in the roof panel.

The sunroof's inner sunscreen is closed manually.

The sunroof has a wind deflector.

The sunroof controls are located in the roof panel. The sunroof can be opened vertically at the rear edge and horizontally. Key position **I** or **II** is required for the sunroof to be opened.

### Horizontal opening

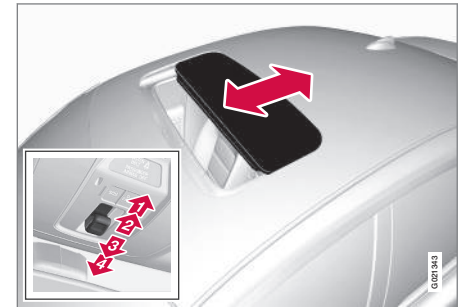

Horizontal opening, backward/forward.

- 1 ➔ Opening, automatic
- 2 ➔ Opening, manual
- 3 ➔ Closing, manual
- 4 ➔ Closing, automatic



## Opening

For maximum sunroof opening, move the control back to the position for automatic opening and release.

Open manually by pulling the control backwards to the point of resistance for manual opening. The sunroof moves to maximum open position as long as the button is kept depressed.

## Closing

Close manually by pushing the control forwards to the point of resistance for manual closing. The sunroof moves to closed position as long as the button is kept depressed.

### WARNING

Risk of crushing when the sunroof is closed. The sunroof's pinch-protection function only operates during automatic closing, not manual.

Close automatically by pressing the control to the position for automatic closing and then release it.

The power supply to the sunroof is switched off by selecting key position **0** and removing the remote control key from the ignition switch.

### WARNING

If there are children in the car:

Remember to always switch off the power supply to the sunroof by selecting key position **0** and then take the remote control key with you when leaving the car. For information on key positions - see Key positions - functions at different levels (p. 74).

## Vertical opening

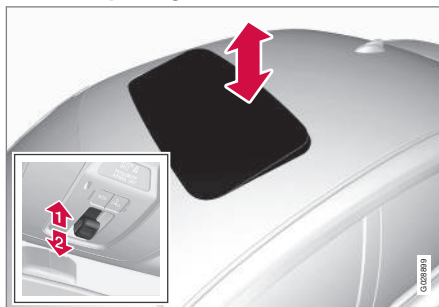

*Vertical opening, raised at the rear edge.*

- Open by pressing the rear edge of the control upward.
- Close by pulling the rear edge of the control down.

## Closing using the remote control key or central locking button



One long press on the lock button closes the sunroof and all the windows, see Remote control key - functions (p. 158) and Locking/unlocking - from the inside (p. 171). The doors and the boot lid are locked. To interrupt closing, press the lock button again.

### WARNING

If the sunroof is closed with the remote control key, check that no one risks being trapped.

## Sunscreen

The sunroof features a manual, sliding interior sunscreen. The sunscreen slides back automatically when the sunroof is opened. Grip the handle and slide the screen forward to close it.



### Pinch protection

The sunroof's pinch protection function is triggered if it is blocked by an object during automatic closing. If blocked, the sunroof will stop and automatically open to the previous position.

### Wind deflector

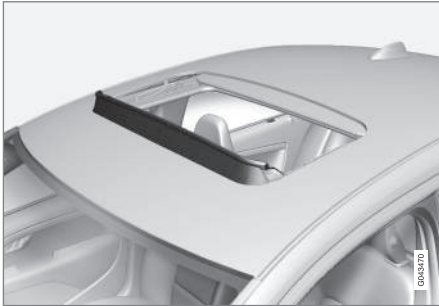

The sunroof has a wind deflector that is folded up when the sunroof is in the open position.

### Menu navigation - combined instrument panel

The left-hand stalk controls the menus (p. 106) shown on the information display in the combined instrument panel (p. 59). Which menus are shown depends on the key position (p. 74).

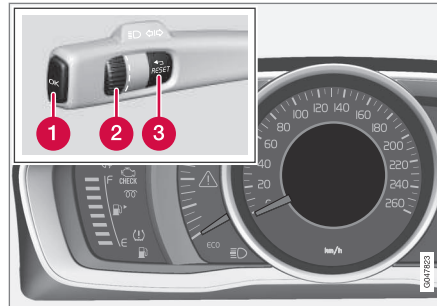

Display (analogue combined instrument panel) and controls for menu navigation.

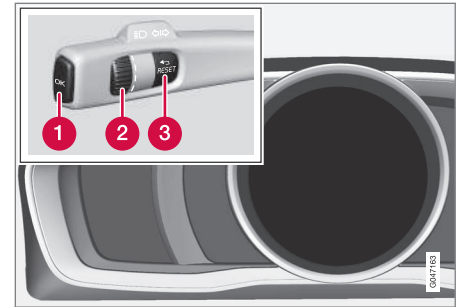

Display (digital combined instrument panel) and controls for menu navigation.

- 1 **OK** – access to message list and message confirmation.
- 2 **Thumbwheel** – browse between menu options.
- 3 **RESET** – reset the active function. Used in certain cases to select/activate a function, see the explanation under each respective function.

If there is a message (p. 106) then it must be acknowledged with **OK** in order that the menus shall be shown.

### Related information

- Messages - handling (p. 107)



## Menu overview - combined instrument panel

Which menus are shown in the combined instrument panel's information display depends on the key position (p. 74).

Some of the following menu options require the function and hardware to be installed in the car.

### Analogue combined instrument panel

#### Digital speed

#### Parking heater\*

#### Additional heater\*

#### TC options

#### Service status

#### Oil level<sup>22</sup>

#### Messages (##)<sup>23</sup>

### Digital combined instrument panel

#### Settings\*

#### Themes

#### Contrast mode/Colour mode

#### Service status

#### Messages<sup>23</sup>

#### Oil level<sup>22</sup>

## Parking heater\*

### Trip computer reset

### Related information

- Analogue combined instrument panel - overview (p. 59)
- Digital combined instrument panel - overview (p. 60)
- Menu navigation - combined instrument panel (p. 105)

## Messages

When a warning, information or indicator symbol illuminates, a corresponding message appears on the information display.

Message	Specification
Stop safely <sup>A</sup>	Stop and switch off the engine. Serious risk of damage - consult a workshop <sup>B</sup> .
Stop engine <sup>A</sup>	Stop and switch off the engine. Serious risk of damage - consult a workshop <sup>B</sup> .
Service urgent <sup>A</sup>	Contact a workshop <sup>B</sup> to check the car immediately.
Service required <sup>A</sup>	Contact a workshop <sup>B</sup> to check the car as soon as possible.
See manual <sup>A</sup>	Read the owner's manual.
Book time for maintenance	Time to book regular service - contact a workshop <sup>B</sup> .

<sup>22</sup> Certain engines.

<sup>23</sup> The number of messages is indicated in brackets.

\* Option/accessory, for more information, see Introduction.



Message	Specification
<b>Time for regular maintenance</b>	Time for regular service - contact a workshop <sup>B</sup> . The timing is determined by the number of kilometres driven, number of months since the last service, engine running time and oil grade.
<b>Maintenance overdue</b>	If the service intervals are not followed then the warranty does not cover any damaged parts - contact a workshop <sup>B</sup> .
<b>Transmission Oil change needed</b>	Contact a workshop <sup>B</sup> to check the car as soon as possible.
<b>Transmission Reduced performance</b>	The gearbox cannot handle full capacity. Drive carefully until the message clears <sup>C</sup> .  If shown repeatedly - contact a workshop <sup>B</sup> .
<b>Transmission hot Reduce speed</b>	Drive more smoothly or stop the car in a safe manner. Disengage the gear and run the engine at idling speed until the message clears <sup>C</sup> .

Message	Specification
<b>Transmission hot Stop safely Wait for cooling</b>	Critical fault. Stop the car immediately in a safe manner and contact a workshop <sup>B</sup> .
<b>Temporarily off<sup>A</sup></b>	A function has been temporarily switched off and is reset automatically while driving or after starting again.
<b>Low battery charge Power save mode</b>	The audio system is switched off to save energy. Charge the battery.

<sup>A</sup> Part of message, shown together with information on where the problem has arisen.

<sup>B</sup> An authorised Volvo workshop is recommended.

<sup>C</sup> For more information regarding the automatic gearbox, see Automatic gearbox -- Geartronic\* (p. 261).

#### Related information

- Messages - handling (p. 107)
- Menu navigation - combined instrument panel (p. 105)

### Messages - handling

Use the left-hand stalk switch to acknowledge and browse among messages (p. 106) that are shown in the information display of the combined instrument panel.

When a warning, information or indicator symbol illuminates, a corresponding message appears in the display at the same time. An error message is stored in a memory list until the fault has been rectified.

Press **OK** on the left-hand stalk switch to acknowledge a message. Scroll through messages with the thumbwheel (p. 105).

#### NOTE

If a warning message appears while you are using the trip computer, the message must be read (press **OK**) before the previous activity can be resumed.

#### Related information

- Menu overview - combined instrument panel (p. 106)

## MY CAR

MY CAR is a menu source that handles many of the car's functions, e.g. City Safety™, locks and alarm, automatic fan speed, setting the clock, etc.

Certain functions are standard, others are optional - the range also varies depending on the market.

### Operation

Navigation in the menus is carried out using buttons in the centre console or with the steering wheel's right-hand keypad\*.

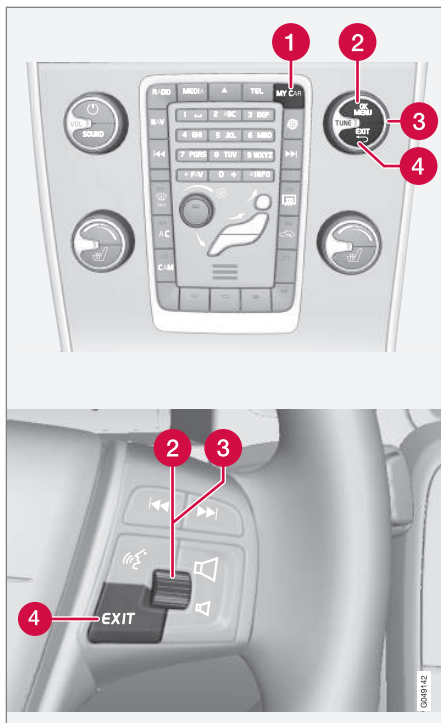

Control panel in centre console and steering wheel keypad. The figure is schematic - the number of functions and layout of the buttons both

vary, depending on the equipment selected and the market.

- 1 **MY CAR** - opens the menu system MY CAR.
- 2 **OK/MENU** - press the button in the centre console or the thumbwheel on the steering wheel to select/tick in the highlighted menu option or store the selected function in the memory.
- 3 **TUNE** - turn the knob in the centre console or the thumbwheel on the steering wheel to scroll up/down through the menu options.
- 4 **EXIT**

### EXIT functions

Depending on the function the cursor is on when **EXIT** is depressed briefly, and on which menu level, one of the following may occur:

- phone call is rejected
- current function is interrupted
- input characters are deleted
- most recent selections are undone
- leads up in the menu system.

A long press on **EXIT** leads to the normal view for MY CAR or if you are in the normal view, to the highest menu level (main source menu).



### Menu options and search paths

For a description of the menu options and search paths in MY CAR, see the Sensus Infotainment supplement.

### Trip computer

*The car's trip computer can record, calculate and show information while driving.*

Trip computer content and appearance varies depending on whether the combined instrument panel is analogue or digital:

- Trip computer - analogue combined instrument panel (p. 110)
- Trip computer - digital combined instrument panel (p. 114)

Checking and settings can be made immediately after the combined instrument panel is automatically illuminated in connection with unlocking. If none of the trip computer's controls are actuated within approx. 30 seconds after the driver's door has been opened then the instrument extinguishes, after which either key position II (p. 74) or engine starting is required in order to operate the trip computer.



#### NOTE

If a warning message appears when the trip computer is used then the message must first be acknowledged before the trip computer can be reactivated.

- Acknowledge the message by briefly pressing the indicator stalk **OK** button.

### Group menus

The trip computer has two different group menus:

- Functions
- Heading in combined instrument panel

The trip computer's **functions** or **headings** are each listed in an infinite loop.

### Related information

- Trip computer - trip statistics\* (p. 119)
- Trip computer - supplementary information (p. 118)



## Trip computer - analogue combined instrument panel

The trip computer's menu is in a variable loop. One of the alternatives is that the trip computer's display extinguishes - this also marks the start/end of the loop.

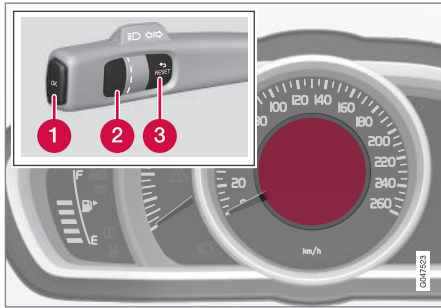

Information display and controls.

- 1 **OK** - Opens the loop with the trip computer's functions + Activates the selected option.
- 2 **Thumbwheel** - Opens the loop with the trip computer's headings + Scrolls through the options.
- 3 **RESET** - Undoes, zeroes or backs out of a function after making a selection.

## Functions

Proceed as follows to open and check/adjust functions:

1. To ensure that no control is in the middle of a sequence - "Reset" them first with two presses on **RESET**.
2. Press **OK** - the loop with all functions opens.
3. Browse through the functions with the **thumbwheel** and select/confirm with **OK**.
4. Finish by pressing twice on **RESET** after completed checking/adjustment.

The different functions of the trip computer are listed in the following table:





Functions	Information
<b>Digital speed</b> <ul style="list-style-type: none"> <li>• km/h</li> <li>• mph</li> <li>• No display</li> </ul>	<p>Shows the car's speed digitally in the centre of the combined instrument panel:</p> <ul style="list-style-type: none"> <li>• Open with <b>OK</b>, select with the <b>thumbwheel</b>, confirm with <b>OK</b> and back out with <b>ENTER</b>.</li> </ul>
<b>Parking heater*</b> <ul style="list-style-type: none"> <li>• DIRECT START</li> <li>• - Timer 1 - leads to the menu for selecting time.</li> <li>• - Timer 2 - leads to the menu for selecting time.</li> </ul>	<p>For a description of programming the timer, see Engine block heater and passenger compartment heater* - timer (p. 138).</p>
<b>Additional heater*</b> <ul style="list-style-type: none"> <li>• Auto On</li> <li>• Off</li> </ul>	<p>For more information, see Additional heater* (p. 142).</p>
<b>TC options</b> <ul style="list-style-type: none"> <li>• Distance to empty tank</li> <li>• Fuel consumption</li> <li>• Average speed</li> <li>• Trip meter <b>T1 and total dist.</b></li> <li>• Trip meter <b>T2 and total dist.</b></li> </ul>	<p>Here you can select/activate the options that you want to be available as selectable headings in the trip computer. The symbols for the items already selected are WHITE with a "tick" - others are GREY and have no "tick":</p> <ol style="list-style-type: none"> <li>1. Open the function with <b>OK</b>, scroll through the symbols for the options with the <b>thumbwheel</b> and select/stop on the desired symbol.</li> <li>2. Confirm with <b>OK</b> - the symbol changes colour from GREY to WHITE and is marked with a "tick".</li> <li>3. Continue to select the function symbols with the <b>thumbwheel</b> or finish with <b>RESET</b>.</li> </ol>
<b>Service status</b>	<p>Shows the number of months and mileage to next service.</p>



# 03 Instruments and controls



Functions	Information
Oil level <sup>A</sup>	For more information, see Engine oil - checking and filling (p. 346).
Messages (##)	For more information, see Messages - handling (p. 107).

A Certain engines.

## Headings

One of the headings in the following table can be selected for constant display in the combined instrument panel. Proceed as follows to determine which:

1. To ensure that no control is in the middle of a sequence - "Reset" them first with two presses on **RESET**.
2. Turn the **thumbwheel** - selectable headings for the trip computer are shown in a loop.
3. Stop on desired heading.

Trip computer heading in combined instrument panel	Information
Trip meter T1 and total dist.	<ul style="list-style-type: none"> <li>• Long press on <b>RESET</b> resets trip meter T1.</li> </ul>
Trip meter T2 and total dist.	<ul style="list-style-type: none"> <li>• Long press on <b>RESET</b> resets trip meter T2.</li> </ul>
Distance to empty	For more information - see the section "Range - distance to empty tank" (p. 118).
Fuel consumption	Current consumption.
Average speed	<ul style="list-style-type: none"> <li>• Long press on <b>RESET</b> resets <b>Average speed</b>.</li> </ul>
No trip computer information.	This option shows a blank display - it also marks the beginning/end of the loop.

The combined instrument panel's trip computer can be changed to another option at any time during the journey. Proceed as follows:

- Turn the **thumbwheel** - stop on the desired heading.

## Resetting - Trip meter and Average speed

With the current trip computer heading - **T1 and total dist., T2 and total dist.** or



**Average speed** - shown in the combined instrument panel:

- Give a long press on **RESET** - selected heading is zeroed.

Each heading must be zeroed individually.

### **Related information**

- Trip computer (p. 109)
- Trip computer - supplementary information (p. 118)
- Trip computer - trip statistics\* (p. 119)



## 03 Instruments and controls

### Trip computer - digital combined instrument panel

The trip computer's menu is in a variable loop. One of the alternatives is that the trip computer's three displays extinguish - this also marks the start/end of the loop.

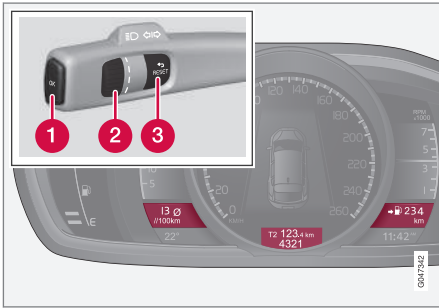

*Information displays and stalk switch controls.*

- 1 OK** - Opens the loop with the trip computer's functions + Activates the selected option.
- 2 Thumbwheel** - Opens the loop with the trip computer's headings + Scrolls through the options.
- 3 RESET** - Undoes, zeroes or backs out of a function after making a selection.

### Functions

Proceed as follows to open and check/adjust functions:

- To ensure that no control is in the middle of a sequence - "Reset" them first with two presses on **RESET**.
- Press **OK** - loop with all functions opens.
- Browse through the functions with the **thumbwheel** and select/confirm with **OK**.
- Finish by pressing twice on **RESET** after completed checking/adjustment.

The different functions of the trip computer are listed in the following table:



Functions	Information
<b>Trip computer reset</b> <ul style="list-style-type: none"> <li>• Average</li> <li>• Average speed</li> </ul>	<b>Note</b> that this function does <b>not</b> reset both trip meters T1 and T2 - see table under next section "Headings" and section "Resetting - Average speed/consumption" for information on the process.
<b>Messages</b>	For more information, see Messages - handling (p. 107).
<b>Themes</b>	The appearance of the combined instrument panel (p. 59) is selected here.
<b>Settings*</b>	Select <b>Auto On</b> or <b>Off</b> . For more information, see Additional heater* (p. 142).
<b>Contrast mode/Colour mode</b>	Adjusting the combined instrument panel's brightness and colour intensity.
<b>Parking heater*</b> <ul style="list-style-type: none"> <li>• <b>Direct start</b></li> <li>• - Symbol Timer 1 - leads to the menu for selecting time.</li> <li>• - Symbol Timer 2 - leads to the menu for selecting time.</li> </ul>	For a description of programming the timer, see Engine block heater and passenger compartment heater* - timer (p. 138).
<b>Service status</b>	Shows the number of months and mileage to next service.
<b>Oil level<sup>A</sup></b>	For more information, see Engine oil - checking and filling (p. 346).

<sup>A</sup> Certain engines.



## Headings

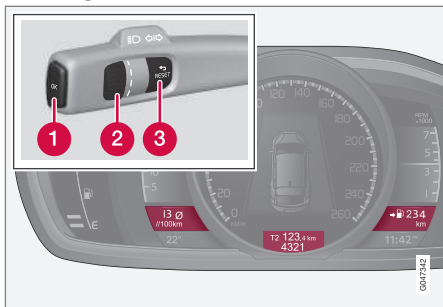

Three trip computer headings can be displayed simultaneously - one in each "window".

One of the heading combinations in the following table can be selected for constant display in the combined instrument panel. Proceed as follows to determine which:

1. To ensure that no control is in the middle of a sequence - "Reset" them first with two presses on **RESET**.
2. Turn the **thumbwheel** - selectable heading combinations are shown in a loop.
3. Stop on desired heading combination.

Heading combinations			Information
Average	Trip meter T1 + Meter reading	Average speed	<ul style="list-style-type: none"> <li>• Long press on <b>RESET</b> resets trip meter T1.</li> </ul>
Instantaneous	Trip meter T2 + Meter reading	Distance to empty tank	<ul style="list-style-type: none"> <li>• Long press on <b>RESET</b> resets trip meter T2.</li> </ul>
Instantaneous	Meter reading	kmh<>mph	kmh<>mph - see section "Digital speed display" (p. 118).
	No trip computer information.		This option extinguishes all three trip computer displays - it also marks the beginning/end of the loop.

The combined instrument panel's heading combination for the trip computer can be changed to another option at any time during the journey. Proceed as follows:

- Turn the **thumbwheel** - stop on the desired heading.

### Resetting - Trip meter

Turn with the **thumbwheel** to the heading combination containing the trip meter to be reset:

- Give a long press on **RESET** - selected trip meter is zeroed.



### Resetting - Average speed/ consumption

1. Select function **Trip computer reset** and activate with **OK**.
2. Select one of the following options with the **thumbwheel** and activate with **OK**:
  - l/100 km
  - km/h
  - Reset both
3. Finish with **RESET**.

### Related information

- Trip computer - supplementary information (p. 118)
- Trip computer - trip statistics\* (p. 119)



## Trip computer - supplementary information

Supplementary information covering several functions follows below.

### Average

Average fuel consumption is calculated from the last resetting.

#### NOTE

There may be a slight error in the reading if a fuel-driven heater\* has been used.

### Average speed

The average speed is calculated for the driving distance driven since the last reset to zero.

### Instantaneous

The information for current fuel consumption is updated continuously - approximately once per second. When the car is driven at low speed the consumption is shown per time unit - at a higher speed it is shown related to mileage.

Different units (km/miles) can be selected for the display - see section "Change unit" (p. 118).

### Range - distance to empty tank

The trip computer shows the approximate distance that can be driven with the fuel quantity remaining in the tank.

No guaranteed range remains when the heading **Distance to empty** shows "----".

- In which case, refuel as soon as possible.

The calculation is based on the average fuel consumption over the last 30 km and the remaining driveable fuel quantity.

#### NOTE

There may be a slight error in the reading if the driving style has been changed.

An economic driving style generally results in a longer driving distance. For more information on how fuel consumption can be influenced, see Volvo Car Corporation 's Environmental Philosophy (p. 21).

### Digital speed display<sup>24</sup>

The speed is shown in the opposite unit (kmh/mph) in relation to the main instrument. If it is calibrated in mph then the trip computer shows the corresponding speed in km/h and vice versa.

### Change unit

You can change unit (km/miles) for distance and speed in the menu system MY CAR, see MY CAR (p. 108).

#### NOTE

In addition to in the trip computer, these units are also changed in Volvo's navigation system\*.

### Related information

- Trip computer - trip statistics\* (p. 119)

<sup>24</sup> Only with combined instrument panel "Digital".

\* Option/accessory, for more information, see Introduction.





## Trip computer - trip statistics\*

Information is stored about completed trips containing average fuel consumption and average speed, which can be viewed in the centre console's screen as a bar chart.

### Function

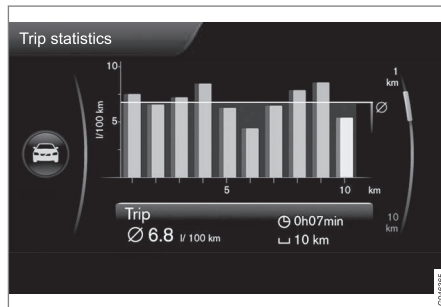

Trip statistics<sup>25</sup>.

Each bar symbolises 1 km or 10 km driven distance, depending on the scale selected - the bar at the far right shows the value for the current kilometre or 10 km.

Using the **TUNE** control, the scale for the bars can be changed between 1 km and 10 km - the cursor on the far right changes position between up and down in relation to the scale selected.

### Operation

Different settings can be made in the menu system **MY CAR**, see MY CAR (p. 108) - there, find **Trip statistics**.

With the "**Reset when vehicle has been off for minimum 4h**" option highlighted, all statistics are deleted automatically once driving is complete and the car has been stopped for 4 hours. Trip statistics start again from zero the next time the engine is started.

- **Reset when vehicle has been off for minimum 4h** - highlight the box by selecting **ENTER** and go back out of the menu by selecting **EXIT**.

If a new driving cycle is started before 4 hours have elapsed then the current period must first be deleted manually using the "**Start new trip**" option.

- **Start new trip - ENTER** is used to delete all previous statistics, go back out of the menu by selecting **EXIT**.

See also information on Eco guide (p. 63).

### Related information

- Trip computer - supplementary information (p. 118)

<sup>25</sup> The figure is schematic - layout may vary depending on car model or updated software.

# 04



CLIMATE CONTROL





## General information on climate control

*The car is equipped with electronic climate control (p. 127). The climate control system cools or heats as well as dehumidifies the air in the passenger compartment.*

### NOTE

Air conditioning (AC) (p. 131) can be switched off, but to ensure the best possible climate comfort in the passenger compartment, and to prevent the windows from misting, it should always be switched on.

### To bear in mind

- To ensure that the air conditioning works optimally, the side windows, and sunroof\* should be closed.
- Total airing function (p. 172) opens/closes all side windows simultaneously and can be used for example to quickly air the car during hot weather.
- Remove ice and snow from the climate control system air intake (the grille between the bonnet and the windscreen).
- In warm weather, condensation from the air conditioning may drip under the car. This is normal.
- When the engine requires full power, e.g. for full acceleration or driving uphill with a trailer, the air conditioning can be temporarily switched off. There may then be a

temporary increase in temperature in the passenger compartment.

- Remove misting on the insides of the windows primarily by using the defroster function (p. 131). To reduce the risk of misting, keep the windows clean and use window cleaner.

### NOTE

To avoid misting on the rear window, do not block the ventilation holes at the back of the parcel shelf with articles of clothing or other objects.

### Cars with Start/Stop\*

With an auto-stopped (p. 268) engine certain equipment may have its function temporarily reduced, e.g. climate control fan speed (p. 130).

### Cars with ECO\*

Certain equipment may have its function temporarily reduced or deactivated when the ECO (p. 277) function is activated, e.g. the air conditioning (p. 131).

### NOTE

When the ECO function is activated, several parameters in the climate control system's settings are changed, and several electricity consumer functions are reduced. Certain settings can be reset manually, but full functionality is only restored by deactivating the ECO function.

### Related information

- Actual temperature (p. 122)
- Menu settings - climate control (p. 124)
- Electronic climate control - ECC (p. 127)
- Air distribution in the passenger compartment (p. 125)
- Air cleaning (p. 122)



## 04 Climate control

### Actual temperature

*The temperature you select in the passenger compartment corresponds to the physical experience with reference to factors such as ambient temperature, air speed, humidity and solar radiation etc. in and around the car at the time.*

The system includes a sun sensor (p. 122) which detects on which side the sun is shining into the passenger compartment. This means that the temperature can differ between the right and left-hand air vents despite the controls being set for the same temperature on both sides.

### Related information

- General information on climate control (p. 121)
- Temperature control in the passenger compartment (p. 130)

### Sensors - climate control

*The climate control system has a number of sensors to help control the temperature (p. 122) in the car.*

- The sun sensor is located on the top side of the dashboard.
- The temperature sensor for the passenger compartment is located below the climate control panel.
- The outside temperature sensor is located in the door mirror.
- The humidity sensor\* is located by the interior rearview mirror.



### NOTE

Do not cover or block the sensors with clothing or other objects.

### Related information

- General information on climate control (p. 121)

### Air cleaning

*The interior in a passenger compartment is designed to be pleasant and comfortable, even for people with contact allergies and for asthma sufferers.*

- Passenger compartment filter (p. 123)
- Material in the passenger compartment (p. 124)
- Clean Zone Interior Package (CZIP) (p. 123)\*
- Interior Air Quality System (IAQS) (p. 124)\*

### Related information

- General information on climate control (p. 121)



### Air cleaning - passenger compartment filter

All air entering the car's passenger compartment is cleaned with a filter.

The filter must be replaced at regular intervals. Follow the Volvo Service Programme for the recommended replacement intervals. If the car is used in a severely contaminated environment, it may be necessary to replace the filter more often.

#### NOTE

There are different types of passenger compartment filter. Make sure that the correct filter is fitted.

#### Related information

- Air cleaning (p. 122)

### Air cleaning - Clean Zone Interior Package (CZIP)\*

CZIP comprises a series of modifications that keep the passenger compartment even clearer from allergy and asthma-inducing substances.

The following is included:

- An enhanced fan function that means that the fan starts when the car is opened with the remote control key. The fan fills the passenger compartment with fresh air. The function starts when required and is disengaged automatically after a time or when one of the passenger compartment doors is opened. The amount of time the fan runs is reduced gradually due to reduced need up until the car is 4 years old.
- The air quality system IAQS (p. 124) is a fully automatic system that cleans the air in the passenger compartment from contaminants such as particles, hydrocarbons, nitrous oxides and ground-level ozone.

#### NOTE

To keep the CZIP standard in cars with CZIP the IAQS filter must be changed after 15 000 km or once per year depending on whichever occurs first. However, up to 75 000 km over 5 years. In cars without CZIP and where the customer does not want to keep the CZIP standard the IAQS filter must be changed at a regular service.

For more information on CZIP, see the brochure included with the purchase of the car.

#### Related information

- General information on climate control (p. 121)
- Air cleaning (p. 122)



## Air cleaning - IAQS\*

The air quality system IAQS separates gases and particles to reduce the levels of odours and pollution in the passenger compartment.

If the outside air is contaminated then the air intake is closed and the air is recirculated.

It is possible to activate/deactivate the function in the menu system MY CAR. For a description of the menu system, see MY CAR (p. 108).

### NOTE

The air quality sensor must always be enabled to ensure the best air in the passenger compartment.

In a cold climate recirculation is limited so as to prevent misting.

In the event of misting, the air quality sensor should be disengaged, and the defroster functions for the windscreen and side windows, as well as the rear window, should be used.

## Related information

- General information on climate control (p. 121)
- Air cleaning (p. 122)
- Air cleaning - Clean Zone Interior Package (CZIP)\* (p. 123)

## Air cleaning - material

Tested materials have been developed in order to minimise the quantity of dust in the passenger compartment and to contribute to making the passenger compartment easier to keep clean.

The carpets in both the passenger compartment and the cargo area are removable and easy to remove and clean. Use cleaning agents and car care products recommended by Volvo to clean the interior (p. 382).

## Related information

- Air cleaning (p. 122)

## Menu settings - climate control

It is possible to activate/deactivate or change the default settings for six of the climate control system's functions via the centre console.

- Fan level during automatic climate control (p. 130).
- Recirculation timer (p. 132).
- Automatic start of rear window defroster (p. 101).
- Interior air quality system (p. 124)\*.
- Automatic start of seat heating driver (p. 128).
- Automatic start of steering wheel heating (p. 80).

More information is available in the description of the menu system (p. 108).

The climate control system's functions can be reset in the menu system MY CAR to the default settings. For a description of the menu system, see MY CAR (p. 108).

## Related information

- General information on climate control (p. 121)



## Air distribution in the passenger compartment

The incoming air is divided between a number of different vents in the passenger compartment.

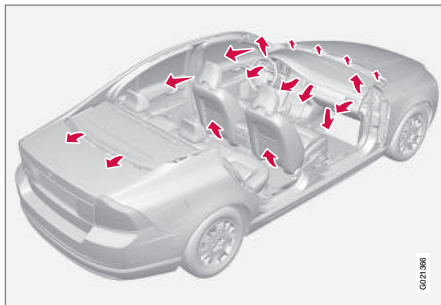

Air distribution is fully automatic in **AUTO** mode.

If necessary it can be controlled manually; see the air distribution table (p. 134).

## Air vents in the dashboard

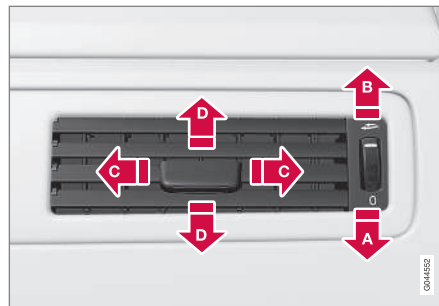

- A** Closed
- B** Open
- C** Lateral airflow
- D** Vertical airflow

Aim the outer vents at the side windows to remove misting.

## Air vents in the door pillars

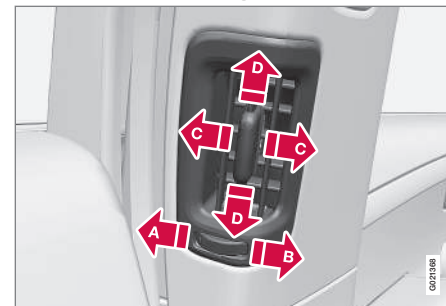

- A** Closed
- B** Open
- C** Lateral airflow
- D** Vertical airflow

Aim the vents at the windows to remove misting in cold weather.

Aim the vents into the passenger compartment to maintain a comfortable climate in the rear seat in hot weather.

### **i** NOTE

Remember that small children may be sensitive to air flows and draughts.



## 04 Climate control



### Air distribution

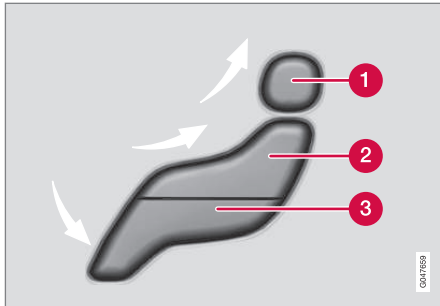

- 1 Air distribution - defroster windscreen
- 2 Air distribution - air vent instrument panel
- 3 Air distribution - ventilation floor

The figure consists of three buttons. When pressing the buttons the corresponding figure is illuminated in the display screen (see following figure) and an arrow in front of each part of the figure shows the air distribution that is selected. For more information, see the air distribution table (p. 134).

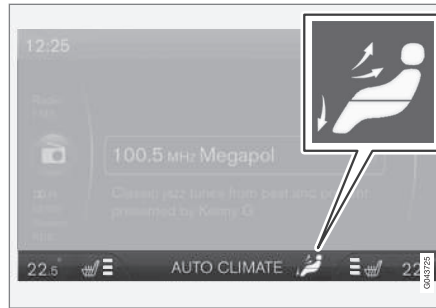

The selected air distribution is shown in the centre console display screen.

### Related information

- General information on climate control (p. 121)
- Auto-regulation (p. 130)
- Air distribution - recirculation (p. 132)





### Electronic climate control - ECC

ECC (Electronic Climate Control) maintains the temperature selected in the passenger

compartment and can be set separately for the driver's side and passenger side.

The auto function is used to automatically control temperature, air conditioning, fan speed, recirculation and air distribution.

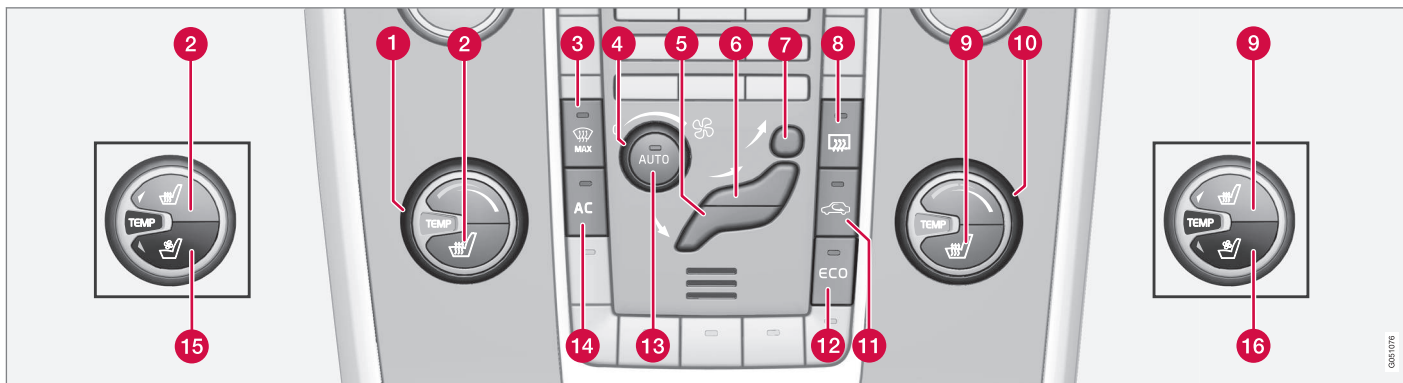

- |  |  |   |
|--|--|---|
| <p><b>1</b> Temperature control (p. 130), left-hand side</p> <p><b>2</b> Electrically heated front seat (p. 128) , left side<sup>1</sup></p> <p><b>3</b> Max. defroster (p. 131)</p> <p><b>4</b> Fan (p. 130)</p> <p><b>5</b> Air distribution (p. 125) - ventilation floor</p> <p><b>6</b> Air distribution - air vent instrument panel</p> <p><b>7</b> Air distribution - defroster windscreen</p> | <p><b>8</b> Rear window and door mirror defrosters (p. 101)</p> <p><b>9</b> Electrically heated front seat (p. 128), right-hand side<sup>1</sup></p> <p><b>10</b> Temperature control (p. 130), right-hand side</p> <p><b>11</b> Recirculation (p. 132)</p> <p><b>12</b> ECO* (p. 277)</p> <p><b>13</b> <b>AUTO</b> - Automatic climate control (p. 130)</p> | <p><b>14</b> <b>AC</b> - Air conditioning on/off (p. 131)</p> <p><b>15</b> Ventilated front seat (p. 129)*, left-hand side</p> <p><b>16</b> Ventilated front seat*, right-hand side</p> <p><b>Related information</b></p> <ul style="list-style-type: none"> <li>• General information on climate control (p. 121)</li> </ul> |
|--|--|---|

<sup>1</sup> The button has a different location depending on whether or not the car is equipped with ventilated front seat\*.

## Heated front seats\*

The front seat heating has three positions for increasing the comfort for driver and passenger when it is cold.

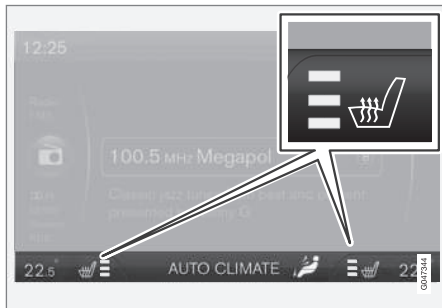

Current heat level is shown in the centre console display screen.



The button has a different location depending on whether or not the car is equipped with ventilated front seat\*, see illustration (p. 127).

Press the button repeatedly in order to activate the function:

- Highest heat level - three orange fields illuminate in the centre console's screen (see figure above).
- Lower heat level - two orange fields illuminate in the screen.

- Lowest heat level - one orange field illuminates in the screen.
- Switch off the heat - no field illuminates.

### WARNING

Heated seats must not be used by people who find it difficult to perceive an increase in temperature due to a lack of sensation or who otherwise have problems operating the controls for the heated seats. Otherwise they may suffer burn injuries.

### Automatic start of driver's seat heating

With the automatic start of the driver's seat heating activated, the driver's seat will have the highest heat level when the engine is started.

Automatic start takes place when the car is cold and the ambient temperature is lower than approx. +10 °C.

It is possible to activate/deactivate the function in the menu system MY CAR. For a description of the menu system, see MY CAR (p. 108).

### Related information

- General information on climate control (p. 121)
- Heated rear seat\* (p. 128)

## Heated rear seat\*

The heating for the rear seat's outer positions has three positions for increasing the comfort for passengers when it is cold.



Current heat level is shown in the pushbutton's lamps.

Press the button repeatedly in order to activate the function:

- Highest heat level - three lamps illuminate.
- Lower heat level - two lamps illuminate.
- Lowest heat level - one lamp illuminates.
- Switch off the heat - no lamp illuminates.



## WARNING

Heated seats must not be used by people who find it difficult to perceive an increase in temperature due to a lack of sensation or who otherwise have problems operating the controls for the heated seats. Otherwise they may suffer burn injuries.

### Related information

- General information on climate control (p. 121)
- Heated front seats\* (p. 128)

### Ventilated front seats\*

*The ventilation can be used at the same time as seat heating. For example, the function can be used to dry damp from clothing.*

The ventilation system consists of fans in the seats and backrests that draw air through the seat upholstery. The cooling effect increases the cooler the passenger compartment air becomes. The system can be activated when the engine is running.

The ventilation is regulated from the climate control and takes seat temperature, solar radiation and outside temperature into consideration.



Current comfort level is shown in the centre console display screen.



For button location, see the illustration (p. 127).

Press the button repeatedly in order to activate the function.

There are three comfort levels that produce different cooling and dehumidification outputs:

- Comfort level **III**: Highest output - three blue fields illuminate in the centre console's screen (see figure above).
- Comfort level **II**: Lower output - two blue fields illuminate in the screen.
- Comfort level **I**: Lowest output - one blue field illuminates in the screen.
- Switch off the function - no field illuminates.

### NOTE

The seat ventilation should be used carefully by people sensitive to draughts. Comfort level **I** is recommended for long-term use.

### IMPORTANT

The seat ventilation cannot be started when the passenger compartment temperature is below 5 °C. This is in order to avoid cooling down the seat occupant.



# 04 Climate control

## Fan

The fan should always be activated in order to avoid misting on the windows.

### **i** NOTE

If the fan is fully switched off then the air conditioning is not engaged - which can cause a risk of misting on the windows.

## Fan knob



Turn the knob to increase or decrease fan speed. If **AUTO** is selected, then the fan speed is regulated automatically (p. 130) - the fan speed previously set is disengaged.

## Related information

- General information on climate control (p. 121)
- Electronic climate control - ECC (p. 127)

## Auto-regulation

The auto function automatically regulates temperature (p. 130), air conditioning (p. 131), fan speed (p. 130), recirculation (p. 132) and air distribution (p. 125).



If you select one or more manual functions, the other functions continue to be controlled automatically. All manual settings are disengaged when **AUTO** is pressed. The display screen

shows **AUTO CLIMATE**.

Fan speed in automatic mode can be set in the menu system MY CAR. For a description of the menu system, see MY CAR (p. 108).

## Related information

- General information on climate control (p. 121)

## Temperature control in the passenger compartment

When the car is started, the most recent temperature setting is resumed.

### **i** NOTE

Heating or cooling cannot be hastened by selecting a higher or lower temperature than the actual desired temperature.

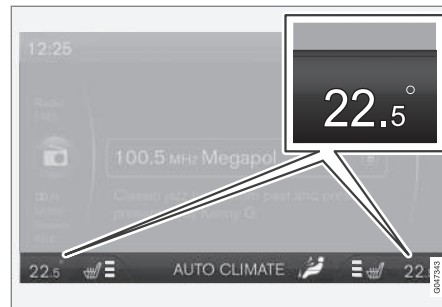

Current temperature for each side is shown in the centre console's display screen.



The temperature can be adjusted with the knob - separately for the driver's side and the passenger side.



### Related information

- General information on climate control (p. 121)
- Actual temperature (p. 122)
- Electronic climate control - ECC (p. 127)

### Air conditioning

*The air conditioning cools and dehumidifies incoming air as required.*



When the lamp in the **AC** button illuminates, the air conditioning is controlled by the system's automatic function.

When the lamp in the **AC** button is switched off the air conditioning is disconnected. Other functions are still controlled automatically. When the max. defroster function (p. 131) is activated, the air conditioning is switched on automatically so that the air is dehumidified at the maximum setting.

### Demisting and defrosting the windscreen

*Heated windscreen\* and max. defroster are used to quickly remove misting and ice from the windscreen and side windows.*

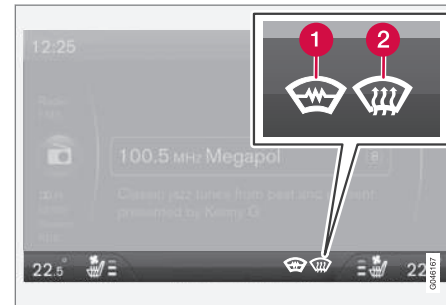

*The selected setting is shown in the centre console's screen.*

- 1 Heated windscreen\*
- 2 Max. defroster



The light in the defroster button illuminates when the function is active.

Press the button repeatedly in order to activate the function.



# 04 Climate control



For cars without heated windscreen:

- Air flows to the windows - symbol (2) illuminates in the screen.
- Switch off the function - no symbol illuminates.

For cars with heated windscreen:

- Start the heating for the windscreen<sup>2</sup> - symbol (1) illuminates in the screen.
- Start the heating for the windscreen<sup>2</sup> and air flow to the windows - symbols (1) and (2) illuminate in the screen.
- Switch off the function - no symbol illuminates.

## NOTE

Heated windscreen and IR window (p. 18) may have an impact on the performance of transponders and other communication equipment.

## NOTE

A triangular area at the end of each side of the windscreen is not electrically heated, where de-icing may take longer.

## NOTE

Electrically heated windscreen is not available when the engine is auto-stopped (p. 268).

The following also takes place in order to provide maximum dehumidification in the passenger compartment:

- the air conditioning is automatically engaged
- recirculation and the air quality system are automatically disengaged.

## NOTE

The noise level increases as the fan is operating at max.

When the defroster is switched off the climate control returns to the previous settings.

## Related information

- General information on climate control (p. 121)

## Air distribution - recirculation

Select recirculation to shut out bad air, exhaust gases etc. from the passenger compartment, i.e. no outside air is taken into the car when this function is activated.



When recirculation is engaged the orange lamp in the button illuminates.

## IMPORTANT

If the air in the car recirculates for too long, there is a risk of misting on the insides of the windows.

## Timer

With the timer function activated the system will exit manually activated recirculation mode according to a time that depends on the outside temperature. This reduces the risk of ice, misting and bad air.

It is possible to activate/deactivate the function in the menu system MY CAR. For a description of the menu system, see MY CAR (p. 108).

<sup>2</sup> If the character **C** is shown in the rearview mirror when the heated windscreen is activated then the compass (p. 102)\* must be recalibrated.

** NOTE**

When max. defroster is selected, recirculation is always deactivated.

**Related information**





- General information on climate control (p. 121)
- Air distribution in the passenger compartment (p. 125)
- Air distribution - table (p. 134)



# 04 Climate control

## Air distribution - table





Three buttons are used to select the distribution (p. 125) of the air.

	Air distribution	Use
	Air to windows. Some air flows from the air vents. The air is not recirculated. Air conditioning is always engaged.	to remove ice and misting quickly.
	Air to windscreen, via defroster vent, and side windows. Some air flows from the air vents.	to prevent misting and icing in a cold and humid climate, (not at too low fan speed to enable this).
	Airflow to windows and from dashboard air vents.	to ensure good comfort in warm, dry weather.
	Airflow to the head and chest from dashboard air vents.	to ensure efficient cooling in warm weather.

04





	Air distribution	Use
	Air to the floor and windows. Some air flows from the dashboard air vents.	to ensure comfortable conditions and good demisting in cold or humid weather.
	Air to floor and from dashboard air vents.	in sunny weather with cool outside temperatures.
	Air to floor. Some air flows to the dashboard air vents and windows.	to direct heat or cold to the floor.
	Airflow to windows, from dashboard air vents and to the floor.	to provide cooling along the floor in hot, dry weather or warming upwards in cold weather.

#### Related information

- General information on climate control (p. 121)
- Air distribution - recirculation (p. 132)



## 04 Climate control

### Engine and passenger compartment heater\*

Preconditioning prepares the car's heater, engine and passenger compartment before departure so that both wear and energy needs during the journey are reduced.

The heater can be started directly (p. 137) or with a timer (p. 138).

The heater cannot start if the outside temperature exceeds 15 °C. At -5 °C or lower the maximum running time of the heater is 50 minutes.

#### WARNING

Do not use the fuel-driven heater indoors. Exhaust gases are secreted.

#### NOTE

When the fuel-driven auxiliary heater is active there may be smoke from the right-hand wheel housing, which is perfectly normal.

### Refuelling

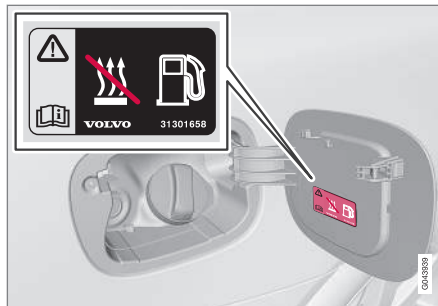

Warning label on fuel filler flap.

#### WARNING

Fuel which spills out could be ignited. Switch off the fuel-driven auxiliary heater before starting to refuel.

Check in the combined instrument panel that the heater is switched off. The heat symbol is shown when it is operating.

### Parking on a hill

If the car is parked on a steep hill, the front of the car should point downhill to ensure that there is a supply of fuel to the fuel-driven heater.

### Battery and fuel

If the battery has insufficient charge or the fuel level is too low, the heater will be switched off automatically and a message

appears on the information display. Acknowledge the message by pressing the indicator stalk (p. 105) **OK** button once.

#### IMPORTANT

Repeated use of the heater combined with short journeys leads to the battery discharging and consequential starting problems.

The car should be driven for the same time as the heater is used to ensure that the car's battery is recharged adequately to replace the energy consumed by the heater when it is used on a regular basis. The heater is used for a maximum of 50 minutes each time.

### Related information

- Engine block heater and passenger compartment heater\* - messages (p. 140)
- Additional heater\* (p. 142)



## Engine block heater and passenger compartment heater\* - direct start

The engine block heater and passenger compartment heater can be started directly.

Direct start can be performed via:

- information display
- remote control key\*
- mobile\*.

Upon direct start of the engine block and passenger compartment heater (p. 136), it will run for 50 minutes.

Heating of the passenger compartment will begin as soon as the engine coolant has reached the correct temperature.

### NOTE

The car can be started and driven while the heater is running.

### Direct start via the information display

1. Press **OK** to access the menu.
2. Scroll with the thumbwheel to **Parking heater** and select with **OK**.
3. Scroll forward in the next menu to **Direct start** in order to activate the heater and select with **OK**.
4. Exit the menu with **RESET**.

### Direct start via the remote control key\*

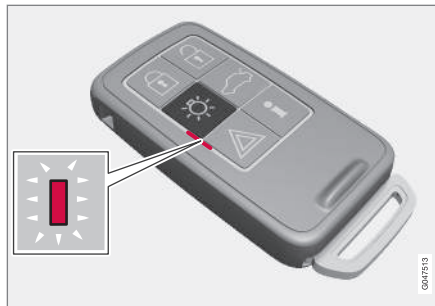

Indicator lamp on remote control key with PCC\*.

The engine block heater and passenger compartment heater can be activated via the remote control key:

- Hold the button for approach lighting  depressed for 2 seconds.
  - Hazard warning flashers provide information in accordance with the following:
    - 5 short flashes followed by a constant glow for approx. 3 seconds - the signal has reached the car and the heater has been activated.
    - 5 short flashes - the signal has reached the car but the heater has not been activated.
    - Hazard warning flashers remain switched off - the signal has not reached the car.

If the button for information  is depressed when the heater is active then the indicator lamp will show the status for this - at the same time the car's lock status (p. 160) is shown. While the status is being investigated the indicator lamp emits a pair of short flashes followed by a constant glow if the heater is active.

Status is also shown in the trip computer during heating.

### Direct start via a mobile\*

Activation and information about the selected settings that can be managed from a mobile phone will be available via the Volvo On Call\* mobile app.

### Related information

- Engine block heater and passenger compartment heater\* - timer (p. 138)
- Engine block heater and passenger compartment heater\* - immediate stop (p. 138)
- Engine block heater and passenger compartment heater\* - messages (p. 140)



## Engine block heater and passenger compartment heater\* - immediate stop

The engine block heater and passenger compartment heater can be deactivated directly via the information display.

1. Press **OK** to access the menu.
2. Scroll with the thumbwheel to **Parking heater** and select with **OK**.
3. Scroll forward in the next menu to **Stop** in order to deactivate the heater and select with **OK**.
4. Exit the menu with **RESET**.

### Related information

- Engine block heater and passenger compartment heater\* - direct start (p. 137)
- Engine block heater and passenger compartment heater\* - timer (p. 138)
- Engine block heater and passenger compartment heater\* - messages (p. 140)

## Engine block heater and passenger compartment heater\* - timer

The timer of the engine block and passenger compartment heater (p. 136) is connected to the car's clock.

Two different times can be selected using the timer. Here, time refers to the time when the car is heated and ready. The car's electronic system calculates when heating should be started based on the outside temperature.

### NOTE

All timer programming will be cleared if the car's clock is reset.

### Adjusting<sup>3</sup>

1. Press **OK** to access the menu.
2. Use the thumbwheel (p. 105) to scroll to one of the timers **Parking heater** and select with **OK**.
3. Select one of the two timers using the thumbwheel and confirm with **OK**.
4. Briefly press **OK** to move to the lit hours setting.
5. Select the required hour using the thumbwheel.

6. Briefly press **OK** to move to the flashing minutes setting.
7. Select the required minute using the thumbwheel.
8. Press **OK**<sup>4</sup> to confirm the setting.
9. Go back in the menu structure using **RESET**.
10. Select the other time (continue from step 2) or exit the menu with **RESET**.

### Starting

1. Press **OK** to access the menu.
2. Scroll with the thumbwheel to **Parking heater** and select with **OK**.
3. Select one of the two timers using the thumbwheel and activate with **OK**.
4. Exit the menu with **RESET**.

### Switching off

A timer-started heater can be switched off manually before the set time has elapsed. Proceed as follows:

1. Press **OK** to access the menu.

<sup>3</sup> Setting the timer is only possible with the engine switched off.

<sup>4</sup> Press **OK** again to activate the timer.



2. Scroll with the thumbwheel to **Parking heater** and select with **OK**.
  - > If a timer is set but not activated then a clock icon is shown beside the set time.
3. Select one of the two timers using the thumbwheel and confirm with **OK**.
4. Deactivate the timer as follows:
  - long press on **OK** or
  - short press on **OK** to continue in the menu. Then select to stop the timer and confirm with **OK**.
5. Exit the menu with **RESET**.

A timer-started heater can be switched off directly (p. 138).

#### **Related information**

- Engine block heater and passenger compartment heater\* - messages (p. 140)



# 04 Climate control

## Engine block heater and passenger compartment heater\* - messages

Symbols and display messages regarding the engine block and passenger compartment heater (p. 136) differ depending on whether the combined instrument panel (p. 59) is analogue or digital.



When the heater has been activated the heat symbol illuminates in the information display.

When one of the timers has been activated, the symbol for activated timer illuminates in the display at the same time as the set time is shown next to the symbol.



Symbol for activated timer in analogue combined instrument panel.





Symbol for activated timer in digital combined instrument panel.

The table shows symbols and display texts that appear.

Symbol	Display	Specification
		The heater is switched on and running.
 	Fuel operated heater stopped Battery saving mode	The heater has been stopped by the car's electronics in order to facilitate starting the engine.



Symbol	Display	Specification
	Fuel operated heater stopped Low fuel level	Starting the heater is not possible due to fuel level being too low - this is in order to facilitate starting the engine as well as approx. 50 km driving.
	Fuel operated heater Service required	Heater not working. Contact a workshop for repair. Volvo recommends that you contact an authorised Volvo workshop.

A display text clears automatically after a time or after one press on the indicator stalk (p. 105) **OK** button.



## 04 Climate control

### Additional heater\*

In cold climate zones<sup>5</sup> an additional heater may be required to obtain the correct operating temperature in the engine and to obtain sufficient heating in the passenger compartment.

A fuel-driven additional heater (p. 142) is fitted in cars with diesel engines.

In a semi-cold<sup>5</sup> climate zone diesel-driven cars have an electric additional heater (p. 143) instead of a fuel-driven version.

Cars with certain petrol engines<sup>6</sup> have an electric additional heater integrated into the car's climate control system.

### Related information

- Engine and passenger compartment heater\* (p. 136)

### Fuel-driven additional heater\*

The car is equipped with either an electric (p. 143) or a fuel-driven additional heater (p. 142).

The heater starts automatically when extra heat is required when the engine is running.

The heater is switched off automatically when the correct temperature is reached or when the engine is switched off.

#### NOTE

When the additional heater is active there may be smoke from the right-hand wheel housing, which is perfectly normal.

### Auto mode or shutdown

The additional heater's automatic start sequence can be switched off if required.

#### NOTE

Volvo recommends that the fuel-driven additional heater should be switched off for short distances.

1. Before starting the engine: Select key position **I** (p. 74).

2. Press **OK** to access the menu.
3. Scroll with the thumbwheel to **Additional heater**<sup>7</sup> or **Settings**<sup>8</sup> and select with **OK**.
4. Select one of the options **ON** or **OFF** using the thumbwheel and confirm with **OK**.
5. Exit the menu with **RESET**.

#### NOTE

The menu options are only visible in key position **I** - any adjustments must therefore be made before starting the engine.

### Passenger compartment heater\*

If the additional heater is supplemented with a timer function then it can be used as a passenger compartment heater (p. 136).

<sup>5</sup> An authorised Volvo dealer has information regarding the geographical areas concerned.

<sup>6</sup> An authorised Volvo dealer has information regarding the engines concerned.

<sup>7</sup> Analogue combined instrument panel.

<sup>8</sup> Digital combined instrument panel.





### Electric additional heater\*

*The car is equipped with either a fuel-driven (p. 142) or an electric additional heater (p. 142).*

The heater cannot be controlled manually, but is instead activated automatically after the engine has been started in outside temperatures below 14 °C and is switched off after the set passenger compartment temperature has been reached.

### Related information

- Engine and passenger compartment heater\* (p. 136)

# 05



## LOADING AND STORAGE

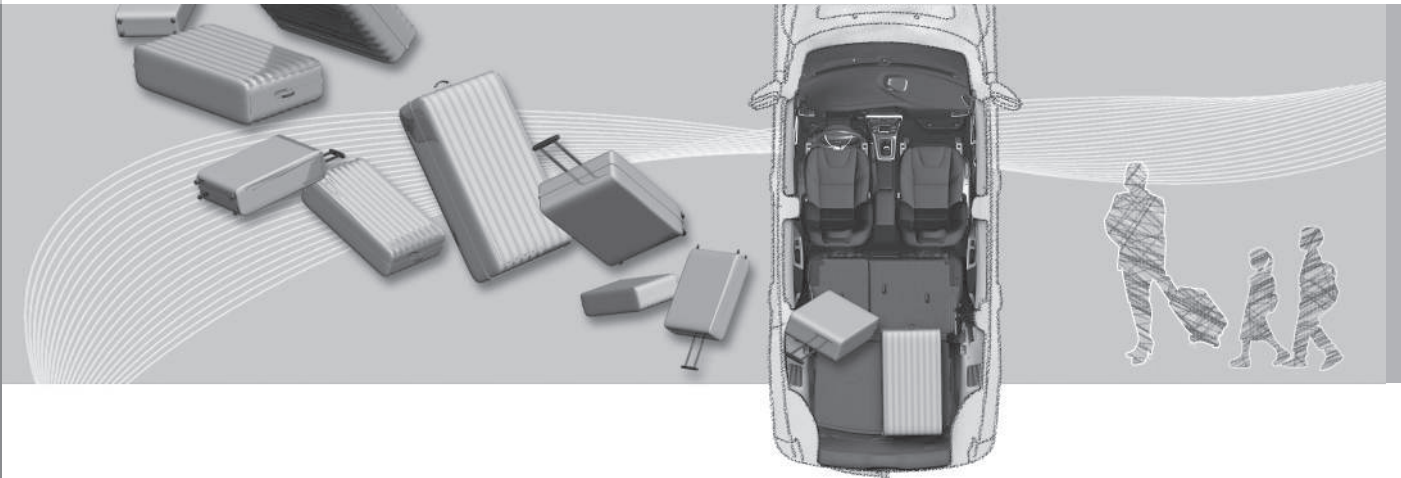



## Storage spaces

Overview of storage spaces in the passenger compartment.

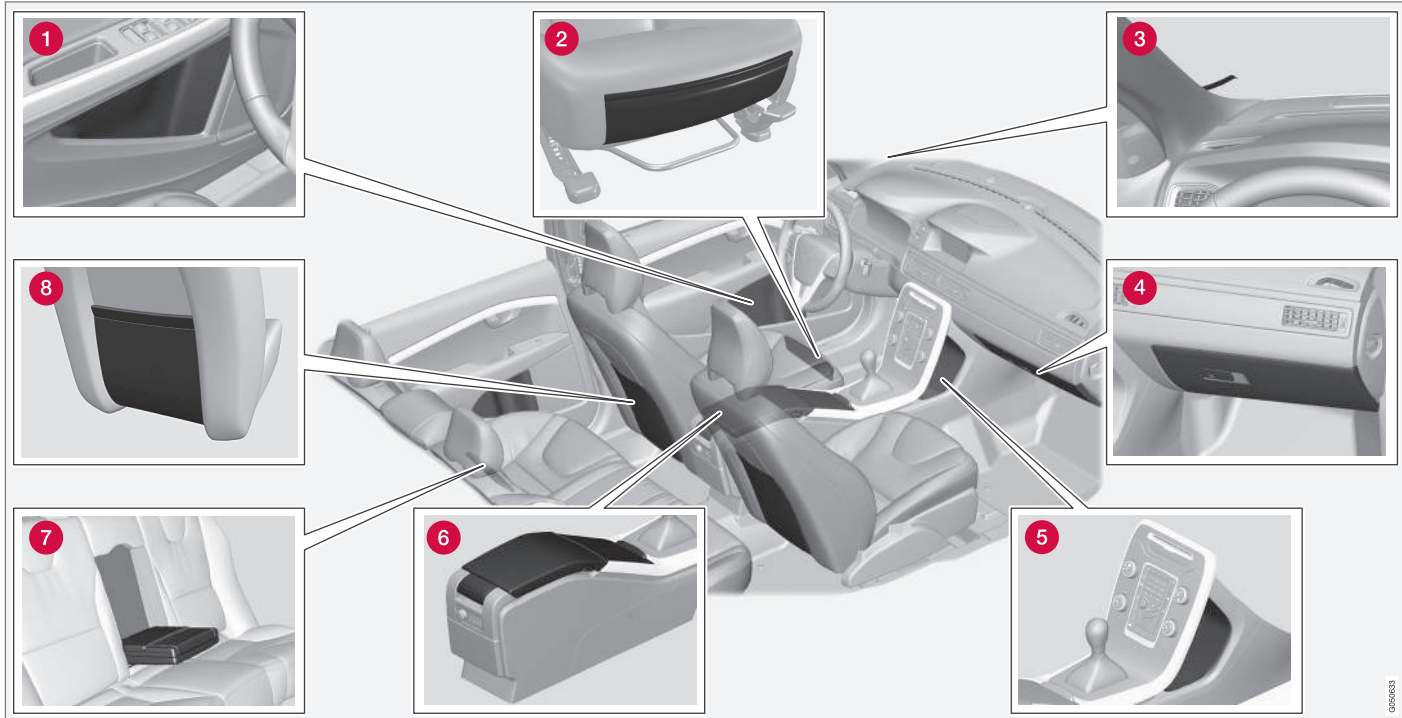



## 05 Loading and storage



- 1 Storage compartment in door panel
- 2 Storage pocket\* on front edge of front seat cushions
- 3 Ticket clip
- 4 Glovebox (p. 147)
- 5 Storage compartment
- 6 Storage compartment, cup holder (p. 147)
- 7 Cup holder\* in armrest, rear seat
- 8 Storage pocket



### WARNING

Keep loose objects such as mobile phones, cameras, remote controls for accessories, etc. in the glove compartment or other compartments. Otherwise they may injure people in the car in the event of sudden braking or a collision.



### Tunnel console

The tunnel console is located between the front seats.

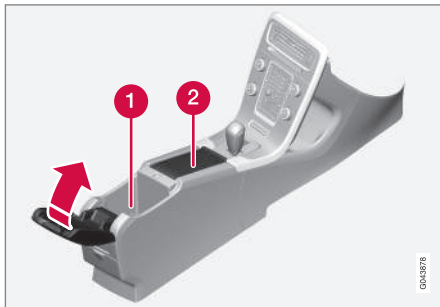

- 1 Storage compartment (e.g. for CDs) and USB\*/AUX input under the armrest.
- 2 Includes cup holder for driver and passenger. If ashtray and cigarette lighter (p. 147) are specified, then there is a cigarette lighter in the 12 V socket (p. 148) for the front seat, and a detachable ashtray in the cup holder.

#### Related information

- Storage spaces (p. 145)

### Tunnel console - cigarette lighter and ashtray\*

A detachable ashtray is fitted in the cup holder under the armrest. The cigarette lighter is fitted in the 12 V socket (p. 148) for the front seat.

The ashtray in the tunnel console (p. 147) is detached by lifting the tray straight up.

Activate the lighter by pushing in the button. The button pops out when the lighter is hot. Pull out the lighter and light a cigarette on the heated coils.

#### Related information

- Storage spaces (p. 145)

### Glovebox

The glovebox is located on the passenger side.

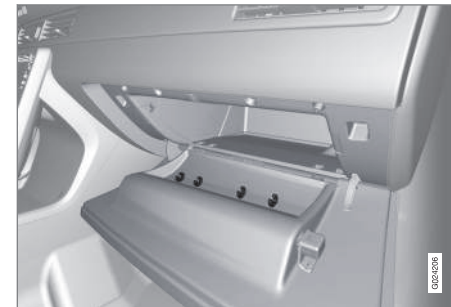

The owner's manual and maps can be kept in here for example. There are also holders for pens on the inside of the lid. The glovebox can be locked (p. 172)\* using the key blade (p. 162).

#### Related information

- Storage spaces (p. 145)

## Inlay mats\*

Inlay mats collect e.g. rubbish and slush. Volvo supplies specially manufactured inlay mats.

### WARNING

Only use one inlaid mat at each seat, and check before setting off that the mat by the driver's seat is firmly affixed and secured in the pins so that it does not get caught adjacent to and under the pedals.

## Related information

- Cleaning the interior (p. 382)

## Vanity mirror

The vanity mirror is located on the rear of the sun visor.



Vanity mirror with lighting.

The light illuminates automatically when the cover is lifted.

## Related information

- Lamp replacement - vanity mirror lighting (p. 358)

## Tunnel console - 12 V-sockets

The electrical sockets (12 V) are located next to the cup holder<sup>1</sup> and rear of the tunnel console.



12 V socket in tunnel console, front seat.



12 V socket in tunnel console, rear seat.

<sup>1</sup> If ashtray and cigarette lighter are specified then there is no cup holder and adjacent 12 V socket.



The electrical socket can be used for various accessories designed for 12 V, e.g. display screens, music players and mobile phones. For the socket to supply current, the remote control key must be in at least key position I (p. 74).

### WARNING

Always leave the plug in the socket when the socket is not in use.

### NOTE

Optional equipment and accessories - e.g. display screens, music players and mobile phones - which are connected to one of the passenger compartment's 12V electrical sockets, could be activated by the climate control system, even when the remote control key has been removed or when the car is locked, for example, when the parking heater is activated at a preset time.

For this reason remove the plugs from the electrical sockets for optional equipment or accessories when not in use because the battery could be drained in the event of such an occurrence!

### IMPORTANT

Max. socket is 10 A (120 W) if one socket is used at a time. If both sockets in the tunnel console are used simultaneously, 7.5 A (90 W) per socket is applicable.

If the compressor for emergency puncture repair is connected to one of the two sockets, no other current consumer must be connected to the other one.

### NOTE

The compressor for emergency puncture repair (p. 325) has been tested and approved by Volvo.

### Related information

- Tunnel console - cigarette lighter and ashtray\* (p. 147)
- 12 V electrical socket, cargo area\* (p. 153)

### Loading

*Payload depends on the car's kerb weight.*

Payload depends on the car's kerb weight. The total of the weight of the passengers and all accessories reduces the car's payload by a corresponding weight.

For more detailed information on weights, see Weights (p. 391).



The boot lid is opened via a button on the lighting panel or the remote control key, see Locking/unlocking - boot lid (p. 173).

### WARNING

The car's driving properties change depending on the weight and positioning of the load.

### To bear in mind when loading

- Position the load firmly against the rear seat's backrest.

Note that objects must not prevent the function of the WHIPS system for the front seats if any of the rear seat's backrests is folded down, see WHIPS - seating position (p. 37).

- Centre the load.
- Heavy objects should be placed as low as possible. Avoid placing heavy loads on lowered backrests.



## 05 Loading and storage



- Cover sharp edges with something soft to avoid damaging the upholstery.
- Secure all loads to the load retaining eyelets with straps or web lashings.

### **WARNING**

A loose object weighing 20 kg can, in a frontal collision at a speed of 50 km/h, carry the impact of an item weighing 1000 kg.

### **WARNING**

The protection provided by the inflatable curtain in the headlining may be compromised or eliminated by high loads.

- Never load cargo above the backrest.

### **WARNING**

Always secure the load. During heavy braking the load may otherwise shift, causing injury to the car's occupants.

Cover sharp edges and sharp corners with something soft.

Switch off the engine and apply the parking brake when loading/unloading long items. Otherwise you may accidentally knock the gear lever or gear selector with the load into a drive position - and the car could then move off.

### **Related information**

- Load retaining eyelets (p. 152)
- Loading - long load (p. 150)
- Roof load (p. 151)

### **Loading - long load**

*To simplify loading (p. 149) in the cargo area, the rear seat backrest can be folded down. The passenger seat<sup>2</sup> backrest can also be folded for an extra long load\*.*

### **Lowering the rear seat backrest**

If the rear seat backrest needs to be lowered, see Seats, rear (p. 78).

<sup>2</sup> Only applies to comfort seats.

\* Option/accessory, for more information, see Introduction.





## Loading - ski hatch

The hatch in the backrest can be opened to transport long narrow items.

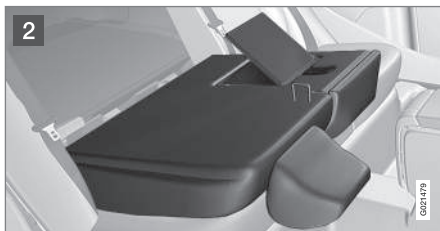

- 1 Fold the right-hand backrest forward.
- 2 Release the hatch in the rear seat backrest by sliding the bolt up while pressing the hatch down/forward.
- 3 Fold back the backrest with the hatch open.

Use the seatbelt to prevent the load from moving.

### WARNING

Stop the engine and apply the parking brake when loading and unloading. Otherwise the gear lever/selector can accidentally be knocked and moved to a driving position.

### Removing the hatch

After the hatch has been released and the backrest folded backwards, open the hatch approx. 30 degrees and pull it straight up.

### Attaching the hatch

Refit the hatch in the grooves behind the upholstery and close the hatch.

### Related information

- Loading (p. 149)

## Roof load

The load carriers recommended for roof loads are the ones developed by Volvo. This is in order to avoid damage to the car and in order to achieve the maximum possible safety during a journey.

Carefully follow the installation instructions supplied with the carriers.

- Check periodically that the load carriers and load are properly secured. Lash the load securely with retaining straps.
- Distribute the load evenly over the load carriers. Put the heaviest objects at the bottom.
- The size of the area exposed to the wind, and therefore fuel consumption, increase with the size of the load.
- Drive gently. Avoid quick acceleration, heavy braking and hard cornering.

### WARNING

The car's centre of gravity and driving characteristics are altered by roof loads.

For information about the maximum permitted load on the roof, including load carriers and any space box, see Weights (p. 391).

### Related information

- Loading (p. 149)



## 05 Loading and storage

### Load retaining eyelets

The folding load retaining eyelets<sup>3</sup> are used to fasten straps in order to anchor items in the cargo area.



### WARNING

Hard, sharp and/or heavy objects which protrude may cause injury under violent braking.

Always secure large and heavy objects with a seatbelt or cargo retaining straps.

#### Related information

- Loading (p. 149)

### Loading - bag holder\*

The bag holder keeps carrier bags in place and prevents them from overturning and spreading their contents across the cargo area.



Bag holder under folding hatch in the floor.

1. Fold up the holder, which is part of the floor hatch.
2. Fasten the bags with strap and secure the carrying handle in the hooks.

#### Related information

- Loading (p. 149)

<sup>3</sup> Number of eyes and their location varies depending on market.



### 12 V electrical socket, cargo area\*

The electrical socket can be used for various accessories designed for 12 V, e.g. display screens, music players and mobile phones.



Raise the cover to access the electrical socket.

- The socket also provides voltage when the remote control key is not in the ignition switch.

#### **!** IMPORTANT

Max. power takeoff is 10 A (120 W).

#### **i** NOTE

Remember that using the electrical socket with the engine switched off involves the risk of discharging the car's battery.

#### **i** NOTE

The compressor for temporary emergency puncture repair has been tested and approved by Volvo. For information on the use of Volvo's recommended temporary emergency puncture repair (TMK), Emergency puncture repair\* (p. 325).

# 06



## LOCKS AND ALARM





## Remote control key

Amongst other things, the remote control key is used for locking/unlocking and starting the engine.

There are two variants of remote control key - Remote control key in basic version and Remote control key with PCC (Personal Car Communicator)\*.

Functionality	Basic <sup>A</sup>	with PCC <sup>B</sup>
Locking/unlocking and detachable key blade	x	x
Keyless locking/unlocking		x
Keyless engine starting		x
Information button and indicator lamps		x

<sup>A</sup> 5-button key

<sup>B</sup> 6-button key

Remote control key with PCC has extended functionality compared with the remote control key in the basic version - e.g. support for Keyless Drive (p. 166) and certain unique functions (p. 160).

All remote control keys have a detachable key blade (p. 162) made of metal. The visible section is available in two versions so that it is possible to distinguish between the remote control keys.

More remote control keys can be ordered - but not variants other than the one supplied with the car. Up to six keys can be programmed and used for one single car.

The car is supplied with two remote control keys



### WARNING

If there are children in the car:

Remember to switch off the supply to the power windows and sunroof by removing the remote control key if the driver leaves the car.

### Related information

- Remote control key - functions (p. 158)

## Remote control key - losing

If you lose a remote control key then a new one can be ordered at a workshop - an authorised Volvo workshop is recommended.

The remaining remote control keys must be taken to the Volvo workshop. The code of the missing remote control key must be erased from the system as a theft prevention measure.

The current number of keys registered to the car can be checked in the menu system MY CAR. For a description of the menu system, see MY CAR (p. 108).

### Related information

- Remote control key - functions (p. 158)



### Remote control key - personalisation\*

*The key memory in the remote control key (p. 155) means that certain settings in the car can be individually adapted for different people.*

The key memory function is available in combination with power\* driver's seat.

Settings for door mirrors (p. 99), driver's seat, steering force (p. 245) and the combined instrument panel's theme, contrast and colour mode (p. 60) can be stored in the memory, depending on the car's equipment level.

The function<sup>1</sup> can be activated/deactivated in the menu system MY CAR. For a description of the menu system, see MY CAR (p. 108).

When the function is activated, the settings are automatically linked to the key memory. This means that a change in a setting will automatically be saved to the specific remote control key's memory.

### Storing settings

Make sure that the key memory function is activated in the menu system MY CAR.

Proceed as follows in order to store the settings and use the key memory in the remote control key:

1. Unlock the car with the remote control key in whose memory the setting<sup>2</sup> shall be stored.
2. Make the desired settings for e.g. the seat and the door mirrors.
3. The settings are stored in the current remote control key's memory.

The next time the car is unlocked with the same remote control key, the positions that are stored in the key memory will be set automatically - providing that they have been changed since the last time the current remote control key was used.

### Emergency stop

If the seat accidentally begins to move, press one of the setting buttons for the seat or memory buttons in order to stop the seat.

Restarting to reach the seat position stored in the key memory is performed by pressing the unlock button on the remote control key. The driver's door must then be open.



### WARNING

Risk of crushing! Make sure that children do not play with the controls. Check that there are no objects in front of, behind or under the seat during adjustment. Ensure that none of the rear seat passengers is in danger of becoming trapped.

### Changing settings

If several people each with a remote control key approach the car, then the settings for e.g. seat and door mirrors are implemented for the person whose remote control key unlocks the driver's door.

If the driver's door has been opened by person A with remote control key A, but person B with remote control key B shall drive, then the settings can be changed as follows:

- Standing by the driver's door, or sitting behind the steering wheel, person B presses the button for unlocking on his/her remote control key, see Remote control key - functions (p. 158).
- Select one of three possible memories for seat adjustment with seat button 1-3, see

<sup>1</sup> Called Car key memory in MY CAR.

<sup>2</sup> This setting does not affect settings that have been stored in the power seat's memory function.



Seats, front - electrically operated\* (p. 77).

- Adjust seat and door mirrors manually, see Seats, front - electrically operated\* (p. 77) and Door mirrors (p. 99).

### Related information

- Remote control key with PCC\* - unique functions (p. 160)

### Locking/unlocking - indicator

*When the car is locked or unlocked using the remote control key (p. 155) the direction indicators confirm that locking/unlocking was correctly performed.*

- Locking - one flash and the door mirrors are folded<sup>3</sup> in.
- Unlocking - two flashes and the door mirrors are folded<sup>3</sup> out.

After locking the indication is only given if all locks are activated once the doors have been closed.

### Selecting the function

Different options for indicating locking/unlocking with light can be set in the car's menu system MY CAR. For a description of the menu system, see MY CAR (p. 108).

### Related information

- Keyless drive\* (p. 166)
- Alarm indicator (p. 177)

### Immobiliser

*The electronic immobiliser is a theft protection system that prevents an unauthorised person from starting the car.*

Each remote control key (p. 155) has a unique code. The car can only be started with the correct remote control key with the correct code.

The following error messages in the combined instrument panel's information display are related to the electronic immobiliser:

<sup>3</sup> Only for cars with retractable power door mirrors.



Message	Specification
Insert car key	Error when reading the remote control key during starting - Remove the key from the ignition switch, press it in again and make a new start attempt.
Car key not found	Error reading the remote control key during starting - Try to start again.  If the error persists: Insert the remote control key into the ignition switch and try to start again.
Immobiliser Try to start again	Error in immobiliser system during starting. If the error persists: Contact a workshop - an authorised Volvo workshop is recommended.

For starting the car, see Starting the engine (p. 252).

### Related information

- Remote-controlled immobiliser with tracking system (p. 158)

### Remote-controlled immobiliser with tracking system

*Remote-controlled immobiliser with tracking system makes it possible to track and locate the car, and to remotely activate the immobiliser to switch off the engine.*

Contact your nearest Volvo dealer for more information and assistance with activating the system.

### Related information

- Remote control key (p. 155)
- Immobiliser (p. 157)





### Remote control key - functions

*The remote control key in basic version has functions such as locking and unlocking the doors.*

### Functions



*Remote control key in basic version.*

-  Locking
-  Unlocking
-  Approach light duration
-  Boot lid
-  Panic function





Remote control key with PCC\* (Personal Car Communicator).

Information

### Function buttons

**Locking** – Locks the doors and boot lid while the alarm is activated.

Press and hold to close all the windows and sunroof\* simultaneously. For more information, see Total airing function (p. 172).

### WARNING

If the sunroof and windows are closed using the remote control key, check that nobody's hands are trapped.

**Unlocking** – Unlocks the doors and boot lid while the alarm is deactivated.

Press and hold to open all windows simultaneously. For more information, see Total airing function (p. 172).

The function can be changed from unlocking all doors simultaneously, to unlocking the driver's door only with one press of the button and, after a further press of the button - within ten seconds - unlocking the remaining doors.

The function can be changed in the menu system MY CAR. For a description of the menu system, see MY CAR (p. 108).

**Approach light duration** – Used to switch on the car's lighting at a distance. For more information, see Approach lighting (p. 91).

**Boot lid (p. 173)** - Unlocks and disarms the alarm for the boot lid only.

**Panic function** – Used to attract attention in an emergency.

Press and hold the button for at least 3 seconds or press it twice within 3 seconds to activate the direction indicators and the horn.

The function can be turned off with the same button once it has been active for at least 5 seconds. Otherwise the function switches off automatically after approx. 3 minutes.

### Related information

- Remote control key (p. 155)
- Remote control key with PCC\* - unique functions (p. 160)
- Locking/unlocking - from the outside (p. 171)



## Remote control key - range

Remote control key functions (in its basic version) have a range of approx. 20 metres from the car.

If the car does not verify a button being pressed - move closer and try again.

### NOTE

The remote control key functions may be disrupted by surrounding radio waves, buildings, topographical conditions, etc. The car can always be locked/unlocked with the key blade (p. 163).

If the remote control key is removed from the car when the engine is running or key position I or II (p. 74) is active, and if all doors are closed, then a warning message is shown in the information display in the combined instrument panel and an audio reminder signal sounds at the same time.

The message is extinguished and the audible reminder signal stops when the remote control key is brought back to the car after either/or:

- The remote control key has been inserted in the ignition switch.
- Speed exceeds 30 km/h.
- The **OK** button has been pressed.

## Related information

- Remote control key (p. 155)
- Remote control key - functions (p. 158)

## Remote control key with PCC\* - unique functions

A remote control key with PCC has enhanced functionality compared with a remote control key in basic version (p. 155) in the form of an information button and indicator lamps.

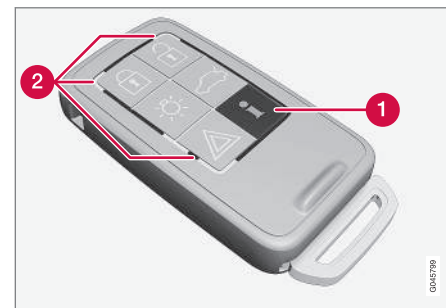

Remote control key with PCC.

- 1 Information button
- 2 Indicator lamps

Using the information button enables access to certain information from the car via the indicator lamps.



### Using the information button

- Press the information button .
  - > All indicator lamps flash for approximately 7 seconds and the light travels around on the remote control key. This indicates that information from the car is being scanned.

If any of the other buttons are pressed during this time then the reading is interrupted.

#### NOTE

 If none of the indicator lamps illuminates with repeated use of the information button and in different locations (as well as after 7 seconds and after the light has travelled around on the PCC), contact a workshop - an authorised Volvo workshop is recommended.

Indicator lamps display information in accordance with the following illustration:

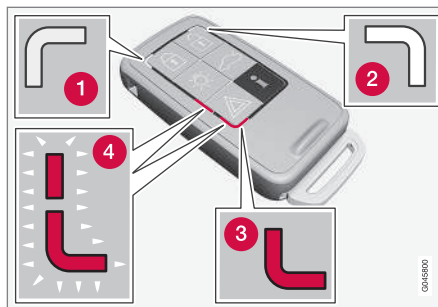

- 1 Green continuous light – the car is locked.
- 2 Yellow continuous light – the car is unlocked.
- 3 Red continuous light – the alarm has been triggered since the car was locked.
- 4 Red light flashing alternately in both indicator lamps – The alarm was triggered less than 5 minutes ago.

#### Related information

- Remote control key with PCC\* - range (p. 161)

### Remote control key with PCC\* - range

*The range of a remote control key with PCC (Personal Car Communicator) for locking, unlocking the doors and boot lid is approx. 20 metres from the car - the other functions are up to approx. 100 metres.*

If the car does not verify a button being pressed - move closer and try again.

#### NOTE

The information button function may be disrupted by surrounding radio waves, buildings, topographical conditions, etc.

### Outside the remote control key's range

If the remote control key is too far away from the car for the information to be read then the status the car was last left in is shown, without the light in the indicator lamps travelling around on the remote control key.

If several remote control keys are used for the car then it is only the one last used for locking/unlocking that shows the correct status.

#### NOTE

 If no indicator lamps illuminate when the information button is used within range then this may be because the last communication between the remote control key and the car was disrupted by surrounding radio waves, buildings, topographical conditions, etc.





## Related information

- Keyless Drive\* - remote control key range (p. 166)
- Remote control key - range (p. 160)

## Detachable key blade

A remote control key contains a detachable key blade of metal with which some functions can be activated and some operations carried out.

The key blade's unique code is provided by authorised Volvo workshops, which are recommended when ordering new key blades.

## Key blade functions

Using the remote control key's detachable key blade:

- the driver's door can be opened manually if central locking cannot be activated with the remote control key, see Detachable key blade - unlocking doors (p. 163).
- the rear doors' mechanical child safety locks can be activated/deactivated (p. 175).
- access to the glovebox and cargo area (privacy locking (p. 163)\*) can be blocked.
- the airbag for front passenger seat (PACOS\*) can be activated/deactivated (p. 32).

## Related information

- Remote control key - functions (p. 158)
- Remote control key (p. 155)

## Detachable key blade - detaching/attaching

Detaching/attaching the detachable key blade (p. 162) is carried out as follows:

### Removing the key blade



- 1 Slide the spring-loaded catch to the side.
- 2 At the same time pull the key blade straight out backwards.

### Attaching the key blade

Carefully refit the key blade into its location in the remote control key (p. 155).

1. Hold the remote control key with the slot pointed up and lower the key blade into its slot.
2. Lightly press the key blade. You should hear a "click" when the key blade is locked in.



### Related information

- Detachable key blade - unlocking doors (p. 163)
- Child safety locks - manual activation (p. 175)
- Passenger airbag - activating/deactivating\* (p. 32)

### Detachable key blade - unlocking doors

The detachable key blade (p. 162) can be used if central locking cannot be activated with the remote control key (p. 155), e.g. if the key's battery has run out.

If central locking cannot be activated with the remote control key - e.g. if the batteries are discharged - then the driver's door can be opened as follows:

1. Unlock the driver's door with the key blade in the door handle's lock cylinder. For illustration and more information, see Keyless drive\* - unlocking with the key blade (p. 169).

#### NOTE

When the door has been unlocked using the key blade and is opened, the alarm is triggered.

2. Deactivate the alarm by inserting the remote control key in the ignition switch.

For cars with the Keyless system, see Keyless drive\* - unlocking with the key blade (p. 169).

### Related information

- Remote control key (p. 155)
- Remote control key - replacing the battery (p. 165)

### Privacy locking\*

Privacy locking is intended for when the car is left for service, with a hotel parking valet or similar. The glovebox is then locked and the boot lid lock is disconnected from the central locking - the boot lid cannot be opened with either the central locking button in the front doors or the remote control key (p. 155).

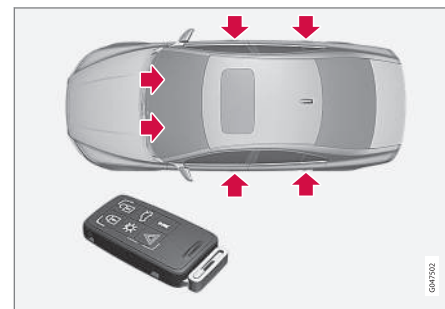

Active locks for remote control key **with** key blade.



## 06 Locks and alarm

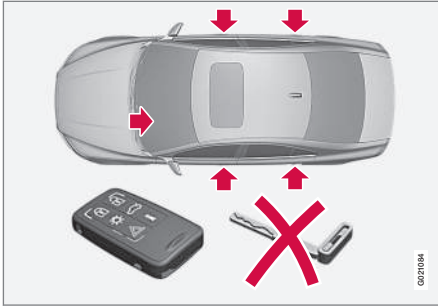

Active locks for remote control key, **without** key blade and privacy locking **activated**.

This means that the remote control key without key blade can only be used to activate/deactivate the alarm (p. 176), to open the doors and to drive the car.

The remote control key without key blade can then be handed over to the service or hotel staff - the loose key blade is retained by the car owner.

### Activate/deactivate



Activating privacy locking.

To activate privacy locking:

- 1 Insert the key blade in the glovebox lock cylinder.
- 2 Turn the key blade 180 degrees clockwise. The keyhole is vertical in the locked position for privacy locking.
- 3 Pull out the key blade. The combined instrument panel's information display shows a message at the same time.

The glovebox is then locked and the boot lid can no longer be unlocked with the remote control key or the central locking button.



### NOTE

Do not reinsert the key blade into the remote control key, but keep it in a safe place instead.

- Deactivation takes place in reverse order. For information on locking the glovebox only, see Locking/unlocking - glovebox (p. 172).



## Remote control key - replacing the battery

The battery<sup>4</sup> for the remote control key may need to be replaced.

The battery for the remote control key should be replaced if:

- the information symbol in the combined instrument panel illuminates and the display shows **Low battery in remote control**. Please change batteries.
- and/or
- the locks repeatedly do not react to signals from the remote control key within 20 metres from the car.

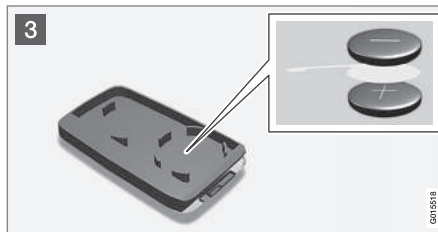

### Opening

- 1 Slide the spring-loaded catch to the side.
- 2 At the same time pull the key blade straight out backwards.
- 2 Insert a 3 mm slot screwdriver in the hole behind the spring-loaded catch and gently prize the remote control key open.

### NOTE

Turn the remote control key over with the buttons facing up, this is to avoid the batteries falling out when it is opened.

### IMPORTANT

Avoid touching new batteries and their contact surfaces with your fingers as this may impair their function.

### Battery replacement

- 3 Closely study how the battery/batteries are secured on the inside of the cover, with regard to their (+) and (-) sides.

### Remote control key (one battery)

1. Carefully prize out the battery.
2. Install a new one with the (+) side down.

### Remote control key with PCC\* (two batteries)

1. Carefully prize out the batteries.
2. First install one new one with the (+) side up.
3. Position the white plastic tab in between and finally install a second new battery with the (+) side down.

<sup>4</sup> Remote control key with PCC has two batteries.



# 06 Locks and alarm



## Battery type

Use batteries with the designation CR2430, 3V - one in the remote control key, two in the remote control key with PCC.

### NOTE

Volvo recommends that the batteries to be used in the remote control key/PCC fulfil UN Manual of Test and Criteria, Part III, sub-section 38.3. Batteries fitted in the factory or replaced by an authorised Volvo workshop fulfil the above criteria.

## Assembly

1. Press the remote control key together.
2. Hold the remote control key with the slot pointed up and lower the key blade into its slot.
3. Lightly press the key blade. You should hear a "click" when the key blade is locked in.

### IMPORTANT

Make sure that exhausted batteries are disposed of in a manner which is kind to the environment.

## Related information

- Remote control key (p. 155)
- Remote control key - functions (p. 158)

<sup>5</sup> Only applies to Remote Control Key with PCC.

## Keyless drive\*

*Cars equipped with Keyless Drive have a starting and locking system that can be operated keylessly.*

With the keyless starting and locking system the car can be started, locked and unlocked without the remote control key (p. 155)<sup>5</sup> inserted in the ignition switch. It is enough to have the remote control key with you in a pocket. The system makes it easier and more convenient to e.g. open the car when your hands are full.

Both of the remote control keys included with the car have Keyless functionality. It is possible to order more remote control keys.

The car's electrical system can be set to three different levels - key position **0**, **I** and **II** (p. 74) - with the remote control key.

## Related information

- Keyless Drive\* - remote control key range (p. 166)
- Keyless drive\* - secure handling of the remote control key (p. 167)
- Keyless drive\* - interference to remote control key function (p. 168)

## Keyless Drive\* - remote control key range

*In order to unlock the doors or boot lid automatically without pressing a button on the*





remote control key<sup>6</sup>, a remote control key must be within approx. 1.5 metres from the car's door handle or boot lid.

The person who wishes to lock or unlock a door must have the remote control key with him or her. It is not possible to lock or unlock a door if the remote control key is on the opposite side of the car.

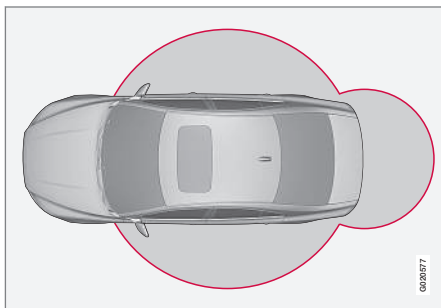

The red rings in the above figure indicate the range covered by the system's antennas.

If all remote control keys are removed from the car when the engine is running or key position I or II (p. 74) is active, and if all doors are closed, then a warning message is shown in the information display in the combined instrument panel and an audio reminder signal sounds at the same time.

When the remote control key has been returned to the car, the warning message goes off and the audible reminder ceases once either/or:

- a door has been opened and closed
- the remote control key has been inserted in the ignition switch
- The **OK** button has been pressed.

#### Related information

- Keyless drive\* (p. 166)
- Keyless Drive\* - antenna location (p. 170)

#### Keyless drive\* - secure handling of the remote control key

*It is important to handle the car's remote control keys with great care.*

If one of the remote control keys<sup>7</sup> has been left in the car then the Keyless functionality is deactivated in case the car is e.g. locked with the other remote control key that belongs to the car. This prevents unauthorised entry.

The next time the car is unlocked with the other remote control key the forgotten remote control key is reactivated again.



#### IMPORTANT

Avoid leaving the remote control key with PCC behind in the car. If someone breaks into your car and takes the remote control key, it will e.g. be possible to start the car by pressing the remote control key in the ignition switch and then pressing the **START/STOP ENGINE** button.

#### Related information

- Keyless drive\* (p. 166)

<sup>6</sup> Applies to remote control key with PCC (Personal Car Communicator).

<sup>7</sup> Applies to remote control key with PCC (Personal Car Communicator).



## Keyless drive\* - interference to remote control key function

Electromagnetic fields and screening can interfere with the remote control key's Keyless functions (p. 166).

### NOTE

Do not place/store the PCC near a mobile phone or metal object - no closer than 10-15 cm.

If interference is experienced nonetheless, use the remote control key and the key blade like a remote control key in basic version, see Remote control key - functions (p. 158).

### Related information

- Remote control key - replacing the battery (p. 165)
- Keyless drive\* - secure handling of the remote control key (p. 167)
- Keyless Drive\* - remote control key range (p. 166)

## Keyless drive\* - locking

Cars equipped with Keyless drive have a button on the outer door handles for locking/unlocking.



Cars with the keyless system have a button on the outside door handles.

Lock the doors and the boot lid by pressing the lock button on one of the door handles on the outside.

All doors and the boot lid must be closed before the car can be locked - otherwise the car is not locked.

### NOTE

In cars with automatic gearbox selectors, the gear selector must be set to the **P** position; otherwise the car can be neither locked nor alarmed.

### Related information

- Keyless drive\* (p. 166)
- Alarm indicator (p. 177)



### Keyless drive\* - unlocking

Unlocking takes place when a hand grasps a door handle or the boot lid's rubberised pressure plate is actuated - open the door or boot lid as normal.

#### Related information

- Keyless drive\* (p. 166)
- Keyless drive\* - locking (p. 168)

### Keyless drive\* - unlocking with the key blade

If central locking cannot be unlocked with the remote control key, e.g. if the batteries are discharged, then the left-hand front door can be opened using the detachable key blade.

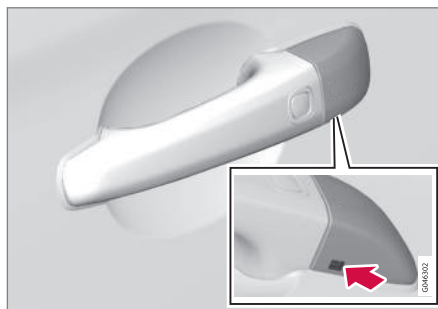

Hole for key blade - to loosen the cover.

To access the lock cylinder, the door handle's plastic cover must be removed - this is also done with the key blade:

1. Press the key blade approx. 1 cm straight up into the hole on the underside of the door handle/cover - do not prize.
  - > The plastic cover loosens automatically by means of the torque when the blade is pushed straight up and into the opening.

2. Then insert the key blade in the lock cylinder and unlock the door.
3. Refit the plastic cover after unlocking.



#### NOTE

When the driver's door is unlocked using the key blade and is opened, the alarm is triggered. It is switched off by inserting the PCC in the ignition switch, see Alarm - remote control key not working (p. 178).

#### Related information

- Keyless drive\* (p. 166)
- Detachable key blade - detaching/attaching (p. 162)
- Alarm (p. 176)



### Keyless Drive\* - lock settings

Lock settings for cars equipped with Keyless Drive can be adapted by indicating in the menu system MY CAR which doors are to be unlocked.

For a description of the menu system, see MY CAR (p. 108).

#### Related information

- Keyless drive\* (p. 166)

### Keyless Drive\* - antenna location

Cars equipped with Keyless Drive have a number of built-in antennae positioned at different locations in the car.

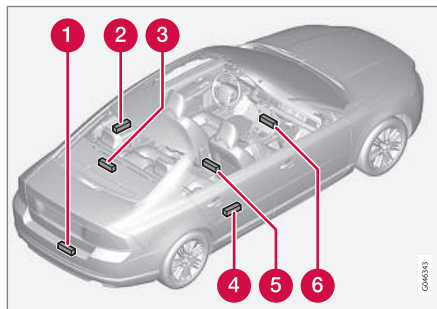

- 1 Rear bumper, centre
- 2 Door handle, left rear
- 3 Parcel shelf, centre, underside
- 4 Door handle, right rear
- 5 Centre console, under the rear section
- 6 Centre console, under the front section.



### WARNING

People with pacemaker operations should not come closer than 22 cm to the keyless system's antennae with their pacemaker. This is to prevent interference between the pacemaker and the keyless system.

#### Related information

- Keyless drive\* (p. 166)



## Locking/unlocking - from the outside

Locking/unlocking from the outside is carried out using the remote control key (p. 155). The remote control key can lock/unlock all doors and the boot lid simultaneously. Different sequences for unlocking can be selected, see Remote control key - functions (p. 158).

In order that the lock sequence can be activated, the driver's door must be closed - if any of the other doors or the boot lid is open, then it/they is/are locked and the alarm is activated only when it/they are closed. For cars equipped with keyless locking system\* all doors and the boot lid must be closed.

### **i** NOTE

Be aware of the risk of locking the remote control key in the car.

If it is not possible to lock/unlock with the remote control key, the battery may be discharged - lock or unlock the driver's door with the detachable key blade, see Detachable key blade - detaching/attaching (p. 162).

### **i** NOTE

Remember that the alarm is triggered when the door is opened after being unlocked with the key blade - the alarm is switched off when the remote control key is inserted into the ignition switch.

### **!** WARNING

Be aware of the risk of being locked in the car when it is locked from the outside using the remote control key - it is then not possible to open any of the doors from the inside with the door controls. For more information, see Deadlocks\* (p. 174).

### Automatic reloading

If none of the doors or the boot lid is opened within two minutes of unlocking, all are locked again automatically. This function reduces the risk that the car is left unlocked unintentionally. (For cars with alarm, see Alarm (p. 176).)

### Related information

- Locking/unlocking - from the inside (p. 171)
- Keyless drive\* (p. 166)

## Locking/unlocking - from the inside

All of the doors and the tailgate are locked or unlocked simultaneously using the central locking button on the driver's door and passenger door\*.

### Central locking

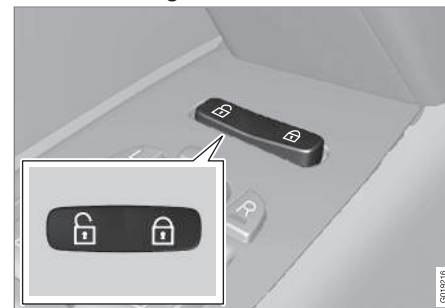

Central locking.

- Press one side  of the button to lock - the other side  to unlock.

Press and hold to also open all side windows\* simultaneously.

### Unlocking

A door can be unlocked from the inside in two different ways:

- Press the central locking button .

A long press also opens all the side windows\* simultaneously (see also Total airing function (p. 172)).



## 06 Locks and alarm



- Pull the door handle once and release - the door is unlocked. Pull the door handle again to open the door.

### Locking

- Press the central locking button  after the front doors have been closed.

A long press also closes all side windows and sunroof simultaneously (see also Total airing function (p. 172)).

All doors can also be individually locked manually with their lock buttons - the door in question must then be closed.

### Automatic locking

The doors and boot lid are locked automatically when the car starts to move.

The function can be activated/deactivated in the menu system **MY CAR**. For a description of the menu system, see MY CAR (p. 108).

### Related information



- Locking/unlocking - from the outside (p. 171)
- Alarm (p. 176)
- Remote control key - functions (p. 158)

### Total airing function

*The total airing function opens or closes all side windows simultaneously and can be used for example to quickly air the car during hot weather.*



Central locking button

A long press on the  symbol in the central locking button **opens** all side windows simultaneously. The same procedure on the  symbol **closes** all side windows simultaneously.

### Related information

- Locking/unlocking - from the inside (p. 171)
- Power windows (p. 97)



### Locking/unlocking - glovebox

*The glovebox (p. 147) can only be locked/unlocked using the detachable key blade from the remote control key.*

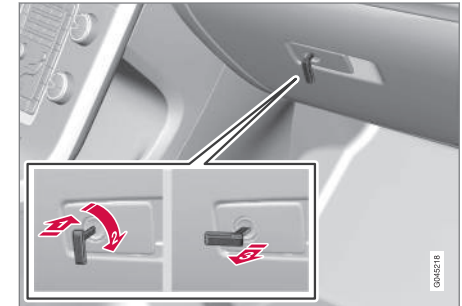
For information on the key blade, see Detachable key blade - detaching/attaching (p. 162).



Locking the glovebox:

-  Insert the key blade in the glovebox lock cylinder.
  -  Turn the key blade 90 degrees clockwise. The keyhole is horizontal in the locked position.
  -  Pull out the key blade.
- Unlock by carrying this out in reverse order.

For information on privacy locking, see Privacy locking\* (p. 163).



## Locking/unlocking - boot lid

The boot lid can be opened, locked and unlocked in several ways.

### Unlocking with the remote control key

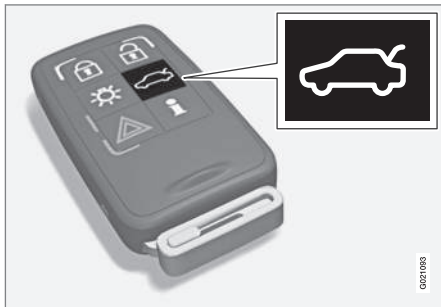

The alarm for the tailgate can be disarmed\* and the tailgate unlocked on its own by using the remote control key's  button.

If the car is equipped with an alarm\* the alarm indicator on the instrument panel stops to show that alarm for the whole of the car is not armed. The alarm's level and movement sensors and the sensors for opening the boot lid are disconnected.

The doors remain locked and armed.

- The tailgate is unlocked, but remains closed - press lightly on the rubberised pressure plate under the outer handle and lift the tailgate.

If the boot lid is not opened within two minutes then it is relocked and the alarm is re-armed.

### The boot lid can be opened in two different ways

**One press** - The boot lid is unlocked, but remains closed - press lightly on the rubberised pressure plate under the outer handle and lift the boot lid.

If the boot lid is not opened within two minutes then it is relocked and the alarm is re-armed.

**Two presses** - The boot lid is unlocked and the lock is disengaged at which the boot lid opens about a centimetre - lift the outer handle to open. Rain, cold, frost or snow could however prevent the tailgate from disengaging from the lock.

#### NOTE

- When the boot lid/tailgate is unlocked with 2 presses, automatic relocking does not take place because the boot lid/tailgate is open - it must be closed manually.
- After the boot lid/tailgate has been closed it is unlocked and the alarm is not armed - relock it and re-arm the alarm with the remote control key's lock button .

### Locking with the remote control key

- Press the remote control key (p. 158) button for locking .

If the car is equipped with an alarm\* the alarm indicator on the instrument panel starts to flash, which means that the alarm is armed.

### Unlocking the car from inside



To unlock the boot lid:

- Press the lighting panel button. (1)
  - > The lock releases and the tailgate opens by a few centimetres.

#### Related information

- Locking/unlocking - from the inside (p. 171)
- Locking/unlocking - from the outside (p. 171)



## 06 Locks and alarm

### Deadlocks\*

*Deadlocks means that all lock buttons and door handles are mechanically disengaged, which prevents doors being opened from both inside and outside.*

The deadlocks are activated with the remote control key (p. 155) and are set after an approx. ten seconds delay after the doors have been locked.

#### **i** NOTE

If a door is opened within the delay time then the sequence is interrupted and the alarm is deactivated.

The car can only be unlocked with the remote control key when the deadlocks function is activated. The front left door can also be unlocked with the detachable key blade (p. 162). In addition, it is possible to unlock and open the doors and boot lid on cars equipped with the Keyless Drive\* by touching door handles or the handle on the boot lid.

#### **!** WARNING

Do not allow anyone to remain in the car without first deactivating the deadlocks in order to avoid the risk of anyone being locked in.

### Temporary deactivation

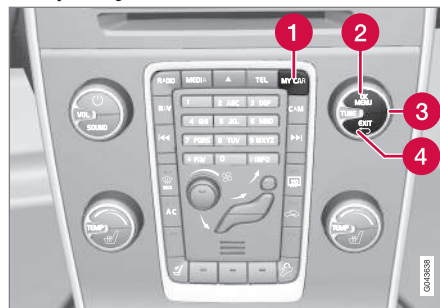

Active menu options are indicated with a cross.

- 1 MY CAR**
- 2 OK MENU**
- 3 TUNE knob control**
- 4 EXIT**

If someone is going to stay in the car but the doors must be locked from the outside, then the deadlocks function can be temporarily switched off. This takes place the menu system **MY CAR**. For a description of the menu system, see MY CAR (p. 108).

#### **i** NOTE

- Remember that the alarm is activated when the car is locked.
- If any of the doors are opened from the inside then the alarm is triggered.

### Related information

- Keyless drive\* - unlocking with the key blade (p. 169)
- Remote control key (p. 155)





### Child safety locks - manual activation

The child safety locks prevent children from being able to open a rear door from the inside.

#### Activate/deactivate child safety locks

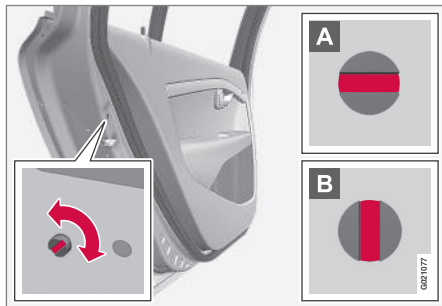

The child safety locks are located on the trailing edge of the rear doors and are only accessible when the doors are open.

To activate/deactivate the child safety locks:

- Use the remote control key's detachable key blade (p. 162) to turn the knob.

- A** The door is blocked against opening from the inside.
- B** The door can be opened from both the outside and the inside.

#### **i** NOTE

- A door's knob control only blocks that particular door - not both rear doors simultaneously.
- Cars with an electric child safety lock do not have a manual child lock.

#### Related information

- Child safety locks - electrical activation\* (p. 175)
- Locking/unlocking - from the inside (p. 171)
- Locking/unlocking - from the outside (p. 171)

### Child safety locks - electrical activation\*

Child safety locks with electrical activation prevent children from opening the rear doors or windows from the inside.

#### Activation

The child safety locks can be activated/deactivated in all key positions (p. 74) higher than **0**. Activation/deactivation can be performed up to 2 minutes after switching off the engine, provided that no door is opened.

To activate the child safety locks:



Control panel driver's door.

1. Start the engine or choose a key position higher than **0**.



## 06 Locks and alarm



2. Press the button in the driver's door control panel.
  - > The combined instrument panel's information display shows the message **Rear child lock activated** and the button's lamp illuminates - the locks are active.

When the child safety lock is active then the rear:

- windows can only be opened with the driver's door control panel
- doors cannot be opened from inside.

The current setting is stored when the engine is switched off - if the child safety locks are activated at engine shutdown, the function will remain activated the next time the engine is started.

### Related information

- Child safety locks - manual activation (p. 175)
- Locking/unlocking - from the inside (p. 171)

### Alarm

*The alarm is a device that warns in the event of e.g. a break-in in the car.*

Activated alarm is triggered if:

- a door, the bonnet or the boot lid is opened
- a movement is detected in the passenger compartment (if fitted with a movement detector\*)
- the car is raised or towed away (if fitted with a tilt detector\*)
- the battery's cable is disconnected
- the siren is disconnected.

If there is a fault in the alarm system then the information display in the combined instrument panel shows a message. In which case, contact a workshop - an authorised Volvo workshop is recommended.



### NOTE

The movement sensors trigger an alarm in the event of movement in the passenger compartment - air currents are also registered. For this reason the alarm is triggered if the car is left with a window or the sunroof open or if the passenger compartment heater is used.

To avoid this: Close the window/sunroof when leaving the car. If the car's integrated passenger compartment heater (or a portable electric heater) shall be used - direct the airflow from the air vents so that they are not pointing upwards in the passenger compartment. Alternatively, reduced alarm level can be used, see Reduced alarm level (p. 178).



### NOTE

Do not attempt to repair or alter components in the alarm system yourself. Any such attempts may affect the terms of the insurance.

### Arming the alarm

- Press the remote control key lock button.

### Deactivate the alarm

- Press the remote control key unlock button.



### Deactivating a triggered alarm

- Press the remote control key unlock button or insert the remote control key in the ignition switch.

### Related information

- Alarm indicator (p. 177)
- Alarm - automatic re-arming (p. 177)
- Alarm - remote control key not working (p. 178)

### Alarm indicator

The alarm indicator shows alarm system (p. 176) status.

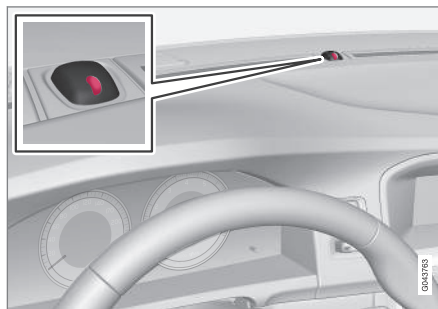

A red LED on the instrument panel indicates the alarm system's status:

- LED not lit – Alarm not armed
- The LED flashes once every other second – Alarm is armed
- The LED flashes rapidly after disarming the alarm (and until the remote control key is inserted in the ignition switch and key position **I** is selected) – Alarm has been triggered.

### Alarm - automatic re-arming

Automatic re-arming of the alarm (p. 176) prevents the car being left with the alarm disarmed unintentionally.

If the car is unlocked with the remote control key (and the alarm is disarmed) but none of the doors or the tailgate is opened within 2 minutes, then the alarm is automatically re-armed. The car is relocked at the same time.

### Related information

- Reduced alarm level (p. 178)



### Alarm - remote control key not working

If the alarm (p. 176) cannot be deactivated with the remote control key, e.g. if the key's battery (p. 165) is discharged - the car can be unlocked, disarmed and the engine started as follows:

1. Open the driver's door with the detachable key blade (p. 169).
  - > The alarm is triggered, the alarm indicator (p. 177) flashes rapidly and the siren sounds.



2. Insert the remote control key in the ignition switch.
  - > The alarm is deactivated and the alarm indicator goes out.
3. Start the engine.

<sup>8</sup> Only in combination with alarm.

### Alarm signals

When the alarm (p. 176) is triggered a siren sounds and all direction indicators flash.

- A siren sounds for 30 seconds or until the alarm is switched off. The siren has its own battery and works independently of the car battery.
- The direction indicators flash for 5 minutes or until the alarm is switched off.

### Reduced alarm level

Reduced guard means that the movement and tilt detectors can be temporarily deactivated.

To avoid accidental triggering of the alarm (p. 176) - e.g. if a dog is left in a locked car or during transport on a car train or car ferry - temporarily deactivate the movement and tilt detectors.

The procedure is the same as with the temporary disengaging of deadlocks (p. 174)<sup>8</sup>.

### Related information

- Alarm indicator (p. 177)





## Type approval - remote control key system



Type approval for the remote control key system can be read in the table.

### Lock system, standard

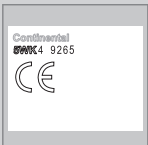
Country/Area	
EU, China	 <p>Continental            FCC ID: K956WTKAR284            IC:2871-SWK48284            @ CCA888LP186074            CET2177C20080R            TRC/LPD/200822 CE            CHN ID:20080J1134            Complies with IDA            Standards DB01783            TA-2008F10            RCM/01786-248            Made in Cz</p>

### Keyless lock system (Keyless drive)

Country/Area	
EU	 <p>Continental            SWK4 9265            CE</p>
Korea	 <p>Continental            SIE-SWK 49268            Made in Cz            K</p>

Country/Area	
China	 <p>Continental            SWK4 9265            CET2177C20080R            TRC/LPD/200822            CHN ID:20080J1121            Complies with IDA            Standards DB01783            TA-2008F10            Made in Cz</p>
Hong Kong	 <p>Continental            SWK4 9265</p>

### Related information

- Remote control key (p. 155)

07



DRIVER SUPPORT

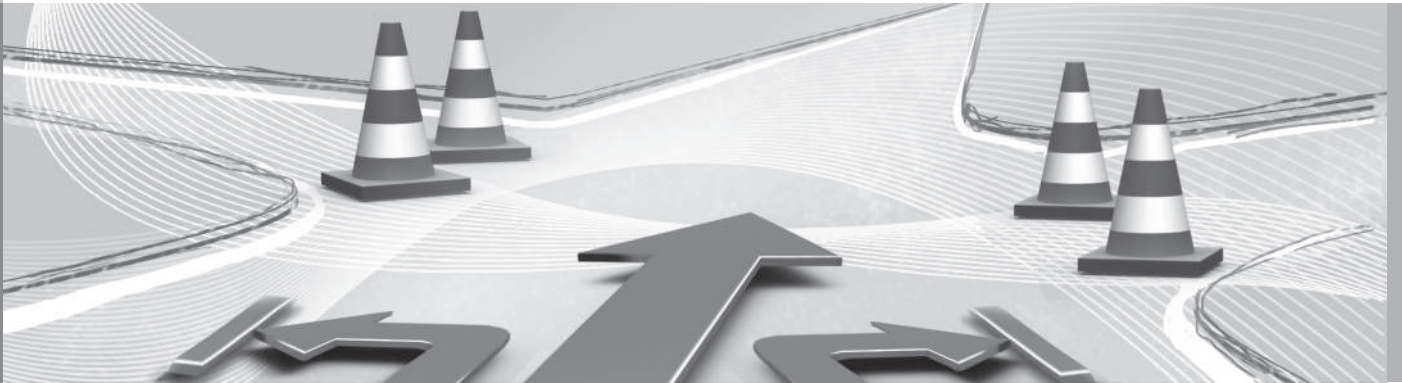



## Active chassis - Four C\*

Active chassis "Four-C" (Continuously Controlled Chassis Concept), regulates the characteristics of the shock absorbers so that the car's driving characteristics can be adjusted. There are three settings: **Comfort**, **Sport** and **Advanced**.

### Comfort

This setting means that the car is perceived as being more comfortable on rough and uneven road surfaces. Shock absorption is soft and the movement of the body is smooth and gentle.

### Sport

This setting means that the car is perceived as being more sporty and is recommended for more active driving. Steering response is faster than in the Comfort mode. Shock absorption is harder and the body follows the road in order to reduce rolling during cornering.

### Advanced

This setting is only recommended on very even and smooth road surfaces.

The shock absorbers are optimised for maximum roadholding and rolling in bends is further minimised.

## Operation



Control buttons.

The required chassis setting is selected using the centre console buttons. The setting used when the engine was switched off is re-activated when the engine is next started. The exception is Advanced - it is restarted as Sport.

## Electronic stability control (ESC) - general

Stability system ESC (Electronic Stability Control) helps the driver to avoid skidding and improves the car's traction.



The activation of the ESC system during braking may be noticed as a throbbing sound. The car may accelerate slower than expected when the accelerator pedal is depressed.



### WARNING

The stability system ESC is supplementary assistance - it cannot handle all situations in all road conditions.

The driver always bears responsibility that the vehicle is driven safely and that applicable road traffic rules and regulations are followed.

The ESC system consists of the following functions:

- Active Yaw Control
- Spin Control
- Traction control system

### Active Yaw Control

The function checks the driving and brake force of the wheels individually in order to stabilise the car.



### Spin Control

The function prevents the driving wheels from spinning against the road surface during acceleration.

### Traction control system

The function is active at low speed and transfers power from the driving wheel that is spinning to the one that is not.

### Related information

- Electronic stability control (ESC) - operation (p. 182)
- Electronic stability control (ESC) - symbols and messages (p. 183)

### Electronic stability control (ESC) - operation

#### Selection of level - Sport mode

The ESC system is always activated - it cannot be deactivated.



However, the driver can select the **Sport** mode, which allows for a more active driving experience.

**Sport** mode is selected in the menu system MY CAR.

For a description of the menu system, see MY CAR (p. 108).

In **Sport** mode the system detects whether the accelerator pedal, steering wheel movements and cornering are more active than in normal driving and then allows controlled skidding with the rear section up to a certain level before it intervenes and stabilises the car.

If, for example, the driver stops a controlled skid by releasing the accelerator pedal, then the ESC system intervenes and stabilises the car.

With **Sport** mode, maximum traction is also obtained if the car has become stuck, or when driving on a loose surface - e.g. sand or deep snow.



**Sport** mode is indicated in the combined instrument panel by means of this symbol illuminating with a constant glow until the driver deselects the function or until the engine is switched off - after the next time the engine is started the ESC system is back in its normal mode again.

### Related information

- Electronic stability control (ESC) - general (p. 181)
- Electronic stability control (ESC) - symbols and messages (p. 183)





## Electronic stability control (ESC) - symbols and messages

Table

Symbol	Message	Specification
	ESC Temporarily OFF	ESC system has been temporarily reduced due to excessive brake disc temperature - the function is reactivated automatically when the brakes have cooled.
	ESC Service required	<p>ESC system disengaged.</p> <ul style="list-style-type: none"> <li>• Stop the car in a safe place, switch off the engine and start it again.</li> <li>• Visit a workshop if the message remains - an authorised Volvo workshop is recommended.</li> </ul>
 and 	"Message"	There is a text message in the combined instrument panel (p. 59) - Read it!
	Constant glow for 2 seconds.	System check when the engine is started.
	Flashing light.	ESC system is being activated.
	Constant glow.	<p><b>Sport</b> mode is activated.</p> <p><b>NOTE:</b> The ESC system is not deactivated in this mode - it is partially reduced.</p>



### Related information

- Electronic stability control (ESC) - general (p. 181)
- Electronic stability control (ESC) - operation (p. 182)



## Road Sign Information (RSI)\*

The road sign information function (RSI – Road Sign Information) helps the driver to remember which speed-related road signs the car has passed.

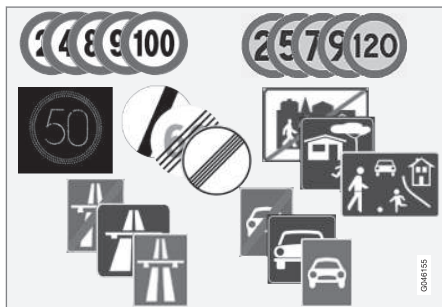

Examples of readable speed related signs<sup>1</sup>.

The RSI function gives information on current speed, e.g. that a motorway or road is starting/ending and when overtaking is prohibited.

If both a sign for motorway/road for motorised traffic and a sign showing the maximum permitted speed are passed, RSI decides to show the sign symbol for maximum permitted speed.

## WARNING

RSI does not work in all situations but is designed merely as a supplementary aid.

The driver always bears ultimate responsibility for ensuring that the vehicle is driven safely and that applicable road traffic rules and regulations are followed.

### Related information

- Road sign information (RSI)\* - operation (p. 185)
- Road sign information (RSI)\* - limitations (p. 187)

## Road sign information (RSI)\* - operation

The road sign information function (RSI – Road Sign Information) helps the driver to remember which speed-related road signs the car has passed.

The function is operated as follows:

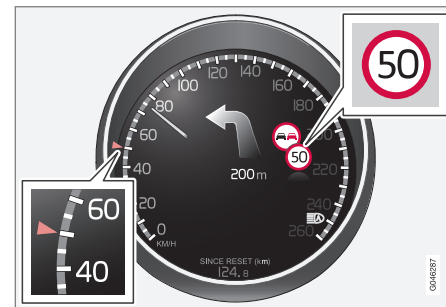

Recorded speed information<sup>2</sup>.

When RSI has recorded a road sign with an imposed speed, the combined instrument panel displays the sign as a symbol.

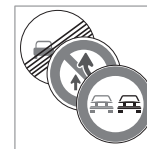

Together with the symbol for the current speed limit, a sign showing that overtaking is prohibited may also be displayed where appropriate.

<sup>1</sup> Road signs shown in the combined instrument panel are market-dependent - the illustrations in these instructions only show a few examples.

<sup>2</sup> Road signs shown in the combined instrument panel are market-dependent - the illustrations in these instructions only show a few examples.



# 07 Driver support



## End of restriction or motorway

A corresponding road sign is shown in the combined instrument panel for approx. 10 seconds in situations where RSI detects a sign that involves the end of a speed limit - or other speed-related information, e.g. end of a motorway.

Examples of such signs are:

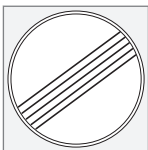

End of all restrictions.



End of motorway.

Following which, the sign information is hidden until the next speed-related sign is detected.

## Additional signs

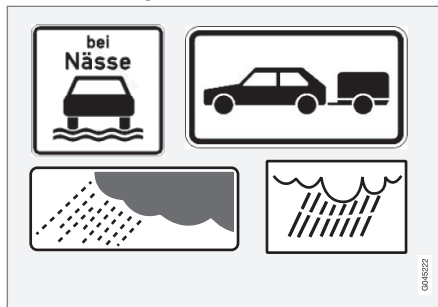

Examples of additional signs<sup>2</sup>.

Sometimes different speed limits are signposted for the same road - an additional sign then indicates the circumstances under which the different speeds apply. The road section may be particularly susceptible to accidents in rain and/or fog, for example.

An additional sign relating to rain is displayed only if the windscreen wipers are in use.

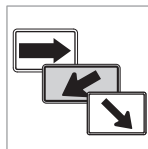

The speed applicable on an exit is indicated in certain markets by means of an additional sign containing an arrow.

Speed signs linked to this type of additional sign are displayed only if the driver is using the direction indicator.

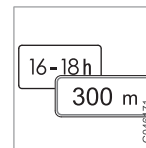

Some speeds are applicable only after e.g. a specific distance or at a certain time of day. The driver's attention is drawn to the situation by means of a symbol for an additional sign under the symbol showing speed.

## Display of additional information



A symbol for additional sign in the form of an empty frame under the combined instrument panel's speed symbol means that the RSI has detected an additional sign with supplementary information for the current speed limit.

## Setting in MY CAR

There are options for RSI in the **MY CAR** menu system; see MY CAR (p. 108).

<sup>2</sup> Road signs shown in the combined instrument panel are market-dependent - the illustrations in these instructions only show a few examples.



## Road sign information On/Off



The combined instrument panel's speed symbol display can be disabled. The function can be activated/deactivated in the menu system **MY CAR**. For a description of the menu system, see MY CAR (p. 108).

## Speed warning



The driver can opt to receive a warning when the applicable speed limit is exceeded by 5 km/h or more. This warning is given by the symbol showing the applicable maximum speed temporarily flashing when this speed is

exceeded. The function can be activated/deactivated in the menu system **MY CAR**. For a description of the menu system, see MY CAR (p. 108).

### Related information

- Road Sign Information (RSI)\* (p. 185)
- Road sign information (RSI)\* - limitations (p. 187)
- MY CAR (p. 108)

## Road sign information (RSI)\* - limitations

*The road sign information function (RSI – Road Sign Information) helps the driver to remember which speed-related road signs the car has passed. The function has the following limitations.*

The RSI function's camera sensor has limitations just like the human eye - read more about camera sensor limitations (p. 221)).

Signs which indirectly provide information on a prevailing speed limit, e.g. name signs for towns/districts, are not recorded by the RSI function.

Here are several examples of what can disrupt the function:

- Faded signs
- Signs positioned on bends
- Rotated or damaged signs
- Concealed or poorly positioned signs
- Signs completely or partly covered with frost, snow and/or dirt.

### Related information

- Road Sign Information (RSI)\* (p. 185)
- Road sign information (RSI)\* - operation (p. 185)



## Cruise control\*

The cruise control (CC – Cruise Control) helps the driver maintain an even speed, resulting in a more relaxed driving on motorways and long, straight roads in regular traffic flows.

### Overview

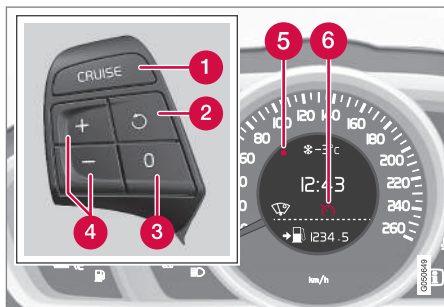

Steering wheel keypad and combined instrument panel.

- 1 Cruise control - On/Off.
- 2 Standby mode ceases and the stored speed is resumed.
- 3 Standby mode
- 4 Activate and adjust the speed.
- 5 Selected speed (GREY = Standby mode).
- 6 Cruise control active - WHITE symbol (GREY = Standby mode).

## WARNING

The driver must always be observant with regard to the traffic conditions and intervene when the cruise control is not maintaining a suitable speed and/or suitable distance.

The driver always bears ultimate responsibility for ensuring that the vehicle is driven safely.

### Related information



- Cruise control\* - managing speed (p. 188)
- Cruise control\* temporary deactivation and standby mode (p. 189)
- Cruise control\* - resume set speed (p. 190)
- Cruise control\* - deactivate (p. 190)
- Adaptive cruise control - ACC\* (p. 190)

## Cruise control\* - managing speed

It is possible to activate, set and change the stored speed.

### Activating and setting the speed



#### To enable cruise control:

- Press the steering wheel button for **CRUISE** (without speed limiter) or  (with speed limiter).
  - > The cruise control symbol (6) in the combined instrument panel illuminates - cruise control is in standby mode.
- #### To activate cruise control:
- At the required speed - press the steering wheel button  or .
  - > The current speed is stored in memory and the combined instrument panel's marking (5) illuminates at the selected speed and the symbol (6) changes from GREY to WHITE - the car then follows the stored speed.

## NOTE

Cruise Control cannot be enabled at speeds below 30 km/h.

### Changing the stored speed

Stored speed is changed with short or long presses on the  or  button.

To adjust +/- 5 km/h:



- Use short presses - each press gives +/- 5 km/h.

To adjust +/- 1 km/h:

- Hold the button depressed and release when the combined instrument panel's mark is by the desired speed.

Last press made is stored in the memory.

If speed is increased using the accelerator pedal prior to pressing the  button, then it is the car's current speed when the button is pressed that is stored.

A temporary increase in speed with the accelerator pedal, e.g. during overtaking, does not affect the setting - the car returns to the last stored speed when the accelerator pedal is released.

#### NOTE

If any of the Cruise Control buttons are held depressed for several minutes then it is blocked and deactivated. To be able to reactivate Cruise Control, the car must be stopped and the engine restarted.

#### Related information

- Cruise control\* (p. 188)

### Cruise control\* temporary deactivation and standby mode

*The function can be temporarily deactivated and set in standby mode.*

#### Temporary deactivation - standby mode

To temporarily disengage cruise control and set it in standby mode:

- Press the steering wheel button .
- > The combined instrument panel's marking (5) and symbol (6) change colour from WHITE to GREY - cruise control is temporarily disengaged.

#### Standby mode due to driver intervention

Cruise control is temporarily disengaged and automatically set in standby mode if:

- the foot brake is used
- the clutch pedal is depressed
- the gear lever-selector is moved to **N** position
- the driver maintains speed higher than the stored speed for longer than 1 minute.

The driver must then regulate the speed.

A temporary increase in speed with the accelerator pedal, e.g. during overtaking, does not affect the setting - the car returns to the last stored speed when the accelerator pedal is released.

### Automatic standby mode

Cruise control is temporarily disengaged and set in standby mode if:

- wheels lose traction
- engine speed is too low/high
- speed falls below approx. 30 km/h.

The driver must then regulate the speed.

#### Related information

- Cruise control\* (p. 188)
- Cruise control\* - managing speed (p. 188)
- Cruise control\* - resume set speed (p. 190)
- Cruise control\* - deactivate (p. 190)



### Cruise control\* - resume set speed

The cruise control (CC – Cruise Control) helps the driver to maintain an even speed.

After temporary deactivation and standby mode (p. 189) it is possible to resume the set speed.

To reactivate the cruise control from standby mode:

- Press the steering wheel button .
- > The combined instrument panel's marking (5) and symbol (6) change colour from GREY to WHITE - the car then follows the last stored speed.

#### NOTE

A marked speed increase may occur once the speed has been resumed by selecting



### Related information

- Cruise control\* (p. 188)
- Cruise control\* - managing speed (p. 188)
- Cruise control\* temporary deactivation and standby mode (p. 189)
- Cruise control\* - deactivate (p. 190)

### Cruise control\* - deactivate

How it is deactivated is described here.

Cruise control is switched off with the steering wheel button (1) or by switching off the engine - the set/stored speed is thus cleared and cannot then be resumed with the  button.

### Related information

- Cruise control\* (p. 188)
- Cruise control\* - managing speed (p. 188)
- Cruise control\* temporary deactivation and standby mode (p. 189)
- Cruise control\* - resume set speed (p. 190)

### Adaptive cruise control - ACC\*

The adaptive cruise control (ACC – Adaptive Cruise Control) helps the driver to maintain an even speed combined with a pre-selected time interval to the vehicle ahead.

The adaptive cruise control provides a more relaxing driving experience on long journeys on motorways and long straight main roads in smooth traffic flows.

The driver sets the desired speed (p. 194) and time interval (p. 195) to the car in front. When the radar detector detects a slower vehicle in front of the car, the speed is automatically adapted to that. When the road is clear again the car returns to the selected speed.

If the adaptive cruise control is switched off or set to standby mode (p. 195) and the car comes too close to a vehicle in front, then the driver is warned instead by the Distance Warning (p. 205) function about the short distance.



**! WARNING**

The driver must always be observant with regard to the traffic conditions and intervene when the adaptive cruise control is not maintaining a suitable speed or suitable distance.

The adaptive cruise control cannot handle all traffic, weather and road conditions.

Read all the sections about the adaptive cruise control in the owner's manual in order to learn about its limitations, of which the driver should be aware before it is used.

The driver always bears responsibility for maintaining the correct distance and speed, even when the adaptive cruise control is being used.

**! IMPORTANT**

Maintenance of adaptive cruise control components must only be performed at a workshop - an authorised Volvo workshop is recommended.

**Automatic gearbox**

Cars with automatic gearbox have enhanced functionality with the adaptive cruise control's Queue assistance (p. 197) function.

**Related information**

- Adaptive cruise control\* - function (p. 191)
- Adaptive cruise control\* - overview (p. 193)
- Adaptive cruise control\* - managing speed (p. 194)
- Adaptive cruise control\* - set time interval (p. 195)
- Adaptive cruise control\* - temporary deactivation, and standby mode (p. 195)
- Adaptive cruise control\* - overtaking another vehicle (p. 196)
- Adaptive cruise control\* - deactivate (p. 197)
- Adaptive Cruise Control\* - queue assistance (p. 197)
- Adaptive cruise control\* - switch cruise control functionality (p. 199)
- Radar sensor (p. 199)
- Radar sensor - limitations (p. 200)
- Adaptive cruise control\* - fault tracing and action (p. 202)
- Adaptive cruise control\* - symbols and messages (p. 203)

**Adaptive cruise control\* - function**

It consists of a cruise control system and a coordinated spacing system.

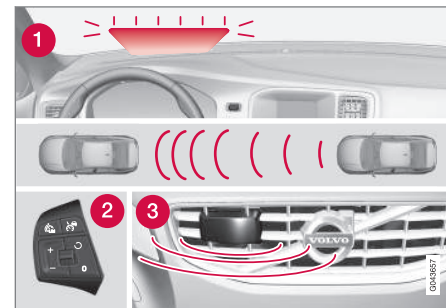
**Function overview**

Function overview<sup>3</sup>.

- 1 Warning lamp - braking by driver required
- 2 Steering wheel keypad (p. 193)
- 3 Radar sensor (p. 199)

<sup>3</sup> NOTE: The illustration is schematic - details may differ depending on car model.



## 07 Driver support



### WARNING

Adaptive cruise control is not a collision avoidance system. The driver must intervene if the system does not detect a vehicle in front.

The adaptive cruise control does not brake for humans or animals, and not for small vehicles such as bicycles and motorcycles. Nor for oncoming, slow or stationary vehicles and objects.

Do not use the adaptive cruise control, for example, in city traffic, in dense traffic, at junctions, on slippery surfaces, with a lot of water or slush on the road, in heavy rain/snow, in poor visibility, on winding roads or on slip roads.

The distance to the vehicle ahead (p. 195) is primarily measured by a radar sensor (p. 199). The cruise control function regulates the speed with acceleration and braking. It is normal for the brakes to emit a low sound when they are being used by the adaptive cruise control.

### WARNING

The brake pedal moves when the adaptive cruise control brakes. Do not rest your foot beneath the brake pedal - it may then become trapped.

The adaptive cruise control aims to follow the vehicle ahead in the same lane according to what the driver set for time interval (p. 195). If the radar sensor cannot see any vehicle in front then the car will instead maintain the speed set and stored by the driver. This also takes place if the speed of the vehicle in front exceeds the stored speed.

The adaptive cruise control aims to control the speed in a smooth way. In situations that demand sudden braking the driver must brake himself/herself. This applies with large differences in speed, or if the vehicle in front brakes heavily. Due to limitations in the radar sensor (p. 200) braking may come unexpectedly or not at all.

The adaptive cruise control can be activated to follow another vehicle at speeds from 30 km/h<sup>4</sup> up to 200 km/h. If the speed falls below 30 km/h or if the engine speed becomes too low, the cruise control is set in standby mode (p. 195) at which automatic braking ceases - the driver must then take over himself/herself to maintain a safe distance to the vehicle ahead.

### Warning lamp - braking by driver required

Adaptive cruise control has a braking capacity that is equivalent to more than 40% of the car's braking capacity.

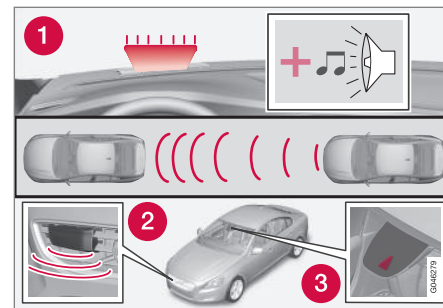

1. Collision warning system warning lamp and warning sound<sup>5</sup>.

If the car needs to be braked more heavily than the adaptive cruise control capacity and the driver does not brake, then the warning lamp and warning sound from the Collision warning system (p. 215) are used in order to alert the driver that immediate intervention is required.

### NOTE

The warning lamp may be difficult to see in strong sunlight or when wearing sunglasses.

<sup>4</sup> Queue Assist (p. 197) (in cars with automatic gearbox) can operate in the range of 0-200 km/h.

<sup>5</sup> NOTE: The illustration is schematic - details may vary depending on car model.



## WARNING

The adaptive cruise control only warns of vehicles which the radar sensor has detected. Hence the warning may not be given, or it may be given with a certain delay. Do not wait for a warning without braking when so required.

### Steep roads and/or heavy load

Bear in mind that the adaptive cruise control is primarily intended for use when driving on level road surfaces. It may have difficulty in keeping the correct distance from the vehicle ahead when driving on steep downhill slopes, with a heavy load or with a trailer - in which case, be extra attentive and ready to slow down.

### Related information

- Adaptive cruise control - ACC\* (p. 190)
- Adaptive cruise control\* - deactivate (p. 197)
- Adaptive cruise control\* - overtaking another vehicle (p. 196)

### Adaptive cruise control\* - overview

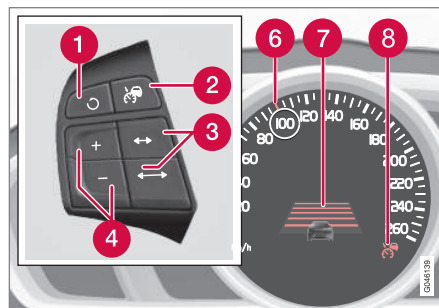

- 1 Standby mode ceases and the stored speed is resumed.
- 2 Cruise control - On/Off or Standby mode.
- 3 Time interval - Increase/decrease.
- 4 Activate and adjust the speed.
- 5 (Not used)
- 6 Green marking at stored speed (WHITE = standby mode).
- 7 Time distance
- 8 ACC is active at the GREEN symbol (WHITE = standby mode).

### Related information

- Adaptive cruise control - ACC\* (p. 190)
- Adaptive cruise control\* - function (p. 191)

- Adaptive cruise control\* - symbols and messages (p. 203)





## Adaptive cruise control\* - managing speed

### To enable ACC:

- Press the steering wheel button  - a similar WHITE symbol illuminates in the combined instrument panel (8) which shows that the adaptive cruise control is in standby mode (p. 195).

### To activate ACC:

- At the required speed - press the steering wheel button  or .
- > The current speed is stored in the memory, the combined instrument panel shows a "magnifying glass" (6) around the stored speed for a second or so and its marking changes from WHITE to GREEN.



When this symbol changes colour from WHITE to GREEN, the ACC is active and the car maintains the stored speed.





Only when the symbol shows an image of another vehicle is the **distance** to the vehicle in front controlled by the ACC.



At the same time a speed range is marked:

- the higher speed with GREEN marking is the pre-programmed speed
- the lower speed is the speed of the vehicle in front.

### Changing the stored speed

Stored speed is changed with short or long presses on the  or  button.

To adjust +/- 5 km/h:

- Use short presses - each press gives +/- 5 km/h.

To adjust +/- 1 km/h:

- Hold the button depressed and release when the combined instrument panel's mark is by the desired speed.

Last press made is stored in the memory.

If speed is increased using the accelerator pedal prior to pressing the  button, then it is the car's current speed when the button is pressed that is stored.

A temporary increase in speed with the accelerator pedal, e.g. during overtaking, does not affect the setting - the car returns to the last

stored speed when the accelerator pedal is released.



### NOTE

If any of the adaptive cruise control buttons are held depressed for several minutes then the function is blocked and deactivated. To be able to reactivate it, the car must be stopped and the engine restarted.

In certain situations it cannot be reactivated - in which case, the combined instrument panel (p. 203) shows **Adaptive cruise control unavailable**.

### Related information

- Adaptive cruise control - ACC\* (p. 190)
- Adaptive cruise control\* - overview (p. 193)
- Adaptive cruise control\* - function (p. 191)



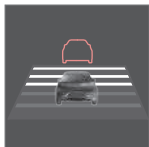

### Adaptive cruise control\* - set time interval



Different time intervals to the vehicle in front can be selected and shown in the combined instrument panel as 1-5 horizontal lines - the more lines the longer the time interval. One line corre-

sponds to approximately 1 second to the vehicle in front, 5 lines approximately 3 seconds.

To set/change the time distance:

- Increase or decrease with the steering wheel buttons  .

At low speed, when the distances are short, the adaptive cruise control increases the time interval slightly.

The adaptive cruise control allows the time interval to vary noticeably in certain situations in order to allow the car to follow the vehicle in front smoothly and comfortably.

Note that a short time interval only allows the driver a short time to react and take action if any unforeseen traffic problem should arise.

The same symbol is also shown when Distance Warning (p. 205) function is activated.

### NOTE

Only use the time intervals permitted by local traffic regulations.

If the adaptive cruise control does not appear to react when activated, this may be because the time distance to the vehicle in front is preventing an increase in speed.

The higher the speed the longer the calculated distance in metres for a given time interval.

Read more how speed is handled (p. 194).

### Related information

- Adaptive cruise control - ACC\* (p. 190)
- Adaptive cruise control\* - overview (p. 193)
- Adaptive cruise control\* - function (p. 191)
- Adaptive cruise control\* - deactivate (p. 197)

### Adaptive cruise control\* - temporary deactivation, and standby mode

*The adaptive cruise control can be temporarily deactivated and set in standby mode.*

### Temporary deactivation/standby mode

To temporarily disengage the adaptive cruise control and set it in standby mode:

- Press the steering wheel button 



This symbol and the stored speed's marking then change colour from GREEN to WHITE.

### Standby mode due to driver intervention

The adaptive cruise control is temporarily disengaged and set automatically in standby mode if:

- the foot brake is used
- the clutch pedal is depressed for longer than 1 minute<sup>6</sup>
- the gear selector is moved to **N** position (automatic gearbox)
- the driver maintains speed higher than the stored speed for longer than 1 minute.

The driver must then regulate the speed.

A temporary increase in speed with the accelerator pedal, e.g. during overtaking, does not affect the setting - the car returns to the last

<sup>6</sup> Disengaging and selecting a higher or lower gear does not involve standby mode.



## 07 Driver support



stored speed when the accelerator pedal is released.

### Automatic standby mode

The adaptive cruise control is dependent on other systems, e.g. Stability system ESC (p. 181). If any of these systems stops working, the adaptive cruise control is deactivated automatically.

In the event of automatic deactivation a signal will sound and the message **Adaptive cruise control cancelled** is shown in the combined instrument panel. The driver must then intervene and adapt the speed and distance to the vehicle ahead.

An automatic deactivation can be due to:

- the driver opens the door
- the driver takes off his seatbelt
- engine speed is too low/high
- speed has fallen below 30 km/h<sup>7</sup>
- wheels lose traction
- brake temperature is high
- the radar sensor is covered e.g. by wet snow or heavy rain (radar waves blocked).

### Resume set speed

Adaptive cruise control in standby mode is reactivated with one press on the steering

wheel button  - the speed is then set to the last stored speed.

### NOTE

A marked speed increase may occur once the speed has been resumed by selecting .

### Related information

- Adaptive cruise control - ACC\* (p. 190)
- Adaptive cruise control\* - overview (p. 193)
- Cruise control\* (p. 188)

### Adaptive cruise control\* - overtaking another vehicle

When the car is following another vehicle and the driver indicates an impending overtaking manoeuvre with the direction indicator<sup>8</sup>, the adaptive cruise control helps to briefly accelerate the car towards the vehicle in front.

This function is active at speeds above 70 km/h.

### WARNING

Be aware that this function can be activated in more situations other than during overtaking, e.g. when a direction indicator is used to indicate a change of lane or exit to another road - the car will then accelerate briefly.

### Related information



- Adaptive cruise control - ACC\* (p. 190)
- Adaptive cruise control\* - overview (p. 193)
- Adaptive cruise control\* - function (p. 191)

<sup>7</sup> Does not apply to a car with Queue Assist - it can go all the way down to 0 km/h.

<sup>8</sup> On left flash only in left-hand-drive car, or right flash in right-hand-drive car.



### Adaptive cruise control\* - deactivate

With a short press on the steering wheel button  the adaptive cruise control is set in standby mode (p. 195). It is switched off with an additional short press - the set/stored speed is thus cleared and cannot then be resumed with the  button.

#### Related information

- Adaptive cruise control - ACC\* (p. 190)
- Adaptive cruise control\* - function (p. 191)
- Adaptive cruise control\* - symbols and messages (p. 203)

### Adaptive Cruise Control\* - queue assistance

*Queue assistance also provides the adaptive cruise control with enhanced functionality at speeds below 30 km/h.*

In cars with automatic gearbox the adaptive cruise control is supplemented with the queue assistance function (also referred to as "Queue Assist").

Queue assistance has the following functions:

- Extended speed range - also below 30 km/h and when stationary
- Change of target
- Automatic braking ceases when stationary
- Automatic activation parking brake.

Note that the lowest programmable speed for the adaptive cruise control is 30 km/h - even though it is capable of following another vehicle down to a standstill, a speed lower than 30 km/h **cannot** be selected/stored.

#### Extended speed range

#### NOTE

In order to activate the adaptive cruise control, the driver's door must be closed and the driver must be wearing the seat-belt.

With an automatic gearbox, the adaptive cruise control can follow another vehicle within the range 0-200 km/h.

#### NOTE

A vehicle in front must be within a reasonable distance in order to enable activation of the adaptive cruise control at a speed lower than 30 km/h.

For shorter stops in connection with inching in slow traffic or at traffic lights driving is automatically resumed if the stops do not exceed about 3 seconds - if it takes longer before the car in front starts moving again then the Adaptive cruise control is set in standby mode with automatic braking. The driver must then reactivate it in one of the following ways:

- Press the steering wheel button .
- or
- Depress the accelerator pedal.
- > The adaptive cruise control will then resume following the vehicle in front.



## NOTE

Queue Assist can hold the car stationary for a maximum of 4 minutes - then the parking brake is applied and the adaptive cruise control is disengaged.

- The parking brake must be released before the adaptive cruise control can be reactivated.

## Change of target

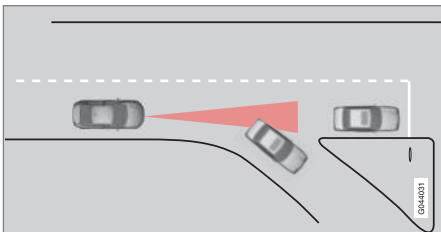

*If the target vehicle in front suddenly turns then there may be stationary traffic in front.*

When the adaptive cruise control is following another vehicle at speeds **below** 30 km/h and changes target from a moving to a stationary vehicle, the adaptive cruise control will slow down for the stationary vehicle.

## WARNING

When the adaptive cruise control is following another vehicle at speeds **in excess of** 30 km/h and the target is changed from a moving vehicle to a stationary vehicle, the adaptive cruise control will ignore the stationary vehicle and instead select the stored speed.

- The driver must intervene him/herself and brake.

## Automatic standby mode with change of target

The adaptive cruise control is disengaged and set in standby mode:

- when the speed is below 5 km/h and the adaptive cruise control is uncertain whether the target object is a stationary vehicle or some other object, e.g. a speed bump.
- when the speed is below 5 km/h and the vehicle in front turns off so the adaptive cruise control no longer has a vehicle to follow.

## Termination of automatic braking at a standstill

In certain situations, queue assistance stops automatic braking at a standstill. This means that the brakes are released and the car may start to roll - the driver must therefore intervene and brake the car himself/herself in order to maintain its position.

Queue assistance releases the foot brake and sets the adaptive cruise control in standby mode in the following situations:

- the driver puts his/her foot on the brake pedal
- the parking brake is applied
- the gear selector is moved to **P**, **N** or **R** position
- the driver sets the adaptive cruise control in standby mode.

## Automatic activation parking brake

In certain situations queue assistance applies the parking brake in order to keep the car remaining stationary.

This takes place if:

- the driver opens the door or takes off his/her seatbelt
- ESC is changed from **Normal** to **Sport** mode
- Queue assistance has held the car stationary for more than 4 minutes
- the engine is switched off
- the brakes have overheated.

## Related information

- Adaptive cruise control - ACC\* (p. 190)
- Adaptive cruise control\* - overview (p. 193)
- Adaptive cruise control\* - function (p. 191)





## Adaptive cruise control\* - switch cruise control functionality

### Changing from ACC to CC

A symbol for active cruise control is shown in the combined instrument panel:

CC Cruise Control	ACC Adaptive Cruise Control
Cruise control	Adaptive cruise control

With one press of the button the adaptive part (spacing system) in the cruise control is deactivated, at which point the car just follows the set/stored speed.

- Give a **long** press on the steering wheel button - the combined instrument panel's symbol changes from to .
- > By these means the standard cruise control (p. 188) CC (Cruise Control) is activated.

### WARNING

The car no longer brakes automatically after switching from ACC to CC - it merely follows the set speed.

### Changing back from CC to ACC

Switch off cruise control with 1-2 presses on the button in accordance with the deactivation instructions (p. 197). The next time the system is switched on it is the Adaptive cruise control that is activated.

### Related information

- Adaptive cruise control - ACC\* (p. 190)
- Adaptive cruise control\* - overview (p. 193)
- Adaptive cruise control\* - function (p. 191)

### Radar sensor

*The function of the radar sensor is to detect cars or larger vehicles in the same direction, in the same lane.*

The radar sensor is used by the following functions:

- Distance Warning\*
- Adaptive cruise control\*
- Collision Warning with Auto Brake and Pedestrian Detection\*

### IMPORTANT

In the event of visible damage to the car's grille, or if you suspect that the radar sensor may be damaged:

- Contact a workshop - an authorised Volvo workshop is recommended.

The function may completely or partially disappear - or malfunction - if the grille, the radar sensor or its bracket is damaged or has loosened.

Modification of the radar sensor could result in it being illegal to use.

### Related information

- Radar sensor - limitations (p. 200)
- Adaptive cruise control - ACC\* (p. 190)
- Collision warning system\* (p. 215)
- Distance Warning\* (p. 205)



## 07 Driver support

### Radar sensor - limitations

A radar sensor (p. 199) has certain limitations - due to its limited field of vision for example.

The capacity of the adaptive cruise control to detect a vehicle in front is significantly reduced if:

- the speed of vehicles in front is significantly different from your own speed
- its radar sensor becomes blocked - e.g. in heavy rain or slush, or if other objects have collected in front of the radar sensor.



#### NOTE

Keep the area in front of the radar sensor clean - see subheading "Maintenance" (p. 219).

### Field of vision

The radar sensor has a limited field of vision. In some situations another vehicle is not detected, or the detection is made later than expected.

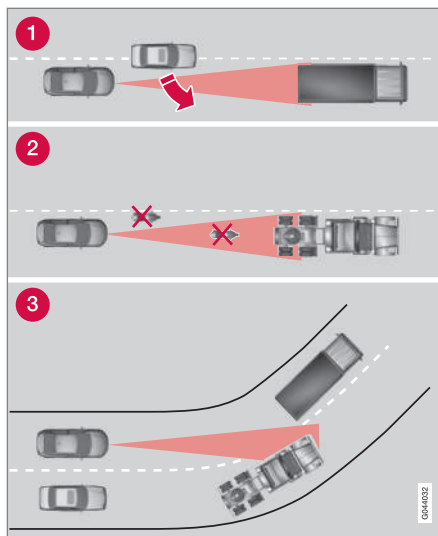

ACC field of vision.

- 1 Sometimes the radar sensor is late at detecting vehicles at close distances - e.g. a vehicle that drives in between the car and vehicles in front.
- 2 Small vehicles, such as motorcycles, or vehicles not driving in the centre of the lane can remain undetected.
- 3 In bends the radar sensor may detect the wrong vehicle or lose a detected vehicle from view.



#### WARNING

The driver must always be observant with regard to the traffic conditions and intervene when the adaptive cruise control is not maintaining a suitable speed or suitable distance.

The adaptive cruise control cannot handle all traffic, weather and road conditions.

Read all the sections about the adaptive cruise control in the owner's manual in order to learn about its limitations, of which the driver should be aware before it is used.

The driver always bears responsibility for maintaining the correct distance and speed, even when the adaptive cruise control is being used.



#### WARNING

Accessories or other objects such as auxiliary lamps must not be fitted in front of the grille.

**! WARNING**

Adaptive cruise control is not a collision avoidance system. The driver must intervene if the system does not detect a vehicle in front.

The adaptive cruise control does not brake for humans or animals, and not for small vehicles such as bicycles and motorcycles. Nor for oncoming, slow or stationary vehicles and objects.

Do not use the adaptive cruise control, for example, in city traffic, in dense traffic, at junctions, on slippery surfaces, with a lot of water or slush on the road, in heavy rain/snow, in poor visibility, on winding roads or on slip roads.

**Related information**

- Adaptive cruise control - ACC\* (p. 190)
- Collision warning system\* (p. 215)
- Distance Warning\* (p. 205)



## 07 Driver support

### Adaptive cruise control\* - fault tracing and action

If the combined instrument panel shows the message **Radar blocked** See manual then it means that the adaptive cruise control's radar

sensor (p. 199) cannot detect other vehicles in front of the car.

This message indicates that neither of the functions for Distance Alert (p. 205) or Colli-

sion Warning with Auto Brake (p. 215) are working.

The following table presents examples of possible causes for a message being shown along with the appropriate action:

Cause	Action
The radar surface in the grille is dirty or covered with ice or snow.	Clean the radar surface in the grille from dirt, ice and snow.
Heavy rain or snow blocking the radar signals.	No action. Sometimes the radar does not work during heavy rain or snowfall.
Water or snow from the road surface swirls up and blocks the radar signals.	No action. Sometimes the radar does not work on a very wet or snowy road surface.
The radar surface has been cleaned but the message remains.	Wait. It could take several minutes for the radar to sense that it is no longer blocked.

### Related information





- Adaptive cruise control\* - overview (p. 193)
- Adaptive cruise control\* - function (p. 191)
- Adaptive cruise control\* - symbols and messages (p. 203)



## Adaptive cruise control\* - symbols and messages

Sometimes the adaptive cruise control may display a symbol and/or text message. Here

are some examples - follow the recommendation given if appropriate:

Symbol	Message	Specification
	The symbol is GREEN	The car maintains the stored speed.
	The symbol is WHITE	Adaptive cruise control is set to standby mode.
		Standard cruise control is selected manually.
	<b>Set ESC to Normal to enable Cruise</b>	The adaptive cruise control cannot be activated until the Stability system (ESC) (p. 181) has been set in Normal mode.
	<b>Adaptive cruise control cancelled</b>	The adaptive cruise control has been deactivated - the driver has to regulate the speed himself.
	<b>Adaptive cruise control unavailable</b>	The adaptive cruise control cannot be activated. This could be due to: <ul style="list-style-type: none"> <li>• brake temperature is high</li> <li>• the radar sensor is blocked by e.g. wet snow or rain.</li> </ul>
	<b>Radar blocked See manual</b>	The adaptive cruise control is temporarily disengaged. <ul style="list-style-type: none"> <li>• The radar sensor is blocked and cannot detect other vehicles. For example, in the event of heavy rain or if slush has collected in front of the radar sensor.</li> </ul> The driver can then choose to switch to (p. 199) normal Cruise control (CC) - a text message provides information on appropriate alternatives. Read about radar sensor limitations (p. 200).



Symbol	Message	Specification
	<b>Adaptive cruise control Service required</b>	The adaptive cruise control is disengaged. <ul style="list-style-type: none"><li>Contact a workshop - an authorised Volvo workshop is recommended.</li></ul>
	<b>Press brake to hold vehicle + acoustic alarm</b> (Only with Queue Assist)	The car is stationary and the cruise control will release the foot brake to allow the parking brake to take over and hold the car, but a fault in the parking brake means the car will shortly begin to roll. <ul style="list-style-type: none"><li>The driver must brake himself/herself. The message remains and the alarm sounds until the driver depresses the brake pedal or uses the accelerator pedal.</li></ul>
	<b>Below 30 km/h Lead vehicle required</b> (Only with Queue Assist)	Shown with attempts to activate the cruise control at speeds below 30 km/h without a vehicle in front within the activation distance (approx. 30 metres).

### Related information

- Adaptive cruise control - ACC\* (p. 190)
- Adaptive cruise control\* - overview (p. 193)
- Adaptive cruise control\* - function (p. 191)



## Distance Warning\*

Distance Warning (Distance Alert) is a function that informs the driver about the time interval to vehicles in front.

Distance Warning is active at speeds above 30 km/h and only reacts to vehicles driving in front of the car, in the same direction. No distance information is provided for oncoming, slow or stationary vehicles.

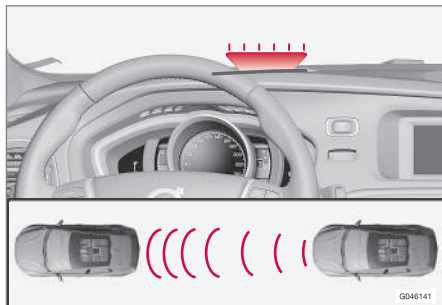

Orange-coloured warning lamp<sup>11</sup>.

An orange-coloured warning lamp in the windscreen illuminates with a constant glow if the distance to the vehicle in front is shorter than the set time interval.

### NOTE

Distance warning is deactivated during the time the adaptive cruise control is active.

### WARNING

Distance warning only reacts if the distance to the vehicle ahead is shorter than the preset value - the speed of the driver's vehicle is not affected.

### Operation

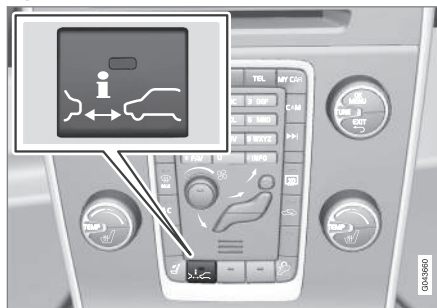

Press the button in the centre console to switch the function on or off. The function is switched on if one lamp is illuminated in the button.

Some combinations of the selected equipment leave no vacant space for a button in the centre console - in which case the func-

tion is handled by the car's menu system **MY CAR**, MY CAR (p. 108) - once there, search for the **Distance Alert** function..

### Set time interval

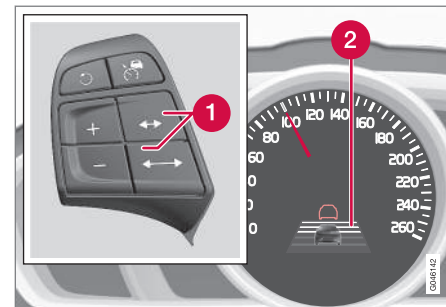

Controls and symbol for time interval.

- 1 Time interval - Increase/decrease.
- 2 Time interval - On.

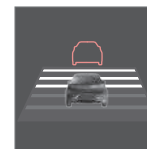

Different time intervals to the vehicle in front can be selected and shown in the combined instrument panel as 1-5 horizontal lines - the more lines the longer the time interval. One line corresponds to approximately 1 second to the vehicle in front, 5 lines approximately 3 seconds.

<sup>11</sup> NOTE: The illustration is schematic - details may vary depending on car model.



The same symbol is also shown when Adaptive cruise control (p. 191) is activated.

### NOTE

The higher the speed the longer the calculated distance in metres for a given time interval.

The set time interval is also used by the function adaptive cruise control (p. 191).

Only use the time intervals permitted by local traffic regulations.

### Related information

- Distance Warning\* - limitations (p. 206)

### Distance Warning\* - limitations

*Distance Warning (Distance Alert) is a function that informs the driver about the distance to vehicles in front. The function uses the same radar sensor as the Adaptive cruise control (p. 190) and Collision warning with auto brake (p. 215), has some limitations.*

### NOTE

Strong sunlight, reflections or strong variations in light intensity, as well as wearing sunglasses, could mean that the warning light in the windscreen cannot be seen.

Poor weather or winding roads could affect the radar sensor's capacity to detect vehicles in front.

The size of other vehicles could also affect detection capacity, e.g. motorcycles. This could mean that the warning lamp illuminates at a shorter distance than the setting or that the warning is temporarily absent.

Extremely high speeds can also cause the lamp to illuminate at a shorter distance than that set due to limitations in sensor range.

For further information on radar sensor limitations, see Radar sensor - limitations (p. 200) and (p. 220).

### Related information

- Distance Warning\* (p. 205)
- Distance Warning\* - symbols and messages (p. 207)







## Distance Warning\* - symbols and messages

Distance Warning (Distance Alert) is a function that informs the driver about the time interval

to vehicles in front. The function has certain limitations.

Symbol <sup>A</sup>	Message	Specification
	<b>Radar blocked See manual</b>	Distance Warning temporarily disengaged. The radar sensor is blocked and cannot detect other vehicles, e.g. in the event of heavy rain or if slush has collected in front of the radar sensor. Read about radar sensor limitations (p. 200).
	<b>Collision warning Service required</b>	Distance Warning and Collision Warning with Auto Brake fully or partially disengaged. Visit a workshop if the message remains - an authorised Volvo workshop is recommended.

<sup>A</sup> Symbols are schematic - may vary by market and car model.

### Related information

- Distance Warning\* (p. 205)
- Distance Warning\* - limitations (p. 206)



### City Safety™

*City Safety™ is a function for helping the driver to avoid a collision when driving in queues, amongst other things, when changes in the traffic ahead, combined with a lapse in attention, could lead to an incident.*

The City Safety™ function is active at speeds under 50 km/h and it helps the driver by automatically braking the car in the event of imminent risk of collision with vehicles in front, should the driver not react in time by braking and/or steering away.

City Safety™ is activated in situations where the driver should have started braking earlier, which is why it cannot help the driver in every situation.

City Safety™ is designed to be activated as late as possible in order to avoid unnecessary intervention.

City Safety™ must not be used as an excuse for the driver to change his/her driving style. If the driver solely relies on City Safety™ to do the braking, there will be a collision sooner or later.

The driver or passengers normally only notice City Safety™ if a situation arises where the car is extremely close to being in a collision.

If the car is also equipped with Collision Warning with Auto Brake (p. 215)\* these two systems complement each other.

### IMPORTANT

Maintenance and replacement of City Safety™ components must only be performed by a workshop - an authorised Volvo workshop is recommended.

### WARNING

City Safety™ does not engage in all driving situations or traffic, weather or road conditions.

City Safety™ does not react to vehicles driving in a different direction from the car, to small vehicles and motorcycles or to humans and animals.

City Safety™ can prevent collision at a speed difference of less than 15 km/h - at a higher speed difference, it is only possible to reduce collision speed. In order to obtain full brake function, the driver must depress the brake pedal.

Never wait for City Safety™ to engage. The driver always bears responsibility for maintaining the proper distance and speed.

### City Safety™ - function

*City Safety™ detects the traffic in front of the car with a laser sensor fitted in the top edge of the windscreen. If there is an imminent risk of collision, City Safety™ will automatically brake the car, which may be experienced as sudden braking.*

### Related information

- City Safety™ - limitations (p. 210)
- City Safety™ - function (p. 208)
- City Safety™ - operation (p. 209)
- City Safety™ - laser sensor (p. 212)
- City Safety™ - symbols and messages (p. 214)

\* Option/accessory, for more information, see Introduction.

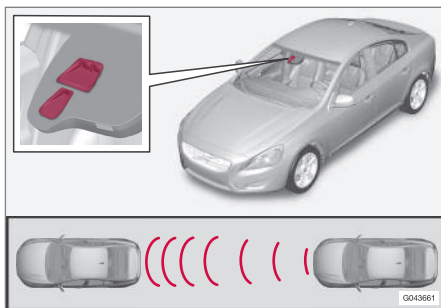

Laser sensor transmitter and receiver window<sup>12</sup>.

If the speed difference is 4-15 km/h in relation to the vehicle in front then City Safety™ can completely prevent a collision.

City Safety™ activates a short, sharp braking and stops the car in normal circumstances, just behind the vehicle in front. For most drivers this is well outside normal driving style and may be experienced as being uncomfortable.

If the difference in speed between the vehicles is greater than 15 km/h then City Safety™ may not prevent the collision on its own. To obtain full brake force, the driver must depress the brake pedal. This could then make it possible to prevent a collision, even at speed differences above 15 km/h.

When the function is activated and brakes, the combined instrument panel shows a text message to the effect that the function is/has been active.

#### NOTE

When City Safety™ brakes, the brake lights come on.

#### Related information

- City Safety™ - limitations (p. 210)
- City Safety™ (p. 208)
- City Safety™ - operation (p. 209)
- City Safety™ - laser sensor (p. 212)
- City Safety™ - symbols and messages (p. 214)

#### City Safety™ - operation

*City Safety™ is a function for helping the driver to avoid a collision when driving in queues, amongst other things, when changes in the traffic ahead, combined with a lapse in attention, could lead to an incident.*

#### On and Off

#### NOTE

The City Safety™ function is activated automatically when the engine is started.

In certain situations, it may be advisable to disable City Safety™, e.g. where leafy branches could sweep over the bonnet and/or windscreen.

City Safety™ handled in the menu system **MY CAR**, MY CAR (p. 108) and after starting the engine the function can be deactivated as follows:

- Search in **MY CAR** for **Driver support system** and select the **Off** option at **City Safety**.

However, the function will be enabled the next time the engine is started, regardless of whether the system was enabled or disabled when the engine was switched off.

<sup>12</sup> NOTE: The illustration is schematic - details may vary depending on car model.



### **WARNING**

The laser sensor also transmits laser light when City Safety™ is disabled manually.

#### **Related information**

- City Safety™ (p. 208)
- City Safety™ - limitations (p. 210)
- City Safety™ - function (p. 208)
- City Safety™ - laser sensor (p. 212)
- City Safety™ - symbols and messages (p. 214)
- MY CAR (p. 108)

### **City Safety™ - limitations**

*The sensor in City Safety™ is designed to detect cars and other large vehicles in front of the car irrespective of whether it is day or night.*

*However, the function does have some limitations.*

The sensor's limitations mean that City Safety™ has poorer functionality - or none at all - in e.g. heavy snowfall or rain, dense fog, dust storms or white-out situations. Misting, dirt, ice or snow on the windscreen may also disrupt the function.

Low-hanging objects, e.g. a flag/pennant for projecting load, or accessories such as auxiliary lamps and bull bars that are higher than the bonnet limit the function.

The laser beam from the sensor in City Safety™ measures how the light is reflected. The sensor cannot detect objects with low reflection capacity. The rear sections of the vehicle generally reflect the light sufficiently thanks to the number plate and rear light reflectors.

On slippery road surfaces the braking distance is extended, which may reduce the capacity of City Safety™ to avoid a collision. In such situations the ABS<sup>13</sup> and ESC<sup>14</sup> sys-

tems will provide best possible braking force with maintained stability.

When your own car is reversing, City Safety™ is temporarily deactivated.

City Safety™ is not activated at low speeds - under 4 km/h, which is why the system does not intervene in situations where a vehicle in front is being approached very slowly, e.g. when parking.

Driver commands are always prioritised, which is why City Safety™ does not intervene in situations where the driver is steering or accelerating in a clear manner, even if a collision is unavoidable.

When City Safety™ has prevented a collision with a stationary object the car remains stationary for a maximum of 1.5 seconds. If the car is braked for a vehicle in front that is moving, then speed is reduced to the same speed as that maintained by the vehicle in front.

On a car with manual gearbox the engine stops when City Safety™ has stopped the car, unless the driver manages to depress the clutch pedal beforehand.

<sup>13</sup> (Anti-lock Braking System) - Anti-lock braking system.

<sup>14</sup> (Electronic Stability Control) - Stability system.

**i NOTE**

- Keep the windscreen surface in front of the laser sensor free from ice, snow and dirt (see the illustration for sensor location (p. 208)).
- Do not affix or mount anything on the windscreen in front of the laser sensor.
- Remove ice and snow from the bonnet - snow and ice must not exceed a height of 5 cm.

**Fault tracing and action**

If the message **Windscreen sensors blocked** See manual is shown in the combined instrument panel it indicates that the laser sensor is blocked and cannot detect vehicles in front of the car. This means in turn that City Safety™ is not operational.

The **Windscreen sensors blocked** See manual message is not shown for all situations in which the laser sensor is blocked. The driver must therefore be diligent about keeping the windscreen and area in front of the laser sensor clean.

The following table presents possible causes for the message being shown, along with suggestions for appropriate action.

Cause	Action
The windscreen surface in front of the laser sensor is dirty or covered with ice or snow.	Clean the windscreen surface in front of the sensor from dirt, ice and snow.
The laser sensor field of vision is blocked.	Remove the blocking object.

**i IMPORTANT**

If there are cracks, scratches or stone chips in the windscreen in front of either of the laser sensor's "windows" and they cover a surface of approx. 0.5 x 3.0 mm (or larger), then a workshop must be contacted for replacement of the windscreen (see the illustration for sensor location (p. 208)) - an authorised Volvo workshop is recommended.

Failure to take action may result in reduced performance for City Safety™.

To avoid the risk of failed, deficient or reduced operation for City Safety™, the following also applies:

- Volvo recommends that you do **not** repair cracks, scratches or stone chips in the area in front of the laser sensor - instead, the whole windscreen should be replaced.
- Before replacing a windscreen, contact an authorised Volvo workshop to verify that the correct windscreen is ordered and fitted.
- The same type or Volvo-approved windscreen wipers must be fitted during replacement.

**Related information**

- City Safety™ (p. 208)
- City Safety™ - function (p. 208)
- City Safety™ - operation (p. 209)



## City Safety™ - laser sensor

The City Safety™ function includes a sensor which transmits laser light (see illustration (p. 208) for sensor location). Contact a qualified workshop in the event of a fault or if the laser sensor needs servicing - an authorised Volvo workshop is recommended. It is absolutely essential to follow the prescribed instructions when handling the laser sensor.

The following two labels relate to the laser sensor:

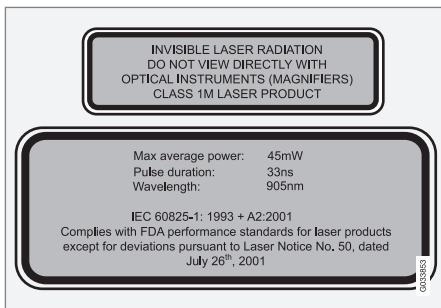

The upper label in the figure describes the laser beam's classification:

- Laser radiation - Do not look into the laser beam with optical instruments - Class 1M laser product.

The lower label in the figure describes the laser beam's physical data:

- IEC 60825-1:1993 + A2:2001. Complies with FDA (U.S. Food Administration) standards for laser product design with the exception of deviations in accordance with "Laser Notice No. 50" from 26 July 2001.

### Radiation data for the laser sensor

The following table specifies the laser sensor's physical data.

Maximum pulse energy	2.64 $\mu$ J
Maximum average output	45 mW
Pulse duration	33 ns
Divergence (horizontal x vertical)	28° x 12°



## WARNING

If any of these instructions are not followed then there is a risk of eye injury!

- Never look into the laser sensor (which emits spreading invisible laser radiation) at a distance of 100 mm or closer with magnifying optics such as a magnifying glass, microscope, lens or similar optical instruments.
- Testing, repair, removal, adjustment and/or replacement of the laser sensor's spare parts must only be carried out by a qualified workshop - we recommend an authorised Volvo workshop.
- To avoid exposure to harmful radiation, do not carry out any readjustments or maintenance other than those specified here.
- The repairer must follow specially drawn up workshop information for the laser sensor.
- Do not remove the laser sensor (this includes removing the lenses). A removed laser sensor does not fulfil laser class 3B as per standard IEC 60825-1. Laser class 3B is not eye-safe and therefore entails a risk of injury.
- The laser sensor's connector must be unplugged before removal from the windscreen.



- The laser sensor must be fitted onto the windscreen before the sensor's connector is plugged in.
- The laser sensor transmits a laser light when the remote control key is in key position **II** (p. 74) even if the engine is switched off.

**Related information**

- City Safety™ (p. 208)
- City Safety™ - limitations (p. 210)
- City Safety™ - function (p. 208)
- City Safety™ - operation (p. 209)
- City Safety™ - symbols and messages (p. 214)





## 07 Driver support

### City Safety™ - symbols and messages

In conjunction with automatic braking by the City Safety™ (p. 208) system, one or more

symbols may illuminate in the combined instrument panel and a text message may be shown. A text message can be acknowledged

by briefly pressing the **OK** button on the direction indicator stalk.

Symbol	Message	Meaning/Action
	Auto braking by City Safety	City Safety™ is braking or has automatically braked.
	Windscreen sensors blocked See manual	The laser sensor is temporarily non-operational because something is blocking it. <ul style="list-style-type: none"> <li>Remove the object blocking the sensor and/or clean the windscreen in front of the sensor. Read about laser sensor limitations (p. 210).</li> </ul>
	City Safety Service required	City Safety™ is not operational. <ul style="list-style-type: none"> <li>Visit a workshop if the message remains - an authorised Volvo workshop is recommended.</li> </ul>

### Related information

- City Safety™ (p. 208)
- City Safety™ - limitations (p. 210)
- City Safety™ - function (p. 208)
- City Safety™ - operation (p. 209)
- City Safety™ - laser sensor (p. 212)





### Collision warning system\*<sup>15</sup>

"Collision Warning with Auto Brake and Cyclist and Pedestrian Detection" is an aid to assist the driver when there is a risk of colliding with a pedestrian, cyclist or vehicle in front that are stationary or moving in the same direction.

"Collision Warning with Auto Brake and Cyclist and Pedestrian Detection" is activated in situations where the driver should have started braking earlier, which is why it cannot help the driver in every situation.

"Collision Warning with Auto Brake and Cyclist and Pedestrian Detection" is designed to be activated as late as possible in order to avoid unnecessary intervention.

"Collision Warning with Auto Brake and Cyclist and Pedestrian Detection" can prevent a collision or reduce collision speed.

"Collision Warning with Auto Brake and Cyclist and Pedestrian Detection" must not be used as an excuse for the driver to change his/her driving style. If the driver solely relies on Collision Warning with Auto Brake to do the braking, there might be a risk of a collision sooner or later.

### Two system levels

Depending on how the car is equipped, the "Collision Warning with Auto Brake and Cyclist and Pedestrian Detection" function may appear in two variants:

#### Level 1

The driver is merely warned<sup>16</sup> of occurring obstacles by means of visual and acoustic signals - no automatic braking intervenes, the driver must himself brake.

#### Level 2

The driver is warned of occurring obstacles by means of visual and acoustic signals - the car is braked automatically if the driver himself does not act within a reasonable time.



### IMPORTANT

Maintenance of the internal components of the "Collision Warning with Auto Brake and Cyclist and Pedestrian Detection" must only be performed at a workshop - an authorised Volvo workshop is recommended.

### Related information

- Collision warning system\* - function (p. 216)
- Collision warning system\* - detection of pedestrians (p. 218)

- Collision warning system\* - detection of cyclists (p. 217)
- Collision warning system\* - operation (p. 219)
- Collision warning system\* - limitations (p. 220)
- Collision warning system\* - camera sensor limitations (p. 221)
- Collision warning system\* - symbols and messages (p. 223)

<sup>15</sup> Not available as an option for certain engines.

<sup>16</sup> No warning for cyclists with "Level 1".



## Collision warning system\* - function

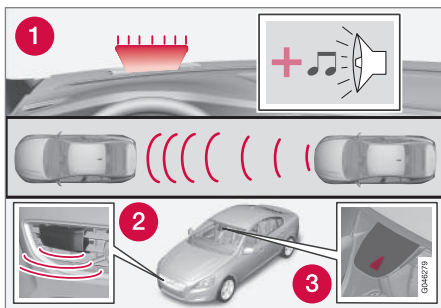

Function overview<sup>17</sup>.

- 1 Audio-visual warning signal in the event of a collision risk.
- 2 Radar sensor<sup>18</sup>
- 3 Camera sensor

Collision Warning with Auto Brake executes three steps in the following order:

1. **Collision warning**
2. **Brake support**<sup>18</sup>
3. **Auto Brake**<sup>18</sup>

The collision warning system and City Safety™ (p. 208) complement each other.

### 1 - Collision warning

The driver is first warned of a potentially imminent collision.

The collision warning system can detect pedestrians, cyclists or vehicles that are stationary or moving in the same direction in front of the driver's vehicle.

If there is a risk of collision with a pedestrian, cyclist or a vehicle then the driver's attention is attracted with a flashing red warning signal (1) and an acoustic signal.

### 2 - Brake support<sup>18</sup>

If the risk of collision has increased further after the collision warning then the brake support is activated.

This means that the brake system is prepared for rapid braking by applying the brakes lightly, which may feel like a slight jolt.

If the brake pedal is depressed sufficiently quickly then full brake function is implemented.

Brake support also reinforces the driver's braking if the system considers that the braking is not sufficient to avoid a collision.

### 3 - Auto Brake<sup>18</sup>

The automatic brake function is activated last.

If in this situation the driver has not yet started to take evasive action and the risk of collision is imminent then the automatic braking function is deployed - this takes place irrespective of whether or not the driver brakes. Braking then takes place with full brake force in order to reduce collision speed, or with limited brake force if it is sufficient to avoid a collision. For cyclists, the warning and full brake intervention may come very late or simultaneously.

<sup>17</sup> NOTE: The illustration is schematic - details may vary depending on car model.

<sup>18</sup> With system Level 2 only.



## WARNING

The collision warning system does not engage in all driving situations or traffic, weather or road conditions. The collision warning system does not react to vehicles or cyclists driving in another direction to the car or to animals.

Warning only activated in the event of a high risk for collision. This section "Function" and the section "Limitations" inform about limitations that the driver must be aware of before using the Collision Warning system with Auto Brake.

Warnings and brake interventions for pedestrians and cyclists are deactivated at a vehicle speed exceeding 80 km/h.

Warnings and brake interventions for pedestrians and cyclists do not work in darkness and tunnels - not even when streetlights are lit.

The auto-brake function can prevent a collision or reduce collision speed. To ensure full brake performance, the driver should always depress the brake pedal - even when the car auto-brakes.

Never wait for a collision warning. The driver is always responsible that the correct distance and speed are maintained - even when the collision warning system with auto-brake is used.

### Related information

- Collision warning system\* (p. 215)

<sup>20</sup> The reflector must fulfil the recommendations and conditions of the traffic authority in the market in question.

### Collision warning system\* - detection of cyclists

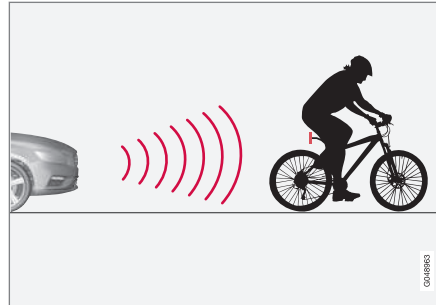

The function only "sees" cyclists from behind, who are travelling in the same direction.

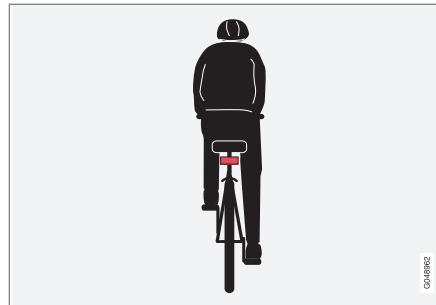

Optimum examples of what the system interprets as a cyclist - with clear body and bicycle con-

tours, directly from behind and in the car's centre line.

Optimal performance of the system requires that the system function that detects a cyclist receives as unambiguous information as possible about the body and bicycle contours - this implies the opportunity to identify the bicycle, head, arms, shoulders, legs, upper and lower body combined with a normal human pattern of movement.

If large parts of the cyclist's body or bicycle are not visible to the function's camera then the system cannot detect a cyclist.

- For the function to be able to detect a cyclist, he/she must be an adult and riding a "senior bicycle".
- The bicycle must be equipped with a highly visible and approved<sup>20</sup> rearward-facing red reflector, fitted at least 70 cm above the roadway.
- The function can only detect cyclists directly from behind and who are travelling in the same direction - not at an angle from behind, not from the side.
- Cyclists travelling on the left or right-hand edge of the car's imagined/extended side lines may be detected late or not at all.
- The function's capacity to detect cyclists at dusk and dawn is limited - just like the human eye.



## 07 Driver support



- The function's capacity to detect cyclists is deactivated when driving in darkness and tunnels - even when streetlights are lit.
- For optimum bicycle detection, the City Safety™ function must be activated, see City Safety™ (p. 208).

### WARNING

Collision Warning with Auto Brake & Cyclist Detection is a means of assistance.

The function cannot detect:

- all cyclists in all situations and does not see partially obscured cyclists, for example.
- cyclists in clothing that obscures the contours of the body or who are approaching from the side.
- bicycles that have no rearward-facing red reflector.
- bicycles loaded with large objects.

The driver is always responsible that the vehicle is driven properly and with a safety distance adapted to the speed.

### Related information

- Collision warning system\* (p. 215)

### Collision warning system\* - detection of pedestrians

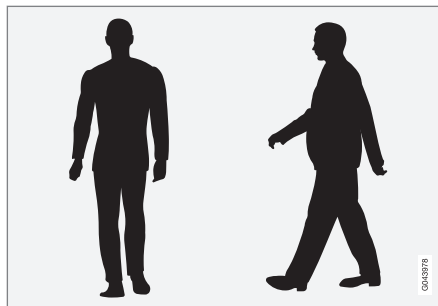

*Optimal examples of what the system regards as pedestrians with clear body contours.*

Optimal performance of the system requires that the system function that detects pedestrians receives as unambiguous information as possible about the contours of the body - this implies the opportunity to identify the head, arms, shoulders, legs, upper and lower body combined with a normal human pattern of movement.

If large parts of the body are not visible to the function's camera then the system cannot detect a pedestrian.

- In order for a pedestrian to be detected he/she must appear full-length and have a height of at least 80 cm.
- The camera sensor's ability to see pedestrians at dusk and dawn is limited - just like the human eye.
- The camera sensor's capacity to detect pedestrians is deactivated when driving in darkness and tunnels - even when streetlights are lit.

### WARNING

"Collision Warning with Auto Brake and Cyclist and Pedestrian Detection" is a means of assistance. The function cannot detect all pedestrians in all situations and does not see, for example:

- partially obscured pedestrians, people in clothing that hides their body contour or pedestrians shorter than 80 cm.
- pedestrians who are carrying larger objects.

The driver is always responsible that the vehicle is driven properly and with a safety distance adapted to the speed.

### Related information

- Collision warning system\* (p. 215)



## Collision warning system\* - operation

### Warning signals On and Off

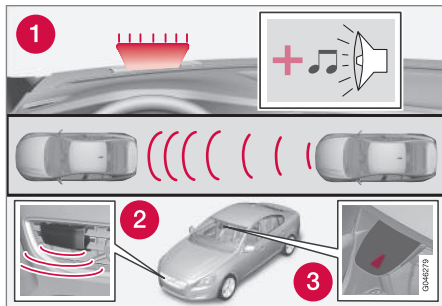

1. Acoustic and visual warning signal in the event of a collision risk.<sup>23</sup>

You can select whether the collision warning system's acoustic and visual warning signals should be switched on or off.

When starting the engine, the setting that was selected when the engine was switched off is obtained automatically.

#### NOTE

The Brake Support and Auto Brake functions are always enabled - they cannot be deactivated.

Settings for the collision warning system are made via the centre console's screen and the menu system **MY CAR**, see MY CAR (p. 108).

### Light and acoustic signals

When the collision warning system's light and acoustic warnings are activated, the warning lamp (no. [1] in previous illustration) is tested each time the engine is started by briefly illuminating the warning lamp's separate points of light.

After starting the engine, both the light and acoustic signals can be switched off:

- Search for **Collision Warning in Driver support systems** in the menu system **MY CAR**, MY CAR (p. 108) - and there select to uncheck the function.

### Acoustic signal

After starting the engine the warning sound can be activated/deactivated separately:

- Search for **Warning sound in Collision Warning** in the menu system **MY CAR**, MY CAR (p. 108) - and there select **On** or **Off**.

Following which, the collision warning system is only indicated with a light signal.

### Set warning distance

The warning distance regulates the distance at which the visual and acoustic warnings are deployed.

- Search for **Warning distance** in **Collision Warning** in the menu system **MY CAR**, MY CAR (p. 108) - and there select **Long**, **Normal** or **Short**.

The warning distance determines the system's sensitivity. Warning distance **Long** provides an earlier warning. First test with **Long** and if this setting produces too many warnings, which could be perceived as irritating in certain situations, then change to warning distance **Normal**.

Only use warning distance **Short** in exceptional cases, e.g. for dynamic driving.

#### NOTE

When the adaptive cruise control is in use the warning lamp and warning sound will be used by the cruise control even if the collision warning system is switched off.

The collision warning system warns the driver in the event of a risk of a collision, but the function cannot shorten driver reaction time.

In order for the collision warning system to be effective, always drive with Distance Warning (p. 205) set at time interval 4-5.

<sup>23</sup> The illustration is schematic - car model and details may differ.



# 07 Driver support



## **i** NOTE

Even if the warning distance has been set to **Long** warnings could be perceived as being late in certain situations, e.g. when there are large differences in speed or if vehicles in front brake heavily.

## **!** WARNING

No automatic system can guarantee 100 % correct function in all situations. Therefore, never test Collision Warning with Auto Brake by driving at people or vehicles - this may cause severe damage and injury and risk lives.

## Checking settings

The current settings can be controlled via the centre console's screen and the menu system (p. 108) **MY CAR**.

## Maintenance

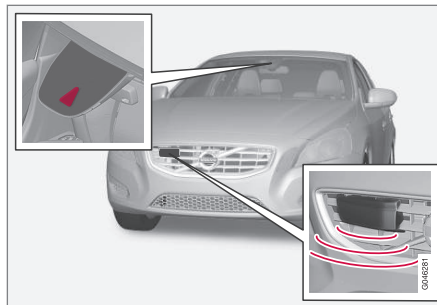

Camera and radar sensor<sup>24</sup>.

For the sensors to work correctly, they must be kept clear of dirt, ice and snow, and be cleaned regularly with water and car shampoo.

## **i** NOTE

Dirt, ice and snow covering the sensors will reduce their function and may prevent measurement.

## Related information

- Collision warning system\* (p. 215)

## Collision warning system\* - limitations

The function has certain limitations - for example, it is not active until approx. 4 km/h.

The collision warning system's visual warning signal (see (1) in the illustration (p. 216)) may be difficult to notice in the event of strong sunlight, reflections, when sunglasses are being worn or if the driver is not looking straight ahead. The warning sound should therefore always be activated.

On slippery road surfaces the braking distance is extended, which may reduce the capacity to avoid a collision. In such situations the ABS and ESC (p. 181) systems will provide best possible braking force with maintained stability.

## **i** NOTE

The visual warning signal can be temporarily disengaged in the event of high passenger compartment temperature caused by strong sunlight for example. If this occurs then the warning sound is activated even if it is deactivated in the menu system.

- Warnings may not appear if the distance to the vehicle in front is small or if steering wheel and pedal movements are large, e.g. a very active driving style.

<sup>24</sup> NOTE: The illustration is schematic - details may vary depending on car model.

**! WARNING**

Warnings and brake interventions could be implemented late or not at all if the traffic situation or external influences mean that the radar or camera sensor cannot detect a pedestrian, a vehicle or a cyclist in front correctly.

The sensor system has a limited range for pedestrians and cyclists<sup>26</sup> - the system can provide effective warnings and brake interventions for them at vehicle speeds up to 50 km/h. For stationary or slow-moving vehicles, warnings and brake interventions are effective at vehicle speeds up to 70 km/h.

Warnings for stationary or slow-moving vehicles could be disengaged due to darkness or poor visibility.

Warnings and brake interventions for pedestrians and cyclists are deactivated at vehicle speeds exceeding 80 km/h.

The collision warning system uses the same radar sensors as the Adaptive cruise control (p. 190). Read more about radar sensor limitations (p. 200).

If warnings are perceived as being too frequent or disturbing then the warning distance can be reduced (p. 219). This would lead to the system warning at a later stage, which reduces the total number of warnings.

Collision Warning with Auto Brake is temporarily deactivated with reverse gear engaged.

Collision Warning with Auto Brake is not activated at low speeds - under 4 km/h, which is why the system does not intervene in situations where the car is approaching a vehicle in front very slowly, e.g. when parking.

In situations where the driver demonstrates active, aware driving behaviour, a collision warning may be postponed slightly in order to keep unnecessary warnings to a minimum.

When Auto Brake has prevented a collision with a stationary object the car remains stationary for a maximum of 1.5 seconds. If the car is braked for a vehicle in front that is moving, then speed is reduced to the same speed as that maintained by the vehicle in front.

On a car with manual gearbox the engine stops when Auto Brake has stopped the car, unless the driver manages to depress the clutch pedal beforehand.

**Related information**

- Collision warning system\* (p. 215)

**Collision warning system\* - camera sensor limitations**

*"Collision Warning with Auto Brake and Cyclist and Pedestrian Detection" is an aid to assist the driver when there is a risk of colliding with a pedestrian, bicycle or vehicle in front that are stationary or moving in the same direction.*

*The function uses the car's camera sensor, which has certain limitations.*

The car's camera sensor is also used - as well as by Collision Warning with Auto Brake - by the functions:

- Automatic main/dipped beam dimming (p. 85)
- Road sign information (p. 185)
- Driver Alert Control - DAC (p. 225)
- Lane Keeping Aid (p. 229)

**i NOTE**

Keep the windscreen surface in front of the camera sensor free from ice, snow, mist and dirt.

Do not stick or attach anything to the windscreen in front of the camera sensor as this may reduce effectiveness or cause one or more of the systems dependent on the camera to stop working.

<sup>26</sup> For cyclists, the warning and full brake intervention may come very late or simultaneously.





## 07 Driver support



The camera sensors have limitations similar to the human eye, i.e. they "see" worse in darkness, heavy snowfall or rain and in thick fog for example. Under such conditions the functions of camera-dependent systems could be significantly reduced or temporarily disengaged.

Strong oncoming light, reflections in the carriageway, snow or ice on the road surface, dirty road surfaces or unclear lane markings could also significantly reduce camera sensor function when it is used to scan the carriageway and detect pedestrians and other vehicles.

The field of vision of the camera sensor is limited, which is why pedestrians, cyclists and vehicles cannot be detected in some situations, or they are detected later than anticipated.

During very high temperatures the camera is temporarily switched off for about 15 minutes after the engine is started in order to protect camera functionality.

### Fault tracing and action

If the display shows the message **Windscreen sensors blocked** See manual then this means that the camera sensor is blocked and cannot detect pedestrians, cyclists, vehicles or road markings in front of the car.

At the same time, this means that - besides Collision Warning with Auto Brake - the Automatic main/dipped beam dimming, Road sign information, Driver Alert Control and Lane Departure Warning functions will not have full functionality either.

The following table presents possible causes for a message being shown along with the appropriate action.

Cause	Action
The windscreen surface in front of the camera is dirty or covered with ice or snow.	Clean the windscreen surface in front of the camera from dirt, ice and snow.
Thick fog, heavy rain or snow means that the camera does not work sufficiently well.	No action. At times the camera does not work during heavy rain or snowfall.

Cause	Action
The windscreen surface in front of the camera has been cleaned but the message remains.	Wait. It may take several minutes for the camera to measure the visibility.
Dirt has appeared between the inside of the windscreen and the camera.	Visit a workshop to have the windscreen inside the camera cover cleaned - an authorised Volvo workshop is recommended.

### Related information

- Collision warning system\* (p. 215)





### Collision warning system\* - symbols and messages

"Collision Warning with Auto Brake and Cyclist and Pedestrian Detection" is an aid to



assist the driver when there is a risk of colliding with a pedestrian, bicycle or vehicle in front that are stationary or moving in the same direction.

Symbol <sup>A</sup>	Message	Specification
	Collision warning system OFF	Collision warning system switched off. Shown when the engine is started. The message clears after about 5 seconds or after one press of the <b>OK</b> button.
	Collision warning system Unavailable	The collision warning system cannot be activated. Shown when the driver attempts to activate the function. The message clears after about 5 seconds or after one press of the <b>OK</b> button.
	Auto Braking was activated	Auto Brake has been active. The message clears after one press of the <b>OK</b> button.
	Windscreen sensors blocked See manual	The camera sensor is temporarily disengaged. Shown in the event of snow, ice or dirt on the windscreen for example. <ul style="list-style-type: none"> <li>Clean the windscreen surface in front of the camera sensor.</li> </ul> Read about camera sensor limitations (p. 221).



# 07 Driver support



Symbol <sup>A</sup>	Message	Specification
	<b>Radar blocked See manual</b>	<p>Collision Warning with Auto Brake is temporarily disengaged.</p> <p>The radar sensor is blocked and cannot detect other vehicles. For example, in the event of heavy rain or if slush has collected in front of the radar sensor.</p> <p>Read about radar sensor limitations (p. 200).</p>
	<b>Collision warning Service required</b>	<p>Collision Warning with Auto Brake is fully or partially disengaged.</p> <ul style="list-style-type: none"> <li>Visit a workshop if the message remains - an authorised Volvo workshop is recommended.</li> </ul>

<sup>A</sup> Symbols are schematic - may vary by market and car model.

## Related information

- Collision warning system\* (p. 215)
- Collision warning system\* - function (p. 216)
- Collision warning system\* - detection of pedestrians (p. 218)
- Collision warning system\* - detection of cyclists (p. 217)
- Collision warning system\* - operation (p. 219)
- Collision warning system\* - limitations (p. 220)
- Collision warning system\* - camera sensor limitations (p. 221)



### Driver Alert System\*<sup>30</sup>

The Driver Alert System is intended to assist drivers whose driving ability is deteriorating or who are inadvertently leaving the lane they are driving on.

The Driver Alert System consists of different functions which can either be switched on at the same time or individually:

- Driver Alert Control - DAC (p. 226).
- Lane Departure Warning - LDW (p. 229).

A switched-on function is set in standby mode and is not activated automatically until speed exceeds 65 km/h.

The function is deactivated again when speed decreases to below 60 km/h.

Both functions use a camera which is dependent on the lane having side markings painted on each side.

#### WARNING

Driver Alert System does not work in all situations but is designed merely as a supplementary aid.

The driver always bears ultimate responsibility for ensuring that the vehicle is driven safely.

### Related information

- Driver Alert Control (DAC)\* (p. 225)
- Lane Departure Warning (LDW)\* (p. 229)

### Driver Alert Control (DAC)\*

The DAC function is intended to attract the driver's attention when he/she starts to drive less consistently, e.g. if he/she becomes distracted or starts to fall asleep.

The objective for DAC is to detect slowly deteriorating driving ability and it is primarily intended for major roads. The function is not intended for city traffic.

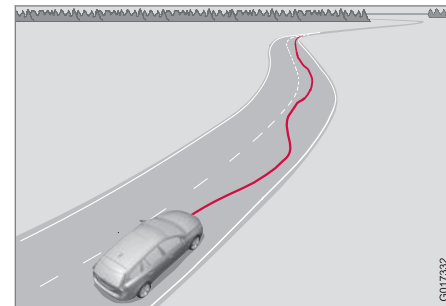

A camera detects the side markings painted on the carriageway and compares the section of the road with the driver's steering wheel movements. The driver is alerted if the vehicle does not follow the carriageway evenly.

In some cases driving ability is not affected despite driver fatigue. In which case there may not be any warning issued for the driver.

<sup>30</sup> Not available as an option for certain engines.



# 07 Driver support



For this reason it is always important to stop and take a break in the event of any signs of driver fatigue, irrespective of whether or not DAC issues a warning.

## NOTE

The function must not be used to extend a period of driving. Always plan breaks at regular intervals, and make sure you are well rested.

## Limitation

In some cases the system may issue a warning despite driving ability not deteriorating, for example:

- in strong side winds
- on rutted road surfaces.

## NOTE

The camera sensor has certain limitations (p. 221).

## Related information

- Driver Alert System\* (p. 225)
- Driver Alert Control (DAC)\* - operation (p. 226)
- Driver Alert Control (DAC)\* - symbols and messages (p. 227)

## Driver Alert Control (DAC)\* - operation

*Settings are made from the centre console display screen and its menu system.*

### On/Off

The Driver Alert function can be set in standby mode via the menu system **MY CAR** (p. 108):

- Checked box - function activated.
- Unchecked box - the function is deactivated.

### Function

Driver Alert is activated when speed exceeds 65 km/h and remains active as long as the speed is over 60 km/h.



If the vehicle is being driven erratically, the driver is notified by an acoustic signal plus the text message **Driver Alert Time for a break**

- the linked symbol is illuminated in the combined instrument panel at the same time. The warning is repeated after a time if driving ability does not improve.

The warning symbol can go off:

- Press the left stalk switch **OK** button.



## WARNING

An alarm should be taken very seriously, as a sleepy driver is often not aware of his/her own condition.

In the event of an alarm or a feeling of tiredness; stop the car in a safe manner as soon as possible and rest.

Studies have shown that it is equally as dangerous to drive while tired as it is under the influence of alcohol.

## Related information

- Driver Alert System\* (p. 225)
- Driver Alert Control (DAC)\* (p. 225)





## Driver Alert Control (DAC)\* - symbols and messages

DAC (p. 225) can show symbols and text messages on the combined instrument panel

or in the centre console's display screen in different situations.

### Combined instrument panel

Symbol <sup>A</sup>	Message	Specification
	<b>Driver Alert Time for a break</b>	The vehicle has been driven inconsistently - the driver is alerted by an acoustic warning signal + text.
	<b>Windscreen sensors blocked See manual</b>	The camera sensor is temporarily disengaged. Shown in the event of snow, ice or dirt on the windscreen for example. <ul style="list-style-type: none"> <li>Clean the windscreen surface in front of the camera sensor.</li> </ul> Read about camera sensor limitations (p. 221).
	<b>Driver Alert system Service required</b>	The system is disengaged. <ul style="list-style-type: none"> <li>Visit a workshop if the message remains - an authorised Volvo workshop is recommended.</li> </ul>

<sup>A</sup> Symbols are schematic - may vary by market and car model.

### Display

Sym- bol <sup>A</sup>	Message	Specification
	<b>Driver Alert OFF</b>	The function is disengaged.
	<b>Driver Alert Available</b>	The function is activated.



Sym- bol <sup>A</sup>	Message	Specification
	<b>Driver Alert Standby &lt;65 km/h</b>	The function is set in standby mode due to speed being lower than 65 km/h.
	<b>Driver Alert Unavailable</b>	The carriageway does not have clear side markings or the camera sensor is temporarily disengaged. Read about camera sensor limitations (p. 221).

<sup>A</sup> Symbols are schematic - may vary by market and car model.

### Related information

- Driver Alert System\* (p. 225)
- Driver Alert Control (DAC)\* (p. 225)
- Driver Alert Control (DAC)\* - operation (p. 226)



## Lane Departure Warning (LDW)\*

Lane Departure Warning is one of the functions in the Driver Alert System - sometimes also referred to as LDW (Lane Departure Warning).

The function is intended for use on motorways and similar major roads in order to reduce the risk of the vehicle accidentally leaving its own lane in certain situations.

### Principle for LDW

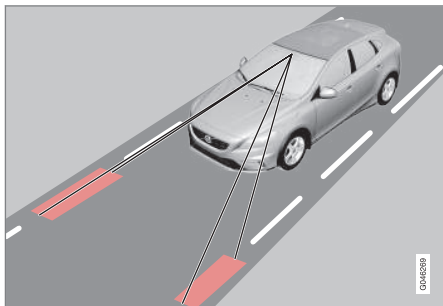

(The figure is schematic - not model specific.)

LDW consists of a camera that detects the side lines painted on the road/lane.

If the vehicle crosses the left or right-hand side line of the carriageway without due cause then the driver is alerted by an acoustic signal.

### NOTE

The driver is only warned once each time the wheels cross a line. So there is no acoustic alarm when there is a line between the car's wheels.

### WARNING

LDW is merely a driver's aid and does not engage in all driving situations or traffic, weather or road conditions.

The driver always bears ultimate responsibility for ensuring that the vehicle is driven safely and that applicable laws and road traffic regulations are followed.

### Related information

- Driver Alert System\* (p. 225)
- Lane Departure Warning (LDW) - limitations (p. 231)
- Lane Departure Warning (LDW) - function (p. 229)
- Lane Departure Warning (LDW) - operation (p. 230)
- Lane Departure Warning (LDW) - symbols and messages (p. 232)

## Lane Departure Warning (LDW) - function

Certain settings can be made for the Lane Departure Warning function.

### Off & On



LDW is engaged or disengaged using a button on the centre console. An indicator lamp in the button illuminates when the function is switched on.

This function is complemented in the combined instrument panel with intuitive graphics in different situations.

### Personal preferences

Settings are made from the centre console's screen via the menu system in **MY CAR**. For a description of the menu system, see **MY CAR** (p. 108).

Select from the options:



- **On at start-up** - The function enters standby mode every time the engine is started. Otherwise the same value as when the engine was switched off is obtained.
- **Increased sensitivity** - The sensitivity increases, an alarm is triggered earlier and fewer limitations apply.

## Related information

- Lane Departure Warning (LDW)\* (p. 229)
- Lane Departure Warning (LDW) - limitations (p. 231)
- Lane Departure Warning (LDW) - operation (p. 230)
- Lane Departure Warning (LDW) - symbols and messages (p. 232)

## Lane Departure Warning (LDW) - operation

*LDW is complemented in the combined instrument panel with intuitive graphics in different situations. Here are some examples:*



*The LDW function's side lines (marked in red in the figure).*

- The LDW symbol has WHITE side lines - the function is active and detects/"sees" one side line, or both.
  - The LDW symbol has GREY side lines - the function is active but detects neither left nor right side line.
- or
- The LDW symbol has GREY side lines - the function is in standby mode because the speed is below 65 km/h.
  - The LDW symbol has no side lines - the function is deactivated.

## Related information

- Lane Departure Warning (LDW)\* (p. 229)
- Lane Departure Warning (LDW) - limitations (p. 231)
- Lane Departure Warning (LDW) - function (p. 229)
- Lane Departure Warning (LDW) - symbols and messages (p. 232)





## Lane Departure Warning (LDW) - limitations

The Lane Keeping Aid camera sensor is restricted in a similar way to the human eye.

For more information, read about camera sensor limitations (p. 221).

### NOTE

There are some situations where LDW does not give any warning, such as:

- Direction indicators are switched on
- The driver has his/her foot on the brake pedal<sup>35</sup>
- In the event of rapid depression of the accelerator pedal<sup>35</sup>
- In the event of rapid steering wheel movements<sup>35</sup>
- If turning is so sharp that the car rolls.

### Related information

- Lane Departure Warning (LDW)\* (p. 229)
- Lane Departure Warning (LDW) - function (p. 229)
- Lane Departure Warning (LDW) - operation (p. 230)
- Lane Departure Warning (LDW) - symbols and messages (p. 232)

<sup>35</sup> When "Increased sensitivity" is selected a warning is still given, see Lane Departure Warning (LDW) - function (p. 229).





## 07 Driver support

### Lane Departure Warning (LDW) - symbols and messages

In situations where there is no LDW function a symbol may be shown in the combined

instrument panel in combination with an explanatory message - follow the recommendation given if appropriate.

Message examples:

Symbol <sup>A</sup>	Message	Specification
	Lane Departure Warning ON/ Lane Departure Warning OFF	The function is switched on/off. Shown at switch-on/off. The text disappears after 5 seconds.
	Lane Depart. Warning Unavailable at this speed	The function is set in standby mode due to speed being lower than 65 km/h.
	Lane Depart. Warning Unavailable	The lane does not have clear side markings or the camera sensor is temporarily disengaged. Read about camera sensor limitations (p. 221).
	Lane Depart. Warning Available	The function scans the lane's side markings.
	Windscreen sensors blocked See manual	The camera sensor is temporarily disengaged. Shown in the event of snow, ice or dirt on the windscreen for example. <ul style="list-style-type: none"> <li>• Clean the windscreen surface in front of the camera sensor.</li> </ul> Read about camera sensor limitations (p. 221).
	Driver Alert system Service required	The system is disengaged. <ul style="list-style-type: none"> <li>• Visit a workshop if the message remains - an authorised Volvo workshop is recommended.</li> </ul>

<sup>A</sup> Symbols are schematic - may vary by market and car model.

**Related information**

- Lane Departure Warning (LDW)\* (p. 229)
- Lane Departure Warning (LDW) - limitations (p. 231)
- Lane Departure Warning (LDW) - function (p. 229)
- Lane Departure Warning (LDW) - operation (p. 230)



## Park Assist\*

Parking assistance is used as an aid to parking. An acoustic signal as well as symbols on the centre console's display screen indicate the distance to the detected obstacle.

Parking assistance sound level can be adjusted during the ongoing acoustic signal using the centre console's **VOL** knob or in the car's menu system (p. 108) **MY CAR**.

Parking assistance is available in two variants:

- Rear only
- Both front and rear.

### NOTE

When a towbar is configured with the car's electrical system, the protrusion of the towbar is included when the function measures the parking space.

### WARNING

- Parking assistance does not relinquish the driver's own responsibility during parking.
- The sensors have blind spots where obstacles cannot be detected.
- Be aware of e.g. people or animals near the car.

## Related information

- Park assist syst\* - cleaning the sensors (p. 237)
- Park assist syst\* - function (p. 234)
- Park assist syst\* - forward (p. 236)
- Park assist syst\* - fault indication (p. 237)
- Park assist syst\* - backward (p. 235)
- Park assist camera\* (p. 238)

## Park assist syst\* - function

The parking assistance system is automatically activated when the engine is started - the switch's On/Off lamp is illuminated. If parking assistance is switched off with the button, the lamp goes out.



On/Off for parking assistance.

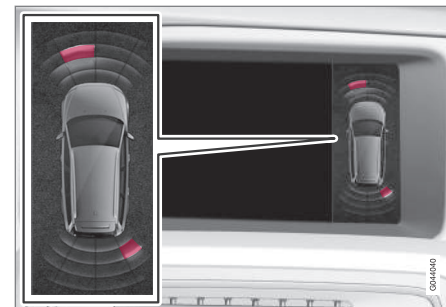

Display screen view - showing an obstacle left front and right rear.



The centre console's display screen shows an overview of the relationship between the car and detected obstacle.

Marked sectors show which of the four sensor(s) detected an obstacle. The closer to the car symbol a selected sector box is, the shorter the distance between the car and a detected obstacle.

The frequency of the signal increases the shorter the distance to an obstacle, in front of or behind the car. Other sound from the audio system is muted automatically.

When the distance is within 30 cm the tone is constant and the active sensor's field nearest the car is filled in. If the detected obstacle is within the distance for the constant tone both behind and in front of the car, then the tone sounds alternately from the loudspeakers.

### ! IMPORTANT

Objects e.g. chains, thin glossy poles or low barriers may be in the "signal shadow" and are then temporarily not detected by the sensors - the pulsating tone may then unexpectedly stop instead of changing over to the expected constant tone.

The sensors cannot detect high objects, such as projecting loading docks.

- In such situations, pay extra attention and manoeuvre/reposition the car particularly slowly or stop the current parking manoeuvre - there may be a high risk of damage to vehicles or other objects since the sensors are temporarily unable to function optimally.

### Related information

- Park Assist\* (p. 234)
- Park assist syst\* - cleaning the sensors (p. 237)
- Park assist syst\* - forward (p. 236)
- Park assist syst\* - fault indication (p. 237)
- Park assist syst\* - backward (p. 235)
- Park assist camera\* (p. 238)

### Park assist syst\* - backward

*Parking assistance is used as an aid to parking. An acoustic signal as well as symbols on the centre console's display screen indicate the distance to the detected obstacle.*

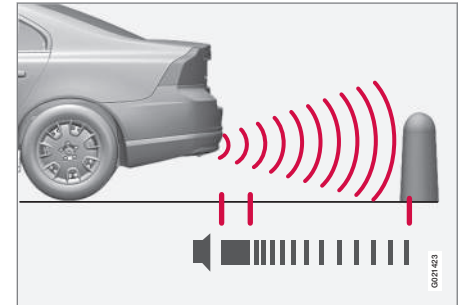

The distance covered to the rear of the car is about 1.5 metres. The acoustic signal for obstacles behind comes from one of the rear loudspeakers.

Rear parking assistance is activated when reverse gear is engaged.

When reversing with e.g. a trailer on the towbar, rear parking assistance is switched off automatically - otherwise the sensors would react to the trailer.



## NOTE

When reversing with e.g. a trailer or bike carrier on the towbar - without Volvo genuine trailer wiring - parking assistance may need to be switched off manually in order that the sensors do not react to them.

### Related information

- Park Assist\* (p. 234)
- Park assist syst\* - cleaning the sensors (p. 237)
- Park assist syst\* - function (p. 234)
- Park assist syst\* - forward (p. 236)
- Park assist syst\* - fault indication (p. 237)
- Park assist camera\* (p. 238)

## Park assist syst\* - forward

*Parking assistance is used as an aid to parking. An acoustic signal as well as symbols on the centre console's display screen indicate the distance to the detected obstacle.*

*The parking assistance system is automatically activated when the engine is started - the switch's On/Off lamp is illuminated. If parking assistance is switched off with the button, the lamp goes out.*

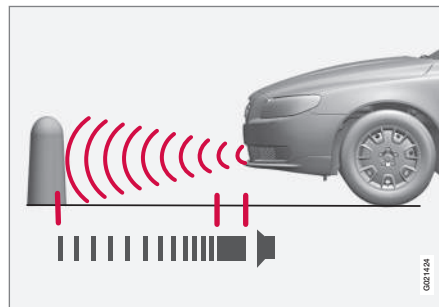

The distance covered in front of the car is about 0.8 metres. The acoustic signal for obstacles in front comes from one of the front loudspeakers.

Front park assist is active up to approx. 10 km/h. The lamp in the button is illuminated in order to indicate that the system is activated. When the speed is below 10 km/h the system is reactivated.

## NOTE

Front parking assistance is deactivated when the parking brake is applied or **P** mode is selected in a car with an automatic gearbox.

## IMPORTANT

When auxiliary lamps are fitted: Remember that these must not obscure the sensors - the auxiliary lamps may then be perceived as an obstacle.

### Related information

- Park Assist\* (p. 234)
- Park assist syst\* - cleaning the sensors (p. 237)
- Park assist syst\* - function (p. 234)
- Park assist syst\* - fault indication (p. 237)
- Park assist syst\* - backward (p. 235)
- Park assist camera\* (p. 238)



### Park assist syst\* - fault indication

Parking assistance is used as an aid to parking. An acoustic signal as well as symbols on the centre console's display screen indicate the distance to the detected obstacle.

 If the combined instrument panel's information symbol illuminates with constant glow and the text message

**Park Assist System Service required** is shown then parking assistance is disengaged.

### IMPORTANT

In certain conditions the parking assistance system may produce incorrect warning signals that are caused by external sound sources that emit the same ultrasonic frequencies that the system works with.

Examples of such sources include horns, wet tyres on asphalt, pneumatic brakes and exhaust noises from motorcycles etc.

### Related information

- Park Assist\* (p. 234)
- Park assist syst\* - cleaning the sensors (p. 237)
- Park assist syst\* - function (p. 234)
- Park assist syst\* - forward (p. 236)
- Park assist syst\* - backward (p. 235)
- Park assist camera\* (p. 238)

### Park assist syst\* - cleaning the sensors

Parking assistance is used as an aid to parking. An acoustic signal as well as symbols on the centre console's display screen indicate the distance to the detected obstacle.

The sensors must be cleaned regularly to ensure that they work properly. Clean them with water and car shampoo.

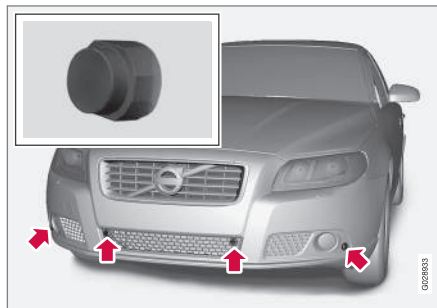

Sensor location, front.

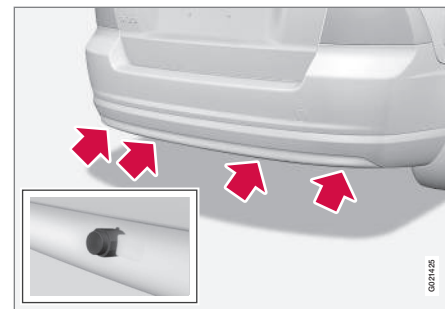

Sensor location, rear.

### NOTE

Dirt, ice and snow covering the sensors may cause incorrect warning signals.

### Related information

- Park Assist\* (p. 234)
- Park assist syst\* - function (p. 234)
- Park assist syst\* - forward (p. 236)
- Park assist syst\* - fault indication (p. 237)
- Park assist syst\* - backward (p. 235)
- Park assist camera\* (p. 238)



## 07 Driver support

### Park assist camera\*

*Parking camera is an auxiliary system, which is activated when the reverse gear is selected.*

The camera image is shown on the centre console's screen.

#### NOTE

When a towbar is configured with the car's electrical system, the protrusion of the towbar is included when the function measures the parking space.

#### WARNING

- The parking camera serves as an aid. It does not relieve the driver of responsibility when reversing.
- The camera has blind spots, where obstacles cannot be detected.
- Be aware of people and animals in the vicinity of the car.

### Function and operation

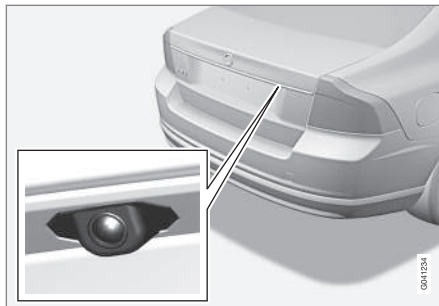

*Camera location next to the opening handle.*

The camera shows what is behind the car and if something appears from the sides.

The camera shows a wide area behind the car and part of the bumper and any towbar.

Objects on the screen may appear to tilt slightly - this is normal.

#### NOTE

Objects on the display screen may be closer to the car than they appear to be on the screen.

If another view is active then the parking camera system takes over automatically and its camera image is displayed on the screen.

When reverse gear is selected, unbroken lines are shown graphically which illustrate where

the car's approximate external dimensions will be positioned with the current steering wheel angle - this facilitates parallel parking, reversing into tight spaces and for hitching a trailer. The park assist lines can be deactivated - see section Settings (p. 240).

If the car is also equipped with Parking assistance sensors (p. 234)\* then their information is shown graphically as coloured areas in order to illustrate distances to detected obstacles, see heading "Cars with reversing sensors" later in the text.

The camera is active approx. 5 seconds after reverse gear has been disengaged or until the car's speed exceeds 10 km/h forward or 35 km/h backward.

### Light conditions

The camera image is adjusted automatically according to prevailing light conditions. Because of this, the image may vary slightly in brightness and quality. Poor light conditions can result in a slightly reduced image quality.

#### NOTE

Keep the camera lens clear of dirt, snow and ice to ensure optimum function. This is particularly important in poor light.





## Park assist lines

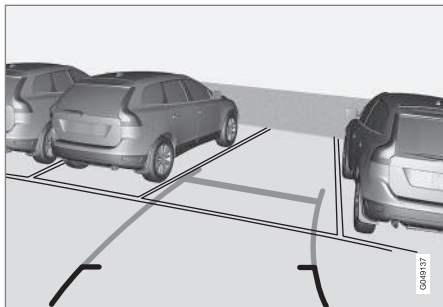

Examples of how the park assist lines can be displayed for the driver.

The lines on the screen are projected as if they were at ground level behind the car and are directly related to steering wheel movement, which shows the driver the path the car will then take - also when the car is turning.

## **i** NOTE

- When reversing with a trailer which is not connected electrically to the car, the lines on the display show the route the **car** will take - not the trailer.
- The screen shows no lines when a trailer is connected electrically to the car's electrical system.
- The parking camera is deactivated automatically when towing a trailer if a Volvo genuine trailer cable is used.

## **!** IMPORTANT

Bear in mind that the screen only shows the area behind the car - pay attention to the sides and front of the car when manoeuvring during reversing.

## Boundary lines

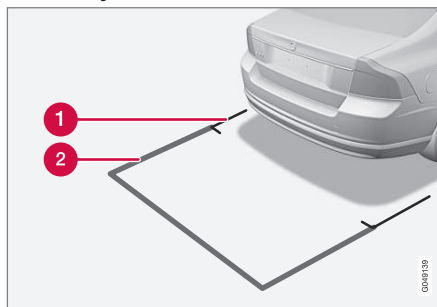

The system's lines.

- 1 Boundary line, 30 cm zone backwards from the car
- 2 Boundary line, free reversing zone

The red line (1) frames in a zone approx. 30 cm back from the bumper.

The yellow horizontal line (2) frames in a zone up to approx. 1.5 m behind the bumper.

The yellow side lines end approx. 2.0 m behind the bumper.

The boundary lines include the car's most protruding parts, e.g. door mirrors and corners - also when the car is turning.

## Cars with reversing sensors\*

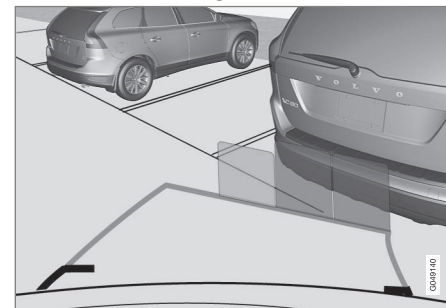

Coloured areas (x 4, one per sensor) show distance.

If the car is also equipped with Parking assistance (p. 234) the distance is shown with coloured fields for each sensor that registers an obstacle.

The colour of the areas changes with decreasing distance to the obstacle - from green to yellow to red.

Colour / paint	Distance (metres)
Green	0,8-1,5
Yellow	0,4-0,8
Red	0-0,4





## Park assist camera - limitations

### NOTE

A bike carrier or other accessory mounted on the rear of the car could obscure the camera's view.

## To bear in mind

Pay attention to the possibility that, even if it only looks like a relatively small part of the image is obscured, it could be a relatively large sector that is hidden from view. Obstacles could thereby go undetected until they are very close to the car.

- Keep the camera lens free from dirt, ice and snow.
- Clean the camera lens regularly with lukewarm water and car shampoo - take care not to scratch the lens.

## Related information

- Park assist camera\* (p. 238)
- Park assist camera - settings (p. 240)
- Park Assist\* (p. 234)

## BLIS\*

*BLIS (Blind Spot Information System) is a camera-based information system that under certain conditions can help the driver to notice vehicles moving in the same direction as the host vehicle in the so-called "blind spot".*

The system is designed to work most effectively when driving in dense traffic on multi-lane highways.

### WARNING

The system is a supplement to, not a replacement for, a safe driving style and use of the rearview mirrors. It can never replace the driver's attention and responsibility. The responsibility for changing lanes safely always rests with the driver.

## Overview

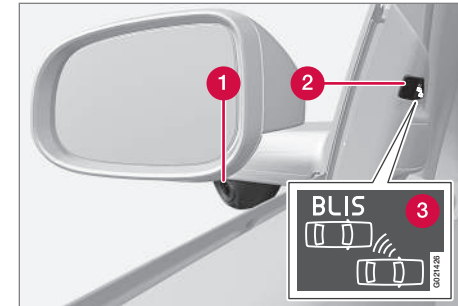

Rearview mirror with BLIS function<sup>36</sup>.

- 1 BLIS camera
- 2 Indicator lamp
- 3 BLIS symbol

### NOTE

The lamp illuminates on the side of the car where the system has detected the vehicle. If the car is overtaken on both sides at the same time then both lamps illuminate.

## Maintenance

In order to work most effectively the BLIS camera lenses<sup>37</sup> must be clean. The lenses can be cleaned with a soft cloth or damp

<sup>36</sup> NOTE: The illustration is schematic - details may vary depending on car model.

<sup>37</sup> See (1) in the preceding illustration.



sponge. Clean the lenses carefully so that they are not scratched.

## **!** IMPORTANT

The lenses are electrically heated to melt ice or snow. If necessary, brush snow away from the lenses.

### Related information

- BLIS\* - operation (p. 242)
- BLIS - symbols and messages (p. 244)

## BLIS\* - operation

*BLIS (Blind Spot Information System) is a function designed for providing support for the driver when driving in dense traffic on roads with several lanes in the same direction.*

### Activate/deactivate BLIS

BLIS is activated when the engine is started. The indicator lamps in the door panels flash three times when BLIS is activated.

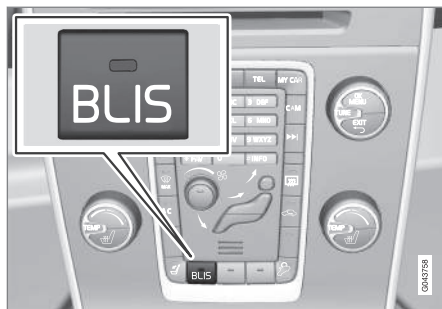

Button for activating/deactivating.

The system can be deactivated/activated after starting the engine with one press on the **BLIS** button.

Some combinations of the selected equipment leave no vacant space for a button in the centre console - in which case the function is handled by the car's menu system (p. 108) **MY CAR**.

When BLIS is deactivated, the lamp in the button extinguishes and a message is shown in the combined instrument panel.

When BLIS is activated the lamp in the button illuminates, the combined instrument panel shows a new text message and the indicator lamps in the door panels flash 3 times. Press the left-hand stalk switch **OK** button in order to switch off the text message.

### When BLIS operates

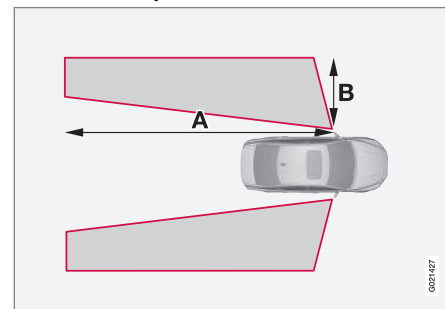

$A = \text{approx. } 9.5 \text{ m}$  and  $B = \text{approx. } 3.0 \text{ m}$ .

The system operates when the car is driven at a speed above 10 km/h.

When a camera (1) has detected a vehicle inside the blind spot zone the indicator lamp (2) illuminates with a constant glow, see overview illustration (p. 241).

BLIS advises the driver with a message if a fault arises in the system. If, for example, the



system's cameras are obscured then the BLIS indicator lamp flashes and a message is shown in the combined instrument panel. In such cases, check and clean the lenses.

If necessary, the system can be switched off temporarily, see "Activate/deactivate BLIS" above.

### Overtaking

The system is designed to react if:

- you overtake another vehicle at a speed of up to 10 km/h faster than the other vehicle
- you are overtaken by a vehicle travelling up to 70 km/h faster than you are travelling.

### WARNING

BLIS does not work in sharp bends.

BLIS does not work when the car is reversing.

A wide trailer coupled to the car can conceal other vehicles in adjacent lanes. It can prevent the vehicle in the screened area from being detected by BLIS.

### Daylight and darkness

In daylight the system reacts to the shape of the surrounding vehicles. The system is designed to detect motor vehicles such as cars, trucks, buses and motorcycles.

In darkness the system reacts to the headlamps of surrounding vehicles. If the headlamps of surrounding vehicles are not switched on then the system does not detect the vehicles. This means for example that the system does not react to a trailer without headlamps which is towed behind a car or truck.

### WARNING

The system does not react to cyclists or moped riders.

The BLIS cameras have limitations similar to those of the human eye, i.e. they do not "see" as well e.g. in heavy snowfall, against strong light or in thick fog.

### Limitations

In some situations the BLIS indicator lamp may illuminate despite there being no other vehicle within the blind spot.

### NOTE

If the BLIS indicator lamp illuminates on isolated occasions despite there being no other vehicle within the blind spot then this does not mean that a fault has arisen in the system.

In the event of a fault in the BLIS system the display shows the text **BLIS Service required**.

The following illustrations show examples of situations where the BLIS indicator lamp may illuminate even if there is no other vehicle within the blind spot.

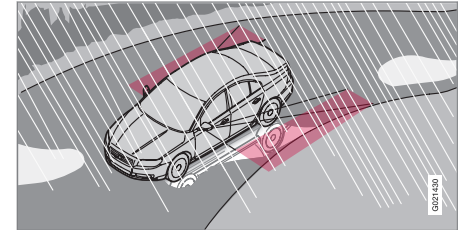

*Reflection from shiny wet road surface.*

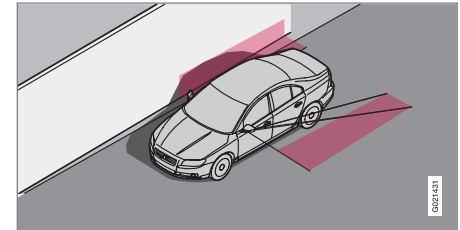

*Own shadow on large light smooth surface, e.g. noise barrier or concrete road surface.*

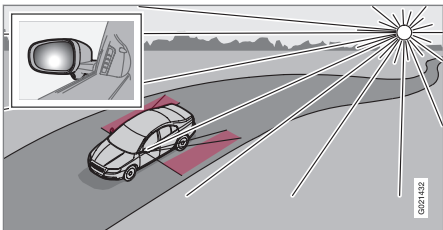

Low stationary sunlight shining into the camera.

## **IMPORTANT**

Repair of the BLIS system components must only be performed by a workshop - an authorised Volvo workshop is recommended.

### **Related information**

- BLIS\* (p. 241)
- BLIS - symbols and messages (p. 244)

## **BLIS - symbols and messages**

*In situations where the BLIS (Blind Spot Information System) (p. 241) function fails or is interrupted, the combined instrument panel may show a symbol, supplemented by an explanatory message. Follow any recommendation given.*

Message examples:

Message	Specification
<b>BLIS ON</b>	The BLIS system is activated.
<b>BLIS Service required</b>	Blind spot syst. disengaged - contact a workshop.
<b>BLIS Camera blocked</b>	The BLIS camera is blocked by dirt, snow or ice - clean the lenses.

Message	Specification
<b>BLIS Reduced function</b>	<p>Reduced function in the data transmission between the BLIS system's camera and the car's electrical system.</p> <p>The camera resets itself when the data transmission between the BLIS system's camera and the car's electrical system returns to normal.</p>
<b>BLIS OFF</b>	The BLIS system is deactivated.

A text message can be acknowledged by briefly pressing the **OK** button on the direction indicator stalk.

### **Related information**

- BLIS\* (p. 241)



### Adjustable steering force\*

Speed related power steering causes the steering wheel force to increase with the speed of the car in order to give the driver enhanced sensitivity.

On motorways the steering feels firmer. Steering is light and requires no extra effort when parking and at low speed.

The driver can choose between three different levels of steering force for road responsiveness or steering sensitivity in the menu system **MY CAR**, MY CAR (p. 108):

- Once there, search for **Steering wheel force** and select **Low**, **Medium** or **High**.

This setting is not accessible when the car is moving.

#### NOTE

In certain situations the power steering may become too hot and then needs to be temporarily cooled - during this time the power steering operates with reduced power and turning the steering wheel may then be perceived to be slightly heavier.

In parallel with the temporarily reduced steering assistance the combined instrument panel shows a message.

#### Related information

- MY CAR (p. 108)

### Type approval - radar system

Type approval for the radar system can be read in the table.

Country/ Area	
Singapore	<div style="border: 1px solid black; padding: 5px; text-align: center;">Complies with IDA standards DA105753</div> <p>IDA: Infocomm Development Authority of Singapore.</p>
Brazil	
Europe	<p><b>CE</b> Delphi Electronics &amp; Safety hereby declares that L2C0038TR and L2C0049TR are in compliance with the essential requirements and other relevant provisions of Directive 1999/5/EC. This declaration of conformity may, if necessary, be consulted with Delphi Electronics &amp; Safety / One Corporate Center / Kokomo, Indiana 46904-9005 USA.</p>

#### Related information

- Radar sensor (p. 199)

# 08



## STARTING AND DRIVING







## Alcolock\*

The function of the Alcolock<sup>1</sup> is to prevent the car from being driven by individuals under the influence of alcohol. Before the engine can be started the driver must take a breath test that verifies that he/she is not under the influence of alcohol. Alcolock calibration takes place in accordance with each market's limit value in force for driving legally.

### WARNING

The Alcolock is an aid and does not exempt the driver from responsibility. It is always the responsibility of the driver to be sober and to drive the car safely.

### Related information

- Alcolock\* - functions and operation (p. 247)
- Alcolock\* - storage (p. 248)
- Alcolock\* - before starting the engine (p. 248)
- Alcolock\* - to bear in mind (p. 250)
- Alcolock\* - symbols and text messages (p. 251)

## Alcolock\* - functions and operation

### Functions

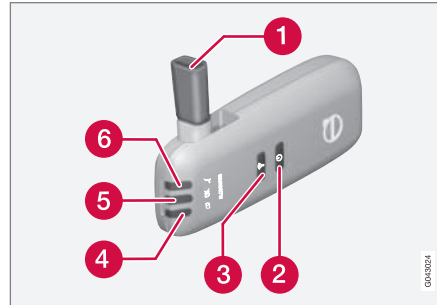

- 1 Nozzle for breath test.
- 2 Switch.
- 3 Transmission button.
- 4 Lamp for battery status.
- 5 Lamp for result of breath test.
- 6 Lamp indicates ready for breath test.

### Operation - battery

Alcolock indicator lamp (4) shows battery status:

Indicator lamp (4)	Battery status
Green flashing	Charging in progress
Green	Fully charged
Yellow	Semi-charged
Red	Discharged - fit the charger in the holder or connect the power supply cable from the glovebox.

### NOTE

Store the Alcolock in its holder. This will keep the built-in battery fully charged and the Alcolock is activated automatically when the car is opened.

### Related information

- Alcolock\* (p. 247)
- Alcolock\* - storage (p. 248)
- Alcolock\* - before starting the engine (p. 248)
- Alcolock\* - to bear in mind (p. 250)
- Alcolock\* - symbols and text messages (p. 251)

<sup>1</sup> Also called Alcolguard.

## Alcolock\* - storage

Store the Alcolock in its holder. Release the handheld unit by depressing it slightly in its holder and releasing it - it then springs out and can be removed from the holder.

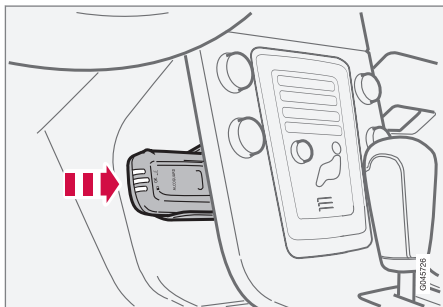

Handheld unit storage and charging station.

- Replace the handheld unit in the holder by pushing it in until it engages.
- Store the handheld unit in the holder - this provides it with the best protection and keeps its batteries fully charged.

## Related information

- Alcolock\* (p. 247)
- Alcolock\* - functions and operation (p. 247)
- Alcolock\* - before starting the engine (p. 248)
- Alcolock\* - to bear in mind (p. 250)

- Alcolock\* - symbols and text messages (p. 251)

## Alcolock\* - before starting the engine

The Alcolock is activated automatically and is then ready for use when the car is opened.

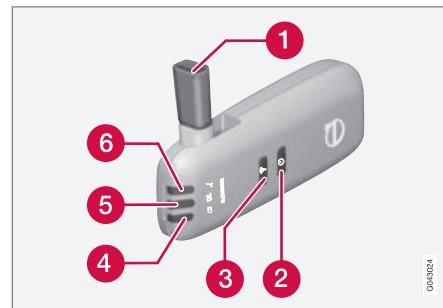

- 1 Nozzle for breath test.
  - 2 Switch.
  - 3 Transmission button.
  - 4 Lamp for battery status.
  - 5 Lamp for result of breath test.
  - 6 Lamp indicates ready for breath test.
1. When the indicator lamp (6) is green the Alcolock is ready for use.
  2. Withdraw the Alcolock from its holder. If the Alcolock is outside the car when it is unlocked then it must first be activated with the switch (2).



3. Fold up the nozzle (1), take a deep breath and blow with an even pressure until a "click" is heard after approx. 5 seconds. The result will be one of the alternatives in the following table **Result after breath test**.
4. If no message is shown then the transmission to the car may have failed - in which case, press the button (3) to transmit the result to the car manually.
5. Fold down the nozzle and refit the Alcolock in its holder.
6. Start the engine following an approved breath test within 5 minutes - otherwise it must be repeated.

### Result after breath test

Indicator lamp (5) + Display text	Specification
Green lamp + <b>Alcoguard Approved test</b>	Start the engine - no alcohol content measured.
Yellow lamp + <b>Alcoguard Approved test</b>	Engine starting possible - measured alcohol content is above 0.1 promille but below the limit value in force <sup>A</sup> .
Red lamp + <b>Dis-approved test Wait 1 minute to try again</b>	Engine starting not possible - measured alcohol content is above the limit value in force <sup>A</sup> .

<sup>A</sup> Limit values vary from country to country. Find out what applies in your country. See also Alcolock\* (p. 247)

### NOTE

After a completed period of driving, the engine can be restarted within 30 minutes without a new breath test.

### Related information

- Alcolock\* (p. 247)
- Alcolock\* - functions and operation (p. 247)

- Alcolock\* - storage (p. 248)
- Alcolock\* - to bear in mind (p. 250)
- Alcolock\* - symbols and text messages (p. 251)



## Alcolock\* - to bear in mind

In order to obtain correct function and as accurate a measurement result as possible:

- Avoid eating or drinking approx. 5 minutes before the breath test.
- Avoid excess windscreen washing - the alcohol in the washer fluid may result in an incorrect measurement result.

## Change of driver

In order to ensure that a new breath test is carried out in the event of a change of driver - depress the switch (2) and the send button (3) simultaneously for approx. 3 seconds. At which point the car returns to start inhibition mode and a new approved breath test is required before starting the engine.

## Calibration and service

The Alcolock must be checked and calibrated at a workshop<sup>2</sup> every 12 months.

30 days before recalibration is necessary the combined instrument panel shows the message **Alcoguard Calibration required See manual**. If calibration is not carried out within these 30 days then normal engine starting will be blocked - only starting with the Bypass function will then be possible, see the following heading "Emergency situation".

The message can be cleared by pressing the send button (3) once. Otherwise it goes out on its own after approx. 2 minutes but then reappears each time the engine is started - only recalibration at a workshop<sup>2</sup> can clear the message permanently.

## Cold or hot weather

The colder the weather the longer it takes before the Alcolock is ready for use:

Temperature (°C)	Maximum heating time (seconds)
+10 to +85	10
-5 to +10	60
-40 to -5	180

At temperatures below -20 °C or above +60 °C the Alcolock requires additional power supply. The combined instrument panel shows **Alcoguard Please insert power cable**. In which case, connect the power supply cable from the glovebox and wait until indicator lamp (6) is green.

In extremely cold weather the heating time can be reduced by taking the Alcolock indoors.

## Emergency situation

In the event of an emergency situation or the Alcolock is out of order, it is possible to bypass the Alcolock in order to drive the car.



### NOTE

All Bypass activation is logged and saved in memory, see Recording data (p. 18).

After the Bypass function has been activated the combined instrument panel shows **Alcoguard Bypass enabled** the whole time while driving and can only be reset by a workshop<sup>2</sup>.

The Bypass function can be tested without the error message being logged - in which case, carry out all the steps without starting the car. The error message is cleared when the car is locked.

When the Alcolock is installed, either the Bypass or Emergency function is selected as the bypassing option. This setting can be changed afterwards at a workshop<sup>2</sup>.

## Activating the Bypass function

- Depress and hold the left-hand stalk switch **OK** button and the button for hazard warning flashers simultaneously for approx. 5 seconds - the combined instrument panel first shows **Bypass activated Please wait for 1 minute** and then

<sup>2</sup> An authorised Volvo workshop is recommended.

\* Option/accessory, for more information, see Introduction.



**Alcoguard Bypass enabled** - after which the engine can be started.

This function can be activated several times. The error message shown during driving can only be cleared at a workshop<sup>2</sup>.

#### Activating the Emergency function

- Depress and hold the left-hand stalk switch **OK** button and the button for hazard warning flashers simultaneously for approx. 5 seconds - the combined instrument panel shows **Alcoguard Bypass enabled** and the engine can be started.

This function can be used once, after which a reset must be made at a workshop<sup>2</sup>.

#### Related information

- Alcolock\* - functions and operation (p. 247)
- Alcolock\* - storage (p. 248)
- Alcolock\* - before starting the engine (p. 248)
- Alcolock\* (p. 247)
- Alcolock\* - symbols and text messages (p. 251)

#### Alcolock\* - symbols and text messages

*In addition to the previously described messages related to how the alcolock works before starting the engine (p. 248) the combined instrument panel's display can also show the following:*

Display text	Meaning/Action
<b>Alcoguard Restart possible</b>	The engine has been switched off for less than 30 minutes - engine starting possible without new test.
<b>Alcoguard Service required</b>	Contact a workshop <sup>A</sup> .
<b>Alcoguard No signal received</b>	Transmission failed - send manually with button (3) or take a new breath test.
<b>Alcoguard Please try again</b>	Test failed - take a new breath test.
<b>Alcoguard Please blow longer</b>	Blowing too short - blow for longer.

Display text	Meaning/Action
<b>Alcoguard Please blow softer</b>	Blowing too hard - blow more gently.
<b>Alcoguard Please blow harder</b>	Blowing too weak - blow harder.
<b>Alcoguard preheating Please wait</b>	Heating not finished - wait for text <b>Alcoguard Please blow for 5 seconds</b> .

<sup>A</sup> An authorised Volvo workshop is recommended.

#### Related information

- Alcolock\* (p. 247)
- Alcolock\* - functions and operation (p. 247)
- Alcolock\* - storage (p. 248)
- Alcolock\* - before starting the engine (p. 248)
- Alcolock\* - to bear in mind (p. 250)

<sup>2</sup> An authorised Volvo workshop is recommended.



## Starting the engine

The engine is started and switched off using the remote control key and the **START/STOP ENGINE** button.

## Petrol and diesel engine



Ignition switch with remote control key extracted/inserted, and **START/STOP ENGINE** button.

### ! IMPORTANT

Do not press in the remote control key incorrectly turned - hold the end with the detachable key blade, see Detachable key blade - detaching/attaching (p. 162).

1. Insert the remote control key in the ignition switch and press it in to its end position. Note that if the car is equipped with Alcolock\* then a breath test must first be approved before the engine can be started. For more information on the Alcolock, see Alcolock\* (p. 247).
2. Hold the clutch pedal fully depressed<sup>3</sup>. (For cars with automatic gearbox - Depress the brake pedal.)
3. Press the **START/STOP ENGINE** button and then release it.

### i NOTE

For diesel-engined cars, there may be a slight delay before the engine can be started - **Engine preheating** is displayed in the meantime.

When the engine is started the starter motor works until the engine is started or until its overheating protection triggers.

### ! IMPORTANT

If the engine fails to start after 3 attempts - wait for 3 minutes before making a further attempt. Starting capacity increases if the battery is allowed to recover.

### ! WARNING

Never remove the remote control key from the ignition switch after starting the engine or when the car is being towed.

### ! WARNING

Always remove the remote control key from the ignition switch when leaving the car, and make sure that the key position is **0** - in particular if there are children in the car. For information on how this works - see Key positions (p. 74).

### i NOTE

The idling speed can be noticeably higher than normal for certain engine types during cold starting. This is done in order that the emissions system can reach normal operating temperature as quickly as possible, which minimises exhaust emissions and protects the environment.

### Keyless drive\*

Follow steps 2-3 for keyless (p. 166) starting of the engine.

<sup>3</sup> If the car is moving then it is enough to press the **START/STOP ENGINE** button to start the engine.

\* Option/accessory, for more information, see Introduction.



### NOTE

A prerequisite for the engine to start is that one of the car's remote control keys with the Keyless drive function is in the passenger compartment or cargo area.

### WARNING

**Never** remove the remote control key from the car while driving or during towing.

#### Related information

- Switching off the engine (p. 253)

### Switching off the engine

*The engine is switched off using the **START/STOP ENGINE** button.*

To stop the engine:

- Press **START/STOP ENGINE** - the engine stops.

If the gear selector is not in **P** position or if the car is moving:

- Press twice on **START/STOP ENGINE** or hold the button depressed until the engine stops.

#### Related information

- Key positions (p. 74)

### Steering lock

*The steering lock makes steering difficult if the car is e.g. taken unlawfully.*

#### Function

- The steering lock unlocks when the remote control key is in the ignition switch<sup>4</sup> and the **START/STOP ENGINE** button is depressed.
- The steering lock locks when the driver's door is opened after the engine has been switched off.

A mechanical noise can be perceived when the steering lock unlocks or locks.

#### Related information

- Starting the engine (p. 252)
- Key positions (p. 74)
- Steering wheel (p. 79)

<sup>4</sup> Cars with Keyless drive only need to have a remote control key inside the passenger compartment.



## Remote start (ERS)\*

Remote start (ERS – Engine Remote Start) means that the car's engine can be started remotely in order to warm up/cool down the passenger compartment before departure. ERS is activated via key and/or via Volvo On Call\*, see Volvo On Call supplement.

The climate control starts with the same settings that were being used when the car was parked.

An ERS-started engine is activated for a maximum of 15 minutes, then it is switched off. After two ERS-activations the engine must be started in the normal way before ERS can be re-used.

ERS is only available in cars with automatic gearbox and cars that have a bonnet switch<sup>5</sup> installed.

### **i** NOTE

The service life of the remote control key's battery is affected by the ERS function. In the event of frequent use of ERS the battery should therefore be changed once per year, see Remote control key - replacing the battery (p. 165).

### **i** NOTE

Follow local/national rules/regulations on idling.

### **!** WARNING

To remote-start the engine, the following criteria must be met:

- The car must be supervised.
- There must be no people or animals inside or around the car.
- The car must not be parked in a closed, unventilated area - the exhaust gases may seriously injure humans and animals.

### Related information

- Remote start (ERS) - operation (p. 254)
- Remote start (ERS) - symbols and messages (p. 256)

## Remote start (ERS) - operation

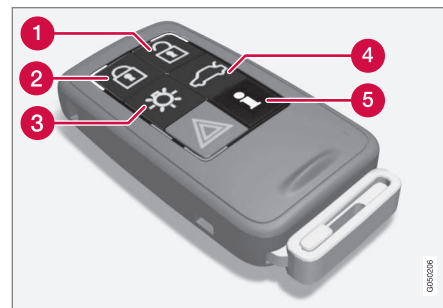

The key's buttons for remote start.

- 1 Unlocking
- 2 Locking
- 3 Approach lighting
- 4 Unlocking, boot lid
- 5 Information<sup>6</sup>

### Remote starting the engine

To be able to remotely start the engine the car must be locked and the bonnet closed.

Proceed as follows:

<sup>5</sup> Available in the XC60, cars with alarm, most cars with 4-cylinder engines or if ERS is selected for new construction.

<sup>6</sup> Only on PCC key, see Remote control key with PCC\* - unique functions (p. 160).

\* Option/accessory, for more information, see Introduction.





1. Briefly press on the key's button (2).
2. Follow this immediately afterwards with a long press - at least 2 seconds - on button (3).

If the conditions for ERS are fulfilled then the following takes place:

1. The direction indicators flash quickly several times.
2. The engine starts.
3. The direction indicators illuminate with a constant glow for 3 seconds to verify that the engine has started.

#### NOTE

After remote starting, the car continues to be locked but with deactivated movement detector\*.

#### With PCC<sup>7</sup> key



The light indication for Approach lighting<sup>8</sup> flashes several times when the button is pressed and then goes to constant glow if all criteria for ERS have been fulfilled. However, this does not mean that ERS has started the engine.

To check whether ERS has started the engine, the user can press the button (5) - if the engine has started, there is a light indication by the buttons (2) and (3).

#### Active functions

The following functions are activated with a remote started engine:

- Ventilation system
- Audio/video system
- Approach lighting.

#### Deactivated functions

The following functions are deactivated with a remote started engine:

- headlamps
- Position lamps
- Number plate lighting
- Windscreen wiper.

#### ERS is interrupted

The following steps switch off an ERS-started engine:

- The remote control key's button (1), (2) or (4) is depressed
- The car is unlocked
- A door is opened
- Accelerator pedal or brake pedal is depressed
- The gear selector is moved out of **P** position
- Active ERS time exceeds 15 minutes.

When an ERS-started engine is switched off, the direction indicators illuminate with a constant glow for 3 seconds.

#### Related information

- Remote start (ERS)\* (p. 254)
- Remote start (ERS) - symbols and messages (p. 256)

<sup>7</sup> For more information on the PCC key, see Remote control key with PCC\* - unique functions (p. 160).

<sup>8</sup> For more information on Approach lighting, see Remote control key - functions (p. 158) and Approach lighting (p. 91).



## Remote start (ERS) - symbols and messages

In situations where the ERS function fails or is interrupted, a symbol is shown in the combined instrument panel, supplemented by an explanatory text message.

### ERS function unavailable

Message	Specification
No remote start Too many tries	ERS unavailable because a maximum of 2 ERS activations in succession are allowed.
No remote start Low fuel level	ERS unavailable because fuel level too low.
No remote start Gear not in P	ERS unavailable because gear selector is not in P position.
No remote start Driver in car	ERS unavailable because someone is in the passenger compartment.
No remote start Low battery	ERS unavailable due to low battery voltage. Charge the battery by starting the engine.

Message	Specification
No remote start Engine warning	ERS unavailable due to warning message from engine. Contact a workshop <sup>A</sup> .
No remote start Engine coolant level low	ERS unavailable due to error message from cooling system, see Coolant - level (p. 349).
No remote start Door open	ERS unavailable because a door/boot lid was not closed.
No remote start Bonnet open	ERS did not activate because the bonnet was not closed.
No remote start Car not locked	ERS unavailable because the car was not locked.
No remote start Key in car	ERS did not activate because the key was in the car.

<sup>A</sup> An authorised Volvo workshop is recommended.

### Interrupted ERS function

Message	Specification
Remote start off Gear not in P	ERS interrupted because gear selector is not in P position.
Remote start off Driver in car	ERS interrupted because someone is in the passenger compartment.
Remote start off Engine warning	ERS interrupted due to error message from engine. Contact a workshop <sup>A</sup> .
No remote start Engine coolant level low	ERS interrupted due to error message from cooling system.
Remote start off Bonnet open	ERS interrupted because the bonnet is open.
Remote start off Low battery	ERS interrupted since the battery voltage is too low.
Remote start off Low fuel level	ERS interrupted since the fuel level is too low.

<sup>A</sup> An authorised Volvo workshop is recommended.



### Related information

- Remote start (ERS)\* (p. 254)
- Remote start (ERS) - operation (p. 254)

### Starting the engine – Flexifuel

*Flex-fuel engines can be driven on 95 octane unleaded petrol and bioethanol E85. The engine is started in the same way as in a petrol-driven car.*

### Engine block heater\*

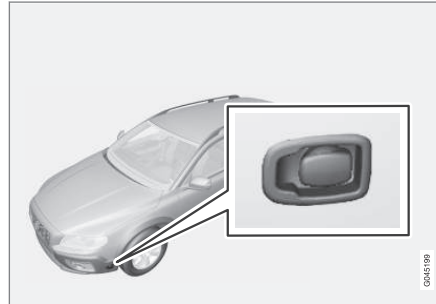

*Electrical input to the engine block heater.*

Cars intended for E85 have an electric engine block heater\*. Starting and driving with a pre-heated engine involves significantly lower emissions and reduced fuel consumption. For this reason you should aim to use the engine block heater throughout the winter months.

- In outside temperatures between +5 °C and -10° C the electric engine block heater should be plugged in for at least 1 hour.
- In outside temperatures between -10 °C and -20° C the electric engine

block heater should be plugged in for at least 2 hours.

- In outside temperatures lower than -20° C the electric engine block heater should be plugged in for at least 3 hours.

### WARNING

The engine block heater is powered by high voltage. Fault tracing and repair of an electric engine block heater and its electrical connections must only be carried out by a workshop - an authorised Volvo workshop is recommended.

### NOTE

Points to remember for carrying reserve fuel:

- In the event of stalling due to an empty fuel tank, bioethanol E85 from a reserve fuel can may make the engine difficult to start in extreme cold. This is avoided by filling the reserve fuel can with 95 octane petrol.

For more information on Flexifuel's bioethanol E85 fuel, see Fuel - bioethanol E85 (p. 293).

### In the event of starting difficulties

If the engine does not start at the first start attempt:

\* Option/accessory, for more information, see Introduction.





## 08 Starting and driving



- Make further attempts to start with the **START/STOP ENGINE** button.
- Check that the engine block heater has been plugged in and, where appropriate, connect it for the time indicated above.

### **!** IMPORTANT

If the engine does not start despite repeated start attempts, you are recommended to contact an authorised Volvo workshop.

### Fuel adaptation

Flexifuel engines can be driven on both 95 octane unleaded petrol and bioethanol E85. Both fuels are filled in the common fuel tank so that any variations of mixing ratios between these two fuels is possible.

If the fuel tank is filled with petrol after the car has been driven on bioethanol E85 (or vice versa) then the engine may run slightly unevenly for a time. For this reason it is important to allow the engine to accustom itself (adapt) to the new fuel mixture.

Adaptation takes place automatically when the car is driven for a short period at an even speed.

### **!** IMPORTANT

After the fuel mixture in the tank has been changed an adaptation should be made by driving at an even speed for about 15 minutes.

If the starter battery has been discharged or disconnected then a slightly longer period of driving is required for the adaptation as the memory for the electronics has been cleared.

### Related information

- Jump starting with battery (p. 258)
- Starting the engine (p. 252)

### Jump starting with battery

*If the starter battery (p. 361) is discharged then the car can be started with current from another battery.*

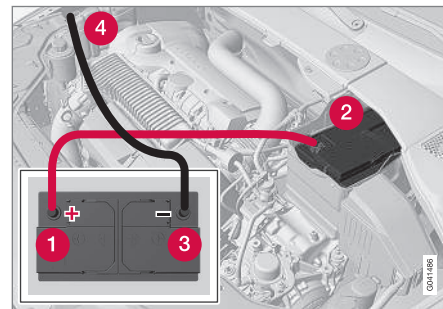

When jump starting the car, the following steps are recommended to avoid short circuits or other damage:

1. Set the car's electrical system in key position **0**, see Key positions - functions at different levels (p. 74).
2. Check that the donor battery has a voltage of 12 V.
3. If the donor battery is installed in another car - switch off the donor car's engine and make sure that the two cars do not touch each other.



4. Connect one of the red jump lead's clamps to the donor battery's positive terminal (1).

### IMPORTANT

Connect the start cable carefully to avoid short circuits with other components in the engine compartment.

5. Open the clips on the front cover of the battery in your car and remove the cover, see Starter battery - replacement (p. 363).
6. Connect the red jump lead's other clamp onto the car's positive terminal (2).
7. Connect one of the black jump lead's clamps to the donor battery's negative terminal (3).
8. Connect the other clamp to a grounding point, e.g. right-hand engine mounting at the top, the outer screw head (4).
9. Check that the jump lead clamps are affixed securely so that there are no sparks during the starting procedure.
10. Start the engine of the "donor car" and allow it to run a few minutes at a speed slightly higher than idle approx. 1500 rpm.

11. Start the engine in the car with the discharged battery.

### IMPORTANT

Do not touch the crocodile clips during the start procedure. There is a risk of sparks forming.

12. Remove the jump leads in reverse order - first the black and then the red.
  - > Make sure that none of the black jump lead's clamps comes into contact with the battery's positive terminal or the clamp connected to the red jump lead!

### WARNING

- The battery can generate oxyhydrogen gas, which is highly explosive. A spark can be formed if a jump lead is connected incorrectly, and this can be enough for the battery to explode.
- The battery contains sulphuric acid, which can cause serious burns.
- If sulphuric acid comes into contact with eyes, skin or clothing, flush with large quantities of water. If acid splashes into the eyes - seek medical attention immediately.

#### Related information

- Starting the engine (p. 252)

#### Gearboxes

There are two main types of gearbox. Manual gearbox and automatic gearbox.

- Manual gearbox (p. 260)
- Automatic gearbox - Geartronic (p. 261) and Powershift (p. 265)

### IMPORTANT

To prevent damage to any drive system components, the working temperature of the gearbox is checked. If there is a risk of overheating, a warning symbol is illuminated in the combined instrument panel in conjunction with a text message being shown. Follow the recommendation given in the text message.

#### Related information

- Automatic gearbox -- Geartronic\* (p. 261)



## Manual gearbox

The function of the gearbox is to change the gear ratio depending on speed and power requirements.

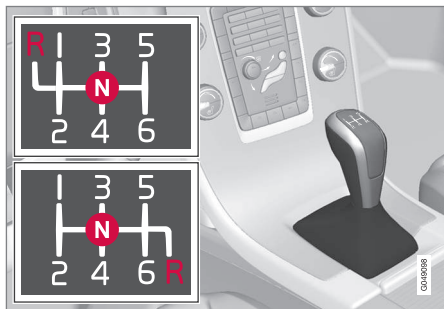

Gearshift pattern 6-speed gearbox.

The 6-speed box is available in two versions - reverse gear position differs between them. Look at the actual gearshift pattern imprinted on the gear lever.

- Depress the clutch pedal fully during each gear change.
- Take your foot off the clutch pedal between gear changes.

### WARNING

Always apply the parking brake when parking on a slope - leaving the car in gear is not sufficient to hold the car in all situations.

## Reverse gear inhibitor

The reverse gear inhibitor hinders the possibility of mistakenly attempting to engage reverse gear during normal forward travel.

- Follow the gearing pattern printed on the gear lever and start from neutral position, **N** before moving it to **R** position.
- Engage reverse gear only when the car is stationary.

### NOTE

With the upper variant of the shifting pattern for 6-speed gearbox (see previous illustration) - **first press down** the gear lever in the **N** position in order to engage reverse gear.

## Related information

- Gearboxes (p. 259)

## Gear shift indicator\*

The gear shift indicator notifies the driver when it is appropriate to engage the next higher or lower gear.

An essential detail in connection with environmental driving is to drive in the right gear and to change gear in plenty of time.

An indicator is available as an aid on some variants - GSI (Gear Shift Indicator) - which notifies the driver when it is appropriate to engage the next higher or lower gear in order to obtain the lowest possible fuel consumption.

However, taking into consideration characteristics such as performance and vibration-free running, it may be advantageous to change gear at a higher engine speed. The framed number indicates the current gear.

## Manual gearbox

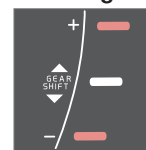

Gear shift indicator for manual gearbox. Only one marker is illuminated at a time - during normal driving it is only illuminated in the centre.

When gearing up/down as recommended, the upper one is illuminated at "+" or the lower at "-", marked red in the illustration.



### Automatic gearbox



Combined instrument panel "Digital" with gear shift indicator.

The framed number indicates the current gear.



With "Analogue" combined instrument panel, the gear positions and indicator arrows are displayed in its centre.

### Related information

- Manual gearbox (p. 260)
- Automatic gearbox -- Geartronic\* (p. 261)

### Automatic gearbox -- Geartronic\*

The Geartronic gearbox has two different gear modes - Automatic and Manual.



**D:** Automatic gear positions. **+/-:** Manual gear positions. **S:** Sport mode\*.

Combined instrument panel (p. 59) shows the position of the gear selector using the following indications: **P, R, N, D, S\*, 1, 2, 3** etc.

### Gear positions

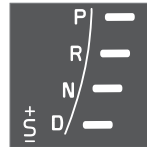

Automatic gear positions are indicated to the right of the combined instrument panel. (Only one marker is illuminated at a time - the one showing the current gear selector position.)

Symbol "S" for Sport mode is ORANGE when the mode is active.

### Parking position - P

Select position **P** when starting the engine or when the car is parked.

- In order to be able to move the gear selector from **P**-position, the brake pedal must first be depressed firmly.

The gearbox is mechanically blocked when the **P** position is engaged. Also apply the parking brake (p. 282), as a precaution.

### NOTE

The gear selector must be in **P** position to allow the car to be locked and alarmed.

### IMPORTANT

The car must be stationary when position **P** is selected.

### WARNING

Always apply the parking brake when parking on a slope - the automatic transmission's **P** position is not sufficient to hold the car in all situations.

### Reverse position - R

The car must be stationary when **R** position is selected.





## Neutral position - N

No gear is engaged and the engine can be started. Apply the parking brake if the car is stationary with the gear selector in **N** position.

## Drive position - D

**D** is the normal driving position. Shifting up and down takes place automatically based on the level of acceleration and speed. The car must be stationary when the gear selector is moved to **D** position from **R** position.

## Geartronic – Manual gear positions (+S-)

The driver can also change gear manually using the Geartronic automatic gearbox. The car engine-brakes when the accelerator pedal is released.



The manual gear position is reached by moving the lever to the side from position **D** to the end position at "+S-". The combined instrument panel's symbol "+S-" changes colour from WHITE to ORANGE and the digits **1, 2, 3** etc. are displayed in a box, corresponding to the gear that has just been selected.

- Move the lever forwards towards "+" (plus) to change up a gear and release the lever, which returns to its rest position between + and -.

or

- Pull the lever back towards "-" (minus) to change down a gear and release it.

The manual gearshift mode "+S-" can be selected at any time while driving.

Geartronic automatically shifts down if the driver allows the speed to decrease lower than a level suitable for the selected gear, in order to avoid jerking and stalling.

To return to automatic driving mode:

- Move the lever to the side to the end position at **D**.

### NOTE

If the gearbox has a Sport programme then the gearbox will only become manual after the gear selector has been moved forwards or backwards in its "+S-" position. The combined instrument panel then changes indication from **S** to show which of the gears **1, 2, 3** etc. is engaged.

## Paddles\*

As a supplement to manual gear changing with the gear selector there are also controls located on the steering wheel, so-called "paddles".

To be able to change gear with the steering wheel paddles they must first be activated. This is by means of pulling one of the paddles toward the steering wheel - the combined instrument panel then changes indication from "**D**" to a figure, which indicates the current gear.

To then change gear one step:

- Pull one of the paddles backwards - towards the steering wheel - and release.



Both steering wheel "paddles".

- 1** "-": Selects the next lower gear.
- 2** "+": Selects the next higher gear.

A gear change occurs at each pull of the paddle provided that the engine speed does not leave the permitted range.

After each gear change the combined instrument panel changes figure to show the current gear.





## NOTE

### Automatic deactivation

If the steering wheel paddles are not used then they are deactivated after a short time - this is indicated when the combined instrument panel switches indication, from the figure for the current gear back to "D".

The exception is during engine braking - then the paddles are activated as long as engine braking is in progress.

### Manual deactivation

The steering wheel paddle shifters can also be deactivated manually:

- Pull both paddles toward the steering wheel and hold until the combined instrument panel changes character from the figure for the current gear to "D".

The paddles can also be used with the gear selector in Sport mode\* - then the paddles are constantly activated without being deactivated.

### Geartronic - Sport mode\* (S)<sup>9</sup>



The Sport programme provides sportier characteristics and allows higher engine speed for the gears.

At the same time it responds more quickly to acceleration. During active driving, the use of a lower gear is prioritised, leading to a delayed upshift.

To activate Sport mode:

- Move the gear selector to the side from **D** position to the end position at "+S-" - the combined instrument panel changes indication from **D** to **S**.

Sport mode can be selected at any time while driving.

### Geartronic - Winter mode

It can be easier to pull away on slippery roads if 3rd gear is engaged manually.

1. Depress the brake pedal and move the gear selector from **D** position to the end position at "+S-" - the combined instrument panel changes indication from **D** to the figure 1<sup>10</sup>.
2. Scroll up to gear 3 by pushing the lever forward towards "+" (plus) twice - the display shifts the indication from 1 to 3.
3. Release the brake and accelerate carefully.

The gearbox "winter mode" means that the car moves off with a lower engine speed and reduced engine power on the drive wheels.

### Kick-down

When the accelerator pedal is pressed all the way to the floor (beyond the position normally regarded as full acceleration) a lower gear is immediately engaged. This is known as kick-down.

If the accelerator is released from the kick-down position, the gearbox automatically changes up.

Kick-down is used when maximum acceleration is needed, such as for overtaking.

### Safety function

To prevent overrevving the engine, the gearbox control program has a protective downshift inhibitor which prevents the kick-down function.

Geartronic does not permit downshifting/kick-down which would result in an engine speed high enough to damage the engine. Nothing happens if the driver still tries to shift down in this way at high engine speed - the original gear remains engaged.

When kick-down is activated the car can change one or more gears at a time depending on engine speed. The car changes up

<sup>9</sup> With some engines only.

<sup>10</sup> If the car has Sport mode\* then "S" is shown first.





when the engine reaches its maximum speed in order to prevent damage to the engine.

### **Towing**

If the car has to be towed - see important information in the section Towing (p. 301).

### **Related information**

- Transmission fluid - grade and volume (p. 400)
- Automatic gearbox -- Powershift\* (p. 265)
- Gearboxes (p. 259)



### Automatic gearbox -- Powershift\*

The Powershift automatic gearbox transmits the motive force from the engine to the drive wheels with double mechanical clutch discs, as opposed to Geartronic which instead uses a hydraulic torque converter.



**D:** Automatic gear positions. **+S-:** Manual gear positions. **S:** Sport mode\*.

Powershift transmission operates in the same way and has similar controls and functions as the Geartronic automatic transmission.

One exception is the function "Geartronic - Winter mode" (p. 261):

- Powershift enables driving away on a slippery road surface if **2nd** gear is engaged manually - instead of 3rd gear with Geartronic.

### Towing

The model with Powershift transmission should not be towed as it is dependent on the engine running in order to receive sufficient lubrication. If towing (p. 301) still has to take place, the route must be as short as possible and then at very low speed.

In the event of uncertainty as to whether the car is equipped with Powershift or Geartronic transmission, this can be verified by checking the designation on the gearbox label under the bonnet, Type designations (p. 387). The designation "MPS6" means that it is Powershift transmission - otherwise it is Geartronic automatic transmission.

See also important information in section Towing (p. 301).

### To bear in mind

The transmission's double clutch has overload protection that is activated if it becomes too hot, e.g. if the car is held stationary with the accelerator pedal on an uphill gradient for a long time.

Overheated transmission causes the car to shake and vibrate, and the warning symbol illuminates and the combined instrument panel shows a message. The transmission

can also overheat during slow driving in queues (10 km/h or slower) on an uphill gradient, or with a trailer hitched. The transmission cools down when the car is stationary, with foot brake depressed and the engine running at idling speed.

Overheating during slow driving in queues can be avoided by driving in stages:

- Stop the car and wait with your foot on the brake pedal until there is a moderate distance to the traffic ahead, drive forward a short distance, and then wait another moment with your foot on the brake pedal.

### ! IMPORTANT

Use the foot brake to hold the car stationary on an uphill gradient - do not hold the car with the accelerator pedal. The gearbox could then overheat.

### Text message and action

In some situations the combined instrument panel may show a text message at the same time as a symbol is illuminated.

\* Option/accessory, for more information, see Introduction.





# 08 Starting and driving



Symbol	Message	Driving characteristics	Action
	Transmission hot Brake to hold	Difficulty in maintaining even speed at constant engine speed.	Transmission overheated. Keep the car stationary using the foot brake. <sup>A</sup>
	Transmission hot Park safely Let engine run	Significant pulling in the car's traction.	Transmission overheated. Park the car immediately in a safe manner. <sup>A</sup>
	Transmission cooling Let engine run	No drive due to overheated gearbox.	Transmission overheated. For fastest cooling: Run the engine at idling speed with the gear lever in the <b>N</b> or <b>P</b> position until the message clears.

<sup>A</sup> For fastest cooling: run the engine at idling speed with the gear lever in the **N** or **P** position, until the message clears.

The table shows three steps with an increased degree of seriousness should the transmission become too hot. In parallel with the text message, the driver is also advised that the car's electronics are temporarily changing the driving characteristics. Follow the instructions in the text message where appropriate.

## NOTE

The examples in the table are no indication of the car being defective, but show that a safety function has been activated with a view to preventing damage to any of the car's components.

## WARNING

If a warning symbol combined with the text **Transmission hot Park safely Let engine run** is ignored then the heat in the gearbox may become so high that the power transmission between engine and gearbox is temporarily halted in order to prevent the clutch from malfunctioning - the car then loses drive and is stationary until gearbox temperature has cooled to an acceptable level.

For more possible text messages with their respective proposals for solutions concerning automatic gearbox, see Messages (p. 106).

A text message extinguishes automatically after the action has been carried out or after one press on the indicator stalk **OK** button.

## Related information

- Automatic gearbox -- Geartronic\* (p. 261)



## Gear selector inhibitor

There are two different types of gear selector inhibitor - mechanical and automatic.

### Mechanical gear selector inhibitor

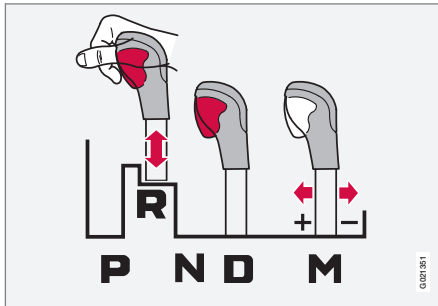

M: Manual shifting<sup>11</sup> - "+/-" or "Sport" mode.

The gear selector can be moved forward and back freely between **N** and **D**. Other positions are locked with a latch that is released with the inhibitor button on the gear selector.

With the inhibitor button depressed the lever can be moved forwards or backwards between **P**, **R**, **N** and **D**.

### Automatic gear selector inhibitor

The automatic gearbox has special safety systems:

#### Parking position (P)

Stationary car with engine running:

- Keep your foot on the brake pedal when moving the gear selector to another position.

#### Electric gear inhibitor – Shiftlock Parking position (P)

To be able to move the gear selector from **P** to other gear positions, the brake pedal must be depressed and the remote control key must be in key position **II** (p. 74).

#### Shiftlock – Neutral (N)

If the gear selector is in **N** position and the car has been stationary for at least 3 seconds (irrespective of whether the engine is running) then the gear selector is locked.

To be able to move the gear selector from **N** to other gear positions, the brake pedal must be depressed and the remote control key must be in key position **II**, see Key positions (p. 74).

## Deactivate automatic gear selector inhibitor



If the car cannot be driven, e.g. due to a flat starter battery, the gear selector must be moved from the **P** position so that the car can be moved.

- 1 Lift the rubber mat in the compartment behind the centre console and locate a hole<sup>12</sup> for the key blade (p. 162) in the bottom of the compartment.
- 2 Search for a spring-loaded button down in the hole with the key blade; depress the button with the blade and hold.
- 3 Move the gear selector from the **P** position and pull up the key blade.
4. Set the rubber mat back in place.

<sup>11</sup> The illustration is schematic.

<sup>12</sup> There may be 2 holes - one for the key blade and one that fixes the rubber mat.



### Related information

- Automatic gearbox -- Geartronic\* (p. 261)
- Automatic gearbox -- Powershift\* (p. 265)

### Hill start assist (HSA)\*<sup>13</sup>

*The foot brake can be released before setting off or reversing uphill - the HSA (Hill Start Assist) function means that the car does not roll backwards.*

The function means that the pedal pressure in the brake system remains for several seconds while the driver's foot is moved from brake pedal to accelerator pedal.

The temporary braking effect releases after several seconds or when the driver accelerates.

### Related information

- Starting the engine (p. 252)

### Start/Stop\*

*Some engine and gearbox combinations come fitted with a Start/Stop function which engages in the event of e.g. stationary traffic or waiting at traffic lights - the engine is then switched off temporarily and restarts automatically when the journey is due to continue.*

Environmental care is one of Volvo Car Corporation's core values and it influences all of our operations. This target orientation has resulted in several separate energy-saving functions of which Start/Stop is one, all with the collective task of reducing fuel consumption, which in turn helps to reduce exhaust emissions.

### General information on Start/Stop



*The engine is switched off - it becomes quieter and cleaner.*

<sup>13</sup> Depends on engine and gearbox combination. HSA not possible with some combinations.

\* Option/accessory, for more information, see Introduction.



The Start/Stop function gives the driver the opportunity for a more active environmentally conscious way of driving the car by means of being able to allow the engine to stop automatically, whenever appropriate.

### Manual or Automatic

Note that there are differences in the Start/Stop function depending on whether the gearbox is manual or automatic.

### Related information

- Start/Stop\* - function and operation (p. 269)
- Starting the engine (p. 252)
- Start/Stop\* - settings (p. 274)
- Start/Stop\* - the engine does not auto-start (p. 273)
- Start/Stop\* - the engine auto-starts (p. 272)
- Start/Stop\* - the engine does not stop (p. 271)
- Start/Stop\* - involuntary stop manual gearbox (p. 274)
- Start/Stop\* - symbols and messages (p. 275)
- Battery - Start/Stop (p. 365)

### Start/Stop\* - function and operation

*The Start/Stop function is activated automatically when the engine is started with the key.*



The Start/Stop function is activated automatically when the engine is started with the key. The driver is made aware of this by the function's symbol illuminating in the combined instrument panel and the On/Off button lamp illuminating.



All of the car's normal systems such as lighting, radio, etc. work as normal even with an engine that has stopped automatically, except that some equipment may have the function temporarily reduced, e.g. the climate control system's fan speed or extremely high volume on the audio system.

### Auto-stopping the engine

The following is required for the engine to auto-stop:

Conditions	M/A A
Declutch, set the gear lever in neutral position and release the clutch pedal - the engine stops automatically.	M
Stop the car with the foot brake and then keep your foot on the pedal - the engine stops automatically.	A

A M = Manual gearbox, A = Automatic gearbox.



If the ECO function is activated then the engine may auto-stop before the car is completely stationary.



As verification and reminder that the engine is auto-stopped the combined instrument panel's symbol for the Start/Stop function illuminates.



## Auto-starting the engine

Conditions	M/ A <sup>A</sup>
With the gear lever in neutral position:  1. Depress the clutch pedal or press the accelerator pedal - the engine starts.  2. Engage a suitable gear and drive.	M
Release the foot pressure on the foot brake - the engine starts automatically and the journey can continue.	A
Maintain foot pressure on the foot brake and depress the accelerator pedal - the engine auto-starts.	A
The following option is also available on a downhill gradient:  Release the foot brake and let the car move off - the engine starts automatically when the speed exceeds normal walking pace.	M + A

<sup>A</sup> M = Manual gearbox, A = Automatic gearbox.

## Deactivating the Start/Stop function



In certain situations, it may be advisable to temporarily switch off the automatic Start/Stop function - this is carried out with a push of this button.



Disengaged function is indicated by the combined instrument panel's Start/Stop symbol and the On/Off button's lamp extinguishing.

The Start/Stop function is disengaged until it is reactivated with the button or until the next time the engine is started with the key.

## Start assistance HSA

The foot brake can also be released on an uphill slope to auto-start the engine - the HSA (p. 268) (Hill Start Assist) function prevents the car from rolling backwards.

HSA means that the pressure in the brake system remains temporarily available while the driver moves his/her foot from the brake pedal to the accelerator pedal for driving off with the engine having stopped automatically. The temporary braking effect releases after a couple of seconds or when the driver accelerates.

## Related information

- Start/Stop\* (p. 268)
- Starting the engine (p. 252)

- Start/Stop\* - settings (p. 274)
- Start/Stop\* - the engine does not auto-start (p. 273)
- Start/Stop\* - the engine auto-starts (p. 272)
- Start/Stop\* - the engine does not stop (p. 271)
- Start/Stop\* - involuntary stop manual gearbox (p. 274)
- Start/Stop\* - symbols and messages (p. 275)
- Battery - Start/Stop (p. 365)





### Start/Stop\* - the engine does not stop

Although the Start/Stop function is activated, the engine does not always stop automatically.

The engine does not auto-stop if:

Conditions	M/A A
the car has not first achieved approx. 8 km/h after a key start or the last auto-stop.	M + A
the driver has opened the seat-belt's buckle.	M + A
the capacity of the starter battery is below the minimum permissible level.	M + A
the engine does not have normal operating temperature.	M + A
ambient temperature is around freezing point or above approx. 30 °C.	M + A
the windscreen's electric heating is activated.	M + A
the environment in the passenger compartment differs from the pre-set values - indicated by the ventilation fan running at a high speed.	M + A

Conditions	M/A A
the car is reversed.	M + A
the starter battery temperature is below the freezing point or is too high.	M + A
the driver makes greater steering wheel movements.	M + A
the exhaust system's particulate filter is full - the temporarily disengaged Start/Stop function is reactivated as soon as an automatic cleaning cycle has been performed (see Diesel particle filter (DPF) (p. 294)).	M + A
the road is very steep.	M + A
a trailer is connected electrically to the car's electrical system.	M + A
the bonnet has been opened <sup>B</sup> .	M + A
the gearbox does not have normal operating temperature.	A

Conditions	M/A A
the atmospheric air pressure is less than equivalent to 1500-2500 metres above sea level - the current air pressure varies with the prevailing weather conditions.	A
adaptive cruise control Queue Assist is activated.	A
the gear selector is in <b>S</b> position <sup>C</sup> or "+/-".	A

A M = Manual gearbox, A = Automatic gearbox.

B With certain engines only.

C Sport mode.

### Related information

- Start/Stop\* (p. 268)
- Start/Stop\* - function and operation (p. 269)
- Starting the engine (p. 252)
- Start/Stop\* - settings (p. 274)
- Start/Stop\* - the engine does not auto-start (p. 273)
- Start/Stop\* - the engine auto-starts (p. 272)
- Start/Stop\* - involuntary stop manual gearbox (p. 274)





- Start/Stop\* - symbols and messages (p. 275)
- Battery - Start/Stop (p. 365)

## Start/Stop\* - the engine auto-starts

*An auto-stopped engine may restart in certain cases without the driver having decided that the journey should continue.*

In the following cases the engine also starts automatically if the driver has not depressed the clutch pedal (manual gearbox) or takes his/her foot off the brake pedal (automatic gearbox):

Conditions	M/A <sup>A</sup>
Misting forms on the windows.	M + A
The environment in the passenger compartment deviates from the preset values.	M + A
There is a temporarily high current take-off or starter battery capacity drops below the lowest permissible level.	M + A
Repeated pumping of the brake pedal.	M + A
The bonnet is opened <sup>B</sup> .	M + A
The car starts to roll, or there is a small increase in speed if the car auto-stopped without being completely stationary.	M + A

Conditions	M/A <sup>A</sup>
The driver's seatbelt buckle is opened with the gear selector in <b>D</b> or <b>N</b> position.	A
Steering wheel movements <sup>B</sup> .	A
The gear selector is moved out of the <b>D</b> position to <b>S</b> position <sup>C</sup> , <b>R</b> or "+/-".	A
The driver's door is opened with the gear selector in <b>D</b> position - a "ping" sound and text message inform that the Start/Stop function is active.	A

A M = Manual gearbox, A = Automatic gearbox.

<sup>B</sup> With certain engines only.

<sup>C</sup> Sport mode.



## WARNING

Do not open the bonnet when the engine has stopped automatically - the engine may suddenly start automatically. First switch off the engine as normal using the **START/STOP ENGINE** button before opening the bonnet.

## Related information

- Start/Stop\* (p. 268)
- Start/Stop\* - function and operation (p. 269)
- Starting the engine (p. 252)



- Start/Stop\* - settings (p. 274)
- Start/Stop\* - the engine does not auto-start (p. 273)
- Start/Stop\* - the engine does not stop (p. 271)
- Start/Stop\* - involuntary stop manual gearbox (p. 274)
- Start/Stop\* - symbols and messages (p. 275)
- Battery - Start/Stop (p. 365)

### Start/Stop\* - the engine does not auto-start

*The engine does not always auto-start after having auto-stopped.*

In the following cases the engine does not auto-start after having auto-stopped:

Conditions	M/ A <sup>A</sup>
A gear is engaged without declutching - a display text prompts the driver to set the gear lever in neutral position in order to enable auto-start.	M
The driver is unrestrained, the gear selector is in <b>P</b> position and the driver's door is open - a normal engine start must take place.	A

<sup>A</sup> M = Manual gearbox, A = Automatic gearbox.

### Related information

- Start/Stop\* (p. 268)
- Start/Stop\* - function and operation (p. 269)
- Starting the engine (p. 252)
- Start/Stop\* - settings (p. 274)
- Start/Stop\* - the engine auto-starts (p. 272)
- Start/Stop\* - the engine does not stop (p. 271)

- Start/Stop\* - involuntary stop manual gearbox (p. 274)
- Start/Stop\* - symbols and messages (p. 275)
- Battery - Start/Stop (p. 365)



## Start/Stop\* - involuntary stop manual gearbox

In the event that a start-up fails and the engine stops, proceed in accordance with the below:

1. Depress the clutch pedal again - the engine starts automatically.
2. In certain cases the gear lever must be set in neutral position. The combined instrument panel then shows the text **Put gear in neutral**.

### Related information

- Start/Stop\* (p. 268)
- Start/Stop\* - function and operation (p. 269)
- Starting the engine (p. 252)
- Start/Stop\* - settings (p. 274)
- Start/Stop\* - the engine does not auto-start (p. 273)
- Start/Stop\* - the engine auto-starts (p. 272)
- Start/Stop\* - the engine does not stop (p. 271)
- Start/Stop\* - symbols and messages (p. 275)
- Battery - Start/Stop (p. 365)

## Start/Stop\* - settings

The car's MY CAR menu system, under the **DRIVE** heading, contains information about Volvo's Start/Stop system, as well as recommendations for energy-saving driving techniques.



### Related information

- Start/Stop\* (p. 268)
- Start/Stop\* - function and operation (p. 269)
- Starting the engine (p. 252)
- Start/Stop\* - the engine does not auto-start (p. 273)
- Start/Stop\* - the engine auto-starts (p. 272)
- Start/Stop\* - the engine does not stop (p. 271)
- Start/Stop\* - involuntary stop manual gearbox (p. 274)

- Start/Stop\* - symbols and messages (p. 275)
- Battery - Start/Stop (p. 365)









### Start/Stop\* - symbols and messages

The Start/Stop function can show text messages in the combined instrument panel.

### Text message

 In combination with this indicator lamp the Start/Stop function may show text messages in the combined instrument panel for certain situations.

For some of them there is a recommended action that should be performed. The following table shows some examples.

Symbol	Message	Info/Action	M/A <sup>A</sup>
	Auto Start/Stop Service required	Start/Stop is not operational. Contact a workshop - an authorised Volvo workshop is recommended.	M + A
	Autostart Engine running + acoustic signal	Activated if the driver's door is opened with auto-stopped engine and the gear selector in <b>D</b> position.	A
	Press start button	The engine will not start automatically - start the engine as normal with the <b>START/STOP ENGINE</b> button.	M + A
	Depress clutch pedal to start	The engine is ready to auto-start - waiting for the clutch pedal to be depressed.	M
	Depress brake and clutch pedals to start	The engine is ready to auto-start - waiting for the brake or clutch pedal to be depressed.	M
	Put gear in neutral to start	Gear is engaged without declutching - disengage and set the gear lever in neutral position.	M



Symbol	Message	Info/Action	M/A <sup>A</sup>
	Select P or N to start	Start/Stop has been deactivated - move the gear selector to <b>N</b> or <b>P</b> position and start the engine as normal with the <b>START/STOP ENGINE</b> button.	A
	Press start button	The engine will not start automatically - start the engine as normal with the <b>START/STOP ENGINE</b> button and the gear selector in <b>P</b> or <b>N</b> .	A

A M = Manual gearbox, A = Automatic gearbox.

If a message does not go out following completion of the action then a workshop should be contacted - an authorised Volvo workshop is recommended.

### Related information

- Start/Stop\* (p. 268)
- Start/Stop\* - function and operation (p. 269)
- Starting the engine (p. 252)
- Start/Stop\* - settings (p. 274)
- Start/Stop\* - the engine does not auto-start (p. 273)
- Start/Stop\* - the engine auto-starts (p. 272)
- Start/Stop\* - the engine does not stop (p. 271)
- Start/Stop\* - involuntary stop manual gearbox (p. 274)
- Battery - Start/Stop (p. 365)



## ECO\*

ECO<sup>14</sup> is an innovative Volvo function for automatic-gearbox cars, capable of reducing fuel consumption by up to 5%, depending on the driver's driving style. The function gives the driver the option of a more active environmentally conscious way of driving.

### General



The following are changed upon activation of the ECO function:

- Gearbox gearshift points.
- Engine management and response from the accelerator pedal.
- Start/Stop function - the engine can also auto-stop before the car has stopped down to being completely stationary.
- The Eco Coast function is activated - engine braking ceases.
- Climate control system settings - some electricity consumers are deactivated or operate at reduced power.

### NOTE

When the ECO function is activated, several parameters in the climate control system's settings are changed, and several electricity consumer functions are reduced. Certain settings can be reset manually, but full functionality is only restored by deactivating the ECO function.

### ECO - Operation

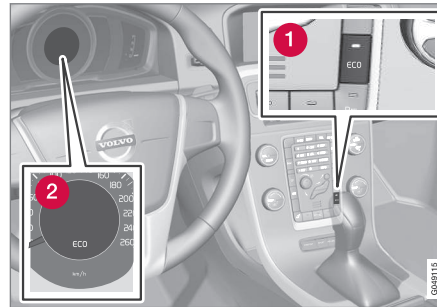

1 ECO On/Off

2 ECO symbol

The ECO function is deactivated when the engine is switched off, and must therefore be activated after each time the engine is started. There are exceptions for certain engines. However, it is easily verified by means of both the combined instrument

panel ECO symbol and the ECO button lamp illuminating when the function is activated.

### ECO function On or Off

ECO



Disengaged ECO function is indicated by the combined instrument panel ECO symbol and the ECO button lamp extinguishing. The function is then switched off until it is reactivated with the ECO button.

### Eco Coast - Function

The Eco Coast subfunction means in practice that engine braking is deactivated, meaning in turn that the car's kinetic energy is used to coast for longer distances. When the driver releases the accelerator pedal the gearbox is automatically disengaged from the engine whose speed is reduced to idling speed with minimum consumption.

This function is intended for use in the event of an anticipated reduction in speed, e.g. to coast forward to an intersection or a red light.

Eco Coast enables proactive driving where the driver can use the so-called "Pulse & Glide" technique and a minimum of braking.

### Combination On and Off

A combination of Eco Coast and temporarily deactivated ECO function can also collec-

<sup>14</sup> Not possible on the XC60 and XC70 with AWD.



tively contribute to reduced consumption. Accordingly:

- Active Eco Coast: Long coasting **without** engine braking = Low consumption and
- Deactivated ECO function: Short coasting **with** engine braking = Minimum consumption.

## NOTE

However, to achieve optimal low fuel consumption, Eco Coast in combination with short coasting distances should generally be avoided.

### Activating Eco Coast

The function is activated when the accelerator pedal is fully released, in combination with the following parameters:

- **ECO** button activated
- Gear selector in **D** position
- Speed within the range of approx. 65-140 km/h
- The road's downhill gradient is not steeper than approx. 6%.

### Deactivate Eco Coast

In certain situations it may be desirable to deactivate the Eco Coast function. Examples of such situations include:

- on steep downhill gradients - to be able to use engine braking.
- before an imminent overtaking manoeuvre - in order to be able to complete it in the safest possible way.

Deactivating Eco Coast and returning to engine braking can be performed as follows:

- Press the **ECO** button.
- Move the gear lever to manual "**S+/-**" position.
- Change gear with the steering wheel paddle shifters.
- Actuate the accelerator or brake pedal.

### Eco Coast - Limitations

The function is not available if:

- cruise control is activated
- the road's downhill gradient is steeper than approx. 6%
- manual gear changing is performed with the steering wheel paddle shifters\*
- engine and/or gearbox are not at normal operating temperature.
- the gear selector is moved from **D-** to "**S +/-**" position
- speed is outside the range of approx. 65-140 km/h

### More information and settings

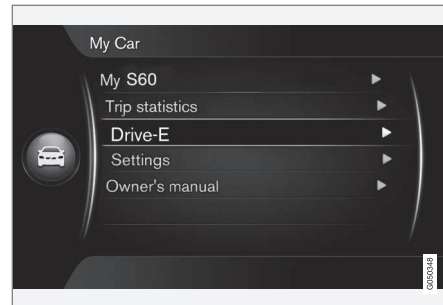

The car's menu system **MY CAR** contains further information on the ECO concept - see the section MY CAR (p. 108).

### Related information

- General information on climate control (p. 121)





### All Wheel Drive - AWD\*

Optimal traction is achieved with all-wheel drive.

#### All Wheel Drive is always available

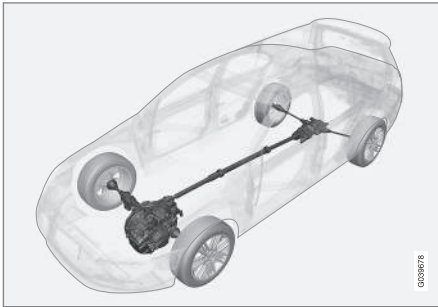

All Wheel Drive (All Wheel Drive) means that the car is driving all four wheels at the same time.

The power is automatically distributed between the front and rear wheels. An electronically controlled clutch system distributes the power to the wheels that have the best grip on the current road surface. This provides the best traction and prevents wheel spin. Under normal driving conditions, the majority of power is transmitted to the front wheels.

All Wheel Drive improves driving safety in rain, snow and icy conditions.

### Foot brake

The foot brake is used to reduce the car's speed while driving.

The car is equipped with two brake circuits. If a brake circuit is damaged then the brake pedal will engage deeper and a higher pressure on the pedal is needed to produce the normal braking effect.

The driver's brake pedal pressure is assisted by a brake servo.

#### WARNING

The brake servo only works when the engine is running.

If the foot brake is used when the engine is switched off then the pedal will feel stiff and a higher pedal pressure must be used to brake the car.

In very hilly terrain or when driving with a heavy load the brakes can be relieved by using engine braking. Engine braking is most efficiently used if the same gear is used downhill as up.

For more general information on heavy loads on the car, see Engine oil - adverse driving conditions (p. 396).

#### Cleaning the brake discs

Coatings of dirt and water on the brake discs may result in delayed brake function. With

wet road surfaces, prior to long-stay parking and after the car has been washed, it is therefore advisable to carry out cleaning by braking gently for a short period while driving.

#### Maintenance



To keep the car as safe and reliable as possible, follow the Volvo service intervals as specified in the Service and Warranty Booklet.

#### IMPORTANT

The wear on the brake system's components must be checked regularly.

Contact a workshop for information about the procedure or engage a workshop to carry out the inspection - an authorised Volvo workshop is recommended.

#### Symbols and messages



Symbol	Specification
	Constant glow – Check the brake fluid level. If the level is low, fill with brake fluid and check for the cause of the brake fluid loss.
	Constant glow for 2 seconds when the engine is started - automatic function check.

\* Option/accessory, for more information, see Introduction.





## **WARNING**

If  and  illuminate at the same time, there may be a fault in the brake system.

If the level in the brake fluid reservoir is normal at this stage, drive carefully to the nearest workshop and have the brake system checked - an authorised Volvo workshop is recommended.

If the brake fluid is below the **MIN** level in the brake fluid reservoir, do not drive further before topping up the brake fluid.

The reason for the loss of brake fluid must be investigated.

### **Related information**

- Parking brake (p. 282)
- Foot brake - emergency brake lights and automatic hazard warning flashers (p. 280)
- Foot brake - emergency brake assistance (p. 281)
- Foot brake - anti-lock braking system (p. 280)

### **Foot brake - anti-lock braking system**

*The anti-lock braking system, ABS (Anti-lock Braking System), prevents the wheels from locking up during braking.*

The function allows the steering ability to be maintained, and it is easier to swerve to avoid a hazard for example. Vibration may be felt in the brake pedal when this is engaged and this is normal.

A short test of the ABS system is made automatically after the engine has been started when the driver releases the brake pedal. A further automatic test of the ABS system may be made when the car reaches 10 km/h. The test may be experienced as pulses in the brake pedal.

### **Related information**

- Foot brake (p. 279)
- Parking brake (p. 282)
- Foot brake - emergency brake lights and automatic hazard warning flashers (p. 280)
- Foot brake - emergency brake assistance (p. 281)

### **Foot brake - emergency brake lights and automatic hazard warning flashers**

*Emergency brake lights are activated to alert vehicles behind about sudden braking. The function means that the brake light flashes instead of - as in normal braking - shining with a constant glow.*

Emergency brake lights are activated at speeds above 50 km/h in the event of sudden braking. After the car's speed has been slowed below 10 km/h the brake light returns from flashing to the normal constant glow - while at the same time the hazard warning flashers (p. 88) are activated, and they flash until the driver changes engine speed with the accelerator pedal or they are deactivated with their button.

### **Related information**

- Foot brake (p. 279)
- Parking brake (p. 282)
- Foot brake - emergency brake assistance (p. 281)
- Foot brake - anti-lock braking system (p. 280)



## Foot brake - emergency brake assistance

*Emergency brake assistance EBA (Emergency Brake Assist) helps to increase the braking force and so reduce the braking distance.*

EBA detects the driver's braking style and increases the braking force when necessary. The brake force can be reinforced up to the level when the ABS system is engaged. The EBA function is interrupted when the pressure on the brake pedal is reduced.

### NOTE

When EBA is activated the brake pedal lowers slightly more than usual, depress (hold) the brake pedal as long as necessary. If the brake pedal is released then all braking ceases.

### Related information

- Foot brake (p. 279)
- Parking brake (p. 282)
- Foot brake - emergency brake lights and automatic hazard warning flashers (p. 280)
- Foot brake - anti-lock braking system (p. 280)



### Parking brake

The parking brake holds the car stationary, when the driver's seat is empty, by mechanically locking/blocking two wheels.

#### Function

A faint electric motor noise can be heard when the electrical parking brake is being applied. The noise can also be heard during the automatic function checking of the parking brake.

If the car is stationary when the parking brake is applied then it only acts on the rear wheels. If it is applied when the car is moving then the normal foot brake is used, i.e. the brake acts on all four wheels. Brake function changes over to the rear wheels when the car is almost stationary.

#### Low battery voltage

If the battery voltage is too low then the parking brake can neither be released nor applied. Connect a donor battery if the battery voltage is too low, see Jump starting with battery (p. 258).

### Applying the parking brake



*Parking brake control - apply.*

1. Press the foot brake pedal down firmly.
  2. Press the control **PUSH LOCK/PULL RELEASE**.
    - >  The combined instrument panel's symbol starts flashing - once there is a constant glow the parking brake is applied.
  3. Release the foot brake pedal and make sure that the car is at a standstill position.
- When parking the vehicle, always engage 1st gear (for manual gearbox) or put the gear selector in position **P** (for automatic gearbox).

#### Emergency brake

In an emergency the parking brake can be applied when the vehicle is in motion by

pressing and holding the control for **PUSH LOCK/PULL RELEASE**. The braking procedure is stopped when the control is released.

#### NOTE

In the event of emergency braking at speeds above 10 km/h a signal sounds during the braking procedure.

#### Parking on a hill

If the car is parked facing uphill:

- Turn the wheels **away from** the kerb.

If the car is parked facing downhill:

- Turn the wheels **towards** the kerb.

#### WARNING

Always apply the parking brake when parking on a slope - leaving the car in gear, or in **P** if it has automatic transmission, is not sufficient to hold the car in all situation.



## Disengaging the parking brake



Parking brake control - release.

## Cars with manual gearbox

### Releasing manually

1. Insert the remote control key in the ignition switch.<sup>15</sup>
2. Press the foot brake pedal down firmly.
3. Pull the control **PUSH LOCK/PULL RELEASE**.
  - > The parking brake releases and the combined instrument panel's symbol extinguishes.

### NOTE

The parking brake can also be released manually by depressing the clutch pedal instead of the brake pedal. Volvo recommends that the brake pedal is used.

### Releasing automatically

1. Start the engine.
2. Engage 1st gear or reverse gear.
3. Ease up the clutch and depress the accelerator.
  - > The parking brake releases and the combined instrument panel's symbol extinguishes.

## Cars with automatic gearbox

### Releasing manually

1. Insert the remote control key in the ignition switch<sup>15</sup>.
2. Press the foot brake pedal down firmly.
3. Pull the control.
  - > The parking brake releases and the combined instrument panel's symbol extinguishes.

### Releasing automatically

1. Put the seatbelt on.

2. Start the engine.
3. Press the foot brake pedal down firmly.
4. Move the gear selector to position **D** or **R** and depress the accelerator.
  - > The parking brake releases and the combined instrument panel's symbol extinguishes.

### NOTE

For safety reasons, the parking brake is only released automatically if the engine is running and the driver is wearing a seatbelt. The parking brake is released immediately on cars with automatic gearbox when the accelerator pedal is depressed and the gear selector is in position **D** or **R**.

### Heavy load uphill

A heavy load, such as a trailer, can cause the car to roll backward when the parking brake is released automatically on a steep incline. Avoid this by depressing the control while driving off. Release the control when the engine achieves traction.

### Replacing the brake linings

The rear brake linings must be replaced at a workshop due to the design of the electric parking brake - an authorised Volvo workshop is recommended.

<sup>15</sup> For a car with the Keyless system: Press **START/STOP ENGINE**.



## Symbols and messages

For information on how the combined instrument panel's text messages can be shown

and deleted, see Messages - handling (p. 107).

Symbol	Message	Meaning/Action
	"Message"	<ul style="list-style-type: none"> <li>Read the combined instrument panel's message.</li> </ul>
		<p>A flashing symbol indicates that the parking brake is applied.</p> <p>If the symbol flashes in any other situation then this means that a fault has arisen.</p> <ul style="list-style-type: none"> <li>Read the combined instrument panel's message.</li> </ul>
	<b>Handbrake not fully released</b>	<p>A fault is preventing the parking brake from being released:</p> <ul style="list-style-type: none"> <li>Try to apply and release the brake.</li> </ul> <p>If the fault persists after a few attempts:</p> <ul style="list-style-type: none"> <li>Visit a workshop - an authorised Volvo workshop is recommended.</li> </ul> <p>Note: A warning signal sounds if the journey is continued with this error message.</p>



Symbol	Message	Meaning/Action
	<b>Handbrake not applied</b>	<p>A fault is preventing the parking brake from being applied:</p> <ul style="list-style-type: none"> <li>• Try to release and apply the brake.</li> </ul> <p>If the fault persists after a few attempts:</p> <ul style="list-style-type: none"> <li>• Visit a workshop - an authorised Volvo workshop is recommended.</li> </ul> <p>The message is also illuminated on cars with manual gearbox when the car is driven at low speed with the door open in order to alert the driver that the parking brake may have been unintentionally disengaged.</p>
	<b>Handbrake Service required</b>	<p>A fault has arisen:</p> <ul style="list-style-type: none"> <li>• Try to apply and release the brake.</li> </ul> <p>If the fault persists after a few attempts:</p> <ul style="list-style-type: none"> <li>• Visit a workshop - an authorised Volvo workshop is recommended.</li> </ul>

- If the car has to be parked before a possible fault has been rectified, then the wheels must be turned as if parking on a hill and 1st gear engaged (manual gearbox) or the gear selector must be in position **P** (automatic gearbox).

A text message can be acknowledged by briefly pressing the **OK** button on the direction indicator stalk.

#### Related information

- Foot brake (p. 279)



### Fording

*Fording means that the car is driven through a water-covered roadway. Fording must be carried out with great caution.*

The car can be driven through water at a maximum depth of 25 cm at a maximum speed of 10 km/h. Extra caution should be exercised when passing through flowing water.

During driving in water, maintain a low speed and do not stop the car. When the water has been passed, depress the brake pedal lightly and check that full brake function is achieved. Water and mud for example can make the brake linings wet resulting in delayed brake function.

- Clean the electric contacts of the electric engine block heater and trailer coupling after driving in water and mud.
- Do not let the car stand with water over the sills for any long period of time - this could cause electrical malfunctions.

### ! IMPORTANT

Engine damage can occur if water enters the air filter.

In depths greater than 25 cm, water could enter the transmission. This reduces the lubricating ability of the oils and shortens the service life of these systems.

Damage to any component, engine, transmission, turbocharger, differential or its internal components caused by flooding, hydrostatic locking or oil shortage, is not covered by the warranty.

In the event of the engine stalling in water, do not try restart - tow the car from the water to a workshop - an authorised Volvo workshop is recommended. Risk of engine breakdown.

### Related information

- Recovery (p. 304)
- Towing (p. 301)

### Overheating

*Under special conditions, for example hard driving in hilly terrain and hot climate, there is a risk that the engine and drive system may overheat - in particular with a heavy load.*

For information about overheating when driving with a trailer, see Driving with a trailer (p. 296).

- Remove any auxiliary lamps from in front of the grille when driving in hot climates.
- If the temperature in the engine's cooling system is too high then a warning symbol is illuminated in the combined instrument panel's information display and a text message **High engine temperature Stop safely** is shown there - stop the car in a safe way and allow the engine to run at idling speed for several minutes in order to cool down.
- If the text message **High engine temperature Turn off engine** or **Engine coolant level low Stop safely** is shown then the engine must be switched off after stopping the car.
- In the event of overheating in the gearbox a built-in protection function is activated which, amongst other things, illuminates a warning symbol in the combined instrument panel, and its display shows the text message **Transmission hot Reduce speed** or **Transmission hot Stop safely Wait for cooling** - follow the recommendation given and lower the speed and





stop the car in a safe way and allow the engine to run at idling speed for a few minutes in order to allow the gearbox to cool down.

- If the car overheats, the air conditioning may be switched off temporarily.
- Do not turn the engine off immediately you stop after a hard drive.



#### NOTE

It is normal for the engine's cooling fan to operate for a time after the engine has been switched off.

### Driving with open tailgate

*When driving with the boot lid open, toxic exhaust fumes can be sucked into the car through the cargo area.*



#### WARNING

Do not drive with the boot lid open. Toxic exhaust fumes can be drawn into the car through the cargo area.

### Related information

- Loading (p. 149)

### Overload - starter battery

*The electrical functions in the car load the starter battery (p. 361) to varying degrees. Avoid using the key position II (p. 74) when the engine is switched off. Instead use position I - which uses less power.*

Also, be aware of different accessories that load the electrical system. Do not use functions which use a lot of power when the engine is switched off. Examples of such functions are:

- ventilation fan
- headlamps
- windscreen wiper
- audio system (high volume).

If the starter battery voltage is low then the combined instrument panel's information display shows the text **Low battery charge Power save mode**. The energy-saving function then shuts down certain functions or reduces certain functions such as the ventilation fan and/or audio system.

- In which case, charge the starter battery by starting the engine and then running it for at least 15 minutes - starter battery charging is more effective during driving than running the engine at idling speed while stationary.



### Before a long journey

Before a long journey, it makes good sense to go through the following points:

- Check that the engine is working normally and that fuel consumption (p. 404) is normal.
- Make sure that there are no leaks (fuel, oil or other fluid).
- Check all bulbs and tyre tread depths.
- Carrying a warning triangle (p. 316) is a legal requirement in certain countries.

### Related information

- Engine oil - checking and filling (p. 346)
- Changing wheels - removing wheels (p. 312)
- Lamp replacement (p. 352)

### Winter driving

For winter driving it is important to perform certain checks in order to ensure that the car can be driven safely.

Check the following in particular before the cold season:

- The engine coolant (p. 349) must contain at least 50% glycol. This mixture protects the engine against frost erosion down to approximately  $-35^{\circ}\text{C}$ . To achieve optimum antifreeze protection, different types of glycol must not be mixed.
- The fuel tank must be kept filled to prevent condensation.
- Engine oil viscosity is important. Oils with lower viscosity (thinner oils) facilitate starting in cold weather and also reduce fuel consumption while the engine is cold. For more information on suitable oils, see Engine oil - adverse driving conditions (p. 396).

### IMPORTANT

Low viscosity oil must not be used for hard driving or in hot weather.

- The condition of the starter battery and charge level must be inspected. Cold weather places great demands on the

starter battery and its capacity is reduced by the cold.

- Use washer fluid (p. 361) to avoid ice forming in the washer fluid reservoir.

To achieve optimum roadholding Volvo recommends using winter tyres on all wheels if there is a risk of snow or ice.

### NOTE

The use of winter tyres is a legal requirement in certain countries. Studded tyres are not permitted in all countries.

### Slippery driving conditions

Practise driving on slippery surfaces under controlled conditions to learn how the car reacts.

### Related information

- Winter driving (p. 288)



### Fuel filler flap - Opening/closing

The fuel filler flap can be opened/closed as follows:

#### Opening/closing the fuel filler flap



Open the fuel filler flap using the button on the lighting panel - the flap opens when the button is released.

 In the combined instrument panel's display the arrow on the symbol indicates which side of the car the fuel cap is located.

- Close the fuel filler flap by pressing it in until a click confirms that it is closed.

#### Related information

- Filling up with fuel (p. 289)

### Fuel filler flap - manual opening

The fuel filler flap can be opened manually when electric opening from the passenger compartment is not possible.



1. Open/remove the side hatch in the cargo area (same side as fuel filler flap) and locate the green cord with handle.
2. Pull the cord gently straight back until the fuel filler flap folds out with a "click".

#### **IMPORTANT**

Pull the wire gently - minimal force is required to disengage the hatch lock.

#### Related information

- Filling up with fuel (p. 289)

### Filling up with fuel

Important things to consider when refuelling.

#### Opening/closing the fuel cap

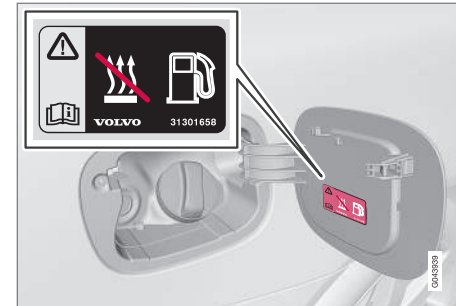

A certain overpressure may arise in the tank in the event of high outside temperatures. Open the cap slowly.

- After refuelling - refit the cap and turn it until one or more clicking sounds are heard.

#### Filling up with fuel

- Do not overfill the tank but fill until the pump nozzle cuts out.

#### **NOTE**

Excess fuel in the tank can overflow in hot weather.



### Filling with a fuel can<sup>16</sup>

When filling with a fuel can, use the funnel located under the floor hatch in the cargo area.

Make sure you insert the funnel's pipe firmly into the filler pipe. The filler pipe has an openable cover and the funnel's pipe must be slid past the cover before filling can begin.

### Related information

- Fuel filler flap - manual opening (p. 289)
- Fuel - handling (p. 290)

### Fuel - handling

*Fuel of a lower quality than that recommended by Volvo must not be used as engine power and fuel consumption is negatively affected.*

#### WARNING

Always avoid inhaling fuel vapour and getting fuel splashes in the eyes.

In the event of fuel in the eyes, remove any contact lenses and rinse the eyes in plenty of water for at least 15 minutes and seek medical attention.

Never swallow fuel. Fuels such as petrol, bioethanol and mixtures of them and diesel are highly toxic and could cause permanent injury or be fatal if swallowed. Seek medical attention immediately if fuel has been swallowed.

#### WARNING

Fuel which spills onto the ground can be ignited.

Switch off the fuel-driven heater before starting to refuel.

Never carry an activated mobile phone when refuelling. The ring signal could cause spark build-up and ignite petrol fumes, leading to fire and injury.

#### IMPORTANT

Mixing different types of fuel<sup>17</sup> or the use of fuel that is not recommended invalidates Volvo's warranties, as well as any supplementary service agreements, and this applies to all engines. NOTE: Does not apply to cars with engines adapted for driving on ethanol fuel (E85).

#### NOTE

Extreme weather conditions, driving with a trailer or driving at high altitudes in combination with fuel grade are factors that could affect the car's performance.

### Related information

- Economical driving (p. 295)
- Fuel - diesel (p. 291)
- Diesel particle filter (DPF) (p. 294)
- Fuel consumption and CO2 emissions (p. 404)
- Fuel tank - volume (p. 403)

<sup>16</sup> Only applies to cars with diesel engine.

<sup>17</sup> Only applies to mixing petrol and ethanol fuel.



## Fuel - petrol

*Petrol is used as fuel.*

Petrol must fulfil the EN 228 standard. Most engines can be run with octane ratings of 95 and 98 RON. A lower octane rating such as 91 and 92 RON should only be used in exceptional cases

- 95 RON can be used for normal driving.
- 98 RON is recommended for optimum performance and minimum fuel consumption.

When driving in temperatures above +38 °C, fuel with the highest possible octane rating is recommended for optimum performance and fuel economy.



### IMPORTANT

- Use only unleaded petrol to avoid damaging the catalytic converter.
- Fuel that contains up to 10 volume-% ethanol is permitted.
- Fuel containing metallic additives must not be used.
- Do not use any additives which have not been recommended by Volvo.

## Alcohols-ethanol

- EN228 E10 petrol (max 10 percent by volume ethanol) is approved for use.
- Ethanol higher than E10 (max 10 percent by volume ethanol) is not permitted, e.g. E85.

### Related information

- Fuel - handling (p. 290)
- Economical driving (p. 295)
- Fuel consumption and CO2 emissions (p. 404)
- Fuel tank - volume (p. 403)

## Fuel - diesel

*Diesel is used as fuel.*

Only use diesel fuel from well-known producers. Never use fuel of dubious quality. Diesel fuel must fulfil the EN 590 and/or SS 155435 standards. Diesel engines are sensitive to contaminants in the fuel, such as excessively high volumes of sulphur particles for example.

At low temperatures (-6 °C to -40 °C), a paraffin precipitate may form in the diesel fuel, which may lead to ignition problems. Special diesel fuel designed for low temperatures around freezing point is available from the major oil companies. This fuel is less viscous at low temperatures and reduces the risk of paraffin precipitate.

The risk of condensation in the fuel tank is reduced if the tank is kept well filled. When refuelling, check that the area around the fuel filler pipe is clean. Avoid spilling fuel onto the paintwork. Wash off any spillage with detergent and water.



## **IMPORTANT**

Diesel fuel must:

- fulfil the EN 590 and/or SS 155435 standards
- have a sulphur content not exceeding 10 mg/kg
- have a maximum of 7 vol % FAME (Fatty Acid Methyl Ester).

## **IMPORTANT**

Diesel type fuels that must not be used:

- Special additives
- Marine diesel fuel
- Heating oil
- FAME<sup>18</sup> (Fatty Acid Methyl Ester) and vegetable oil.

These fuels do not fulfil the requirements in accordance with Volvo recommendations and generate increased wear and engine damage that is not covered by the Volvo warranty.

### Empty tank

The design of the fuel system in a diesel engine means that if the vehicle runs out of fuel, the tank may need to be vented in the workshop in order to restart the engine after fuelling.

Once the engine has stopped due to fuel starvation, the fuel system needs a few moments to carry out a check. Do this before starting the engine, once the fuel tank has been filled with diesel:

1. Insert the remote control key in the ignition switch and push it in to the end position. For more information, see Key positions (p. 74).
2. Press the **START** button **without** depressing the brake and/or clutch pedal.
3. Wait approx. one minute.
4. To start the engine: Depress the brake and/or clutch pedal and then press the **START** button again.

## **NOTE**

Before filling with fuel in the event of fuel shortage:

- Stop the car on as flat/level ground as possible - if the car is tilting there is a risk of air pockets in the fuel supply.

### Draining condensation from the fuel filter

The fuel filter separates condensation from the fuel. Condensation can disrupt engine operation.

The fuel filter must be drained at the intervals specified in the Service and Warranty Booklet or if you suspect that the car has been filled with contaminated fuel. For more information, see Volvo service programme (p. 338).

## **IMPORTANT**

Certain special additives remove the water separation in the fuel filter.

### Related information

- Fuel - handling (p. 290)
- Diesel particle filter (DPF) (p. 294)
- Fuel consumption and CO2 emissions (p. 404)

<sup>18</sup> Diesel fuel may contain a certain amount of FAME, but further amounts must not be added.



### Catalytic converters

The purpose of the catalytic converters is to purify exhaust gases. They are located close to the engine so that operating temperature is reached quickly.

The catalytic converters consist of a monolith (ceramic or metal) with channels. The channel walls are lined with a thin layer of platinum/rhodium/palladium. These metals act as catalysts, i.e. they participate in and accelerate a chemical reaction without being used up themselves.

### Lambda-sond™ oxygen sensor

The Lambda-sond is part of a control system intended to reduce emissions and improve fuel economy. For more information, see Fuel consumption and CO2 emissions (p. 404).

An oxygen sensor monitors the oxygen content of the exhaust gases leaving the engine. This value is fed into an electronic system that continuously controls the injectors. The ratio of fuel to air directed to the engine is continuously adjusted. These adjustments create optimal conditions for efficient combustion, and together with the three-way catalytic converter reduce harmful emissions (hydrocarbons, carbon monoxide and nitrous oxides).

### Related information

- Economical driving (p. 295)
- Fuel - petrol (p. 291)

- Fuel - diesel (p. 291)

### Fuel - bioethanol E85

Bioethanol E85 is used as the fuel for the car's engine.

Do not modify the fuel system or its components, and do not replace components with parts that are not specifically designed for use with bioethanol.



#### WARNING

Methanol must not be used. A decal on the inside of the fuel filler flap shows the correct alternative fuel.

The use of components not designed for bioethanol engines could cause fire, injury or engine damage.

### Reserve fuel can



#### IMPORTANT

Statutory provisions relating to storage of reserve fuel cans in cars vary from country to country. Check what does apply.

The reserve fuel can should be filled with petrol. For more information, see Starting the engine – Flexifuel (p. 257).



#### IMPORTANT

Make sure the reserve fuel can is securely fastened and that its cap is sealed.



## **WARNING**

Ethanol is sensitive to sparks, and explosive gases could form in the reserve fuel can if it is refuelled with ethanol.

### **Related information**

- Fuel - handling (p. 290)
- Economical driving (p. 295)

## **Diesel particle filter (DPF)**

*Diesel cars are equipped with a particle filter, which results in more efficient emission control.*

The particles in the exhaust gases are collected in the filter during normal driving. So-called "regeneration" is started in order to burn away the particles and empty the filter. This requires the engine to have reached normal operating temperature.

Regeneration of the particle filter is automatic and normally takes 10-20 minutes. It may take a little longer at a low average speed. Fuel consumption may increase slightly during regeneration.

### **Regeneration in cold weather**

If the car is frequently driven short distances in cold weather then the engine does not reach normal operating temperature. This means that regeneration of the diesel particle filter does not take place and the filter is not emptied.

When the filter has become approx. 80% full of particles, a yellow warning triangle is shown in the combined instrument panel, and the message **Soot filter full See manual** is shown in its information display.

Start regeneration of the filter by driving the car until the engine reaches normal operating temperature, preferably on a main road or

motorway. The car should then be driven for approximately 20 minutes more.

## **NOTE**

The following may arise during regeneration:

- a smaller reduction of engine power may be noticed temporarily
- fuel consumption may increase temporarily
- a smell of burning may arise.

When regeneration is complete the warning text is cleared automatically.

Use the parking heater\* in cold weather - the engine then reaches normal operating temperature more quickly.

## **IMPORTANT**

If the filter is completely filled with particles, it may be difficult to start the engine and the filter is non-functional. Then there is a risk that the filter will need to be replaced.

### **Related information**

- Fuel - handling (p. 290)
- Fuel - diesel (p. 291)
- Fuel consumption and CO2 emissions (p. 404)
- Fuel tank - volume (p. 403)





## Economical driving

*Driving economically means driving smoothly while thinking ahead and adjusting your driving style and speed to the prevailing conditions.*

- For lowest fuel consumption, activate ECO (p. 277)<sup>19</sup>.
- Use the ECO Guide which indicates how fuel-efficiently the car is being driven, see Eco guide & Power guide\* (p. 63).
- Drive in the highest gear possible, adapted to the current traffic situation and road - lower engine speeds result in lower fuel consumption. Use the gear indicator (p. 260).
- Avoid sudden unnecessary acceleration and heavy braking.
- High speed results in increased fuel consumption - the wind resistance increases with speed.
- Do not run the engine to operating temperature at idling speed, but rather drive with a light load as soon as possible - a cold engine consumes more fuel than a warm one.
- Drive with the correct air pressure in the tyres and check this regularly - select ECO tyre pressure for best results, see Tyres - approved tyre pressures (p. 407).

<sup>19</sup> Only applies to cars with automatic gearbox.

- Choice of tyres can affect fuel consumption - seek advice on suitable tyres from a dealer.
- Remove unnecessary items from the car - the greater the load the higher the consumption.
- Use engine braking to slow down, when it can take place without risk to other road users.
- A roof load and ski box increase air resistance, leading to higher consumption - remove the load carriers when not in use.
- Avoid driving with open windows.

For information about Volvo Car Corporation's environmental philosophy, see Volvo Cars' environmental philosophy (p. 21).

For more information about fuel consumption, see Fuel consumption and CO2 emissions (p. 404).



### WARNING

Never switch off the engine while moving, such as downhill, this deactivates important systems such as the power steering and brake servo.

### Related information

- Fuel - handling (p. 290)
- Fuel consumption and CO2 emissions (p. 404)

- Fuel tank - volume (p. 403)



## Driving with a trailer

When driving with a trailer there are a number of important points to think about regarding e.g. the towing bracket, the trailer and how the load is positioned in the trailer.

Payload depends on the car's kerb weight. The total of the weight of the passengers and all accessories, e.g. towbar, reduces the car's payload by a corresponding weight. For more detailed information, see Weights (p. 391).

If the towing bracket is mounted by Volvo, then the car is delivered with the necessary equipment for driving with a trailer.

- The car's towing bracket must be of an approved type.
- If the towbar is retrofitted, check with your Volvo dealer that the car is fully equipped for driving with a trailer.
- Distribute the load on the trailer so that the weight on the towing bracket complies with the specified maximum towball load.
- Increase the tyre pressure to the recommended pressure for a full load. For tyre pressure label location, see Tyres - air pressure (p. 315).
- The engine is loaded more heavily than usual when driving with a trailer.
- Do not tow a heavy trailer when the car is brand new. Wait until it has been driven at least 1000 km.

- The brakes are loaded much more than usual on long and steep downhill slopes. Downshift to a lower gear and adjust your speed.
- For safety reasons, the maximum permitted speed for the car when coupled with a trailer should not be exceeded. Follow the regulations in force for the permitted speeds and weights.
- Maintain a low speed when driving with a trailer up long, steep ascents.
- Avoid driving with a trailer on inclines of more than 12%.

## Trailer cable

An adapter is required if the car's towing bracket has 13 pin electrics and the trailer has 7 pin electrics. Use an adapter cable approved by Volvo. Make sure the cable does not drag on the ground.

## Direction indicators and brake lights on the trailer

If any of the trailer's lamps for direction indicators are broken, then the combined instrument panel's symbol for direction indicators flashes faster than normal and the information display shows the text **Trailer indicator malfunction**.

If any of the trailer's lamps for the brake light are broken then the **Trailer brake light malfunction** text is shown.

## Level control\*

The rear shock absorbers maintain a constant height irrespective of the car's load (up to the maximum permissible weight). When the car is stationary the rear of the car lowers slightly, which is normal

## Trailer weights

For information on Volvo's permitted trailer weights, see Towing capacity and towball load (p. 392).



### NOTE

The stated maximum permitted trailer weights are those permitted by Volvo. National vehicle regulations can further limit trailer weights and speeds. Towbars can be certified for higher towing weights than the car can actually tow.



### WARNING

Follow the stated recommendations for trailer weights. Otherwise, the car and trailer may be difficult to control in the event of sudden movement and braking.

## Related information

- Driving with a trailer - manual gearbox (p. 297)
- Driving with a trailer - automatic gearbox (p. 297)
- Towing bracket/Towbar (p. 298)
- Lamp replacement (p. 352)

\* Option/accessory, for more information, see Introduction.



### Driving with a trailer - manual gearbox

When driving with a trailer in hilly terrain in a hot climate there may be a risk of overheating.

#### Overheating

When driving with a trailer in hilly terrain in a hot climate there may be a risk of overheating.

- Do not run the engine at higher revolutions than 4500 rpm (diesel engines: 3500 rpm) - otherwise the oil temperature may become too high.

#### Diesel engine 5-cyl

- In the event of a risk of overheating the optimal speed for the engine is 2300-3000 rpm for optimal circulation of the coolant.

#### Related information

- Driving with a trailer (p. 296)

### Driving with a trailer - automatic gearbox

When driving with a trailer in hilly terrain in a hot climate there may be a risk of overheating.

- An automatic gearbox selects the optimum gear related to load and engine speed.
- In the event of overheating a warning symbol is illuminated in the combined instrument panel with a message that is shown in the information display - follow the recommendation given.

#### Steep inclines

- Do not lock the automatic transmission in a higher gear than the engine "can cope with" - it is not always a good idea to drive at a high gear with low engine revolutions.

#### Parking on a hill

- Depress the foot brake.
  - Activate the parking brake.
  - Move the gear selector to position **P**.
  - Release the foot brake.
- Move the gear selector to park position **P** when parking an automatic car with a hitched trailer. Always use the parking brake.
  - Block the wheels with chocks when parking a car with hitched trailer on a hill.



#### IMPORTANT

See also the specific information on slow driving with a trailer for cars with the Powershift automatic transmission, see Automatic gearbox -- Powershift\* (p. 265).

#### Starting on a hill

- Depress the foot brake.
- Move the gear selector to driving position **D**.
- Release the parking brake.
- Release the foot brake and start driving off.

#### Related information

- Automatic gearbox -- Geartronic\* (p. 261)



## Towing bracket/Towbar

A towing bracket means that it is possible to e.g. tow a trailer behind the car.

If the car is equipped with a detachable/removable towbar, the installation instructions for the loose section must be followed carefully, see Detachable towbar - attachment/removal (p. 299).

### WARNING

If the car is fitted with a Volvo detachable towbar:

- Follow the installation instructions carefully.
- The detachable section must be locked with the key before setting off.
- Check that the indicator window shows green.

### Important checks

- The towbar's towball must be cleaned and greased regularly.

### NOTE

When a hitch with a vibration damper is used, the towball must not be lubricated.

### Related information

- Driving with a trailer (p. 296)

## Detachable towbar - storage

Store the detachable towbar in the cargo area.

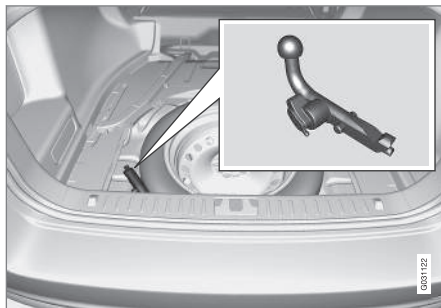

Towbar storage space.

### IMPORTANT

Always remove the towbar after use and store it in the appointed location in the car, firmly fastened with its strap.

### Related information

- Detachable towbar - specifications (p. 298)
- Detachable towbar - attachment/removal (p. 299)
- Driving with a trailer (p. 296)

## Detachable towbar - specifications

Specifications for detachable towbar.

### Specifications

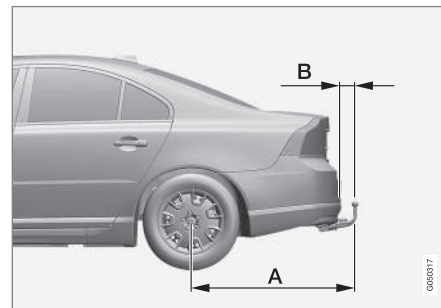

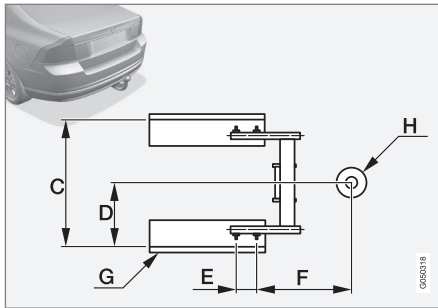

### Dimensions, mounting points (mm)

A	1127
B	87
C	855
D	428
E	112
F	360
G	Side member
H	Ball centre

### Related information

- Detachable towbar - attachment/removal (p. 299)
- Detachable towbar - storage (p. 298)
- Driving with a trailer (p. 296)

### Detachable towbar - attachment/ removal

The attachment/removal of the detachable towbar is performed in the following way:

#### Attaching

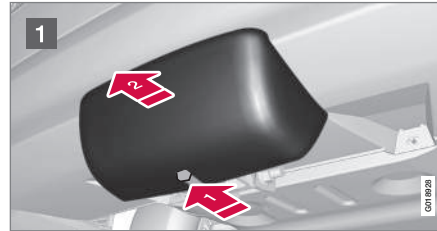

- 1 Remove the protective cover by first pressing in the catch and then pulling the cover straight back .

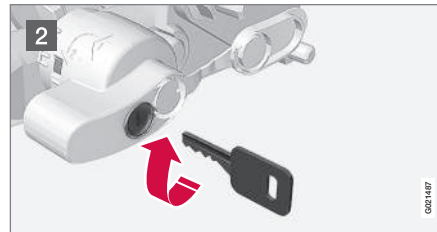

- 2 Ensure that the mechanism is in the unlocked position by turning the key clockwise.

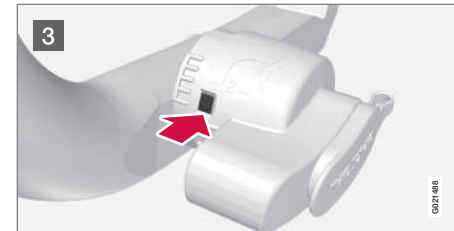

- 3 The indicator window must show red.

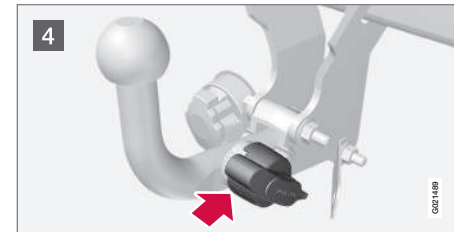

- 4 Insert the towbar until you hear a click.

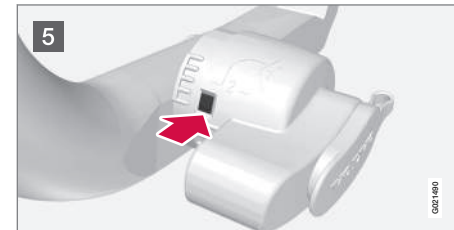

- 5 The indicator window must show green.



# 08 Starting and driving

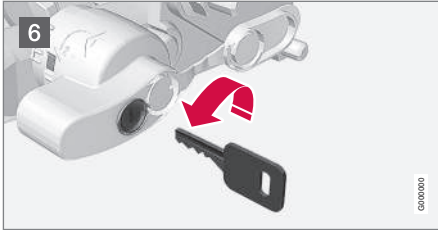

**6** Turn the key anticlockwise to locked position. Remove the key from the lock.

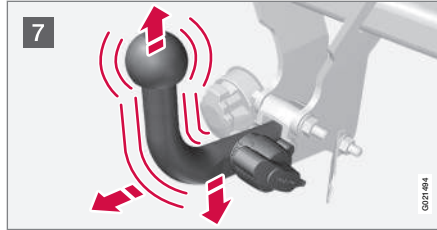

**7** Check that the towbar is secure by pulling it up, down and back.

 **WARNING**  
If the towbar is not fitted correctly then it must be detached and reattached in accordance with the previous instructions.

 **IMPORTANT**  
Only grease in the ball for the towing hitch, the remainder of the towbar should be clean and dry.



**8** Safety cable.

 **WARNING**  
Take care to secure the trailer's safety cable in the intended bracket.

## Removing the towbar

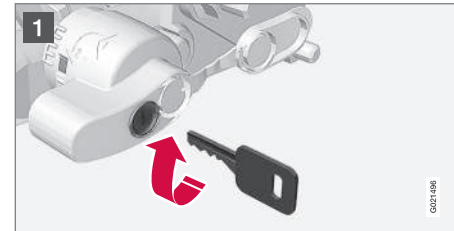

**1** Insert the key and turn it clockwise to the unlocked position.

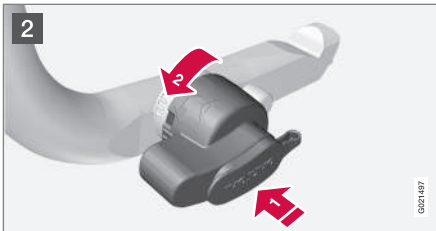

- 2 Push in the locking wheel **I** and turn it anticlockwise **2** until you hear a click.

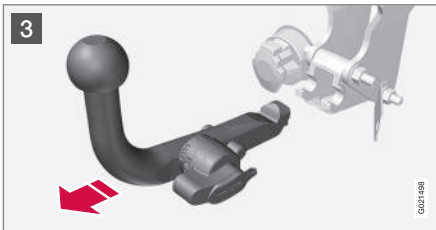

- 3 Turn the locking wheel down fully, until it comes to a stop. Hold it in this position while pulling the towbar rearward and upward.

### **WARNING**

Secure the towbar safely if it is stored in the car, see Detachable towbar - storage (p. 298).



- 4 Push the protective cover until it snaps tight.

### Related information

- Detachable towbar - storage (p. 298)
- Detachable towbar - specifications (p. 298)
- Driving with a trailer (p. 296)

### Towing

*During towing, one vehicle is towed by another vehicle using a tow rope.*

Find out the statutory maximum speed limit for towing before towing begins.

1. Unlock the steering lock by inserting the remote control key in the ignition switch and giving a long press on the **START/STOP ENGINE** button - key position **II** is activated, see Key positions (p. 74) for more information about key positions.
2. The remote control key must remain in the ignition switch while the car is being towed.
3. Keep the towline taut when the towing vehicle reduces speed by holding your foot gently pressed on the brake pedal - thereby avoiding unnecessary jerking.
4. Be prepared to brake to stop.

### **WARNING**

- Check that the steering lock is unlocked before towing.
- The remote control key must be in key position **II** - in position **I** all airbags are deactivated.
- Never remove the remote control key from the ignition switch when the car is being towed.



## **WARNING**

The brake servo and power steering do not work when the engine is switched off - the brake pedal needs to be depressed about 5 times more heavily and the steering is considerably heavier than normal.

### **Manual gearbox**

Prior to towing:

- Move gear lever into neutral and release the parking brake.

### **Automatic gearbox Geartronic**

Prior to towing:

- Move the gear selector to position **N** and release the parking brake.

## **IMPORTANT**

- Do not tow the vehicle at speeds higher than 80 km/h or for distances in excess of 80 km.
- Note that the car must always be towed with the wheels rolling forward.

### **Automatic gearbox Powershift**

The model with Powershift transmission should not be towed as it is dependent on the engine running in order to receive sufficient lubrication. If towing still has to take place, the route must be as short as possible and then with very low speed.

In the event of uncertainty as to whether or not the car is equipped with Powershift transmission, this can be verified by checking the designation on the gearbox label under the bonnet, see Type designations (p. 387). The designation "MPS6" means that it is Powershift transmission - otherwise it is Geartronic automatic transmission.

## **IMPORTANT**

Avoid towing.

- However, the car can be towed for a short distance at low speed to move it from a dangerous position - not further than 10 km and not faster than 10 km/h. Note that the car must always be towed with the wheels rolling forward.
- In the event of moving a longer distance than 10 km, the car must be transported with the drive wheels raised from the road - professional recovery is recommended.

Prior to towing:

- Move the gear selector to position **N** and release the parking brake.

### **Jump starting**

Do not tow the car to bump start the engine. Use a donor battery if the starter battery is

discharged and the engine does not start, see Jump starting with battery (p. 258).

## **IMPORTANT**

The catalytic converter may be damaged during attempts to tow-start the engine.

### **Related information**

- Towing eye (p. 303)
- Recovery (p. 304)





## Towing eye

The towing eye is screwed into a threaded socket behind a cover on the right-hand side of the bumper, front or rear.

### Attaching the towing eye

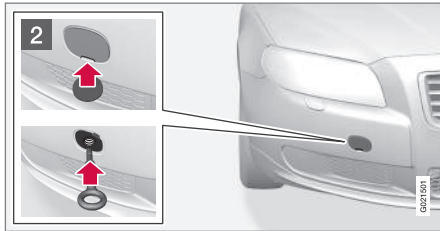
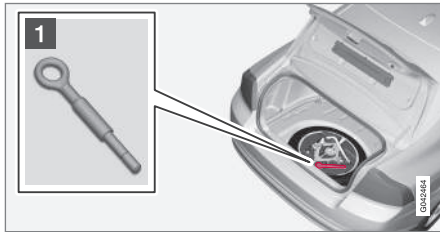

- 1 Take out the towing eye that is located under the floor hatch in the cargo area.

- 2 The cover for the towing eye's attachment point is available in two variants which must be opened in different ways:

- Open the variant with a recess using a coin or similar inserted in the recess, turning it outwards. Then turn out the cover completely and remove it.
- The second variant has a marking along one side or in a corner: Press the marking with a finger and fold out the opposite side/corner at the same time using a coin or similar - the cover turns around its axis and can then be removed.

Screw the towing eye right in up to its flange. Turn in the towing eye firmly e.g. using the wheel wrench.

After use, unscrew the towing eye and return it to its place.

Finish by refitting the cover onto the bumper.

The towing eye may be used to pull the car up onto a recovery vehicle with a flatbed platform. The car's position and ground clearance determine whether it is possible. If the slope of the recovery vehicle's ramp is too steep, or if the ground clearance under the car is inadequate, then the car may be damaged if you try to pull it up using the towing eye. Raise the car using the recovery vehicle's lifting device if necessary.

### WARNING

No one/nothing is allowed to remain behind the recovery vehicle while the car pulled up onto the flatbed platform.

### IMPORTANT

The towing eye is only designed for towing on roads - **not** for pulling the car unstuck or out of a ditch. Call a recovery service for recovery assistance.

### Related information

- Towing (p. 301)
- Recovery (p. 304)



### Recovery

*Recovery means that the vehicle is transported away by means of another vehicle.*

Call a recovery service for recovery assistance.

The towing eye may be used to pull the car up onto a recovery vehicle with a flatbed platform. The car's position and ground clearance determine whether it is possible. If the slope of the recovery vehicle's ramp is too steep, or if the ground clearance under the car is inadequate, then the car may be damaged if you try to pull it up using the towing eye. Raise the car using the recovery vehicle's lifting device if necessary.

### WARNING

No one/nothing is allowed to remain behind the recovery vehicle while the car pulled up onto the flatbed platform.

### IMPORTANT

The towing eye is only designed for towing on roads - **not** for pulling the car unstuck or out of a ditch. Call a recovery service for recovery assistance.

### IMPORTANT

Note that the car must always be transported with the wheels rolling forward.

- An All Wheel Drive car (AWD) with raised front suspension must not be towed at speeds above 70 km/h. It should not be towed further than 50 km.

### Related information

- Towing (p. 301)

# 09

## WHEELS AND TYRES

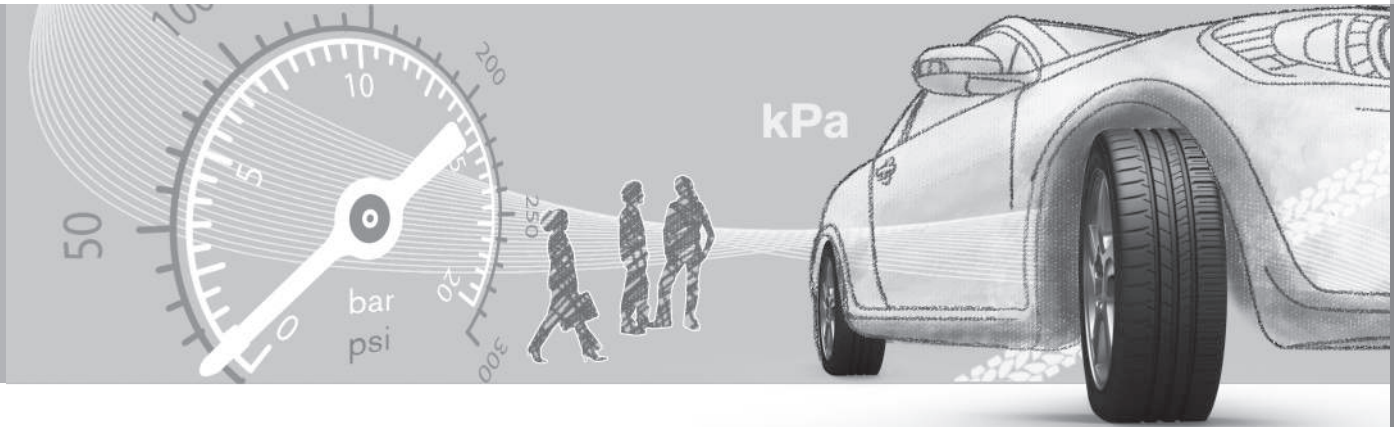



### Tyres - direction of rotation

Tyres with a tread pattern which are designed to only turn in one direction have the direction of rotation marked with an arrow.

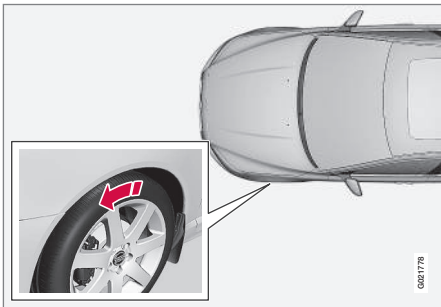

The arrow shows the tyre's direction of rotation.

The tyre must always rotate in the same direction throughout its lifespan. Tyres should only be switched between front and rear positions, never between left and right-hand sides, or vice versa. If the tyres are fitted incorrectly, the car's braking characteristics and capacity to force rain and slush out of the way are adversely affected. Tyres with the greatest tread depth should always be fitted to the rear of the car (to decrease the risk of skidding).

### NOTE

Make sure that both pairs of wheels have the same type and dimension, and also the same make.

Follow the recommended tyre pressures specified in the tyre pressure table (p. 407).

### Related information

- Tyres - dimensions (p. 310)
- Tyres - speed ratings (p. 311)
- Tyres - load index (p. 311)
- Tyres - maintenance (p. 306)
- Tyres - tread wear indicators (p. 308)

### Tyres - maintenance

Amongst other things, the function of the tyres is to provide grip on the road surface, dampen vibration and protect the wheel from wear.

### Driving characteristics

Tyres greatly affect the car's driving characteristics. The type of tyre, dimensions, tyre pressure and speed rating are important for how the car performs.

### Tyre age

All tyres older than 6 years old should be checked by an expert even if they seem undamaged. Tyres age and decompose, even if they are hardly ever or never used. The function can therefore be affected. This applies to all tyres that are stored for future use. Examples of external signs which indicate that the tyre is unsuitable for use are cracks or discoloration.



## New tyres

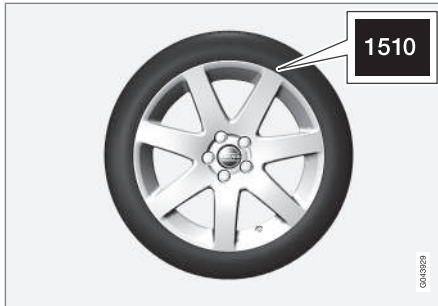

Tyres are perishable. After a few years they begin to harden at the same time as the friction capacity/characteristics gradually deteriorate. For this reason, aim to get as fresh tyres as possible when you replace them. This is especially important with regard to winter tyres. The last four digits in the sequence mean the week and year of manufacture. This is the tyre's DOT marking (Department of Transportation), and this is stated with four digits, for example 1510. The tyre in the figure was manufactured in week 15 of 2010.

## Summer and winter tyres

When summer and winter wheels are changed the wheels should be marked with which side of the car they were mounted on, for example **L** for left and **R** for right.

## Wear and maintenance

Correct tyre pressure (p. 315) results in more even wear. Driving style, tyre pressure, climate and road condition affect how quickly your tyres age and wear. To avoid differences in tread depth and to prevent wear patterns arising, the front and rear wheels can be switched with each other. A suitable distance for the first change is approx. 5000 km and then at 10000 km intervals. Volvo recommends that you contact an authorised Volvo workshop for checking if you are uncertain about tread depth. If significant differences in wear (> 1 mm difference in tread depth) between tyres have already occurred, the least worn tyres must always be placed on the rear. Understeer is normally easier to correct than oversteer, and leads to the car continuing forwards in a straight line rather than having the rear end skidding to one side, resulting in possible complete loss of control over the car. This is why it is important for the rear wheels never to lose grip before the front wheels.

Wheels should be stored lying down or hanging up - and not standing up.



### WARNING

A damaged tyre may lead to loss of control over the car.

## Related information

- Tyres - dimensions (p. 310)
- Tyres - speed ratings (p. 311)
- Tyres - load index (p. 311)
- Tyres - direction of rotation (p. 306)
- Tyres - tread wear indicators (p. 308)



## Tyres - tread wear indicators

A tread wear indicator shows the status of the tyre's tread.

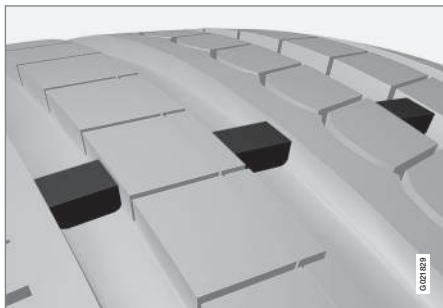

Tread wear indicators.

Tread wear indicators are narrow treadless bands across the width of the tread. On the side of the tyre are the letters TWI (Tread Wear Indicator). When the tyre's tread depth is down to 1.6 mm, the tread depth will be level in height with the tread wear indicators. Change to new tyres as soon as possible. Remember that tyres with little tread depth provide very poor grip in rain and snow.

### Related information

- Tyres - dimensions (p. 310)
- Tyres - speed ratings (p. 311)
- Tyres - load index (p. 311)
- Tyres - direction of rotation (p. 306)
- Tyres - maintenance (p. 306)

## Wheel bolts

Wheel bolts are used to fasten the wheels at the hubs and are available in different versions.

### ! IMPORTANT

The wheel bolts must be tightened to 140 Nm. Overtightening can damage the nuts and the bolts.

Only use rims that are tested and approved by Volvo and which are Volvo genuine accessories. Check the torque with a torque wrench.

### Locking wheel bolts\*

Locking wheel bolts\* can be used on both aluminium and steel rims. Under the cargo area floor there is space for the sleeve for the lockable wheel bolts.

### Related information

- Wheel and wheel rim dimensions (p. 310)

## Tools

Amongst other things, the car contains towing eye, jack\* and wheel bolt wrench\*.

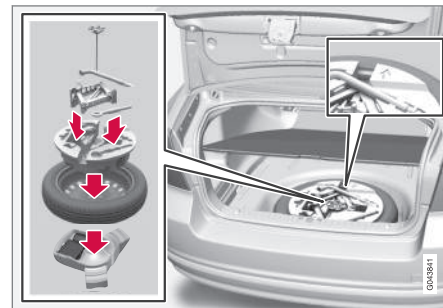

Located under the cargo area floor are the car's towing eye, jack\* and wheel wrench\*. There is also space for the sleeve for the lockable wheel bolts.

### Related information

- Emergency puncture repair\* (p. 325)
- Towing eye (p. 303)
- Changing wheels - removing wheels (p. 312)
- Wheel bolts (p. 308)
- Jack\* (p. 309)



## Jack\*

A jack is used to raise the car, e.g. when changing the tyres.

The original jack should only be used for changing to the spare wheel. The jack's thread must always be well greased.

## Tools - returning into place

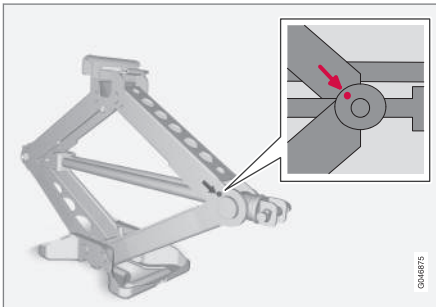

The tools and jack\* must be returned to their correct places after use. The jack needs to be cranked together to the correct position in order to have space.

The foam block and spare wheel are replaced in the reverse order to taking out.

Note that there is an arrow on the upper foam block. It must point forwards in the car.

## ! IMPORTANT

The tools and jack\* must be stored in the intended location in the car's cargo area when not in use.

## Related information

- Warning triangle (p. 316)
- Emergency puncture repair\* (p. 325)

## Winter tyres

Winter tyres are tyres that are adapted for winter road conditions.

## Winter tyres

Volvo recommends winter tyres with particular dimensions. Tyre dimensions are dependent on engine variant. When driving on winter tyres, the correct type of tyres must be fitted to all four wheels.

## i NOTE

Volvo recommends that you consult a Volvo dealer about which wheel rim and tyre types are most suitable.

## Studded tyres

Studded winter tyres should be run in gently for 500-1000 km so the studs settle properly into the tyres. This gives the tyre, and especially the studs, a longer service life.

## i NOTE

The legal provisions for the use of studded tyres vary from country to country.

## Tread depth

Road conditions with ice, slush and low temperatures place considerably higher demands on tyres than summer conditions. Volvo therefore recommends not to drive on winter tyres that have a tread depth of less than 4 mm.



## Using snow chains

Snow chains may only be used on the front wheels (also applies to all-wheel drive cars). Never drive faster than 50 km/h with snow chains. Avoid driving on bare ground as this wears out both the snow chains and tyres.



### WARNING

Use Volvo genuine snow chains or equivalent chains designed for the car model, and tyre and rim dimensions. In the event of uncertainty Volvo recommends that you consult an authorised Volvo workshop. The wrong snow chains may cause serious damage to your car and lead to an accident.

## Related information

- Changing wheels - removing wheels (p. 312)

## Wheel and wheel rim dimensions

*Wheel and rim dimensions are designated in accordance with the examples in the table below.*

The car has an approval for the complete vehicle. This means that certain combinations of wheel (wheel rim) and tyre are approved.

Wheels (rims) have a designation of dimensions, for example: 7Jx16x50.

7	Rim width in inches
J	Rim flange profile
16	Rim diameter in inches
50	Off-set in mm (distance from wheel centre to wheel contact surface against the hub)

## Related information

- Tyres - dimensions (p. 310)
- Tyres - approved tyre pressures (p. 407)

## Tyres - dimensions

*The car's wheels (wheel rims) and tyres have a certain dimension, see the examples in the table below.*

The car has an approval for the complete vehicle. This means that certain combinations of wheels (wheel rims) and tyres are approved.

The dimensions are stated on all car tyres.

**Example of designation:** 225/50R17 98W.

225	Tyre width (mm)
50	Ratio between tyre wall height and tyre width (%)
R	Radial ply
17	Rim diameter in inches (")
98	Codes for the maximum permitted tyre load, tyre load index (LI)
W	Speed rating for maximum permitted speed, speed rating (SS). (In this case 270 km/h.)



**WARNING**

19-inch wheels must **never** be used on cars that are **not** equipped with the R-Design or Sport chassis options. The use of 19-inch wheels on cars with **standard chassis** constitutes a safety risk, with a risk of vehicle damage, and it impairs the car's driving characteristics.

**Related information**

- Tyres - speed ratings (p. 311)
- Tyres - load index (p. 311)
- Tyres - direction of rotation (p. 306)
- Tyres - maintenance (p. 306)
- Tyres - approved tyre pressures (p. 407)
- Wheel and wheel rim dimensions (p. 310)

**Tyres - load index**

*Load index indicates a tyre's ability to carry a certain load.*

Each tyre has a certain capacity to carry a load, a load index (LI). The car's weight determines the load capacity required of the tyres. Minimum permissible index is indicated in the load index table.

**Related information**

- Tyres - dimensions (p. 310)
- Tyres - approved tyre pressures (p. 407)
- Tyres - speed ratings (p. 311)
- Tyres - maintenance (p. 306)

**Tyres - speed ratings**

*Each tyre can withstand a certain maximum speed and therefore belongs to a particular speed rating (SS - Speed Symbol).*

Tyre speed class must at least correspond with the car's top speed. Minimum speed rating is indicated in the speed rating table below. The only exception to these regulations is the winter tyre (p. 309)<sup>1</sup>, where a lower speed rating may be used. If such a tyre is chosen, the car must not be driven faster than the speed rating of the tyre (for example, class Q can be driven at a maximum of 160 km/h). Traffic regulations determine how fast a car can be driven, not the speed rating of the tyres.

**NOTE**

The maximum permitted speed is specified in the table.

Q	160 km/h (used only on winter tyres)
T	190 km/h
H	210 km/h
V	240 km/h

<sup>1</sup> Both metal-studded and studless tyres.



# 09 Wheels and tyres



W	270 km/h
Y	300 km/h

## WARNING

The car must be fitted with tyres which have the same or a higher load index (p. 311) (LI) and speed rating (SS) than specified. If a tyre with too low a load index or speed rating is used, it may over-heat.

### Related information

- Tyres - dimensions (p. 310)
- Tyres - load index (p. 311)
- Tyres - direction of rotation (p. 306)

## Changing wheels - removing wheels

*The car's wheels can be changed for e.g. winter wheels/winter tyres.*

### Spare wheel\*

The spare wheel (Temporary spare) is only intended for use temporarily and must be replaced by an ordinary wheel as soon as possible. The car's handling may be altered by the use of the spare wheel. The spare wheel is smaller than the normal wheel. The car's ground clearance is affected accordingly. Pay attention to high kerbs and do not machine wash the car. If the spare wheel is fitted on the front axle, you cannot use snow chains at the same time. On all-wheel drive cars the drive on the rear axle can be disconnected. The spare wheel must not be repaired.

The correct tyre pressure for the spare wheel is stated in the tyre pressure table (p. 407).

## IMPORTANT

- Never drive faster than 80 km/h with a spare wheel on the car.
- The car must never be driven fitted with more than one "Temporary Spare" wheel.

The spare wheel is located in the spare wheel well with the outside down. The same bolt runs through to secure the spare wheel and

the foam block. The foam block contains all the tools needed to change the wheels.

### Taking out the spare wheel under the cargo area floor

1. Fold up the cargo area floor, from the rear and forwards.
2. Undo the retaining screw.
3. Lift out the foam block with its tools.
4. Lift out the spare wheel.

### Removing

Set up warning triangle (p. 316) if a wheel is replaced in trafficked location. The car and jack\* must be on a firm horizontal surface.

1. Apply the parking brake, (p. 282) and engage reverse gear, or position **P** if the car has an automatic gearbox.

**! WARNING**

Check that the jack is not damaged, that the threads are thoroughly lubricated and that it is free from dirt.

**i NOTE**

Volvo recommends only using the jack\* that belongs to the car model in question, which is indicated on the jack's label.

The label also indicates the jack's maximum lift capacity at a specified minimum lifting height.

2. Take out the jack\*, wheel wrench\* and removal tool for the wheel covers\* located in the foam block. If another jack is selected, see Raising the car (p. 341).
3. Place chocks in front of and behind the wheels which will remain on the ground to prevent them from rolling. Use heavy wooden blocks or large stones for example.

4. Cars with steel rims have removable wheel covers. Use the removal tool to hook in and pull off any full-wheel wheel covers. Alternatively, the wheel covers can be pulled away by hand.

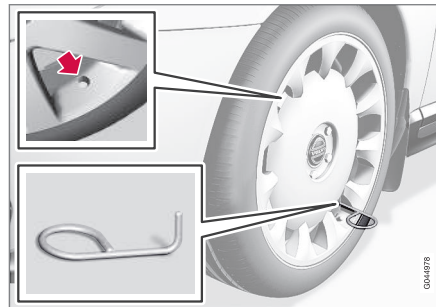

5. Screw together the towing eye with the wheel wrench\* until the stop position in accordance with the following figure.

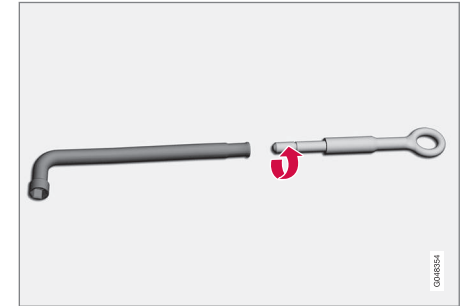
**! IMPORTANT**

The towing eye must be screwed into all threads in the wheel bolt wrench.

6. Loosen the wheel bolts  $\frac{1}{2}$ -1 turn anti-clockwise with the wheel wrench.



## **WARNING**

Never position anything between the ground and the jack, nor between the jack and the car's jacking point.

- There are two jacking points on each side of the car. There is a recess in the plastic cover at each point. Crank the foot of the jack down so it is pressed squarely on the ground.

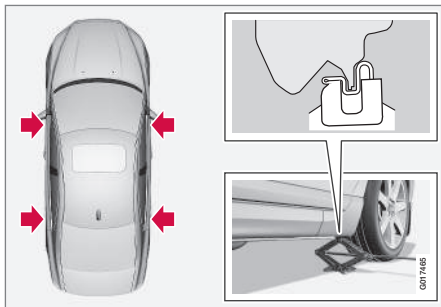

## **IMPORTANT**

The ground must be firm, smooth and level.

- Lift the car so that the wheel is free. Remove the wheel bolts and lift off the wheel.

## Related information

- Changing wheels - fitting (p. 314)
- Jack\* (p. 309)
- Warning triangle (p. 316)
- Wheel bolts (p. 308)

## Changing wheels - fitting

*It is important that the procedure for fitting the wheel is carried out correctly.*

### Installation

- Clean the contact surfaces between wheel and hub.
- Put on the wheel. Tighten the wheel bolts thoroughly.
- Lower the car so that the wheels cannot rotate.



- Tighten the wheel bolts crosswise. It is important that the wheel bolts are tightened properly. Tighten to 140 Nm. Check the torque with a torque wrench.
- Refit any full wheel covers.

**i NOTE**

- After a tyre has been inflated, always refit the dust cap in order to avoid damage to the valve from gravel, dirt, etc.
- Only use plastic dust caps. Metal dust caps can rust and become difficult to unscrew.

**i NOTE**

The wheel cover outlet for the valve must be positioned over the valve on the wheel rim during fitting.

**⚠ WARNING**

Never crawl under the car when it is raised on the jack.

Passengers must leave the car when it is raised on the jack.

Park the car such that passengers have the car, or ideally a crash barrier, between themselves and the roadway.

**i NOTE**

The car's regular jack is designed only for use occasionally and for a short time, such as when changing a wheel with a punctured tyre, switching between summer tyres and winter tyres, etc. Only the jack belonging to the specific model is to be used to jack up the car. If the car is to be jacked up more often, or for a longer time than is required just to change a wheel, use of a garage jack is recommended. In this instance, follow the instructions for use that come with the equipment.

**Related information**

- Changing wheels - removing wheels (p. 312)
- Jack\* (p. 309)
- Warning triangle (p. 316)
- Wheel bolts (p. 308)

**Tyres - air pressure**

*Tyres can have different air pressures which are measured in bar.*

**Check the air pressure in the tyres**

The tyre pressures must be checked every month.

This also applies to the car's spare wheel.

- Tyre pressure for the car's recommended tyre dimension
- ECO pressure<sup>2</sup>
- Spare wheel tyre pressure (Temporary Spare)

<sup>2</sup> ECO pressure results in improved fuel economy.



## **i** NOTE

- Check the tyre pressure when the tyres are cold. "Cold tyres" means that the tyres are at the same temperature as the outdoor temperature. The tyres will heat up and the tyre pressures will increase after driving for a few kilometres.
- Tyre pressures which are too low will increase fuel consumption, reduce tyre service life and impair the car's handling. Driving with tyre pressures which are too low may lead to the tyres overheating and sustaining damage. Tyre pressures affect ride comfort, road noise and steering.
- Tyre pressure decreases over time, this is a natural phenomenon. Tyre pressure also varies depending on ambient temperature.

### Tyre pressure label



The tyre pressure label on the driver's side door pillar (between frame and rear door) shows which pressures the tyres should have at different loads and speed conditions. This is also specified in the tyre pressure table, see Tyres - approved tyre pressures (p. 407).

### Fuel economy, ECO pressure

In order to obtain optimum fuel economy at speeds below 160 km/h an ECO pressure is recommended (applies to both full and light load), see Tyres - approved tyre pressures (p. 407).

### Related information

- Tyres - dimensions (p. 310)
- Tyres - speed ratings (p. 311)
- Tyres - load index (p. 311)
- Tyres - maintenance (p. 306)
- Tyres - tread wear indicators (p. 308)

### Warning triangle

The warning triangle is used to warn other road users of a stationary vehicle.

### Storage and folding up

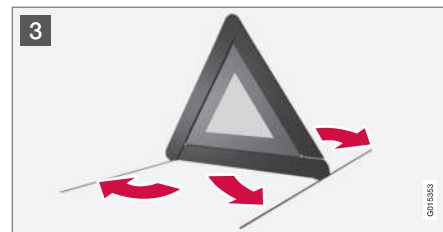
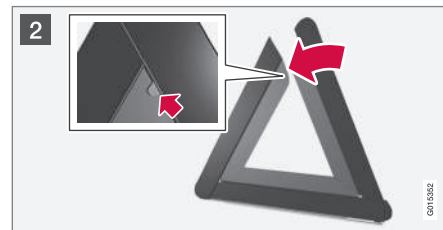

The warning triangle is fitted on the inside of the boot lid with two clips.

- 1 Detach the warning triangle case by pulling both of the snap latches outwards.
- 2 Take the warning triangle from the case, fold out and assemble the two loose sides.
- 3 Fold out the warning triangle's support legs.

Follow the regulations for the use of a warning triangle. Position the warning triangle in a suitable place with regard to traffic.

Ensure the warning triangle and its case are properly secured in the cargo area after use.

### First aid kit\*

The first aid box contains first aid equipment.

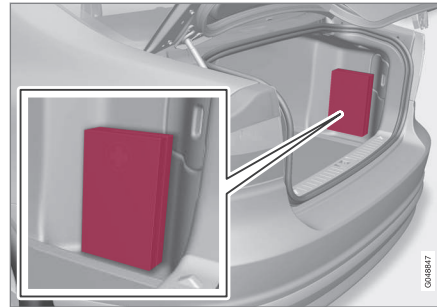

A case with first aid equipment is located in the cargo area.

### Tyre pressure monitoring\*<sup>3</sup>

Tyre pressure monitoring warns the driver when the pressure is too low in one or more of the car's tyres. For certain markets the tyre pressure monitoring is standard in accordance with legal requirements.

There are two systems for tyre pressure monitoring, TPMS (Tyre Pressure Monitoring System) and TM (Tyre Monitor). In the event of uncertainty about which system the car has, open the menu system **MY CAR** and search for the car's settings:

- The **Tyre pressure** menu is used if it is TPMS, see TPMS (Tyre Pressure Monitoring System)\* - general (p. 318)
- The **Tyre monitoring** menu is used if it is TM, see TM (Tyre Monitor)\* (p. 323).

The system does not replace normal tyre maintenance.

### Related information

- TPMS (Tyre Pressure Monitoring System)\* - general (p. 318)
- TPMS (Tyre Pressure Monitoring System)\* - adjusting (recalibration) (p. 319)
- TPMS (Tyre Pressure Monitoring System)\* - rectifying low tyre pressure (p. 322)
- TPMS (Tyre Pressure Monitoring System)\* - activate/deactivate (p. 321)

<sup>3</sup> Standard in certain markets.



- TPMS (Tyre Pressure Monitoring System)\* - recommendations (p. 321)
- TPMS (Tyre Pressure Monitoring System)\* - driveable punctured tyres\* (p. 322)

## TPMS (Tyre Pressure Monitoring System)\*<sup>10</sup> - general

*Tyre pressure monitoring (TPMS) (Tyre Pressure Monitoring System)\* warns the driver when the pressure is too low in one or more of the car's tyres.*

Tyre pressure monitoring uses sensors located inside the air valve in each wheel. When the car is driven at about 30 km/h the system detects the tyre pressure. If the pressure is too low then a warning lamp  illuminates in the combined instrument panel and one of the following messages is shown:

- **Tyre pressure low Check front right tyre**
- **Tyre pressure low Check front left tyre**
- **Tyre pressure low Check rear right tyre**
- **Tyre pressure low Check rear left tyre**
- **Tyre needs air now Check front right tyre**
- **Tyre needs air now Check front left tyre**
- **Tyre needs air now Check rear right tyre**
- **Tyre needs air now Check rear left tyre**

- **Tyre pressure system Service required**

Both factory-fitted and optional wheels can be equipped with TPMS sensors in the valves.

If wheels without TPMS sensors are used or if a sensor has failed then **Tyre pressure system Service required** will be shown.

Always check the system after changing a wheel in order to ensure that replacement wheels work with the system.

For information on the correct tyre pressure, see Tyres - air pressure (p. 315).

The system does not replace normal tyre maintenance.



### IMPORTANT

If a fault occurs in the TPMS system the warning lamp  in the combined instrument panel will flash for approx. 1 minute and then illuminate with a constant glow. A message is also shown in the combined instrument panel.

### Related information

- TPMS (Tyre Pressure Monitoring System)\* - adjusting (recalibration) (p. 319)
- TPMS (Tyre Pressure Monitoring System)\* - rectifying low tyre pressure (p. 322)

<sup>10</sup> Standard in certain markets.





- TPMS (Tyre Pressure Monitoring System)\*  
- activate/deactivate (p. 321)
- TPMS (Tyre Pressure Monitoring System)\*  
- recommendations (p. 321)
- TPMS (Tyre Pressure Monitoring System)\*  
- driveable punctured tyres\* (p. 322)

### TPMS (Tyre Pressure Monitoring System)\*<sup>16</sup> - adjusting (recalibration)

*Tyre pressure monitoring (TPMS) (Tyre Pressure Monitoring System)\* warns the driver when the pressure is too low in one or more of the car's tyres.*

*TPMS can be adjusted in order to follow Volvo's tyre pressure recommendations (p. 315), when driving with a heavy load for example.*



#### NOTE

The car must be stationary when calibration is started.

Settings are made using the centre console's controls, see MY CAR (p. 108).

1. Inflate the tyres to the desired pressure in accordance with the tyre pressure label on the driver's side door pillar (between front and rear doors).
2. Start the engine.
3. Select the menu system **MY CAR** to open the menus for tyre pressure.
4. Select **Calibrate tyre pressure** and press **OK**.

5. Drive for at least 10 minutes at a speed of at least 30 km/h.
  - > Calibration is performed automatically following initialisation by the driver. The system provides no confirmation when the calibration is complete.

The new reference values apply until steps 1-5 are carried out again.

#### Related information

- Tyre pressure monitoring\* (p. 317)
- Tyres - air pressure (p. 315)

<sup>16</sup> Standard in certain markets.



## TPMS (Tyre Pressure Monitoring System)\*<sup>18</sup> - status

*Tyre pressure monitoring (TPMS) (Tyre Pressure Monitoring System)\* warns the driver when the pressure is too low in one or more of the car's tyres.*

### System and tyre status

The current status of the system and the tyres can be checked, see MY CAR (p. 108).

1. Select the menu system **MY CAR** to open the menus for tyre monitoring.
2. Select **Tyre pressure**.

The status is colour-coded for each tyre in accordance with the following:

- All-green: the system is operating normally and the tyre pressure in all tyres is slightly above the recommended level.
- Yellow wheel: corresponding tyre's pressure is too low.
- Red wheel: corresponding tyre's pressure is very low.
- All wheels grey: the system is temporarily unavailable. It may be necessary to drive the car for a few minutes at a speed above 30 km/h before the system becomes active again.
- All wheels grey and the message **Tyre pressure system Service required**: an

error has occurred in the system. Contact a Volvo dealer or workshop.

### Clearing warning messages

If a tyre pressure message has been shown and the TPMS warning lamp has been illuminated:

1. Check the tyre pressure on the indicated tyre/tyres with a tyre pressure gauge.
2. Inflate the tyre/tyres to the correct pressure in accordance with the tyre pressure label on the driver's side door pillar (between front and rear doors).
3. In some cases it may be necessary to drive the car for a few minutes at a speed above 30 km/h in order to clear the warning text. At which point, the TPMS warning lamp is extinguished as well.



### NOTE

- The TPMS system uses a so-called compensated pressure value, based on both tyre temperature and ambient temperature. This means that the tyre pressure may differ slightly from the recommended pressures listed on the tyre pressure label on the driver's side door pillar (between front and rear doors). For this reason, it may be necessary to inflate the tyres to a slightly higher pressure in order to clear a low tyre pressure message.
- To avoid incorrect tyre pressure, the pressure should be checked on cold tyres. "Cold tyres" means the tyres are the same temperature as the ambient temperature (approx. 3 hours after the car has been driven). After a few kilometres of driving, the tyres warm up and the pressure increases.



### WARNING

- Incorrect tyre pressure may lead to tyre failure, which could result in the driver losing control of the car.
- The system cannot indicate sudden tyre damage in advance.

<sup>18</sup> Standard in certain markets.

\* Option/accessory, for more information, see Introduction.



### TPMS (Tyre Pressure Monitoring System)\*<sup>19</sup> - activate/deactivate

*Tyre pressure monitoring (TPMS) (Tyre Pressure Monitoring System)\* warns the driver when the pressure is too low in one or more of the car's tyres.*

#### NOTE

The car must be stationary when the tyre pressure monitoring is activated/deactivated.

Settings are made using the centre console's controls, see MY CAR (p. 108).

1. Start the engine.
2. Select the menu system **MY CAR** to open the menus for tyre pressure.
3. Select **Tyre pressure** and press **OK**.
  - > An **X** is shown in the information display if the system is activated, the option disappears if the system is deactivated<sup>20</sup>.

#### Related information

- Tyre pressure monitoring\* (p. 317)

<sup>19</sup> Standard in certain markets.

<sup>20</sup> Only in certain markets.

<sup>22</sup> Standard in certain markets.

### TPMS (Tyre Pressure Monitoring System)\*<sup>22</sup> - recommendations

*Tyre pressure monitoring (TPMS) (Tyre Pressure Monitoring System)\* warns the driver when the pressure is too low in one or more of the car's tyres.*

- Volvo recommends that TPMS sensors are fitted to all wheels on the car, including winter wheels.
- Volvo recommends that sensors are not moved between different wheels.
- The spare wheel is not equipped with a TPMS sensor.
- If the spare wheel or a wheel without a TPMS sensor is used, the error message **Tyre pressure system Service required** will be shown in the combined instrument panel.
- If a wheel has been changed, or if the TPMS sensor has been moved to another wheel then the seal, nut and valve core must be replaced.
- When TPMS sensors are installed, the car should be switched off for at least 15 minutes otherwise an error message will be shown in the combined instrument panel.

#### WARNING

When inflating a tyre equipped with TPMS, hold the nozzle of the pump directly against the valve to avoid damaging the valve.

#### NOTE

- After a tyre has been inflated, always refit the dust cap in order to avoid damage to the valve from gravel, dirt, etc.
- Only use plastic dust caps. Metal dust caps can rust and become difficult to unscrew.

#### NOTE

If you want to change the tyre dimension then the TPMS system must be reconfigured. For further information - contact a Volvo dealer.

#### Related information

- Tyre pressure monitoring\* (p. 317)



## TPMS (Tyre Pressure Monitoring System)\*<sup>24</sup> - driveable punctured tyres\*

If SST (Self Supporting run flat Tyres)\* is selected, the car is also equipped with TPMS (p. 317).

This type of tyre has a specially reinforced side wall that makes continued driving possible to a limited extent despite the tyre losing all or some of its pressure. These tyres are fitted on a special rim. (Normal tyres can also be fitted to this rim.)

If an SST tyre loses tyre pressure then the yellow TPMS lamp in the combined instrument panel illuminates and a message is shown in the information display. If this occurs, reduce speed to max. 80 km/h. The tyre must be replaced as soon as possible.

Drive carefully, in some cases it can be difficult to see which tyre is faulty. In order to establish which tyre needs attention, check all four tyres.

### WARNING

Only people with knowledge of SST tyres should fit them.

SST tyres must only be fitted together with TPMS.

After an error message about low tyre pressure has been shown, do not drive faster than 80 km/h.

Maximum mileage before tyre replacement is 80 km.

Avoid hard driving such as sudden braking or turning.

SST tyres must be replaced if they are damaged or punctured.

#### Related information

- Tyre pressure monitoring\* (p. 317)

## TPMS (Tyre Pressure Monitoring System)\*<sup>26</sup> - rectifying low tyre pressure

The tyre pressure monitoring system TPMS (Tyre Pressure Monitoring System)<sup>27</sup> warns the driver when the pressure is too low in one or more of the car's tyres and indicates the tyre to which it applies. The lamp illuminates in yellow at the first indication, stop and check the tyre pressure as soon as possible. When the lamp illuminates in red you must stop and rectify the tyre pressure immediately.

If a message for low tyre pressure is shown in the display:

1. Check the tyre pressure on the tyre in question.
2. Inflate the tyre(s) to the correct pressure.
3. Drive at least at 30 km/h for several minutes and check that the message disappears.

#### Related information

- Tyre pressure monitoring\* (p. 317)

<sup>24</sup> Standard in certain markets.

<sup>26</sup> Standard in certain markets.

<sup>27</sup> Option only in certain markets.



## TM (Tyre Monitor)\*<sup>29</sup>

The TM (Tyre Monitor) system senses tyre rotation speed in order to determine whether the tyres have the correct tyre pressure. If the pressure is too low, the tyre's diameter is changed and, as a result, so is the rotation speed. By comparing the tyres with each other the system can determine whether one or more tyres have pressure that is too low.

### Messages

If the tyre pressure is too low then a warning lamp () illuminates in the combined instrument panel and one of the following messages is shown:

- Tyre pressure low Check front right tyre
- Tyre pressure low Check front left tyre
- Tyre pressure low Check rear right tyre
- Tyre pressure low Check rear left tyre
- Tyre pressure low Check tyres
- Tyre pressure system Service required



### IMPORTANT

If a fault occurs in the TM system the warning lamp () in the combined instrument panel will flash for approx. 1 minute and then illuminate with a constant glow. A message is also shown in the combined instrument panel.

The system does not replace normal tyre maintenance.

### TM recalibration

In order for TM to work correctly, a reference value for the tyre pressure must be determined. This must be performed each time the tyres are changed or the tyre pressure is changed.

### Recalibration

Settings are made using the centre console's controls, see MY CAR (p. 108).

1. Switch off the ignition.
2. Inflate the tyres to the desired pressure in accordance with the tyre pressure label on the driver's side door pillar (between front and rear doors) and select key position **II**, see Key positions - functions at different levels (p. 74).
3. Select the menu system **MY CAR** to open the menus for tyre monitoring.

4. Select **Calibrate tyre pressure** and press **OK**.
5. Start and drive the car.
  - > Recalibration is carried out while the car is being driven and can be interrupted at any time. If the engine is switched off while recalibration is in progress then it is resumed when the car is driven again.

TM is then recalibrated and the new reference value applies until steps 1-5 are carried out again.



### NOTE

Remember that the TM system must be recalibrated at each tyre change or if the tyre pressure is changed. If new reference values are not stored then the system cannot function properly.



### NOTE

- After a tyre has been inflated, always refit the dust cap in order to avoid damage to the valve from gravel, dirt, etc.
- Only use plastic dust caps. Metal dust caps can rust and become difficult to unscrew.

<sup>29</sup> Standard in certain markets.



## System and tyre status

The current status of the system and the tyres can be checked, see MY CAR (p. 108).

1. Select the menu system **MY CAR** to open the menus for tyre monitoring.
2. Select **Tyre monitoring**.

The status is colour-coded for each tyre in accordance with the following:

- All-green: the system is operating normally and the tyre pressure in all tyres is slightly above the recommended level.
- Yellow wheel: corresponding tyre's pressure is too low.
- All wheels yellow: two or more tyres have pressure that is too low.
- All wheels grey: the system is temporarily unavailable. It may be necessary to drive the car for a few minutes at a speed above 30 km/h before the system becomes active again.
- All wheels grey and the message **Tyre pressure system Service required**: an error has occurred in the system. Contact a Volvo dealer or workshop.

## Clearing warning messages

If a tyre pressure message has been shown and the TM warning lamp has been illuminated:

1. Check the tyre pressure on the indicated tyre/tyres with a tyre pressure gauge.
2. Inflate the tyre/tyres to the correct pressure in accordance with the tyre pressure label on the driver's side door pillar (between front and rear doors).
3. Recalibrate the TM system.



## NOTE

- The TM system uses a so-called compensated pressure value, based on both tyre temperature and ambient temperature. This means that the tyre pressure may differ slightly from the recommended pressures listed on the tyre pressure label on the driver's side door pillar (between front and rear doors). For this reason, it may be necessary to inflate the tyres to a slightly higher pressure in order to clear a low tyre pressure message.
- To avoid incorrect tyre pressure, the pressure should be checked on cold tyres. "Cold tyres" means the tyres are the same temperature as the ambient temperature (approx. 3 hours after the car has been driven). After a few kilometres of driving, the tyres warm up and the pressure increases.



## WARNING

- Incorrect tyre pressure may lead to tyre failure, which could result in the driver losing control of the car.
- The system cannot indicate sudden tyre damage in advance.



### Emergency puncture repair\*

*Emergency puncture repair, where the emergency puncture repair kit (TMK - Temporary Mobility Kit) is used to seal a puncture and check and adjust the tyre pressure (p. 407).*

The emergency puncture repair kit (p. 326) consists of a compressor and a bottle of sealant. The sealing works as a temporary repair. The sealing fluid bottle must be replaced before its expiration date and after use. The sealing fluid effectively seals tyres punctured in the tread.

#### **i** NOTE

The emergency puncture repair kit is only intended for sealing tyres with a puncture in the tread.

The emergency puncture repair kit has limited capacity to seal tyres which have punctures in the wall. Do not seal tyres with the emergency puncture repair kit if they have larger slits, cracks or similar damage. Connect the compressor to one of the car's 12 V sockets. Choose the socket that is nearest to the punctured tyre.

#### **i** IMPORTANT

If the compressor for emergency puncture repair is connected to one of the two sockets (p. 148) in the tunnel console then no other current consumer may be connected to the other one.

#### **i** NOTE

The compressor for temporary emergency puncture repair has been tested and approved by Volvo.

#### Related information

- Emergency puncture repair\* - operation (p. 327)
- Emergency puncture repair\* - rechecking (p. 328)
- Emergency puncture repair kit\* - overview (p. 326)
- Tools (p. 308)

### Emergency puncture repair kit\* - location

*Emergency puncture repair kit (TMK - Temporary Mobility Kit) is used to seal a puncture and check and adjust the tyre pressure (p. 407).*

#### Location of the emergency puncture repair kit

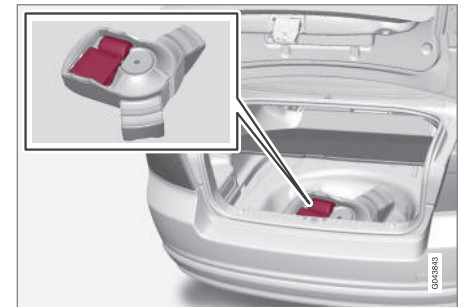

The emergency puncture repair kit is located under the floor in the cargo area.

Set up the warning triangle (p. 316) if a tyre is being sealed in a trafficked location.

#### **i** NOTE

The emergency puncture repair kit is only intended for sealing tyres with a puncture in the tread.



## ! IMPORTANT

If the compressor for emergency puncture repair is connected to one of the two sockets (p. 148) in the tunnel console then no other current consumer may be connected to the other one.

## i NOTE

The compressor for temporary emergency puncture repair has been tested and approved by Volvo.

### Related information

- Emergency puncture repair kit\* - overview (p. 326)
- Emergency puncture repair kit\* - sealant (p. 330)
- Emergency puncture repair\* (p. 325)

## Emergency puncture repair kit\* - overview

*Emergency puncture repair, where the emergency puncture repair kit (TMK - Temporary Mobility Kit) is used to seal a puncture and check and adjust the tyre pressure (p. 407).*

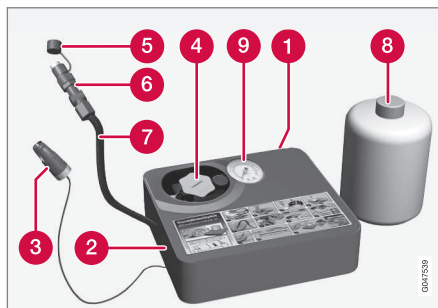

- 1 Label, maximum permitted speed
- 2 Switch
- 3 Cable
- 4 Bottle holder (orange cap)
- 5 Protective cap
- 6 Pressure reducing valve
- 7 Air hose
- 8 Sealing fluid bottle
- 9 Pressure gauge

### Related information

- Emergency puncture repair kit\* - location (p. 325)
- Emergency puncture repair kit\* - sealant (p. 330)
- Emergency puncture repair\* (p. 325)





## Emergency puncture repair\* - operation

Emergency puncture repair, where the emergency puncture repair kit (TMK - Temporary Mobility Kit) is used to seal a puncture and check and adjust the tyre pressure (p. 407).

### Emergency puncture repair

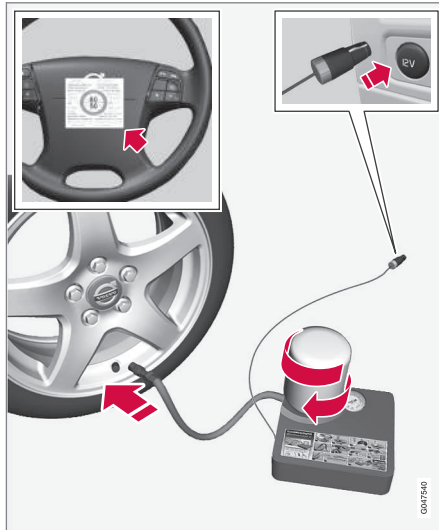

For information on the function of the parts, see *Emergency puncture repair kit\* - overview* (p. 326).

1. Detach the label for maximum permitted speed (which is fitted on one side of the compressor) and affix it to the steering wheel.

#### WARNING

You should not drive faster than 80 km/h after the emergency tyre repair kit has been used. Volvo recommends that you visit an authorised Volvo workshop for inspection of the sealed tyre (maximum driving distance is 200 km). The staff there can determine whether or not the tyre can be repaired or if it needs to be replaced.

#### WARNING

The sealing fluid can irritate the skin. In the case of contact with skin, wash away the fluid with soap and water.

2. Check that the switch is in position **0** and locate the cable and the air hose.

#### NOTE

Do not break the bottle's seal before use. The seal is broken automatically when the bottle is screwed in.

3. Unscrew the orange cap and unscrew the bottle's stopper.

4. Screw the bottle into its holder.

#### WARNING

Do not unscrew the bottle, it is equipped with a reverse catch to prevent leakage.

5. Connect the hose from the compressor to the valve.
6. Plug the cable into the 12 V socket and start the car.

#### NOTE

If the compressor is connected to one of the two 12 V sockets in the tunnel console then no other current consumer may be connected to the other one.

#### WARNING

Do not leave children in the car without supervision when the engine is running.



7. Flick the switch to position I.

## WARNING

Never stand next to the tyre when the compressor is running. If cracks or unevenness arise then the compressor must be switched off immediately. The journey should not be continued. Contacting an authorised tyre centre is recommended.

## NOTE

When the compressor starts, the pressure can increase up to 6 bar but the pressure drops after approximately 30 seconds.

8. Inflate the tyre for 7 minutes.

## IMPORTANT

Risk of overheating. The compressor must not run for more than 10 minutes.

9. Switch off the compressor to check the pressure on the pressure gauge. Minimum pressure is 1.8 bar and maximum 3.5 bar. (Release air with the pressure reducing valve if the tyre pressure is too high.)

## WARNING

If the pressure is below 1.8 bar then the hole in the tyre is too big. The journey should not be continued. Contacting an authorised tyre centre is recommended.

10. Switch off the compressor and unplug the cable from the 12 V socket.

11. Detach the hose from the tyre valve and fit the valve cap.

12. As soon as possible, drive approximately 3 km at a maximum speed of 80 km/h so that the sealing fluid can seal the tyre.

### Related information

- Emergency puncture repair\* (p. 325)
- Emergency puncture repair\* - rechecking (p. 328)
- Emergency puncture repair kit\* - overview (p. 326)

## Emergency puncture repair\* - rechecking

*Emergency puncture repair, where the emergency puncture repair kit (TMK - Temporary Mobility Kit) is used to seal a puncture and check and adjust the tyre pressure (p. 407).*

### Check tyre pressure

1. Reconnect the equipment.
2. Read the tyre pressure on the pressure gauge.
  - If it is below 1.3 bar<sup>30</sup> then the tyre is insufficiently sealed. The journey should not be continued. Contact a tyre centre.
  - If the tyre pressure is higher than 1.3 bar<sup>30</sup>, the tyre must be inflated to the pressure specified in accordance with the tyre pressure table, see Tyres - approved tyre pressures (p. 407). Release air using the pressure reducing valve if the tyre pressure is too high.

<sup>30</sup> 1 bar = 100 kPa.

**! WARNING**

Do not unscrew the bottle, it is equipped with a reverse catch to prevent leakage.

3. Make sure the compressor is switched off. Detach the air hose and cable.

Fit the valve cap.

**i NOTE**

- After a tyre has been inflated, always refit the dust cap in order to avoid damage to the valve from gravel, dirt, etc.
- Only use plastic dust caps. Metal dust caps can rust and become difficult to unscrew.

**i NOTE**

The sealing fluid bottle and the hose must be replaced after use. Volvo recommends that this replacement is performed by an authorised Volvo workshop.

**! WARNING**

Check the tyre pressure regularly.

Volvo recommends that you drive to the nearest authorised Volvo workshop for the replacement/repair of the damaged tyre.

Advise the workshop that the tyre contains sealing fluid.

**! WARNING**

You should not drive faster than 80 km/h after the emergency tyre repair kit has been used. Volvo recommends that you visit an authorised Volvo workshop for inspection of the sealed tyre (maximum driving distance is 200 km). The staff there can determine whether or not the tyre can be repaired or if it needs to be replaced.

**Related information**

- Emergency puncture repair\* (p. 325)
- Emergency puncture repair\* - operation (p. 327)
- Emergency puncture repair kit\* - overview (p. 326)

**Emergency puncture repair kit\* - inflating the tyres**

*The car's original tyres can be inflated using the compressor in the emergency puncture repair kit (p. 326).*

1. The compressor must be switched off. Make sure that the switch is in position **O** and locate the cable and air hose.
2. Unscrew the wheel's dust cap and screw in the air hose valve connection to the bottom of the thread on the tyre's air valve.

**! WARNING**

Inhaling car exhaust fumes could result in danger to life. Never leave the engine running in sealed areas or areas that lack sufficient ventilation.

**! WARNING**

Do not leave children in the car without supervision when the engine is running.

3. Connect the cable to one of the car's 12 V sockets and start the car.
4. Start the compressor by flicking the switch to position **I**.



## **IMPORTANT**

Risk of overheating. The compressor must not run for more than 10 minutes.

- Inflate the tyre to the pressure specified in accordance with the tyre pressure table, Tyres - approved tyre pressures (p. 407). Release air using the pressure reducing valve if the tyre pressure is too high.
- Switch off the compressor Detach the air hose and cable.
- Refit the dust cap.

### **Related information**

- Emergency puncture repair\* (p. 325)
- Emergency puncture repair kit\* - overview (p. 326)
- Emergency puncture repair\* - rechecking (p. 328)

## **Emergency puncture repair kit\* - sealant**

*The container (bottle) with the emergency puncture repair kit (p. 326) contains sealant and it can be replaced.*

Replace the bottle when the expiration date has passed. Treat the old bottle as environmentally hazardous waste.

## **WARNING**

The bottle contains 1,2-Ethanol and natural rubber-latex.

Harmful if ingested. Could result in allergic reaction in the event of skin contact.

Avoid contact with the skin and eyes.

Store out of the reach of children.

### **Related information**

- Emergency puncture repair\* (p. 325)



### **Type approval - tyre pressure monitoring**

*Type approval of the sensors in tyre pressure monitoring - TPMS (Tyre Pressure Monitoring System)\* can be read in the table.*







# 09 Wheels and tyres

09



Country/Area	
Brazil	<div data-bbox="560 232 876 445" style="border: 1px solid black; padding: 10px; text-align: center;"><p>Modelo: S180052050</p><p>Agência Nacional de Telecomunicações 1542-12-2149</p><p>(01) 07894476056448</p><div style="border: 1px solid black; padding: 2px; font-size: 8px; margin: 5px auto; width: 80%;"><p>Este equipamento opera em caráter secundário, isto é, não tem direito a proteção contra interferência prejudicial, mesmo de estações do mesmo tipo, e não pode causar interferência a sistemas operando em caráter primário.</p></div></div> <div data-bbox="906 434 922 471" style="text-align: right; font-size: 8px;">000090</div>
Ukraine	<div data-bbox="587 538 847 799" style="border: 2px solid black; border-radius: 15px; padding: 10px; text-align: center;"></div> <div data-bbox="906 766 922 803" style="text-align: right; font-size: 8px;">000091</div>



Country/Area	
Israel	<div data-bbox="497 185 936 488" style="border: 1px solid black; padding: 10px;"><p data-bbox="587 204 847 227">שם הדגם (Hebrew:Model name)</p><p data-bbox="655 240 778 263">S180052050</p><p data-bbox="507 288 927 311">שם היצרן וכתובתו (Hebrew:Manufacturer and address)</p><p data-bbox="627 333 807 412">Continental AG Siemensstraße 12 93055 Regensburg</p><p data-bbox="906 437 919 471" style="writing-mode: vertical-rl; transform: rotate(180deg);">0001054</p></div>



# 09 Wheels and tyres

09



## Declaration of Conformity (Declaration of Conformity)

### Country/ Area

Countries in the EU:



Exporting country: Germany

Manufacturer: Continental Automotive GmbH

Type of equipment: TPMS unit

**Continental**  
Continental Automotive GmbH - Postfach 10 15 60 - 33094 Hannover

Chief of Office  
 183 POC 171P 180  
 Phone: +49 (0)41 750-2542  
 Fax: +49 (0)41 750-2542  
 Email: [prod\\_kund@continental-corporation.com](mailto:prod_kund@continental-corporation.com)

To: April 16, 2012      For message used: TGIC Valve      For Reference:      For reference:

**Declaration of Conformity in accordance with Directive 1999/5/EC (R&TTE Directive)**

Manufacturer: Continental Automotive GmbH  
 Address: Siemensstrasse 12  
 D-33094 Hagenberg  
 Germany

Product type designation: 816000350  
 Intended use: Tire Pressure Monitoring Sensor

The product mentioned above complies with the essential requirements and other relevant provisions of Directive 1999/5/EC, when used for its intended purposes.

Health and safety pursuant to Art. 3(1)(a):      **Applied standard(s):**  
 EN 60 800-1:2006 + A11:2009  
 + A2:2010 + A3:2011  
 EN 62 479:2010

Electromagnetic compatibility pursuant to Art. 3(1)(b):      **Applied standard(s):**  
 EN 301 489-1 V1.8.1 (2006-04)  
 EN 301 489-3 V1.4.1 (2002-08)

Efficient use of spectrum pursuant to Art. 3(2):      **Applied standard(s):**  
 EN 300 220-1 V2.3.1 (2010-02)  
 EN 300 220-2 V2.3.1 (2010-02)

The following marking applies to the above-mentioned product:

Continental Automotive GmbH  
 Hagenberg, 33123-04-18

*Wey*      *Moll*

Andreas Wey      Norbert Moll  
 Executive Vice President      Cluster Product Group 1  
 Body & Security      Body & Security

Continental Automotive GmbH      Phone: +49 (0)41 750-2542      Fax: +49 (0)41 750-2542      Email: [prod\\_kund@continental-corporation.com](mailto:prod_kund@continental-corporation.com)

Continental Automotive GmbH      Phone: +49 (0)41 750-2542      Fax: +49 (0)41 750-2542      Email: [prod\\_kund@continental-corporation.com](mailto:prod_kund@continental-corporation.com)

Continental Automotive GmbH      Phone: +49 (0)41 750-2542      Fax: +49 (0)41 750-2542      Email: [prod\\_kund@continental-corporation.com](mailto:prod_kund@continental-corporation.com)

00011903





Country/ Area	
Czech Republic:	Continental tímto prohlašuje, že tento Radio Transmitter je ve shodě se základními požadavky a dalšími příslušnými ustanoveními směrnice 1999/5/ES.
Denmark:	Undertegnede Continental erklærer herved, at følgende udstyr Radio Transmitter overholder de væsentlige krav og øvrige relevante krav i direktiv 1999/5/EF.
Germany:	Hiermit erklärt Continental, dass sich das Gerät Radio Transmitter in Übereinstimmung mit den grundlegenden Anforderungen und den übrigen einschlägigen Bestimmungen der Richtlinie 1999/5/EG befindet.
Estonia:	Käesolevaga kinnitab Continental seadme Radio Transmitter vastavust direktiivi 1999/5/EÜ põhinõuetele ja nimetatud direktiivist tulenevatele teistele asjakohastele sätetele.
UK	Hereby, Continental declares that this Radio Transmitter is in compliance with the essential requirements and other relevant provisions of Directive 1999/5/EC.
Spain:	Por medio de la presente Continental declara que el Radio Transmitter cumple con los requisitos esenciales y cualesquiera otras disposiciones aplicables o exigibles de la Directiva 1999/5/CE.
Greece:	ΜΕ ΤΗΝ ΠΑΡΟΥΣΑ Continental ΔΗΛΩΝΕΙ ΟΤΙ Radio Transmitter ΣΥΜΜΟΡΦΩΝΕΤΑΙ ΠΡΟΣ ΤΙΣ ΟΥΣΙΩΔΕΙΣ ΑΠΑΙΤΗΣΕΙΣ ΚΑΙ ΤΙΣ ΛΟΙΠΕΣ ΣΧΕΤΙΚΕΣ ΔΙΑΤΑΞΕΙΣ ΤΗΣ ΟΔΗΓΙΑΣ 1999/5/ΕΚ.
France:	Par la présente Continental déclare que l'appareil Radio Transmitter est conforme aux exigences essentielles et aux autres dispositions pertinentes de la directive 1999/5/CE.
Italy:	Con la presente Continental dichiara che questo Radio Transmitter è conforme ai requisiti essenziali ed alle altre disposizioni pertinenti stabilite dalla direttiva 1999/5/CE.
Latvia:	Ar šo Continental deklarē, ka Radio Transmitter atbilst Direktīvas 1999/5/EK būtiskajām prasībām un citiem ar to saistītajiem noteikumiem.
Lithuania:	Šiuo Continental deklaruoja, kad šis Radio Transmitter atitinka esminius reikalavimus ir kitas 1999/5/EB Direktyvos nuostatas.
Netherlands:	Hierbij verklaart Continental dat het toestel Radio Transmitter in overeenstemming is met de essentiële eisen en de andere relevante bepalingen van richtlijn 1999/5/EG.



## 09 Wheels and tyres



Country/ Area	
Malta:	Hawnhekk, Continental, jiddikjara li dan Radio Transmitter jikkonforma mal-htigijiet essenzjali u ma provvedimenti oħrajn relevanti li hemm fid-Dirrettiva 1999/5/EC.
Hungary:	Alulírott, Continental nyilatkozom, hogy a Radio Transmitter megfelel a vonatkozó alapvető követelményeknek és az 1999/5/EC irányelv egyéb előírásainak.
Poland:	Niniejszym Continental oświadcza, że Radio Transmitter jest zgodny z zasadniczymi wymogami oraz pozostałymi stosownymi postanowieniami Dyrektywy 1999/5/EC.
Portugal:	Continental declara que este Radio Transmitter está conforme com os requisitos essenciais e outras disposições da Directiva 1999/5/CE.
Slovenia:	Continental izjavlja, da je ta Radio Transmitter v skladu z bistvenimi zahtevami in ostalimi relevantnimi določili direktive 1999/5/ES.
Slovakia:	Continental týmto vyhlasuje, že Radio Transmitter spĺňa základné požiadavky a všetky príslušné ustanovenia Smernice 1999/5/ES.
Finland:	Continental vakuuttaa täten että Radio Transmitter tyypinen laite on direktiivin 1999/5/EY oleellisten vaatimusten ja sitä koskevien direktiivin muiden ehtojen mukainen.
Sweden:	Härmed intygar Continental att denna Radio Transmitter står i överensstämmelse med de väsentliga egenskapskrav och övriga relevanta bestämmelser som framgår av direktiv 1999/5/EG.
Iceland:	Hér með lýsir Continental yfir því að Radio Transmitter er í samræmi við grunnkröfur og aðrar kröfur, sem gerðar eru í tilskipun 1999/5/EC.
Norway:	Continental erklærer herved at utstyret Radio Transmitter er i samsvar med de grunnleggende krav og øvrige relevante krav i direktiv 1999/5/EF.

### Related information

- Tyre pressure monitoring\* (p. 317)

# 10

## MAINTENANCE AND SERVICE

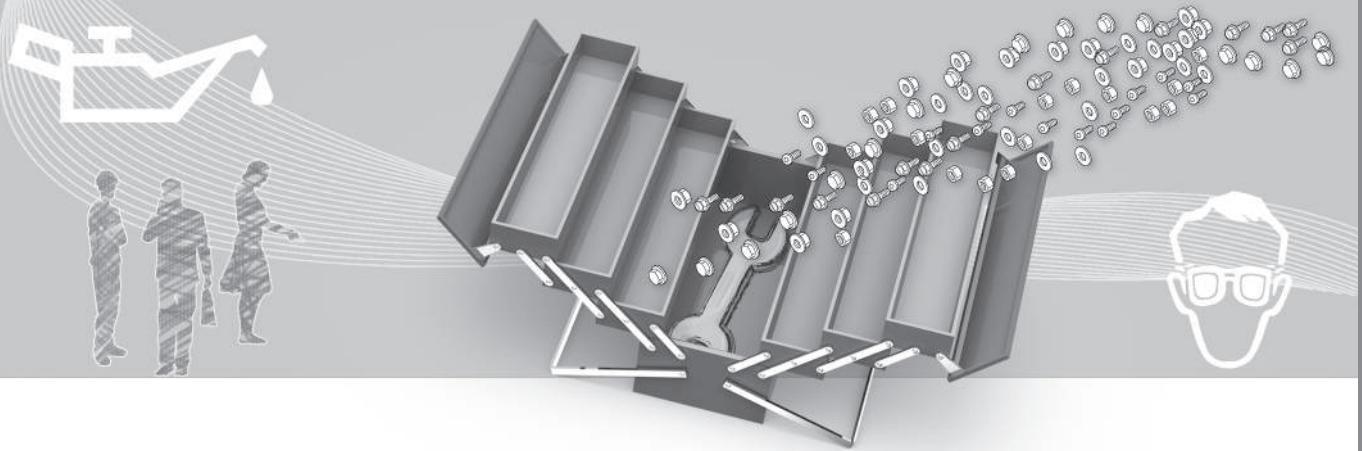



## Volvo service programme

To keep the car as safe and reliable as possible, follow the Volvo service programme as specified in the Service and Warranty Booklet.

Volvo recommends engaging an authorised Volvo workshop to perform the service and maintenance work. Volvo workshops have the personnel, special tools and service literature to guarantee the highest quality of service.

### IMPORTANT

For the Volvo warranty to apply, check and follow the instructions in the Service and Warranty Booklet.

## Related information

- Climate control system - fault tracing and repair (p. 352)

## Book service and repair\*<sup>1</sup>

Manage service, repair and booking information directly in your Internet-connected car.

This service provides a convenient way to book a service and workshop visit directly in the car. Car information is sent to your dealer, who can prepare the workshop visit. The dealer will contact you to schedule an appointment time. For certain markets, the system reminds you of a scheduled appointment time as it approaches and the navigation system<sup>2</sup> can also guide you to the workshop when the time comes.

## Before the service can be used

### Volvo ID and my profile

- Register a Volvo ID. For more information and how to create a Volvo ID, see Volvo ID (p. 19).
- Log in to the web portal My Volvo, go to your profile and carry out the following:
  - Check that the car is connected to your profile.
  - Check that your contact information is correct.
  - Select the Volvo dealer you want to contact for service and repair.

- Select preferred communication channel (SMS or phone). Booking information is always sent to the car and to you via email.

### Prerequisite for booking from car

- To send and receive booking information to and from the car, the car must be connected to the Internet, see Sensus Infotainment supplement for information on how to connect the car to the Internet.
- Since the booking information is sent over your private phone subscription, you will be asked whether you want to send the information. The question is asked once and then applies to the selected connection for a limited time.
- For the service to work and for the system to communicate via the car's screen, notifications/pop-up messages must be accepted. In the normal view for the **MY CAR** source, press **OK/MENU** and then **Service & repair** → **Display notifications**.

### Using the service

All menus and settings are accessed from the normal view in **MY CAR** by pressing **OK/MENU** and then **Service & repair**.

When it is time for service, and in some cases when the car is in need of repair, this is noti-

<sup>1</sup> Applies to certain markets.

<sup>2</sup> Applies to Sensus Navigation.



fied in the combined instrument panel (p. 59) and via a pop-up menu in the screen.

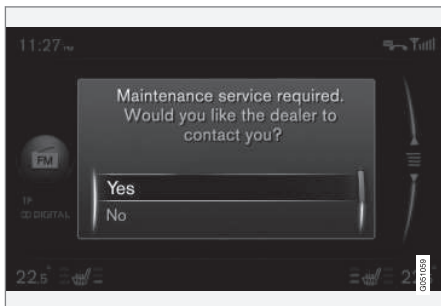

Service message in the screen.

Meaning of the answer options in the screen's pop-up menu:

- **Yes** - A booking enquiry is sent to your dealer who then comes back with a booking proposal. The service lamp and service message in the combined instrument panel are extinguished.
- **No** - No more pop-up messages will be shown in the screen. The message in the combined instrument panel remains. After this option has been selected, it is possible to start the manual booking in the car, see below.
- **Postpone** - The pop-up menu is shown the next time the car is started.

### Book a service or repair manually<sup>1</sup>

1. Press the **MY CAR** button in the centre console and select **Service & repair** → **Dealer information** → **Request service or repair**.
  - > Vehicle data is sent automatically to your dealer.
2. The dealer sends a booking proposal to the car.
3. Accept or request a new booking proposal.

After the booking has been accepted the booking information is stored in the car, see My bookings. The car will automatically communicate with you via the screen by means of reminders about the booking and guide you to the workshop visit.

You can also book a workshop visit via My Volvo. Go to "My bookings" and select "Update" in order to gain access to bookings from My Volvo.

### My bookings<sup>1</sup>

Show booking information in the car's screen. Accept or request a new booking proposal.

- Select **Service & repair** → **My bookings**.

### Call the dealer<sup>1</sup>

With a Bluetooth® phone connected to the car, you can call your dealer. For connecting the phone, see Sensus Infotainment supplement.

- Select **Service & repair** → **Dealer information** → **Call dealer**.

### Using the navigation system<sup>1, 2</sup>

Enter your workshop as destination or waypoint in the navigation system.

- Select **Service & repair** → **Dealer information** → **Set single destination**.
- Select **Service & repair** → **Dealer information** → **Add as waypoint**.

### Sending vehicle data<sup>1</sup>

Vehicle data is sent to a central Volvo database (not your dealer) from which Volvo dealers can retrieve vehicle information using the car's identification number (VIN<sup>3</sup>). The number is printed in the car's service and warranty booklet, alternatively inside the windscreen's bottom left-hand corner.

- Select **Service & repair** → **Send car data**.

<sup>1</sup> Applies to certain markets.

<sup>2</sup> Applies to Sensus Navigation.

<sup>3</sup> Vehicle Identification Number



## Booking information and vehicle data

When you decide to book a service from your car, the booking information and vehicle data will be sent. Vehicle data information consists of a number of signals within the following areas:

- Service requirement.
- Function status.
- Fluid levels.
- Mileage (distance).
- The car's vehicle identification number (VIN<sup>3</sup>).
- The car's software version.

## Related information

- Volvo ID (p. 19)

---

<sup>3</sup> Vehicle Identification Number



### Raising the car

*When raising the car it is important that the jack or lifting arms are fitted in the intended points on the car's underbody.*

#### NOTE

Volvo recommends only using the jack that belongs to the car model in question. If a jack is selected other than the one recommended by Volvo, follow the instructions supplied with the equipment.

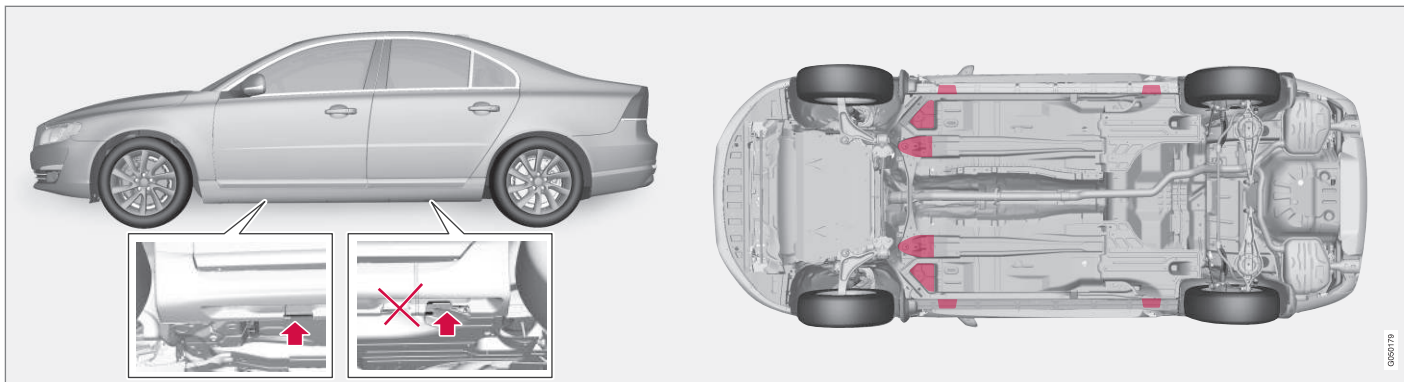

Jacking points (arrows) for the jack that belongs to the car and lifting points (marked in red).

If the car is raised with a front workshop jack then this must be positioned under one of the four lifting points furthest in under the car. If the car is raised with a rear workshop jack then it must be positioned under one of the lifting points. Ensure that the workshop jack is positioned so that the car cannot slide off the jack. Always use axle stands or similar.

If the car is raised with a two-pillar workshop lift then the front and rear lifting arms can be positioned under the outer lifting points (jacking points). Alternatively, the inner lifting points can be used at the front.

## Related information

- Changing wheels - removing wheels (p. 312)





## Bonnet - opening and closing

The bonnet can be opened when the handle by the pedals has been pulled backwards, and the lock by the grille has been moved to the left.

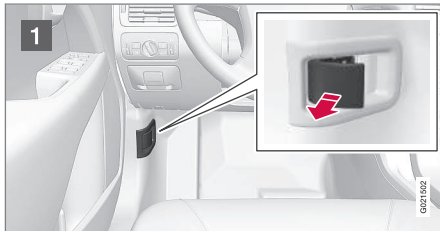

- 1 Pull the handle by the pedals. You will hear when the catch releases.
- 2 Move the catch to the left and open the bonnet. (The catch hook is located between the headlamp and grille, see illustration.)

## WARNING

Check that the bonnet locks properly when closed.

### Related information

- Engine compartment - checking (p. 344)
- Engine compartment - overview (p. 343)

## Engine compartment - overview

The overview shows normal checking points.

### Engine compartment 4-cyl. 2.0 I

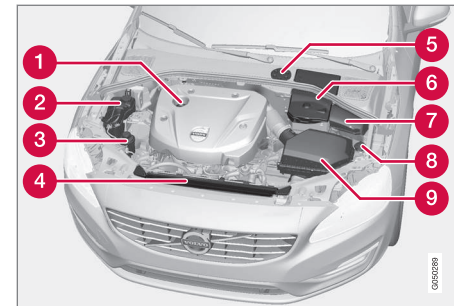

The appearance of the engine compartment may differ depending on engine variant.

- 1 Filling engine oil
- 2 Coolant expansion tank
- 3 Power steering fluid reservoir
- 4 Radiator
- 5 Reservoir for brake and clutch fluid (located on the driver's side)
- 6 Starter battery
- 7 Relay and fuse box
- 8 Filling washer fluid
- 9 Air filter



## **! WARNING**

The ignition system has very high voltage and output. The voltage in the ignition system is highly dangerous. The car's electrical system must always be in key position **0** when work is being performed in the engine compartment; see Key positions - functions at different levels (p. 74).

Do not touch the spark plugs or ignition coil when the car's electrical system is in key position **II** or when the engine is hot.

### Engine compartment, apart from 4-cyl. 2.0 I

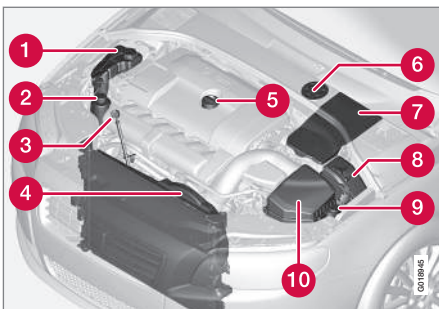

The appearance of the engine compartment may differ depending on engine variant.

- 1** Coolant expansion tank
- 2** Power steering fluid reservoir

- 3** Engine oil dipstick<sup>4</sup>
- 4** Radiator
- 5** Filling engine oil
- 6** Reservoir for brake and clutch fluid (located on the driver's side)
- 7** Starter battery
- 8** Relay and fuse box
- 9** Filling washer fluid
- 10** Air filter

## **! WARNING**

The ignition system has very high voltage and output. The voltage in the ignition system is highly dangerous. The car's electrical system must always be in key position **0** when work is being performed in the engine compartment; see Key positions - functions at different levels (p. 74).

Do not touch the spark plugs or ignition coil when the car's electrical system is in key position **II** or when the engine is hot.

### Related information

- Bonnet - opening and closing (p. 343)
- Engine compartment - checking (p. 344)

### Engine compartment - checking

Some oils and fluids should be checked at regular intervals.

### Regular checking

Check the following oils and fluids at regular intervals, e.g. when refuelling:

- Coolant
- Engine oil
- Power steering fluid
- Washer fluid

## **! WARNING**

Remember that the radiator fan (located at the front of the engine compartment, behind the radiator) may start automatically some after the engine has been switched off.

Always have the engine cleaned by a workshop - an authorised Volvo dealership is recommended. There is a risk of fire if the engine is hot.

### Related information

- Bonnet - opening and closing (p. 343)
- Engine compartment - overview (p. 343)
- Coolant - level (p. 349)
- Engine oil - checking and filling (p. 346)
- Power steering fluid - level (p. 351)
- Washer fluid - filling (p. 361)

<sup>4</sup> Engines with electronic oil level sensor do not have a dipstick (5-cyl. diesel).



## Engine oil - general

An approved engine oil must be used in order that the recommended service intervals can be applied.

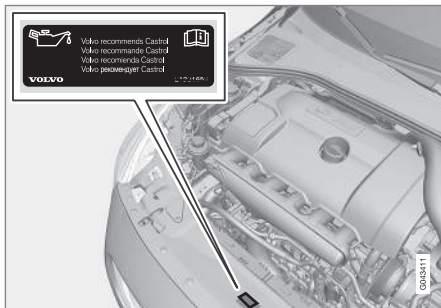

Volvo recommends:



When driving under adverse conditions, see Engine oil - adverse driving conditions (p. 396).

### ! IMPORTANT

In order to fulfil the requirements for the engine's service intervals all engines are filled with a specially adapted synthetic engine oil at the factory. The choice of oil has been made very carefully with regard to service life, starting characteristics, fuel consumption and environmental impact.

An approved engine oil must be used in order that the recommended service intervals can be applied. Only use a prescribed grade of oil for both filling and oil change, otherwise you will risk affecting service life, starting characteristics, fuel consumption and environmental impact.

Volvo Car Corporation disclaims all warranty liability if engine oil of the prescribed grade and viscosity is not used.

Volvo recommends that oil changes are carried out at an authorised Volvo workshop.

Volvo uses different systems for warning of low/high oil level or low oil pressure. Certain engine variants have an oil pressure sensor, and then the combined instrument panel's warning symbol for low oil pressure is used. Other variants have an oil level sensor, when the driver is informed via the instrument's warning symbol  and display texts. Cer-

tain variants have both systems. Contact a Volvo dealer for more information.

Change the engine oil and oil filter in accordance with the intervals specified in the Service and Warranty Booklet.

Using oil of a higher than specified grade is permitted. If the car is driven in adverse conditions, Volvo recommends using an oil of a higher grade; see Engine oil - adverse driving conditions (p. 396).

For filling capacities, see Engine oil - grade and volume (p. 397).

### Related information

- Engine oil - checking and filling (p. 346)



## Engine oil - checking and filling

The oil level is checked on certain engine variants with the electronic oil level sensor, on other engine variants with the oil dipstick.

### Engine with oil dipstick<sup>5</sup>

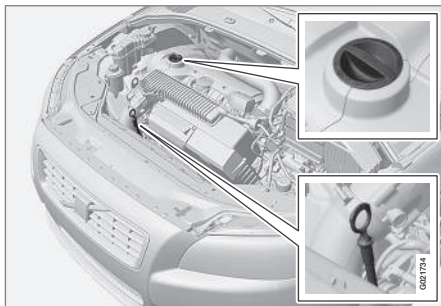

Dipstick and filler pipe.

Checking the oil level in a new car is especially important before the first scheduled oil change.

Volvo recommends checking the oil level every 2 500 km. The most accurate measurements are made on a cold engine before starting. The measurement will be inaccurate if taken immediately after the engine is switched off. The dipstick will indicate that the level is too low because the oil has not had time to flow down into the oil sump.

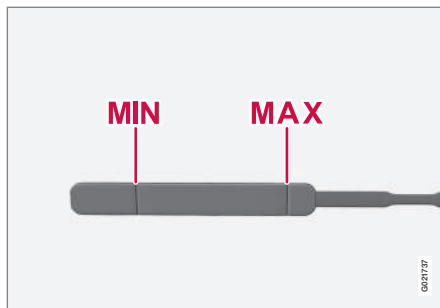

The oil level must be between the **MIN** and **MAX** marks.

### Measurement and filling if required

1. Ensure that the car is level. After switching off the engine it is important to wait 5 minutes to allow the oil time to run back to the sump.
2. Pull up and wipe the dipstick.
3. Re-insert the dipstick.
4. Pull it out and check the level.
5. If the level is close to **MIN** then 0.5 litres should be added. If the level is significantly below, then an additional amount is required.

6. If required, check the level again, do it after driving a short distance. Then repeat steps 1 - 4.

### **WARNING**

Never fill above the **MAX** mark. The level should never be above **MAX** or below **MIN** as this could lead to engine damage.

### **WARNING**

Do not spill oil onto the hot exhaust manifold due to the risk of fire.

### Engine with electronic oil level sensor, 4-cyl. 2.0 l

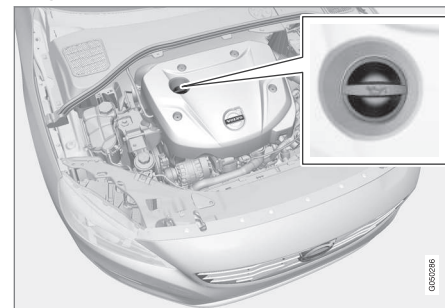

Filler pipe<sup>6</sup>.

<sup>5</sup> Does not apply to 4-cyl. 2.0 l or 5-cyl. diesel, which have electronic oil level sensor.

<sup>6</sup> Engines with electronic oil level sensor do not have a dipstick.



You do not need to take action with respect to the engine oil level before a message is shown in the display, see following illustration.

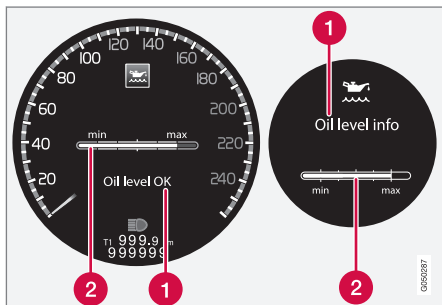

Message and graph in the display. The left-hand display shows the digital combined instrument panel and the right-hand the analogue.

- 1 Message
- 2 Engine oil level

The oil level is checked using the electronic oil level gauge with the thumbwheel when the engine is switched off, see Menu navigation - combined instrument panel (p. 105).

### WARNING

If the message **Oil service required** is shown, visit a workshop. The oil level may be too high.

### IMPORTANT

If notified of low oil level, only fill with the volume specified, for example, 0.5 litres.

### NOTE

The system cannot directly detect changes when the oil is filled or drained. The car must have been driven approx. 30 km and have been stationary for 2 hours with the engine switched off and on level ground before oil level indication is correct.

### WARNING

Do not spill oil onto the hot exhaust manifold due to the risk of fire.

### Measuring the oil level, 4-cyl. 2.0 I

If the oil level needs to be checked then it should be carried out in accordance with the sequence below.

1. Activate key position **II**; see Key positions - functions at different levels (p. 74).

2. Rotate the thumbwheel on the left-hand stalk switch to position **Oil level**.
  - > You will then see information displayed about the engine oil level.

For more information on menu navigation, see Menu navigation - combined instrument panel (p. 105).

### NOTE

If the right conditions for measuring the oil level are not met (time after engine shut-down, the car's inclination, outside temperature, etc.) then the message **Not available** will be shown. This does **not** mean that there is something wrong in the car's systems.



# 10 Maintenance and service



## Engine with electronic oil level sensor, 5-cyl. diesel

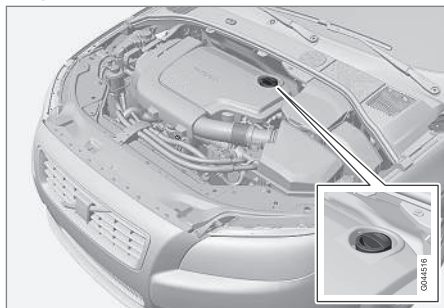

Filler pipe<sup>7</sup>.

You do not need to take action with respect to the engine oil level before a message is shown in the display, see following illustration.

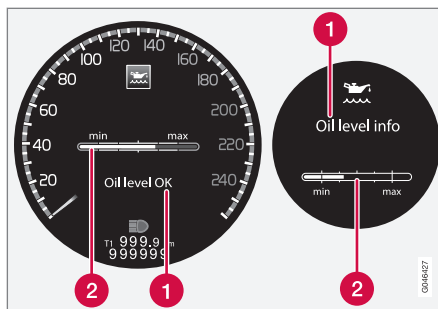

Message and graph in the display. The left-hand display shows the digital combined instrument panel and the right-hand the analogue.

- 1 Message
- 2 Engine oil level

The oil level is checked using the electronic oil level gauge with the thumbwheel when the engine is switched off, see Menu navigation - combined instrument panel (p. 105).

### WARNING

If the message **Oil service required** is shown, visit a workshop. The oil level may be too high.

### IMPORTANT

In the event of the message **Oil level low Refill 0.5 litre**, only fill with 0.5 litres.

### NOTE

The oil level is only detected by the system during driving. The system cannot directly detect changes when the oil is filled or drained. The car must be driven about 30 km before the oil level display is correct.

### WARNING

Do not fill more oil if filling level (3) or (4) appears as shown in the illustration below. The level must never be above **MAX** or below **MIN**, as this could lead to engine damage.

### WARNING

Do not spill oil onto the hot exhaust manifold due to the risk of fire.

<sup>7</sup> Engines with electronic oil level sensor do not have a dipstick.



### Measuring the oil level, 5-cyl. diesel

If the oil level needs to be checked then it should be carried out in accordance with the sequence below.

1. Activate key position **II**; see Key positions - functions at different levels (p. 74).
2. Rotate the thumbwheel on the left-hand stalk switch to position **Oil level**.
  - > You will then see information displayed about the engine oil level.

For more information on menu navigation, see Menu navigation - combined instrument panel (p. 105).

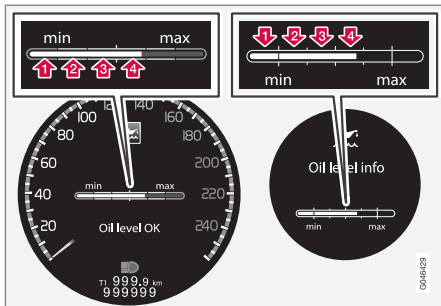

The figures 1-4 represent filling level. Do not fill more oil if filling level (3) or (4) is shown. Recommended filling level is 4. Message and graph in the display. The left-hand display shows the digital combined instrument panel and the right-hand the analogue.

### Related information

- Engine oil - general (p. 345)

### Coolant - level

The coolant cools the internal combustion engine to the correct operating temperature. The heat that is transferred from the engine to the coolant can be used to heat the passenger compartment.

The coolant level must lie between the **MIN** and **MAX** marks on the expansion tank.

### Checking the level and topping up

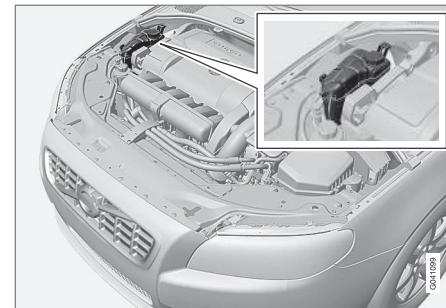

When topping up the coolant, follow the instructions on the packaging. It is important that the mixture of coolant concentrate and water is correct for the prevailing weather conditions. Never top up with water only. The risk of freezing increases with both too little and too much coolant concentrate.



## **WARNING**

Coolant can be very hot. If the coolant requires topping up when the engine is at operating temperature, unscrew the expansion tank cap slowly to gently release the overpressure.

For capacities and for standards regarding water quality; see Coolant - grade and volume (p. 399).

### **Check the coolant regularly**

The level must be between the **MIN** and **MAX** marks on the expansion tank. If the system is not filled sufficiently, high temperatures could occur, causing a risk of damage to the engine.

## **IMPORTANT**

- A high content of chlorine, chlorides and other salts may cause corrosion in the cooling system.
- Always use coolant with anti-corrosion agent as recommended by Volvo.
- Ensure that the coolant mixture is 50% water and 50% coolant.
- Mix the coolant with approved quality tap water. In the event of any doubt about water quality, used ready-mixed coolant in accordance with Volvo recommendations.
- When changing coolant/replacing cooling system components, flush the cooling system clean with approved quality tap water or flush with ready-mixed coolant.
- The engine must only be run with a well-filled cooling system. Otherwise, temperatures that are too high may occur resulting in the risk of damage (cracks) in the cylinder head.

## **Brake and clutch fluid - level**

*Brake and clutch fluid level should be between the reservoir **MIN** and **MAX** marks.*

### **Checking the level**

Brake and clutch fluid have a common reservoir. The level must be between the **MIN** and **MAX** marks that are visible inside the reservoir. Check the level regularly.

Change the brake fluid every other year or at every other regular service.

The fluid should be changed annually on cars driven in conditions requiring hard, frequent braking, such as driving in mountains or tropical climates with high humidity.

For capacities and recommended brake fluid grade, see Brake fluid - grade and volume (p. 402).

## **WARNING**

If the brake fluid is under the **MIN** level in the brake fluid reservoir, do not drive further before topping up the brake fluid. Volvo recommends that the reason for the loss of brake fluid is investigated by an authorised Volvo workshop.





## Filling

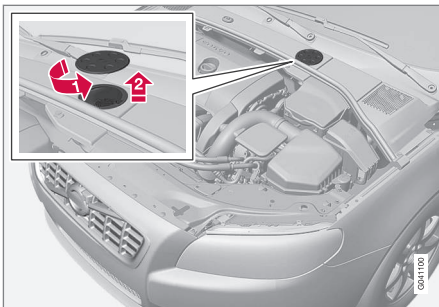

The fluid reservoir is located on the driver's side.

The fluid reservoir is protected under the cover over the cold zone in the engine compartment. The round cover must be removed first before the reservoir cap can be reached.

- 1 Turn and open the cover located on the covering.
- 2 Unscrew the reservoir cap and fill the fluid. The level must be between the **MIN** and **MAX** marks, which are located on the inside of the reservoir.

### ! IMPORTANT

Do not forget to refit the cap.

## Power steering fluid - level

The power steering fluid level must be between the reservoir's **MIN** and **MAX** marks. The fluid does not need to be changed.

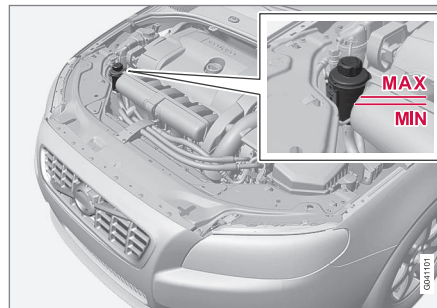

### ! IMPORTANT

Keep the area around the power steering fluid reservoir clean when checking. The cover must not be opened.

Check the level frequently. The fluid does not require changing. The level must be between the **MIN** and **MAX** marks.

For recommended fluid grade, see Power steering fluid - grade (p. 402).

### i NOTE

If a fault should arise in the power steering system, or if the engine is switched off and must be towed, then the car can still be steered.



## Climate control system - fault tracing and repair

The air conditioning system must only be serviced and repaired by an authorised workshop.

### Troubleshooting and repair

The air conditioning system contains fluorescent tracing agents. Use ultraviolet light when looking for leaks.

Volvo recommends that you contact an authorised Volvo workshop.

#### WARNING

The air conditioning system contains pressurised refrigerant R134a. This system must only be serviced and repaired by an authorised workshop.

### Related information

- Volvo service programme (p. 338)

## Lamp replacement

Lamp replacement can be carried out for bulbs. When replacing LED and Xenon lamps, please refer to a workshop.

The bulbs are specified (p. 358). The following list contains locations of bulbs and other light sources that are specialised, such as LED<sup>8</sup> lamps, or are unsuitable for changing for some other reason, except at a workshop<sup>9</sup>:

- Active Xenon headlamps - ABL (Xenon lamps)
- Position/parking lamps front
- Daytime running lights
- Side direction indicators, door mirrors
- Approach lighting, door mirrors
- Interior lighting
- Position/parking lamps rear
- Side marker lamps rear
- Brake light.

#### WARNING

On cars with Xenon headlamps, the replacement of Xenon lamps must be carried out at a workshop - an authorised Volvo workshop is recommended. Working with Xenon lamps demands extreme caution because the headlamp is equipped with a high voltage unit.

#### WARNING

The car's electrical system must be in key position **0** for bulb replacement; see Key positions - functions at different levels (p. 74).

#### IMPORTANT

Never touch the glass part of the bulbs with your fingers. Grease from your fingers is vaporised by the heat, coating the reflector and then causing damage.

#### NOTE

If an error message remains after the broken bulb has been replaced then we recommend that you visit an authorised Volvo workshop.

<sup>8</sup> LED (Light Emitting Diode)

<sup>9</sup> An authorised Volvo workshop is recommended.



### **i** NOTE

Outside lighting such as headlamps, fog lamps and rear lamps may temporarily have condensation on the inside of the lens. This is normal, all exterior lighting is designed to withstand this. Condensation is normally vented out of the lamp housing when the lamp has been switched on for a time.

### Related information

- Lamp replacement - headlamps (p. 353)
- Lamp replacement - location of rear lamps (p. 356)
- Lamp replacement - vanity mirror lighting (p. 358)
- Lamp replacement - lighting in cargo area (p. 357)
- Lamp replacement - number plate lighting (p. 357)

### Lamp replacement - headlamps

All of the headlamp bulbs are replaced via the engine compartment. First loosen and remove the whole headlamp.

#### Removing the headlamp

Set the car's electrical system in key position **0**, see Key positions - functions at different levels (p. 74).

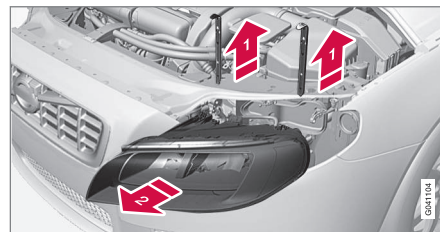

- 1 Pull out the headlamp's locking pins.
- 2 Pull the headlamp straight forward.

### **i** IMPORTANT

Do not pull the electrical cable, only the connector.

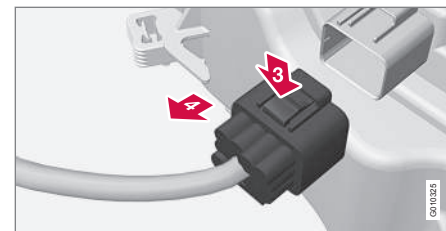

- 3 Detach the headlamp connector by pressing down the clip with your thumb.
- 4 At the same time, guide out the connector with your other hand.
- 5 Lift out the headlamp and place it on a soft surface to avoid scratching the lens.
- 6 Replace the bulb in question.

#### Securing the headlamp

- 1 Plug in the connector, a clicking sound should be heard.
- 2 Reinstall the headlamp and locking pins. Check that they are firmly inserted.
- 3 Check the lighting.

The headlamp must be mounted and the connector firmly connected before the lighting is switched on or the remote control key is inserted into the ignition switch.



## Related information

- Lamp replacement (p. 352)
- Lamp replacement - cover for main/dipped beam bulbs (p. 354)
- Lamps - specifications (p. 358)

## Lamp replacement - cover for main/dipped beam bulbs

Main/dipped beam bulbs are accessed by releasing the headlamp's larger cover.

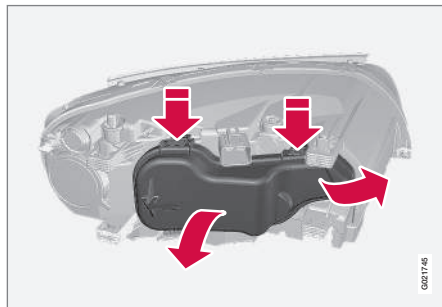

Before starting to replace a bulb, see Lamp replacement - headlamps (p. 353).

1. Open the lock clamp by pressing up/out.
2. Press down the clips on the cover and remove it.

Reinstall the cover in reverse order.

## Related information

- Lamp replacement - headlamps (p. 353)
- Lamp replacement - dipped beam (p. 354)
- Lamp replacement - main beam (p. 355)
- Lamp replacement - extra main beam (p. 355)

## Lamp replacement - dipped beam

The dipped beam bulb is fitted inside the headlamp's larger cover.



## NOTE

Applies to cars with halogen headlamps.

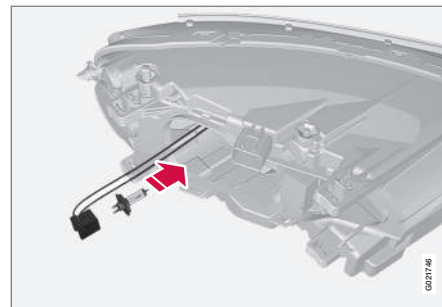

1. Detach the headlamp (p. 353).
2. Remove the cover (p. 354).
3. Unplug the connector from the bulb.
4. Detach the bulb by pressing the holder downwards.
5. Fit the new bulb in the socket and snap it in. It can only be secured in one position.

Reinstall the parts in reverse order.

## Related information

- Lamps - specifications (p. 358)



### Lamp replacement - main beam

The main beam bulb is fitted inside the headlamp's larger cover.

#### **i** NOTE

Applies to cars with halogen headlamps.

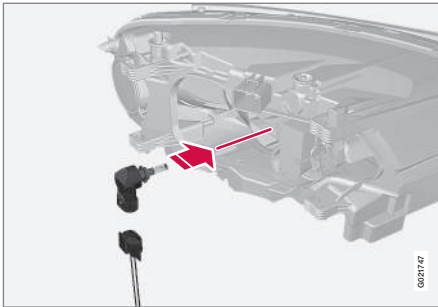

1. Detach the headlamp (p. 353).
2. Remove the cover (p. 354).
3. Detach the bulb by turning anticlockwise and then pulling straight out.
4. Unplug the connector from the bulb.
5. Replace the bulb and align it in the socket and turn clockwise in order to secure it. It can only be secured in one position.

Reinstall the parts in reverse order.

#### Related information

- Lamps - specifications (p. 358)

### Lamp replacement - extra main beam

The extra main beam bulb is fitted inside the headlamp's larger cover.

#### **i** NOTE

Applies to cars with Xenon headlamps\*.

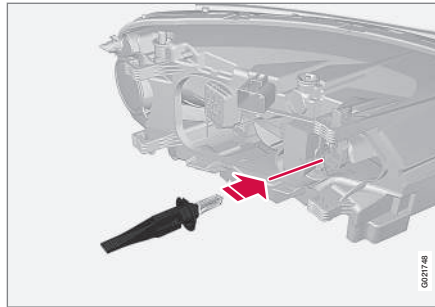

1. Detach the headlamp (p. 353).
2. Remove the cover (p. 354).
3. Detach the bulb by pressing the holder downwards.
4. Unplug the connector from the bulb.
5. Fit the new bulb in the socket and snap it in. It can only be secured in one position.

Reinstall the parts in reverse order.

#### Related information

- Lamps - specifications (p. 358)

### Lamp replacement - direction indicators front

The direction indicator lamp is fitted inside the headlamp's smaller cover.

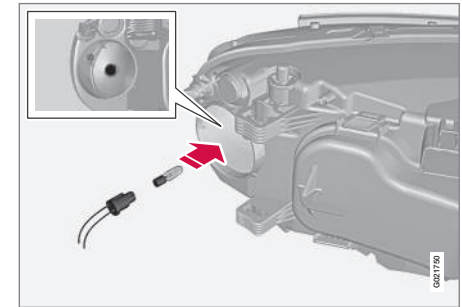

1. Detach the headlamp (p. 353).
2. Remove the small round cover.
3. Pull the bulb holder in order to extract the bulb.
4. Remove the blown bulb and fit a new one. It can only be installed in one way.
5. Fit the bulb holder in the socket and press until a clicking sound is heard.
6. Refit the cover. It must be fitted and pressed in until a clicking sound is heard.

Reinstall the parts in reverse order.

#### Related information

- Lamps - specifications (p. 358)



## Lamp replacement - rear lamp

Lamps in the rear lamp cluster are replaced from inside the cargo area.

### Lamp housing, rear

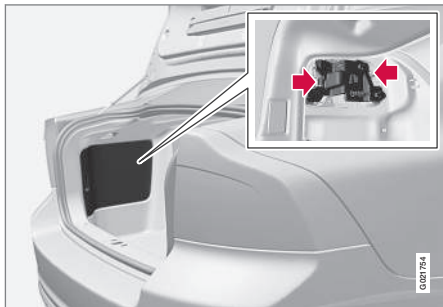

The bulbs in the rear light cluster are replaced from inside the cargo area (not the LED lamps).

1. Remove the covers in the left/right-hand panel to access the bulbs. The bulbs are located in separate bulb holders.
2. Press the catches together and pull out the bulb holder.
3. Replace the bulb.
4. Plug in the connector.
5. Press the bulb holder into place and refit the cover.

### Related information

- Lamp replacement - location of rear lamps (p. 356)
- Lamps - specifications (p. 358)

## Lamp replacement - location of rear lamps

The overview shows the location of the lamps at the rear.

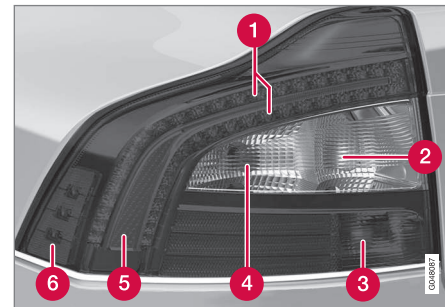

- 1 Brake light (LED)
- 2 Reversing lamp (p. 356)
- 3 Fog lamps (p. 356)
- 4 Indicator (p. 356)
- 5 Position/parking lights (LED)
- 6 Side marker lamps (LED)

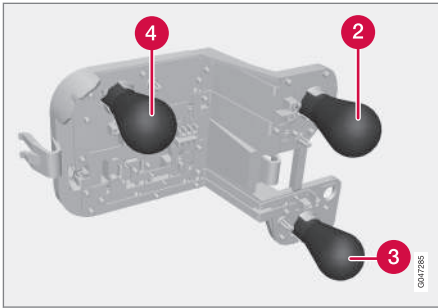

Rear lamp cluster bulb holder

- 1 Reversing lamp (p. 356)
- 2 Fog lamps (p. 356)
- 3 Indicator (p. 356)

#### Related information

- Lamp replacement (p. 352)
- Lamps - specifications (p. 358)

#### Lamp replacement - number plate lighting

The number plate lighting is located under the tailgate handle.



1. Remove the screws with a screwdriver.
2. Carefully detach the whole lamp housing and withdraw it.
3. Replace the bulb.
4. Refit the whole lamp housing and screw it into place.

#### Related information

- Lamps - specifications (p. 358)

#### Lamp replacement - lighting in cargo area

The cargo area lighting is positioned on both sides of the boot lid opening.

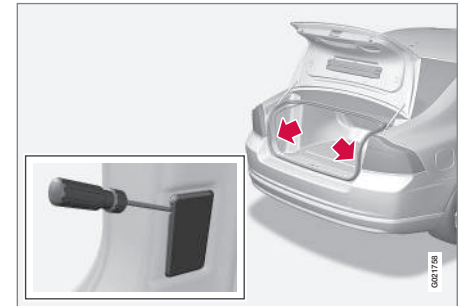

1. Insert a screwdriver and gently prize so that the lamp housing comes loose.
2. Replace the bulb.
3. Check that the bulb illuminates and press back the lamp housing.

#### Related information

- Lamps - specifications (p. 358)



## Lamp replacement - vanity mirror lighting

The vanity mirror's lamps are fitted inside the lamp lenses.

### Removal of lamp lens

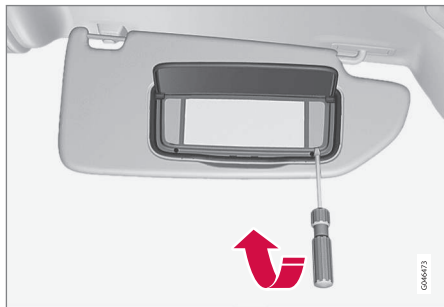

1. Insert a screwdriver under the lamp lens and gently prize up the lock lugs on the edge.
2. Snap off the lamp lens.
3. Use needle-nose pliers to pull the bulb straight out to the side and replace with a new one. Note! - Do not pinch hard with the pliers. Otherwise the lamp lens could then be crushed.

### Attaching the lamp lens

1. Refit the lamp lens.
2. Press it into place.

### Related information

- Lamps - specifications (p. 358)

### Lamps - specifications

The specifications apply to bulbs. When replacing LED and Xenon lamps, please refer to a workshop.

Lighting	W <sup>A</sup>	Type
Dipped beam, halogen	55	H7 LL
Main beam, Halogen	65	H9
Extra main beam, ABL	55	H7 LL
Front direction indicators	21	H21W LL
Glovebox lighting	5	Socket SV8.5 Length 43 mm
Vanity mirror lighting	2	T5 Socket W2x4.6d
Cargo area lighting	5	Socket SV8.5 Length 38 mm
Number plate lighting	5	C5W LL
Direction indicators, rear	21	PY21W SV





Lighting	W <sup>A</sup>	Type
Reversing lamp	21	P21W LL
Rear fog lamp	21	P21W LL

<sup>A</sup> Watt

### Related information

- Lamp replacement (p. 352)
- Lamp replacement - location of rear lamps (p. 356)
- Lamp replacement - vanity mirror lighting (p. 358)

### Wiper blades

*The windscreen wiper blades must be in service position when they are to be replaced.*

### Service position



*Wiper blades in service position.*

In order to change, clean or lift the wiper blades (for scraping off ice from the windscreen, for example) they must be in service position.

### IMPORTANT

Before placing the wiper blades in the service position, make sure that they are not frozen down.

1. Insert the remote control key in the ignition switch<sup>10</sup> and briefly press the **START/STOP ENGINE** button to set the car's electrical system to key position **I**. For detailed information on key positions, see Key positions - functions at different levels (p. 74).
2. Briefly press the **START/STOP ENGINE** button again to set the car's electrical system in key position **0**.
3. Within 3 seconds, move the right stalk switch up and hold it in position for approx. 1 second.
  - > The wipers then move to standing straight up.

The wipers return to their starting position when you briefly press the **START/STOP ENGINE** button to set the car's electrical system to key position **I** (or when the car is started).

### IMPORTANT

If the wiper arms in service position have been folded up from the windscreen, they must be folded back down onto the windscreen before the wipers are allowed to return to their starting position. This is to avoid scraping the paint on the bonnet.

<sup>10</sup> Not necessary in cars with the Keyless function.



## Replacing the wiper blades

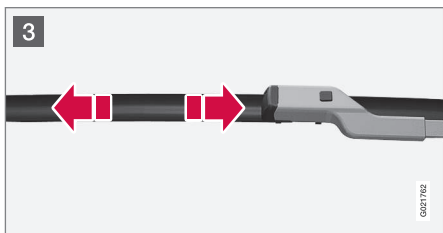
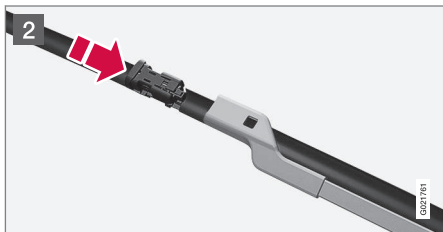
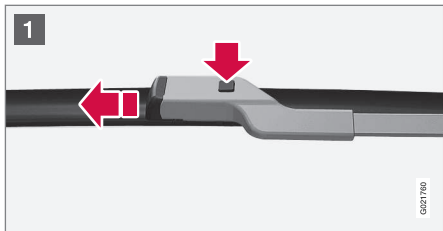

- 1 Fold up the wiper arm when it is in service position. Press the button located on the wiper blade mounting and pull straight out parallel with the wiper arm.
- 2 Slide in the new wiper blade until a "click" is heard.
- 3 Check that the blade is firmly installed.
4. Fold the wiper arm back towards the windscreen.

The wipers return from service position to their starting position when you briefly press the **START/STOP ENGINE** button to set the car's electrical system to key position **I** (or when the car is started).

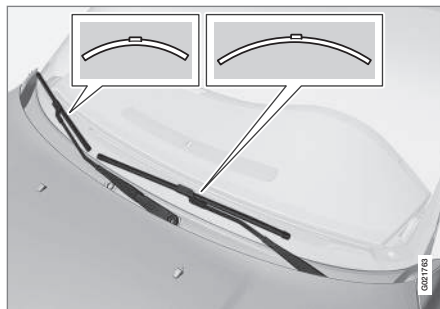

### NOTE

The wiper blades are different lengths. The blade on the driver's side is longer than on the passenger side.

## Cleaning

For cleaning wiper blades and windscreen, see Car washing (p. 380).

### IMPORTANT

Check the blades regularly. Neglected maintenance shortens the service life of the wiper blades.

## Related information

- Washer fluid - filling (p. 361)



### Washer fluid - filling

Washer fluid is used for cleaning the headlamps and windows. Washer fluid with anti-freeze must be used during winter.

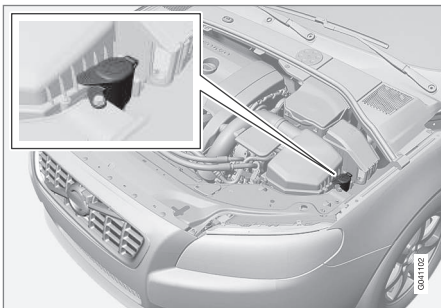

The windscreen and headlamp washers share a common reservoir.

#### **!** IMPORTANT

Use Volvo genuine washer fluid or equivalent with a recommended pH of between 6 and 8.

#### **!** IMPORTANT

Use washer fluid with antifreeze during the winter to avoid freezing in the pump, reservoir and hoses.

For capacities, see Washer fluid - quality and volume (p. 402).

### Related information

- Wiper blades (p. 359)

### Starter battery - general

The starter battery is used to drive the starter motor and other electrical equipment in the car.

The service life and function of the starter battery is influenced by factors such as the number of starts, discharging, driving style, driving conditions, climatic conditions, etc.

The starter battery is a traditional 12 V battery.

- Never disconnect the starter battery when the engine is running.
- Check that the cables to the starter battery are correctly connected and properly tightened.

	Engine	
	Petrol (Ethanol)	Diesel
Voltage (V)	12	12
Cold start capacity <sup>A</sup> - CCA <sup>B</sup> (A)	520–800	700–800

A In accordance with SAE or EN standard.

B Cold Cranking Amperes.



## IMPORTANT

If the starter battery is replaced, make sure you replace it with a battery with the same cold starting capacity and type as the original battery (see the label on the battery).

## NOTE

- The starter battery's container size should be consistent with the original battery's dimensions.
- The starter battery's height is different depending on size.

## WARNING

- The battery can generate oxyhydrogen gas, which is highly explosive. A spark can be formed if a jump lead is connected incorrectly, and this can be enough for the battery to explode.
- The battery contains sulphuric acid, which can cause serious burns.
- If sulphuric acid comes into contact with eyes, skin or clothing, flush with large quantities of water. If acid splashes into the eyes - seek medical attention immediately.

## IMPORTANT

When charging the starter battery or the support battery (p. 365), only use a modern battery charger with controlled charging voltage. Fast charging function must not be used since it may damage the battery.

## IMPORTANT

If the following instruction is not observed then the energy saving function for information may be temporarily disengaged, and/or the message in the information display about the main battery's state of charge may be temporarily inapplicable, following the connection of an external battery or battery charger:

- The negative battery terminal on the car's starter battery must **never** be used for connecting an external battery or battery charger - only the **car chassis** may be used as the grounding point.

See Jump starting with battery (p. 258) for a description of how the cable clamps must be attached.

## NOTE

The life of the battery is shortened if it becomes discharged repeatedly.

The life of the battery is affected by several factors, including driving conditions and climate. Battery starting capacity decreases gradually with time and therefore needs to be recharged if the car is not used for a longer time or when it is only driven short distances. Extreme cold further limits starting capacity.

To maintain the battery in good condition, at least 15 minutes of driving/week is recommended or that the battery is connected to a battery charger with automatic trickle charging.

A battery that is kept fully charged has a maximum service life.

### Related information





- Battery - symbols (p. 363)
- Starter battery - replacement (p. 363)
- Battery - Start/Stop (p. 365)



## Battery - symbols

There are information and warning symbols on the battery.

### Symbols on the battery

	Use protective goggles.
	Further information in the owner's manual for the car.
	Store the battery out of the reach of children.
	The battery contains corrosive acid.

	Avoid sparks and naked flames.
	Risk of explosion.
	Must be taken for recycling.

### NOTE

An expended battery must be recycled in an environmentally safe manner as it contains lead.

### Related information

- Starter battery - general (p. 361)

## Starter battery - replacement

The starter battery in the car can be replaced without the help of a workshop.

The starter battery is a traditional 12 V battery.

### Removal

**First of all:** Take the remote control key from the ignition switch and wait at least 5 minutes before any electrical connections are touched - this is because the car's electrical system needs to store the necessary information to control modules.

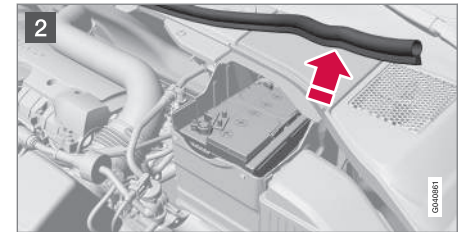
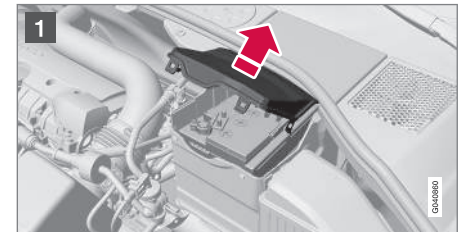



# 10 Maintenance and service

◀◀

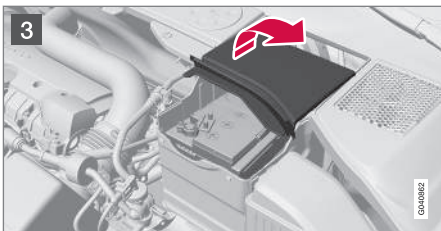

3

- 3 Remove the rear cover by screwing one quarter turn and lifting it away.

## WARNING

Connect and remove the positive and negative cables in the correct order.

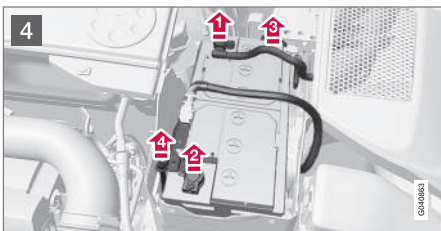

4

- 1 Detach the black negative cable.
- 2 Detach the red positive cable.
- 3 Detach the ventilation hose from the battery.
- 4 Loosen the screw holding the battery clamp.

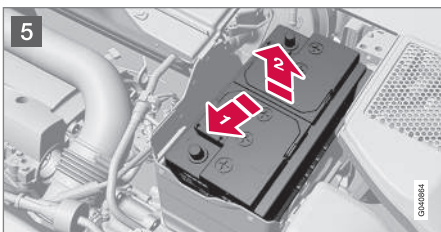

5

- 5
  - 1 Move the battery aside.
  - 2 Lift it up.

- 1 Open the clips on the front cover and remove the cover.
- 2 Release the rubber moulding so that the rear cover is free.

1. Lower the battery into the battery box.
2. Move the battery inward and to the side until it reaches the rear edge of the box.
3. Tighten the clamp that holds the battery.
4. Connect the ventilation hose.
  - > Check that it is correctly connected to both battery and outlet in the body.
5. Connect the red positive cable.
6. Connect the black negative cable.
7. Press in the rear cover. (See earlier section "Removal".)
8. Fit the rubber moulding. (See "Removal".)
9. Align the front cover and secure it with the clips. (See "Removal".)

For more information on the car's starter battery, see Jump starting with battery (p. 258).

## Fitting

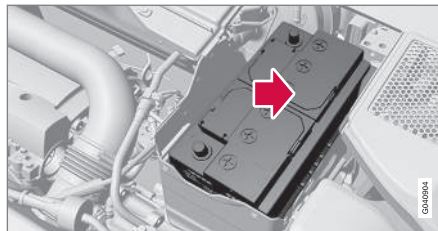



## Battery - Start/Stop

Cars with the Start/Stop function are equipped with a support battery in addition to the starter battery.

Cars with the Start/Stop function are equipped with two 12 V batteries - one extra powerful starter battery for starting and one support battery that helps during the Start/Stop function's starting sequence.

For more information on the Start/Stop function, see Start/Stop\* (p. 268).

For more information on the car's starter battery, see Jump starting with battery (p. 258).

The following table shows specifications for the starter battery and support battery respectively in cars with Start/Stop function.

	Battery	
	Start, 12 V	Support, 12 V
Cold start capacity <sup>A</sup> - CCA <sup>B</sup> (A)	720 <sup>C</sup> 760 <sup>D</sup>	Left-hand drive car: 120 <sup>E</sup> 170 <sup>F</sup> Right-hand drive car: 120
Size, L×W×H (mm)	278×175×190	Left-hand drive car: 150×90×106 <sup>E</sup> 150×90×130 <sup>F</sup> Right-hand drive car: 150×90×106

	Battery	
	Start, 12 V	Support, 12 V
Capacity (Ah)	70	Left-hand drive car: 8 <sup>E</sup> 10 <sup>F</sup> Right-hand drive car: 8

A In accordance with EN standard.

B Cold Cranking Amperes.

C Manual gearbox.

D Automatic gearbox.

E Manual gearbox in combination with Start/Stop function that only auto-stops when the car is completely stationary.

F Others.



### IMPORTANT

When replacing the starter battery, in cars with Start/Stop function, a battery of the correct type must be fitted, EFB<sup>11</sup> in cars with manual gearbox and AGM<sup>12</sup> in cars with automatic gearbox.

When replacing the support battery, a battery of AGM type must be fitted.

<sup>11</sup> Enhanced Flooded Battery.

<sup>12</sup> Absorbed Glass Mat.



# 10 Maintenance and service



## NOTE

- The higher the current take-off in the car, the more the alternator must be working and the batteries charging = Increased fuel consumption.
- When the capacity of the starter battery has fallen below the lowest permissible level then the Start/Stop function is disengaged.

Temporarily reduced Start/Stop function due to high current take-off means:

- The engine starts automatically<sup>13</sup> without the driver depressing the clutch pedal (manual gearbox).
- The engine starts automatically without the driver lifting his/her foot off the foot brake pedal (automatic gearbox).

<sup>13</sup> Automatic starting can only take place if the gear lever is in neutral position.

<sup>14</sup> See Starter battery - general (p. 361) for detailed description of the starter battery.

## Location of the batteries

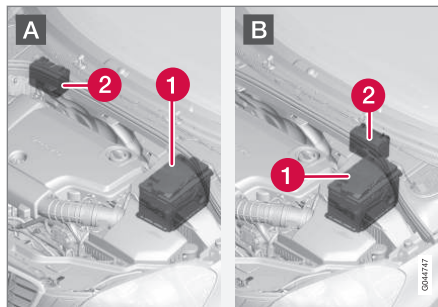

A: Left-hand drive car. B: Right-hand drive car.  
(1) Starter battery<sup>14</sup> (2) Support battery.

The support battery normally requires no more service than the normal starter battery. A workshop should be contacted in the event of questions or problems - an authorised Volvo workshop is recommended.

## IMPORTANT

If the following instruction is not observed then the Start/Stop function may temporarily cease to work after the connection of an external battery or battery charger:

- The negative battery terminal on the car's starter battery must **never** be used for connecting an external battery or battery charger - only the **car chassis** may be used as the grounding point.

See Jump starting with battery (p. 258) for a description of how the cable clamps must be attached.



**i NOTE**

If the battery has become so discharged that everything is "black" and in principle the car does not have all the normal electrical functions and the engine is subsequently started using an external battery or battery charger, then the Start/Stop function will be activated. It will then be possible for the engine to be auto-stopped but in the event of an auto-stop the Start/Stop function may fail to auto-start the engine due to inadequate capacity in the battery.

The battery must first be charged in order to ensure a successful auto-start after an auto-stop. At an outside temperature of +15 °C the battery needs to be charged for at least 1 hour. At a lower outside temperature a charging time of 3-4 hours is recommended. The recommendation is that the battery is charged using an external battery charger.

If this is not possible then the recommendation is to temporarily deactivate the Start/Stop function until the battery has been adequately recharged.

For more information on charging the starter battery, see Starter battery - general (p. 361).

**Related information**

- Battery - symbols (p. 363)

**Electrical system**

*The electrical system is single-pole and uses the chassis and engine casing as a conductor.*

The car has a voltage-regulated AC alternator.

The size, type and performance of the starter battery depend on the car's equipment and function.

**! IMPORTANT**

If the starter battery is replaced, make sure you replace it with a battery with the same cold starting capacity and type as the original battery (see the label on the battery).

**Related information**

- Starter battery - replacement (p. 363)
- Starter battery - general (p. 361)

**Fuses - general**

*All electrical functions and components are protected by a number of fuses in order to protect the car's electrical system from damage by short circuiting or overloading.*

If an electrical component or function does not work, it may be because the component's fuse was temporarily overloaded and failed. If the same fuse fails repeatedly then there is a fault in the circuit. Volvo recommends that you visit an authorised Volvo workshop for checking.

**Changing**

1. Look in the fuse diagram to locate the fuse.
2. Pull out the fuse and check from the side to see whether the curved wire has blown.
3. If this is the case, replace it with a new fuse of the same colour and amperage.

**WARNING**

Never use a foreign object or a fuse with an amperage higher than that specified when replacing a fuse. This could cause significant damage to the electrical system and possibly lead to fire.



## Location of central electrical units

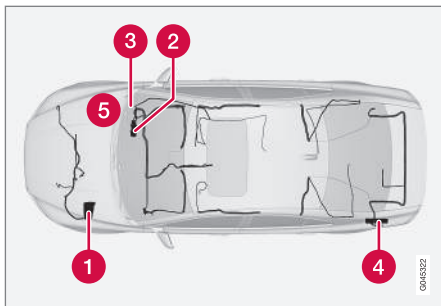

Central electrical unit locations in a left-hand drive car. In a right-hand drive car the central electrical units under the glovebox change sides.

- 1 Engine compartment
- 2 Under the glovebox
- 3 Under the glovebox
- 4 Cargo area
- 5 Engine compartment cold zone (only Start/Stop)

### Related information

- Fuses - in engine compartment (p. 369)
- Fuses - under glovebox (p. 373)
- Fuses - in the control module under the glovebox (p. 375)
- Fuses - in cargo area (p. 377)

- Fuses - in the engine compartment's cold zone (p. 378)



## Fuses - in engine compartment

Fuses in the engine compartment protect engine and brake functions, amongst other things.

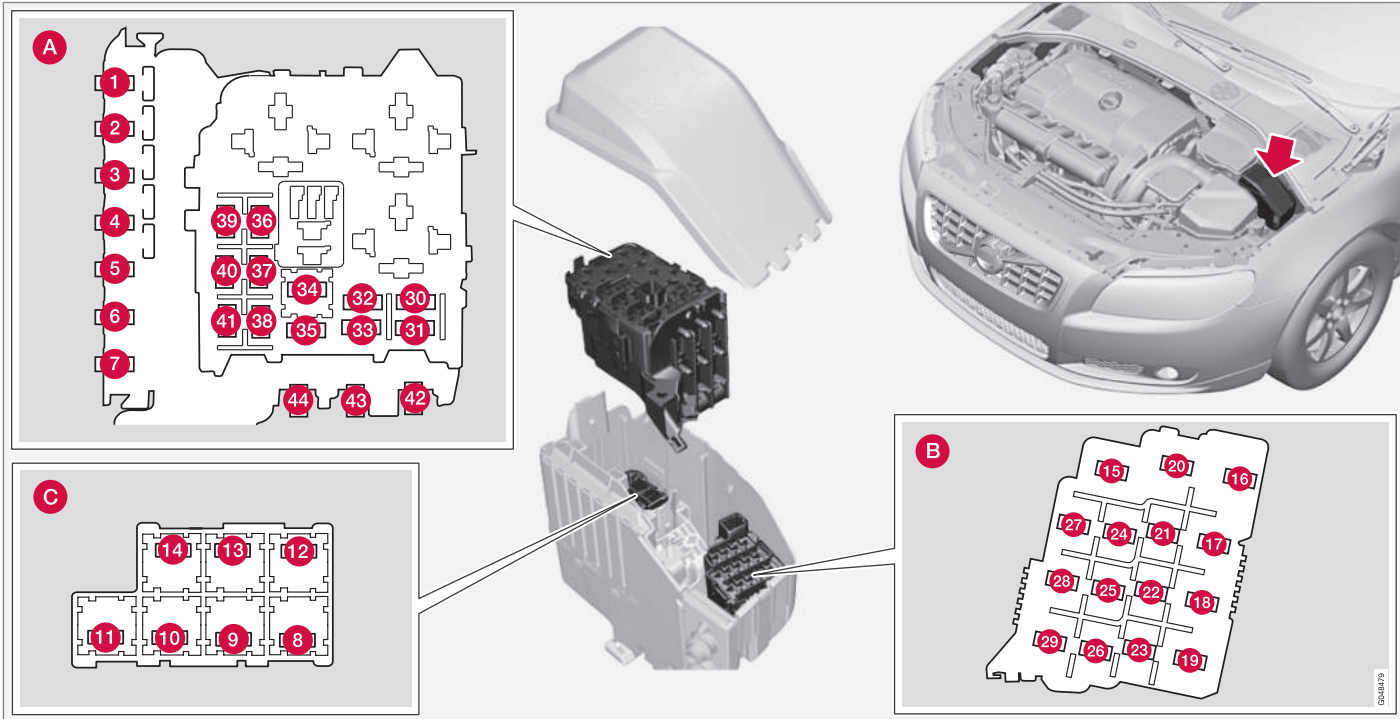



# 10 Maintenance and service



## General fuses, engine compartment

On the inside of the cover there are tweezers that facilitate the procedure for the removal and fitting of fuses.

### Positions (see preceding illustration)

- A** Engine compartment, upper
- B** Engine compartment, front
- C** Engine compartment, lower

These fuses are all located in the engine compartment box. The fuses in (C) are located under (A).

On the inside of the cover is a label that shows the location of the fuses.

- Fuses 1-7 and 42-44 are of the "Midi Fuse" type and must only be replaced by a workshop<sup>15</sup>.
- Fuses 8-15 and 34 are of the "JCASE" type and should be replaced by a workshop<sup>15</sup>.
- Fuses 16-33 and 35-41 are of the "Mini Fuse" type.

	Function	A
1	Primary fuse for the central electronic module (CEM) under the glovebox <sup>A</sup>	50
2	Primary fuse for the central electronic module (CEM) under the glovebox	50
3	Primary fuse for central electrical unit in cargo area <sup>A</sup>	60
4	Primary fuse for relay/fuse box under the glovebox <sup>A</sup>	60
5	Primary fuse for relay/fuse box under the glovebox <sup>A</sup>	60
6	-	-
7	Electric additional heater <sup>A</sup>	100
8	Heated windscreen*, left-hand side	40
9	Windscreen wipers	30
10	Parking heater*	25
11	Ventilation fan <sup>A</sup>	40
12	Heated windscreen*, right-hand side	40

	Function	A
13	ABS pump	40
14	ABS valves	20
15	Headlamp washers*	20
16	Headlamp levelling*; Active Xenon headlamps - ABL*	10
17	Primary fuse for the central electronic module (CEM) under the glovebox	20
18	ABS	5
19	Adjustable steering force*	5
20	Engine control module; Transmission control module; Airbags	10
21	Heated washer nozzles*	10
22	-	-
23	Headlamp control	5
24	-	-
25	-	-
26	-	-

<sup>15</sup> An authorised Volvo workshop is recommended.



	Function	A
27	Relay coils	5
28	Auxiliary lamps*	20
29	Horn	15
30	Relay coil in main relay for engine management system; Engine control module (4-cyl. 2.0 l, 5, 6-cyl.)	10
31	Transmission control module	15
32	Solenoid clutch A/C (not 4-cyl. 2.0 l, not 5-cyl. diesel); Supporting coolant pump (4-cyl. 2.0 l diesel)	15
33	Relay coil in relay for solenoid clutch A/C (not 5-cyl. diesel); Relay coil in relay for coolant pump (1.6 l petrol Start/Stop); Relay coils in central electrical unit in engine compartment cold zone (Start/Stop)	5
34	Start relay <sup>A</sup>	30

	Function	A
35	Ignition coils (1.6 l petrol); Glow control module (5-cyl. diesel)	10
	Engine control module (4-cyl. 2.0 l); Ignition coils (5, 6-cyl. petrol); Capacitor (6-cyl.)	20
36	Engine control module (petrol except 4-cyl. 2.0 l)	10
	Engine control module (1.6 l diesel, 5-cyl. diesel)	15
	Engine control module (4-cyl. 2.0 l)	20
37	Valves (1.6 l petrol); mass air flow sensor (1.6 l, 4-cyl. 2.0 l); Thermostat (4-cyl. 2.0 l petrol); EVAP valve (4-cyl. 2.0 l petrol); Cooling valve for climate control system (4-cyl. 2.0 l diesel); Cooling pump for EGR (4-cyl. 2.0 l diesel)	10
	Regulator valve, fuel flow (engine D4162T)	
	Mass air flow sensor (5-cyl. diesel, 6-cyl.); Control valves (5-cyl. diesel); Injectors (5, 6-cyl. petrol); Engine control module (5, 6-cyl. petrol)	15

	Function	A
38	Solenoid clutch A/C (5, 6-cyl.); Valves (1.6 l, 5, 6-cyl.); Engine control module (6-cyl.) Sole-noids (6-cyl. without turbo); Actuator motors, intake manifold (6-cyl. without turbo); Mass air flow sensor (5-cyl. petrol); Oil level sensor (5-cyl. diesel)	10
	Valves (4-cyl. 2.0 l); Oil pump (4-cyl. 2.0 l petrol); Lambda-sond, centre (4-cyl. 2.0 l petrol); Lambda-sond, rear (4-cyl. 2.0 l diesel)	15
39	Lambda-sonds (1.6 l petrol); Lambda-sond (5-cyl. diesel); Control module, radiator roller cover (1.6 l diesel, 5-cyl. diesel)	10
	Lambda-sond, front (4-cyl. 2.0 l); Lambda-sond, rear (4-cyl. 2.0 l petrol); EVAP valve (5, 6-cyl. petrol); Lambda-sonds (5, 6-cyl. petrol)	15

10





# 10 Maintenance and service



10

	Function	A
40	Coolant pump (1.6 l petrol Start/Stop)	10
	Coolant pump (5-cyl. petrol); Crankcase ventilation heater (5-cyl. petrol); Oil pump automatic gearbox (5-cyl. petrol Start/Stop)	
	Ignition coils (4-cyl. 2.0 l petrol)	
	Diesel filter heater (diesel)	
41	Control module, radiator roller cover (5-cyl. petrol)	5
	Solenoid clutch A/C (4-cyl. 2.0 l petrol)	7.5
	Crankcase ventilation heater (5-cyl. diesel); Oil pump automatic gearbox (5-cyl. diesel Start/Stop)	10
	Solenoid clutch A/C (4-cyl. 2.0 l diesel); Glow control module (4-cyl. 2.0 l diesel); Oil pump (4-cyl. 2.0 l diesel)	15
42	Coolant pump (4-cyl. 2.0 l petrol)	50
	Glow plugs (diesel)	70

	Function	A
43	Cooling fan (1.6 l, 4-cyl. 2.0 l petrol, 5-cyl. petrol)	60
	Cooling fan (6-cyl., 4-cyl. 2.0 l diesel, 5-cyl. diesel)	80
44	Power steering	100

<sup>A</sup> For cars with the Start/Stop function this fuse location is empty - see instead Fuses - in the engine compartment's cold zone (p. 378).

### Related information

- Fuses - under glovebox (p. 373)
- Fuses - in the control module under the glovebox (p. 375)
- Fuses - in cargo area (p. 377)



## Fuses - under glovebox

Fuses under the glovebox protect the infotainment system and seat functions, amongst other things.



### Positions

	Function	A
1	Primary fuse for audio control module*; Primary fuse for fuses 16-20: Infotainment	40
2	-	-
3	-	-
4	Heated steering wheel*	10

	Function	A
5	-	-
6	-	-
7	12 V socket cargo area*; Refrigerator*	15
8	Control panel, driver's door	20
9	Control panel, front passenger door	20

	Function	A
10	Control panel, rear passenger door, right	20
11	Control panel, rear passenger door, left	20
12	Keyless*	20
13	Power seat, driver's side*	20
14	Power seat, passenger side*	20

\* Option/accessory, for more information, see Introduction.



# 10 Maintenance and service



	Function	A
15	-	-
16	Infotainment Control Module or Screen <sup>A</sup>	5
17	Audio control unit (amplifier)*; Digital radio*; TV*	10
18	Audio control module or Control module Sensus <sup>A</sup>	15
19	Telematics*; Bluetooth*	5
20	-	-
21	Sunroof*; Interior lighting roof; Climate sensor*; Damper motors, air intake	5
22	12 V socket, tunnel console	15
23	Seat heating, rear right*	15
24	Seat heating, rear left*	15
25	-	-
26	Seat heating, front passenger side	15
27	Seat heating, front driver's side	15

	Function	A
28	Parking assistance*; Parking camera*; Towbar control module*	5
29	AWD control module*	15
30	Active chassis Four-C*	10

<sup>A</sup> Certain model variants.

## Related information

- Fuses - in engine compartment (p. 369)
- Fuses - in the control module under the glovebox (p. 375)
- Fuses - in cargo area (p. 377)
- Fuses - in the engine compartment's cold zone (p. 378)





## Fuses - in the control module under the glovebox

Fuses in the control module under the glovebox protect airbag and collision warning system functions, amongst other things.

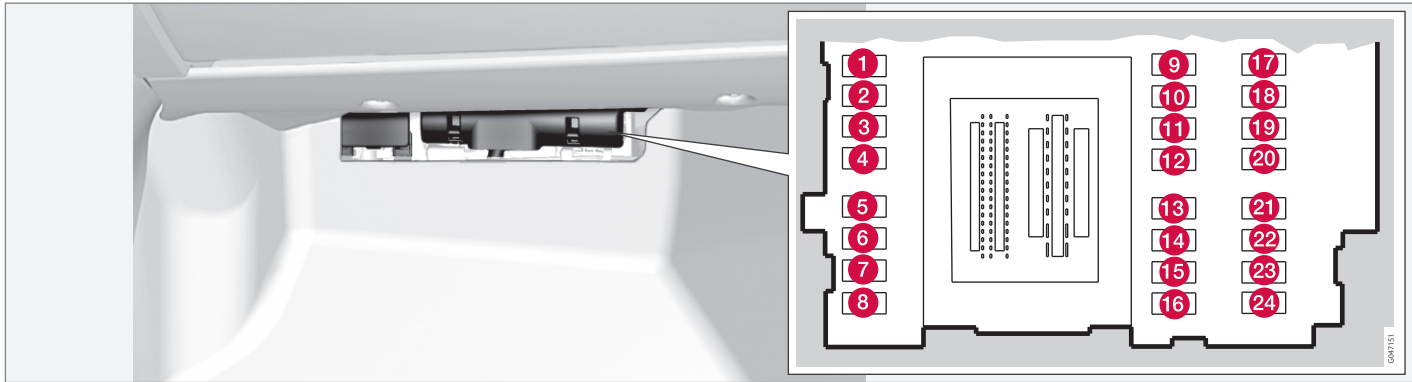

### Positions

	Function	A
1	-	-
2	-	-
3	Interior lighting; Driver's door control panel, power windows; Power seats*	7.5
4	Combined instrument panel	5

	Function	A
5	Adaptive cruise control, ACC*; collision warning system*	10
6	Interior lighting; Rain sensor*	7.5
7	Steering wheel module	7.5
8	Central locking system, fuel filler flap	10
9	-	-

	Function	A
10	Windscreen washers	15
11	Unlocking, boot lid	10
12	Folding head restraint*	10
13	Fuel pump	20
14	Movement detector alarm*; Climate panel	5

\* Option/accessory, for more information, see Introduction.





# 10 Maintenance and service



	Function	A
15	Steering lock	15
16	Siren*; Data link connector OBDII	5
17	-	-
18	Airbags	10
19	Collision warning system*	5
20	Accelerator pedal sensor; Dimming interior rearview mirror*; Seat heating, rear* Electric additional heater*	7.5
21	Infotainment control module (Performance); Audio (Performance)	15
22	Brake light	5
23	Sunroof*	20
24	Immobiliser	5

## Related information

- Fuses - in engine compartment (p. 369)
- Fuses - under glovebox (p. 373)
- Fuses - in cargo area (p. 377)
- Fuses - in the engine compartment's cold zone (p. 378)



## Fuses - in cargo area

Fuses in the cargo area protect trailer and electric drive functions, amongst other things.

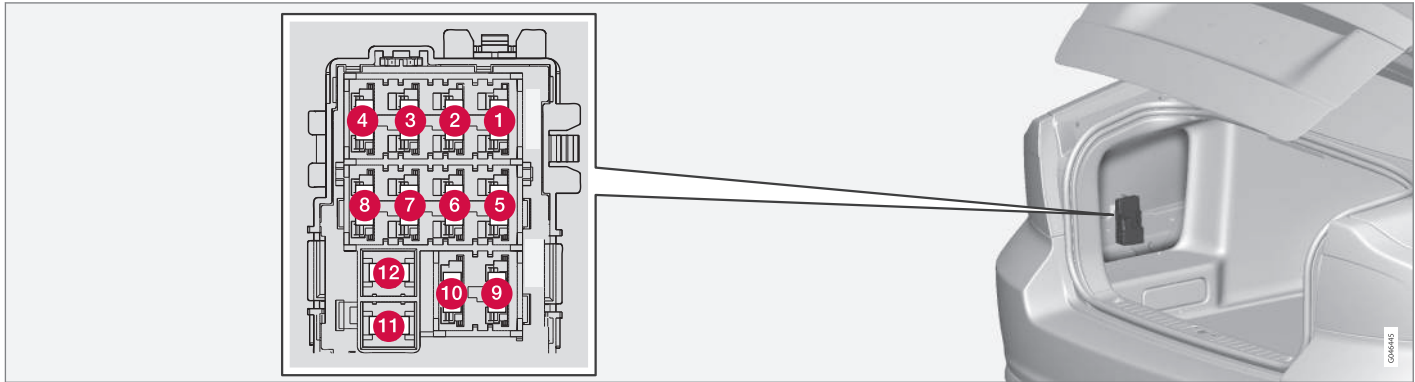

The fuse box is located behind the upholstery on the left-hand side.

### Positions

	Function	A
1	Electric parking brake, left	30
2	Electric parking brake, right	30
3	Rear window defroster	30
4	Trailer socket 2*	15
5	-	-

	Function	A
6	-	-
7	-	-
8	-	-
9	-	-
10	-	-

	Function	A
11	Trailer socket 1*	40
12	-	-

### Related information

- Fuses - in engine compartment (p. 369)
- Fuses - under glovebox (p. 373)
- Fuses - in the control module under the glovebox (p. 375)
- Fuses - in the engine compartment's cold zone (p. 378)

\* Option/accessory, for more information, see Introduction.



## Fuses - in the engine compartment's cold zone

Fuses in the engine compartment's cold zone are fitted in cars with the Start/Stop function.

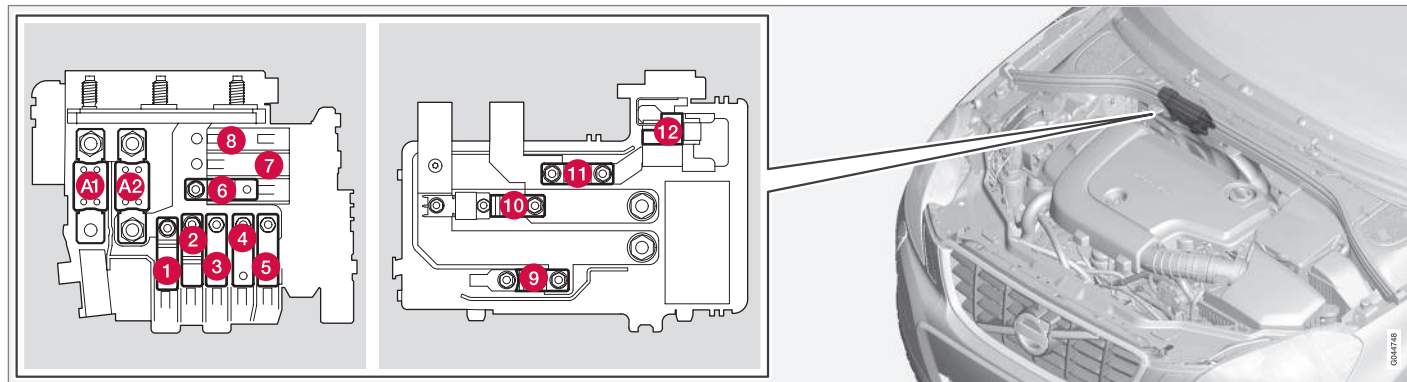

Location of fuses for the Start/Stop function.

- Fuses A1 and A2 are of the "MEGA Fuse" type and must only be replaced by a workshop<sup>16</sup>.
- Fuses 1-11 are of the "Midi Fuse" type and must only be replaced by a workshop<sup>16</sup>.
- Fuse 12 is of the "Mini Fuse" type.

For more information on Start/Stop - see Start/Stop\* (p. 268).

### Positions

	Function	A
A1	Main fuse for central electrical unit in the engine compartment	175
A2	Main fuse for central electronic module (CEM) under the glovebox, relay/fuse box under the glovebox, central electrical unit in cargo area	175

	Function	A
1	Electric additional heater*	100
2	Primary fuse for the central electronic module (CEM) under the glovebox	50
3	Primary fuse for relay/fuse box under the glovebox	60

<sup>16</sup> An authorised Volvo workshop is recommended.



	Function	A
4	Primary fuse for relay/fuse box under the glovebox	60
5	Primary fuse for central electrical unit in cargo area	60
6	Ventilation fan	40
7	-	-
8	-	-
9	Start relay	30
10	Internal diode	50
11	Support battery	70
12	Central electronic module (CEM) - reference voltage support battery; Charging point support battery	15

#### Related information

- Fuses - in engine compartment (p. 369)
- Fuses - under glovebox (p. 373)
- Fuses - in the control module under the glovebox (p. 375)
- Fuses - in cargo area (p. 377)



## Car washing

*The car should be washed as soon as it becomes dirty. Wash the car in a car wash with oil separator. Use car shampoo.*

### Washing by hand

- Remove bird droppings from the paintwork as soon as possible. Bird droppings contain chemicals that affect and discolour paintwork very quickly. An authorised Volvo workshop is recommended for the removal of any discoloration.
- Hose down the underbody.
- Rinse the entire car until the dissolved dirt has been removed so as to reduce the risk of scratches from washing. Do not spray directly onto the locks.
- If necessary, use cold degreasing agent on very dirty surfaces. Note that in this case, the surfaces must not be hot from the sun!
- Wash using a sponge, car shampoo and plenty of lukewarm water.
- Clean the wiper blades with a lukewarm soap solution or car shampoo.
- Dry the car using a clean, soft chamois or a water scraper. If you avoid allowing drops of water to dry in strong sunlight, you reduce the risk of water drying stains which may need to be polished out.

### WARNING

Always have the engine cleaned by a workshop. There is a risk of fire if the engine is hot.

### IMPORTANT

Dirty headlamps have impaired functionality. Clean them regularly, when refuelling for example.

Do not use any corrosive cleaning agents but use water and a non-scratching sponge instead.

### NOTE

Outside lighting such as headlamps, fog lamps and rear lamps may temporarily have condensation on the inside of the lens. This is normal, all exterior lighting is designed to withstand this. Condensation is normally vented out of the lamp housing when the lamp has been switched on for a time.

### Wiper blades

Asphalt, dust and salt residue on wiper blades, as well as insects, ice etc. on the windscreen, impair the service life of wiper blades.

For cleaning:

- Set the wiper blades to the service position, see Wiper blades (p. 359).

### NOTE

Wash the wiper blades and windscreen regularly with lukewarm soap solution or car shampoo. Do not use any strong solvents.

### Automatic car washes

An automatic car wash is a simple and quick way of washing the car, but it cannot reach everywhere. Handwashing the car is recommended for achieving optimum results.

### NOTE

The car must only be washed by hand over the first few months. This is because the paint is more delicate when it is new.

### High-pressure washing

When using high-pressure washing, use sweeping movements and make sure that the nozzle does not come closer than 30 cm to the surface of the car (the distance applies to all exterior parts). Do not spray directly onto the locks.



## Testing the brakes

### WARNING

Always test the brakes after washing the car, including the parking brake, to ensure that moisture and corrosion do not attack the brake linings and reduce braking performance.

Lightly depress the brake pedal now and then when driving long distances in rain or slush. The heat from the friction causes the brake linings to warm up and dry. Do the same thing after starting in very damp or cold weather.

### Exterior plastic, rubber and trim components

A special cleaning agent available from Volvo dealers is recommended for the cleaning and care of coloured plastic parts, rubber and trim components, such as glossy trim mouldings. When using such a cleaning agent the instructions must be followed carefully.

### IMPORTANT

Avoid waxing and polishing on plastic and rubber.

When using degreasant on plastic and rubber, only rub with light pressure if it is necessary. Use a soft washing sponge.

Polishing glossy trim mouldings could wear away or damage the glossy surface layer.

Polishing agent that contains abrasive must not be used.

### Rims

Only use rim cleaning agent recommended by Volvo.

Strong rim cleaning agents can damage the surface and cause stains on chrome-plated aluminium rims.

### Related information

- Polishing and waxing (p. 381)
- Cleaning the interior (p. 382)
- Water and dirt-repellent coating (p. 382)

## Polishing and waxing

*Polish and wax the car if the paintwork is dull or to give the paintwork extra protection.*

*The car does not need to be polished until it is at least one year old. However, the car can be waxed during this time. Do not polish or wax the car in direct sunlight.*

Wash and dry the car thoroughly before you begin polishing or waxing. Clean off asphalt and tar stains using tar remover or white spirit. More stubborn stains can be removed using fine rubbing paste designed for car paintwork.

Polish first with a polish and then wax with liquid or solid wax. Follow the instructions on the packaging carefully. Many preparations contain both polish and wax.

### IMPORTANT

Only paint treatment recommended by Volvo should be used. Other treatment such as preserving, sealing, protection, lustre sealing or similar could damage the paintwork. Paintwork damage caused by such treatments is not covered by Volvo warranty.

### Related information

- Car washing (p. 380)



## Water and dirt-repellent coating

The windows are treated with a surface coating that improves visibility in difficult weather conditions.

## Water and dirt-repellent coating\*



There is natural wear of the water-repellent coating.

Maintenance:

- Never use products such as car wax, degreaser or similar on glass surfaces as this could ruin their water-repellent properties.
- Take care when cleaning so as not to damage the glass surface.
- To avoid damaging glass surfaces when removing ice – only use plastic ice scrapers.
- Treatment with a special finishing agent available from Volvo dealers is recommended in order to maintain the water-repellent properties. This should be used first after three years and then each year.

### IMPORTANT

Do not use a metal ice scraper to remove ice from the windows. Use the heating to remove ice from the door mirrors, see Windows and rearview and door mirrors - heating (p. 101).

## Related information

- Car washing (p. 380)

## Rustproofing

The car received a thorough and complete rustproofing at the factory. Parts of the body are made of galvanised sheet metal. The underbody is protected by a wear-resistant anti-corrosion compound. A thin, penetrating rustproofing fluid was sprayed into the exposed members, cavities, closed sections and side doors.

## Inspection and maintenance

Dirt and road salt can lead to corrosion so it is important to keep the car clean. The car's rustproofing needs to be checked regularly and touched-up if necessary in order for it to be maintained.

Under normal conditions the rustproofing does not require treatment for approximately 12 years. After this period, it should be treated at three-year intervals. Volvo recommends that you engage an authorised Volvo workshop for assistance if the car needs further treatment.

## Related information

- Paint damage (p. 384)

## Cleaning the interior

Only use cleaning agents and car care products recommended by Volvo. Clean regularly and follow the instructions included with the car care product.

Vacuuming is important prior to using cleaning agents.

## Carpets and cargo area

Remove inlaid carpets for separate cleaning of the floor carpet and the inlaid carpets. Use a vacuum cleaner to remove dust and dirt. Each inlay mat is secured with pins.

Take hold of the inlay mat at each pin and lift the mat straight up.

Fit the inlay mat in place by pressing it in at each pin.



### WARNING

Only use one inlaid mat at each seat, and check before setting off that the mat by the driver's seat is firmly affixed and secured in the pins so that it does not get caught adjacent to and under the pedals.

A special textile cleaner is recommended for stains on the floor mat after vacuuming. Floor mats should be cleaned with agents recommended by your Volvo dealer.





### Stains on fabric upholstery and roof upholstery

A special fabric cleaning agent, available from authorised Volvo dealers, is recommended to avoid impairing the fire retardant qualities of the upholstery.

#### **IMPORTANT**

Sharp objects and Velcro may damage the fabric upholstery.

### Stains on leather upholstery

Volvo's leather upholstery is treated to preserve its original appearance.

Leather upholstery ages and acquires a beautiful patina over time. The leather is refined and processed so that it retains its natural characteristics. It is given a protective coating, but regular cleaning is required in order to maintain both characteristics and appearance. Volvo offers a comprehensive product for the cleaning and treatment of leather upholstery which, when used in accordance with the instructions, preserves the leather's protective coating. After a period of use the natural appearance of the leather will nevertheless emerge, depending more or less on the surface texture of the leather. This is a natural maturing of the leather and shows that it is a natural product.

To achieve best results Volvo recommends cleaning and the application of protective cream once to four times per year (or more if necessary). The Volvo Leather Care kit is available from your Volvo dealer.

#### **IMPORTANT**

- Certain items of coloured clothing (for example, jeans and suede garments) may stain the upholstery.
- Never use strong solvents. Such products may damage fabric, vinyl and leather upholstery.

### Washing instructions for leather upholstery

1. Pour the leather cleaner on the dampened sponge and squeeze out a strong foam.
2. Work the dirt away with gentle circular movements.
3. Dab accurately with the sponge on the stains. Allow the sponge to absorb the stain. Do not rub.
4. Wipe off with soft paper or a cloth and allow the leather to dry completely.

### Protective treatment of leather upholstery

1. Pour a small amount of the protective cream on the felted cloth and massage in a thin layer of cream with gentle circular movements on the leather.
2. Allow the leather to dry for 20 minutes before use.

The leather has now been given improved protection against stains and improved UV protection.

### Washing instructions for the leather steering wheel

- Remove dirt and dust with a soft pre-moistened sponge and neutral soap.
- Leather needs to breathe. Never cover the leather steering wheel with protective plastic.
- Use natural oils. Volvo's leather care agents are recommended for best results.

#### **If the steering wheel has stains:**

##### **Group 1** (ink, wine, coffee, milk, sweat and blood)

- Use a soft cloth or sponge. Mix a 5% ammonia solution. (For blood stains, use a solution of 2 dl water and 25g salt.)

##### **Group 2** (fats, oils, sauces and chocolate)

1. Same procedure as for group 1.
2. Polish with an absorbent paper or cloth.



## Group 3 (dry dirt, dust)

1. Use a soft brush to remove the dirt.
2. Same procedure as for group 1.

## Stains on interior plastic parts, metal parts and wood parts

A fibrillated fibre or microfibre cloth, lightly moistened with water, available from Volvo dealers, is recommended for cleaning interior parts and surfaces.

Do not scrape or rub stains. Never use strong stain removers. A special cleaning agent available from Volvo dealers can be used for more difficult cleaning.

### IMPORTANT

Do not use solvents with high alcohol content, e.g. washer fluid, to clean the combined instrument panel.

## Seatbelts

Use water and a synthetic detergent. A special textile cleaning agent is available from your Volvo dealer. Make sure the seatbelt is dry before allowing it to retract.

## Related information

- Car washing (p. 380)

<sup>17</sup> If required.

<sup>18</sup> Follow the instructions that are included with the package for the touch-up pen/stick.

## Paint damage

*Paint is an important part of the car's rust-proofing and should therefore be checked regularly. The most common types of paintwork damage are stone chips, scratches, and marks on the edges of wings, doors and bumpers.*

## Touching up minor paintwork damage

To avoid the onset of rust, damaged paintwork should be rectified immediately.

## Materials

- primer<sup>17</sup> - a special adhesive primer in a spray can is available for e.g. plastic-coated bumpers
- base coat and clear coat - are available in spray cans or as touch-up pens/sticks<sup>18</sup>
- masking tape
- fine sand paper<sup>17</sup>.

## Colour code

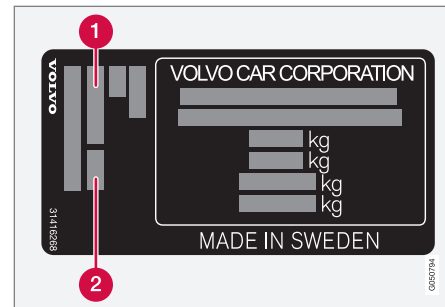

- 1 Exterior colour code
- 2 Any secondary exterior colour code

It is important that the correct colour is used. For product label location, see Type designations (p. 387).



### Repairing minor paint damage such as stone chips and scratches

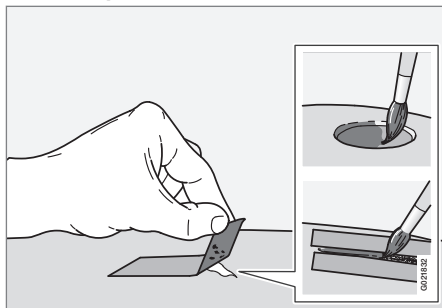

Before work is started, the car must be clean and dry as well as at a temperature above 15 °C.

1. Apply a piece of masking tape over the damaged surface. Then remove the tape to remove any loose paint.

If the damage has reached down to a metal surface (sheet steel), it is preferable to use a primer. In the event of damage to a plastic surface, an adhesive primer should be used for better results - spray into the spray can's cap and brush thinly.

2. Before painting, gentle polishing using a very fine polishing agent may be carried out locally if required (e.g. if there are any uneven edges). Clean the surface thoroughly and allow to dry.

3. Stir the primer well and apply using a fine brush, matchstick or similar. Finish with base coat and clear coat once the primer has dried.
4. For scratches, proceed as above, but mask around the damaged area to protect the undamaged paintwork.

#### **i** NOTE

If the stone chip has not penetrated down to the metal and an undamaged layer of paint remains in place, fill in with base coat and clear coat as soon as the surface has been cleaned.

#### Related information

- Rustproofing (p. 382)



01 10  
00 11

## SPECIFICATIONS

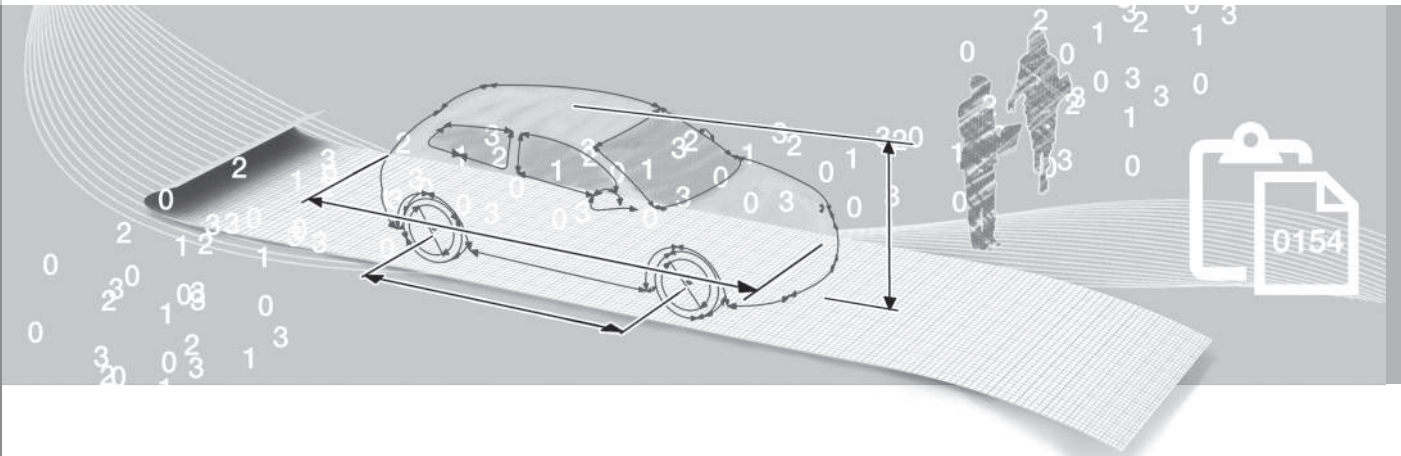

## Type designations

*Type designation, vehicle identification number, etc., i.e. information unique to the car, can be read on a label in the car.*

# 11 Specifications



## Label location

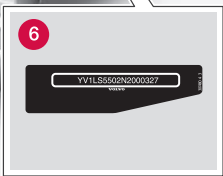
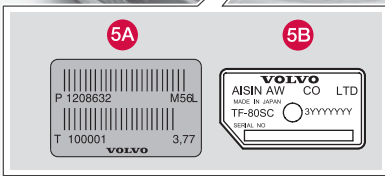
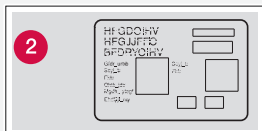
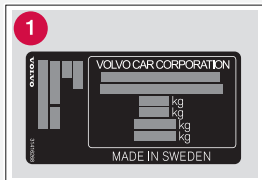
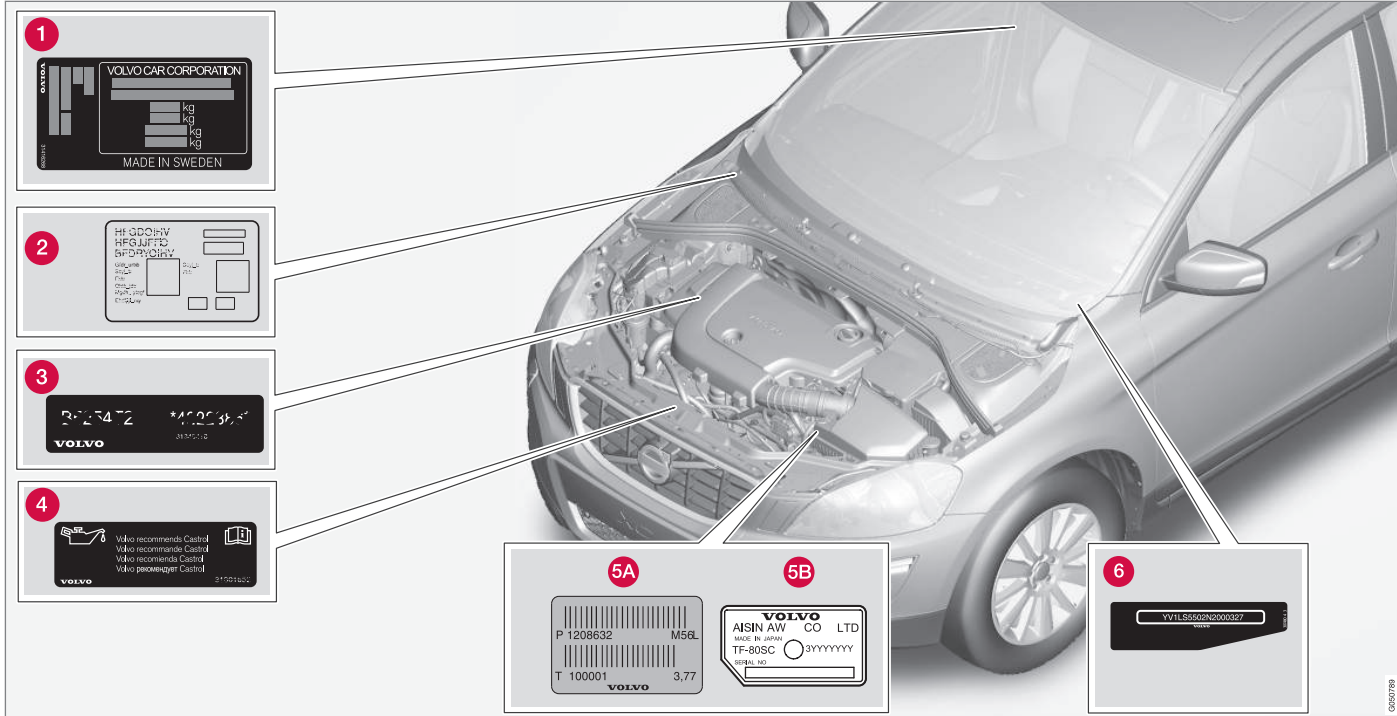

Knowing the car's type designation, vehicle identification and engine numbers can facilitate all contact with an authorised Volvo

dealer regarding the car and when ordering spare parts and accessories.

**1** Type designation, vehicle identification number, permissible maximum weights and code designation for exterior colour

and type approval number. The label is visible when the right rear door is opened.

- 2 Label for parking heater.
- 3 Engine code and engine serial number.
- 4 Label for engine oil.
- 5 Gearbox type designation and serial number.
  - A Manual gearbox
  - B Automatic gearbox
- 6 Car's identification number. (VIN Vehicle Identification Number)

Further information on the car is presented in the registration document.



#### NOTE

It is not intended that the decals illustrated in the owner's manual should be exact replicas of those in the car. They are included to show their approximate appearance and location in the car. The information that applies to your particular car is available on the respective decals for your car.

#### Related information

- Weights (p. 391)
- Engine specifications (p. 395)

# 11 Specifications

## Dimensions

Measurement of car length, height, etc. can be read in the table.

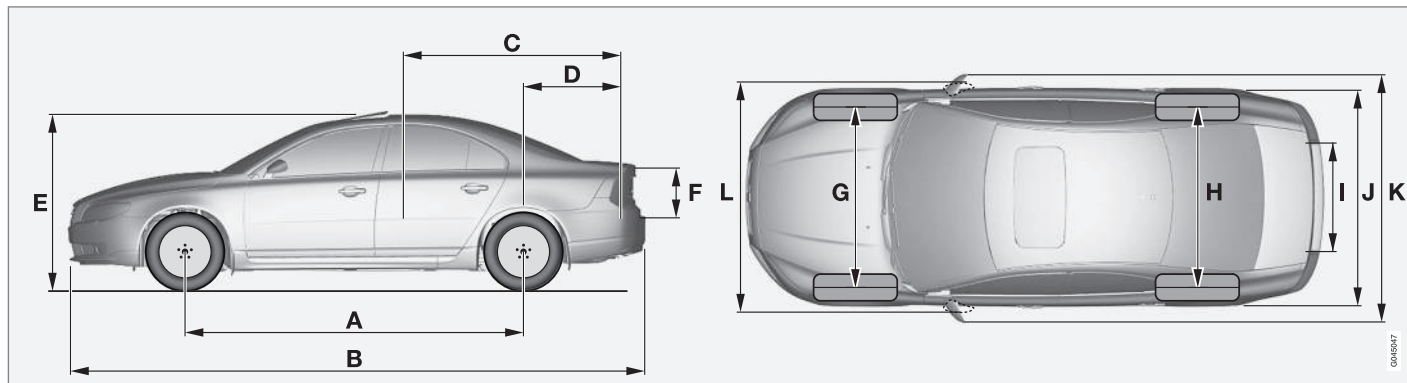

	Dimensions	mm
A	Wheelbase	2835
B	Length	4854
C	Load length, floor, folded seat	1927
D	Load length, floor	1094
E	Height	1493
F	Load height	368

	Dimensions	mm
G	Front track	1588 <sup>A</sup> 1578 <sup>B</sup>
H	Rear track	1585 <sup>A</sup> 1575 <sup>B</sup>
I	Load width, floor	1130
J	Width	1861 (1876 <sup>C</sup> )

	Dimensions	mm
K	Width including door mirrors	2106
L	Width including folded-in door mirrors	1907

A with 16" wheel  
B with 17" wheel  
C with Keyless drive\*

concept



## Weights

Max. gross vehicle weight, etc. can be read on a label in the car.

Kerb weight includes the driver, the fuel tank 90% full and all fluids.

The weight of passengers and accessories, and towball load (p. 392) (when a trailer is hitched) influence the load capacity and are not included in the kerb weight.

Permitted max. load = Gross vehicle weight - Kerb weight.

### NOTE

The documented kerb weight applies to cars in the standard version - i.e. a car without extra equipment or accessories. This means that for every accessory added the loading capacity of the car is reduced correspondingly by the weight of the accessory.

Examples of accessories that reduce loading capacity are the Kinetic/Momentum/Summum equipment levels, as well as other accessories such as Towbar, Load carrier, Space box, Audio system, Auxiliary lamps, GPS, Fuel-driven engine block heater, Safety grille, Carpets, Cargo cover, Power seats, etc.

Weighing the car is a certain way of ascertaining the kerb weight of your own particular car.

### WARNING

The car's driving characteristics change depending on how heavily it is loaded and how the load is distributed.

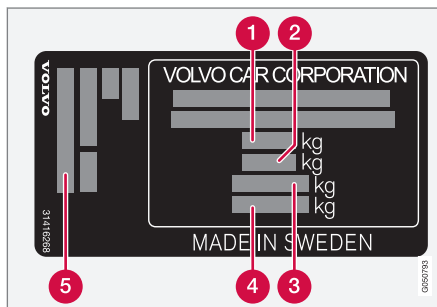

For information on label location, see Type designations (p. 387).

- 1 Max. gross vehicle weight
- 2 Max. train weight (car+trailer)
- 3 Max. front axle load
- 4 Max. rear axle load
- 5 Equipment level

Max. load: See registration document.

Max. roof load: 100 kg.

### Related information

- Towing capacity and towball load (p. 392)

## Towing capacity and towball load

*Towing capacity and towball load for driving with a trailer can be read in the tables.*

## Max. weight braked trailer



### NOTE

The use of a stabiliser hitch on the towing bracket is recommended for trailers heavier than 1800 kg.

Engine	Engine code <sup>A</sup>	Gearbox	Max. weight braked trailer (kg)	Max. towball load (kg)
All	All	All	1200	50
T4	B4164T	Automatic, MPS6	1600	75
T5	B4204T11	Automatic, TG-81SC	1800	90
T5	B4204T15	Automatic, TG-81SC	1800	90
T6 AWD	B6304T4	Automatic, TF-80SC	2000	90
D2	D4162T	Manual, MMT6	1300	75
D2	D4162T	Automatic, MPS6	1300	75
D4	D5204T3	Manual, M66	1600	75
D4	D5204T3	Automatic, TF-80SC <sup>B</sup> / TF-80SD <sup>C</sup>	1600	75
D4	D4204T5	Manual, M66	1800	90
D4	D4204T5	Automatic, TG-81SC	1800	90
D5	D5244T15	Automatic, TF-80SC	2000	90
D5 AWD	D5244T15	Automatic, TF-80SC	2000	90

<sup>A</sup> Engine code, component and serial number can be read on the engine; see Type designations (p. 387).

<sup>B</sup> Without Start/Stop.

<sup>C</sup> With Start/Stop.

### Max. weight unbraked trailer

Max. weight unbraked trailer (kg)	Max. towball load (kg)
750	50

**Related information**

- Weights (p. 391)
- Driving with a trailer (p. 296)

**Engine specifications**

Engine specifications (output etc.) for each respective engine alternative can be read in the table.

**NOTE**

Not all engines are available in all markets.

Engine	Engine code <sup>A</sup>	Output (kW/rpm)	Output (hp/rpm)	Torque (Nm/rpm)	No. of cylinders	Bore (mm)	Stroke (mm)	Swept volume (litres)	Compression ratio
T4	B4164T	132/5700	180/5700	240/1600-5000	4	79	81.4	1,596	10.0:1
T5	B4204T11	180/5500	245/5500	350/1500-4800	4	82	93.2	1,969	10.8:1
T5	B4204T15	162/5500	220/5500	350/1500-4000	4	82	93.2	1,969	10.8:1
T6	B6304T4	224/5600	304/5600	440/2100-4200	6	82.0	93.2	2,953	9.3:1
D2	D4162T	84/3600	115/3600	270/1750-2500	4	75	88.3	1,560	16.0:1
D4	D5204T3	120/3500	163/3500	400/1500-2750	5	81.0	77	1,984	16.5:1
D4	D4204T5	133/4250	181/4250	400/1750-2500	4	82.0	93.2	1,969	15.8:1
D5	D5244T15 <sup>B</sup>	158/4000	215/4000	440/1500-3000	5	81.0	93.15	2,400	16.5:1

<sup>A</sup> Engine code, component and serial number can be read on the engine; see Type designations (p. 387).

<sup>B</sup> Automatic gearbox

**Related information**

- Coolant - grade and volume (p. 399)
- Engine oil - grade and volume (p. 397)

## Engine oil - adverse driving conditions

*Adverse driving conditions can lead to abnormally high oil temperature or oil consumption. Below are some examples of adverse driving conditions.*

Check the oil level (p. 346) more frequently for long journeys:

- towing a caravan or trailer
- in mountainous regions
- at high speeds
- in temperatures colder than -30 °C or hotter than +40 °C.

The above also apply to shorter driving distances at low temperatures.

Choose a fully synthetic engine oil for adverse driving conditions. It provides extra protection for the engine.

Volvo recommends:



### ! IMPORTANT

In order to fulfil the requirements for the engine's service intervals all engines are filled with a specially adapted synthetic engine oil at the factory. The choice of oil has been made very carefully with regard to service life, starting characteristics, fuel consumption and environmental impact.

An approved engine oil must be used in order that the recommended service intervals can be applied. Only use a prescribed grade of oil for both filling and oil change, otherwise you will risk affecting service life, starting characteristics, fuel consumption and environmental impact.

Volvo Car Corporation disclaims all warranty liability if engine oil of the prescribed grade and viscosity is not used.

Volvo recommends that oil changes are carried out at an authorised Volvo workshop.

## Related information

- Engine oil - grade and volume (p. 397)
- Engine oil - general (p. 345)

## Engine oil - grade and volume

Engine oil grade and volume for each respective engine alternative can be read in the table.

Volvo recommends:



11

Engine	Engine code <sup>A</sup>	Oil grade	Volume, incl. oil filter (litres)
T6	B6304T4	<b>Oil grade: ACEA A5/B5</b> <b>Viscosity: SAE 0W-30</b>	approx 6.8
D4	D5204T3		approx. 5.9
D5	D5244T15 <sup>B</sup>		approx. 5.9
D2	D4162T	<b>Oil grade: ACEA A5/B5</b> <b>Viscosity: SAE 5W-30</b> When driving under adverse conditions, use ACEA A5/B5 SAE 0W-30.	approx. 3.8
T4	B4164T	Certified and factory-filled oil: <b>Oil grade WSS-M2C925-A</b> options for service: <b>Oil grade: ACEA A5/B5</b> <b>Viscosity: SAE 5W-30</b>	approx. 4.1

# 11 Specifications



Engine	Engine code <sup>A</sup>	Oil grade	Volume, incl. oil filter (litres)
T5	B4204T11	Castrol Edge Professional V 0W-20 or VCC RBS0-2AE 0w20	approx. 5.4
T5	B4204T15		approx. 5.4
D4	D4204T5		approx 5.2

<sup>A</sup> Engine code, component and serial number can be read on the engine; see Type designations (p. 387).

<sup>B</sup> Automatic gearbox.

## Related information

- Engine oil - adverse driving conditions (p. 396)
- Engine oil - checking and filling (p. 346)



## Coolant - grade and volume

Approved coolant volume for each respective engine alternative can be read in the table.

**Prescribed grade:** Coolant recommended by Volvo mixed with 50% water<sup>1</sup>, see the packaging.

Engine <sup>A</sup>		Volume (litres)
D2	D4162T <sup>B</sup>	10.5
D2	D4162T <sup>C</sup>	11.1
T6	B6304T4	8.9
D4	D5204T3	
D5	D5244T15	
T4	B4164T <sup>B</sup>	9.2
T4	B4164T <sup>C</sup>	9.8
T5	B4204T11	8,3 (8,7 <sup>D</sup> )
T5	B4204T15	
D4	D4204T5	8,9 (9,2 <sup>D</sup> )

<sup>A</sup> Engine code, component and serial number can be read on the engine; see Type designations (p. 387).

<sup>B</sup> Manual gearbox

<sup>C</sup> Automatic gearbox

<sup>D</sup> Applies to cars with fuel-driven heater.

## Related information

- Coolant - level (p. 349)

<sup>1</sup> Water quality must fulfil the standard STD 1285.1.

**Transmission fluid - grade and volume**

The prescribed transmission fluid and volume for each respective gearbox alternative can be read in the table.

**Manual gearbox**

Manual gearbox	Volume (litres)	Prescribed transmission fluid
MMT6	approx. 1.7	BOT 350M3
M66	approx. 1.9 (approx. 1.45 <sup>A</sup> )	

<sup>A</sup> Applies to the D4204T5 engine.

**i NOTE**

For the MPS6, oil changes must take place within certain service intervals.

For other gearboxes the gearbox oil does not need to be changed under normal driving conditions. However, it may be necessary under adverse driving conditions.

**Automatic gearbox**

Automatic gearbox	Volume (litres)	Prescribed transmission fluid
MPS6	approx 7.3	BOT 341
TF-80SC	approx 7.0	AW1

Automatic gearbox	Volume (litres)	Prescribed transmission fluid
TF-80SD	approx 7.0	AW1
TG-81SC	approx. 6.6 <sup>A</sup> approx. 7.5 <sup>B</sup>	AW1

A Petrol engines

B Diesel engines

### NOTE

For the MPS6, oil changes must take place within certain service intervals.

For other gearboxes the gearbox oil does not need to be changed under normal driving conditions. However, it may be necessary under adverse driving conditions.

### Related information

- Engine oil - adverse driving conditions (p. 396)
- Type designations (p. 387)

**Brake fluid - grade and volume**

The medium in a hydraulic brake system is called brake fluid, and it is used to transfer pressure from e.g. a brake pedal via a master brake cylinder to one or more slave cylinders, which in turn act on a mechanical brake.

**Prescribed grade:** DOT 4

**Volume:** 0.6 litres

**Related information**

- Brake and clutch fluid - level (p. 350)

**Power steering fluid - grade**

Power steering fluid is the denomination of the medium used in the car's power steering system.

**Prescribed grade:** WSS M2C204-A2 or equivalent product.

**Related information**

- Power steering fluid - level (p. 351)

**Washer fluid - quality and volume**

Washer fluid is used, together with windscreen and rear window wipers, to keep the car's windows and headlamps clean and ensure visibility while driving.

**Prescribed grade:** Washer fluid recommended by Volvo - with frost protection during cold weather and below freezing point.

**Volume:**

- Cars **with** headlamp washing: 6.5 litres.
- Cars **without** headlamp washing: 4.5 litres.

**Related information**

- Washer fluid - filling (p. 361)
- Wiper blades (p. 359)
- Wipers and washing (p. 96)

**Fuel tank - volume**

Fuel tank volume for each respective engine alternative can be read in the table.

Engine	Volume (litres)	Prescribed grade
Petrol engine	approx. 70	Petrol: Fuel - petrol (p. 291)
Diesel engine	approx. 70	Diesel: Fuel - diesel (p. 291)

**Related information**

- Filling up with fuel (p. 289)
- Engine specifications (p. 395)



# 11 Specifications

## Fuel consumption and CO2 emissions







Fuel consumption in a vehicle is measured in litres per 100 km and CO2 emissions in grams per km.







### Explanation

 CO <sub>2</sub>	gram/km
	litre/100 km

	urban driving
	extra-urban driving
	combined driving

 **NOTE**  
If the consumption and emission data is missing then it is included in the enclosed supplement.

S80 							
		CO <sub>2</sub>		CO <sub>2</sub>		CO <sub>2</sub>	
T4 (B4164T)	aut	226	9.7	130	5.6	165	7.1
T5 (B4204T11)	aut	195	8.4	115	4.9	144	6.2
T6 AWD (B6304T4)	aut	337	14.5	170	7.3	231	9.9
D2 <sup>A</sup> (D4162T)	man	140	5.3	106	4.0	119	4.5
D2 <sup>B</sup> (D4162T)	man	120	4.6	100	3.8	107	4.1
D2 <sup>A</sup> (D4162T)	aut	134	5.1	111	4.2	119	4.5

S80 							
		CO <sub>2</sub>		CO <sub>2</sub>		CO <sub>2</sub>	
D2 <sup>B</sup> (D4162T)	aut	125	4.8	100	3.8	109	4.1
D4 (D5204T3)	man	135	5.1	102	3.9	114	4.3
D4 <sup>C</sup> (D5204T3)	aut	214	8.1	126	4.8	158	6.0
D4 <sup>D</sup> (D5204T3)	aut	162	6.1	115	4.3	132	5.0
D4 <sup>E</sup> (D5204T3)	aut	159	6.1	112	4.3	129	4.9
D4 <sup>A</sup> (D4204T5)	man	117	4.5	97	3.7	104	4.0
D4 <sup>B</sup> (D4204T5)	man	116	4.4	94	3.6	102	3.9
D4 <sup>A</sup> (D4204T5)	aut	138	5.4	106	4.0	117	4.5
D4 <sup>B</sup> (D4204T5)	aut	131	5.1	103	3.9	113	4.3

# 11 Specifications



S80 							
		CO <sub>2</sub>		CO <sub>2</sub>		CO <sub>2</sub>	
D5 (D5244T15)	aut	219	8.4	124	4.7	159	6.1
D5 AWD (D5244T15)	aut	213	8.1	127	4.8	158	5.9

A Does **not** apply to the low-emissions variant.

B **Only** applies to the low-emissions variant, max. tyre width 225.

C Applies to cars without Start/Stop.

D Applies to cars with Start/Stop without tyre restriction.

E Applies to cars with Start/Stop with tyre restriction, max. tyre width 225.

Fuel consumption and emission values in the table above are based on specific EU cycles<sup>2</sup>, that apply to cars with kerb weight in the basic version and without extra equipment. The car's weight may increase depending on equipment. This, as well as how heavily the car is loaded, increases fuel consumption and carbon dioxide emissions.

There are several reasons for increased fuel consumption compared with the table's values. Examples of this are:

- The driver's driving style.
- If the customer has specified wheels larger than those fitted as standard on the

model's basic version, then resistance increases.

- High speed results in increased wind resistance.
- Fuel quality, road and traffic conditions, weather and the condition of the car.

Even a combination of the above-mentioned examples can result in significantly improved consumption. For further information, please refer to the regulations referred to<sup>2</sup>.

Large deviations in fuel consumption may arise in a comparison with the EU driving cycles<sup>2</sup> which are used in the certification of

the car and on which the consumption figures in the table are based.



## NOTE

Extreme weather conditions, driving with a trailer or driving at high altitudes in combination with fuel grade are factors that could affect the car's performance.

## Related information

- Economical driving (p. 295)
- Weights (p. 391)

<sup>2</sup> Official fuel consumption figures are based on two standardised driving cycles in a laboratory environment ("EU driving cycles") all in accordance with EU Regulation no 692/2008 and 715/2007 (Euro 5 / Euro 6) and UN ECE Regulation no 101. The regulations cover the driving cycles for urban driving and extra-urban driving. - Urban driving - the measurement starts with cold starting the engine. The driving is simulated. - Extra-urban driving - the car is accelerated and braked at speeds between 0 and 120 km/h. The driving is simulated. - A car with D2, D3, D4 or D5 engine and 6-speed manual gearbox is started in 2nd gear. The combined driving value given in the table is a combination of urban driving and extra-urban driving, in accordance with applicable legislation. CO<sub>2</sub> emissions - the exhaust gases are collected in order to calculate the carbon dioxide emissions during the two driving cycles. These are then analysed and give the value for CO<sub>2</sub> emissions.



**Tyres - approved tyre pressures**

Approved tyre pressures for each respective engine alternative can be read in the table.

**NOTE**

All engines, tyres or combinations of these are not always available in all markets.

S80 Engine	Tyre size	Speed (km/h)	Load, 1-3 persons		Max. load		ECO pressure <sup>A</sup>
			Front (kPa) <sup>B</sup>	Rear (kPa)	Front (kPa)	Rear (kPa)	Front/rear (kPa)
T6	225/55 R 16	0 - 160	230	210	260	260	260
	225/50 R 17	160 +	280	280	290	290	-
	235/40 R 18	0 - 160	230	210	260	260	260
	235/40 R 19	160 +	290	290	320	320	-
D5	225/55 R 16	0 - 160	220	210	260	260	260
	225/50 R 17	160 +	260	260	280	280	-
	235/40 R 18	0 - 160	230	210	260	260	260
	235/40 R 19	160 +	280	280	300	300	-

# 11 Specifications



S80 Engine	Tyre size	Speed (km/h)	Load, 1-3 persons		Max. load		ECO pressure <sup>A</sup>
			Front (kPa) <sup>B</sup>	Rear (kPa)	Front (kPa)	Rear (kPa)	Front/rear (kPa)
T4	225/55 R 16	0 - 160	220	210	260	260	260
	225/50 R 17	160 +	260	260	270	270	-
T5	205/60 R 16 <sup>C</sup>	0 - 160	230	210	260	260	260
D2	205/55 R 17 <sup>D</sup>	160 +	270	270	290	290	-
D4	215/50 R 17 <sup>E</sup>						
	235/40 R 18						
	235/40 R 19						
Temporary Spare Tyre		max. 80	420	420	420	420	-

<sup>A</sup> Economical driving.

<sup>B</sup> In certain countries there is the "bar" unit beside the SI unit "Pascal": 1 bar = 100 kPa.

<sup>C</sup> Not approved for T5 (B5254T12) or T5 (B5254T14).

<sup>D</sup> Only approved for D2 Low emission variant and D4 Low emission variant.

<sup>E</sup> Not approved for T5, D4 and D2 low-emissions variant.

## WARNING

19-inch wheels must **never** be used on cars that are **not** equipped with the R-Design or Sport chassis options. The use of 19-inch wheels on cars with **standard chassis** constitutes a safety risk, with a risk of vehicle damage, and it impairs the car's driving characteristics.

## Related information

- Tyres - dimensions (p. 310)
- Tyres - air pressure (p. 315)
- Type designations (p. 387)



## A

- ACC – Adaptive cruise control..... 190
- Active Bending Lights (ABL)..... 87
- Active chassis - FOUR-C..... 181
- Active high beam..... 85
- Active Xenon headlamps..... 87
- Active Yaw Control..... 181
- Adapting driving characteristics..... 181, 245
- Adaptive Cruise Control..... 190  
     change cruise control functionality..... 199  
     deactivate..... 197  
     fault tracing..... 202  
     function..... 191  
     managing speed..... 194  
     overtaking..... 196  
     overview..... 193  
     radar sensor..... 199  
     setting the time interval..... 195  
     standby mode..... 195  
     temporary deactivation..... 195
- Additional heater  
     electric..... 142, 143  
     fuel-driven..... 142
- Adjusting the steering wheel..... 79
- Airbag  
     activating/deactivating, PACOS..... 32  
     driver's side..... 30, 38  
     passenger side..... 31, 32, 38
- AIRBAG ..... 30, 31
- Airbag system..... 29  
     warning symbol..... 28
- Air cleaning  
     material..... 124  
     passenger compartment.... 122, 123, 124
- Air conditioning..... 131
- Air conditioning system  
     repair..... 352
- Air distribution..... 125  
     Recirculation..... 132  
     table..... 134
- Air quality system IAQS..... 124
- Alarm..... 176, 177, 178  
     alarm indicator..... 177  
     alarm signals..... 178  
     automatic re-arming..... 177  
     checking the alarm..... 161  
     reduced alarm level..... 178  
     remote control key not working..... 178
- Alcolock..... 247
- Allergy and asthma inducing substances. 123
- All Wheel Drive, (AWD)..... 279
- All Wheel Drive (AWD)..... 279
- Approach lighting..... 91, 159
- Automatic car washes..... 380
- Automatic gearbox..... 261, 265  
     manual gear positions (Geartronic).... 262  
     towing and recovery..... 302  
     trailer..... 297
- Automatic relocking..... 171
- AWD, All Wheel Drive..... 279

## B

- Backrest..... 76  
     front seat, lowering..... 76
- Backrest rear seat, lowering..... 78
- Bag holder ..... 152
- Battery..... 287, 361  
     jump starting..... 258  
     maintenance..... 361  
     overload..... 287  
     remote control key/PCC..... 165  
     symbols on the battery..... 363  
     warning symbols..... 363
- Bioethanol E85..... 293
- BLIS..... 241, 242
- Bonnet, opening..... 343

- Book service and repair..... 338
- Boot lid..... 173  
  Locking/unlocking..... 173
- Brake and clutch fluid..... 350
- Brake fluid  
  grade and volume..... 402
- Brake light..... 88
- Brakes..... 279, 280  
  Anti-lock braking system, ABS..... 280  
  brake light..... 88  
  brake system..... 279, 280  
  Emergency Brake Assistance, EBA ... 281  
  emergency brake lights..... 88  
  filling brake fluid..... 351  
  handbrake..... 282  
  symbols in the combined instrument  
  panel..... 279
- Bulbs, see Lighting..... 353
- C**
- 
- Camera sensor..... 210, 221
- Car care..... 380
- Car care, leather upholstery..... 383
- Cargo area  
  loading..... 149  
  load retaining eyelets..... 152
- Car key memory..... 156
- Car upholstery..... 382
- Car washing..... 380
- Catalytic converter..... 293  
  Recovery..... 302
- Chassis settings..... 181
- Checking the engine oil level..... 345
- Children  
  child safety locks..... 41  
  child seat and airbag..... 46  
  child seats and side airbags..... 35  
  location in car..... 46  
  safety..... 35, 41
- Child safety locks..... 175
- Child seats..... 41  
  ISOFIX fixture system for child seats... 47  
  recommended..... 42  
  size classes for child seats with ISO-  
  FIX fixture system..... 47  
  types..... 49  
  upper mounting points for child seats.. 51
- City Safety™..... 208
- Cleaning  
  automatic car wash..... 380  
  car washing..... 380  
  rims..... 381  
  seatbelts..... 384  
  upholstery..... 382
- Clean Zone Interior Package (CZIP)..... 123
- Climate control  
  actual temperature..... 122  
  auto-regulation..... 130  
  general..... 121  
  personal preferences..... 124  
  sensors..... 122  
  temperature control..... 130
- Clock, adjustment..... 69
- CO<sub>2</sub> emissions..... 404
- Collision..... 39
- Collision warning..... 215, 216
- Collision warning system  
  function..... 216  
  general limitations..... 220  
  operation..... 219  
  Pedestrian detection..... 218  
  Radar sensor..... 199, 208
- Collision Warning System with Auto  
  Brake..... 215
- Colour code, paint..... 384
- Combined instrument panel..... 59, 60
- Compass..... 102  
  calibration..... 102
- Condensation in headlamps..... 380
- Controls, lights..... 81
- Control symbols..... 60, 62

Coolant	
volume and grade.....	399
Coolant, checking and filling.....	349
Cooling system.....	286
overheating.....	286
Crash, see Collision.....	39
Cruise control.....	188
deactivate.....	190
managing speed.....	188
resume set speed.....	190
temporary deactivation.....	189
Cyclist detection.....	217
CZIP (Clear Zone Interior Package).....	123
<b>D</b>	
<hr/>	
Daytime running lights.....	83
Deadlock.....	174
deactivation.....	174
temporary deactivation.....	174
Defroster.....	131
Detachable towbar	
storage.....	298
Diesel.....	291
run out of fuel.....	292
Diesel particle filter.....	294

Dimensions.....	390
Dipstick, electronic.....	346, 348
Direction indicator.....	89
Direction indicators.....	89
direction of rotation.....	306
Disengaging the gear selector inhibitor...	267
Display lighting.....	82
Distance Warning.....	205
Limitations.....	206
Symbols and messages.....	207
Door mirrors.....	99
Driveable punctured tyres.....	322
Driver Alert Control.....	225
operation.....	226
Driver Alert System.....	225
Driving.....	288
cooling system.....	286
with a trailer.....	296
with boot lid open.....	287
Driving in water.....	286
Driving with a trailer	
towball load.....	392
towing capacity.....	392

**E**

<hr/>	
ECC, electronic climate control.....	127
Eco Cruise.....	277
EcoGuide.....	63
Ecolabelling, FSC, owner's manual.....	23
Economical driving.....	295
ECO pressure.....	407
Electrical socket.....	148
cargo area.....	153
Electrical system.....	367
Electric parking brake	
low battery voltage.....	282
Electronic climate control - ECC.....	127
Emergency equipment	
first aid kit.....	317
warning triangle.....	316
Emergency puncture repair.....	325
action.....	327
inflating the tyres.....	329
rechecking.....	328
Emergency puncture repair kit	
location.....	325
overview.....	326
sealing fluid.....	330
Emissions of carbon dioxide.....	404

- Engine  
 deactivate..... 253  
 overheating..... 296  
 start..... 252  
 Start/Stop..... 268
- Engine and passenger compartment heater  
 messages..... 140  
 timer..... 138
- Engine block heater..... 136, 257
- Engine block heater and passenger compartment heater  
 direct start..... 137  
 immediate stop..... 138
- Engine compartment  
 coolant..... 349  
 oil..... 345  
 overview..... 343  
 power steering fluid..... 351
- Engine oil..... 345, 396  
 adverse driving conditions..... 396  
 filter..... 345  
 grade and volume..... 397
- Engine specifications..... 395
- Error messages  
 Adaptive Cruise Control..... 203  
 Driver Alert Control..... 227  
 Lane Departure Warning..... 232  
 see Messages and symbols..... 203, 284
- Error messages in BLIS..... 244
- ERS - Remote Start..... 254
- exhaust gases, toxic, sucked in..... 287
- External dimensions..... 390
- ## F
- Fan  
 ECC..... 130
- Fault tracing for the camera sensor..... 211
- First aid..... 317
- First aid kit..... 317
- Flexifuel..... 257
- Fluids, capacities..... 399, 400, 402, 403
- Fluids and oils..... 399, 400, 402
- Fog lamp  
 rear..... 87
- Foot brake..... 279, 280
- FOUR-C - Active chassis..... 181
- FSC, ecolabelling..... 23
- Fuel..... 290, 291, 293  
 fuel consumption..... 404  
 fuel economy..... 315, 316  
 fuel filter..... 292
- Fuel-driven heater  
 timer..... 138
- Fuelling  
 filling..... 289  
 fuel cap..... 289  
 fuel filler flap..... 289  
 fuel filler flap, manual opening..... 289
- Fuel tank  
 volume..... 403
- Fuse box..... 368
- Fuses..... 367  
 cargo area..... 377  
 changing..... 367  
 cold zone..... 378  
 engine compartment..... 369  
 General..... 367  
 Start/Stop..... 378  
 under glovebox..... 373, 375
- ## G
- Gearbox..... 259, 260  
 automatic..... 261, 265  
 manual..... 260
- Gear indicator..... 260
- Gear selector inhibitor..... 267

Gear selector inhibitor, mechanical disengagement.....	267
Geartronic.....	262
Glass	
laminated/reinforced.....	23
Glovebox.....	147
locking.....	172
Gross vehicle weight.....	391
GSI - Gear selector assistance.....	260

## H

---

Handbrake.....	282
Hazard warning flashers.....	88
Headlamp control.....	81
Headlamp levelling.....	82
Headlamp pattern, adjusting.....	92
Headlamp pattern adjustment.....	92
Active Bending Lights .....	92
Halogen headlamp.....	92
Headlamps.....	353
head restraint	
centre seat, rear.....	78
lowering.....	79
Heated washer nozzles.....	97

Heating	
rearview and door mirrors.....	101
rear window.....	101
seats.....	128
steering wheel.....	80
windscreen.....	101
Heat-reflecting windscreen.....	18
High engine temperature.....	296
High-pressure headlamp washing.....	97
Hill Start Assist.....	268
Home safe light duration.....	91
Horn.....	80

## I

---

IAQS - Interior Air Quality System.....	124
Immobiliser.....	157
Indicator symbols.....	64
Inflatable curtain.....	35, 38
Information button, PCC.....	160, 161
Information display.....	59, 60
Inlaid mats.....	148
Instrument lighting, see Lighting.....	82
Instrument overview	
left-hand drive car.....	53
right-hand drive car.....	56

Instruments and controls.....	53, 56
Interior Air Quality System (IAQS)	
Air cleaning.....	124
Interior lighting, see Lighting.....	90
Interior rearview mirror.....	101
automatic dimming.....	101
Intermittent wiping.....	96
Internet-connected car	
book service and repair.....	338

## J

---

Jack.....	309
Journey statistics.....	119
Jump starting.....	258

## K

---

Kerb weight.....	391
Key.....	155, 157
Key blade.....	162, 163
Keyless drive....	166, 167, 168, 169, 170, 252
Keyless - locking.....	168
Keyless start (keyless drive).....	166, 167, 168, 169, 170, 252



Keyless - unlocking.....	169
Keypad in the steering wheel.....	80
Key positions.....	74

**L**

Labels.....	387
Laminated glass.....	23
Lamps, see Lighting.....	352
Lane Departure Control.....	229, 230
Lane keeping assistant operation.....	230, 231
Laser sensor.....	212
Leather upholstery, washing instructions	383
Light indications, PCC.....	161
Lighting.....	352
Active Xenon headlamps.....	87
approach lighting.....	91, 159
automatic lighting, passenger com- partment.....	90
bulbs, specifications.....	358
controls.....	90
daytime running lights.....	83
display lighting.....	82
headlamp levelling.....	82
home safe lighting.....	91
instrument lighting.....	82
in the passenger compartment.....	90
main/dipped beam.....	84
position/parking lamps.....	83
rear fog lamp.....	87
tunnel detection.....	84
Lighting, bulb replacement.....	353
bulb holder, rear.....	356
cargo area.....	357
dipped beam (cars with halogen head- lamps).....	354
direction indicators, front.....	355
main beam (cars with active xenon headlamps).....	355
main beam (cars with halogen head- lamps).....	355
number plate lighting.....	357
vanity mirror.....	358
Loading	
General.....	149
load retaining eyelets.....	152
long load.....	150
roof load.....	151
Lock	
locking.....	171
unlocking.....	171
Lockable wheel bolts.....	308
Lock confirmation .....	157

Locking/unlocking	
glovebox.....	172
inside.....	171

**M**

Main/dipped beam, see Lighting.....	84
Main beam, automatic activation.....	85
maintenance	
Rustproofing.....	382
Manual gearbox.....	260
GSI - Gear selector assistance.....	260
Towing and recovery.....	302
trailer.....	297
Manual gear positions (Geartronic).....	262
Max. roof load.....	391
Memory function in seat.....	77
Menus	
Combined instrument panel.....	105
menu overview.....	106
Messages.....	107
Information display.....	106
Messages and symbols	
Adaptive Cruise Control.....	203
Collision Warning with Auto Brake.....	214, 223
Driver Alert Control.....	227

Engine block heater and passenger compartment heater.....	140
Lane Departure Warning.....	232
Messages in BLIS.....	244
<b>Meters</b>	
fuel gauge.....	59, 61
speedometer.....	59, 61
tachometer.....	59, 61
misting	
attending to the windows.....	121
Misting	
condensation in headlamps.....	380
Mood lighting.....	91
MY CAR.....	108

**O**

Oil, see also Engine oil.....	396, 397
Oil level low.....	345
Output.....	395
outside temperature gauge.....	68
Overheating.....	296
Owner's manual, ecolabelling.....	23

**P**

PACOS.....	32
Paddle on the steering wheel.....	80
Paintwork	
colour code.....	384
damage and touch-up.....	384
Panel lighting.....	82
Panic function.....	159
Park Assist.....	234
backward.....	235
fault indicator.....	237
function.....	234
parking assistance sensors.....	237
Park assist camera.....	238
settings.....	240
Parking brake.....	282
Passenger compartment filter.....	123
Passenger compartment heater.....	136
PCC – Personal Car Communicator	
functions.....	158
range.....	161, 166
Pedestrian detection.....	215
Personal Car Communicator.....	161
Petrol grade.....	291
Pinch protection, sunroof.....	105

Polishing.....	381
Position/parking lamps.....	83
Power guide.....	63
Power seat.....	77
Powershift gearbox.....	265, 302
Power steering fluid	
grade.....	402
Power sunroof.....	103
Power windows.....	97
Privacy locking.....	163

**Q**

Queue Assist.....	197
Queue Assistant.....	197

**R**

Radar sensor.....	191
Limitations.....	199, 200
Rain sensor.....	96
Rear bulbs	
location.....	356
Rear seat	
Heating.....	128



- Stability and traction control system 181,  
 operation..... 182
- Stability system..... 181
- Stains..... 382
- Start/Stop..... 268  
 function and operation..... 269  
 the engine does not stop..... 271
- Steering force, speed related..... 245
- Steering force level, see Steering force... 245
- Steering lock..... 253
- Steering wheel..... 79  
 heating..... 80  
 keypad..... 80  
 paddle..... 80  
 steering wheel adjustment..... 79
- Stone chips and scratches..... 384
- Storage spaces  
 glovebox..... 147  
 tunnel console..... 147
- Storage spaces in the passenger compartment..... 145
- Sun blind..... 99
- Sunroof  
 opening and closing..... 103  
 pinch protection..... 105
- sunscreen..... 104  
 ventilation position..... 104
- Sunscreen, sunroof..... 104
- Switching off the engine..... 253
- Symbols  
 indicator symbols..... 60, 62, 64  
 warning symbols..... 60, 62
- Symbols and messages  
 Adaptive Cruise Control..... 203  
 Collision Warning with Auto  
 Brake..... 214, 223  
 Driver Alert Control..... 227  
 Lane Departure Warning..... 232
- System  
 tripping..... 38
- T**
- Temperature  
 actual temperature..... 122
- Temperature control..... 130
- TM - Tyre Monitor..... 323
- Tools..... 308
- Total airing function..... 121, 172
- Towbar  
 detachable, attachment..... 299  
 detachable, removal..... 300
- Towbar, see Towing equipment..... 298
- Towbar - detachable  
 attachment/removal..... 299, 300
- Towing..... 301  
 towing eye..... 303
- Towing bracket..... 298  
 specifications..... 298
- Towing capacity and towball load..... 392
- Towing eye..... 303
- TPMS - Tyre Pressure Monitoring.... 317,  
 318, 320
- Traction control..... 181
- Trailer..... 296  
 cable..... 296  
 driving with a trailer..... 296
- Transmission..... 260
- Transmission oil  
 volume and grade..... 400
- Transponder..... 18
- Tread depth..... 309
- Tread wear indicators..... 308
- Trip computer..... 109, 110, 114, 118, 119
- Trip meter..... 68
- Trip meter, resetting..... 112, 116
- Troubleshooting  
 Adaptive Cruise Control..... 202

Tunnel console.....	147	tyre pressure monitoring.....	317, 318, 320,
12 V socket.....	148		323
cigarette lighter and ashtray.....	147	winter tyres.....	309
Tunnel detection.....	84		
Type approval		<b>U</b>	
radar system.....	245	Unlocking	
remote control key system.....	179	from the inside.....	171
tyre pressure monitoring.....	331	from the outside.....	171
Type designations.....	387	Unlocking with the key blade.....	169
Tyre dimension.....	310		
Tyre load index.....	311	<b>V</b>	
Tyre pressure label.....	315	Vanity mirror.....	90, 148
Tyre pressure monitoring. 317, 318, 320,	323	Ventilation.....	125
Adjust.....	319	Vibration damper.....	298
arming.....	321	Volvo ID.....	19
deactivate.....	321	Volvo Sensus.....	73
driveable punctured tyres (SST).....	322		
low tyre pressure.....	322		
recommendations.....	321		
Tyres			
direction of rotation.....	306		
maintenance.....	306		
pressure.....	315, 407		
puncture repair.....	325		
specifications.....	407		
tread depth.....	309		
tread wear indicators.....	308		

**W**

Warning lamp	
Adaptive Cruise Control.....	191
collision warning system.....	219
stability and traction control system..	181
Warning lamps	
Airbags – SRS.....	66
alternator not charging.....	66
Fault in brake system.....	66
Low oil pressure.....	66
Parking brake applied.....	66
seatbelt reminder.....	27, 66
Warning.....	66
Warning sound	
collision warning system.....	219
Warning symbols.....	60, 62, 66
Warning triangle.....	316
Washer fluid	
volume.....	402
Washer fluid, filling.....	361
Washer nozzles, heated.....	97
Washers	
washer fluid, filling.....	361
windscreen.....	97
Water and dirt-repellent coating.....	382
Water-repellent surface, cleaning.....	382

Waxing.....	381	Wiper blades.....	359
Weights		changing.....	360
kerb weight.....	391	Cleaning.....	360
Wheel bolts.....	308	Service position.....	359
lockable.....	308	Wipers and washing.....	96
Wheel rim, dimensions.....	310		
Wheel rims			
cleaning.....	381		
Wheels			
installation.....	314		
removal.....	312		
snow chains.....	309		
Whiplash injury, WHIPS.....	36		
WHIPS			
child seat/booster cushion.....	37		
seating position.....	37		
whiplash protection.....	36, 38		
Window			
sun blind.....	99		
Windows, rearview and door mirrors.....	382		
Windscreen			
heating.....	101, 131		
Windscreen washing.....	97		
Windscreen wiper.....	96		
rain sensor.....	96		
Winter driving.....	288		
Winter tyres.....	309		



